

Verykool USA Inc.

Mobile Phone

Main Model: s354

Serial Model: N/A

May 09, 2014



Report No.: 14070196-FCC-R3

(This report supersedes none)

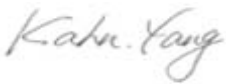

Modifications made to the product : None

This Test Report is Issued Under the Authority of:

		
Kahn Yang Compliance Engineer	Alex Liu Technical Manager	

**This test report may be reproduced in full only.
Test result presented in this test report is applicable to the representative sample only.**

RF Test Report

To: FCC Part 15.247: 2013, ANSI C63.4: 2009

SIEMIC, INC.
Accessing global markets

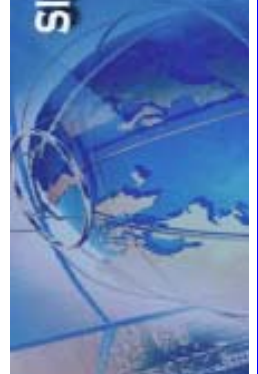

Laboratory Introduction

SIEMIC, headquartered in the heart of Silicon Valley, with superior facilities in US and Asia, is one of the leading independent testing and certification facilities providing customers with one-stop shop services for Compliance Testing and Global Certifications.



In addition to [testing](#) and [certification](#), SIEMIC provides initial design reviews and [compliance management](#) through out a project. Our extensive experience with [China](#), [Asia Pacific](#), [North America](#), [European](#), and [international](#) compliance requirements, assures the fastest, most cost effective way to attain regulatory compliance for the [global markets](#).

SIEMIC (Shenzhen - China) Laboratories Accreditations for Conformity Assessment

Country/Region	Scope
USA	EMC , RF/Wireless , Telecom
Canada	EMC, RF/Wireless , Telecom
Taiwan	EMC, RF, Telecom , Safety
Hong Kong	RF/Wireless ,Telecom
Australia	EMC, RF, Telecom , Safety
Korea	EMI, EMS, RF , Telecom, Safety
Japan	EMI, RF/Wireless, Telecom
Singapore	EMC , RF , Telecom
Europe	EMC, RF, Telecom , Safety



SIEMIC, INC.

Accessing global markets

Title: RF Test Report for Mobile Phone
Main Model: s354
Serial Model: N/A
To: FCC Part 15.247: 2013, ANSI C63.4: 2009

Report No.: 14070196-FCC-R3
Issue Date: May 09, 2014
Page: 3 of 77
www.siemic.com
www.siemic.com.cn

This page has been left blank intentionally.

CONTENTS

1	EXECUTIVE SUMMARY & EUT INFORMATION	5
2	TECHNICAL DETAILS	6
3	MODIFICATION.....	7
4	TEST SUMMARY.....	8
5	MEASUREMENTS, EXAMINATION AND DERIVED RESULTS	9
	ANNEX A. TEST INSTRUMENT & METHOD	55
	ANNEX B. EUT AND TEST SETUP PHOTOGRAPHS	60
	ANNEX C. TEST SETUP AND SUPPORTING EQUIPMENT.....	72
	ANNEX D. USER MANUAL / BLOCK DIAGRAM / SCHEMATICS / PART LIST	76
	ANNEX E. DECLARATION OF SIMILARITY	77

1 EXECUTIVE SUMMARY & EUT INFORMATION

The purpose of this test programme was to demonstrate compliance of the Verykool USA Inc., Mobile Phone and model: s354 against the current Stipulated Standards. The Mobile Phone has demonstrated compliance with the FCC Part 15.247: 2013, ANSI C63.4: 2009.

EUT Information

EUT Description : Mobile Phone

Main Model : s354

Serial Model : N/A

Antenna Gain :
UMTS-FDD Band V/GSM850: -0.78 dBi
UMTS-FDD Band II/PCS1900: 0.76 dBi
Bluetooth/WIFI: 0.43 dBi
BLE: 0.43 dBi

Input Power :
Battery:
Model: Prime 351D
Spec: 3.7V 1200mAh
Limited charger voltage: 4.2V
Adapter:
Model: T97057T2
Input: 100-240V; 50/60Hz 0.2A
Output: 5.0V; 500mA

Classification Per Stipulated Test Standard : FCC Part 15.247: 2013, ANSI C63.4: 2009

**SIEMIC, INC.**

Accessing global markets

Title: RF Test Report for Mobile Phone
 Main Model: s354
 Serial Model: N/A
 To: FCC Part 15.247: 2013, ANSI C63.4: 2009

Report No.: 14070196-FCC-R3
 Issue Date: May 09, 2014
 Page: 6 of 77
www.siemic.com
www.siemic.com.cn

2 TECHNICAL DETAILS

Purpose	Compliance testing of Mobile Phone with stipulated standard
Applicant / Client	Verykool USA Inc. 3636 Nobel Drive, Suite 325, San Diego, CA 92122 USA
Manufacturer	Wingtech Group 6th Floor, G Block, No.668, East Beijing Road, Huangpu District, Shanghai City, China 200001
Laboratory performing the tests	SIEMIC Shenzhen (Shenzhen - China) Laboratories Zone A, Floor 1, Building 2, Wan Ye Long Technology Park, South Side of Zhoushi Road, Bao'an District, Shenzhen, Guangdong, China Tel: +86-0755-2601 4629 / 2601 4953 Fax: +86-0755-2601 4953-810 Email: China@siemic.com.cn
Test report reference number	14070196-FCC-R3
Date EUT received	April 28, 2014
Standard applied	FCC Part 15.247: 2013, ANSI C63.4: 2009
Dates of test (from – to)	April 29 to May 06, 2014
No of Units :	#1
Equipment Category :	DTS
Trade Name :	Verykool
RF Operating Frequency (ies)	GSM850 TX : 824.2 ~ 848.8 MHz; RX : 869.2 ~ 893.8 MHz PCS1900 TX : 1850.2 ~ 1909.8 MHz; RX : 1930.2 ~ 1989.8 MHz UMTS-FDD Band V TX : 826.4 ~ 846.6 MHz; RX : 871.4 ~ 891.6 MHz UMTS-FDD Band II TX : 1852.4 ~ 1907.6 MHz; RX : 1932.4 ~ 1987.6 MHz 802.11b/g/n: 2412-2462 MHz Bluetooth& BLE: 2402-2480 MHz
Number of Channels	299CH (PCS1900) and 124CH (GSM850) UMTS-FDD Band V : 102CH UMTS-FDD Band II : 277CH Bluetooth: 79CH 802.11b/g/n: 11CH BLE: 40CH
Modulation	GSM / GPRS: GMSK UMTS-FDD: QPSK 802.11b/g/n: DSSS/OFDM Bluetooth: GFSK& π/4DQPSK&8DPSK BLE: GFSK
GPRS Multi-slot class	8/10/12
FCC ID	WA6S354



SIEMIC, INC.

Accessing global markets

Title: RF Test Report for Mobile Phone
Main Model: s354
Serial Model: N/A
To: FCC Part 15.247: 2013, ANSI C63.4: 2009

Report No.: 14070196-FCC-R3
Issue Date: May 09, 2014
Page: 7 of 77
www.siemic.com
www.siemic.com.cn

3 MODIFICATION

NONE

4 TEST SUMMARY

The product was tested in accordance with the following specifications.
 All testing has been performed according to below product classification:

Test Results Summary

FCC Rules	Description of Test	Result
§15.247 (i), §2.1093	RF Exposure	Compliance
§15.203	Antenna Requirement	Compliance
§15.247 (a)(2)	DTS (6 dB&26 dB) CHANNEL BANDWIDTH	Compliance
§15.247(b)(3)	Conducted Maximum Output Power	Compliance
§15.247(e)	Power Spectral Density	Compliance
§15.247(d)	Band-Edge & Unwanted Emissions into Non-Restricted Frequency Bands	Compliance
§15.207 (a),	AC Power Line Conducted Emissions	Compliance
§15.205, §15.209, §15.247(d)	Radiated Spurious Emissions & Unwanted Emissions into Restricted Frequency Bands	Compliance

5 MEASUREMENTS, EXAMINATION AND DERIVED RESULTS

5.1 §15.247 (i) and §2.1093 – RF Exposure

Standard Requirement:

According to §15.247 (i) and §1.1307(b)(1), systems operating under the provisions of this section shall be operated in a manner that ensures that the public is not exposed to radio frequency energy level in excess of the Commission’s guidelines.

The 1-g and 10-g SAR test exclusion thresholds for 100 MHz to 6 GHz at *test separation distances* ≤ 50 mm are determined by:

$$[(\text{max. power of channel, including tune-up tolerance, mW}) / (\text{min. test separation distance, mm})] \cdot [\sqrt{f_{\text{GHz}}}] \leq 3.0 \text{ for 1-g SAR and } \leq 7.5 \text{ for 10-g extremity SAR,}^{16} \text{ where}$$

- f_{GHz} is the RF channel transmit frequency in GHz
- Power and distance are rounded to the nearest mW and mm before calculation¹⁷
- The result is rounded to one decimal place for comparison

The test exclusions are applicable only when the minimum *test separation distance* is ≤ 50 mm and for transmission frequencies between 100 MHz and 6 GHz. When the minimum *test separation distance* is < 5 mm, a distance of 5 mm is applied to determine SAR test exclusion.

Routine SAR evaluation refers to that specifically required by § 2.1093, using measurements or computer simulation. When routine SAR evaluation is not required, portable transmitters with output power greater than the applicable low threshold require SAR evaluation to qualify for TCB approval.

Two antennas are available for the EUT (GSM antenna, Bluetooth/WIFI/BLE antenna).
 The maximum average output power(turn-up power) in low channel of WIFI is 8.63 dBm= 7.29 mW
 The calculation results= $7.29 / 5 * \sqrt{2.412} = 2.26 < 3$

The maximum average output power(turn-up power) in middle channel of WIFI is 8.82 dBm= 7.62 mW
 The calculation results= $7.62 / 5 * \sqrt{2.437} = 2.37 < 3$

The maximum average output power(turn-up power) in high channel of WIFI is 8.27 dBm= 6.71 mW
 The calculation results= $6.71 / 5 * \sqrt{2.462} = 2.10 < 3$

According to KDB 447498, no stand-alone required for WIFI antenna, and no simultaneous SAR measurement is required , please refer to SAR report.

Test Result: Pass

5.2 §15.203 - ANTENNA REQUIREMENT

Applicable Standard

According to § 15.203, an intentional radiator shall be designed to ensure that no antenna other than that furnished by the responsible party shall be used with the device. The use of a permanently attached antenna or of an antenna that uses a unique coupling to the intentional radiator shall be considered sufficient to comply with the provisions of this section. The manufacturer may design the unit so that a broken antenna can be replaced by the user, but the user of a standard antenna jack or electrical connector is prohibited. The structure and application of the EUT were analyzed to determine compliance with section §15.203 of the rules. §15.203 state that the subject device must meet the following criteria:

- a. Antenna must be permanently attached to the unit.
- b. Antenna must use a unique type of connector to attach to the EUT.

Unit must be professionally installed, and installer shall be responsible for verifying that the correct antenna is employed with the unit.

And according to FCC 47 CFR section 15.247 (b), if the transmitting antennas of directional gain greater than 6dBi are used, the power shall be reduced by the amount in dB that the directional gain of the antenna exceeds 6 dBi.

Antenna Connector Construction

The EUT has 2 antennas: a PIFA antenna for WIFI/Bluetooth/BLE, the gain is 0.43 dBi for WIFI/Bluetooth/BLE.
. a PIFA antenna for GSM and UMTS, the gain is -0.78 dBi for UMTS-FDD BandV/GSM850 and 0.76 dBi for UMTS-FDD Band II / PCS1900 .

which in accordance to section 15.203, please refer to the internal photos.

Test Result: Pass

5.3 §15.247(a) (2) –DTS (6 dB&20 dB) CHANNEL BANDWIDTH

1. Conducted Measurement
EUT was set for low, mid, high channel with modulated mode and highest RF output power.
The spectrum analyzer was connected to the antenna terminal.
2. Environmental Conditions

Temperature	22°C
Relative Humidity	54%
Atmospheric Pressure	1009mbar
3. Conducted Emissions Measurement Uncertainty
All test measurements carried out are traceable to national standards. The uncertainty of the measurement at a confidence level of approximately 95% (in the case where distributions are normal), with a coverage factor of 2, in the range 30MHz – 40GHz is ± 1.5 dB.
4. Test date : April 29, 2014
Tested By : Kahn Yang

Requirement(s): The minimum 6 dB bandwidth of a DTS transmission shall be at least 500 kHz. Within this document, this bandwidth is referred to as the DTS bandwidth. The procedures provided herein for measuring the maximum peak conducted output power assume the use of the DTS bandwidth.

Procedures:

1. Set RBW = 100 kHz.
2. Set the video bandwidth (VBW) $\geq 3 \times$ RBW.
3. Detector = Peak.
4. Trace mode = max hold.
5. Sweep = auto couple.
6. Allow the trace to stabilize.
7. Measure the maximum width of the emission that is constrained by the frequencies associated with the two outermost amplitude points (upper and lower) that are attenuated by 6 dB relative to the maximum level measured in the fundamental emission.

Test Result: Pass.

Please refer to the following tables and plots.

6dB bandwidth:

Channel	Channel Frequency (MHz)	Data Rate (Mbps)	Measured 6dB Bandwidth (MHz)	FCC Part 15.247 Limit (kHz)
802.11b mode				
Low	2412	1	10.039	> 500
Middle	2437	1	10.026	> 500
High	2462	1	10.015	> 500
802.11g mode				
Low	2412	6	16.628	> 500
Middle	2437	6	16.632	> 500
High	2462	6	16.612	> 500
802.11n(20M) mode				
Low	2412	MCS0	17.866	> 500
Middle	2437	MCS0	17.840	> 500
High	2462	MCS0	17.877	> 500

Note:

11B: 802.11b
 11G: 802.11g
 11N: 802.11n

L: Low Channel
 M: Middle Channel
 H: High Channel



SIEMIC, INC.

Accessing global markets

Title: RF Test Report for Mobile Phone
Main Model: s354
Serial Model: N/A
To: FCC Part 15.247: 2013, ANSI C63.4: 2009

Report No.: 14070196-FCC-R3
Issue Date: May 09, 2014
Page: 13 of 77
www.sieminc.com
www.sieminc.com.cn

Agilent R T

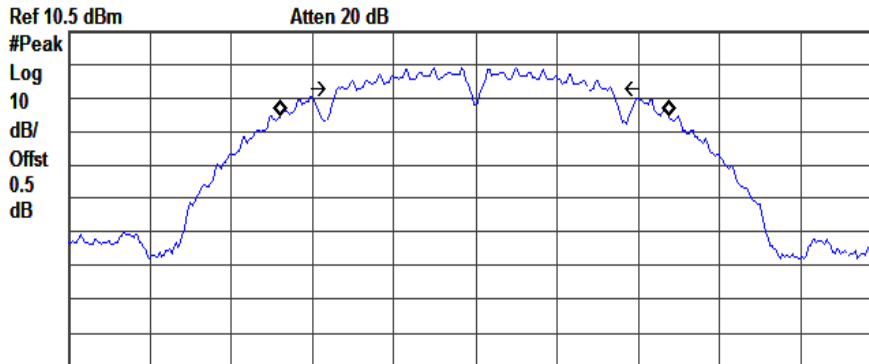

Center 2.412 GHz Span 30 MHz
#Res BW 100 kHz #VBW 300 kHz Sweep 4 ms (401 pts)

Occupied Bandwidth
14.2883 MHz

Occ BW % Pwr 99.00 %
x dB -6.00 dB

Transmit Freq Error -35.027 kHz
x dB Bandwidth 10.039 MHz



11B-L

Agilent R T

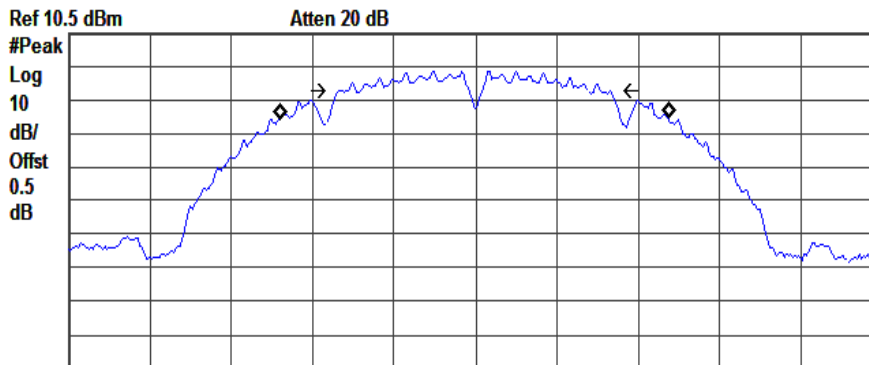

Center 2.437 GHz Span 30 MHz
#Res BW 100 kHz #VBW 300 kHz Sweep 4 ms (401 pts)

Occupied Bandwidth
14.2766 MHz

Occ BW % Pwr 99.00 %
x dB -6.00 dB

Transmit Freq Error -37.050 kHz
x dB Bandwidth 10.026 MHz

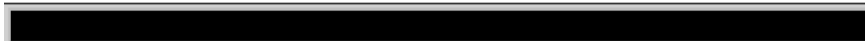

11B-M



SIEMIC, INC.

Accessing global markets

Title: RF Test Report for Mobile Phone
Main Model: s354
Serial Model: N/A
To: FCC Part 15.247: 2013, ANSI C63.4: 2009

Report No.: 14070196-FCC-R3
Issue Date: May 09, 2014
Page: 14 of 77
www.siemec.com
www.siemec.com.cn

Agilent R T

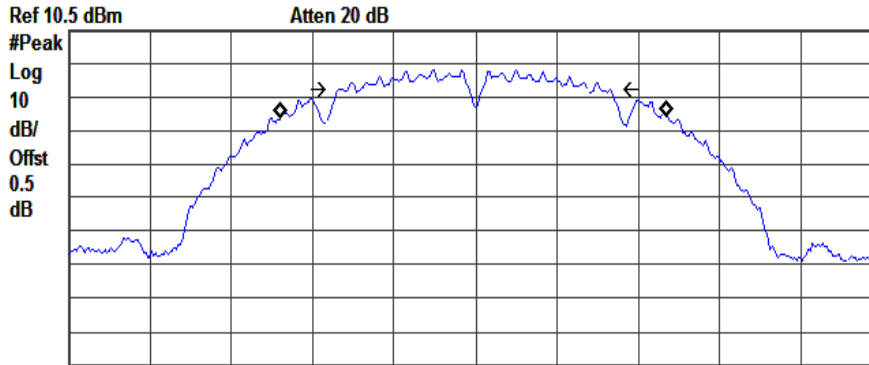

Center 2.462 GHz Span 30 MHz
#Res BW 100 kHz #VBW 300 kHz Sweep 4 ms (401 pts)

Occupied Bandwidth	Occ BW % Pwr	99.00 %
14.2619 MHz	x dB	-6.00 dB

Transmit Freq Error -44.996 kHz
x dB Bandwidth 10.015 MHz

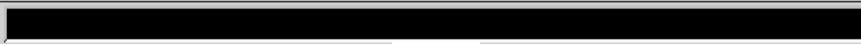

11B-H

Agilent R T

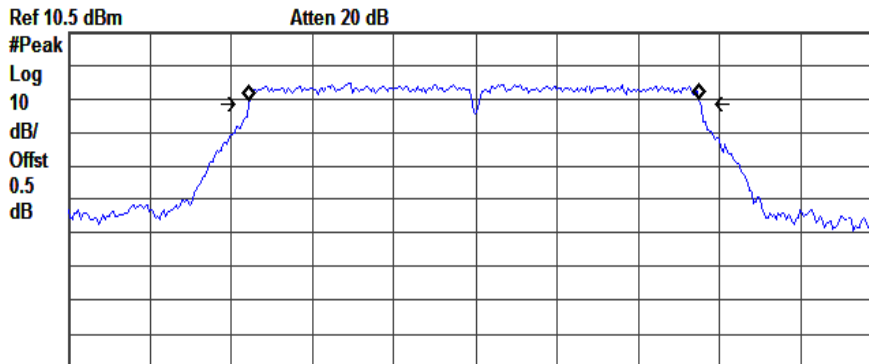

Center 2.412 GHz Span 30 MHz
#Res BW 100 kHz #VBW 300 kHz Sweep 4 ms (401 pts)

Occupied Bandwidth	Occ BW % Pwr	99.00 %
16.5581 MHz	x dB	-6.00 dB

Transmit Freq Error -35.666 kHz
x dB Bandwidth 16.628 MHz



11G-L



SIEMIC, INC.

Accessing global markets

Title: RF Test Report for Mobile Phone
Main Model: s354
Serial Model: N/A
To: FCC Part 15.247: 2013, ANSI C63.4: 2009

Report No.: 14070196-FCC-R3
Issue Date: May 09, 2014
Page: 15 of 77
www.siemec.com
www.siemec.com.cn

Agilent

R T

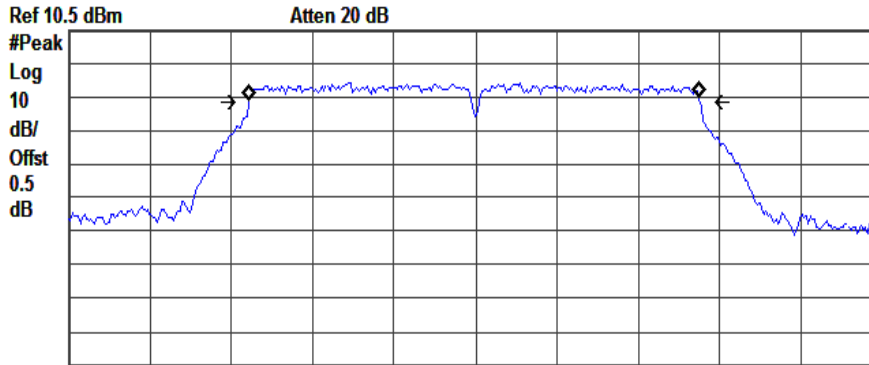

Center 2.437 GHz Span 30 MHz
#Res BW 100 kHz #VBW 300 kHz Sweep 4 ms (401 pts)

Occupied Bandwidth
16.5593 MHz

Occ BW % Pwr 99.00 %
x dB -6.00 dB

Transmit Freq Error -37.104 kHz
x dB Bandwidth 16.632 MHz

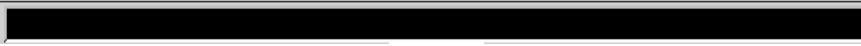

11G-M

Agilent

R T

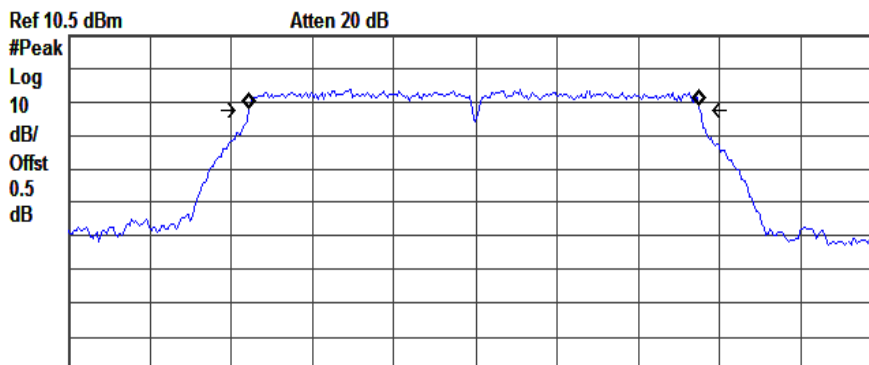

Center 2.462 GHz Span 30 MHz
#Res BW 100 kHz #VBW 300 kHz Sweep 4 ms (401 pts)

Occupied Bandwidth
16.5527 MHz

Occ BW % Pwr 99.00 %
x dB -6.00 dB

Transmit Freq Error -43.271 kHz
x dB Bandwidth 16.612 MHz



11G-H



SIEMIC, INC.

Accessing global markets

Title: RF Test Report for Mobile Phone
Main Model: s354
Serial Model: N/A
To: FCC Part 15.247: 2013, ANSI C63.4: 2009

Report No.: 14070196-FCC-R3
Issue Date: May 09, 2014
Page: 16 of 77
www.siemec.com
www.siemec.com.cn

Agilent

R T

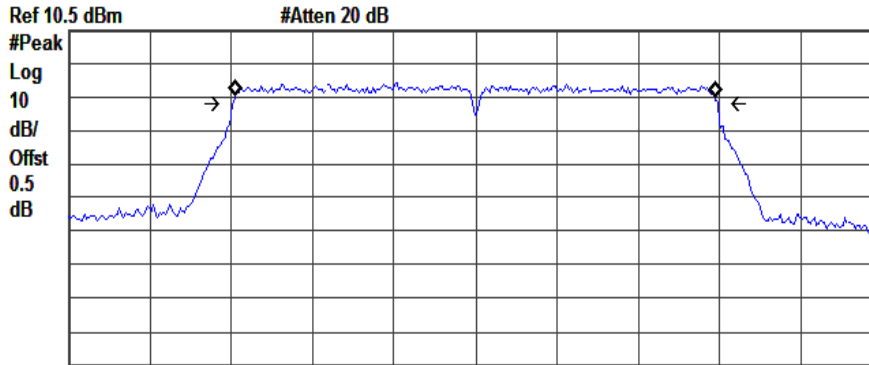

Center 2.412 GHz Span 30 MHz
#Res BW 100 kHz #VBW 300 kHz Sweep 4 ms (401 pts)

Occupied Bandwidth
17.6426 MHz

Occ BW % Pwr 99.00 %
x dB -6.00 dB

Transmit Freq Error -4.053 kHz
x dB Bandwidth 17.866 MHz



11N-L

Agilent

R T

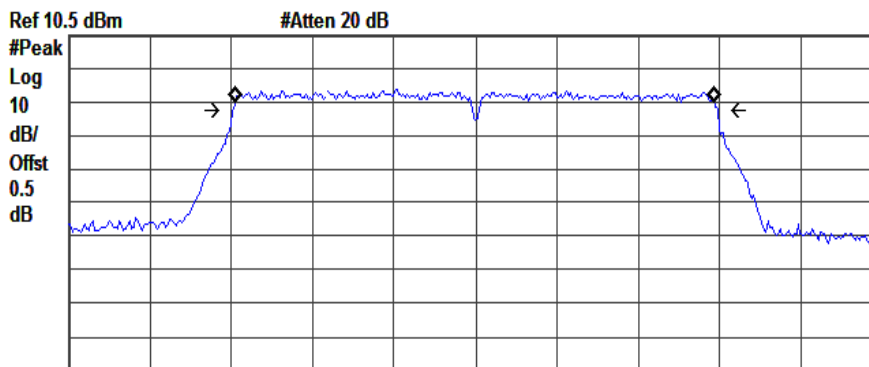

Center 2.437 GHz Span 30 MHz
#Res BW 100 kHz #VBW 300 kHz Sweep 4 ms (401 pts)

Occupied Bandwidth
17.6325 MHz

Occ BW % Pwr 99.00 %
x dB -6.00 dB

Transmit Freq Error -5.694 kHz
x dB Bandwidth 17.840 MHz



11N-M



SIEMIC, INC.

Accessing global markets

Title: RF Test Report for Mobile Phone
Main Model: s354
Serial Model: N/A
To: FCC Part 15.247: 2013, ANSI C63.4: 2009

Report No.: 14070196-FCC-R3
Issue Date: May 09, 2014
Page: 17 of 77
www.siemic.com
www.siemic.com.cn

Agilent

R T

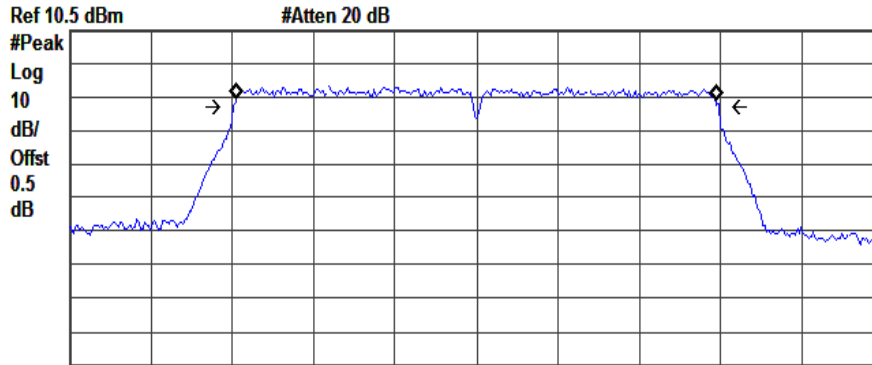

Center 2.462 GHz Span 30 MHz
#Res BW 100 kHz #VBW 300 kHz Sweep 4 ms (401 pts)

Occupied Bandwidth
17.6429 MHz

Occ BW % Pwr 99.00 %
x dB -6.00 dB

Transmit Freq Error -7.787 kHz
x dB Bandwidth 17.877 MHz

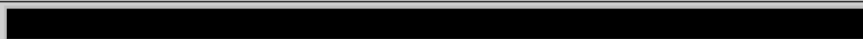

11N-H



SIEMIC, INC.

Accessing global markets

Title: RF Test Report for Mobile Phone
Main Model: s354
Serial Model: N/A
To: FCC Part 15.247: 2013, ANSI C63.4: 2009

Report No.: 14070196-FCC-R3
Issue Date: May 09, 2014
Page: 18 of 77
www.siemec.com
www.siemec.com.cn

The 20dB bandwidth:

Agilent R T

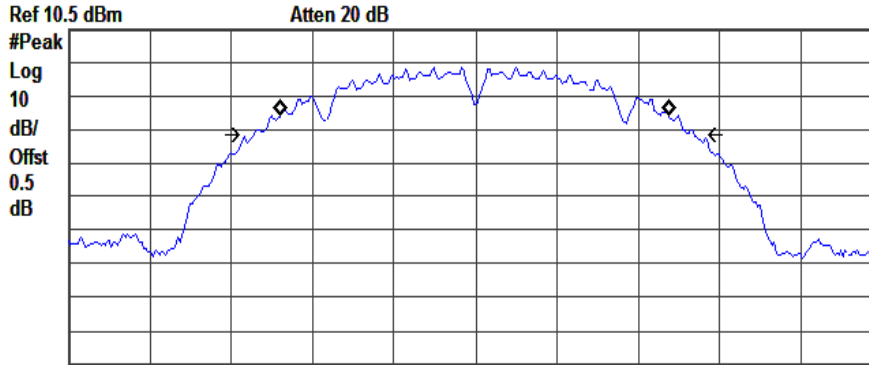

Center 2.412 GHz Span 30 MHz
#Res BW 100 kHz #VBW 300 kHz Sweep 4 ms (401 pts)

Occupied Bandwidth
14.2805 MHz

Occ BW % Pwr 99.00 %
x dB -20.00 dB

Transmit Freq Error -32.875 kHz
x dB Bandwidth 16.238 MHz



11B-L

Agilent R T

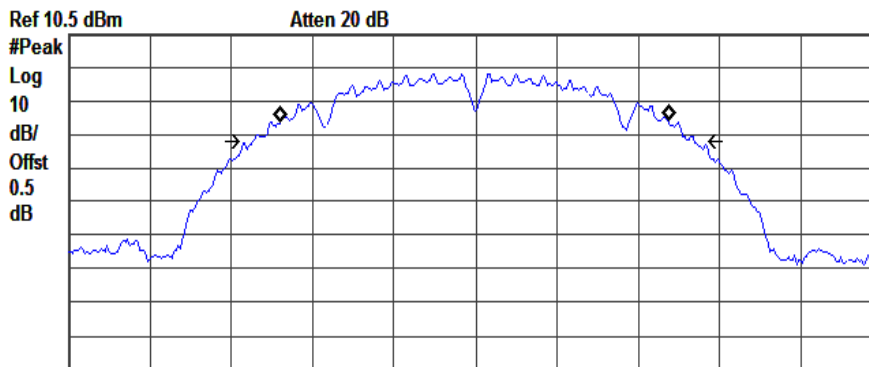

Center 2.437 GHz Span 30 MHz
#Res BW 100 kHz #VBW 300 kHz Sweep 4 ms (401 pts)

Occupied Bandwidth
14.2727 MHz

Occ BW % Pwr 99.00 %
x dB -20.00 dB

Transmit Freq Error -39.518 kHz
x dB Bandwidth 16.235 MHz



11B-M



SIEMIC, INC.

Accessing global markets

Title: RF Test Report for Mobile Phone
Main Model: s354
Serial Model: N/A
To: FCC Part 15.247: 2013, ANSI C63.4: 2009

Report No.: 14070196-FCC-R3
Issue Date: May 09, 2014
Page: 19 of 77
www.siemec.com
www.siemec.com.cn

Agilent

R T

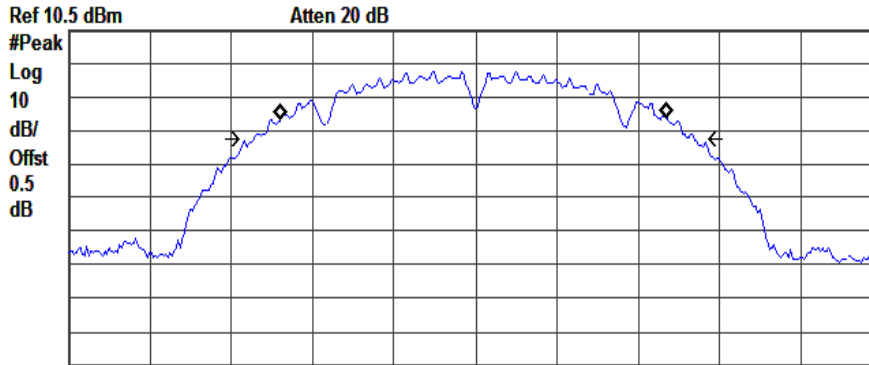

Center 2.462 GHz Span 30 MHz
#Res BW 100 kHz #VBW 300 kHz Sweep 4 ms (401 pts)

Occupied Bandwidth
14.2618 MHz

Occ BW % Pwr 99.00 %
x dB -20.00 dB

Transmit Freq Error -45.140 kHz
x dB Bandwidth 16.232 MHz

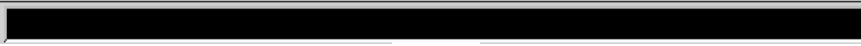

11B-H

Agilent

R T

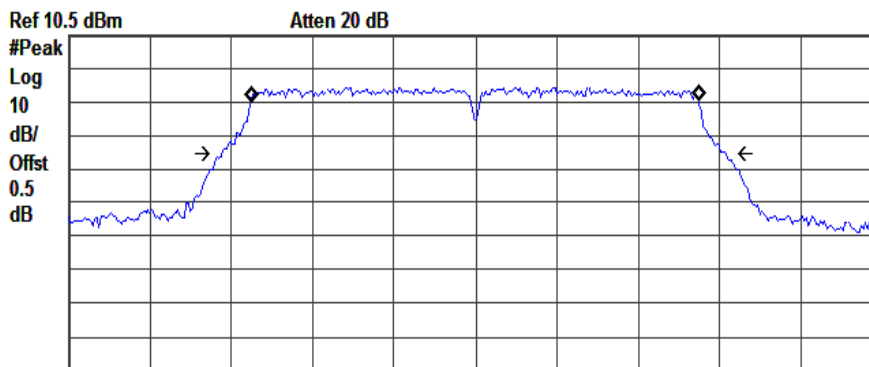

Center 2.412 GHz Span 30 MHz
#Res BW 100 kHz #VBW 300 kHz Sweep 4 ms (401 pts)

Occupied Bandwidth
16.4843 MHz

Occ BW % Pwr 99.00 %
x dB -20.00 dB

Transmit Freq Error -20.316 kHz
x dB Bandwidth 18.581 MHz



11G-L



SIEMIC, INC.

Accessing global markets

Title: RF Test Report for Mobile Phone
Main Model: s354
Serial Model: N/A
To: FCC Part 15.247: 2013, ANSI C63.4: 2009

Report No.: 14070196-FCC-R3
Issue Date: May 09, 2014
Page: 20 of 77
www.siemec.com
www.siemec.com.cn

Agilent

R T

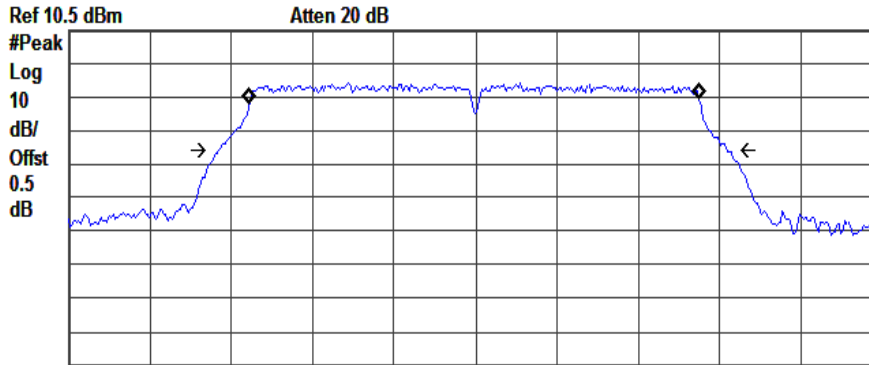

Center 2.437 GHz Span 30 MHz
#Res BW 100 kHz #VBW 300 kHz Sweep 4 ms (401 pts)

Occupied Bandwidth
16.5445 MHz

Occ BW % Pwr 99.00 %
x dB -20.00 dB

Transmit Freq Error -25.996 kHz
x dB Bandwidth 18.741 MHz



11G-M

Agilent

R T

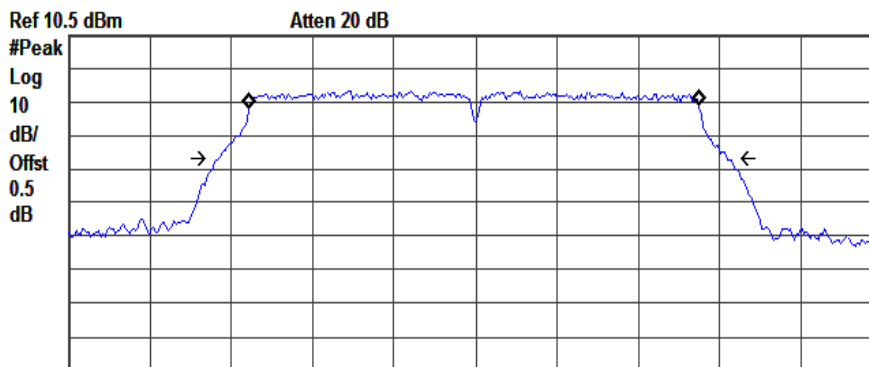

Center 2.462 GHz Span 30 MHz
#Res BW 100 kHz #VBW 300 kHz Sweep 4 ms (401 pts)

Occupied Bandwidth
16.5576 MHz

Occ BW % Pwr 99.00 %
x dB -20.00 dB

Transmit Freq Error -37.411 kHz
x dB Bandwidth 18.736 MHz



11G-H



Agilent R T

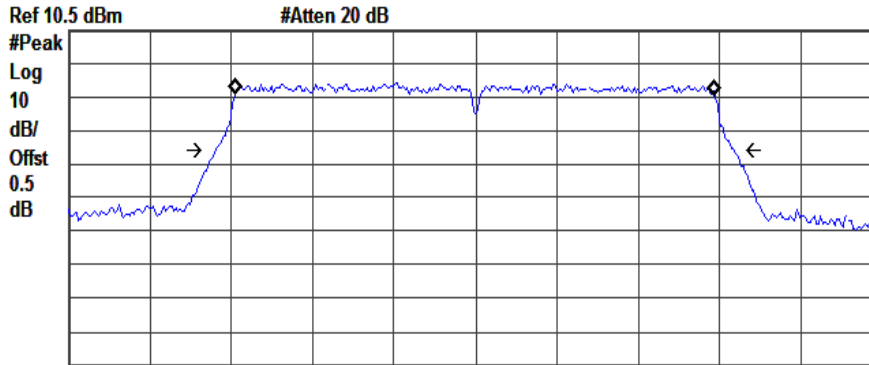

Center 2.412 GHz Span 30 MHz
#Res BW 100 kHz #VBW 300 kHz Sweep 4 ms (401 pts)

Occupied Bandwidth 17.6350 MHz
Occ BW % Pwr 99.00 %
x dB -20.00 dB

Transmit Freq Error -9.062 kHz
x dB Bandwidth 19.138 MHz

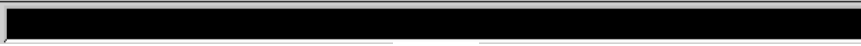

11N-L

Agilent R T

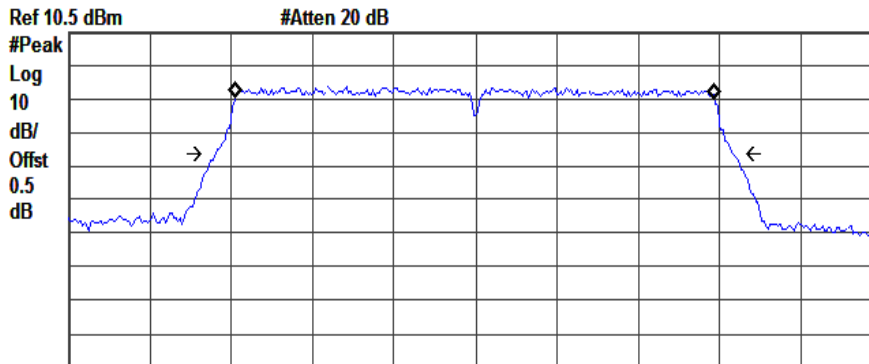

Center 2.437 GHz Span 30 MHz
#Res BW 100 kHz #VBW 300 kHz Sweep 4 ms (401 pts)

Occupied Bandwidth 17.6324 MHz
Occ BW % Pwr 99.00 %
x dB -20.00 dB

Transmit Freq Error -8.222 kHz
x dB Bandwidth 19.077 MHz



11N-M



SIEMIC, INC.

Accessing global markets

Title: RF Test Report for Mobile Phone
Main Model: s354
Serial Model: N/A
To: FCC Part 15.247: 2013, ANSI C63.4: 2009

Report No.: 14070196-FCC-R3
Issue Date: May 09, 2014
Page: 22 of 77
www.siemic.com
www.siemic.com.cn

Agilent R T

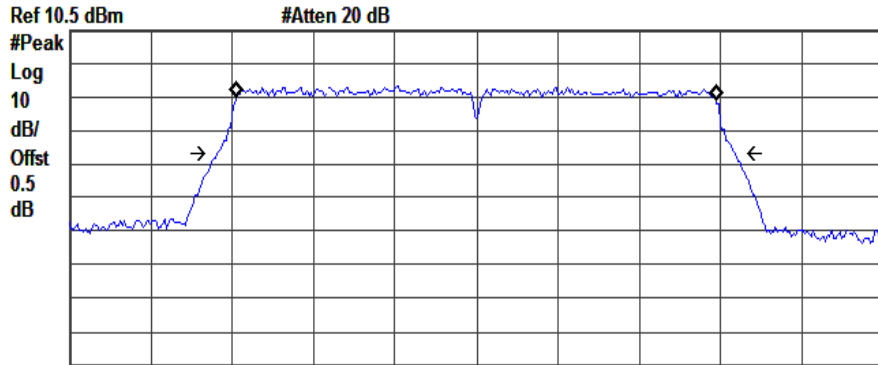

Center 2.462 GHz Span 30 MHz
#Res BW 100 kHz #VBW 300 kHz Sweep 4 ms (401 pts)

Occupied Bandwidth
17.6465 MHz

Occ BW % Pwr 99.00 %
x dB -20.00 dB

Transmit Freq Error -5.680 kHz
x dB Bandwidth 19.113 MHz

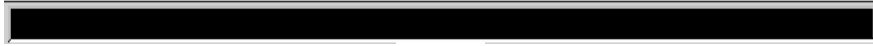

11N-H

5.4 §15.247(b) (3) - Conducted Maximum Output Power

1. Conducted Measurement
EUT was set for low, mid, high channel with modulated mode and highest RF output power.
The spectrum analyzer was connected to the antenna terminal.
2. Conducted Emissions Measurement Uncertainty
All test measurements carried out are traceable to national standards. The uncertainty of the measurement at a confidence level of approximately 95% (in the case where distributions are normal), with a coverage factor of 2, in the range 30MHz – 40GHz is ± 1.5 dB.
3. Environmental Conditions

Temperature	20°C
Relative Humidity	58%
Atmospheric Pressure	1020mbar
4. Test date : May 05, 2014
Tested By : Kahn Yang

Standard Requirement:

Maximum Peak Conducted Output Power

The following procedures can be used to determine the maximum peak conducted output power of a DTS EUT.

Maximum Conducted Output Power

§15.247(b)(3) permits the maximum (average) conducted output power to be measured as an alternative to the maximum peak conducted output power for demonstrating compliance to the limit. When these procedures are utilized, the power is referenced to the emission bandwidth (EBW) rather than the DTS bandwidth (see Section 2.0 for definitions).

When using a spectrum/signal analyzer to perform these measurements, it must be capable of utilizing a number of measurement points in each sweep that is greater than or equal to twice the span/RBW in order to ensure bin-to-bin spacing of $\leq RBW/2$ so that narrowband signals are not lost between frequency bins.

The ideal method for measuring the maximum (average) conducted output power is with the EUT is configured to transmit continuously (duty cycle $\geq 98\%$) at its maximum power control level. However, when this condition cannot be realized, video triggering or signal gating can be used to ensure that the measurements are performed only during periods when the EUT is transmitting at its maximum power control level. An option is also provided that can be used when none of the above requirements can be met with the available measurement instrumentation.

Procedures:

Measurement Procedure PK:

This procedure should only be used when the maximum available RBW of the spectrum/signal analyzer is less than the DTS bandwidth.

1. Set the RBW = maximum available (at least 1 MHz).
2. Set the VBW = 3 x RBW or maximum available setting (must be $\geq RBW$).
3. Set the span to fully encompass the DTS bandwidth.
4. Detector = peak.
5. Sweep time = auto couple.
6. Trace mode = max hold.
7. Allow trace to fully stabilize.
8. Use the spectrum analyzer's band/channel power measurement function with the band limits set equal to the DTS bandwidth edges (for some analyzers, this may require a manual override to ensure use of peak detector). If the spectrum analyzer does not have a band power function, sum the spectrum levels (in linear power units) at intervals equal to the RBW extending across the DTS channel bandwidth.

Measurement Procedure AVG:

This procedure should be used with an RMS power averaging detector; however, a sample detector can be used when an RMS detector is not available. This is the baseline method for measuring the maximum (average) conducted output power.

1. Set the analyzer span to a minimum of 1.5 times the EBW.
2. Set the RBW = 1 MHz.
3. Set the VBW ≥ 3 MHz.
4. Ensure that the number of measurement points in the sweep $\geq 2 \times \text{span}/\text{RBW}$.
5. Sweep time = auto couple.

6. Detector = power averaging (RMS) or sample detector when RMS not available.
7. Employ trace averaging in power averaging (RMS) mode over a minimum of 100 traces.
8. Use the spectrum analyzer's band power measurement function with band limits set equal to the EBW band edges.

Note: If the analyzer does not have a band power function, sum the spectral levels (in linear power units) at 1 MHz intervals extending across the entire EBW.

Test Result: Pass.

Please refer to the following tables and plots.

The Peak Power

Channel	Channel Frequency (MHz)	Data Rate (Mbps)	PK Output Power (dBm)	AV Output Power (dBm)	Limit (dBm)
802.11b mode					
Low	2412	1	12.28	8.63	30
Middle	2437	1	12.97	8.58	30
High	2462	1	12.31	8.24	30
802.11g mode					
Low	2412	6	13.14	8.31	30
Middle	2437	6	13.70	8.82	30
High	2462	6	13.84	8.27	30
802.11n mode					
Low	2412	MCS0 (20M)	13.99	7.70	30
Middle	2437	MCS0 (20M)	13.33	7.91	30
High	2462	MCS0 (20M)	13.38	7.77	30

Note:

11B: 802.11b
11G: 802.11g
11N: 802.11n

L: Low Channel
M: Middle Channel
H: High Channel



SIEMIC, INC.

Accessing global markets

Title: RF Test Report for Mobile Phone
Main Model: s354
Serial Model: N/A
To: FCC Part 15.247: 2013, ANSI C63.4: 2009

Report No.: 14070196-FCC-R3
Issue Date: May 09, 2014
Page: 25 of 77
www.siemec.com
www.siemec.com.cn

The Peak Power

Agilent R T

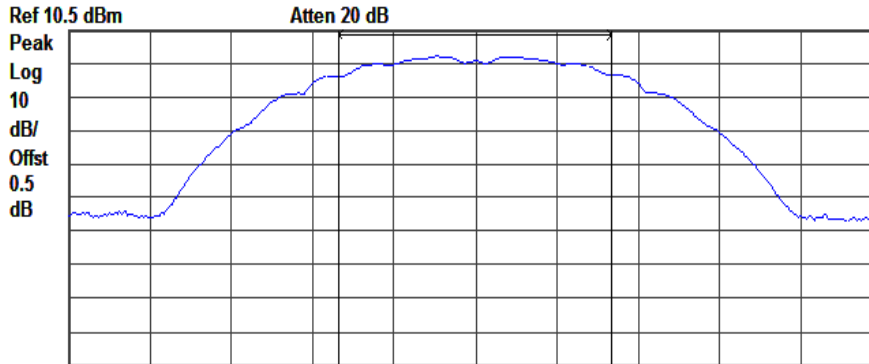

Center 2.412 GHz Span 30 MHz
#Res BW 1 MHz #VBW 3 MHz Sweep 4 ms (401 pts)

Channel Power Power Spectral Density
12.28 dBm / 10.0390 MHz -59.74 dBm/Hz



11B-L

Agilent R T

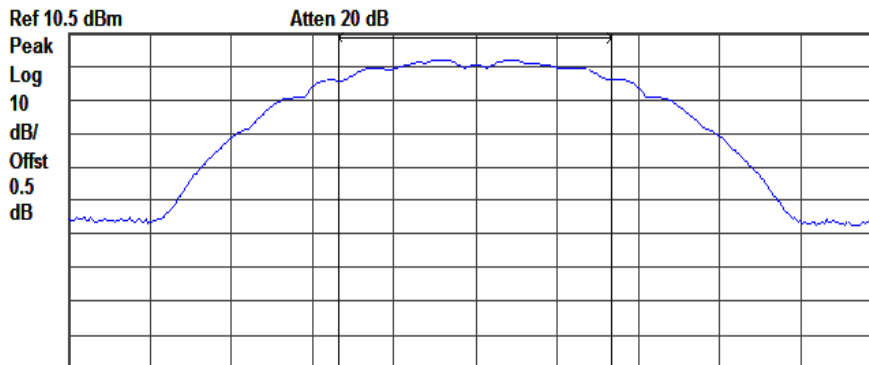

Center 2.437 GHz Span 30 MHz
#Res BW 1 MHz #VBW 3 MHz Sweep 4 ms (401 pts)

Channel Power Power Spectral Density
12.97 dBm / 10.0260 MHz -60.04 dBm/Hz



11B-M



SIEMIC, INC.

Accessing global markets

Title: RF Test Report for Mobile Phone
Main Model: s354
Serial Model: N/A
To: FCC Part 15.247: 2013, ANSI C63.4: 2009

Report No.: 14070196-FCC-R3
Issue Date: May 09, 2014
Page: 26 of 77
www.siemec.com
www.siemec.com.cn

Agilent R T

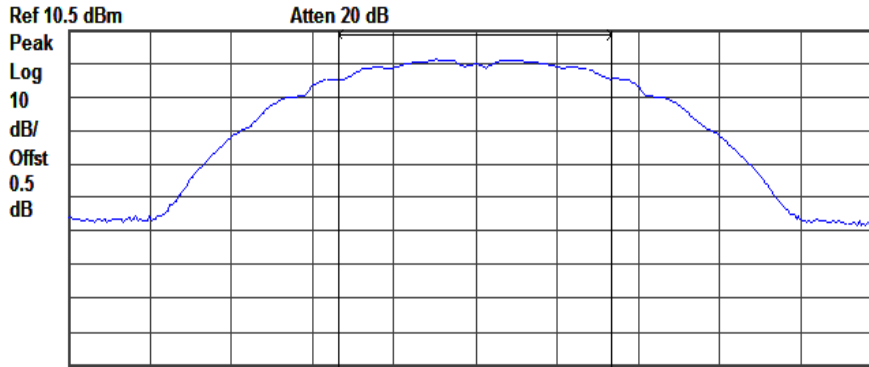

Center 2.462 GHz #VBW 3 MHz Sweep 4 ms (401 pts)
#Res BW 1 MHz

Channel Power Power Spectral Density
12.31 dBm / 10.0150 MHz -60.69 dBm/Hz

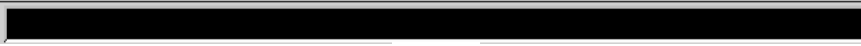

11B-H

Agilent R T

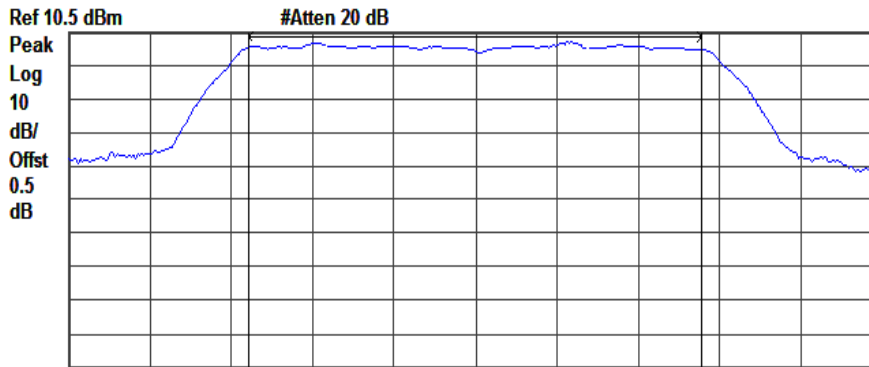

Center 2.412 GHz #VBW 3 MHz Sweep 4 ms (401 pts)
#Res BW 1 MHz

Channel Power Power Spectral Density
13.14 dBm / 16.6280 MHz -57.07 dBm/Hz



11G-L



SIEMIC, INC.

Accessing global markets

Title: RF Test Report for Mobile Phone
Main Model: s354
Serial Model: N/A
To: FCC Part 15.247: 2013, ANSI C63.4: 2009

Report No.: 14070196-FCC-R3
Issue Date: May 09, 2014
Page: 27 of 77
www.siemec.com
www.siemec.com.cn

Agilent R T

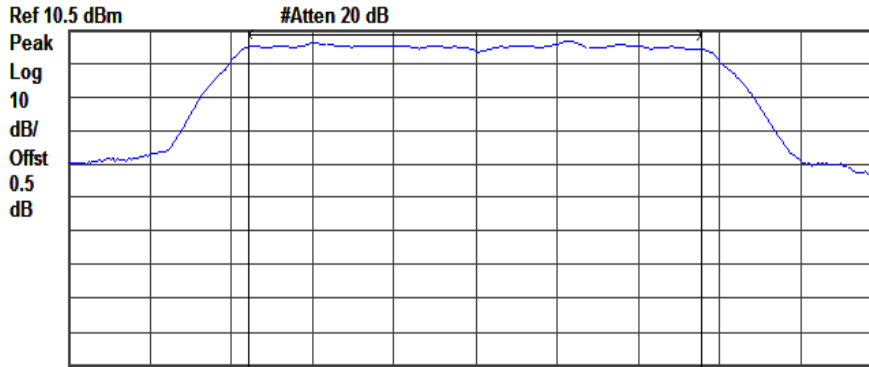

Center 2.437 GHz #Res BW 1 MHz #VBW 3 MHz Sweep 4 ms (401 pts) Span 30 MHz

Channel Power Power Spectral Density
13.70 dBm / 16.6320 MHz -57.51 dBm/Hz

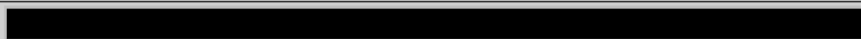

11G-M

Agilent R T

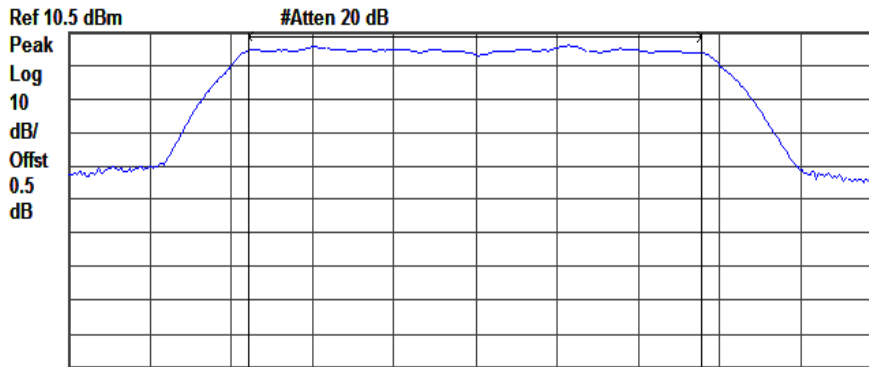

Center 2.462 GHz #Res BW 1 MHz #VBW 3 MHz Sweep 4 ms (401 pts) Span 30 MHz

Channel Power Power Spectral Density
13.84 dBm / 16.6120 MHz -58.37 dBm/Hz



11G-H



SIEMIC, INC.

Accessing global markets

Title: RF Test Report for Mobile Phone
Main Model: s354
Serial Model: N/A
To: FCC Part 15.247: 2013, ANSI C63.4: 2009

Report No.: 14070196-FCC-R3
Issue Date: May 09, 2014
Page: 28 of 77
www.siemec.com
www.siemec.com.cn

Agilent R T

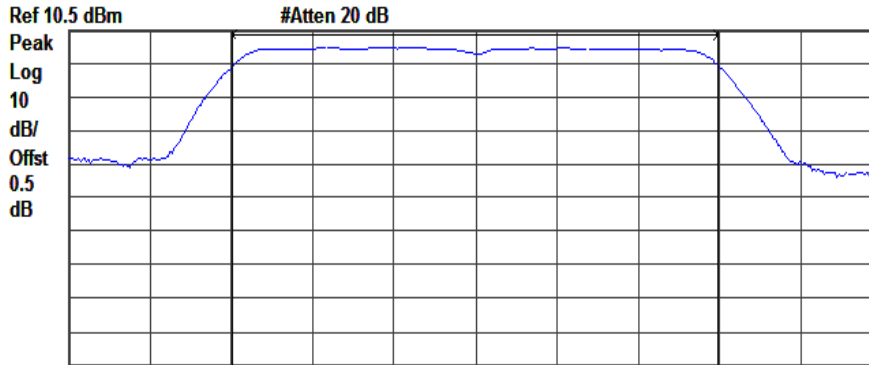

Center 2.412 GHz Span 30 MHz
#Res BW 1 MHz #VBW 3 MHz Sweep 4 ms (401 pts)

Channel Power Power Spectral Density
13.99 dBm / 17.8660 MHz -58.53 dBm/Hz

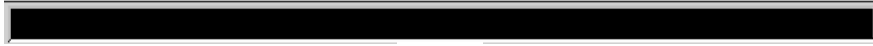

11N-L

Agilent R T

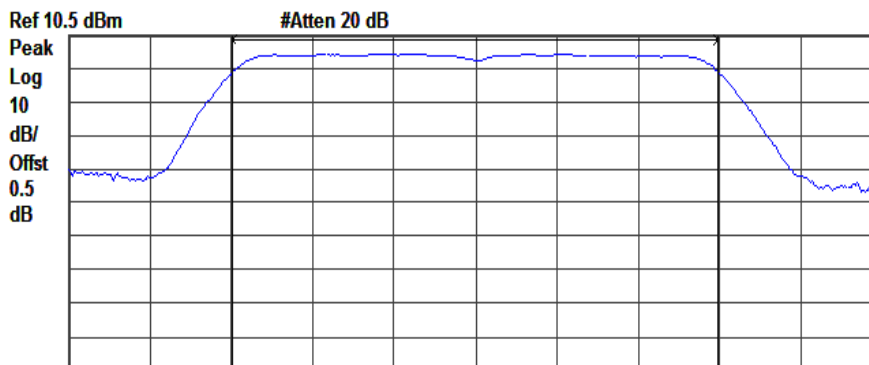

Center 2.437 GHz Span 30 MHz
#Res BW 1 MHz #VBW 3 MHz Sweep 4 ms (401 pts)

Channel Power Power Spectral Density
13.33 dBm / 17.8400 MHz -59.18 dBm/Hz



11N-M



SIEMIC, INC.

Accessing global markets

Title: RF Test Report for Mobile Phone
Main Model: s354
Serial Model: N/A
To: FCC Part 15.247: 2013, ANSI C63.4: 2009

Report No.: 14070196-FCC-R3
Issue Date: May 09, 2014
Page: 29 of 77
www.siemic.com
www.siemic.com.cn

Agilent R T

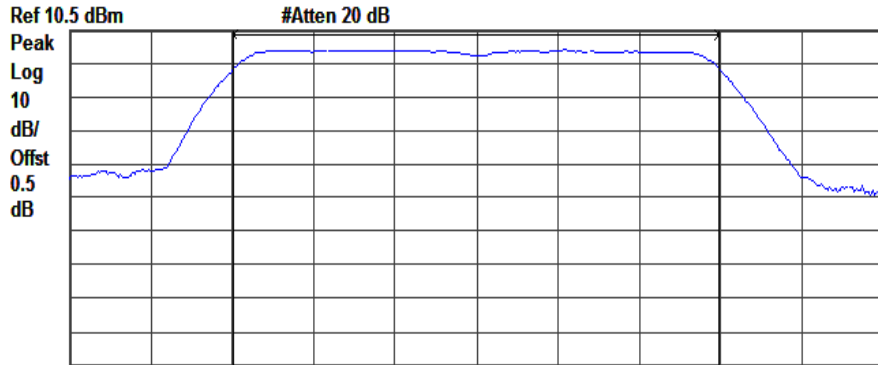

Center 2.462 GHz Span 30 MHz
#Res BW 1 MHz #VBW 3 MHz Sweep 4 ms (401 pts)

Channel Power

13.38 dBm / 17.8770 MHz

Power Spectral Density

-59.15 dBm/Hz

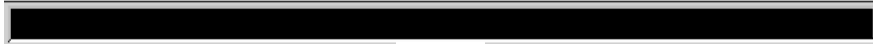

11N-H



SIEMIC, INC.

Accessing global markets

Title: RF Test Report for Mobile Phone
Main Model: s354
Serial Model: N/A
To: FCC Part 15.247: 2013, ANSI C63.4: 2009

Report No.: 14070196-FCC-R3
Issue Date: May 09, 2014
Page: 30 of 77
www.siemic.com
www.siemic.com.cn

The Average Power

Agilent R T

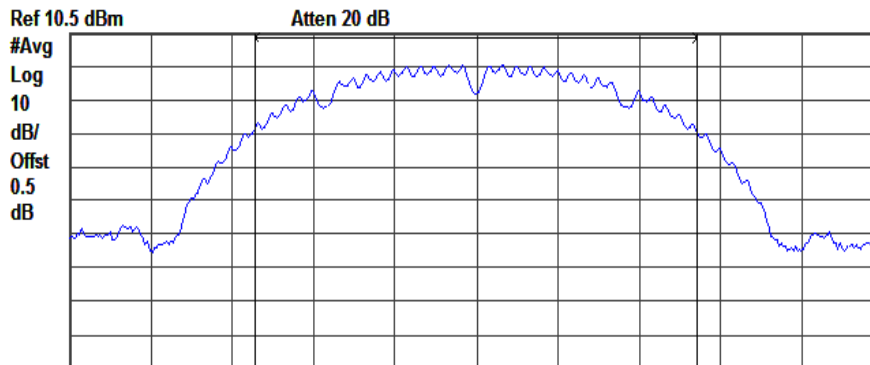

Center 2.412 GHz Span 30 MHz
#Res BW 300 kHz #VBW 1 MHz Sweep 8 ms (401 pts)

Channel Power Power Spectral Density
8.63 dBm / 16.2380 MHz -62.47 dBm/Hz



11B-L

Agilent R T

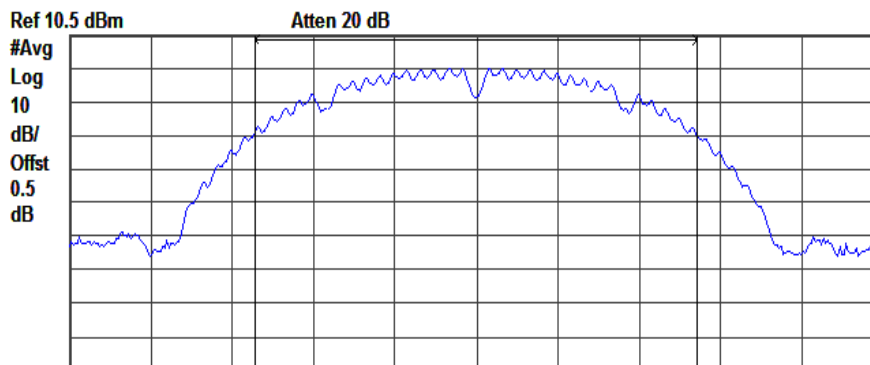

Center 2.437 GHz Span 30 MHz
#Res BW 300 kHz #VBW 1 MHz Sweep 8 ms (401 pts)

Channel Power Power Spectral Density
8.58 dBm / 16.2350 MHz -62.53 dBm/Hz



11B-M



SIEMIC, INC.

Accessing global markets

Title: RF Test Report for Mobile Phone
Main Model: s354
Serial Model: N/A
To: FCC Part 15.247: 2013, ANSI C63.4: 2009

Report No.: 14070196-FCC-R3
Issue Date: May 09, 2014
Page: 31 of 77
www.sieminc.com
www.sieminc.com.cn

Agilent R T

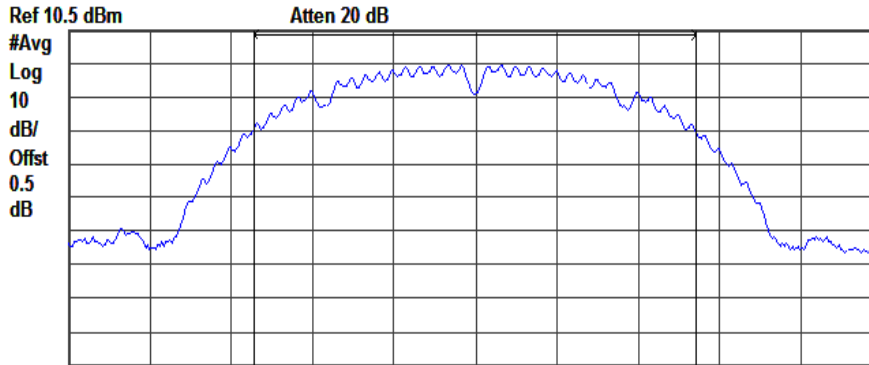

Center 2.462 GHz Span 30 MHz
#Res BW 300 kHz #VBW 1 MHz Sweep 8 ms (401 pts)

Channel Power Power Spectral Density
8.24 dBm / 16.2320 MHz -63.87 dBm/Hz

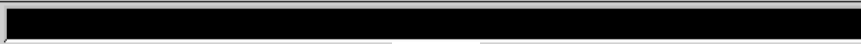

11B-H

Agilent R T

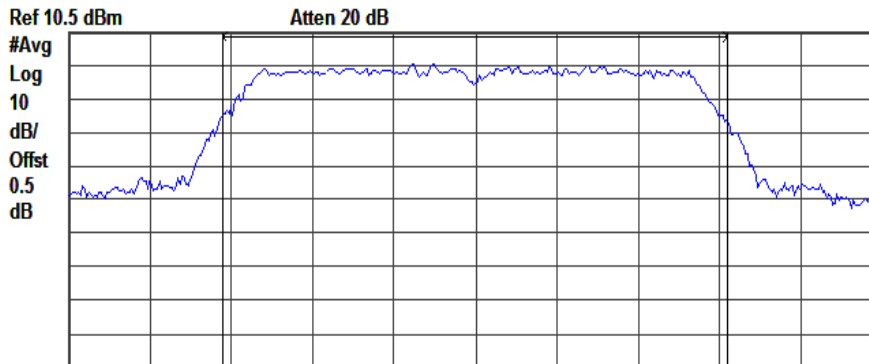

Center 2.412 GHz Span 30 MHz
#Res BW 300 kHz #VBW 1 MHz Sweep 8 ms (401 pts)

Channel Power Power Spectral Density
8.31 dBm / 18.5810 MHz -63.38 dBm/Hz



11G-L



SIEMIC, INC.

Accessing global markets

Title: RF Test Report for Mobile Phone
Main Model: s354
Serial Model: N/A
To: FCC Part 15.247: 2013, ANSI C63.4: 2009

Report No.: 14070196-FCC-R3
Issue Date: May 09, 2014
Page: 32 of 77
www.siemic.com
www.siemic.com.cn

Agilent

R T

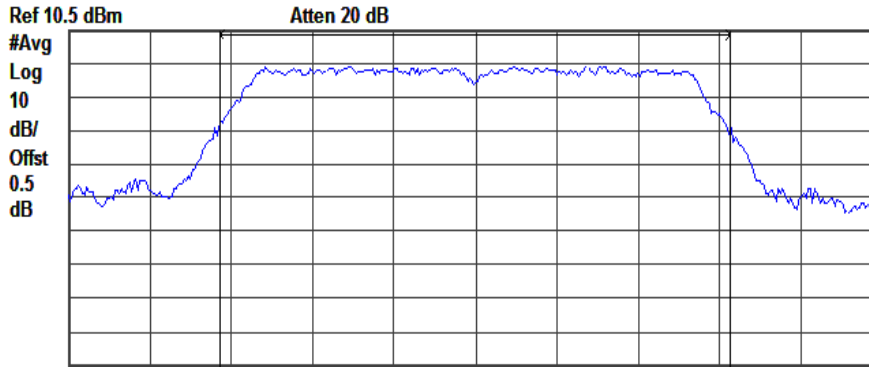

Center 2.437 GHz Span 30 MHz
#Res BW 300 kHz #VBW 1 MHz Sweep 8 ms (401 pts)

Channel Power

Power Spectral Density

8.82 dBm / 18.7410 MHz

-63.91 dBm/Hz

11G-M

Agilent

R T

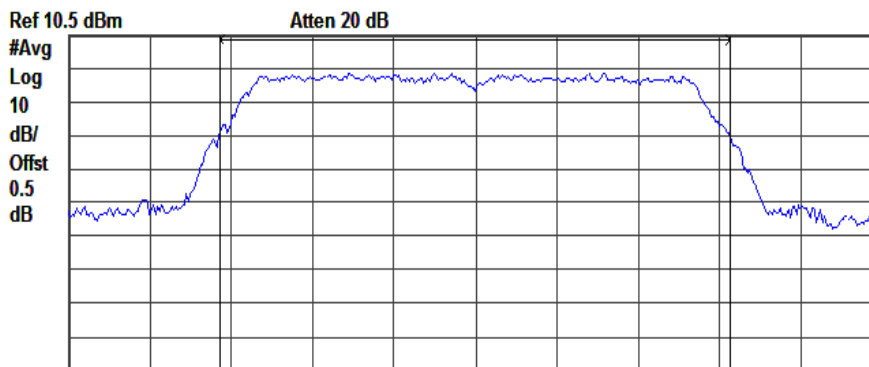

Center 2.462 GHz Span 30 MHz
#Res BW 300 kHz #VBW 1 MHz Sweep 8 ms (401 pts)

Channel Power

Power Spectral Density

8.27 dBm / 18.7360 MHz

-64.63 dBm/Hz

11G-H



SIEMIC, INC.

Accessing global markets

Title: RF Test Report for Mobile Phone
Main Model: s354
Serial Model: N/A
To: FCC Part 15.247: 2013, ANSI C63.4: 2009

Report No.: 14070196-FCC-R3
Issue Date: May 09, 2014
Page: 33 of 77
www.siemec.com
www.siemec.com.cn

Agilent R T

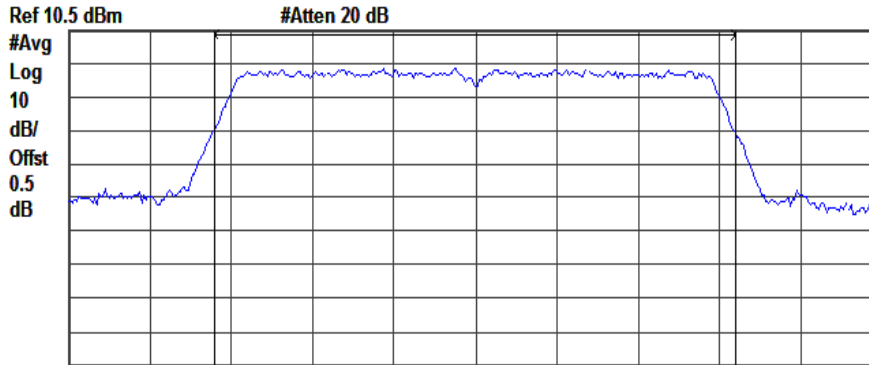

Center 2.412 GHz Span 30 MHz
#Res BW 300 kHz #VBW 1 MHz Sweep 8 ms (401 pts)

Channel Power Power Spectral Density
7.70 dBm / 19.1380 MHz -64.12 dBm/Hz

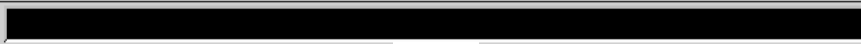

11N-L

Agilent R T

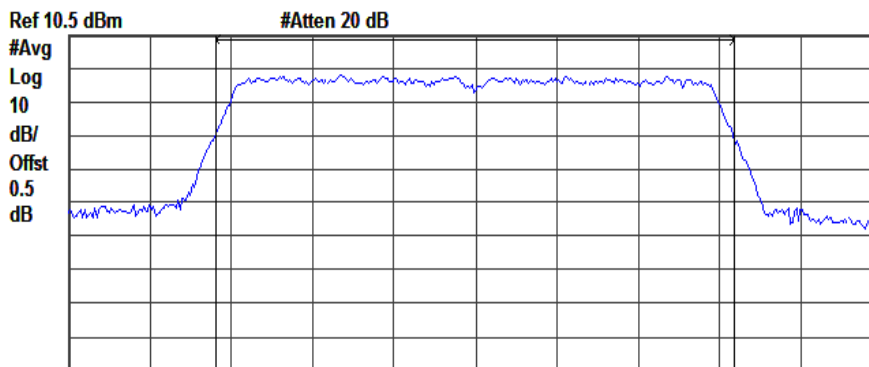

Center 2.437 GHz Span 30 MHz
#Res BW 300 kHz #VBW 1 MHz Sweep 8 ms (401 pts)

Channel Power Power Spectral Density
7.91 dBm / 19.0770 MHz -64.89 dBm/Hz



11N-M



SIEMIC, INC.

Accessing global markets

Title: RF Test Report for Mobile Phone
Main Model: s354
Serial Model: N/A
To: FCC Part 15.247: 2013, ANSI C63.4: 2009

Report No.: 14070196-FCC-R3
Issue Date: May 09, 2014
Page: 34 of 77
www.siemic.com
www.siemic.com.cn

Agilent

R T

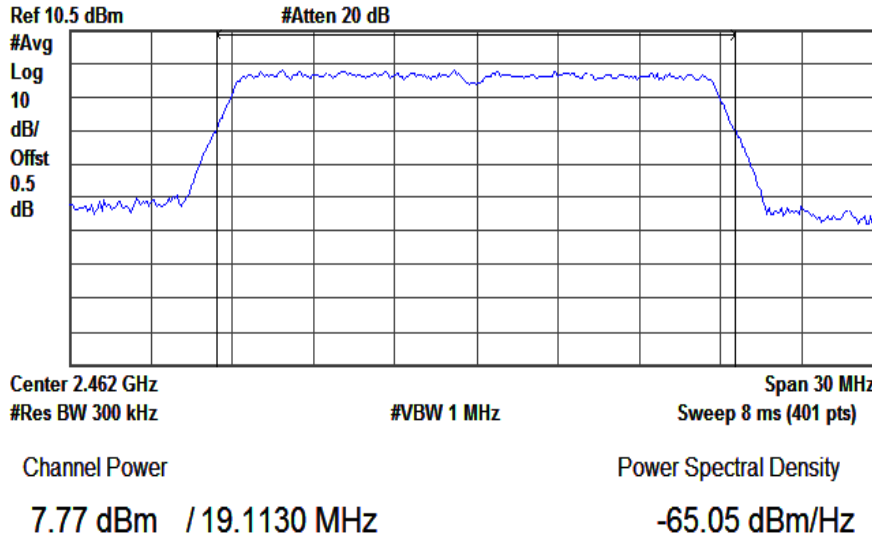

11N-H.

5.5 §15.247(e) - Power Spectral Density

1. **Conducted Measurement**
EUT was set for low, mid, high channel with modulated mode and highest RF output power.
The spectrum analyzer was connected to the antenna terminal.
2. **Environmental Conditions**

Temperature	20°C
Relative Humidity	58%
Atmospheric Pressure	1020mbar
3. **Conducted Emissions Measurement Uncertainty**
All test measurements carried out are traceable to national standards. The uncertainty of the measurement at a confidence level of approximately 95% (in the case where distributions are normal), with a coverage factor of 2, in the range 30MHz – 40GHz is ±1.5dB.
4. **Test date :** May 05, 2014
Tested By : Kahn Yang

Requirement(s):

A conducted power spectral density (PSD) limit of 8 dBm in any 3 kHz band segment within the DTS bandwidth is specified during any time interval of continuous transmission. By rule, the same method as used to determine the conducted output power shall be used to determine the power spectral density (i.e., if maximum peak conducted output power was measured then the peak PSD procedure shall be used and if maximum conducted output power was measured then the average PSD procedure shall be used).

If the average PSD is measured with a power averaging (RMS) detector or a sample detector, then the spectrum analyzer must be capable of utilizing a number of measurement points in each sweep that is greater than or equal to twice the span/RBW in order to ensure bin-to-bin spacing of $\leq RBW/2$ so that narrowband signals are not lost between frequency bins.

Procedures:

This procedure must be used if maximum peak conducted output power was used to demonstrate compliance to the fundamental output power limit, and is optional if the maximum (average) conducted output power was used to demonstrate compliance.

1. Set analyzer center frequency to DTS channel center frequency.
2. Set the span to 1.5 times the DTS channel bandwidth.
3. Set the RBW ≥ 3 kHz.
4. Set the VBW $\geq 3 \times$ RBW.
5. Detector = peak.
6. Sweep time = auto couple.
7. Trace mode = max hold.
8. Allow trace to fully stabilize.
9. Use the peak marker function to determine the maximum amplitude level.
10. If measured value exceeds limit, reduce RBW (no less than 3 kHz) and repeat.

Test Result: Pass.

Please refer to the following tables and plots.

Channel	Frequency (MHz)	Data Rate	PSD (dBm)	Limit (dBm)
802.11b mode				
Low	2412	1	-2.298	8
Middle	2437	1	-0.969	8
High	2462	1	-1.208	8
802.11g mode				
Low	2412	6	-3.130	8
Middle	2437	6	-3.469	8
High	2462	6	-4.171	8
802.11n mode				
Low	2412	MCS0	-5.037	8
Middle	2437	MCS0	-5.927	8
High	2462	MCS0	-6.513	8

Note:

11B: 802.11b
11G: 802.11g
11N: 802.11n

L: Low Channel
M: Middle Channel
H: High Channel



SIEMIC, INC.

Accessing global markets

Title: RF Test Report for Mobile Phone
Main Model: s354
Serial Model: N/A
To: FCC Part 15.247: 2013, ANSI C63.4: 2009

Report No.: 14070196-FCC-R3
Issue Date: May 09, 2014
Page: 37 of 77
www.siemic.com
www.siemic.com.cn

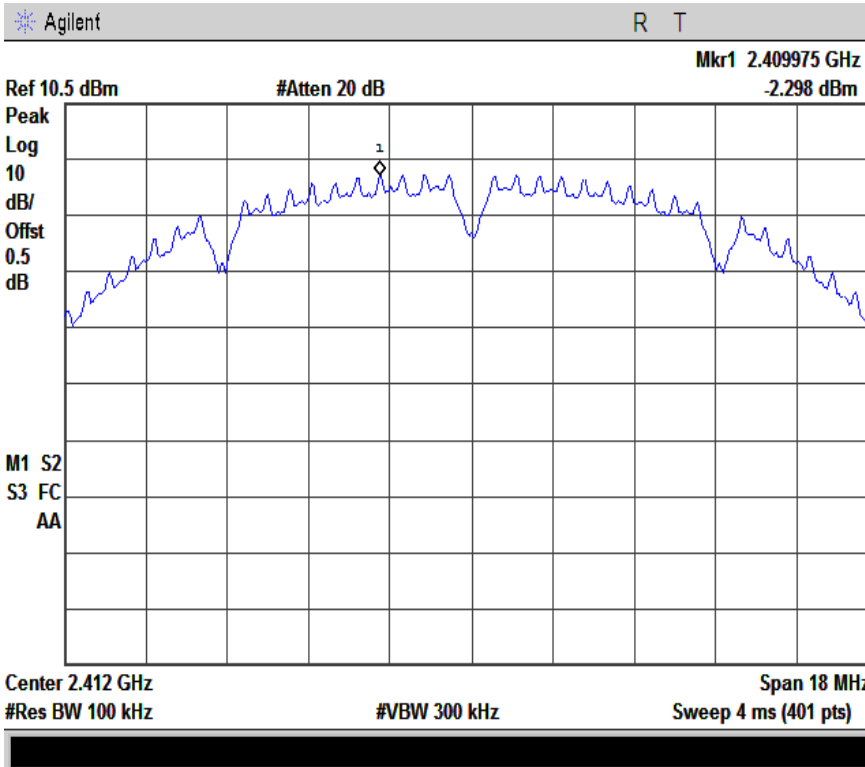

11B-L

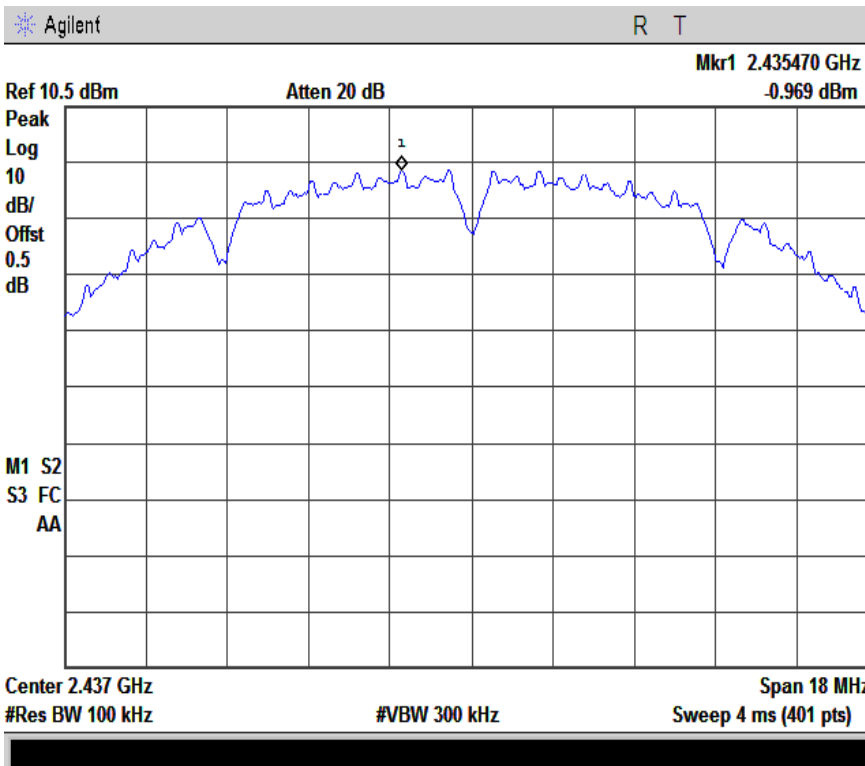

11B-M



SIEMIC, INC.

Accessing global markets

Title: RF Test Report for Mobile Phone
Main Model: s354
Serial Model: N/A
To: FCC Part 15.247: 2013, ANSI C63.4: 2009

Report No.: 14070196-FCC-R3
Issue Date: May 09, 2014
Page: 38 of 77
www.siemic.com
www.siemic.com.cn

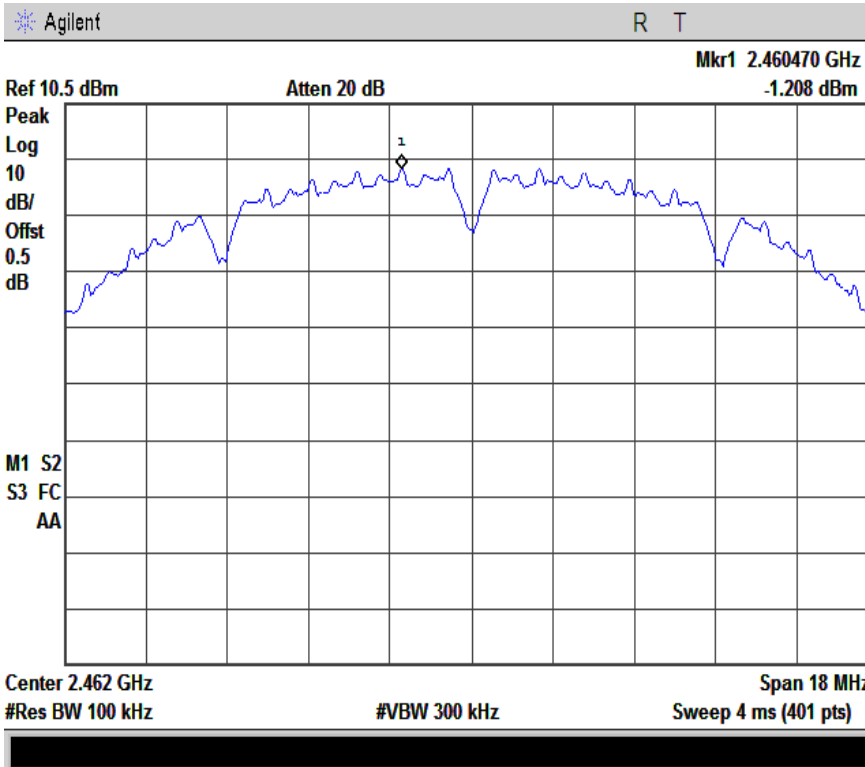

11B-H

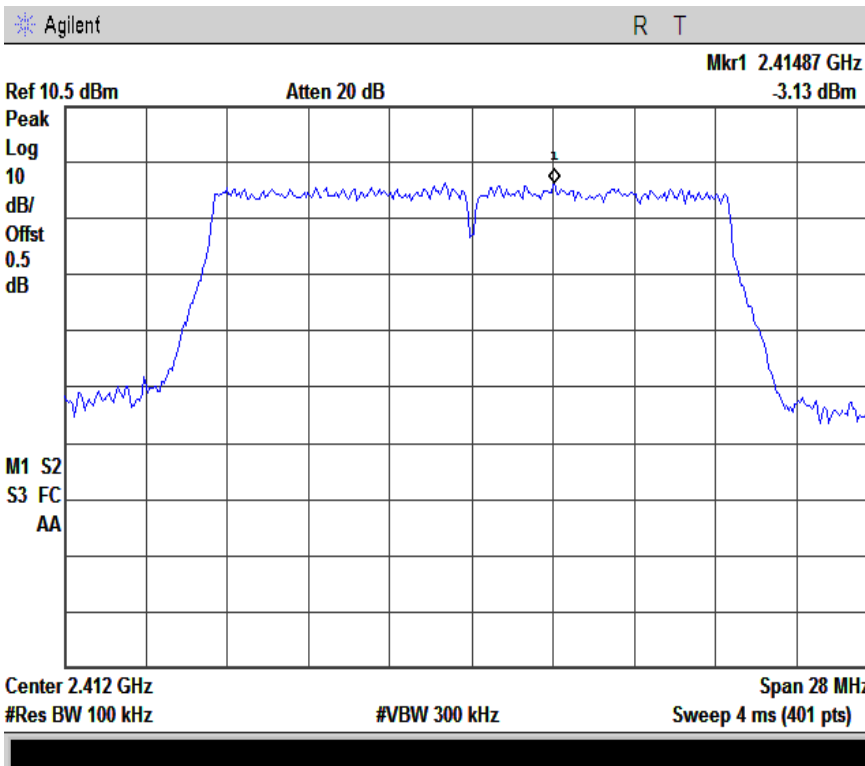

11G-L



SIEMIC, INC.

Accessing global markets

Title: RF Test Report for Mobile Phone
Main Model: s354
Serial Model: N/A
To: FCC Part 15.247: 2013, ANSI C63.4: 2009

Report No.: 14070196-FCC-R3
Issue Date: May 09, 2014
Page: 39 of 77
www.siemic.com
www.siemic.com.cn

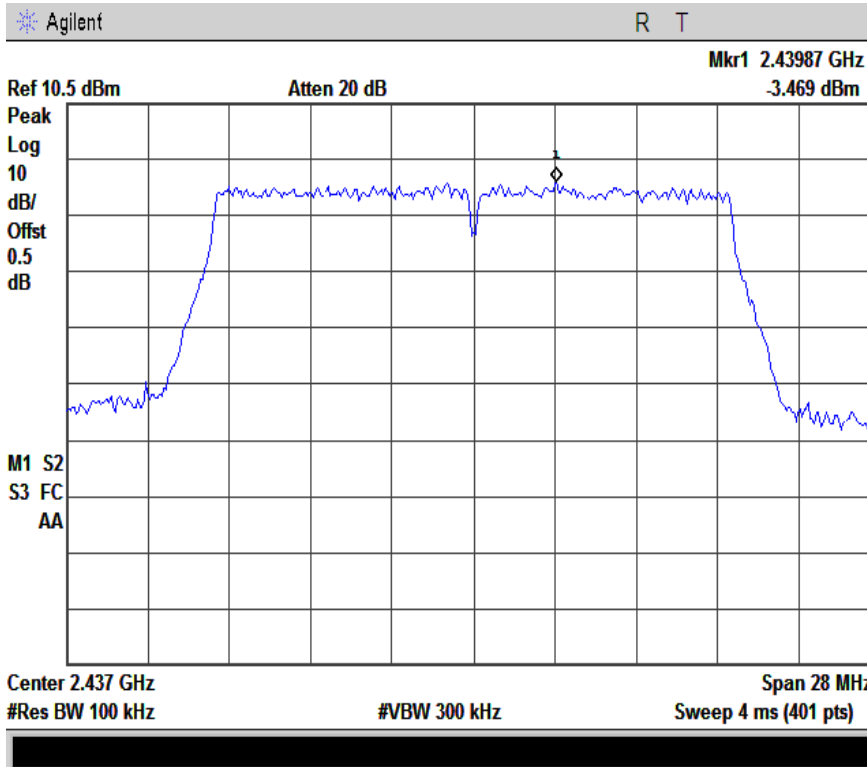

11G-M

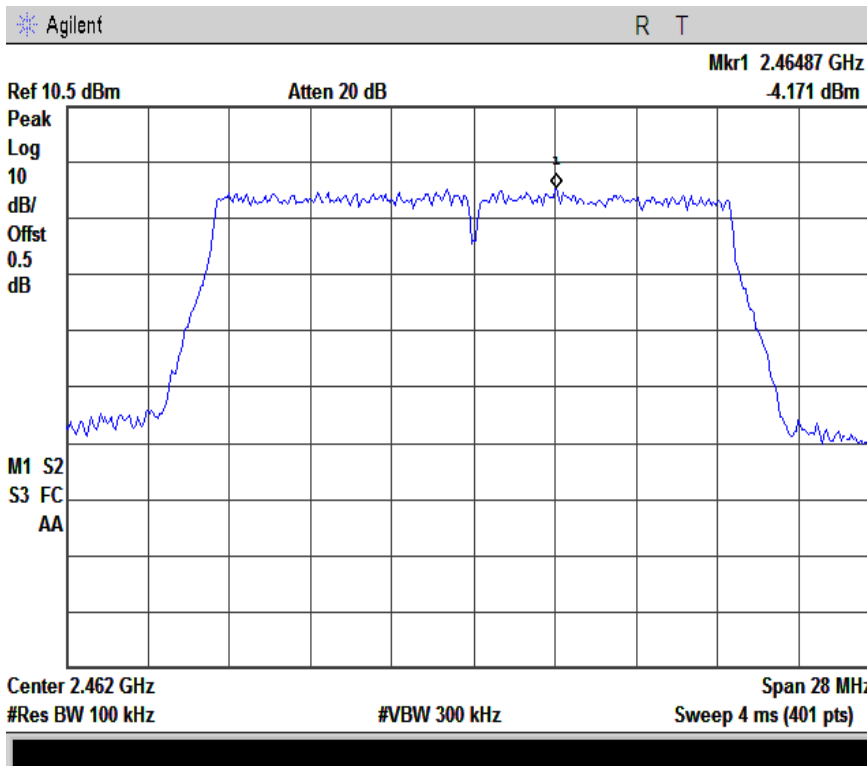

11G-H



SIEMIC, INC.

Accessing global markets

Title: RF Test Report for Mobile Phone
Main Model: s354
Serial Model: N/A
To: FCC Part 15.247: 2013, ANSI C63.4: 2009

Report No.: 14070196-FCC-R3
Issue Date: May 09, 2014
Page: 40 of 77
www.siemic.com
www.siemic.com.cn

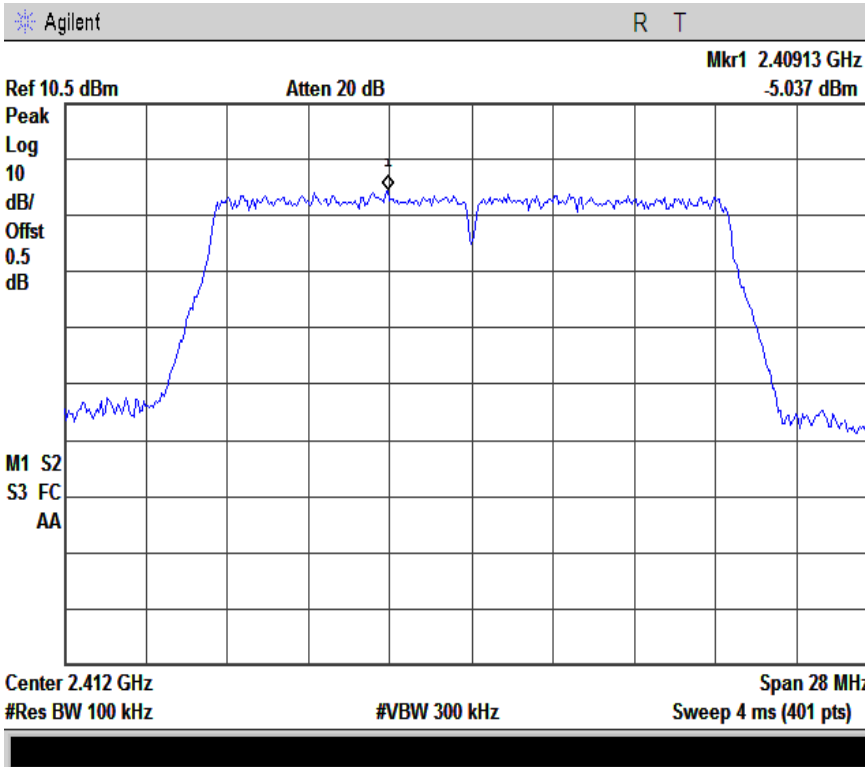

11N-L

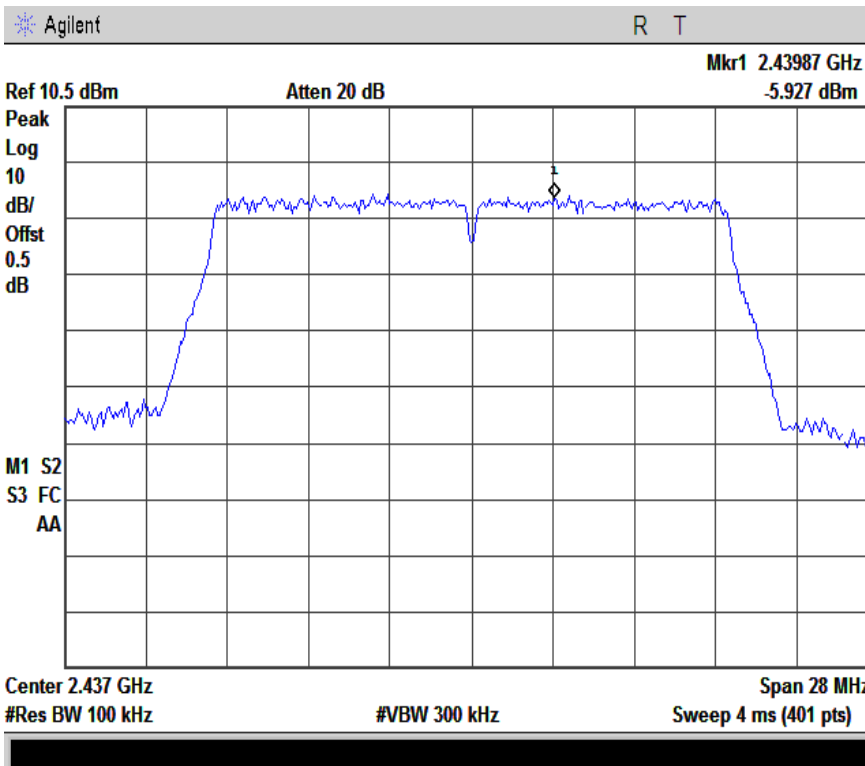

11N-M



SIEMIC, INC.

Accessing global markets

Title: RF Test Report for Mobile Phone
Main Model: s354
Serial Model: N/A
To: FCC Part 15.247: 2013, ANSI C63.4: 2009

Report No.: 14070196-FCC-R3
Issue Date: May 09, 2014
Page: 41 of 77
www.siemic.com
www.siemic.com.cn

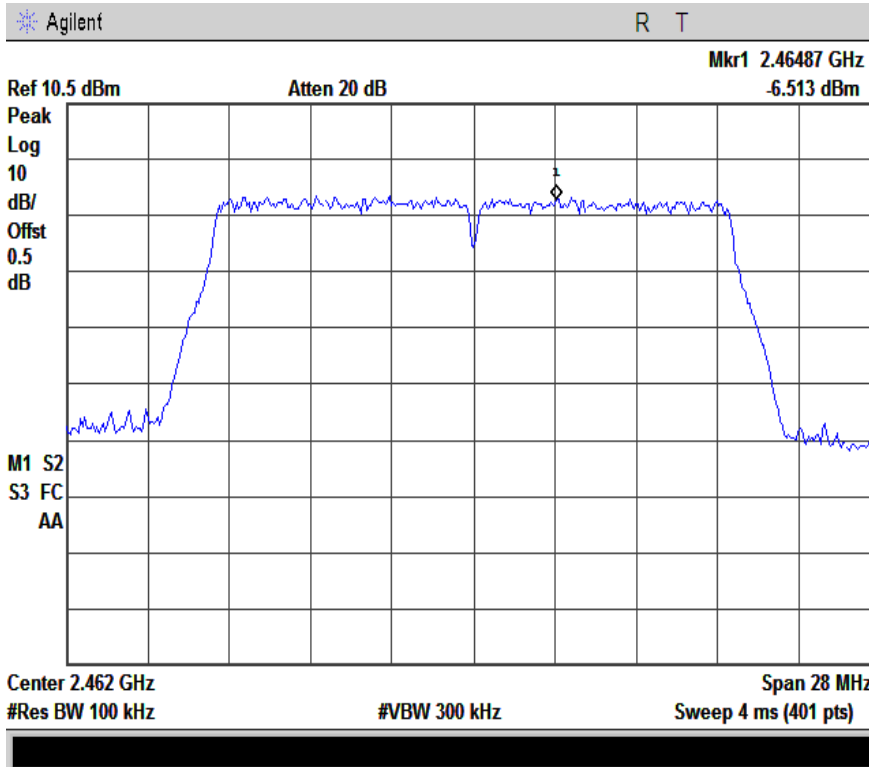

11N-H

5.6 §15.247(d) –Band-Edge & Unwanted Emissions into Non-Restricted Frequency Bands

1. In any 100 kHz bandwidth outside the frequency band in which the spread spectrum or digitally modulated intentional radiator is operating, the radio frequency power that is produced by the intentional radiator shall be at least 20 dB below that in the 100 kHz bandwidth within the band that contains the highest level of the desired power, based on either an RF conducted or a radiated measurement, provided the transmitter demonstrates compliance with the peak conducted power limits. If the transmitter complies with the conducted power limits based on the use of RMS averaging over a time interval, as permitted under paragraph (b)(3) of this section, the attenuation required under this paragraph shall be 30 dB instead of 20 dB. Attenuation below the general limits specified in §15.209(a) is not required. In addition, radiated emissions which fall in the restricted bands, as defined in §15.205(a), must also comply with the radiated emission limits specified in §15.209(a) (see §15.205(c))

2. Environmental Conditions

Temperature	22°C
Relative Humidity	54%
Atmospheric Pressure	1009mbar

3. Test date : April 29, 2014
 Tested By : Kahn Yang

Requirement(s):

Band-Edge Measurements

An additional consideration when performing conducted measurements of restricted band emissions is that unwanted emissions radiating from the EUT cabinet, control circuits, power leads, or intermediate circuit elements will likely go undetected in a conducted measurement configuration. To address this concern, a radiated test shall be performed to ensure that emissions emanating from the EUT cabinet (rather than the antenna port) also comply with the applicable limits.

For these cabinet radiated spurious emission measurements the EUT transmit antenna may be replaced with a termination matching the nominal impedance of the antenna. Procedures for performing radiated measurements are specified in ANSI C63.10. All detected emissions shall comply with the applicable limits.

Procedures: (Radiated Method Only)

1. Check the calibration of the measuring instrument using either an internal calibrator or a known signal from an external generator.
2. Position the EUT on the rotated table inside the anechoic chamber without connection to measurement instrument. Turn on the EUT and make it operate in transmitting mode. Then set it to Low Channel and High Channel within its operating range, and make sure the instrument is operated in its linear range. Repeat above procedures until all measured frequencies were complete.
3. Set band RBW=1MHz, VBW=3MHz with a convenient frequency span from band edge.
4. Find the highest point in edge frequency, and then calculated results.
5. Repeat above procedures until all measured frequencies were complete.

Test Result: Pass.

Please refer to the following tables and plots.

Note:

B: 802.11b

G: 802.11g

N20: 802.11n

1: Left Side

11: Right Side

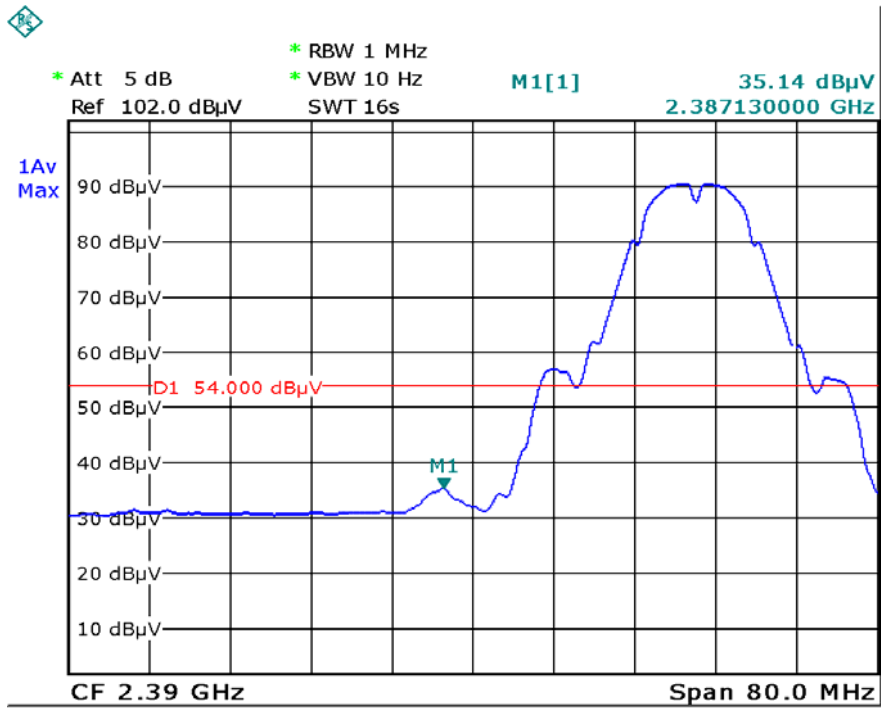

Date: 29.APR.2014 16:40:06

B-1 AV

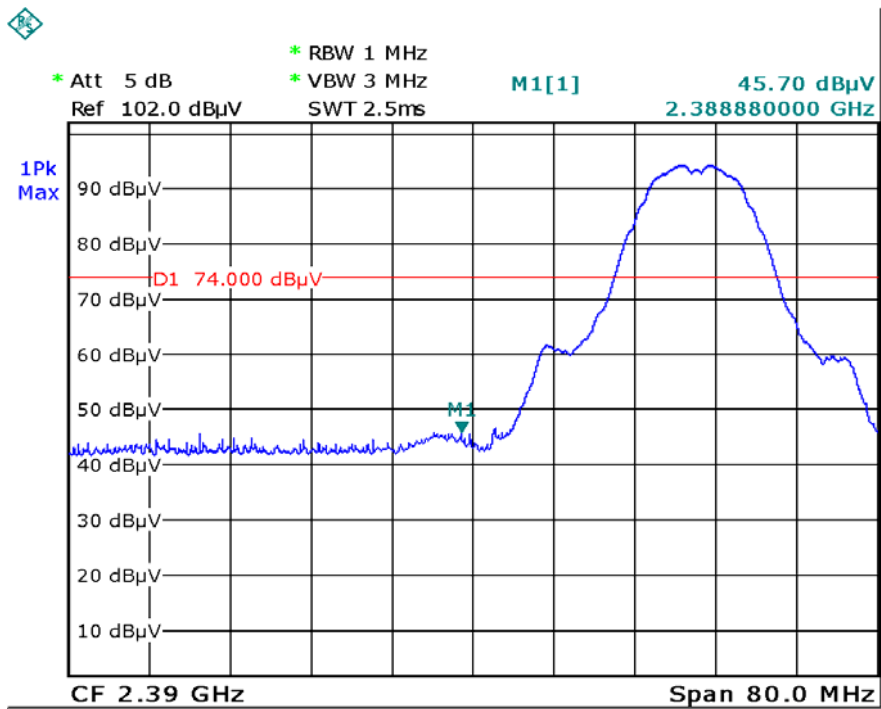

Date: 29.APR.2014 16:38:52

B-1 PK



SIEMIC, INC.

Accessing global markets

Title: RF Test Report for Mobile Phone
Main Model: s354
Serial Model: N/A
To: FCC Part 15.247: 2013, ANSI C63.4: 2009

Report No.: 14070196-FCC-R3
Issue Date: May 09, 2014
Page: 44 of 77
www.sieminc.com
www.sieminc.com.cn

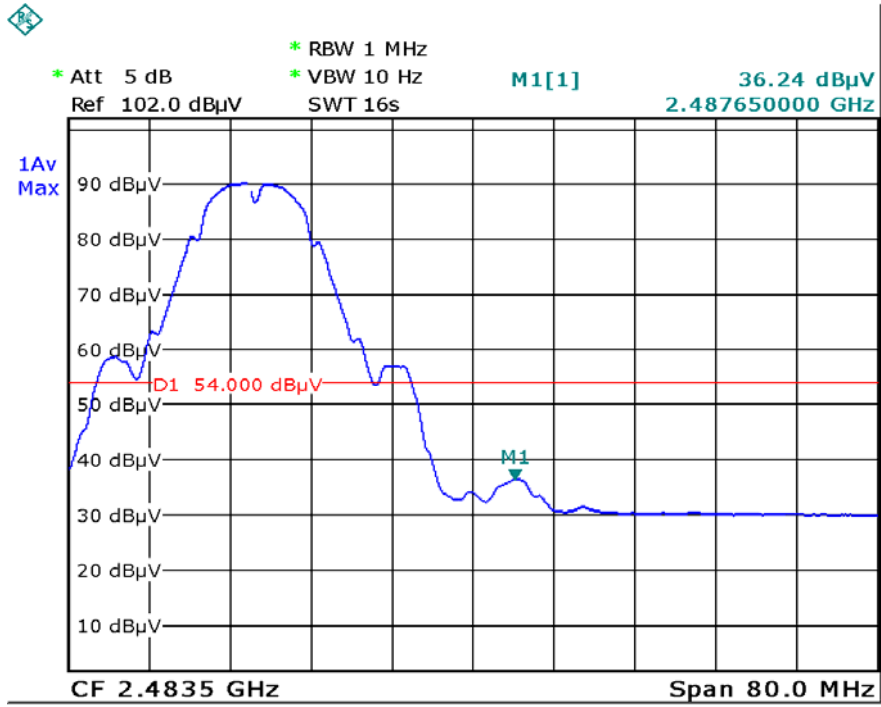

Date: 29.APR.2014 16:55:42

B-11 AV

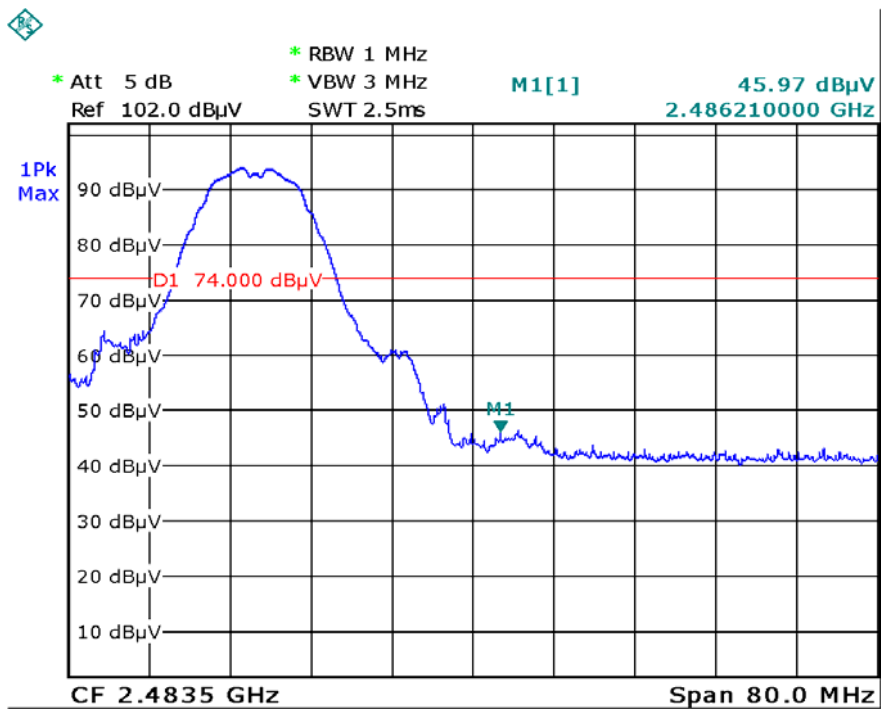

Date: 29.APR.2014 16:56:29

B-11 PK



SIEMIC, INC.

Accessing global markets

Title: RF Test Report for Mobile Phone
Main Model: s354
Serial Model: N/A
To: FCC Part 15.247: 2013, ANSI C63.4: 2009

Report No.: 14070196-FCC-R3
Issue Date: May 09, 2014
Page: 45 of 77
www.siemic.com
www.siemic.com.cn

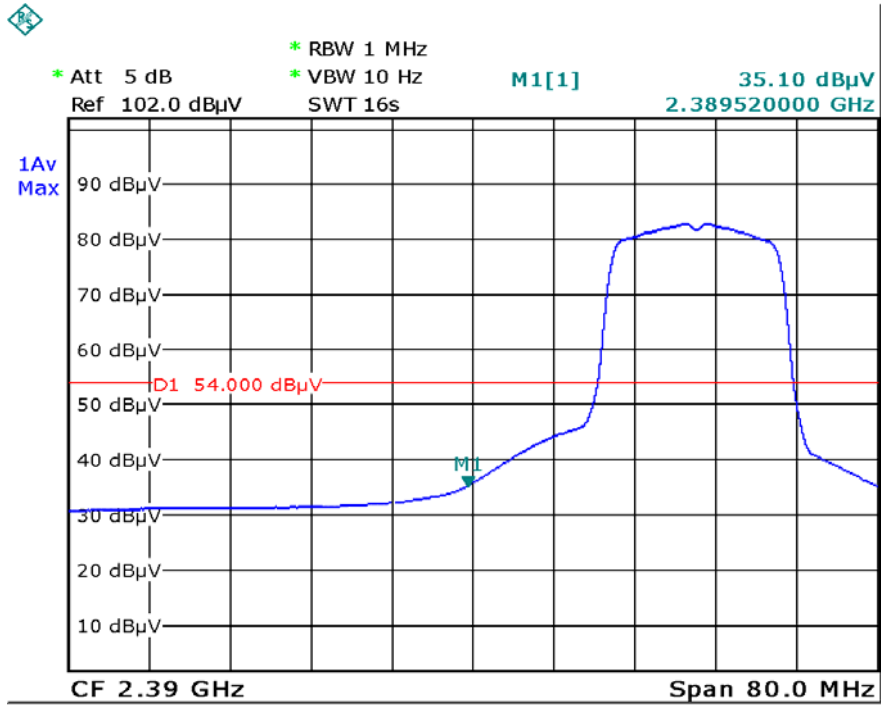

Date: 29.APR.2014 16:42:26

G-1 AV

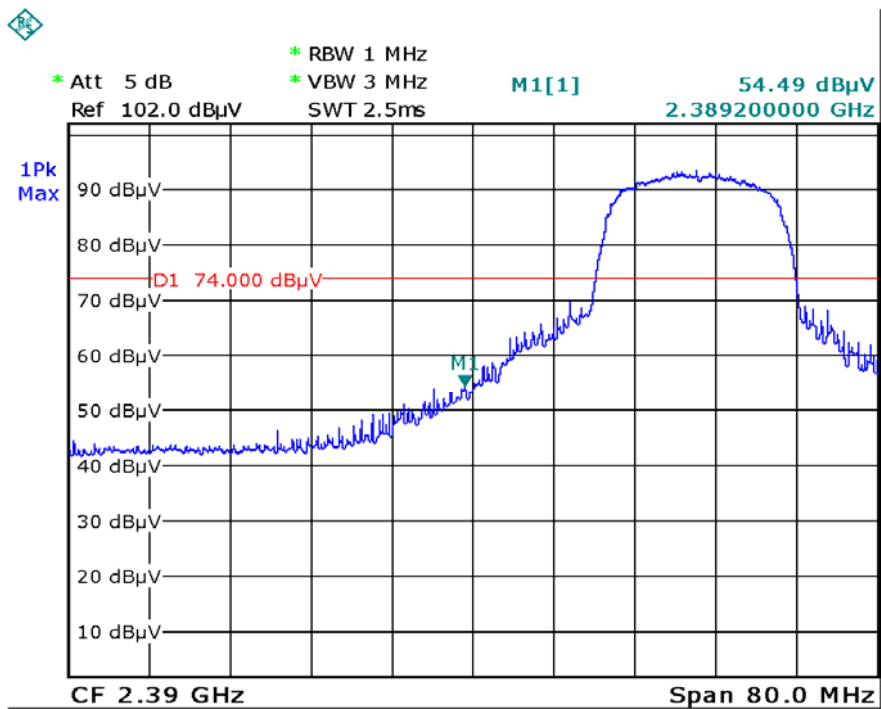

Date: 29.APR.2014 16:43:19

G-1 PK



SIEMIC, INC.

Accessing global markets

Title: RF Test Report for Mobile Phone
Main Model: s354
Serial Model: N/A
To: FCC Part 15.247: 2013, ANSI C63.4: 2009

Report No.: 14070196-FCC-R3
Issue Date: May 09, 2014
Page: 46 of 77
www.sieminc.com
www.sieminc.com.cn

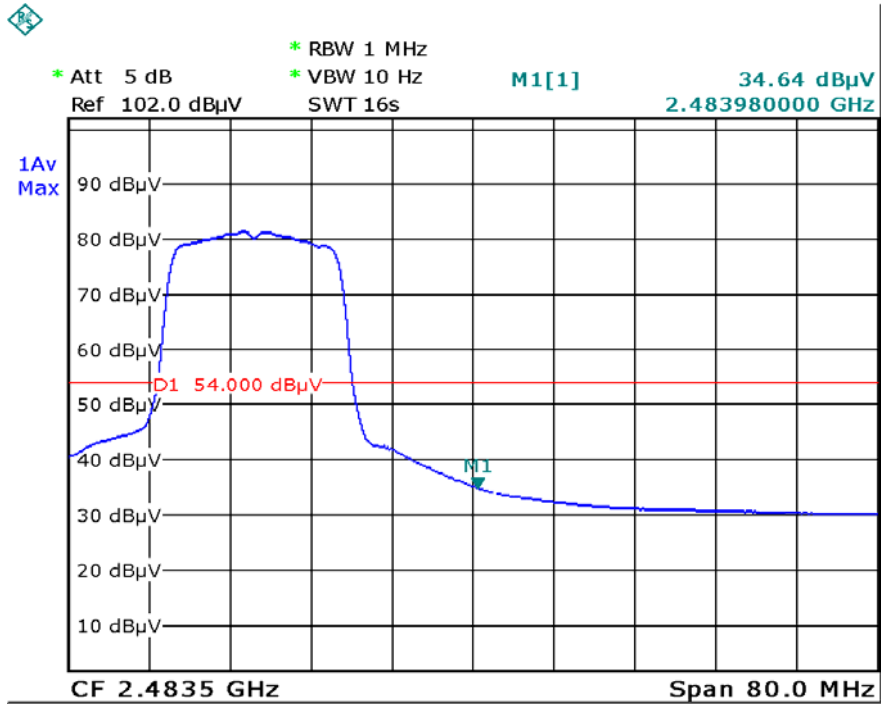

Date: 29.APR.2014 16:53:24

G-11 AV

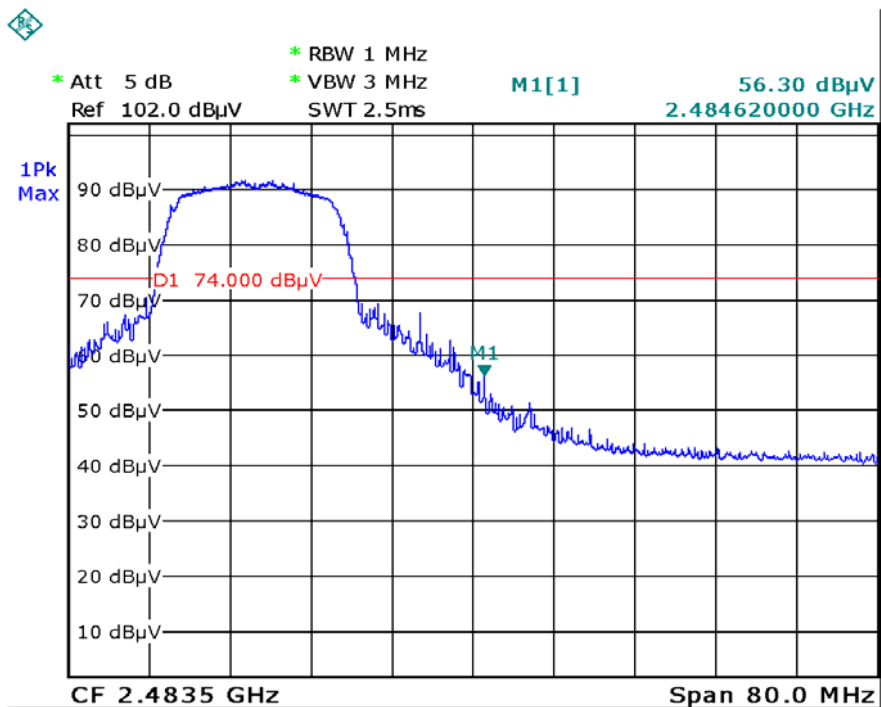

Date: 29.APR.2014 16:52:30

G-11 PK



SIEMIC, INC.

Accessing global markets

Title: RF Test Report for Mobile Phone
Main Model: s354
Serial Model: N/A
To: FCC Part 15.247: 2013, ANSI C63.4: 2009

Report No.: 14070196-FCC-R3
Issue Date: May 09, 2014
Page: 47 of 77
www.siemic.com
www.siemic.com.cn

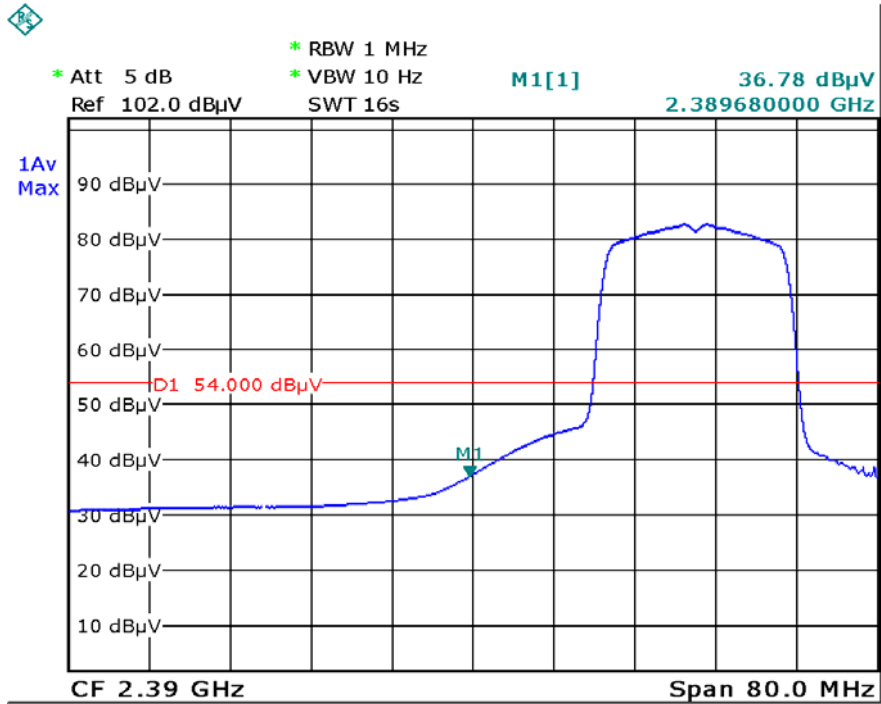

Date: 29.APR.2014 16:47:30

N20-1 AV

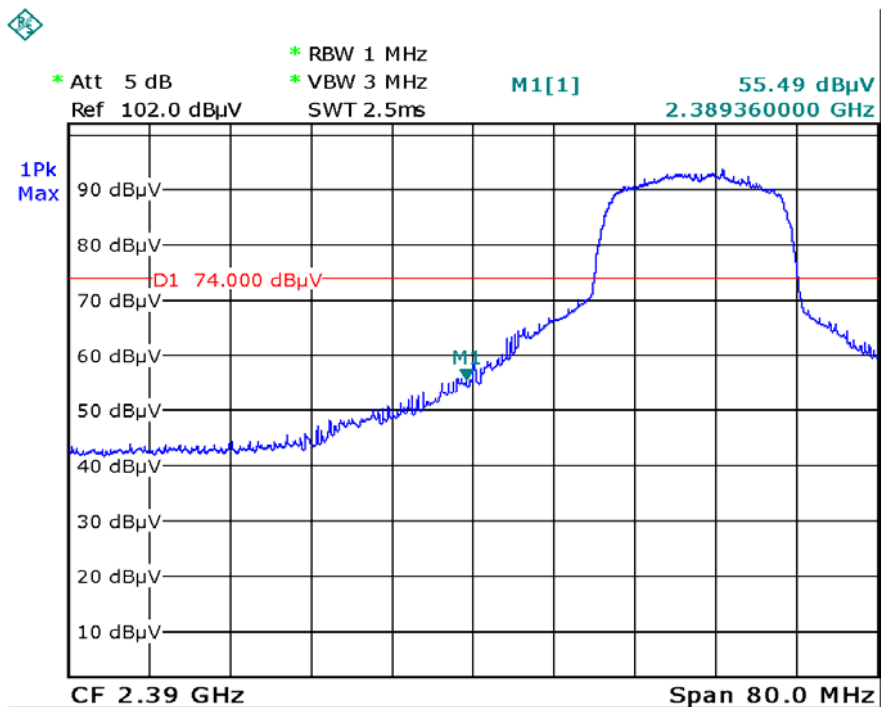

Date: 29.APR.2014 16:45:48

N20-1 PK



SIEMIC, INC.

Accessing global markets

Title: RF Test Report for Mobile Phone
Main Model: s354
Serial Model: N/A
To: FCC Part 15.247: 2013, ANSI C63.4: 2009

Report No.: 14070196-FCC-R3
Issue Date: May 09, 2014
Page: 48 of 77
www.siemec.com
www.siemec.com.cn

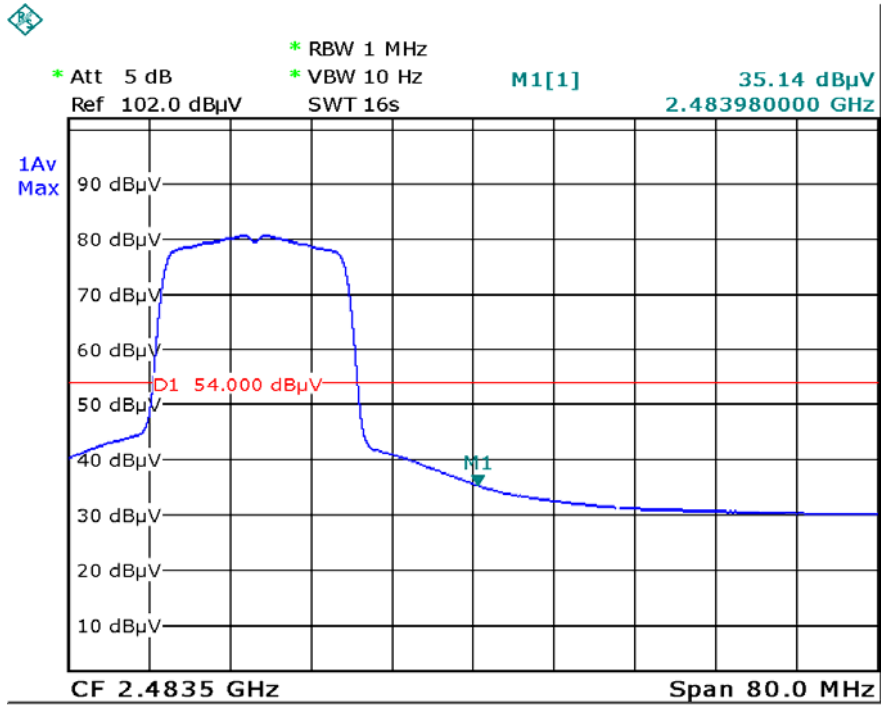

N20-11 AV

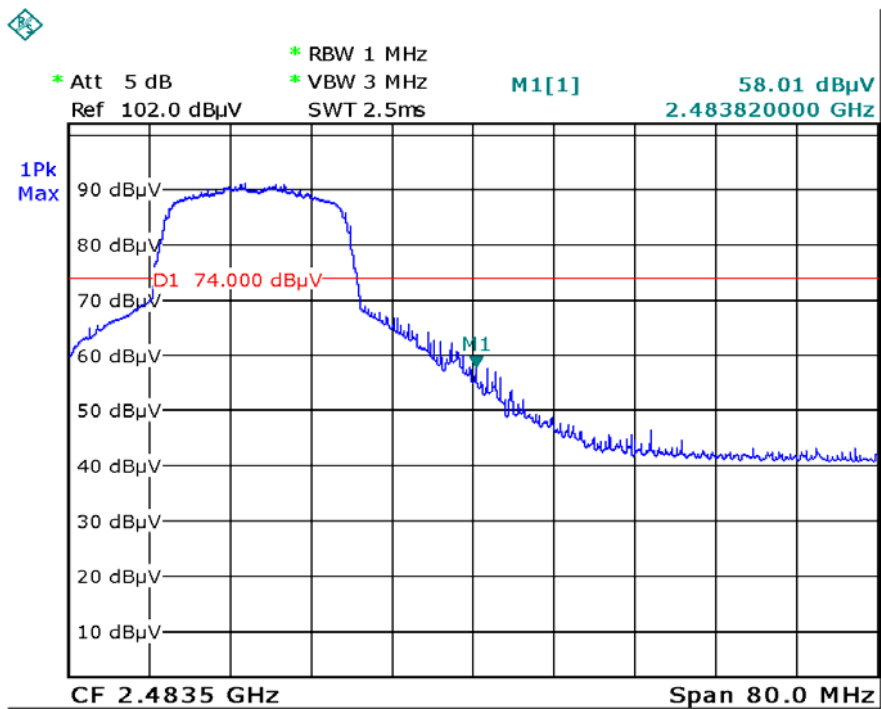

N20-11 PK

5.7 §15.207 (a) - AC Power Line Conducted Emissions

Requirement:

Frequency of emission (MHz)	Conducted limit (dBµV)	
	Quasi-peak	Average
0.15–0.5	66 to 56*	56 to 46*
0.5–5	56	46
5–30	60	50

*Decreases with the logarithm of the frequency.

Procedures:

- All possible modes of operation were investigated. Only the 6 worst case emissions measured, using the correct CISPR and Average detectors, are reported. All other emissions were relatively insignificant.
- A "-ve" margin indicates a PASS as it refers to the margin present below the limit line at the particular frequency.
- Conducted Emissions Measurement Uncertainty
All test measurements carried out are traceable to national standards. The uncertainty of the measurement at a confidence level of approximately 95% (in the case where distributions are normal), with a coverage factor of 2, in the range 9kHz – 30MHz (Average & Quasi-peak) is ±3.5dB.
- Environmental Conditions

Temperature	22°C
Relative Humidity	52%
Atmospheric Pressure	1011mbar
- Test date: April 30, 2014
Tested By : Kahn Yang

Test Mode:	Transmitting Mode(Worse Case)
-------------------	--------------------------------------

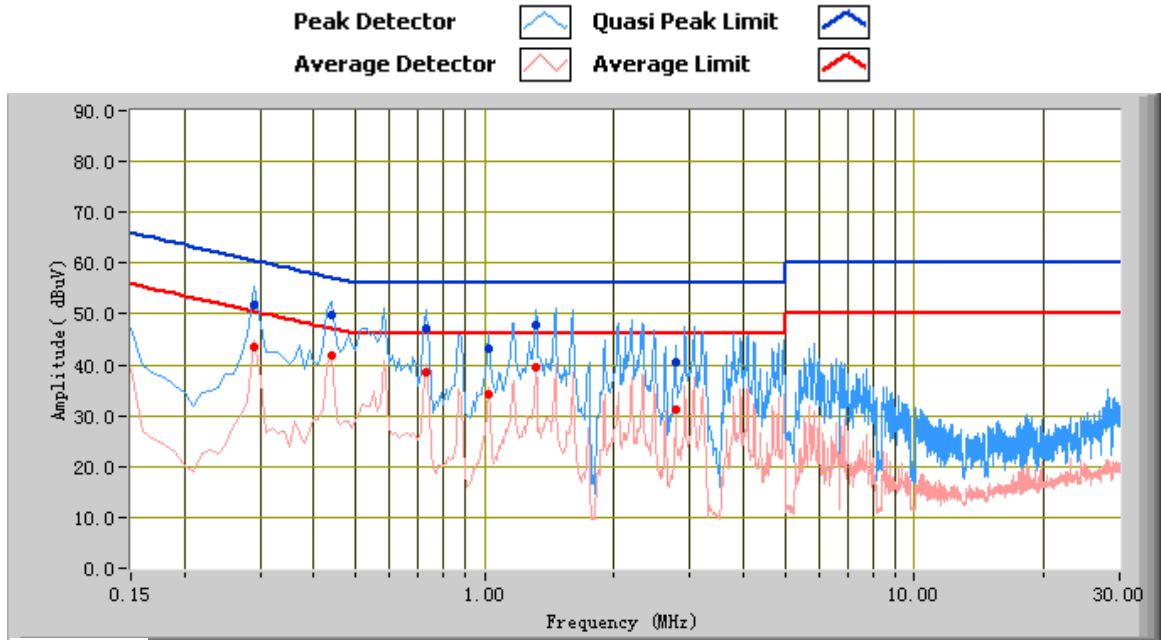

Test Data

Phase Line Plot at 120Vac, 60Hz

Frequency (MHz)	Quasi Peak (dBuV)	Limit (dBuV)	Margin (dB)	Average (dBuV)	Limit (dBuV)	Margin (dB)	Factors (dB)
0.44	49.70	57.06	-7.36	41.73	47.06	-5.33	10.81
0.73	47.04	56.00	-8.96	38.45	46.00	-7.55	10.43
0.29	51.90	60.52	-8.62	43.44	50.52	-7.08	11.57
1.31	47.89	56.00	-8.11	39.66	46.00	-6.34	10.31
1.02	43.23	56.00	-12.77	34.35	46.00	-11.65	10.29
2.78	40.43	56.00	-15.57	31.13	46.00	-14.87	10.58

Test Mode:	Transmitting Mode(Worse Case)
-------------------	--------------------------------------

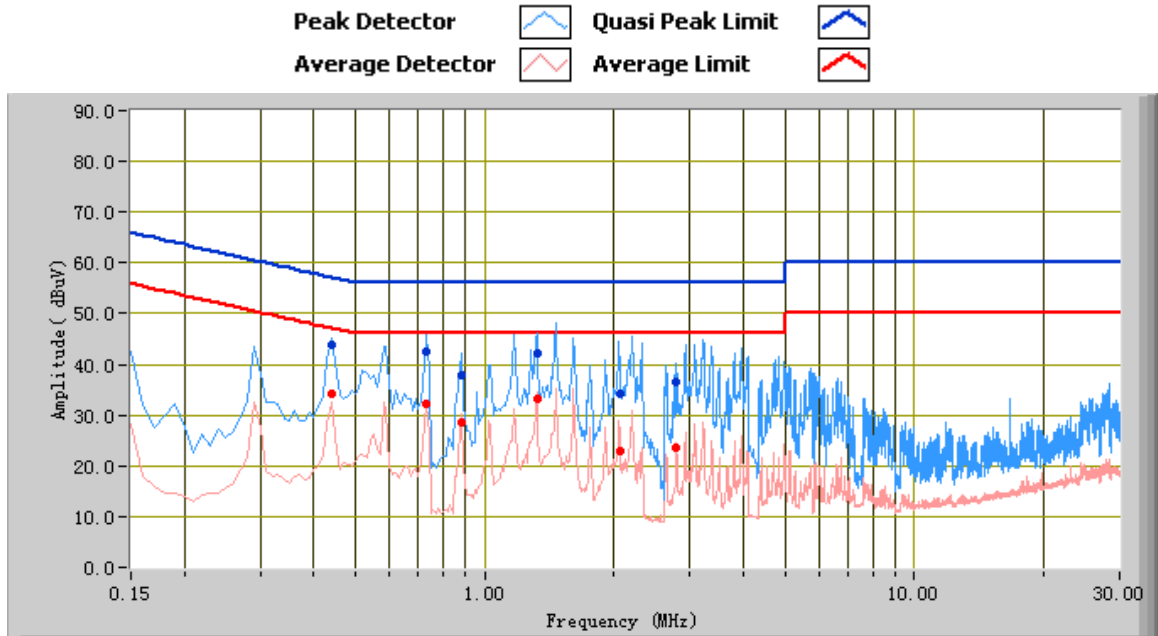

Test Data

Phase Neutral Plot at 120Vac, 60Hz

Frequency (MHz)	Quasi Peak (dBuV)	Limit (dBuV)	Margin (dB)	Average (dBuV)	Limit (dBuV)	Margin (dB)	Factors (dB)
1.32	42.10	56.00	-13.90	33.20	46.00	-12.80	10.32
0.73	42.56	56.00	-13.44	32.32	46.00	-13.68	10.43
0.44	43.86	57.06	-13.20	34.35	47.06	-12.71	10.81
0.88	37.84	56.00	-18.16	28.49	46.00	-17.51	10.36
2.06	34.28	56.00	-21.72	22.98	46.00	-23.02	10.45
2.78	36.60	56.00	-19.40	23.52	46.00	-22.48	10.58

5.8 §15.209, §15.205 & §15.247(d) - Radiated Spurious Emissions & Unwanted Emissions into Restricted Frequency Bands

1. All possible modes of operation were investigated. Only the 6 worst case emissions measured, using the correct CISPR detectors, are reported. All other emissions were relatively insignificant.
2. A "-ve" margin indicates a PASS as it refers to the margin present below the limit line at the particular frequency.
3. Radiated Emissions Measurement Uncertainty
All test measurements carried out are traceable to national standards. The uncertainty of the measurement at a confidence level of approximately 95% (in the case where distributions are normal), with a coverage factor of 2, in the range 30MHz – 1GHz & 1GHz above (3m & 10m) is +/-6dB.
4. Environmental Conditions

Temperature	20°C
Relative Humidity	56%
Atmospheric Pressure	1015mbar
5. Test date : May 06, 2014
Tested By : Kahn Yang

Requirement: §15.247(d) specifies that emissions which fall in the restricted bands, as defined in **§15.205(a)**, must comply with the radiated emission limits specified in **§15.209(a)**.

Procedures:

Radiated Spurious Emissions Measurement

An additional consideration when performing conducted measurements of restricted band emissions is that unwanted emissions radiating from the EUT cabinet, control circuits, power leads, or intermediate circuit elements will likely go undetected in a conducted measurement configuration. To address this concern, a radiated test shall be performed to ensure that emissions emanating from the EUT cabinet (rather than the antenna port) also comply with the applicable limits.

For these radiated spurious emission measurements the EUT transmit antenna may be replaced with a termination matching the nominal impedance of the antenna. Established procedures for performing radiated measurements shall be used (see C63.10). All detected emissions must comply with the applicable limits.

Measurement Detectors

§15.35(a) specifies that on frequencies less than and below 1000 MHz, the radiated emissions limits assume the use of a CISPR quasi-peak detector function and related measurement bandwidths. **§15.35(b)** specifies that on frequencies above 1000 MHz, the radiated emissions limits assume the use of an average detector and a minimum resolution bandwidth of 1 MHz. In addition, **§15.35(b)** that when average radiated emissions measurements are specified there is also a limit on the peak emissions level which is 20 dB above the applicable maximum permitted average emission limit. These specifications also apply to conducted emissions measurements.

1. CISPR Quasi-Peak Measurement

The specifications for the measuring instrument using the CISPR quasi-peak detector can be found in Publication 16 of the International Special Committee on Radio Frequency Interference (CISPR) of the International Electrotechnical Commission.

As an alternative to CISPR quasi-peak measurement, compliance can be demonstrated to the applicable emission limits using a peak detector.

2. Peak Power Measurement Procedure

Utilize the peak power measurement procedure specified in Section 8.1.1 with the following modifications:

Set analyzer center frequency to the frequency associated with the restricted band emission under examination.

Set RBW = 1 MHz.

Note that if the peak measured value complies with the average limit, it is not necessary to perform a separate average measurement. If this option is exercised, it should be so noted in the test report.

3. Average Power Measurement Procedures

The average restricted band emission levels must be measured with the EUT transmitting continuously ($\geq 98\%$ duty cycle) at its maximum power control level. Optionally, video triggering/signal gating can be used to ensure that measurements are performed only when the EUT is transmitting at its maximum power control level.

The average power measurement procedures described in Section 8.2 shall be used with the following modifications:

Set analyzer center frequency to the frequency associated with the restricted band emission.



Set span to at least 1 MHz.

Use peak marker function to determine the highest amplitude within the RBW (1 MHz).

Test Result: Pass

Test Mode:	Transmitting Mode(Worse Case)
-------------------	--------------------------------------

(Below 1GHz)

Peak Detector 
 Quasi Peak Limit 

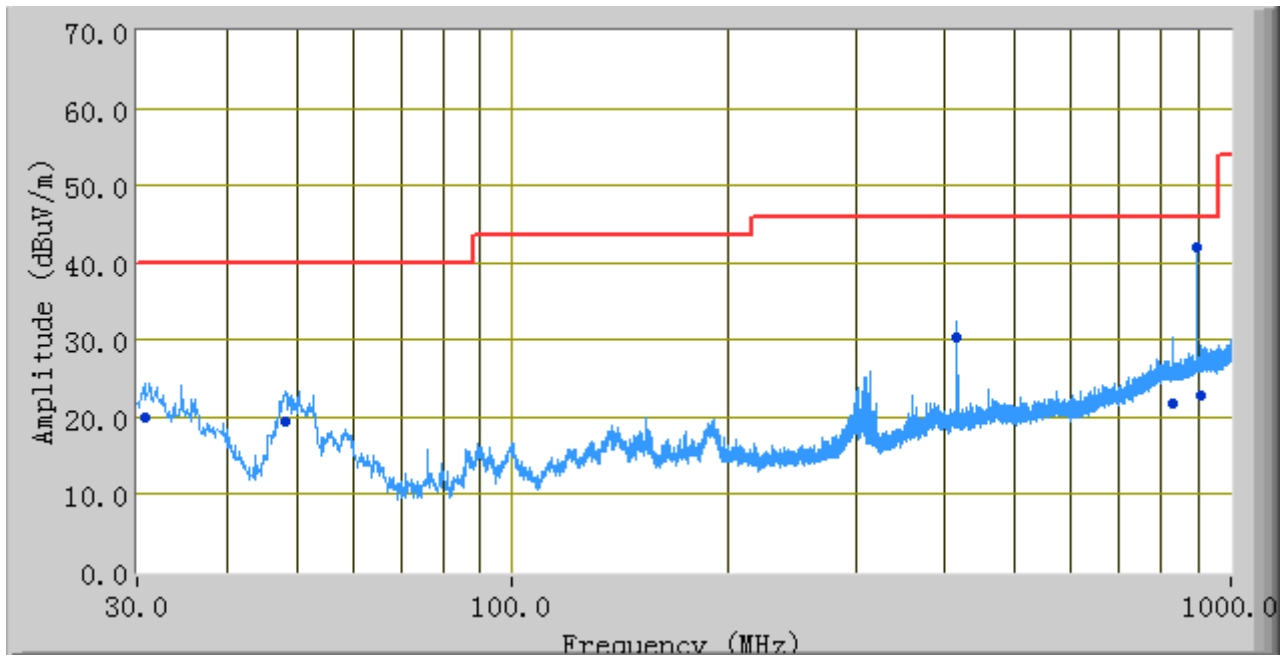

Test Data

Vertical & Horizontal Polarity Plot @3m

Frequency (MHz)	Quasi Peak (dBuV/m)	Azimuth	Polarity(H/V)	Height (cm)	Factors (dB)	Limit (dBuV)	Margin (dB)
896.07	41.90	0.00	H	330.00	4.72	46.00	-4.10
415.99	30.40	116.00	H	265.00	-2.83	46.00	-15.60
30.71	19.95	234.00	V	117.00	-2.06	40.00	-20.05
832.02	21.89	96.00	H	256.00	3.90	46.00	-24.11
48.36	19.57	321.00	V	102.00	-13.14	40.00	-20.43
910.05	22.84	197.00	V	266.00	4.93	46.00	-23.16

Above 1 GHz:

Test Mode: Transmitting

Note: Other modes were verified, only the result of worst case basic rate mode was presented.

Mode: 802.11b
 Low Channel (2412 MHz)

Frequency (MHz)	Substituted level (dBμV/m)	Detector (PK/AV)	Polarity (H/V)	Ant. Factor (dB/m)	Cable Loss (dB)	Pre-Amp. Gain (dB)	Cord. Amp. (dBμV/m)	Limit (dBμV/m)	Margin (dB)
4824	39.13	AV	V	34	4.87	26.79	51.21	54	-2.79
4824	39.19	AV	H	33.8	4.87	26.79	51.07	54	-2.93
4824	46.27	PK	V	34	4.87	26.79	58.35	74	-15.65
4824	46.33	PK	H	33.8	4.87	26.79	58.21	74	-15.79

Middle Channel (2437 MHz)

Frequency (MHz)	Substituted level (dBμV/m)	Detector (PK/AV)	Polarity (H/V)	Ant. Factor (dB/m)	Cable Loss (dB)	Pre-Amp. Gain (dB)	Cord. Amp. (dBμV/m)	Limit (dBμV/m)	Margin (dB)
4874	39.26	AV	V	33.6	4.87	26.78	50.95	54	-3.05
4874	39.24	AV	H	33.8	4.87	26.78	51.13	54	-2.87
4874	45.93	PK	V	33.6	4.87	26.78	57.62	74	-16.38
4874	46.35	PK	H	33.8	4.87	26.78	58.24	74	-15.76

High Channel (2462 MHz)

Frequency (MHz)	Substituted level (dBμV/m)	Detector (PK/AV)	Polarity (H/V)	Ant. Factor (dB/m)	Cable Loss (dB)	Pre-Amp. Gain (dB)	Cord. Amp. (dBμV/m)	Limit (dBμV/m)	Margin (dB)
4924	38.93	AV	V	34.6	4.87	26.75	51.65	54	-2.35
4924	38.97	AV	H	34.7	4.87	26.75	51.79	54	-2.21
4924	46.09	PK	V	34.6	4.87	26.75	58.81	74	-15.19
4924	46.56	PK	H	34.7	4.87	26.75	59.38	74	-14.62

Annex A. TEST INSTRUMENT & METHOD

Annex A.i. TEST INSTRUMENTATION & GENERAL PROCEDURES

Instrument	Model	Serial #	Calibration Date	Calibration Due Date
AC Line Conducted Emissions				
EMI test receiver	ESCS30	8471241027	05/27/2013	05/26/2014
Line Impedance Stabilization Network	LI-125A	191106	11/14/2013	11/13/2014
Line Impedance Stabilization Network	LI-125A	191107	11/14/2013	11/13/2014
LISN	ISN T800	34373	01/11/2014	01/10/2015
Double Ridge Horn Antenna (1 ~18GHz)	AH-118	71283	11/20/2013	11/19/2014
Transient Limiter	LIT-153	531118	09/02/2013	09/01/2014
RF conducted test				
Agilent ESA-E SERIES SPECTRUM ANALYZER	E4407B	MY45108319	09/17/2013	09/16/2014
Power Splitter	1#	1#	09/02/2013	09/01/2014
DC Power Supply	E3640A	MY40004013	09/17/2013	09/16/2014
Wireless Connectivity Test Set	N4010A	GB44440198	03/20/2014	03/19/2015
Radiated Emissions				
EMI test receiver	ESL6	100262	11/23/2013	11/22/2014
Positioning Controller	UC3000	MF780208282	11/19/2013	11/19/2014
OPT 010 AMPLIFIER (0.1-1300MHz)	8447E	2727A02430	09/02/2013	09/01/2014
Microwave Preamplifier (0.5~18GHz)	PAM-118	443008	09/02/2013	09/01/2014
Bilog Antenna (30MHz~6GHz)	JB6	A110712	09/23/2013	09/22/2014
Double Ridge Horn Antenna (1 ~18GHz)	AH-118	71283	11/20/2013	11/19/2014
Universal Radio Communication Tester	CMU200	121393	09/17/2013	09/16/2014

Annex A.ii. CONDUCTED EMISSIONS TEST DESCRIPTION

Test Set-up

1. The EUT and supporting equipment were set up in accordance with the requirements of the standard on top of a 1.5m x 1m x 0.8m high, non-metallic table, as shown in Annex B.
2. The power supply for the EUT was fed through a 50Ω/50μH EUT LISN, connected to filtered mains.
3. The RF OUT of the EUT LISN was connected to the EMI test receiver via a low-loss coaxial cable.
4. All other supporting equipments were powered separately from another main supply.

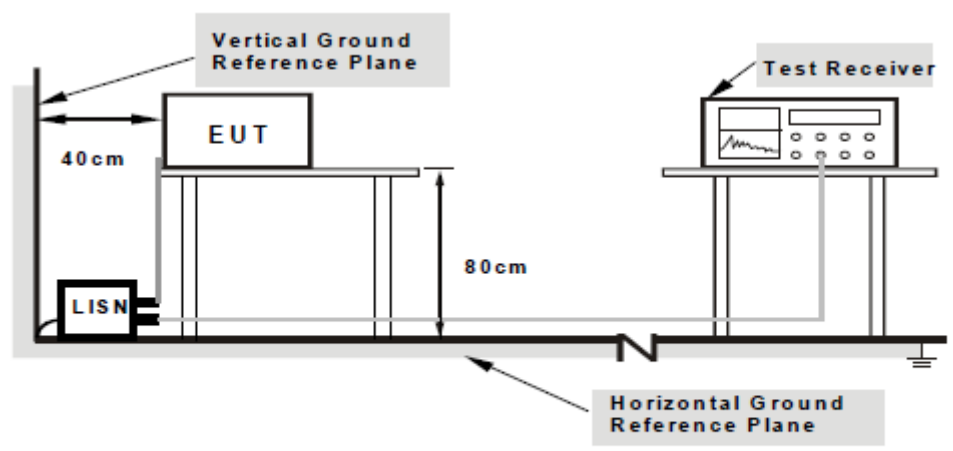

For the actual test configuration, please refer to the related item – Photographs of the Test Configuration1.

Test Method

1. The EUT was switched on and allowed to warm up to its normal operating condition.
2. A scan was made on the NEUTRAL line (for AC mains) or Earth line (for DC power) over the required frequency range using an EMI test receiver.
3. High peaks, relative to the limit line, were then selected.
4. The EMI test receiver was then tuned to the selected frequencies and the necessary measurements made with a receiver bandwidth setting of 10 kHz. For FCC tests, only Quasi-peak measurements were made; while for CISPR/EN tests, both Quasi-peak and Average measurements were made.
5. Steps 2 to 4 were then repeated for the LIVE line (for AC mains) or DC line (for DC power).

Description of Conducted Emission Program

This EMC Measurement software run LabView automation software and offers a common user interface for electromagnetic interference (EMI) measurements. This software is a modern and powerful tool for controlling and monitoring EMI test receivers and EMC test systems. It guarantees reliable collection, evaluation, and documentation of measurement results. Basically, this program will run a pre-scan measurement before it proceeds with the final measurement. The pre-scan routine will run the common scan range from 150 kHz to 30 MHz; the program will first start a peak and average scan on selectable measurement time and step size. After the program complete the pre-scan, this program will perform the Quasi Peak and Average measurement, based on the pre-scan peak data reduction result.

Sample Calculation Example

At 20 MHz

limit = 250 μ V = 47.96 dB μ V

Transducer factor of LISN, pulse limiter & cable loss at 20 MHz = 11.20 dB

Q-P reading obtained directly from EMI Receiver = 40.00 dB μ V
(Calibrated for system losses)

Therefore, Q-P margin = 47.96 – 40.00 = 7.96 i.e. **7.96 dB below limit**

Annex A. iii RADIATED EMISSIONS TEST DESCRIPTION

EUT Characterisation

EUT characterisation, over the frequency range from 30MHz to 10th Harmonic, was done in order to minimise radiated emissions testing time while still maintaining high confidence in the test results.

The EUT was placed in the chamber, at a height of about 0.8m on a turntable. Its radiated emissions frequency profile was observed, using a spectrum analyzer /receiver with the appropriate broadband antenna placed 3m away from the EUT. Radiated emissions from the EUT were maximised by rotating the turntable manually, changing the antenna polarisation and manipulating the EUT cables while observing the frequency profile on the spectrum analyzer / receiver. Frequency points at which maximum emissions occurred, clock frequencies and operating frequencies were then noted for the formal radiated emissions test at the Open Area Test Site (OATS).

Test Set-up

1. The EUT and supporting equipment were set up in accordance with the requirements of the standard on top of a 1.5m X 1.0m X 0.8m high, non-metallic table.
2. The filtered power supply for the EUT and supporting equipment were tapped from the appropriate power sockets located on the turntable.
3. The relevant broadband antenna was set at the required test distance away from the EUT and supporting equipment boundary.

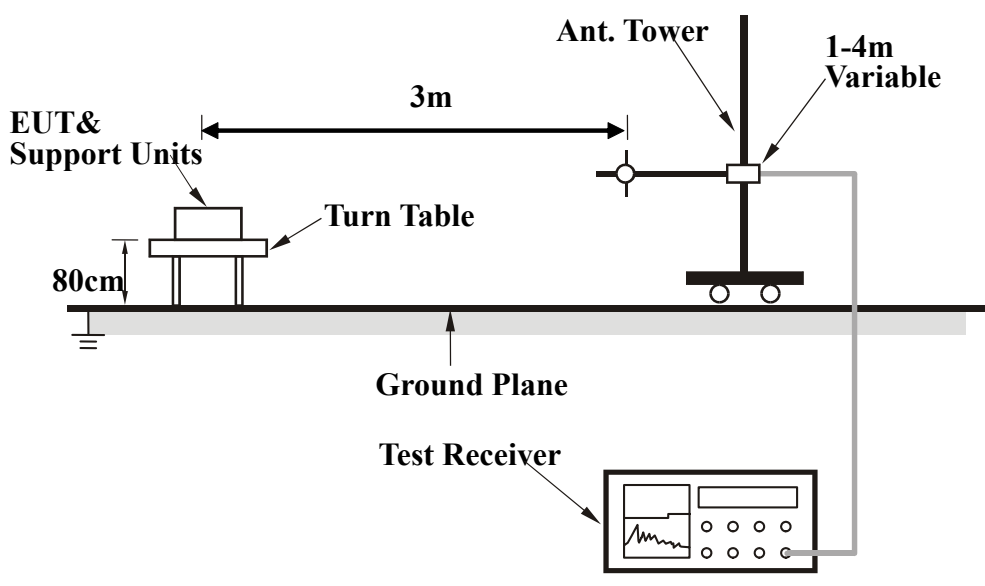

Test Method

The following procedure was performed to determine the maximum emission axis of EUT:

1. With the receiving antenna is H polarization, rotate the EUT in turns with three orthogonal axes to determine the axis of maximum emission.
2. With the receiving antenna is V polarization, rotate the EUT in turns with three orthogonal axes to determine the axis of maximum emission.
3. Compare the results derived from above two steps. So, the axis of maximum emission from EUT was determined and the configuration was used to perform the final measurement.

Final Radiated Emission Measurement

1. Setup the configuration according to figure 1. Turn on EUT and make sure that it is in normal function.
2. For emission frequencies measured below 1 GHz, a pre-scan is performed in a shielded chamber to determine the accurate frequencies of higher emissions will be checked on a open test site. As the same purpose, for emission frequencies measured above 1 GHz, a pre-scan also be performed with a 1 meter measuring distance before final test.
3. For emission frequencies measured below and above 1 GHz, set the spectrum analyzer on a 100 kHz and 1 MHz resolution bandwidth respectively for each frequency measured in step 2.
4. The search antenna is to be raised and lowered over a range from 1 to 4 meters in horizontally polarized orientation. Position the highness when the highest value is indicated on spectrum analyzer, then change the orientation of EUT on test table over a range from 0 ° to 360 ° with a speed as slow as possible, and keep the azimuth that highest emission is indicated on the spectrum analyzer. Vary the antenna position again and record the highest value as a final reading.
5. Repeat step 4 until all frequencies need to be measured was complete.
6. Repeat step 5 with search antenna in vertical polarized orientations.

During the radiated emission test, the Spectrum Analyzer was set with the following configurations:

Frequency Band (MHz)	Function	Resolution bandwidth	Video Bandwidth
30 to 1000	Peak	100 kHz	100 kHz
Above 1000	Peak	1 MHz	1 MHz
	Average	1 MHz	10 Hz

Sample Calculation Example

The field strength is calculated by adding the Antenna Factor and Cable Factor, and subtracting the Amplifier Gain (if any) from the measured reading. For the limit is employed average value, therefore the peak value can be transferred to average value by subtracting the duty factor. The basic equation with a sample calculation is as follows:

$$\text{Peak} = \text{Reading} + \text{Corrected Factor}$$

where

$$\text{Corr. Factor} = \text{Antenna Factor} + \text{Cable Factor} - \text{Amplifier Gain (if any)}$$

And the average value is

$$\text{Average} = \text{Peak Value} + \text{Duty Factor or}$$

$$\text{Set RBW} = 1\text{MHz, VBW} = 10\text{Hz.}$$

Note :

If the measured frequencies are fall in the restricted frequency band, the limit employed must be quasi peak value when frequencies are below or equal to 1 GHz. And the measuring instrument is set to quasi peak detector function.

Annex B. EUT AND TEST SETUP PHOTOGRAPHS

Annex B.i. Photograph 1: EUT External Photo



Whole Package - Top View

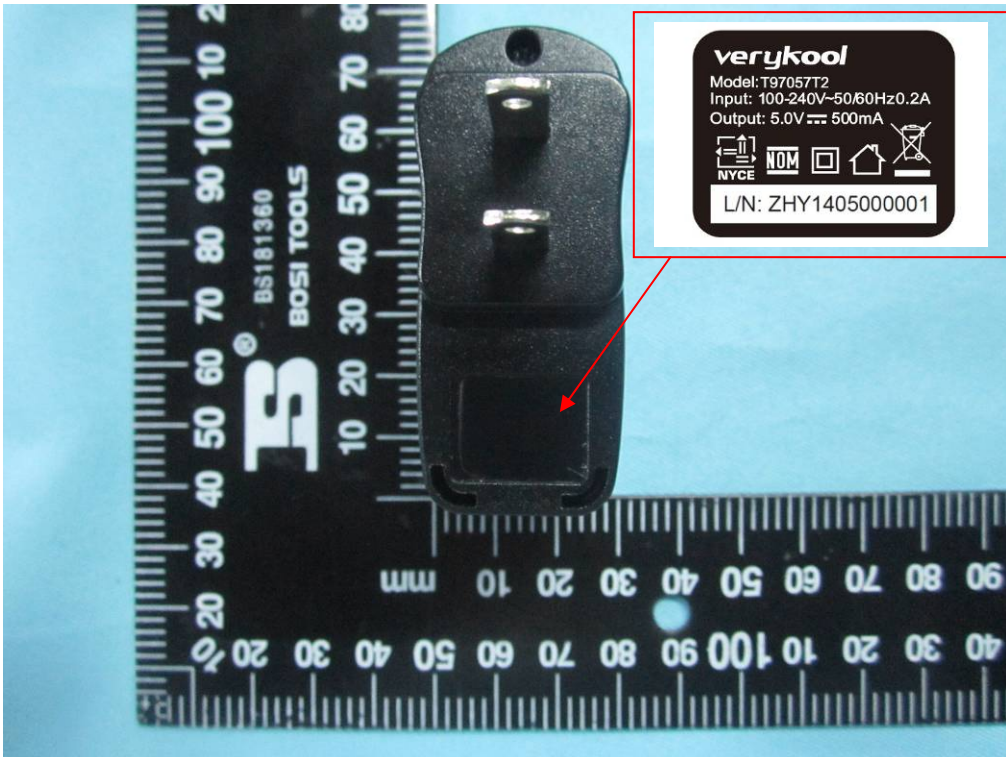

Adapter – Front View



EUT - Front View



EUT - Rear View



SIEMIC, INC.

Accessing global markets

Title: RF Test Report for Mobile Phone
Main Model: s354
Serial Model: N/A
To: FCC Part 15.247: 2013, ANSI C63.4: 2009

Report No.: 14070196-FCC-R3
Issue Date: May 09, 2014
Page: 62 of 77
www.siemic.com
www.siemic.com.cn



EUT - Top View



EUT - Bottom View



SIEMIC, INC.

Accessing global markets

Title: RF Test Report for Mobile Phone
Main Model: s354
Serial Model: N/A
To: FCC Part 15.247: 2013, ANSI C63.4: 2009

Report No.: 14070196-FCC-R3
Issue Date: May 09, 2014
Page: 63 of 77
www.siemic.com
www.siemic.com.cn

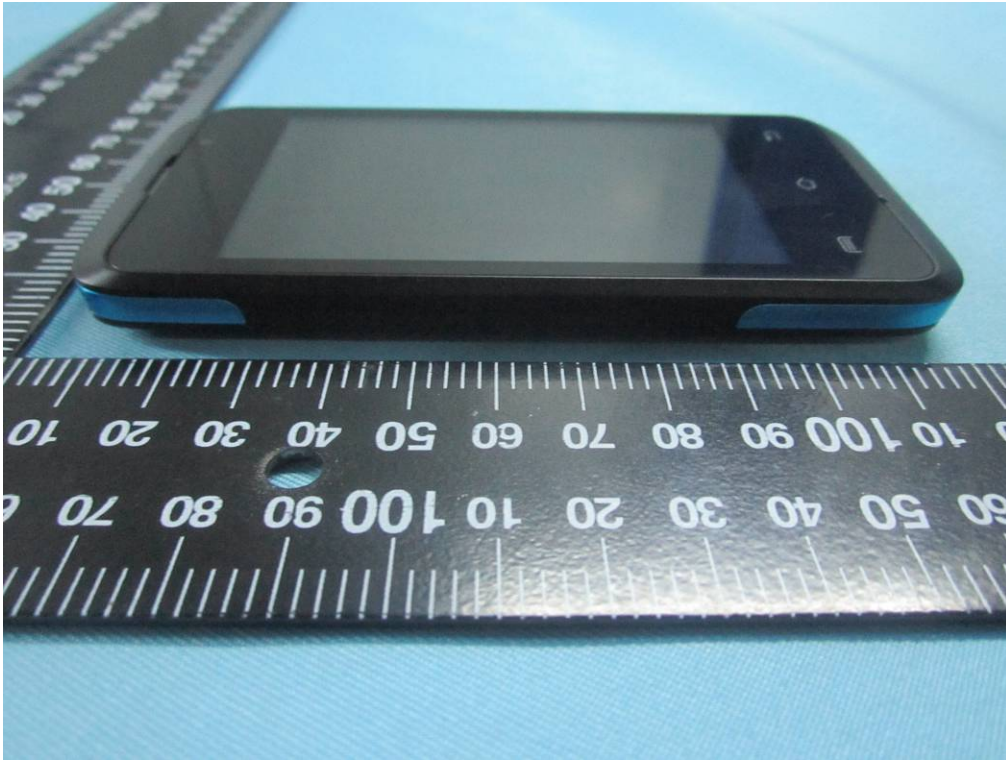

EUT - Left View



EUT - Right View

Annex B.ii. Photograph 2: EUT Internal Photo



Cover Off - Top View 1



Cover Off - Top View 2

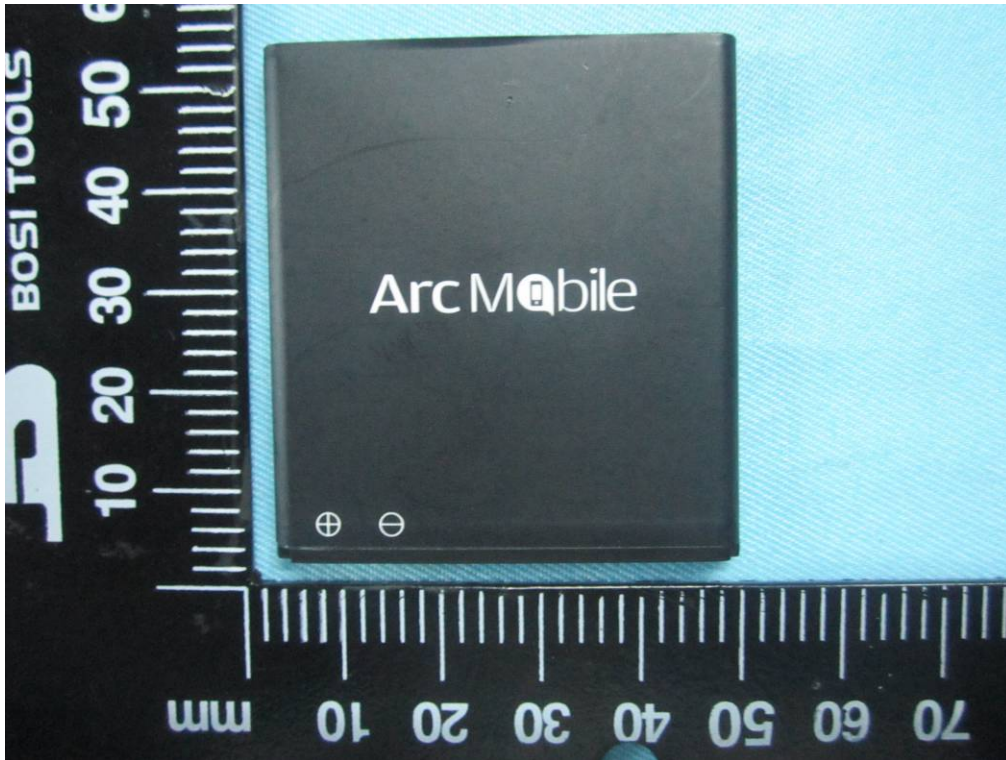

Battery - Top View



Battery - Bottom View

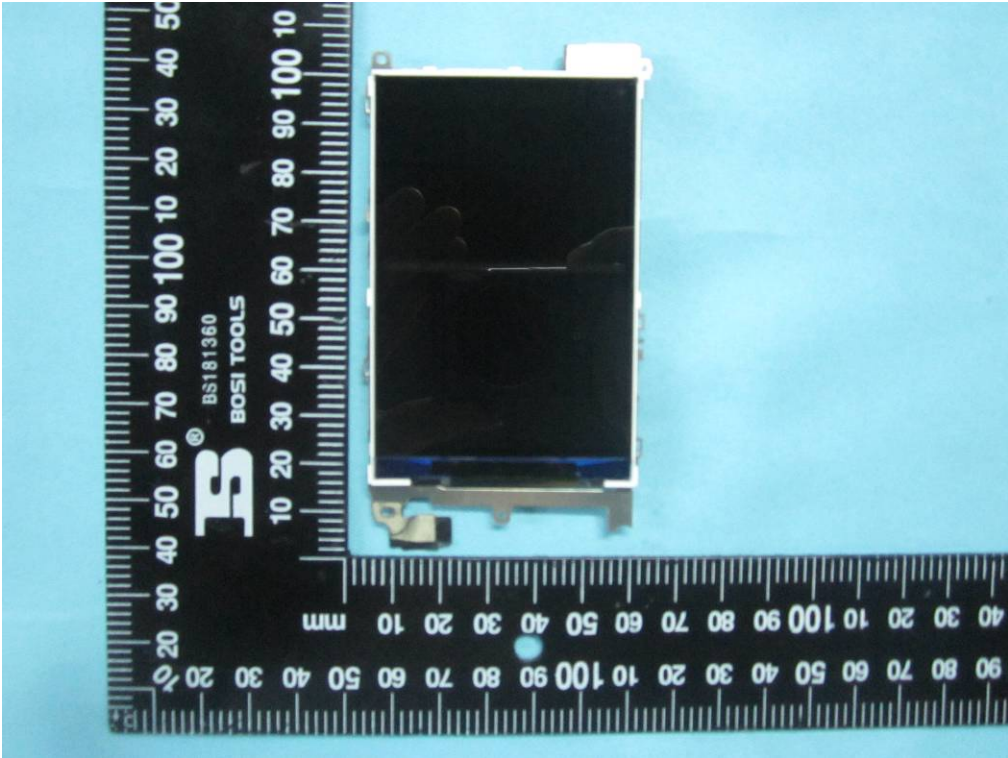

LCD – Front View

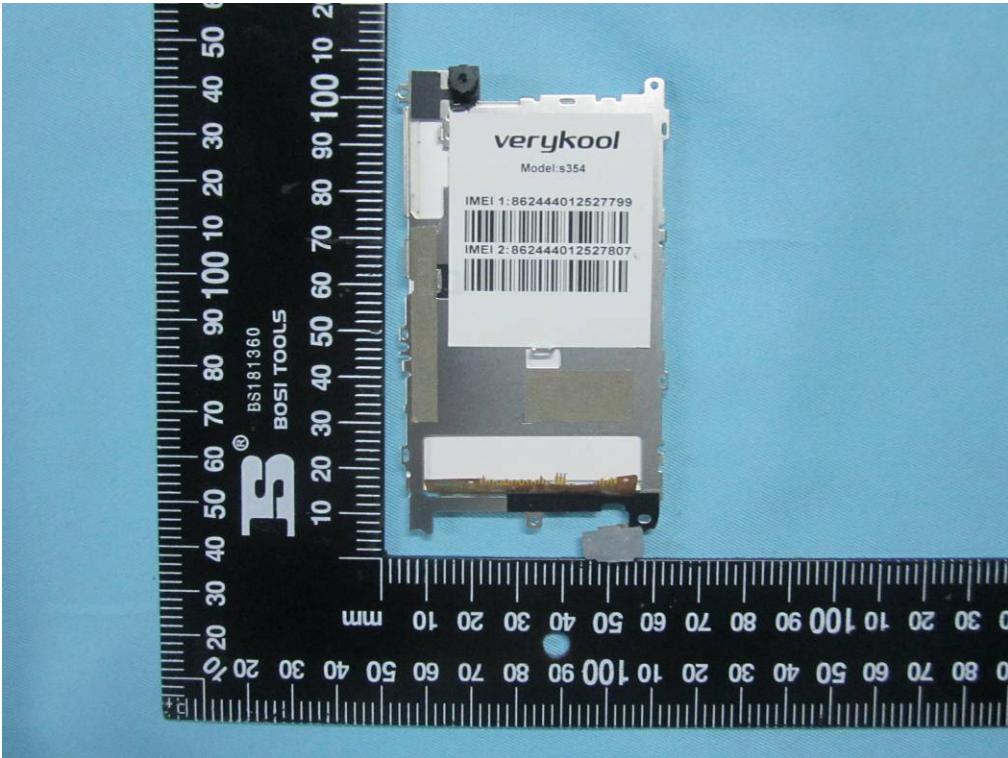

LCD – Rear View

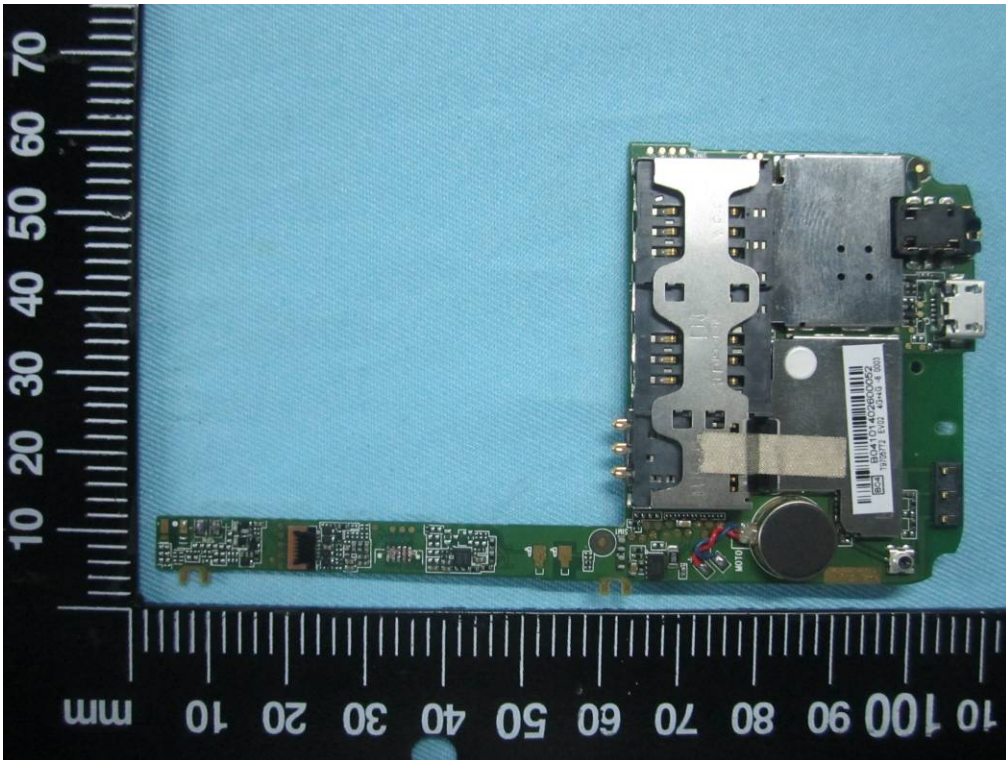

Mainboard With Shielding - Front View

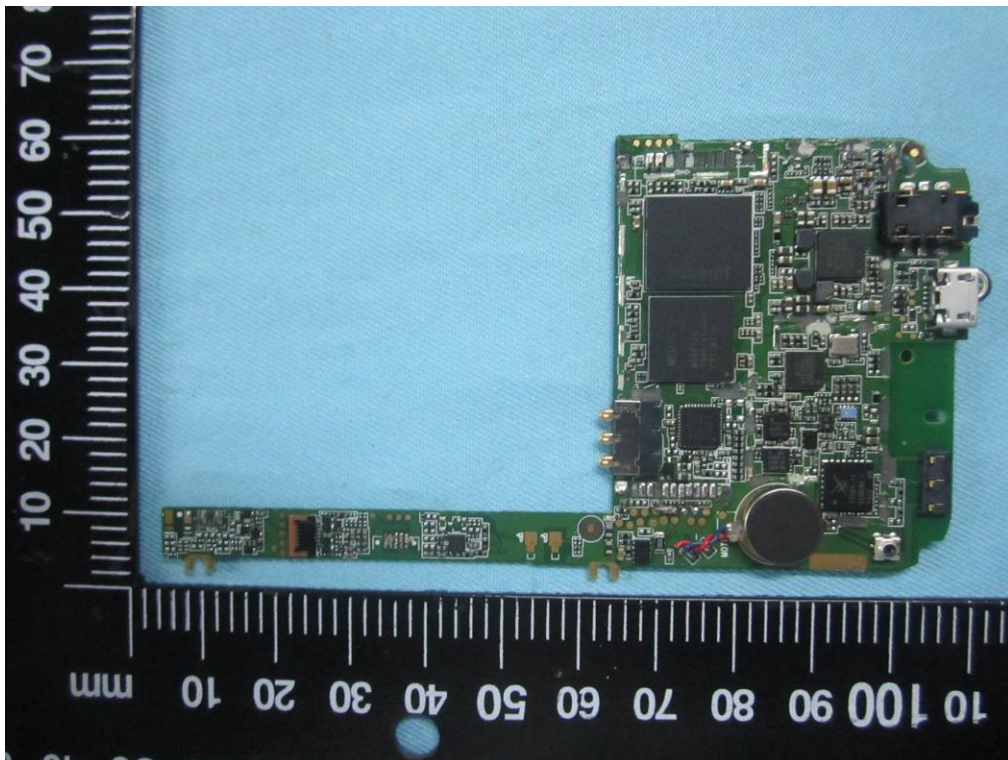

Mainboard Without Shielding - Front View

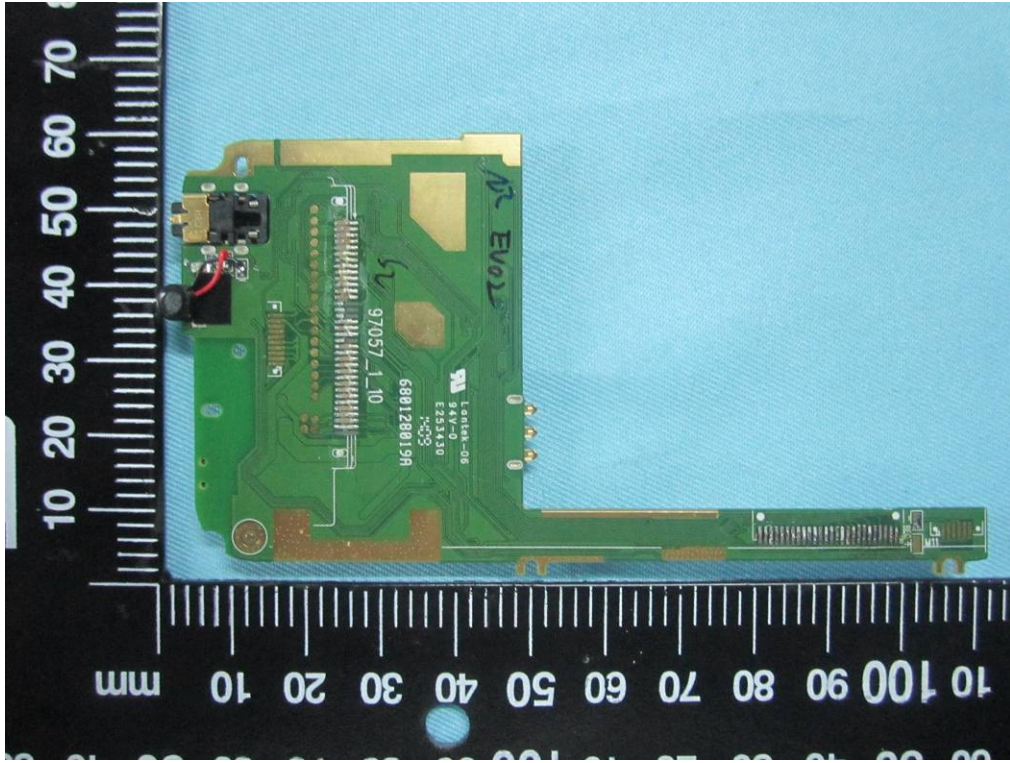

Mainboard – Rear View

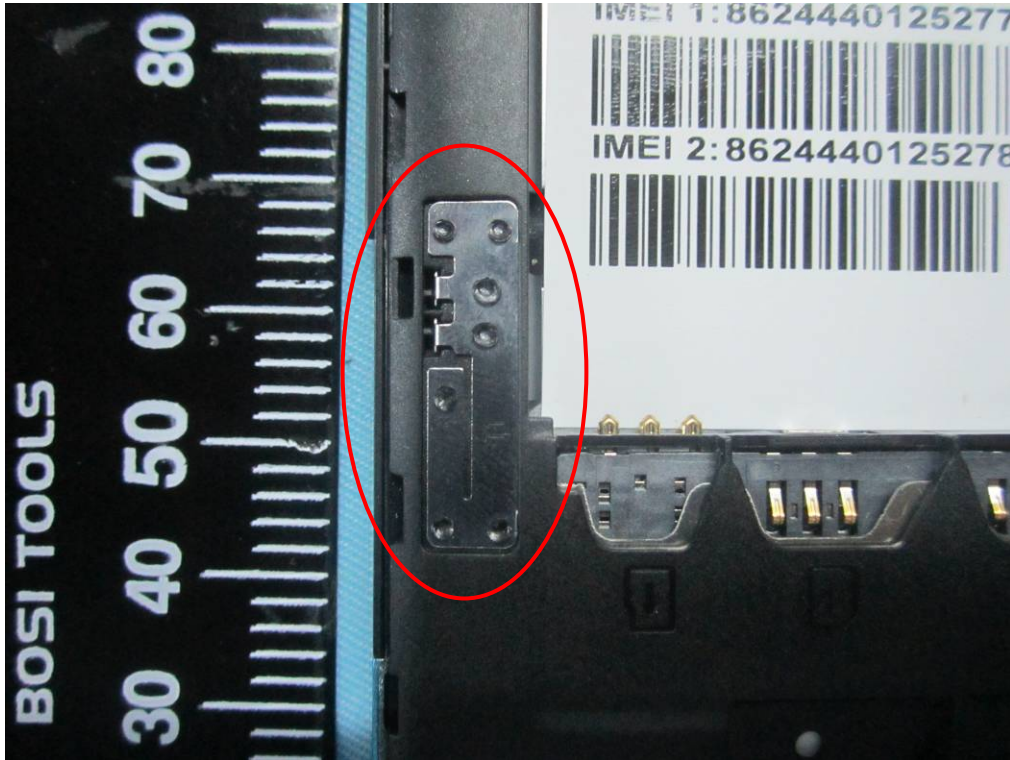

BT/BLE/WIFI Antenna View

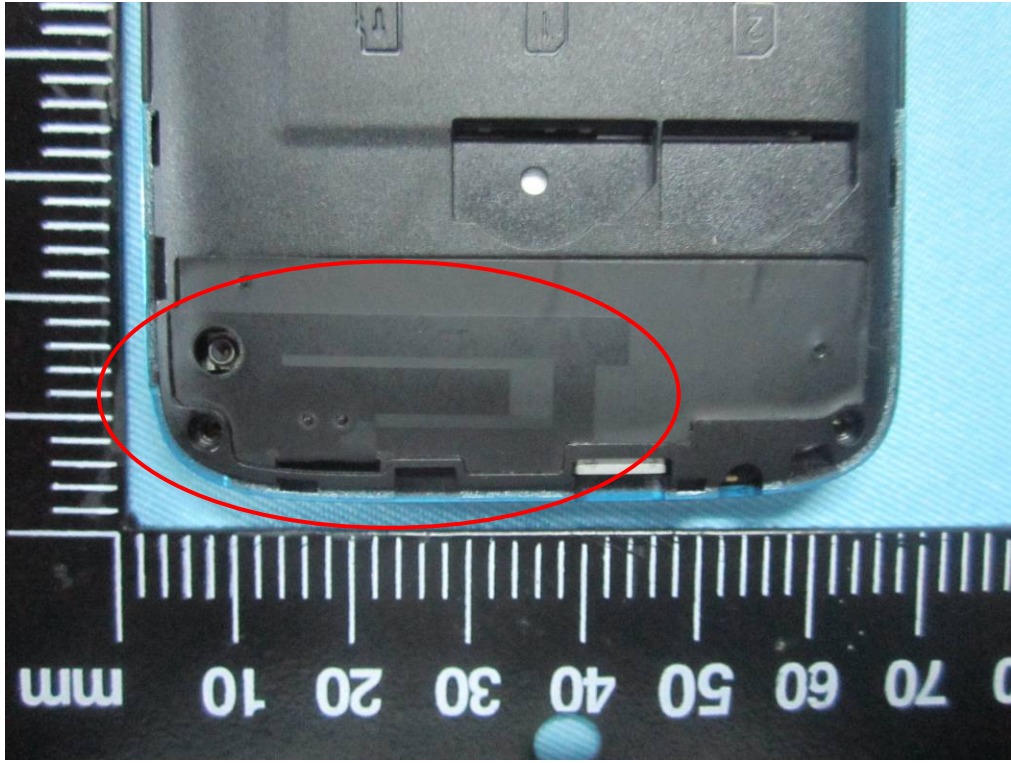

GSM/PCS/UMTS-FDD Antenna View

Annex B.iii. Photograph 3: Test Setup Photo



Conducted Emissions Test Setup Front View



Conducted Emissions Test Setup Side View

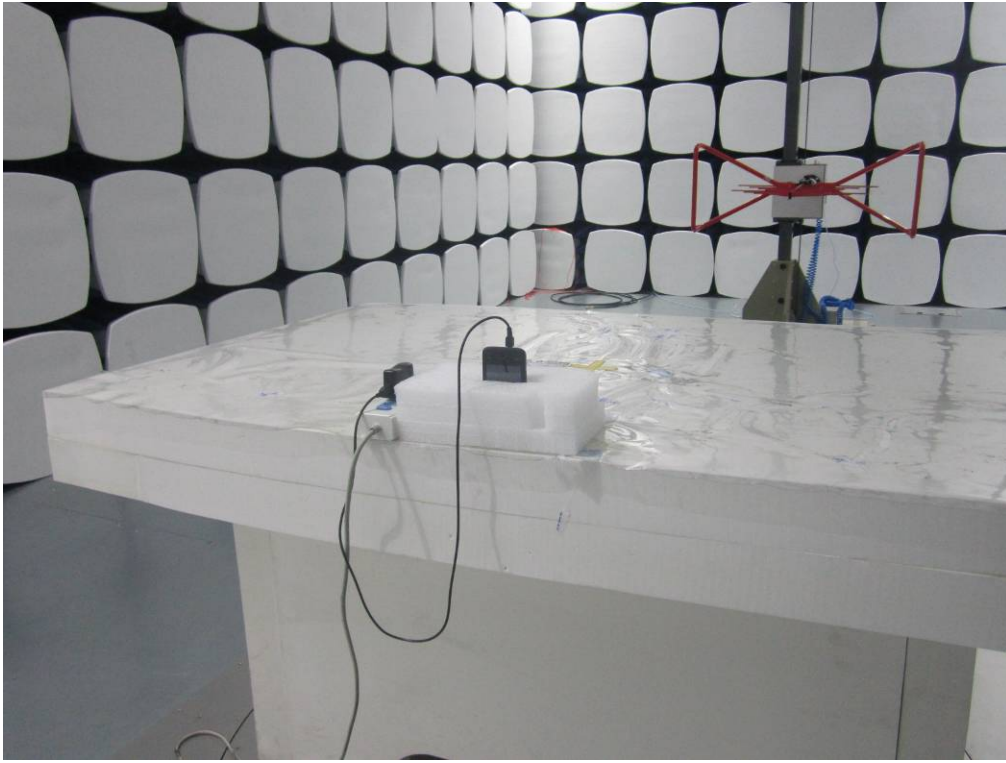

Radiated Spurious Emissions Test Setup Below 1GHz - Front View

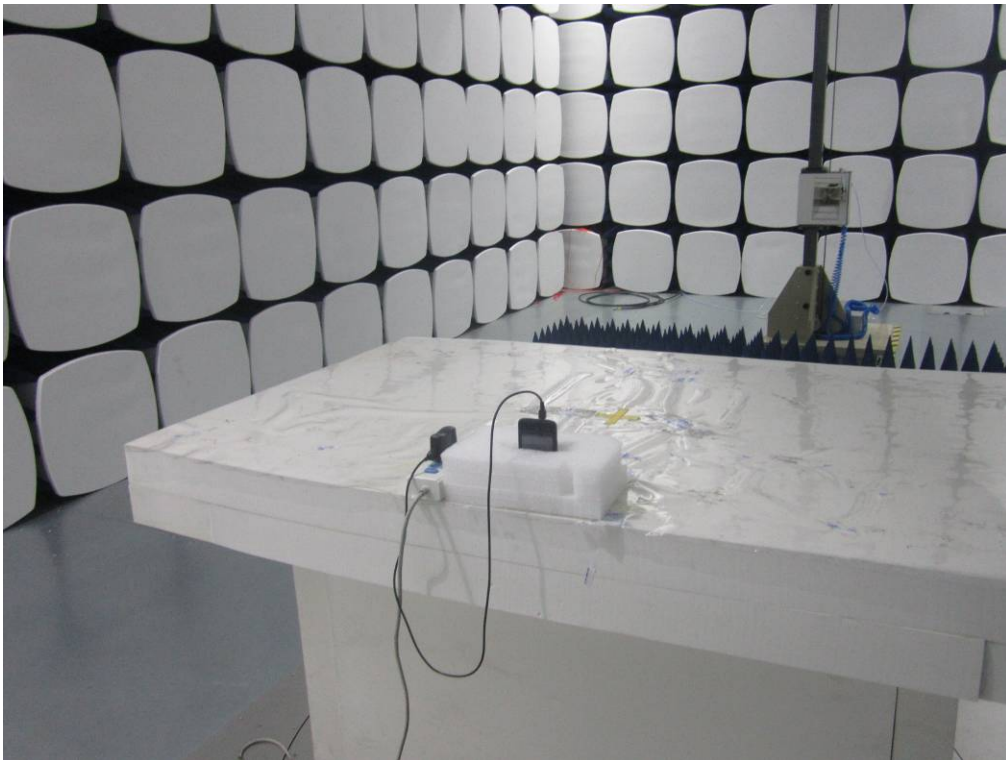

Radiated Spurious Emissions Test Setup Above 1GHz - Front View

Annex C. TEST SETUP AND SUPPORTING EQUIPMENT

EUT TEST CONDITIONS

Annex C. i. SUPPORTING EQUIPMENT DESCRIPTION

The following is a description of supporting equipment and details of cables used with the EUT.

Manufacturer	Equipment Description (Including Brand Name)	Model	Calibration Date	Calibration Due Date
N/A	N/A	N/A	N/A	N/A

Block Configuration Diagram for AC Line Conducted Emissions

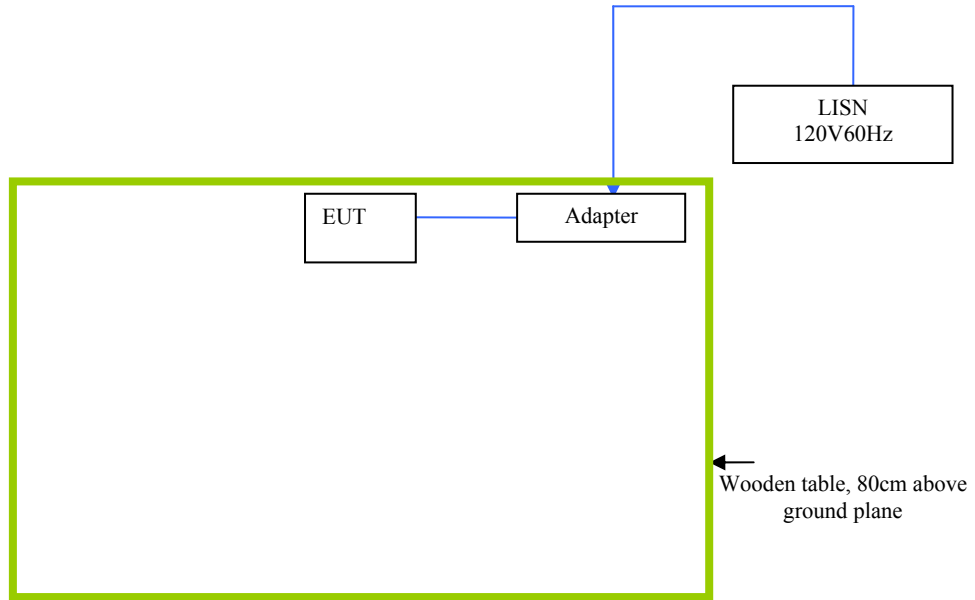



SIEMIC, INC.

Accessing global markets

Title: RF Test Report for Mobile Phone
Main Model: s354
Serial Model: N/A
To: FCC Part 15.247: 2013, ANSI C63.4: 2009

Report No.: 14070196-FCC-R3
Issue Date: May 09, 2014
Page: 74 of 77
www.siemic.com
www.siemic.com.cn

Block Configuration Diagram for Radiated Emissions

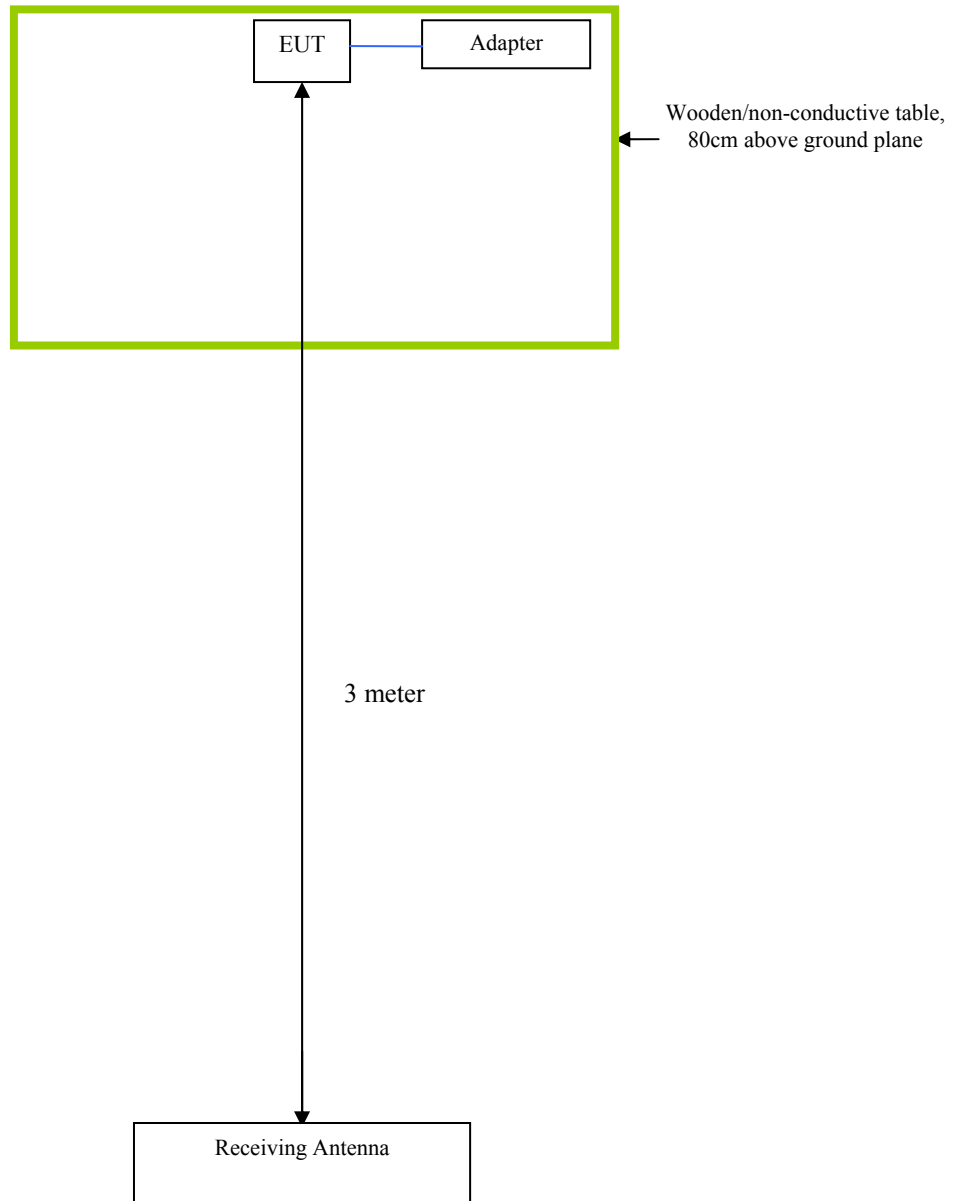

Annex C.ii. EUT OPERATING CONDITIONS

The following is the description of how the EUT is exercised during testing.

Test	Description Of Operation
Emissions Testing	The EUT was continuously transmitting to stimulate the worst case.



SIEMIC, INC.

Accessing global markets

Title: RF Test Report for Mobile Phone
Main Model: s354
Serial Model: N/A
To: FCC Part 15.247: 2013, ANSI C63.4: 2009

Report No.: 14070196-FCC-R3
Issue Date: May 09, 2014
Page: 76 of 77
www.siemic.com
www.siemic.com.cn

Annex D. USER MANUAL / BLOCK DIAGRAM / SCHEMATICS / PART LIST

Please see attachment



SIEMIC, Inc.

Accessing global markets

Title: RF Test Report for Mobile Phone
Main Model: s354
Serial Model: N/A
To: FCC Part 15.247: 2013, ANSI C63.4: 2009

Report No.: 14070196-FCC-R3
Issue Date: May 09, 2014
Page: 77 of 77
www.siemic.com
www.siemic.com.cn

Annex E. DECLARATION OF SIMILARITY

N/A