

Verykool USA Inc

GSM/GPRS Tri-band Mobile Phone

Model: R700

21 November, 2011

Report No.: 11070093-FCC-RF-BT

(This report supersedes NONE)



Modifications made to the product : None

This Test Report is Issued Under the Authority of:

Back Huang
Compliance Engineer

Alex Liu
Technical Manager

This test report may be reproduced in full only.
All Test Data Presented in this report is only applicable to presented Test sample.

RF Test Report

TO: FCC Part 15.247: 2011

SIEMIC, INC.
Accessing global markets



Laboratory Introduction

SIEMIC, headquartered in the heart of Silicon Valley, with superior facilities in US and Asia, is one of the leading independent testing and certification facilities providing customers with one-stop shop services for Compliance Testing and Global Certifications.



In addition to [testing](#) and [certification](#), SIEMIC provides initial design reviews and [compliance management](#) through out a project. Our extensive experience with [China](#), [Asia Pacific](#), [North America](#), [European](#), and [international](#) compliance requirements, assures the fastest, most cost effective way to attain regulatory compliance for the [global markets](#).

Accreditations for Conformity Assessment

Country/Region	Accreditation Body	Scope
USA	FCC, A2LA	EMC , RF/Wireless , Telecom
Canada	IC, A2LA, NIST	EMC, RF/Wireless , Telecom
Taiwan	BSMI , NCC , NIST	EMC, RF, Telecom , Safety
Hong Kong	OFTA , NIST	RF/Wireless , Telecom
Australia	NATA, NIST	EMC, RF, Telecom , Safety
Korea	KCC/RRA, NIST	EMI, EMS, RF , Telecom, Safety
Japan	VCCI, JATE, TELEC, RFT	EMI, RF/Wireless, Telecom
Mexico	NOM, COFETEL, Caniety	Safety, EMC , RF/Wireless, Telecom
Europe	A2LA, NIST	EMC, RF, Telecom , Safety

Accreditations for Product Certifications

Country	Accreditation Body	Scope
USA	FCC TCB, NIST	EMC , RF , Telecom
Canada	IC FCB , NIST	EMC , RF , Telecom
Singapore	iDA, NIST	EMC , RF , Telecom
EU	NB	EMC & R&TTE Directive



SIEMIC, INC.

Accessing global markets

Title: RF Test Report for GSM/GPRS Tri-band Mobile Phone
Model: R700
To: FCC 15.247:2011

Serial#: 11070093-FCC-RF-BT
Issue Date: 3 November, 2011
Page: 3 of 53
www.siemac.com.cn

This page has been left blank intentionally.

CONTENTS

1 EXECUTIVE SUMMARY & EUT INFORMATION 5

2 TECHNICAL DETAILS 6

3 MODIFICATION..... 7

4 TEST SUMMARY..... 8

5 MEASUREMENTS, EXAMINATION AND DERIVED RESULTS..... 9

ANNEX A. TEST INSTRUMENT & METHOD..... 40

ANNEX B. EUT AND TEST SETUP PHOTOGRAPHS 46

ANNEX C. TEST SETUP AND SUPPORTING EQUIPMENT..... 47

ANNEX D. USER MANUAL / BLOCK DIAGRAM / SCHEMATICS / PART LIST 51

ANNEX E. SIEMIC ACCREDITATION CERTIFICATES..... 52



1 Executive Summary & EUT information

The purpose of this test programme was to demonstrate compliance of the Verykool USA Inc and model: R700 against the current Stipulated Standards. The GSM/GPRS Tri-band Mobile Phone has demonstrated compliance with the FCC 15.247:2011.

EUT Information

EUT Description : GSM/GPRS Tri-band Mobile Phone

Model No : R700

Serial No : N/A

Input Power : Powered by Power Adapter:
Trade Name :Power Supply
Model No.:A361-0500600U
Input: 100-240V-50/60Hz, 0.2A
Output: 5.0V-600mA

Li-ion Battery:
Trade Name :verykool
Model:454461AR
Spec:3.7V 1400mAh(5.18Wh)
Limited charger voltage:4.2V

Classification Per Stipulated Test Standard : FCC 15.247:2011



2 TECHNICAL DETAILS

Purpose	Compliance testing of GSM/GPRS Tri-band Mobile Phone model R700 with stipulated standard
Applicant / Client	Verykool USA Inc 4350 Executive Dr.#100,San Diego Postal Code: CA92121
Manufacturer	Verykool Wireless Technology Ltd Room 1701, Reward Building C, No.203, 2nd Section of WangJing, Li Ze Zhong Yuan, ChaoYang District, Beijing, P.R. of China 100102
Laboratory performing the tests	SIEMIC Nanjing (China) Laboratories NO.2-1,Longcang Dadao, Yuhua Economic Development Zone, Nanjing, China Tel:+86(25)86730128/86730129 Fax:+86(25)86730127 Email:info@siemic.com
Test report reference number	11070093-FCC-RF-BT
Date EUT received	3 November, 2011
Standard applied	FCC 15.247:2011
Dates of test (from – to)	4 November,2011~20 November,2011
No of Units :	#1
Equipment Category :	Spread Spectrum System/Device
Trade Name :	Verykool
Model :	R700
RF OPERATING FREQUENCY (IES)	GSM850 TX : 824.2 ~ 848.8 MHz RX :869.2 ~ 893.8 MHz PCS1900 TX : 1850.2 ~ 1909.8 MHz RX :1930.2 ~ 1989.8 MHz UMTS Band V TX : 826.4 ~ 846.6 MHz RX :871.4 ~ 891.6 MHz BT: 2402MHz-2480MHz WIFI:2.4GHz band: 802.11b/g: 2412MHz-2462MHz
NUMBER OF CHANNELS :	300 (PCS1900) and 125 (GSM850) BT: 79CH WIFI:2.4GHz band: 802.11b/g-20MHz 11CH
MODULATION :	GSM / GPRS/ EGPRS : GMSK, 8PSK WCDMA:QPSK BT: GFSK WIFI:DSSS
FCC ID :	WA6R700



SIEMIC, Inc.

Accessing global markets

Title: RF Test Report for GSM/GPRS Tri-band Mobile Phone
Model: R700
To: FCC 15.247:2011

Serial#: 11070093-FCC-RF-BT
Issue Date: 3 November, 2011
Page: 7 of 53
www.siemic.com.cn

3 MODIFICATION

NONE

4 TEST SUMMARY

The product was tested in accordance with the following specifications.
All testing has been performed according to below product classification:

Spread Spectrum System/Device Test Results Summary

FCC Rules	Description of Test	Result
§15.247 (i), §2.1093	RF Exposure	Compliance
§15.203	Antenna Requirement	Compliance
§15.207 (a)	Conducted Emissions	Compliance
§15.205, §15.209, §15.247(d)	Radiated Emissions	Compliance
§15.247 (a)(1)	20 dB Bandwidth	Compliance
§15.247(a)(1)	Channel Separation Test	Compliance
§15.247(a)(1)(iii)	Time of Occupancy (Dwell Time)	Compliance
§15.247(a)(1)(iii)	Quantity of hopping channel Test	Compliance
§15.247(b)(1)	Peak Output Power Measurement	Compliance
§15.247(d)	Band Edges	Compliance

5 MEASUREMENTS, EXAMINATION AND DERIVED RESULTS

5.1 §15.247 (i) and §2.1093 – RF Exposure

Applicable Standard

According to §15.247 (i) and §1.1307(b)(1), systems operating under the provisions of this section shall be operated in a manner that ensures that the public is not exposed to radio frequency energy level in excess of the Commission’s guidelines.

Table 2 – Summary of SAR Evaluation Requirements for a Cell Phone with Multiple Transmitters

	Individual Transmitter	Simultaneous Transmission
Licensed Transmitters	<u>Routine evaluation required</u>	SAR not required: <u>Unlicensed only</u>
Unlicensed Transmitters	<p>When there is no simultaneous transmission –</p> <ul style="list-style-type: none"> ○ output ≤ 60/f: SAR not required ○ output > 60/f: stand-alone SAR required <p>When there is simultaneous transmission – <u>Stand-alone SAR not required when</u></p> <ul style="list-style-type: none"> ○ output ≤ 2·P_{Ref} and antenna is ≥ 5.0 cm from other antennas ○ output ≤ P_{Ref} and antenna is ≥ 2.5 cm from other antennas ○ output ≤ P_{Ref} and antenna is < 2.5 cm from other antennas, each with either output power ≤ P_{Ref} or 1-g SAR < 1.2 W/kg <p><u>Otherwise stand-alone SAR is required</u></p> <p>When stand-alone SAR is required</p> <ul style="list-style-type: none"> ○ test SAR on highest output channel for each wireless mode and exposure condition ○ if SAR for highest output channel is > 50% of SAR limit, evaluate all channels according to normal procedures 	<ul style="list-style-type: none"> ○ when stand-alone 1-g SAR is not required and antenna is ≥ 5 cm from other antennas <p><u>Licensed & Unlicensed</u></p> <ul style="list-style-type: none"> ○ when the sum of the 1-g SAR is < 1.6 W/kg for all simultaneous transmitting antennas ○ when SAR to peak location separation ratio of simultaneous transmitting antenna pair is < 0.3 <p>SAR required: <u>Licensed & Unlicensed</u></p> <p>antenna pairs with SAR to peak location separation ratio ≥ 0.3; test is only required for the configuration that results in the highest SAR in stand-alone configuration for each wireless mode and exposure condition</p> <p>Note: simultaneous transmission exposure conditions for head and body can be different for different style phones; therefore, different test requirements may apply</p>
Jaw, Mouth and Nose	<u>Flat phantom SAR required</u>	
	<ul style="list-style-type: none"> ○ when measurement is required in tight regions of SAM and it is not feasible or the results can be questionable due to probe tilt, calibration, positioning and orientation issues ○ position rectangular and clam-shell phones according to flat phantom procedures and conduct SAR measurements for these specific locations 	When simultaneous transmission SAR testing is required, contact the FCC Laboratory for interim guidance.

Routine SAR evaluation refers to that specifically required by § 2.1093, using measurements or computer simulation. When routine SAR evaluation is not required, portable transmitters with output power greater than the applicable low threshold require SAR evaluation to qualify for TCB approval.

Three antennas are available for the EUT, (GSM antenna, WiFi/Bluetooth antenna, GPS antenna), The distance between WiFi/BT antenna and WWAN antenna is 8.5cm which is More than 5 cm, and the Max output power of WiFi is 19.18 mW $< 2 * P_{pref}$ (24 mW), Max output power of BT is 2.238mW. So no stand-alone SAR is required for WiFi and BT antenna. According to KDB 648474, no simultaneous SAR measurement is required too.

Note: The WiFi and BT use the same antenna.

Result:

The SAR measurement is exempt.

5.2 §15.203 - ANTENNA REQUIREMENT

Applicable Standard

According to § 15.203, an intentional radiator shall be designed to ensure that no antenna other than that furnished by the responsible party shall be used with the device. The use of a permanently attached antenna or of an antenna that uses a unique coupling to the intentional radiator shall be considered sufficient to comply with the provisions of this section. The manufacturer may design the unit so that a broken antenna can be replaced by the user, but the user of a standard antenna jack or electrical connector is prohibited. The structure and application of the EUT were analyzed to determine compliance with section §15.203 of the rules. §15.203 state that the subject device must meet the following criteria:

- a. Antenna must be permanently attached to the unit.
- b. Antenna must use a unique type of connector to attach to the EUT.

Unit must be professionally installed, and installer shall be responsible for verifying that the correct antenna is employed with the unit.

And according to FCC 47 CFR section 15.247 (b), if the transmitting antennas of directional gain greater than 6dBi are used, the power shall be reduced by the amount in dB that the directional gain of the antenna exceeds 6 dBi.

Antenna Connector Construction

The EUT has 3 antennas, one is a PIFA antenna for Bluetooth/WIFI, the gain is 1.0 dBi; one is a PIFA antenna for GSM, the gain are -0.5 dBi for GSM and 2.8dBi for PCS, other is a PIFA antenna for GPS, the gain is 1.5 dBi which in accordance to section 15.203, please refer to the internal photos.

Result: Compliant.

5.3 §15.207 (a) - CONDUCTED EMISSIONS

Requirement:

Frequency of emission (MHz)	Conducted limit (dBµV)	
	Quasi-peak	Average
0.15–0.5	66 to 56*	56 to 46*
0.5–5	56	46
5–30	60	50

*Decreases with the logarithm of the frequency.

Procedures:

1. All possible modes of operation were investigated. Only the 6 worst case emissions measured, using the correct CISPR and Average detectors, are reported. All other emissions were relatively insignificant.
2. A "-ve" margin indicates a PASS as it refers to the margin present below the limit line at the particular frequency.
3. Conducted Emissions Measurement Uncertainty
All test measurements carried out are traceable to national standards. The uncertainty of the measurement at a confidence level of approximately 95% (in the case where distributions are normal), with a coverage factor of 2, in the range 9kHz – 30MHz (Average & Quasi-peak) is ±3.5dB.
4. Environmental Conditions

Temperature	22°C
Relative Humidity	50%
Atmospheric Pressure	1019mbar
5. Test date :19 November, 2011
Tested By : Back Huang

Test mode:GFSK Transmitting

Peak Detector  **Quasi Peak Limit** 
Average Detector  **Average Limit** 

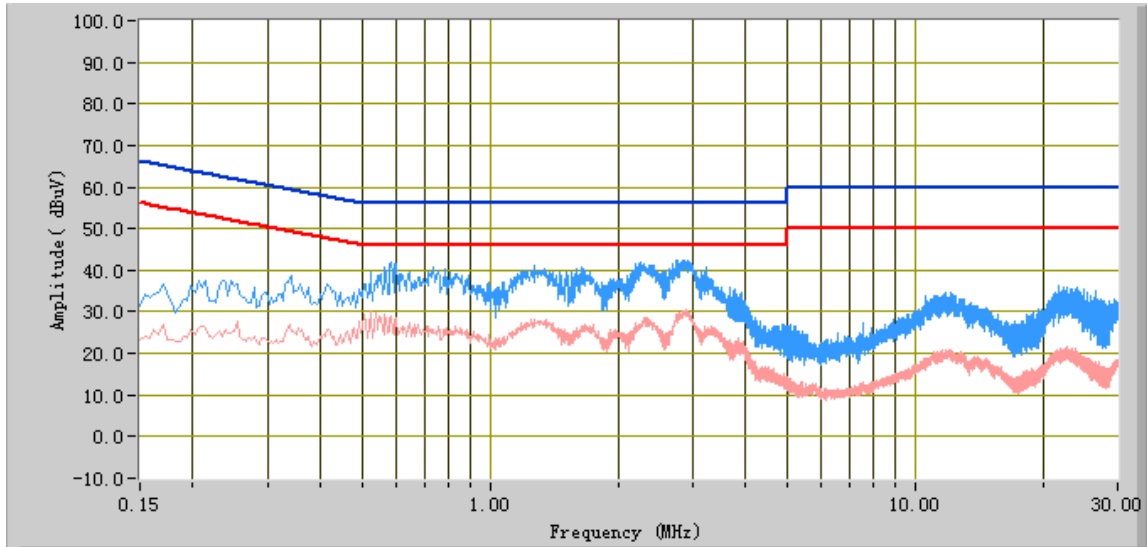

Test Data

Line

Frequency (MHz)	Quasi Peak (dBuV)	Limit (dBuV)	Margin (dB)	Average (dBuV)	Limit (dBuV)	Margin (dB)	Factors (dB)
2.750	40.462	56.000	-15.538	29.174	46.000	-16.826	10.200
2.874	40.417	56.000	-15.583	29.465	46.000	-16.535	10.200
2.262	39.914	56.000	-16.086	27.071	46.000	-18.929	10.200
2.958	39.886	56.000	-16.114	29.833	46.000	-16.167	10.200
2.730	39.875	56.000	-16.125	28.531	46.000	-17.469	10.200
0.586	39.819	56.000	-16.181	29.116	46.000	-16.884	10.151

Peak Detector  **Quasi Peak Limit** 
Average Detector  **Average Limit** 

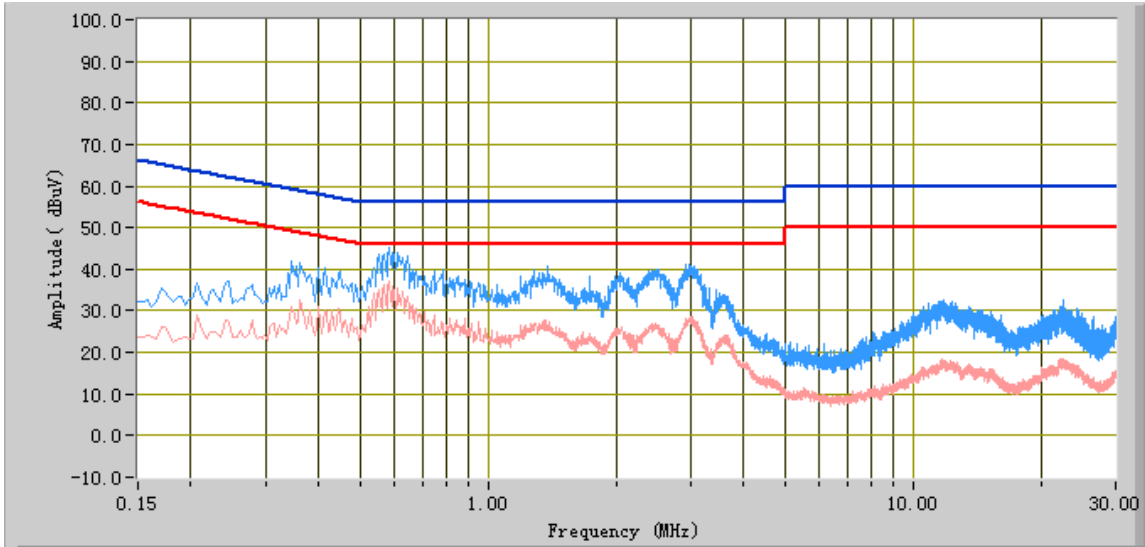

Test Data

Neutral

Frequency (MHz)	Quasi Peak (dBuV)	Limit (dBuV)	Margin (dB)	Average (dBuV)	Limit (dBuV)	Margin (dB)	Factors (dB)
0.586	43.134	56.000	-12.866	36.985	46.000	-9.015	10.151
0.646	41.119	56.000	-14.881	33.586	46.000	-12.414	10.135
2.966	39.280	56.000	-16.72	27.557	46.000	-18.443	10.200
2.922	39.242	56.000	-16.758	26.476	46.000	-19.524	10.200
1.386	38.622	56.000	-17.378	26.614	46.000	-19.386	10.175
3.050	38.548	56.000	-17.452	27.856	46.000	-18.144	10.215

5.4 §15.209, §15.205 & §15.247(d) - Spurious Emissions

1. All possible modes of operation were investigated. Only the 6 worst case emissions measured, using the correct CISPR detectors, are reported. All other emissions were relatively insignificant.
2. A "-ve" margin indicates a PASS as it refers to the margin present below the limit line at the particular frequency.
3. Radiated Emissions Measurement Uncertainty
All test measurements carried out are traceable to national standards. The uncertainty of the measurement at a confidence level of approximately 95% (in the case where distributions are normal), with a coverage factor of 2, in the range 30MHz – 1GHz & 1GHz above (3m & 10m) is +5.6/-4.5dB.
4. Environmental Conditions



Temperature	22°C
Relative Humidity	50%
Atmospheric Pressure	1019mbar
5. Test date : 19 November, 2011
Tested By : Back Huang

Standard Requirement: The emissions from the Low-power radio-frequency devices shall not exceed the field strength levels specified in the following table and the level of any unwanted emissions shall not exceed the level of the fundamental emission. The tighter limit applies at the band edges.

Test Result: Pass

30-1000 MHz:

Test Mode: GFSK Transmitting

Peak Detector 
Quasi Peak Limit 

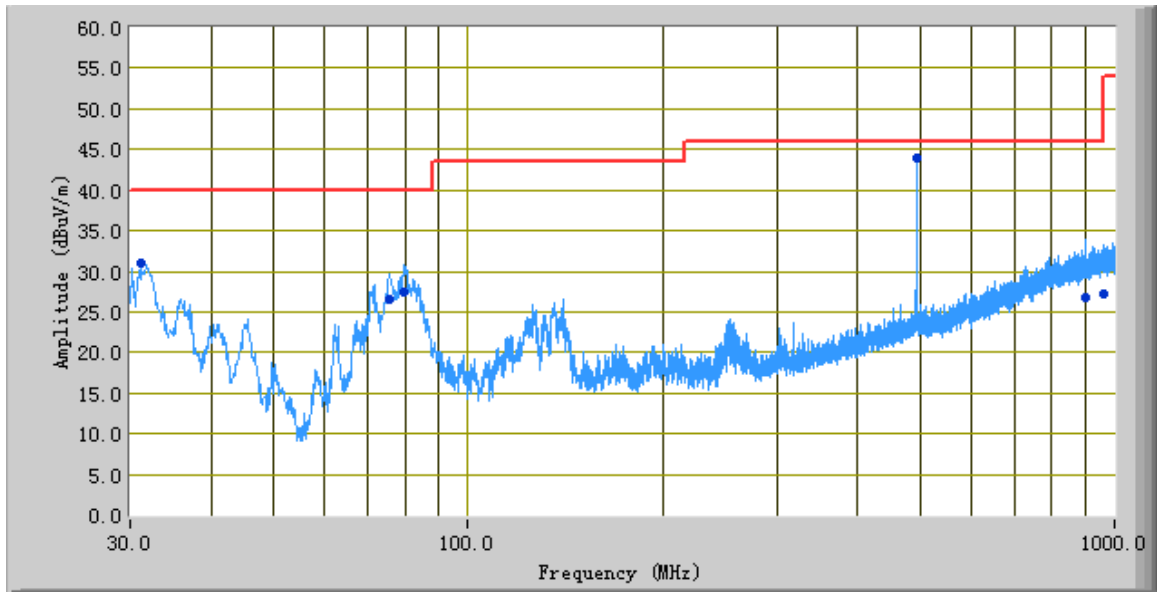

Test Data

Frequency (MHz)	Quasi Peak (dBuV/m)	Azimuth	Polarity(H/V)	Height (cm)	Factors (dB)	Limit (dBuV/m)	Margin (dB)
494.00	43.87	192.00	H	170.00	-25.93	46.00	-2.13
31.23	30.90	224.00	V	105.00	-24.75	40.00	-9.10
79.81	27.52	154.00	V	137.00	-37.63	40.00	-12.48
75.57	26.44	69.00	V	188.00	-38.09	40.00	-13.56
900.36	26.67	144.00	H	198.00	-15.13	46.00	-19.33
959.73	27.22	0.00	H	198.00	-15.24	46.00	-18.78

Note: The data which below 20 dB to the limit was not recorded.

Above 1 GHz:

Test mode:GFSK Transmitting

Note: Other Bluetooth modes were verified, only the result of worst case basic rate mode was presented.

Low Channel (2402 MHz)

Frequency (MHz)	Substituted level (dBm)	Detector (PK/AV)	Direction (degree)	Height (m)	Polarity (H/V)	Ant. Factor (dB/m)	Cable Loss (dB)	Pre-Amp. Gain (dB)	Cord. Amp. (dBμV/m)	Limit (dBm)	Margin (dB)
4804	40.49	AV	150	1.2	V	34	2.6	26.79	50.3	54	-3.70
4804	39.54	AV	160	1.2	H	33.8	2.6	26.79	49.15	54	-4.85
4804	55.36	PK	150	1.2	V	34	2.6	26.79	65.17	74	-8.83
4804	54.88	PK	160	1.2	H	33.8	2.6	26.79	64.49	74	-9.51
1112.92	35.63	AV	140	1.4	V	25.3	1.1	26.51	35.52	54	-18.48
1112.92	34.88	AV	150	1.4	H	23.8	1.1	26.51	33.27	54	-20.73
1112.92	46.92	PK	140	1.4	V	23.8	1.1	26.51	45.31	74	-28.69
1112.92	48.07	PK	150	1.4	H	25.3	1.1	26.51	47.96	74	-26.04

Middle Channel (2441 MHz)

Frequency (MHz)	Substituted level (dBm)	Detector (PK/AV)	Direction (degree)	Height (m)	Polarity (H/V)	Ant. Factor (dB/m)	Cable Loss (dB)	Pre-Amp. Gain (dB)	Cord. Amp. (dBμV/m)	Limit (dBm)	Margin (dB)
4882	38.23	AV	170	1.3	V	33.6	2.6	26.78	47.65	54	-6.35
4882	39.66	AV	150	1.3	H	33.8	2.6	26.78	49.28	54	-4.72
4882	52.36	PK	170	1.3	V	33.6	2.6	26.78	61.78	74	-12.22
4882	53.42	PK	150	1.3	H	33.8	2.6	26.78	63.04	74	-10.96
1397.52	33.56	AV	120	1.4	V	25.1	1.3	26.65	33.31	54	-20.69
1397.52	33.26	AV	140	1.2	H	25.1	1.3	26.65	33.01	54	-20.99
1397.52	43.58	PK	120	1.4	V	25.3	1.3	26.65	43.53	74	-30.47
1397.52	43.46	PK	140	1.2	H	25.3	1.3	26.65	43.41	74	-30.59

High Channel (2480 MHz)

Frequency (MHz)	Substituted level (dBm)	Detector (PK/AV)	Direction (degree)	Height (m)	Polarity (H/V)	Ant. Factor (dB/m)	Cable Loss (dB)	Pre-Amp. Gain (dB)	Cord. Amp. (dBμV/m)	Limit (dBm)	Margin (dB)
4960	37.39	AV	150	1.2	V	34.6	2.7	26.75	47.94	54	-6.06
4960	36.48	AV	120	1.3	H	34.7	2.7	26.75	47.13	54	-6.87
4960	54.56	PK	150	1.2	V	34.6	2.7	26.75	65.11	74	-8.89
4960	52.25	PK	120	1.3	H	34.7	2.7	26.75	62.9	74	-11.1
1413.16	32.23	AV	180	1.1	V	25.3	1.3	26.65	32.18	54	-21.82
1413.16	31.37	AV	180	1.2	H	25.5	1.3	26.65	31.52	54	-22.48
1413.16	43.66	PK	180	1.1	V	25.3	1.3	26.65	43.61	74	-30.39
1413.16	43.43	PK	180	1.2	H	25.5	1.3	26.65	43.58	74	-30.42

Spurious emission in restricted band:

Frequency (MHz)	Substituted level (dBm)	Detector (PK/AV)	Direction (degree)	Height (m)	Polarity (H/V)	Ant. Factor (dB/m)	Cable Loss (dB)	Pre-Amp. Gain (dB)	Cord. Amp. (dB μ V/m)	Limit (dBm)	Margin (dB)
2397.69	31.45	AV	80	1.2	V	30.1	1.8	26.83	36.52	54	-17.48
2484.87	31.82	AV	120	1.1	V	30.6	1.8	26.83	37.39	54	-16.61
2484.87	32.23	AV	60	1.3	H	30.6	1.8	26.83	37.80	54	-16.20
2397.69	32.19	AV	20	1.2	H	30.1	1.8	26.83	37.26	54	-16.74
2484.87	44.38	PK	10	1.1	V	30.6	1.8	26.83	49.95	74	-24.05
2397.69	43.18	PK	20	1.2	V	30.1	1.8	26.83	48.25	74	-25.75
2484.87	43.72	PK	30	1.3	H	30.6	1.8	26.83	49.29	74	-24.71
2397.69	44.67	PK	20	1.2	H	30.1	1.8	26.83	49.74	74	-24.26

5.5 §15.247(a) (1)-CHANNEL Separation Test

1. Conducted Measurement
EUT was set for low, mid, high channel with modulated mode and highest RF output power.
The spectrum analyzer was connected to the antenna terminal.
2. Environmental Conditions

Temperature	22°C
Relative Humidity	50%
Atmospheric Pressure	1019mbar
3. Conducted Emissions Measurement Uncertainty
All test measurements carried out are traceable to national standards. The uncertainty of the measurement at a confidence level of approximately 95% (in the case where distributions are normal), with a coverage factor of 2, in the range 30MHz – 40GHz is ±1.5dB.
4. Test date : 17 November, 2011
Tested By : Back Huang

Requirement(s): According to §15.247(a)(1), Frequency hopping systems shall have hopping channel carrier frequencies separated by a minimum of 25 kHz or the 20 dB bandwidth of the hopping channel, whichever is greater.

Procedures:

1. Place the EUT on the table and set it in hopping function transmitting mode.
2. Remove the antenna from the EUT and then connect a low loss RF cable from the antenna port to the spectrum analyzer.
3. Set center frequency of spectrum analyzer = middle of hopping channel.
4. Set the spectrum analyzer as Resolution (or IF) Bandwidth (RBW) ≥ 1% of the span, Video (or Average) Bandwidth (VBW) ≥ RBW, Sweep = auto, Detector function = peak, Trace = max hold.
5. Max hold, mark 2 peaks of hopping channel and record the 2 peaks frequency.

Test Mode: GFSK Transmitting

Channel	Channel Frequency (MHz)	Channel Separation (MHz)	Limit (kHz)	Result
Low Channel	2402	1.004	696.000	<u>PASS</u>
Adjacency Channel	2403			
Mid Channel	2441	1.004	696.000	<u>PASS</u>
Adjacency Channel	2442			
High Channel	2480	1.004	696.000	<u>PASS</u>
Adjacency Channel	2479			

Please refer to the following plots.

Low Channel

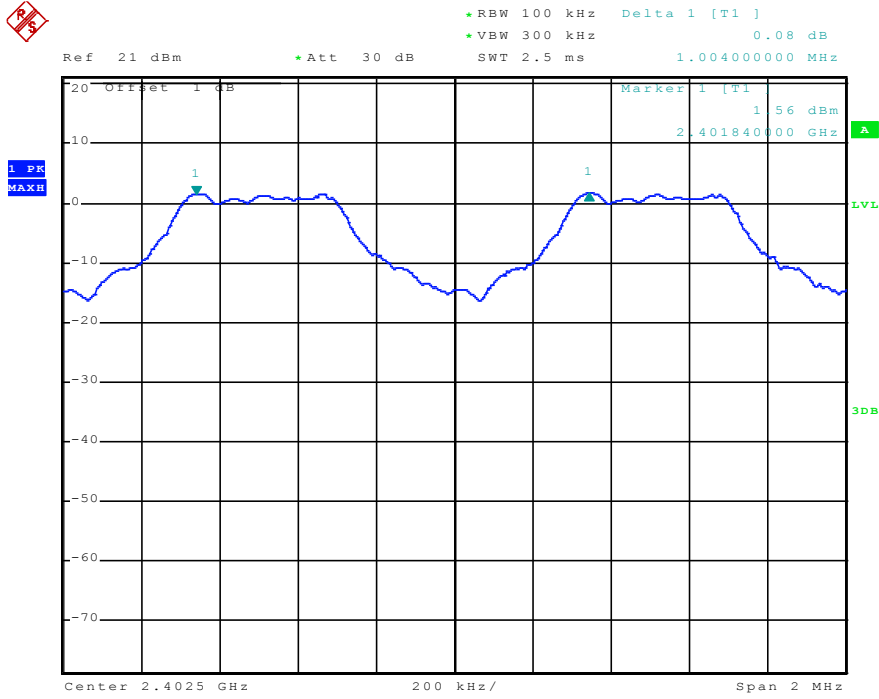

Date: 17.NOV.2011 00:27:49

Middle Channel

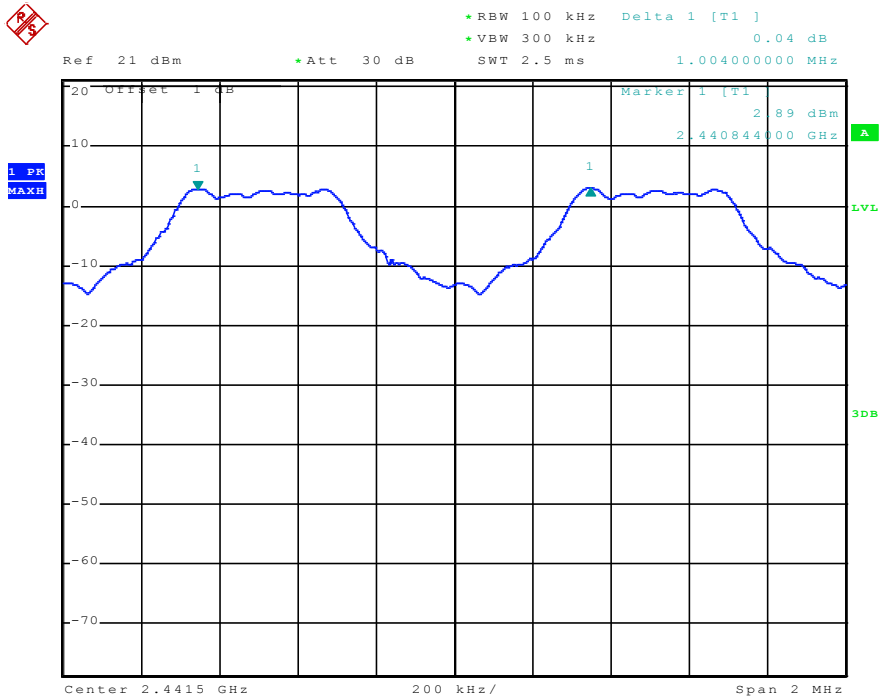

Date: 17.NOV.2011 00:30:29



SIEMIC, INC.

Accessing global markets

Title: RF Test Report for GSM/GPRS Tri-band Mobile Phone
Model: R700
To: FCC 15.247:2011

Serial#: 11070093-FCC-RF-BT
Issue Date: 3 November, 2011
Page: 21 of 53
www.siemec.com.cn

High Channel

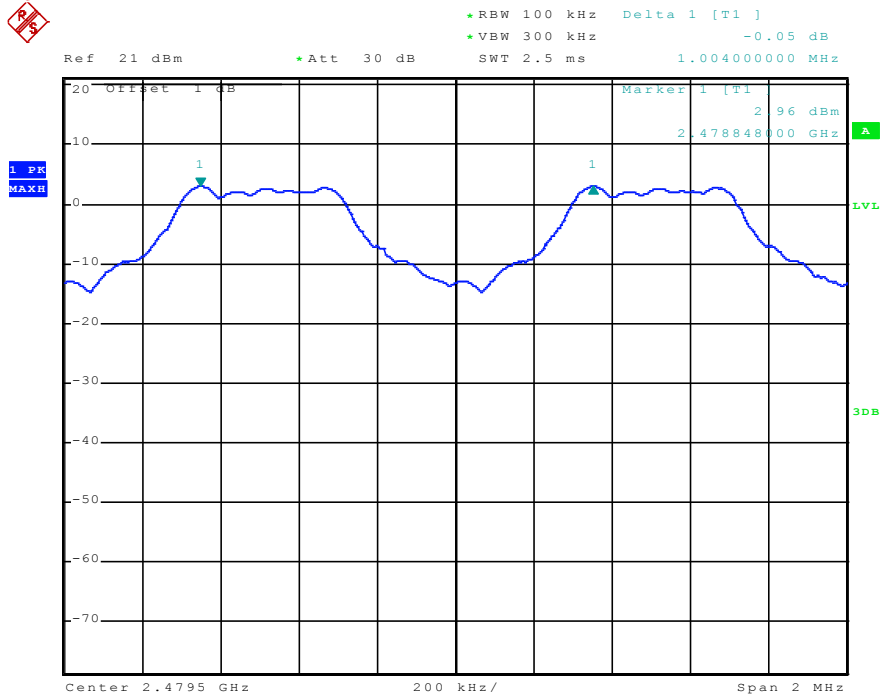

Date: 17.NOV.2011 00:32:54

§15.247(a) (1) – 20 dB BANDWIDTH TESTING

1. Conducted Measurement
EUT was set for low, mid, high channel with modulated mode and highest RF output power.
The spectrum analyzer was connected to the antenna terminal.
2. Environmental Conditions

Temperature	22°C
Relative Humidity	50%
Atmospheric Pressure	1019mbar
3. Conducted Emissions Measurement Uncertainty
All test measurements carried out are traceable to national standards. The uncertainty of the measurement at a confidence level of approximately 95% (in the case where distributions are normal), with a coverage factor of 2, in the range 30MHz – 40GHz is ± 1.5 dB.
4. Test date : 17 November, 2011
Tested By : Back Huang

Requirement(s): According to §15.247(a)(1), Frequency hopping systems shall have hopping channel carrier frequencies separated by a minimum of 25 kHz or the 20 dB bandwidth of the hopping channel, whichever is greater.

Procedures:

1. Place the EUT on the table and set it in transmitting mode.
2. Remove the antenna from the EUT and then connect a low loss RF cable from the antenna port to the spectrum analyzer.
- 3.
4. Set the spectrum analyzer as Span = approximately 2 to 3 times the 20 dB bandwidth, centered on a hopping channel, RBW \geq 1% of the 20 dB bandwidth, VBW \geq RBW, Sweep = auto, Detector function = peak, Trace = max hold.
5. Set the measured low, middle and high frequency and test 20dB bandwidth with spectrum analyzer.

Test Mode: GFSK Transmitting

Channel	Frequency (MHz)	20 dB Bandwidth (MHz)
Low	2402	1.044
Middle	2441	1.044
High	2480	1.044

Please refer to the following plots.

Low Channel

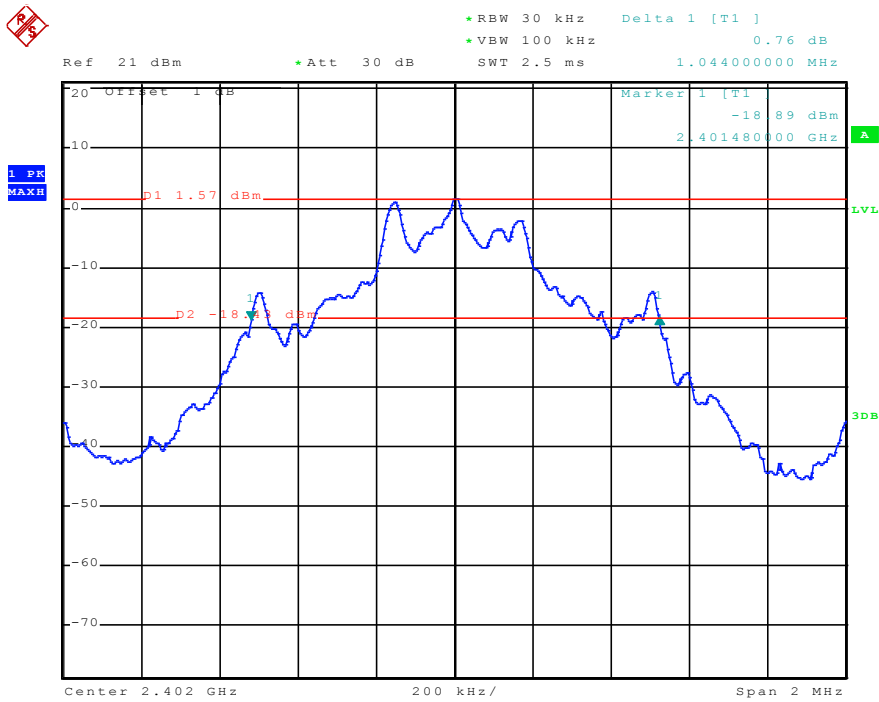

Date: 17.NOV.2011 00:35:34

MiddleChannel

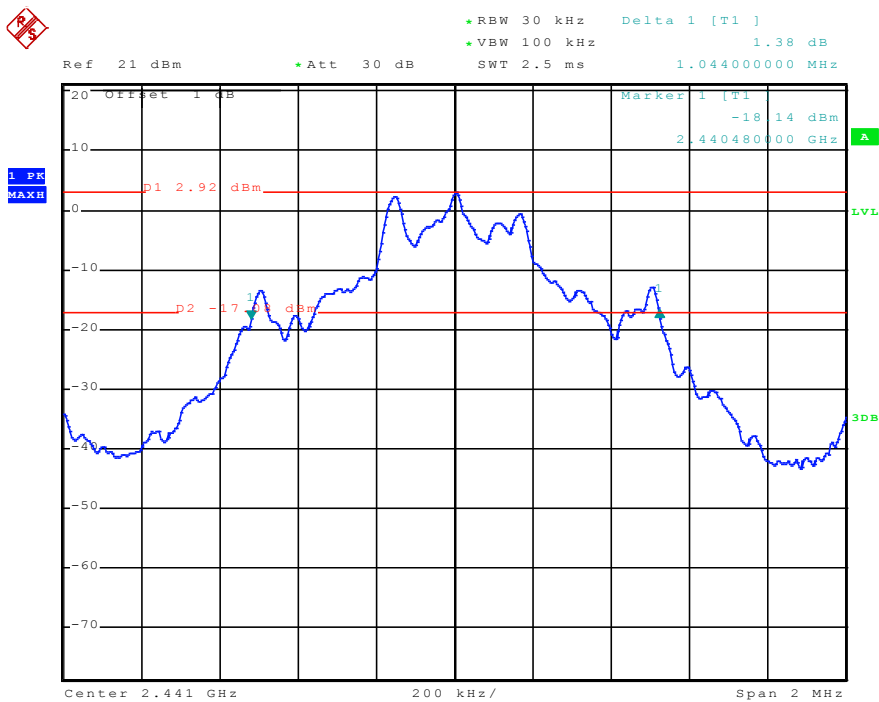

Date: 17.NOV.2011 00:39:30

High Channel

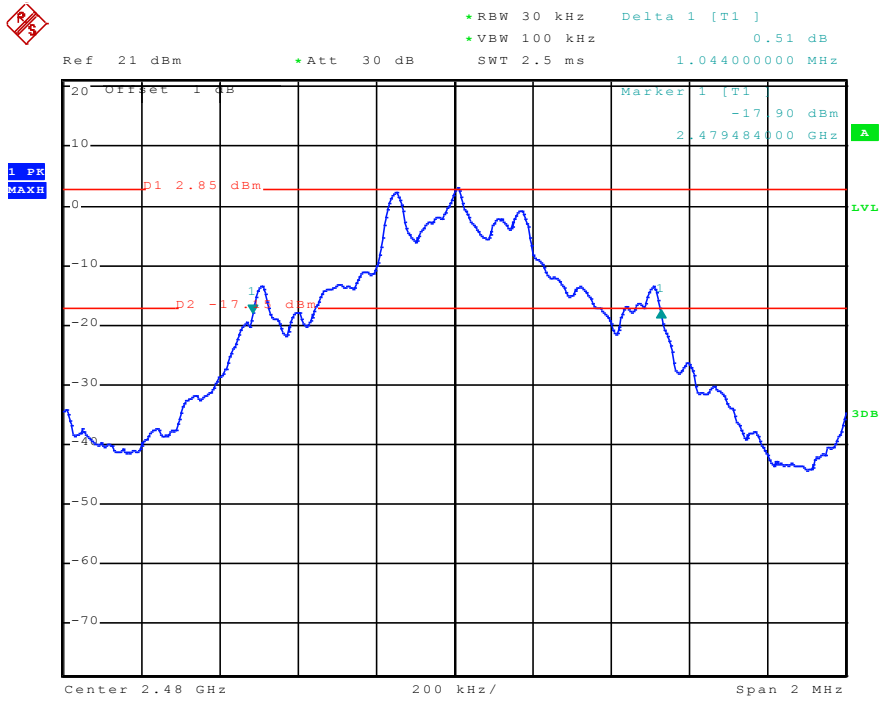

Date: 17.NOV.2011 00:42:20

5.6 §15.247(a) (1) (iii)-QUANTITY OF HOPPING CHANNEL TEST

1. Conducted Measurement
EUT was set for low, mid, high channel with modulated mode and highest RF output power.
The spectrum analyzer was connected to the antenna terminal.
2. Conducted Emissions Measurement Uncertainty
All test measurements carried out are traceable to national standards. The uncertainty of the measurement at a confidence level of approximately 95% (in the case where distributions are normal), with a coverage factor of 2, in the range 30MHz – 40GHz is ± 1.5 dB.
3. Environmental Conditions

Temperature	22°C
Relative Humidity	50%
Atmospheric Pressure	1019mbar
4. Test date : 17 November, 2011
Tested By : Back Huang

Standard Requirement:

According to §15.247(a)(1)(iii), Frequency hopping systems in the 2400–2483.5 MHz band shall use at least 15 channels.

Procedures:

1. Place the EUT on the table and set it in hopping function transmitting mode.
2. Remove the antenna from the EUT and then connect a low loss RF cable from the antenna port to the spectrum analyzer.
3. Set the spectrum analyzer as Start=2400MHz, Stop = 2483.5MHz, Span = the frequency band of operation, RBW $\geq 1\%$ of the span, VBW \geq RBW, Sweep = auto, Detector function = peak, Trace = max hold.
4. Count the quantity of peaks to get the number of hopping channels.

Test Result: Compliant.

Please refer to following tables and plots

Test Mode: GFSK Transmitting

Frequency Range (MHz)	Number of Hopping Channel	Limit
2400-2483.5	79	≥ 15

Number of Hopping Channels

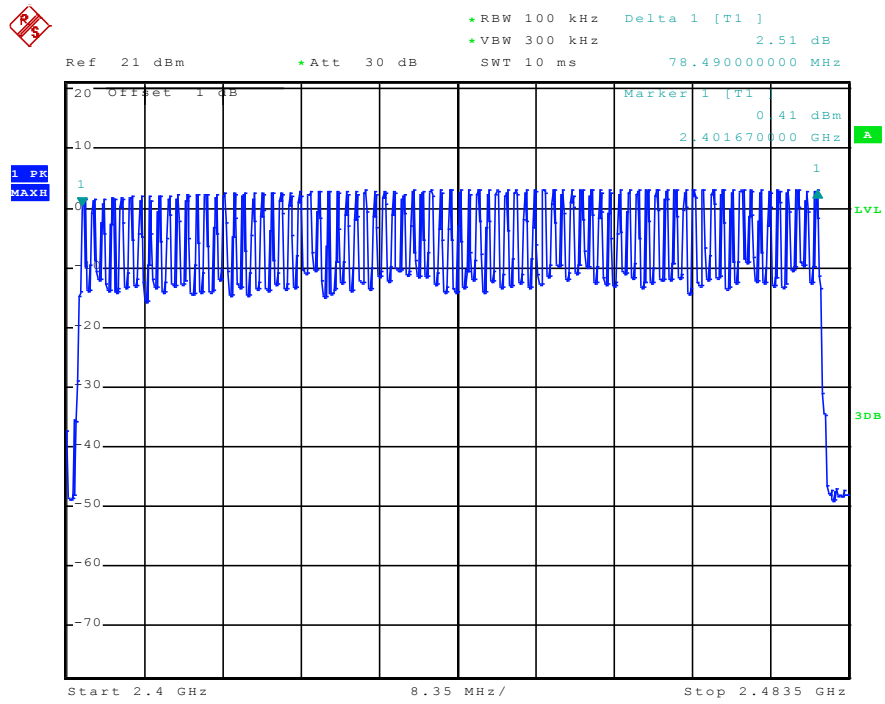

Date: 17.NOV.2011 00:48:34

5.7 §15.247(a) (1) (iii) -TIME OF OCCUPANCY (DWELL TIME)

1. Conducted Measurement
EUT was set for low, mid, high channel with modulated mode and highest RF output power.
The spectrum analyzer was connected to the antenna terminal.
2. Conducted Emissions Measurement Uncertainty
All test measurements carried out are traceable to national standards. The uncertainty of the measurement at a confidence level of approximately 95% (in the case where distributions are normal), with a coverage factor of 2, in the range 30MHz – 40GHz is $\pm 1.5\text{dB}$.
3. Environmental Conditions

Temperature	22°C
Relative Humidity	50%
Atmospheric Pressure	1019mbar
4. Test date : 17 November, 2011
Tested By : Back Huang

Standard Requirement:

According to §15.247(a)(1)(iii), The average time of occupancy on any channel shall not be greater than 0.4 seconds within a period of 0.4 seconds multiplied by the number of hopping channels employed. Frequency hopping systems may avoid or suppress transmissions on a particular hopping frequency provided that a minimum of 15 channels are used

Procedures:

1. Place the EUT on the table and set it in transmitting mode and switch on frequency hopping function.
2. Remove the antenna from the EUT and then connect a low loss RF cable from the antenna port to the spectrum analyzer.
3. Set the spectrum analyzer as Span = zero span, centered on a hopping channel, RBW=1MHz, VBW \geq RBW, Sweep = as necessary to capture the entire dwell time per hopping channel, Detector function = peak, Trace = max hold.
4. Calculate the time of occupancy in a period with time occupancy of a burst and quantity of bursts.

Test Result: Compliant.

Please refer to following tables and plots

Test Mode: GFSK Transmitting

Mode	Channel	Pulse Width (ms)	Dwell Time (S)	Limit (S)	Result
DH 1	Low	0.4590	0.146880	0.4	Pass
	Middle	0.4590	0.146880	0.4	Pass
	High	0.4590	0.146880	0.4	Pass
	<i>Note: Dwell time=Pulse time (ms) × (1600 ÷ 2 ÷ 79) × 31.6 Second</i>				
DH 3	Low	1.7536	0.280576	0.4	Pass
	Middle	1.7536	0.280576	0.4	Pass
	High	1.7536	0.280576	0.4	Pass
	<i>Note: Dwell time=Pulse time (ms) × (1600 ÷ 4 ÷ 79) × 31.6 Second</i>				
DH 5	Low	2.9920	0.319147	0.4	Pass
	Middle	2.9920	0.319147	0.4	Pass
	High	2.9920	0.319147	0.4	Pass
	<i>Note: Dwell time=Pulse Time (ms) × (1600 ÷ 6 ÷ 79) × 31.6 Second</i>				

Please refer to the following plots.

Low Channel for DH1

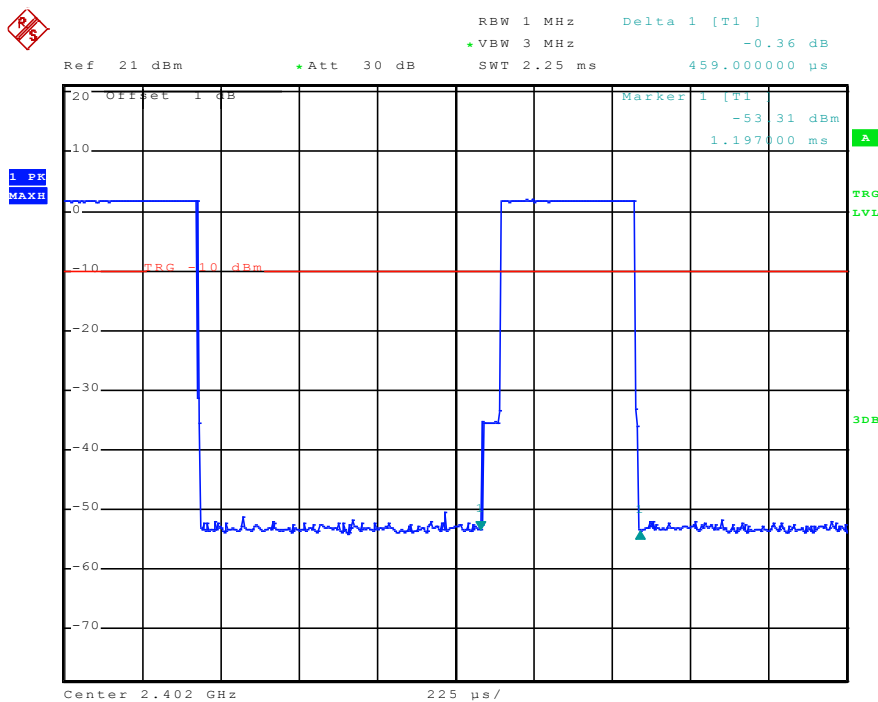

Middle Channel for DH1

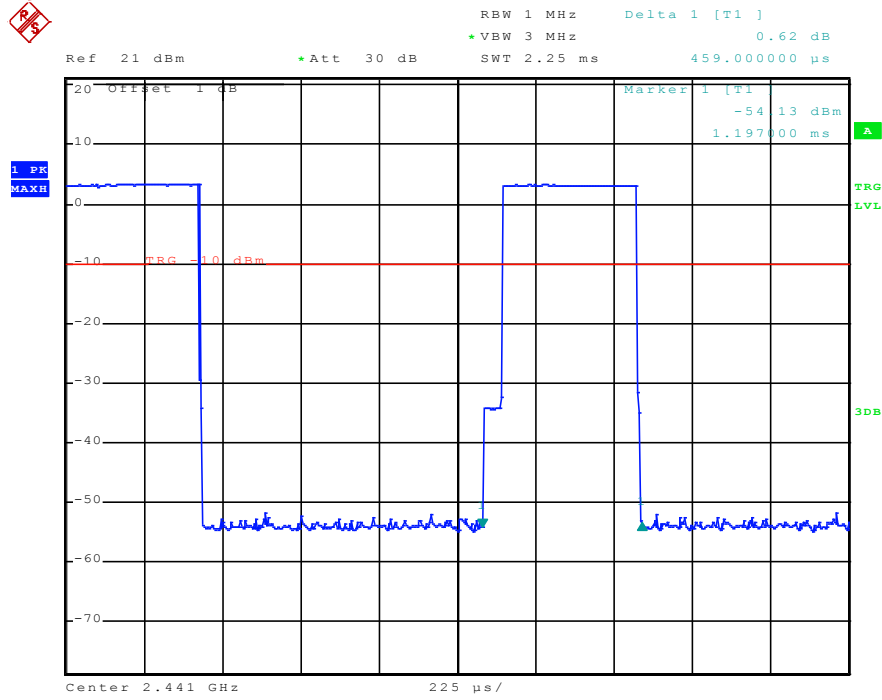

Date: 17.NOV.2011 00:53:51

High Channel for DH1

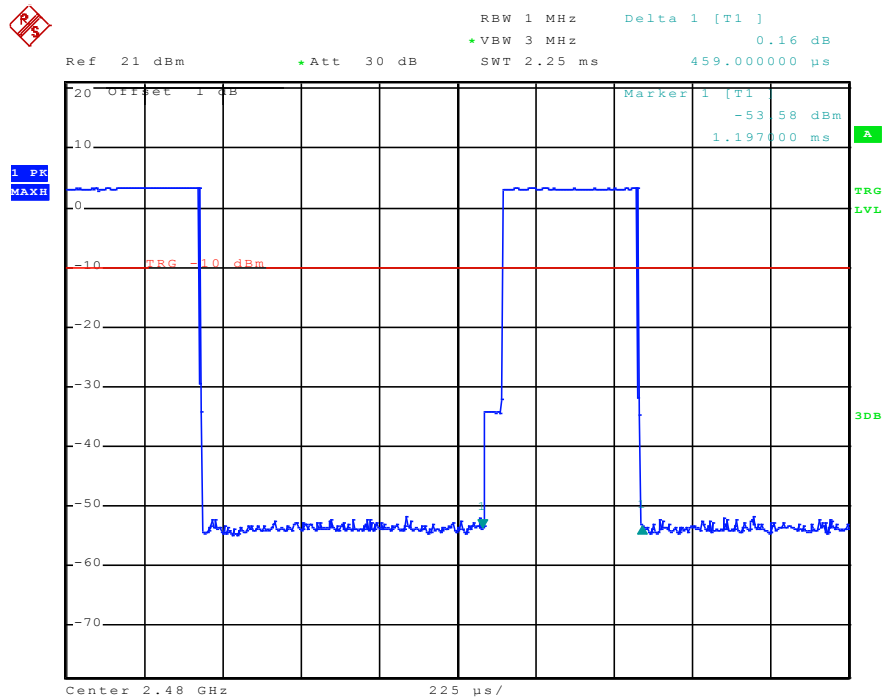

Date: 17.NOV.2011 00:54:31

Low Channel for DH3

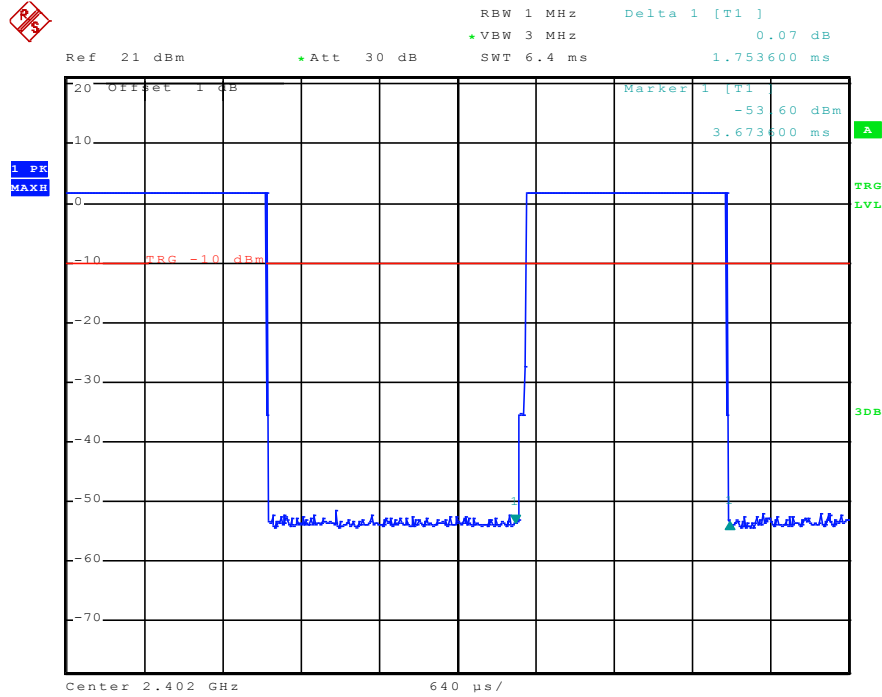

Date: 17.NOV.2011 00:56:50

Middle Channel for DH3

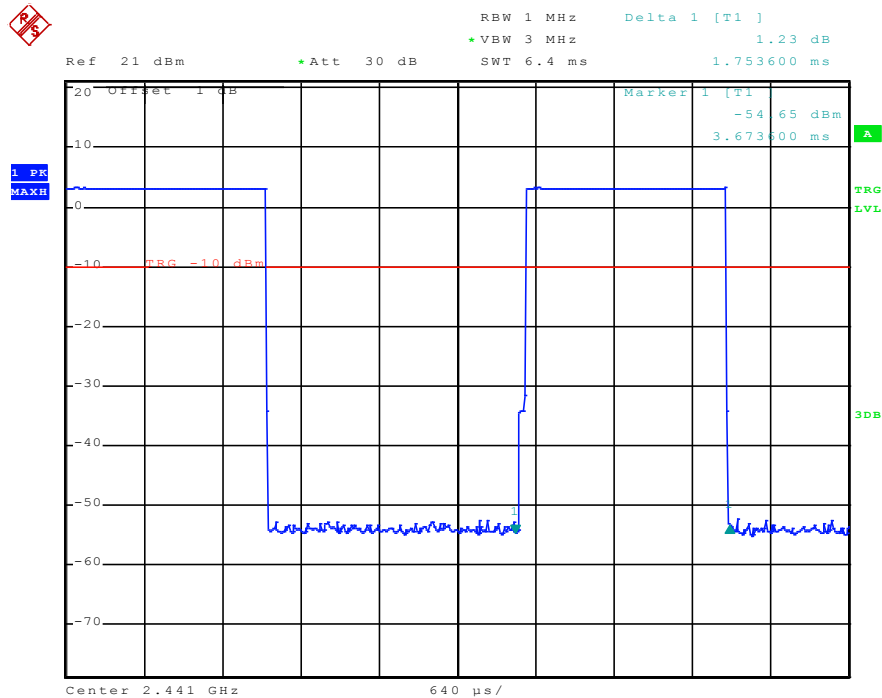

Date: 17.NOV.2011 00:57:30

High Channel for DH3

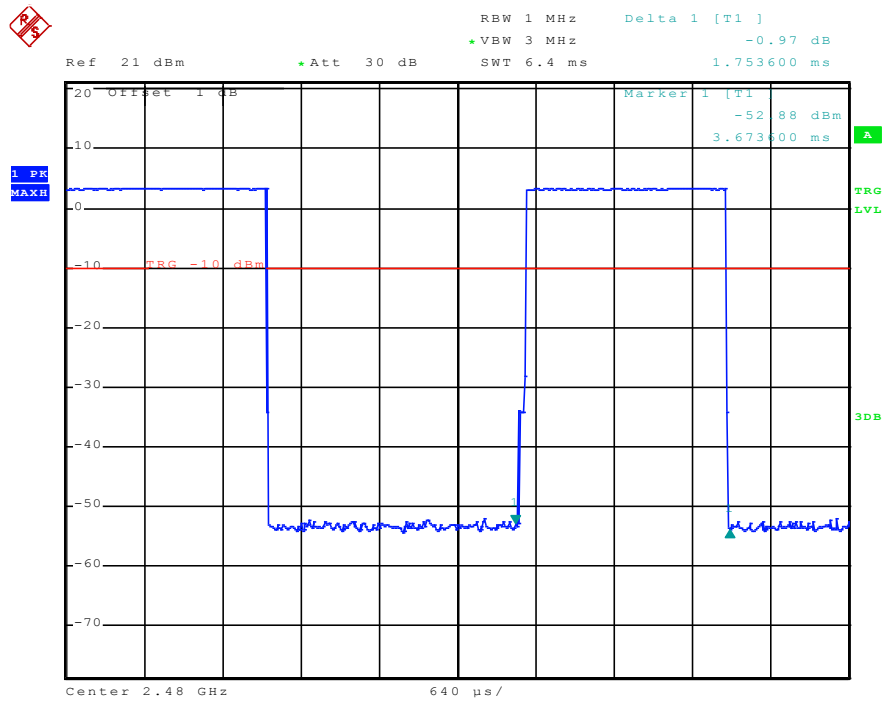

Date: 17.NOV.2011 00:58:17

Low Channel for DH5

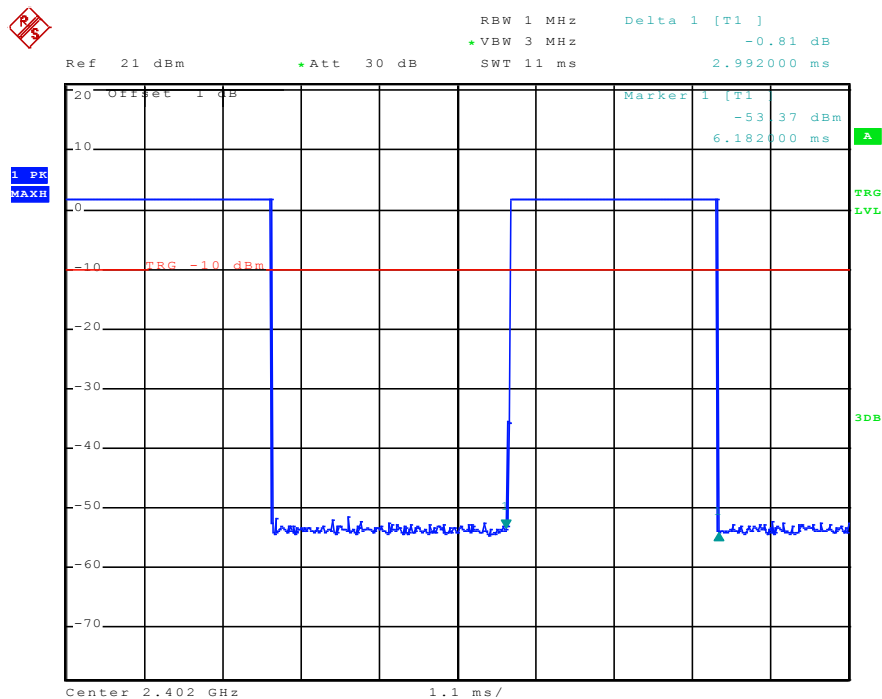

Date: 17.NOV.2011 01:00:58

Middle Channel for DH5

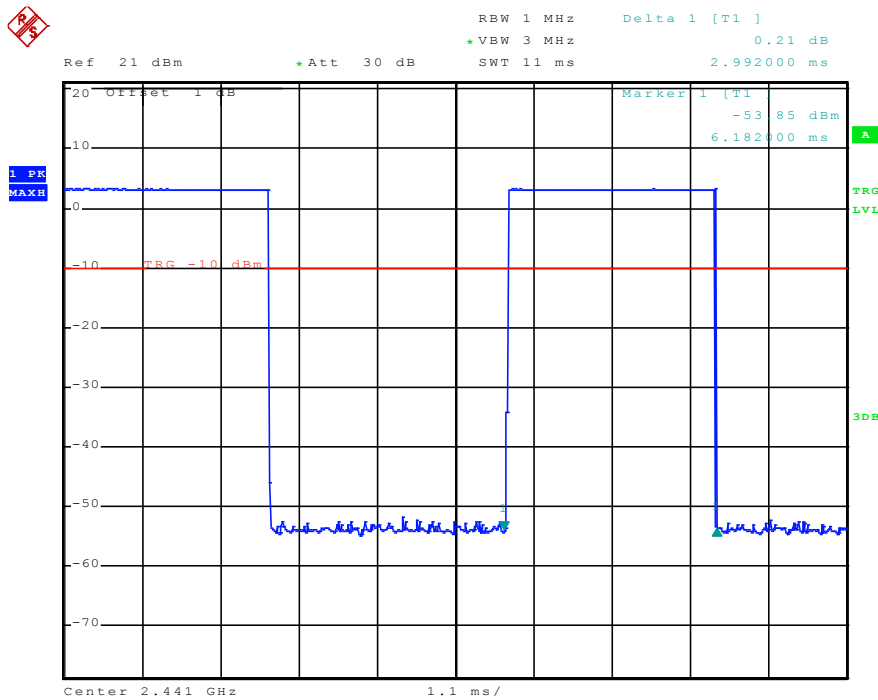

Date: 17.NOV.2011 01:01:47

High Channel for DH5

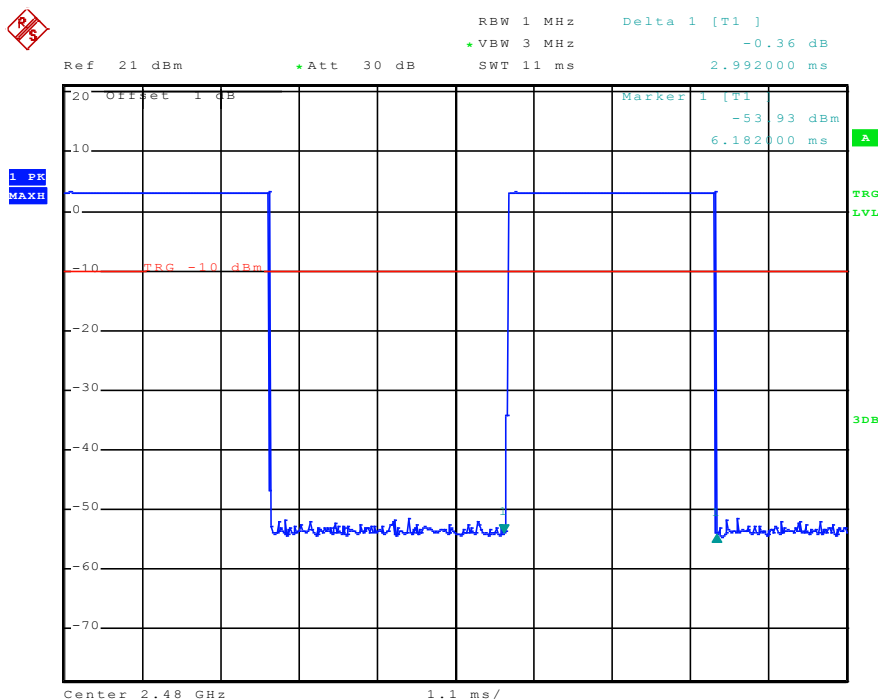

Date: 17.NOV.2011 01:02:28

5.8 §15.247(b) (1) - PEAK OUTPUT POWER MEASUREMENT

1. Conducted Measurement
EUT was set for low, mid, high channel with modulated mode and highest RF output power.
The spectrum analyzer was connected to the antenna terminal.
2. Conducted Emissions Measurement Uncertainty
All test measurements carried out are traceable to national standards. The uncertainty of the measurement at a confidence level of approximately 95% (in the case where distributions are normal), with a coverage factor of 2, in the range 30MHz – 40GHz is $\pm 1.5\text{dB}$.
3. Environmental Conditions

Temperature	22°C
Relative Humidity	50%
Atmospheric Pressure	1019mbar
4. Test date : 17 November, 2011
Tested By : Back Huang

Standard Requirement:

According to §15.247(b)(2), For frequency hopping systems in the 2400-2483.5 MHz band employing at least 75 non-overlapping hopping channels, and all frequency hopping systems in the 5725-5850MHz band: 1 watt. For all other frequency hopping systems in the 2400-2483.5MHz band: 0.125watts.

Procedures:

1. Place the EUT on the table and set it in transmitting mode.
2. Remove the antenna from the EUT and then connect a low loss RF cable from the antenna port to the spectrum analyzer.
3. Set the spectrum analyzer as Span = approximately 5 times the 20 dB bandwidth, centered on a hopping channel, RBW > the 20 dB bandwidth of the emission being measured, VBW \geq RBW, Sweep=auto, Detector function=peak, Trace = max hold.
4. Then set the EUT to transmit at low, middle and high channel and measure the conducted output power separately.

Test Result: Compliant.

Please refer to following tables and plots

Test Mode: GFSK Transmitting

Channel	Channel frequency (MHz)	Peak output power (dBm)	Power output (mW)	Limit (mW)
Low channel	2402	1.91	1.552	1000
Middle channel	2441	3.50	2.239	1000
High channel	2480	3.41	2.193	1000

Note: The data above was tested in conducted mode.

Low Channel

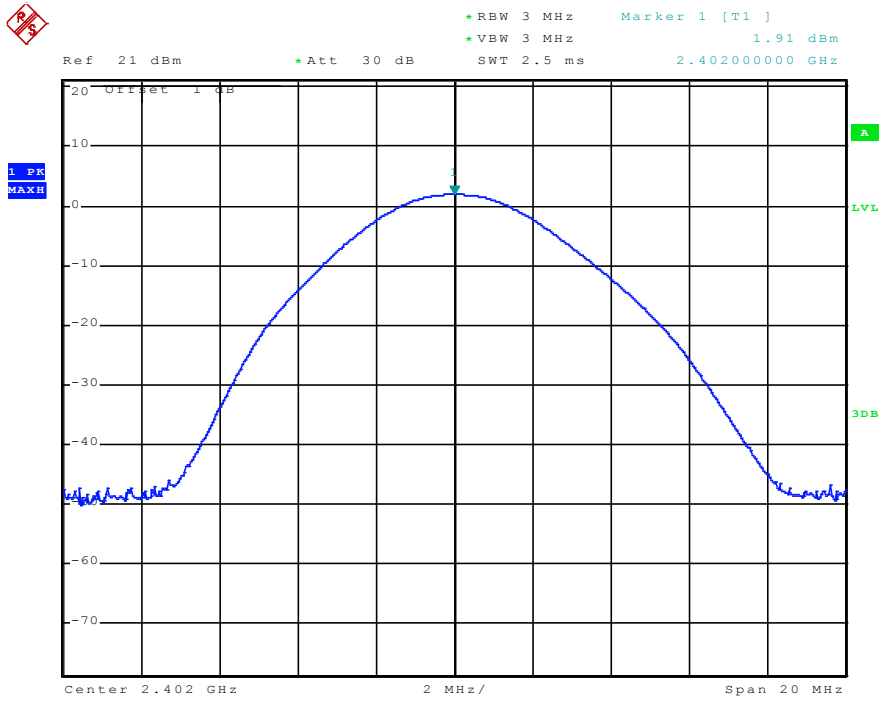

Date: 17.NOV.2011 01:04:24

Middle Channel

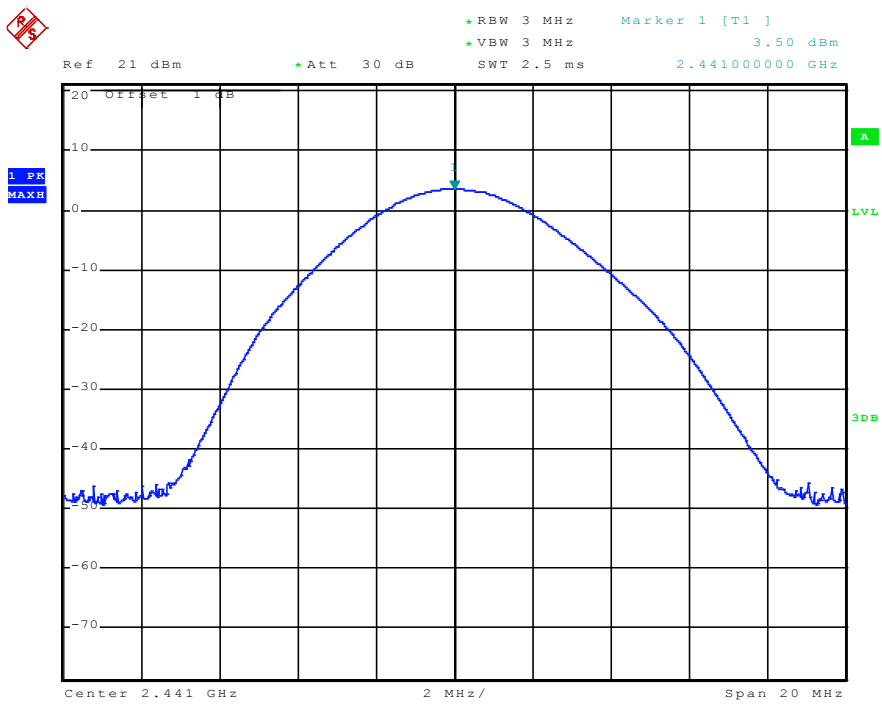

Date: 17.NOV.2011 01:05:51



SIEMIC, INC.

Accessing global markets

Title: RF Test Report for GSM/GPRS Tri-band Mobile Phone
Model: R700
To: FCC 15.247:2011

Serial#: 11070093-FCC-RF-BT
Issue Date: 3 November, 2011
Page: 36 of 53
www.siemec.com.cn

High Channel

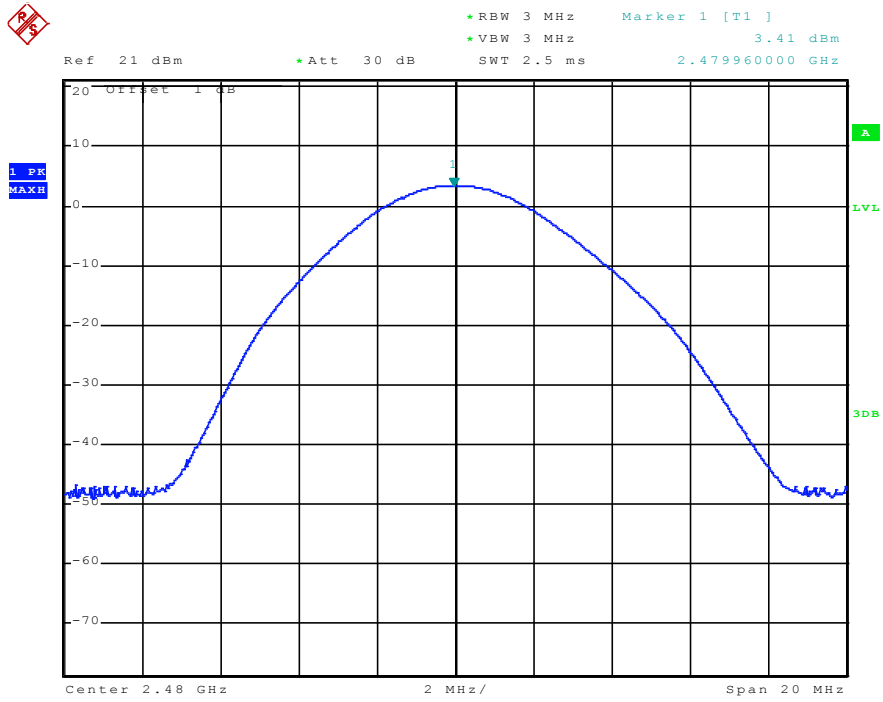

Date: 17.NOV.2011 01:06:29

5.9 §15.247(d) - BAND EDGES TESTING

Applicable Standard

In any 100 kHz bandwidth outside the frequency band in which the spread spectrum or digitally modulated intentional radiator is operating, the radio frequency power that is produced by the intentional radiator shall be at least 20 dB below that in the 100 kHz bandwidth within the band that contains the highest level of the desired power, based on either an RF conducted or a radiated measurement, provided the transmitter demonstrates compliance with the peak conducted power limits. If the transmitter complies with the conducted power limits based on the use of RMS averaging over a time interval, as permitted under paragraph (b)(3) of this section, the attenuation required under this paragraph shall be 30 dB instead of 20 dB. Attenuation below the general limits specified in §15.209(a) is not required. In addition, radiated emissions which fall in the restricted bands, as defined in §15.205(a), must also comply with the radiated emission limits specified in §15.209(a) (see §15.205(c)).

Test Procedure

1. Check the calibration of the measuring instrument using either an internal calibrator or a known signal from an external generator.
2. Position the EUT without connection to measurement instrument. Put it on the Rotated table and turn on the EUT and make it operate in transmitting mode. Then set it to Low Channel and High Channel within its operating range, and make sure the instrument is operated in its linear range.
3. Set both RBW and VBW of spectrum analyzer to 100 kHz with a convenient frequency span including 100kHz bandwidth from band edge, for Radiated emissions restricted band RBW=1MHz, VBW=3MHz.
4. Measure the highest amplitude appearing on spectral display and set it as a reference level. Plot the graph with marking the highest point and edge frequency.
5. Repeat above procedures until all measured frequencies were complete.

Test Result: Compliant

Test Mode: GFSK Transmitting

Frequency (MHz)	Delta Peak to Band Emission (dBc)	Limit (dBc)
2398.736	47.72	20
2486.668	49.98	20

Note: The point fall into the strict band was recorded in FCC 15.209, please refer to the restrict band testing.

Please refer to follow plots:

Band Edge: Left Side

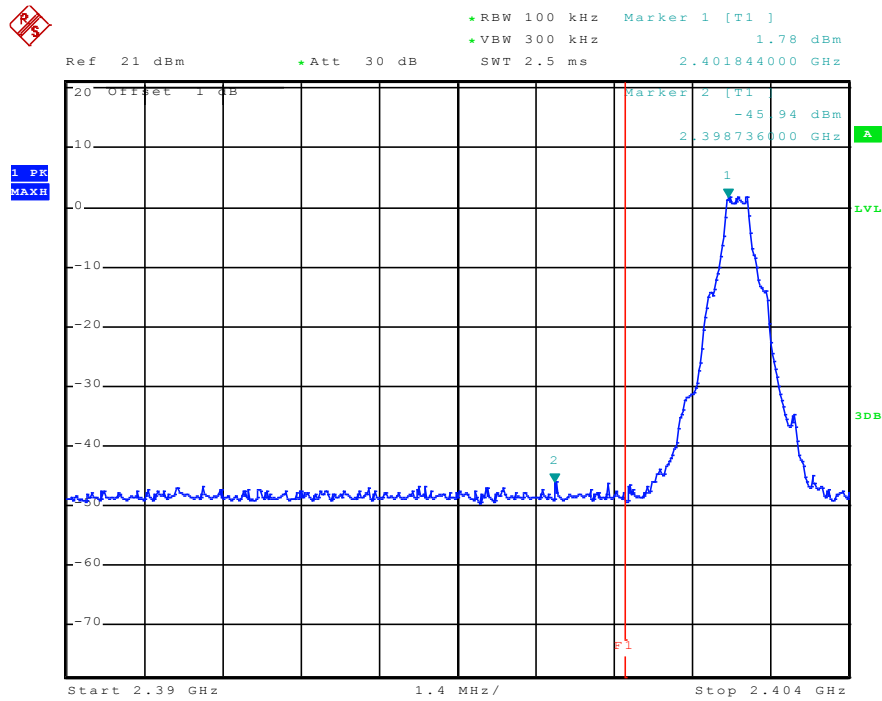

Date: 17.NOV.2011 01:10:49

Band Edge: Right Side

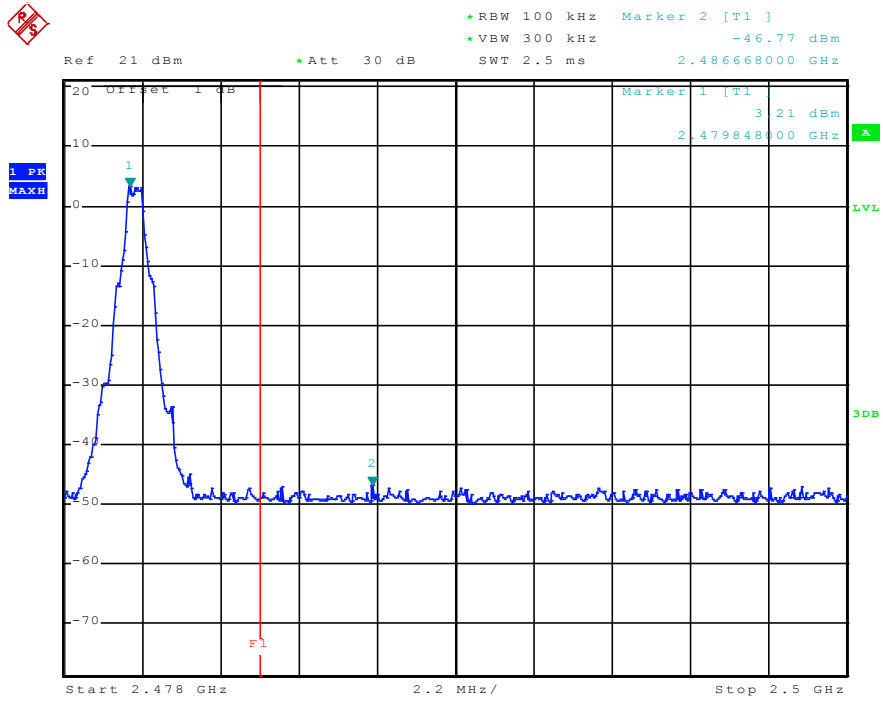

Date: 17.NOV.2011 01:13:03

Annex A. TEST INSTRUMENT & METHOD

Annex A.i. TEST INSTRUMENTATION & GENERAL PROCEDURES

Instrument	Model	Calibration Date	Calibration Due Date
AC Conducted Emissions			
R&S EMI Test Receiver	ESPI3	05/25/2011	05/25/2012
R&S LISN	LI-115	05/25/2011	05/25/2012
Universal Radio Communication Tester	CMU200	02/22/2011	02/22/2012
Radiated Emissions			
Spectrum Analyzer	8563E	01/10/2011	01/10/2012
EMI Receiver	ESPI3	05/18/2011	05/18/2012
Antenna(1 ~18GHz)	3115	6/2/2011	6/2/2012
Antenna (30MHz~2GHz)	JB1	05/25/2011	05/25/2012
Chamber	3m	4/13/2011	4/13/2012
Pre-Amplifier(1 ~ 18GHz)	AMF-7D-00101800-30-10P	5/25/2011	5/25/2012
Horn Antenna (18~40GHz)	AH-840	7/23/2011	7/23/2013
Microwave Pre-Amp (18~40GHz)	PA-840	Every 2000 Hours	
Universal Radio Communication Tester	CMU200	02/22/2011	02/22/2012
Signal Analyzer	8665B	1/21/2011	1/21/2012
Temperature/Humidity Chamber	1007H	06/08/2011	06/08/2012

Annex A.ii. CONDUCTED EMISSIONS TEST DESCRIPTION

Test Set-up

1. The EUT and supporting equipment were set up in accordance with the requirements of the standard on top of a 1.5m x 1m x 0.8m high, non-metallic table, as shown in Annex B.
2. The power supply for the EUT was fed through a 50Ω/50μH EUT LISN, connected to filtered mains.
3. The RF OUT of the EUT LISN was connected to the EMI test receiver via a low-loss coaxial cable.
4. All other supporting equipments were powered separately from another main supply.

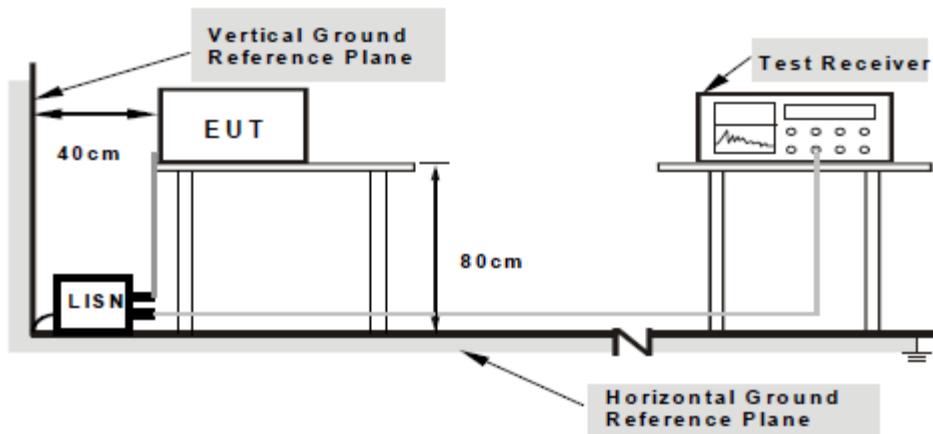

**Note: 1.Support units were connected to second LISN.
2.Both of LISNs (AMN) are 80cm from EUT and at least 80cm from other units and other metal planes support units.**

For the actual test configuration, please refer to the related item – Photographs of the Test Configuration1.

Test Method

1. The EUT was switched on and allowed to warm up to its normal operating condition.
2. A scan was made on the NEUTRAL line (for AC mains) or Earth line (for DC power) over the required frequency range using an EMI test receiver.
3. High peaks, relative to the limit line, were then selected.
4. The EMI test receiver was then tuned to the selected frequencies and the necessary measurements made with a receiver bandwidth setting of 10 KHz. For FCC tests, only Quasi-peak measurements were made; while for CISPR/EN tests, both Quasi-peak and Average measurements were made.
5. Steps 2 to 4 were then repeated for the LIVE line (for AC mains) or DC line (for DC power).

Description of Conducted Emission Program

This EMC Measurement software run LabView automation software and offers a common user interface for electromagnetic interference (EMI) measurements. This software is a modern and powerful tool for controlling and monitoring EMI test receivers and EMC test systems. It guarantees reliable collection, evaluation, and documentation of measurement results. Basically, this program will run a pre-scan measurement before it proceeds with the final measurement. The pre-scan routine will run the common scan range from 150 kHz to 30 MHz; the program will first start a peak and average scan on selectable measurement time and step size. After the program complete the pre-scan, this program will perform the Quasi Peak and Average measurement, based on the pre-scan peak data reduction result.



SIEMIC, Inc.

Accessing global markets

Title: RF Test Report for GSM/GPRS Tri-band Mobile Phone
Model: R700
To: FCC 15.247:2011

Serial#: 11070093-FCC-RF-BT
Issue Date: 3 November, 2011
Page: 42 of 53
www.siemac.com.cn

Sample Calculation Example

At 20 MHz

limit = $250 \mu\text{V} = 47.96 \text{ dB}\mu\text{V}$

Transducer factor of LISN, pulse limiter & cable loss at 20 MHz = 11.20 dB

Q-P reading obtained directly from EMI Receiver = 40.00 dB μV

(Calibrated for system losses)

Therefore, Q-P margin = $47.96 - 40.00 = 7.96$

i.e. **7.96 dB below limit**

Annex A. iii. RADIATED EMISSIONS TEST DESCRIPTION

Limit

1. Except as provided elsewhere in this Subpart, the emissions from an intentional radiator shall not exceed the field strength levels specified in the following table:

Frequency (MHz)	Field Strength (mV/m)	Measurement Distance (m)
30-88	100*	3
88-216	150*	3
216-960	200*	3
Above 960	500	3

Remark: Except as provided in paragraph (g), fundamental emissions from intentional radiators operating under this Section shall not be located in the frequency bands 54-72 MHz, 76-88 MHz, 174-216 MHz or 470-806 MHz. However, operation within these frequency bands is permitted under other sections of this Part, e.g., Sections 15.231 and 15.241.

2. In the above emission table, the tighter limit applies at the band edges.

Frequency (Hz)	Field Strength (µV/m at 3-meter)	Field Strength (dBµV/m at 3-meter)
30-88	100	40
88-216	150	43.5
216-960	200	46
Above 960	500	54

EUT Characterisation

EUT characterisation, over the frequency range from 30MHz to 10th Harmonic, was done in order to minimise radiated emissions testing time while still maintaining high confidence in the test results.

The EUT was placed in the chamber, at a height of about 0.8m on a turntable. Its radiated emissions frequency profile was observed, using a spectrum analyzer /receiver with the appropriate broadband antenna placed 3m away from the EUT. Radiated emissions from the EUT were maximised by rotating the turntable manually, changing the antenna polarisation and manipulating the EUT cables while observing the frequency profile on the spectrum analyzer / receiver. Frequency points at which maximum emissions occurred, clock frequencies and operating frequencies were then noted for the formal radiated emissions test at the Open Area Test Site (OATS).

Test Set-up

1. The EUT and supporting equipment were set up in accordance with the requirements of the standard on top of a 1.5m X 1.0m X 0.8m high, non-metallic table.
2. The filtered power supply for the EUT and supporting equipment were tapped from the appropriate power sockets located on the turntable.
3. The relevant broadband antenna was set at the required test distance away from the EUT and supporting equipment boundary.

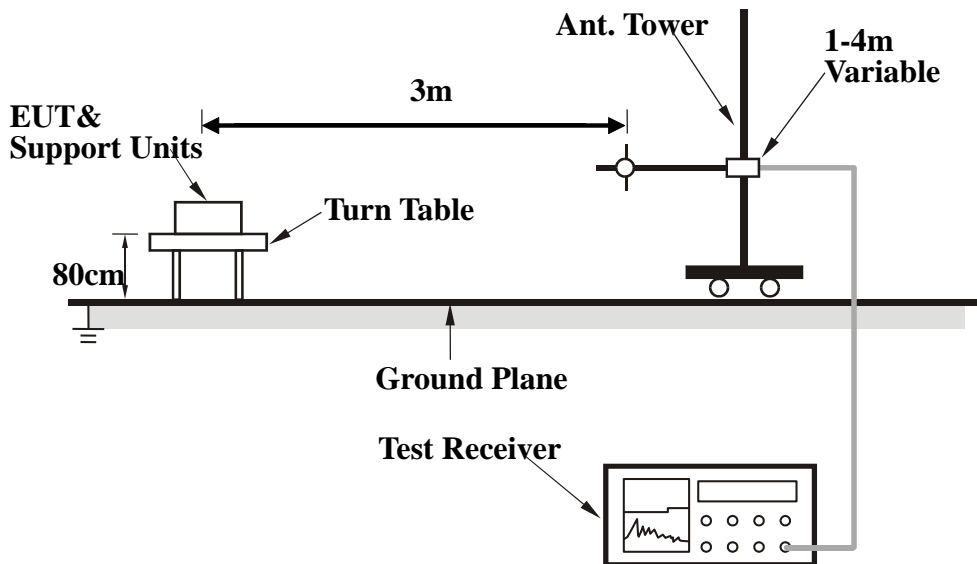

Test Method

The following procedure was performed to determine the maximum emission axis of EUT:

1. With the receiving antenna is H polarization, rotate the EUT in turns with three orthogonal axes to determine the axis of maximum emission.
2. With the receiving antenna is V polarization, rotate the EUT in turns with three orthogonal axes to determine the axis of maximum emission.
3. Compare the results derived from above two steps. So, the axis of maximum emission from EUT was determined and the configuration was used to perform the final measurement.

Final Radiated Emission Measurement

1. Setup the configuration according to figure 1. Turn on EUT and make sure that it is in normal function.
2. For emission frequencies measured below 1 GHz, a pre-scan is performed in a shielded chamber to determine the accurate frequencies of higher emissions will be checked on a open test site. As the same purpose, for emission frequencies measured above 1 GHz, a pre-scan also be performed with a 1 meter measuring distance before final test.
3. For emission frequencies measured below and above 1 GHz, set the spectrum analyzer on a 100 kHz and 1 MHz resolution bandwidth respectively for each frequency measured in step 2.
4. The search antenna is to be raised and lowered over a range from 1 to 4 meters in horizontally polarized orientation. Position the highness when the highest value is indicated on spectrum analyzer, then change the orientation of EUT on test table over a range from 0 ° to 360 ° with a speed as slow as possible, and keep the azimuth that highest emission is indicated on the spectrum analyzer. Vary the antenna position again and record the highest value as a final reading.
5. Repeat step 4 until all frequencies need to be measured were complete.
6. Repeat step 5 with search antenna in vertical polarized orientations.

During the radiated emission test, the Spectrum Analyzer was set with the following configurations:

Frequency Band (MHz)	Function	Resolution bandwidth	Video Bandwidth
30 to 1000	Peak	100 kHz	100 kHz
Above 1000	Peak	1 MHz	1 MHz
	Average	1 MHz	10 Hz

Description of Radiated Emission Program

This EMC Measurement software run LabView automation software and offers a common user interface for electromagnetic interference (EMI) measurements. This software is a modern and powerful tool for controlling and monitoring EMI test receivers and EMC test systems. It guarantees reliable collection, evaluation, and documentation of measurement results. Basically, this program will run a pre-scan measurement before it proceeds with the final measurement. The pre-scan routine will run the scan on four different antenna heights, 2 antenna polarity, and 360 degrees table rotation. For example, the program was set to run 30 MHz to 1 GHz scan; the program will first start from a meter antenna height and divide the 30 MHz to 1 GHz into 10 separate parts of maximum hold sweeps. Each parts of maximum hold sweep, the program will collect the data from 0 degree to 360 degrees table rotation. After the program complete the 1m scan, the antenna continues to rise to 2m and continue the scan. The step will repeated for all specified antenna height and polarity. This program will perform the Quasi Peak measurement after the signal maximization process and pre-scan routine. The final measurement will be base on the pre-scan data reduction result.

Sample Calculation Example

The field strength is calculated by adding the Antenna Factor and Cable Factor, and subtracting the Amplifier Gain (if any) from the measured reading. For the limit is employed average value, therefore the peak value can be transferred to average value by subtracting the duty factor. The basic equation with a sample calculation is as follows:

$$\text{Peak} = \text{Reading} + \text{Corrected Factor}$$

where

Corr. Factor = Antenna Factor + Cable Factor - Amplifier Gain (if any)

And the average value is

$$\text{Average} = \text{Peak Value} + \text{Duty Factor or}$$

Set RBW = 1MHz, VBW = 10Hz.

Note :

If the measured frequencies are fall in the restricted frequency band, the limit employed must be quasi peak value when frequencies are below or equal to 1 GHz. And the measuring instrument is set to quasi peak detector function.



SIEMIC, INC.

Accessing global markets

Title: RF Test Report for GSM/GPRS Tri-band Mobile Phone
Model: R700
To: FCC 15.247:2011

Serial#: 11070093-FCC-RF-BT
Issue Date: 3 November, 2011
Page: 46 of 53
www.siemac.com.cn

Annex B. EUT AND TEST SETUP PHOTOGRAPHS

Please see attachment

Annex C. TEST SETUP AND SUPPORTING EQUIPMENT

EUT TEST CONDITIONS

Annex C. i. SUPPORTING EQUIPMENT DESCRIPTION

The following is a description of supporting equipment and details of cables used with the EUT.

Manufacturer	Equipment Description (Including Brand Name)	Model & Serial Number	Calibration Date	Calibration Date
A.H. System	Horn Antenna	SAS-200/571	01/10/2011	01/10/2012
Rohde & Schwarz	Universal Radio Communication Tester	CMU200	05/18/2011	05/18/2012

Block Configuration Diagram for Conducted Emissions

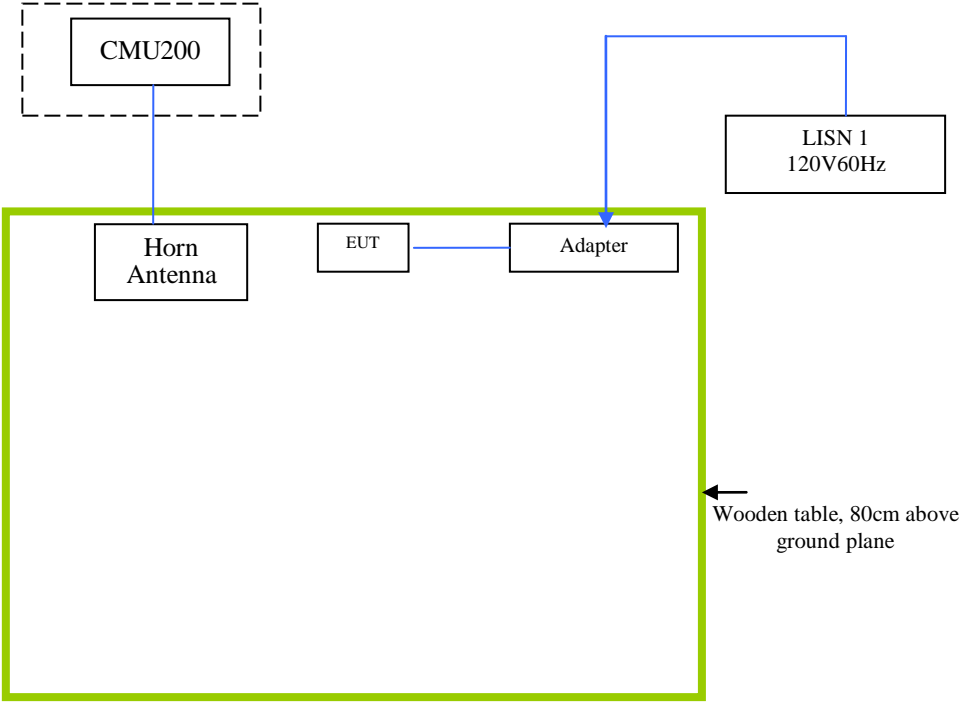

Block Configuration Diagram for Radiated Emissions

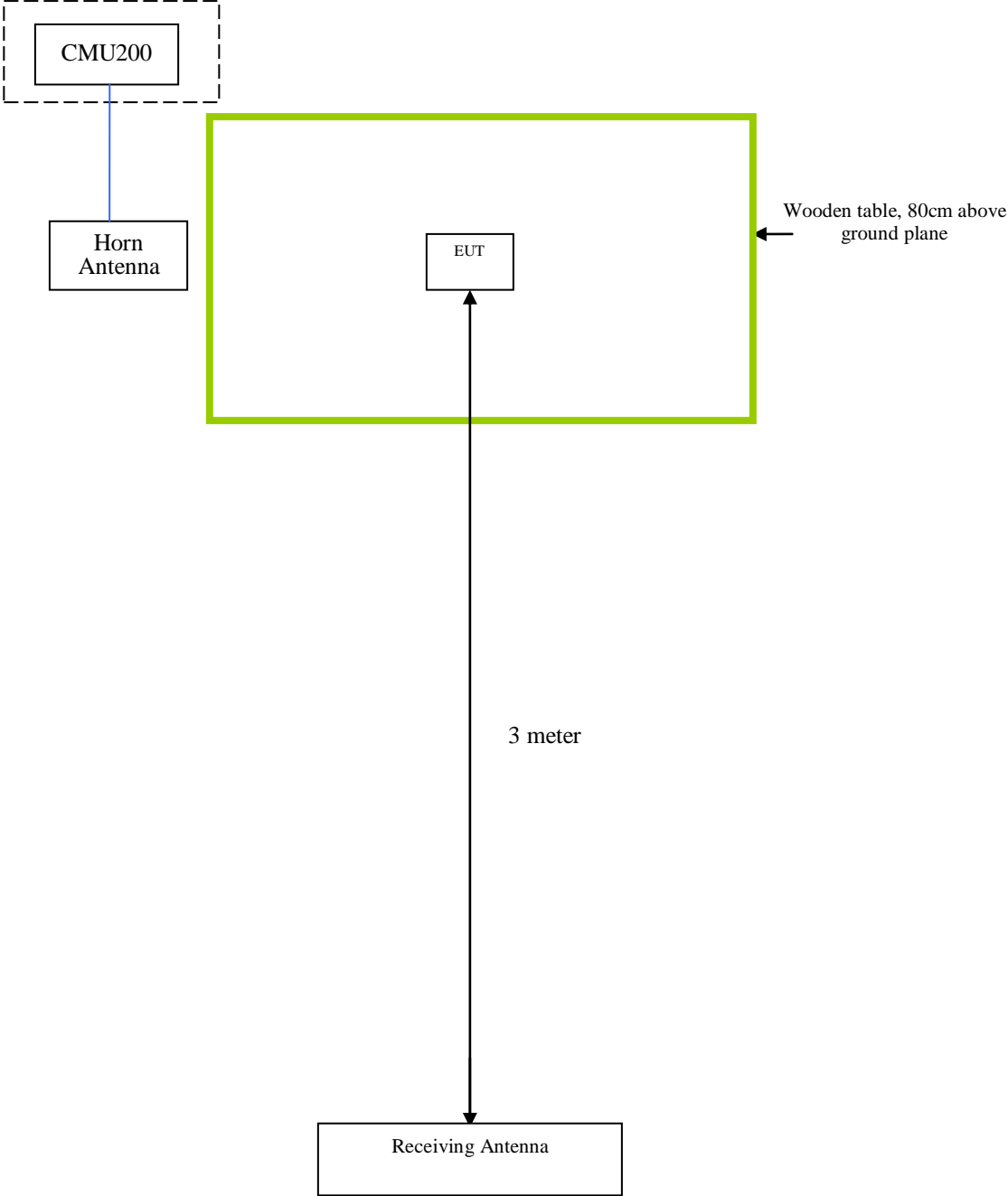

Annex C.ii. EUT OPERATING CONDITIONS

The following is the description of how the EUT is exercised during testing.

Test	Description Of Operation
Emissions Testing	The EUT was continuously transmitting to stimulate the worst case.



SIEMIC, INC.

Accessing global markets

Title: RF Test Report for GSM/GPRS Tri-band Mobile Phone
Model: R700
To: FCC 15.247:2011

Serial#: 11070093-FCC-RF-BT
Issue Date: 3 November, 2011
Page: 51 of 53
www.siemac.com.cn

Annex D. USER MANUAL / BLOCK DIAGRAM / SCHEMATICS / PART LIST

Please see attachment



SIEMIC, INC.

Accessing global markets

Title: RF Test Report for GSM/GPRS Tri-band Mobile Phone
Model: R700
To: FCC 15.247:2011

Serial#: 11070093-FCC-RF-BT
Issue Date: 3 November, 2011
Page: 52 of 53
www.sieminc.com.cn

Annex E. SIEMIC ACCREDITATION CERTIFICATES

SIEMIC ACREDITATION DETAILS: FCC Test Site Registration No. 986914

FEDERAL COMMUNICATIONS COMMISSION

Laboratory Division
7435 Oakland Mills Road
Columbia, MD 21046

April 19, 2011

Registration Number: 986914

SIEMIC Nanjing (China) Laboratories
2-1 Longcang Avenue,
Yuhua Economic and Technology Development Park,
Nanjing, 210039
China

Attention: Leslie Bai,

Re: Measurement facility located at 2-1 Longcang Avenue, Nanjing, China
Anechoic chamber (3 meters) and 3&10 meter OATS
Date of Renewal: April 19, 2011

Dear Sir or Madam:

Your request for renewal of the registration of the subject measurement facility has been received. The information submitted has been placed in your file and the registration has been renewed. The name of your organization will remain on the list of facilities whose measurement data will be accepted in conjunction with applications for Certification under Parts 15 or 18 of the Commission's Rules. Please note that the file must be updated for any changes made to the facility and the registration must be renewed at least every three years.

Measurement facilities that have indicated that they are available to the public to perform measurement services on a fee basis may be found on the FCC website www.fcc.gov under E-Filing, OET Equipment Authorization Electronic Filing, Test Firms.

Sincerely,

Phyllis Parrish
Industry Analyst



SIEMIC, INC.

Accessing global markets

Title: RF Test Report for GSM/GPRS Tri-band Mobile Phone
Model: R700
To: FCC 15.247:2011

Serial#: 11070093-FCC-RF-BT
Issue Date: 3 November, 2011
Page: 53 of 53
www.siemec.com.cn

SIEMIC ACREDITATION DETAILS: Industry of Canada Test Site Registration No. 4842B

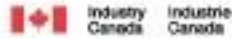

January 25, 2011

OUR FILE: 46405-4842
Submission No: 145222

Siemic Nanjing (China) Laboratories
2-1 Longcang Avenue
Yuhua Economic & Technology Dev. Park, Nanjing
China

Attention: Leslie Bai

Dear Sir/Madame:

The Bureau has received your application for the registration of a 3/10m OATS. Be advised that the information received was satisfactory to Industry Canada. The following number(s) is now associated to the site(s) for which registration / renewal was sought (**Site# 4842B-2**). Please reference the appropriate site number in the body of test reports containing measurements performed on the site. In addition, please keep for your records the following information:

- The company address code associated to the site(s) located at the above address is: **4842B**

Furthermore, to obtain or renew a unique site number, the applicant shall demonstrate that the site has been accredited to ANSI C63.4-2003 or later. A scope of accreditation indicating the accreditation by a recognized accreditation body to ANSI C63.4-2003 or later shall be accepted. Please indicate in a letter the previous assigned site number if applicable and the type of site (example: 3 metre OATS or 3 metre chamber). If the test facility is not accredited to ANSI C63.4-2003 or later, the test facility shall submit test data demonstrating full compliance with the ANSI standard. The Bureau will evaluate the filing to determine if recognition shall be granted.

The frequency for re-validation of the test site and the information that is required to be filed or retained by the testing party shall comply with the requirements established by the accrediting organization. However, in all cases, test site re-validation shall occur on an interval not to exceed three years. There is no fee or form associated with an OATS filing. OATS submissions are encouraged to be submitted electronically to the Bureau using the following URL:
http://strategis.ic.gc.ca/epcc/internet/inceb-bhst.nsf/en/h_00052e.html.

If you have any questions, you may contact the Bureau by e-mail at certification.bureau@ic.gc.ca. Please reference our file and submission number above for all correspondence.

Yours sincerely,

Dalvinder Gill
For: Wireless Laboratory Manager
Certification and Engineering Bureau
3701 Carling Ave., Building 94
P.O. Box 11490, Station "H"
Ottawa, Ontario K2H 8S2
Email: dalvinder.gill@ic.gc.ca
Tel. No. (613) 998-8363
Fax. No. (613) 990-4752