

6 5 4 3 2 1

REVISION RECORD			
LT#	ECO NO.	APPROVED:	DATE:

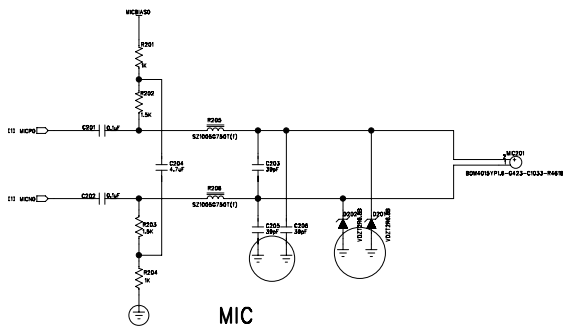

MIC

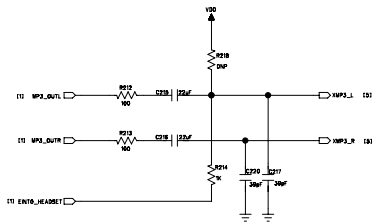

Headset spk

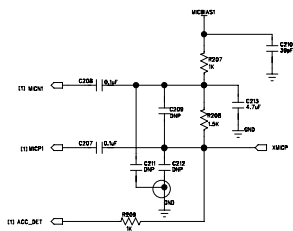

Headset MIC

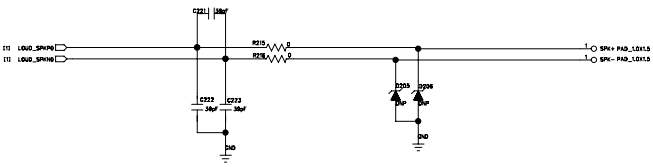

SPEAKER1

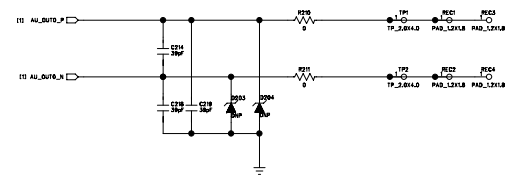

RECEIVER

DRAWN:		DATED:		COMPANY:	
CHECKED:		DATED:		TITLE:	
QUALITY CONTROL:		DATED:		AUDIO	
RELEASED:		DATED:		CODE:	SIZE:
				DRAWING NO.:	REV.:
				SHEET: OF	

6 5 4 3 2 1

REVISION RECORD			
LTN	ECO NO.	APPROVED:	DATE

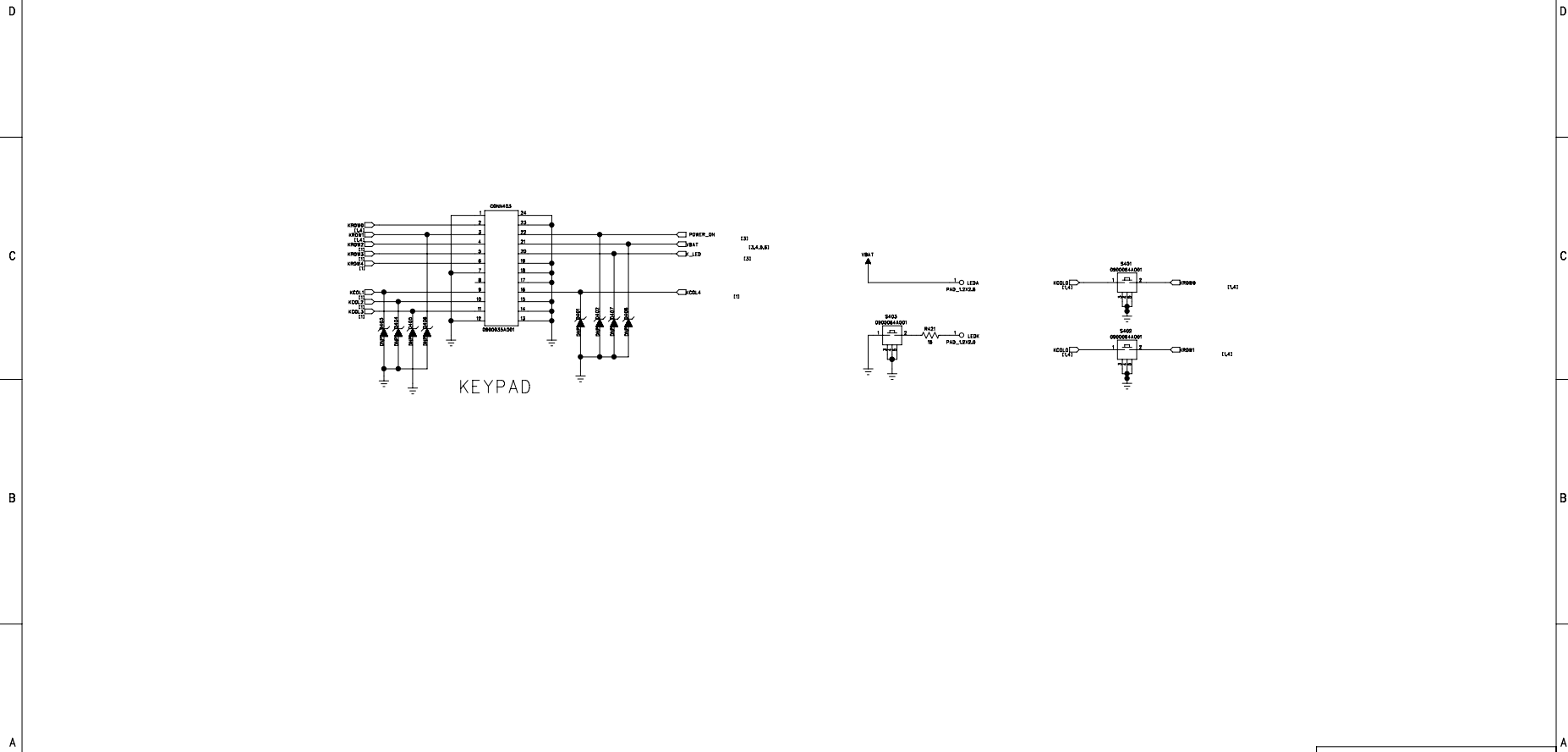

DRAWN:		DATED:		COMPANY:			
CHECKED:		DATED:		TITLE:			
QUALITY CONTROL:		DATED:		WIFI_KEY			
RELEASED:		DATED:		CODE:	SIZE:	DRAWING NO.	REV.
				SCALE:		SHEET: OF	

REVISION RECORD			
LT#	ECO NR	APPROVED:	DATE

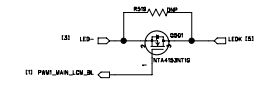
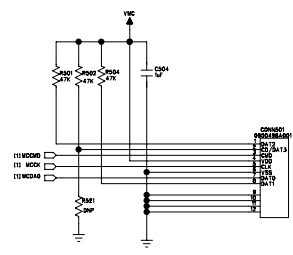
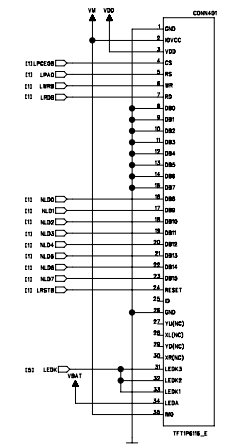
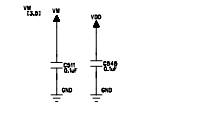
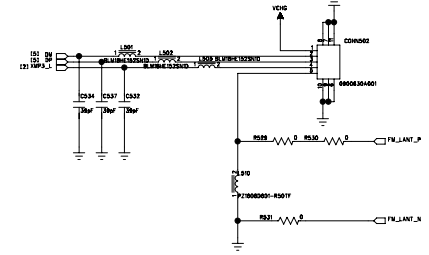
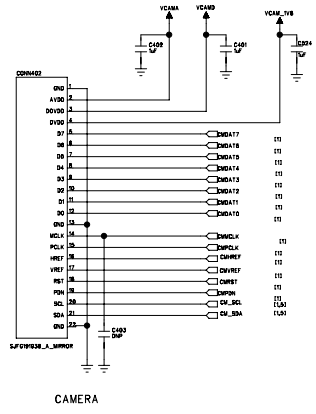
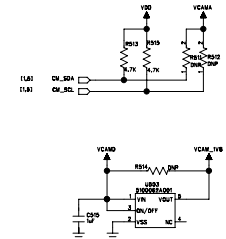
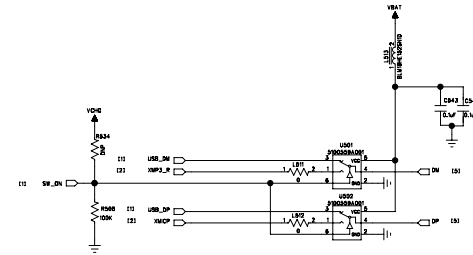

DRAWN:		DATED:		COMPANY:	
CHECKED:		DATED:		TITLE:	
QUALITY CONTROL:		DATED:		LCM_SENSOR_IO_TF	
RELEASED:		DATED:		CODE:	SIZE:
				DRAWING NO:	REV:
				SCALE:	SHEET: OF

REVISION RECORD			
LT#	ECO NO.	APPROVED:	DATE

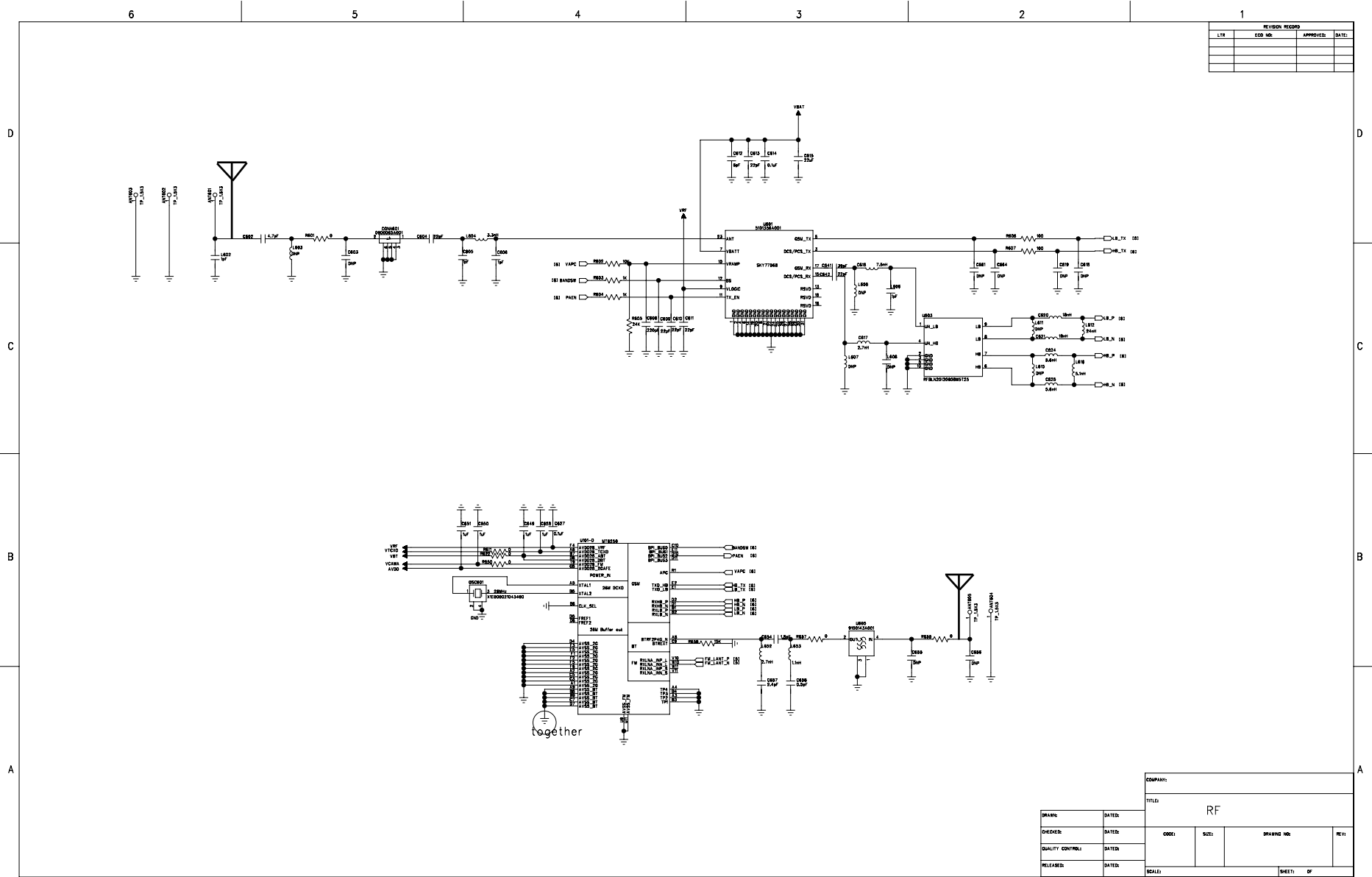

DRAWN:		DATED:		COMPANY:	
CHECKED:		DATED:		TITLE: RF	
QUALITY CONTROL:		DATED:		CODE:	SIZE:
RELEASED:		DATED:		DRAWING NO.:	REV.:
SCALE:				SHEET: OF	