

6

5

4

3

2

1

REVISION RECORD			
LT#	ECO NO.	APPROVED:	DATE

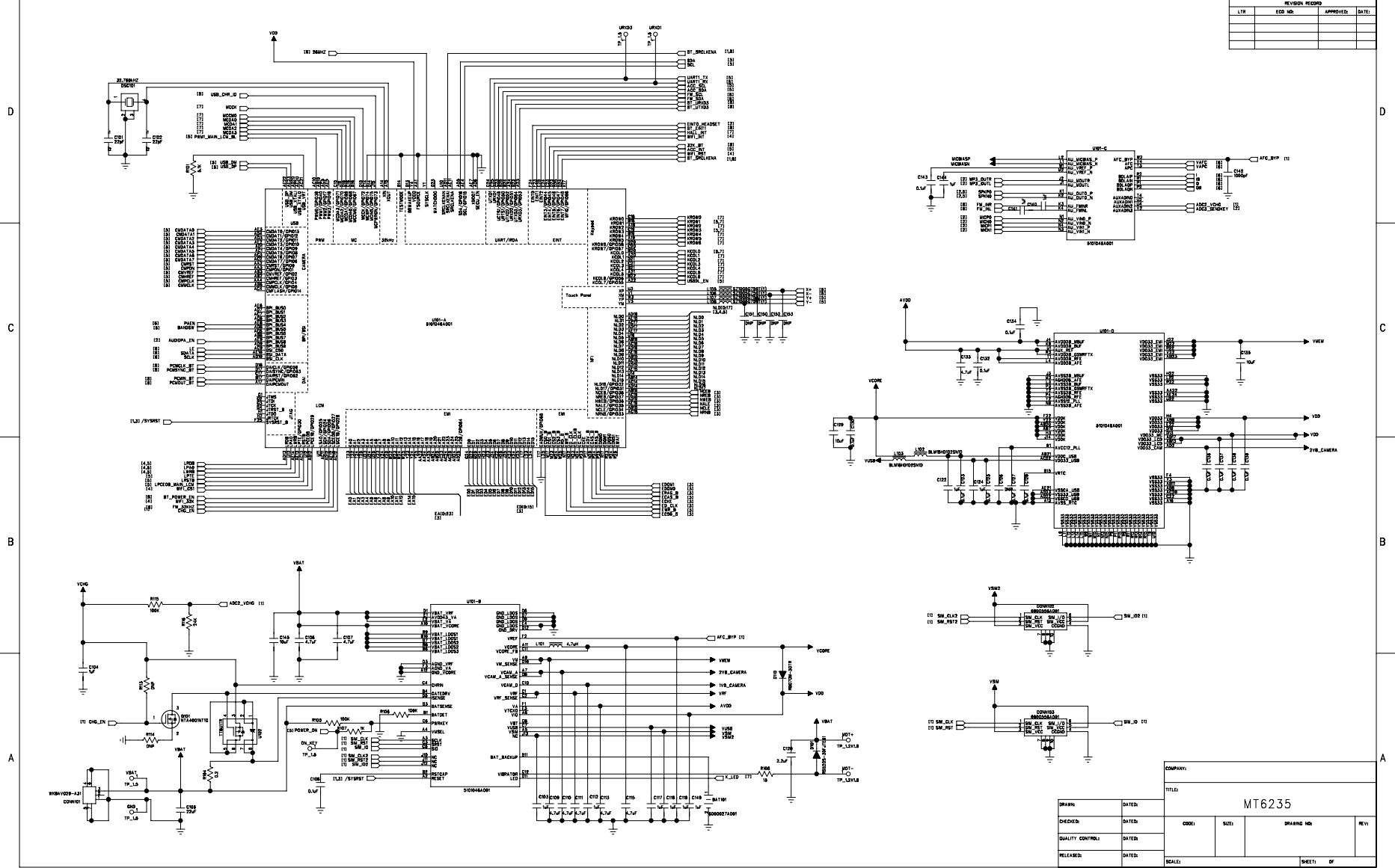

COMPANY:			
TITLE:			
MT6235			
DRAWN:	DATED:	CODE:	SIZE:
CHECKED:	DATED:	DRAWING NO.:	REV.:
QUALITY CONTROL:	DATED:		
RELEASED:	DATED:	SCALE:	SHEET: OF

6 5 4 3 2 1

REVISION RECORD			
LTN	ECO NO.	APPROVED:	DATE:

D D

C C

B B

A A

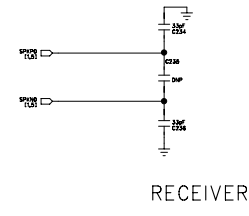
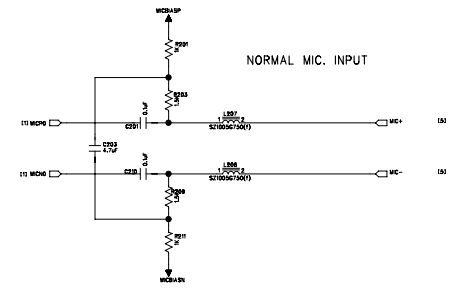

HEADSET / DIGITAL AUDIO

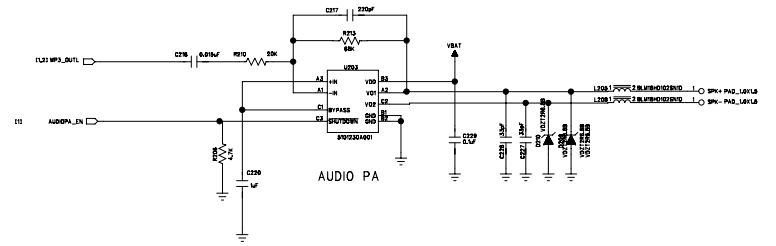
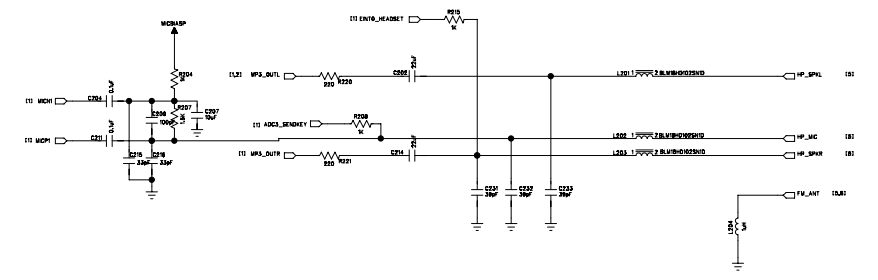

COMPANY:				
TITLE: AUDIO				
DRAWN:	DATED:	CODE:	SIZE:	DRAWING NO.:
CHECKED:	DATED:			REV:
QUALITY CONTROL:	DATED:			
RELEASED:	DATED:	SCALE:	SHEET: OF	

6

5

4

3

2

1

REVISION RECORD			
LTN	ECO NO.	APPROVED:	DATE

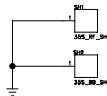
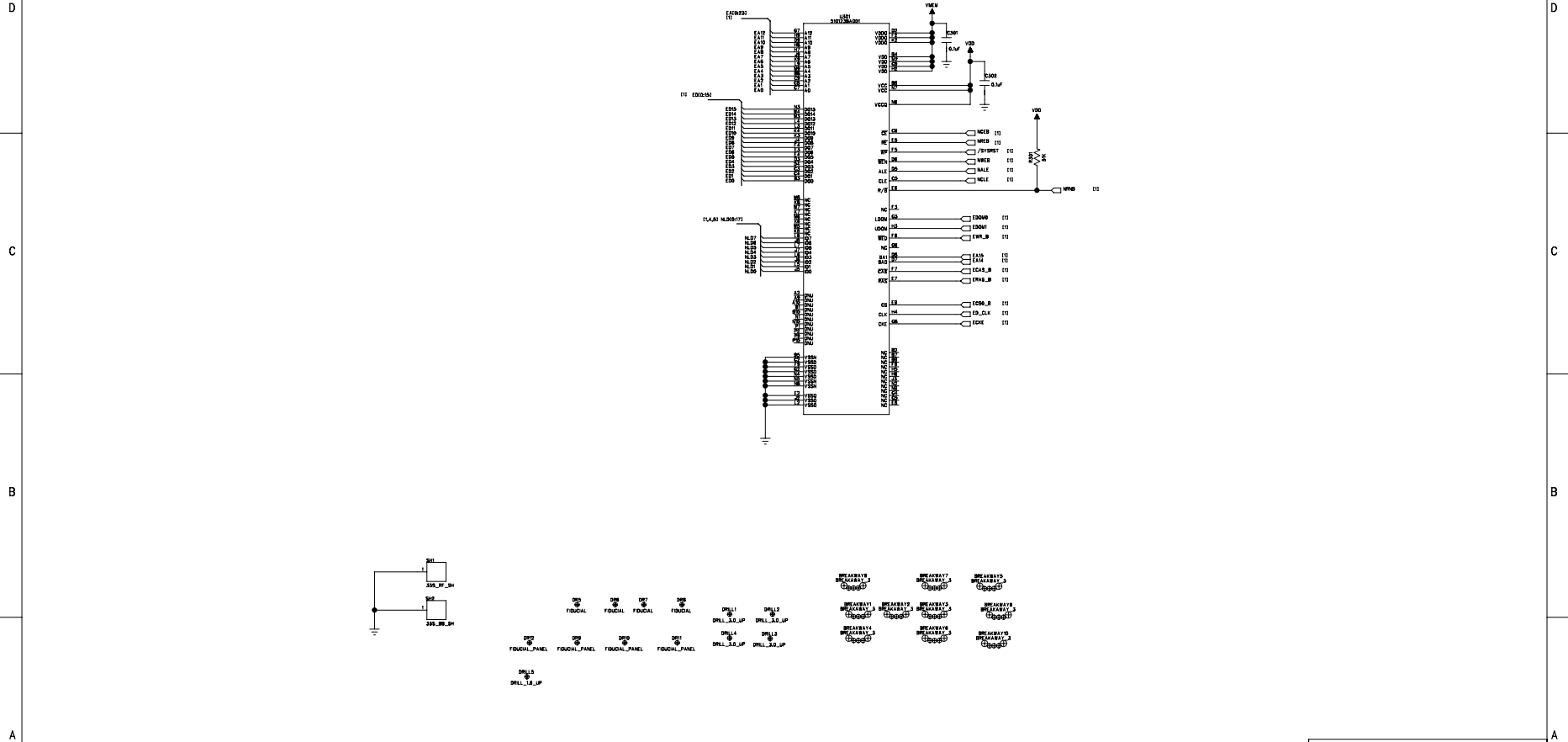

F0000
 F0001
 F0002
 F0003
 F0004
 F0005
 F0006
 F0007
 F0008
 F0009
 F000A
 F000B
 F000C
 F000D
 F000E
 F000F
 F0010
 F0011
 F0012
 F0013
 F0014
 F0015
 F0016
 F0017
 F0018
 F0019
 F001A
 F001B
 F001C
 F001D
 F001E
 F001F
 F0020
 F0021
 F0022
 F0023
 F0024
 F0025
 F0026
 F0027
 F0028
 F0029
 F002A
 F002B
 F002C
 F002D
 F002E
 F002F
 F0030
 F0031
 F0032
 F0033
 F0034
 F0035
 F0036
 F0037
 F0038
 F0039
 F003A
 F003B
 F003C
 F003D
 F003E
 F003F
 F0040
 F0041
 F0042
 F0043
 F0044
 F0045
 F0046
 F0047
 F0048
 F0049
 F004A
 F004B
 F004C
 F004D
 F004E
 F004F
 F0050
 F0051
 F0052
 F0053
 F0054
 F0055
 F0056
 F0057
 F0058
 F0059
 F005A
 F005B
 F005C
 F005D
 F005E
 F005F
 F0060
 F0061
 F0062
 F0063
 F0064
 F0065
 F0066
 F0067
 F0068
 F0069
 F006A
 F006B
 F006C
 F006D
 F006E
 F006F
 F0070
 F0071
 F0072
 F0073
 F0074
 F0075
 F0076
 F0077
 F0078
 F0079
 F007A
 F007B
 F007C
 F007D
 F007E
 F007F
 F0080
 F0081
 F0082
 F0083
 F0084
 F0085
 F0086
 F0087
 F0088
 F0089
 F008A
 F008B
 F008C
 F008D
 F008E
 F008F
 F0090
 F0091
 F0092
 F0093
 F0094
 F0095
 F0096
 F0097
 F0098
 F0099
 F009A
 F009B
 F009C
 F009D
 F009E
 F009F
 F00A0
 F00A1
 F00A2
 F00A3
 F00A4
 F00A5
 F00A6
 F00A7
 F00A8
 F00A9
 F00AA
 F00AB
 F00AC
 F00AD
 F00AE
 F00AF
 F00B0
 F00B1
 F00B2
 F00B3
 F00B4
 F00B5
 F00B6
 F00B7
 F00B8
 F00B9
 F00BA
 F00BB
 F00BC
 F00BD
 F00BE
 F00BF
 F00C0
 F00C1
 F00C2
 F00C3
 F00C4
 F00C5
 F00C6
 F00C7
 F00C8
 F00C9
 F00CA
 F00CB
 F00CC
 F00CD
 F00CE
 F00CF
 F00D0
 F00D1
 F00D2
 F00D3
 F00D4
 F00D5
 F00D6
 F00D7
 F00D8
 F00D9
 F00DA
 F00DB
 F00DC
 F00DD
 F00DE
 F00DF
 F00E0
 F00E1
 F00E2
 F00E3
 F00E4
 F00E5
 F00E6
 F00E7
 F00E8
 F00E9
 F00EA
 F00EB
 F00EC
 F00ED
 F00EE
 F00EF
 F00F0
 F00F1
 F00F2
 F00F3
 F00F4
 F00F5
 F00F6
 F00F7
 F00F8
 F00F9
 F00FA
 F00FB
 F00FC
 F00FD
 F00FE
 F00FF

F0000
 F0001
 F0002
 F0003
 F0004
 F0005
 F0006
 F0007
 F0008
 F0009
 F000A
 F000B
 F000C
 F000D
 F000E
 F000F
 F0010
 F0011
 F0012
 F0013
 F0014
 F0015
 F0016
 F0017
 F0018
 F0019
 F001A
 F001B
 F001C
 F001D
 F001E
 F001F
 F0020
 F0021
 F0022
 F0023
 F0024
 F0025
 F0026
 F0027
 F0028
 F0029
 F002A
 F002B
 F002C
 F002D
 F002E
 F002F
 F0030
 F0031
 F0032
 F0033
 F0034
 F0035
 F0036
 F0037
 F0038
 F0039
 F003A
 F003B
 F003C
 F003D
 F003E
 F003F
 F0040
 F0041
 F0042
 F0043
 F0044
 F0045
 F0046
 F0047
 F0048
 F0049
 F004A
 F004B
 F004C
 F004D
 F004E
 F004F
 F0050
 F0051
 F0052
 F0053
 F0054
 F0055
 F0056
 F0057
 F0058
 F0059
 F005A
 F005B
 F005C
 F005D
 F005E
 F005F
 F0060
 F0061
 F0062
 F0063
 F0064
 F0065
 F0066
 F0067
 F0068
 F0069
 F006A
 F006B
 F006C
 F006D
 F006E
 F006F
 F0070
 F0071
 F0072
 F0073
 F0074
 F0075
 F0076
 F0077
 F0078
 F0079
 F007A
 F007B
 F007C
 F007D
 F007E
 F007F
 F0080
 F0081
 F0082
 F0083
 F0084
 F0085
 F0086
 F0087
 F0088
 F0089
 F008A
 F008B
 F008C
 F008D
 F008E
 F008F
 F0090
 F0091
 F0092
 F0093
 F0094
 F0095
 F0096
 F0097
 F0098
 F0099
 F009A
 F009B
 F009C
 F009D
 F009E
 F009F
 F00A0
 F00A1
 F00A2
 F00A3
 F00A4
 F00A5
 F00A6
 F00A7
 F00A8
 F00A9
 F00AA
 F00AB
 F00AC
 F00AD
 F00AE
 F00AF
 F00B0
 F00B1
 F00B2
 F00B3
 F00B4
 F00B5
 F00B6
 F00B7
 F00B8
 F00B9
 F00BA
 F00BB
 F00BC
 F00BD
 F00BE
 F00BF
 F00C0
 F00C1
 F00C2
 F00C3
 F00C4
 F00C5
 F00C6
 F00C7
 F00C8
 F00C9
 F00CA
 F00CB
 F00CC
 F00CD
 F00CE
 F00CF
 F00D0
 F00D1
 F00D2
 F00D3
 F00D4
 F00D5
 F00D6
 F00D7
 F00D8
 F00D9
 F00DA
 F00DB
 F00DC
 F00DD
 F00DE
 F00DF
 F00E0
 F00E1
 F00E2
 F00E3
 F00E4
 F00E5
 F00E6
 F00E7
 F00E8
 F00E9
 F00EA
 F00EB
 F00EC
 F00ED
 F00EE
 F00EF
 F00F0
 F00F1
 F00F2
 F00F3
 F00F4
 F00F5
 F00F6
 F00F7
 F00F8
 F00F9
 F00FA
 F00FB
 F00FC
 F00FD
 F00FE
 F00FF

DRAWN:		DATED:		COMPANY:	
CHECKED:		DATED:		TITLE: MEMORY	
QUALITY CONTROL:		DATED:		CODE:	SIZE:
RELEASED:		DATED:		DRAWING NO.	
				REV:	
SCALE:				SHEET: OF	

6

5

4

3

2

1

REVISION RECORD			
LTN	ECO NO.	APPROVED:	DATE

D

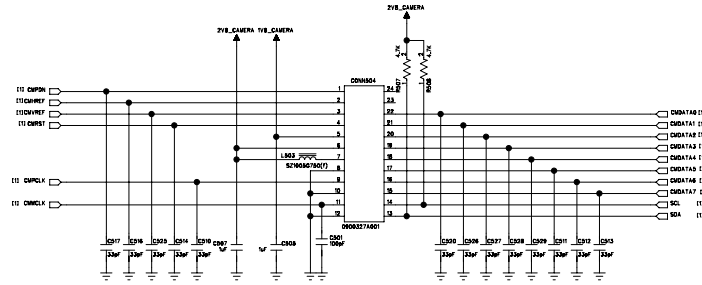
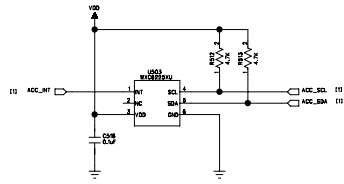

C

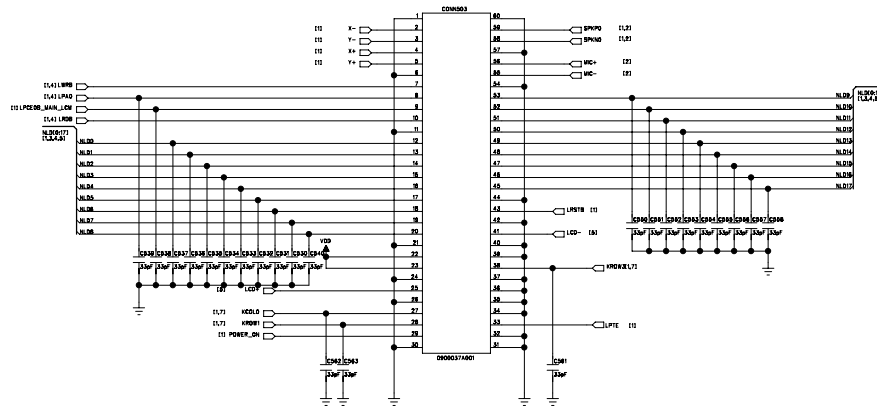
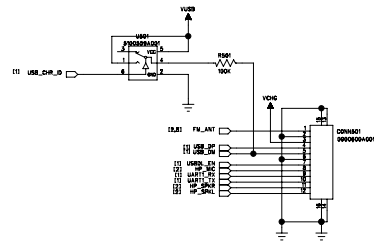

B

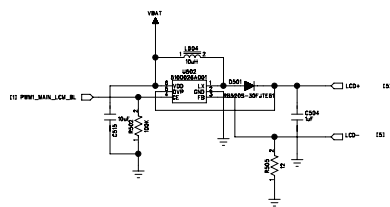

A

COMPANY:			
TITLE: LCM_SENSOR_IO			
DRAWN:	DATED:	CODE:	SIZE:
CHECKED:	DATED:	DRAWING NO.:	REV.:
QUALITY CONTROL:	DATED:		
RELEASED:	DATED:	SCALE:	SHEET: OF

D

C

B

A

6

5

4

3

2

1

REVISION RECORD			
LTN	ECD NO	APPROVED	DATE

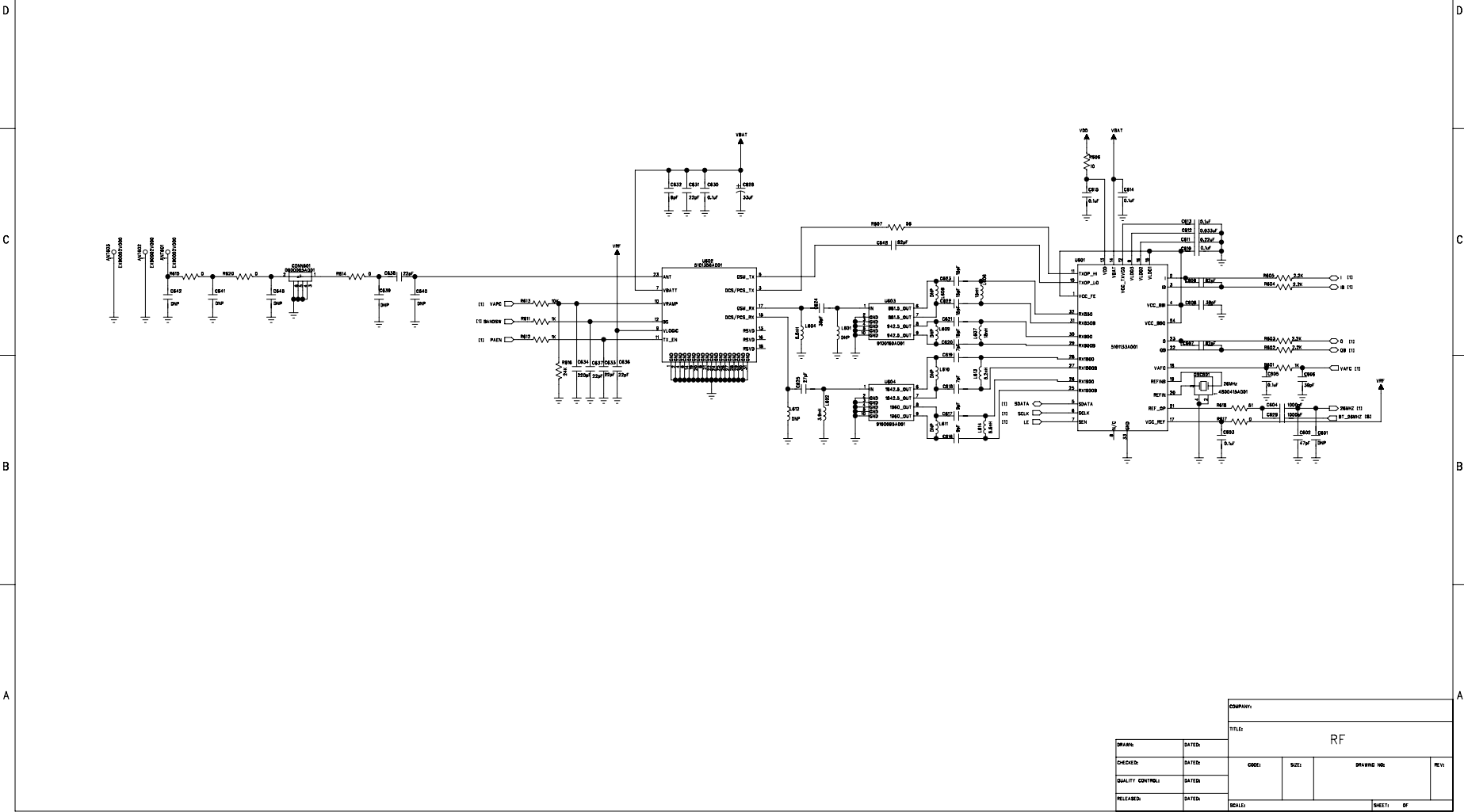

COMPANY:					
TITLE: RF					
DRAWN:	DATE:	CODE:	SIZE:	DRAWING NO:	REV:
CHECKER:	DATE:				
QUALITY CONTROL:	DATE:				
RELEASED:	DATE:	SCALE:	SHEET:		OF:

6

5

4

3

2

1

REVISION RECORD			
LT#	ECO NO.	APPROVED:	DATE:

D

C

B

A

D

C

B

A

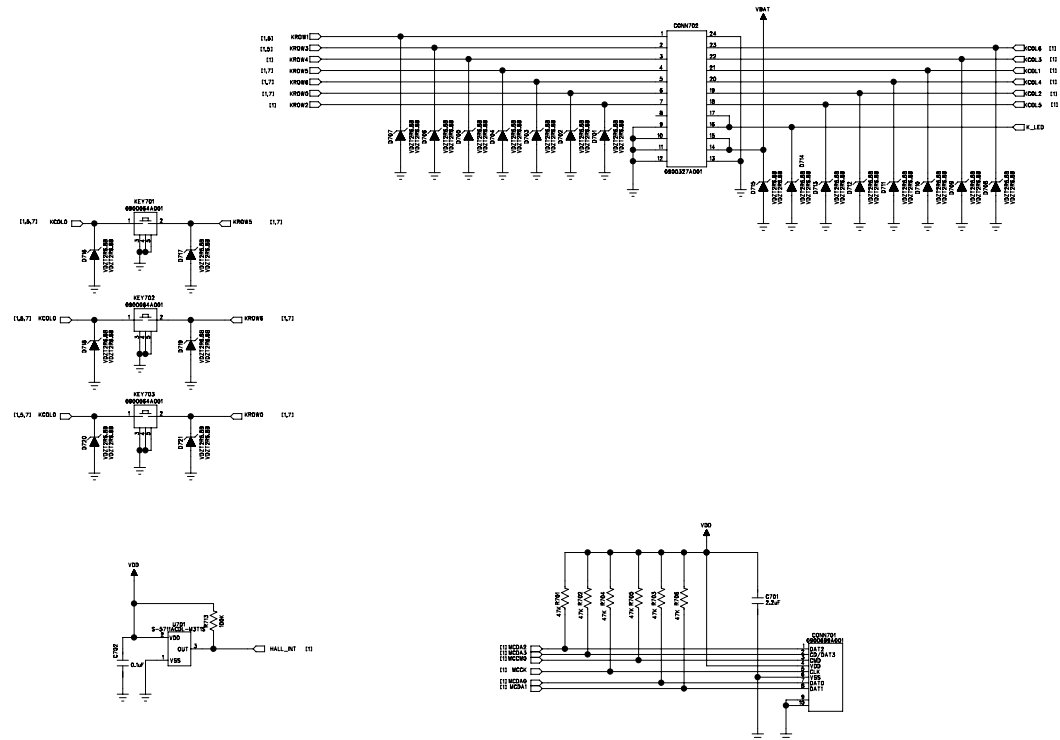

DRAWN:		DATED:		COMPANY:	
CHECKED:		DATED:		TITLE:	
QUALITY CONTROL:		DATED:		KEYPAD	
RELEASED:		DATED:		CODE:	SIZE:
				DRAWING NO.	
				REV.	
				SHEET: OF	

6

5

4

3

2

1

REVISION RECORD			
LT#	ECO NO.	APPROVED:	DATE:

D

C

B

A

D

C

B

A

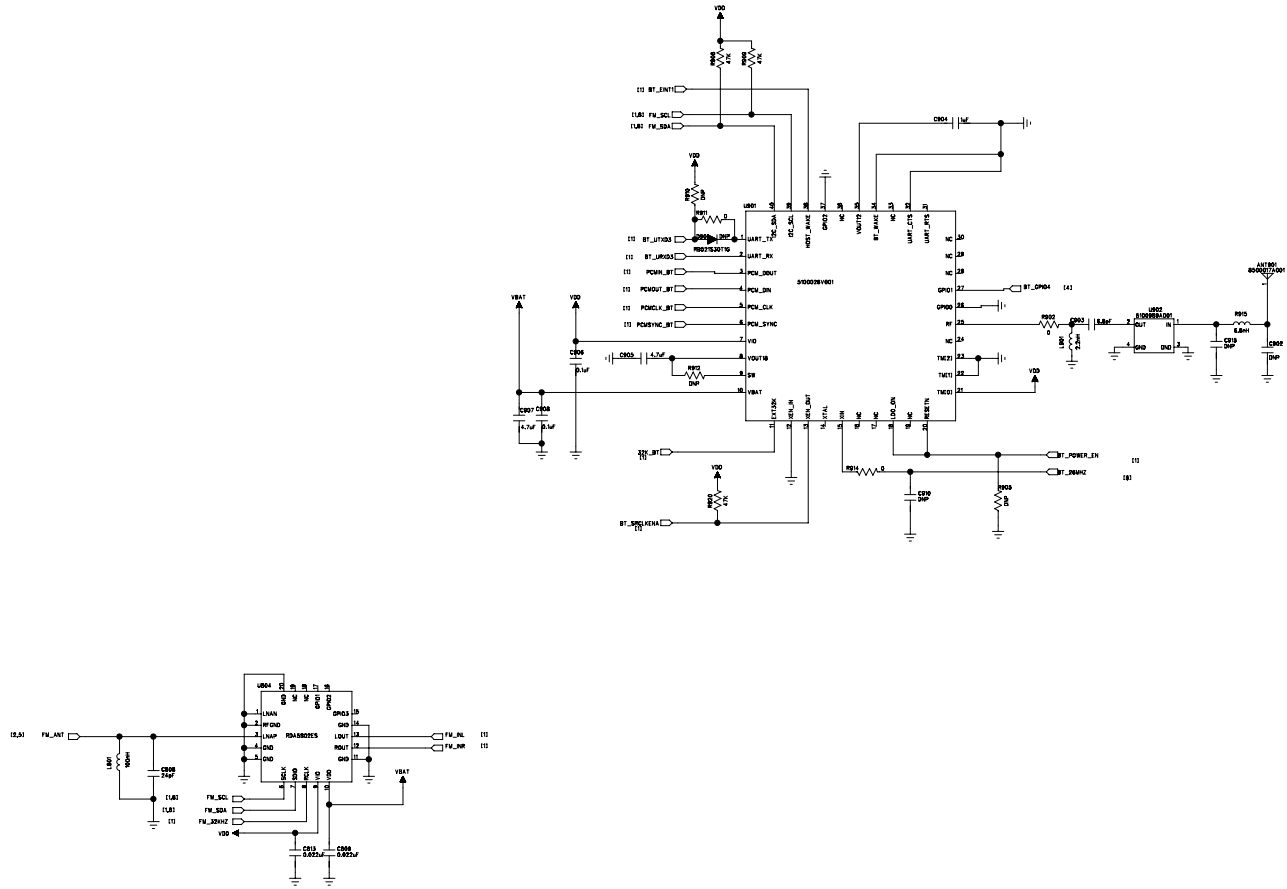

COMPANY:		TITLE:		BT_FM	
DRAWN:	DATED:	CODE:	SIZE:	DRAWING NO.:	REV.:
CHECKED:	DATED:	RELEASED:		DATE:	
QUALITY CONTROL:	DATED:	RELEASED:		DATE:	
RELEASED:	DATED:	RELEASED:		DATE:	