



FCC 47 CFR PART 24 SUBPART E

TEST REPORT

For

Applicant : Verykool USA Inc.

**Address : 4350 Executive Drive. Suite 100, San Diego, CA 92121,
USA**

Product Name : GSM Dual Band GPRS Digital Mobile Phone

Model Name : i705

Brand Name : verykool

FCC ID : WA6I705

Report No. : STS100305F3

Date of Issue : Mar. 27, 2010

Issued by : Shenzhen Super Test Service Technology Co., Ltd.

**Address : No.5, Nangshan 2nd Rd., North Hi-Tech Industrial Park ,Nanshan,
Shenzhen, Guangdong ,China**

Tel : 86-755-2795 8522

Fax : 86-755-2795 8022

The report consists 42 pages in total. It may be duplicated completely for legal use with the approval of the applicant. It should not be reproduced except in full, without the written approval of our laboratory. The client should not use it to claim product endorsement by STS. The test results in the report only apply to the tested sample. The test report shall be invalid without all the signatures of testing engineers, reviewer and approver.

TABLE OF CONTENTS

1. VERIFICATION OF CONFORMITY	4
2. GENERAL INFORMATION	5
2.1 Product Information	5
2.2 Objective	6
2.3 Test Standards and Results	6
2.4 Environmental Conditions	6
3. TEST FACILITY	7
4. TEST EQUIPMENT LIST	8
5. 47 CFR Part 2, Part 24E Requirements	9
5.1 General Information	9
5.1.1 Conducted Related Tests	9
5.1.2 Radiated Power and Spurious Emission Tests	9
5.1.3 Frequency Stability Test	10
6. FREQUENCIES	11
6.1. Requirement	11
6.2 Test Procedure	11
6.3 Test Result	11
7. Conducted RF Output Power	13
7.1 Requirement	13
7.2 Test Procedure	13
7.3 Test Result	13
8. OCCUPIED BANDWIDTH	16
8.1 Occupied Bandwidth Definition	16
8.2 Test Procedure	16
8.3 Test Result	16
9. CONDUCTED SPURIOUS EMISSION	19
9.1 Requirement	19
9.2 Test Procedure	19
9.3 Test Result	20
10. Transmitter Radiated Power (EIRP/ERP)	25
10.1 Requirement	25
10.2 Test Procedure	25
10.3 Test Result	25
11. Radiated Spurious Emission	26
11.1 Requirement	26
11.2 Test Procedure	26

11.3 Test Result 27

12. Frequency Stability 28

12.1 Frequency Stability Requirement..... 28

12.2 Test Procedure 28

12.3 Test Result..... 29

APPENDIX 1 30

PHOTOGRAPHS OF TEST SETUP..... 30

APPENDIX 2 33

PHOTOGRAPHS OF EUT 33

2. GENERAL INFORMATION

2.1 Product Information

EUT1- Mobile Phone	
Description:	GSM Dual Band GPRS Digital Mobile Phone
Model Name:	i705
Serial No.:	N/A
IMEI No.:	352676035000000
Frequency:	GSM 850MHz/1900MHz
Hardware Version:	v1.1
Software Version:	KAAI705FM_SAE_Sp_En_Fr_1.01.301
EUT2- Battery	
Description:	Lithium-ion Battery
Model Name:	KLB80N163
Brand Name:	verykool
Manufacturer:	SHENZHEN KONKA TELECOMMUNICATION TECHNOLOGY CO., LTD.
Capacitance:	800 mAh
Rated Voltage:	3.7V
Charge Limit:	4.2V
EUT3 – Power Supply	
Description:	Travel Charger
Model Name:	KTC-08USB-D
Brand Name:	verykool
Manufacturer:	SHENZHEN KONKA TELECOMMUNICATION TECHNOLOGY CO., LTD.
Rated Input:	AC 100-240V, 50/60HZ 150mA
Rated Output:	DC 5.0V, 500mA
Length USB cable:	1.00m

NOTE:

1. The normal configuration for the EUT is the Mobile Phone (MS) associated with ancillary equipments e.g. the Battery, Earphone, USB Cable and/or the AC Adapter (Charger).
2. The transmitter (Tx) frequency arrangement of the PCS 1900MHz band for the EUT can be represented with a formula $F(n)=1850.2+0.2*(n-512)$, $512 \leq n \leq 810$.
3. The normal, high and low voltage supply for the Battery of the EUT is separately 3.7V, 4.2V and 3.6V, which are specified by the applicant.
4. Please refer to Appendix I for the photographs of the EUT. For a more detailed features description about the EUT, please refer to User’s Manual.

2.2 Objective

The objective of the report is to perform tests according to 47 CFR Part 2, Part 24 for FCC ID Certification:

No.	Identity	Document Title
1	47 CFR Part 2 (10-1-05 Edition)	Frequency Allocations and Radio Treaty Matters; General Rules and Regulations
2	47 CFR Part 24 (10-1-05 Edition)	Personal Communications Services

2.3 Test Standards and Results

Test items and the results are as bellow:

No.	Rules	Test Type	Result	Date of Test
1	§2.106 §24.229	Frequencies	PASS	2010-03-27
2	§2.1046	Conducted RF Output Power at Antenna Terminal	PASS	2010-03-27
3	§2.1049	Occupied Bandwidth	PASS	2010-03-27
4	§2.1051 §2.1057 §24.238	Conducted Spurious Emission at Antenna Terminal	PASS	2010-03-27
5	§24.232	Transmitter Radiated Power (EIPR/ERP)	PASS	2010-03-27
6	§2.1053 §2.1057 §24.238	Radiated Spurious Emission	PASS	2010-03-27
7	§2.1055 §24.235	Frequency Stability	PASS	22010-03-27

Note: 1. The test result judgment is decided by the limit of measurement standard
 2. The information of measurement uncertainty is available upon the customer's request.

2.4 Environmental Conditions

During the measurement the environmental conditions were within the listed ranges:

- Temperature: 15-35°C
- Humidity: 30-60 %
- Atmospheric pressure: 86-106 kPa

3. TEST FACILITY

Test Site:	Most Technology Service Co., Ltd.
Location:	No.5, Langshan 2nd Rd., North Hi-Tech Industrial park , Nanshan, Shenzhen, Guangdong ,China
Description:	There is one 3m semi-anechoic an area test sites and two line conducted labs for final test. The Open Area Test Sites and the Line Conducted labs are constructed and calibrated to meet the FCC requirements in documents ANSI C63.4:2003 and CISPR 16 requirements. The FCC Registration Number is 490827 .
Site Filing:	The site description is on file with the Federal Communications Commission, 7435 Oakland Mills Road, Columbia, MD 21046.
Instrument Tolerance:	All measuring equipment is in accord with ANSI C63.4:2003 and CISPR 16 requirements that meet industry regulatory agency and accreditation agency requirement.
Ground Plane:	Two conductive reference ground planes were used during the Line Conducted Emission, one in vertical and the other in horizontal. The dimensions of these ground planes are as below. The vertical ground plane was placed distancing 40 cm to the rear of the wooden test table on where the EUT and the support equipment were placed during test. The horizontal ground plane projected 50 cm beyond the footprint of the EUT system and distanced 80 cm to the wooden test table. For Radiated Emission Test, one horizontal conductive ground plane extended at least 1m beyond the periphery of the EUT and the largest measuring antenna, and covered the entire area between the EUT and the antenna. It has no holes or gaps having longitudinal dimensions larger than one-tenth of a wavelength at the highest frequency of measurement up to 1GHz.

4. TEST EQUIPMENT LIST

Instrumentation: The following list contains equipment used at Most for testing. The equipment conforms to the CISPR 16-1 / ANSI C63.2 Specifications for Electromagnetic Interference and Field Strength Instrumentation from 10 kHz to 1.0 GHz or above.

No.	Equipment	Manufacturer	Model No.	S/N	Calibrator due date
1	Test Receiver	Rohde & Schwarz	ESCI	100492	2011/03/14
2	L.I.S.N.	Rohde & Schwarz	ENV216	100093	2011/03/14
3	Coaxial Switch	Anritsu Corp	MP59B	6200283933	2011/03/14
4	Terminator	Hubersuhner	50Ω	No.1	2011/03/14
5	RF Cable	SchwarzBeck	N/A	No.1	2011/03/14
6	Test Receiver	Rohde & Schwarz	ESPI	101202	2011/03/14
7	Bilog Antenna	Sunol	JB3	A121206	2011/03/14
8	Cable	SchwarzBeck	N/A	NO.1	2011/03/14
9	Cable	SchwarzBeck	N/A	NO.2	2011/03/14
10	Cable	SchwarzBeck	N/A	NO.3	2011/03/14
11	DC Power Filter	DuoJi	DL2×30B	N/A	2011/03/14
12	Single Phase Power Line Filter	DuoJi	FNF 202B30	N/A	2011/03/14
13	3 Phase Power Line Filter	DuoJi	FNF 402B30	N/A	2011/03/14
14	Test Receiver	Rohde & Schwarz	ESCI	100492	2011/03/14
15	Absorbing Clamp	Luthi	MDS21	3635	2011/03/14
16	Coaxial Switch	Anritsu Corp	MP59B	6200283933	2011/03/14
17	AC Power Source	Kikusui	AC40MA	LM003232	2011/03/14
18	Test Analyzer	Kikusui	KHA1000	LM003720	2011/03/14
19	Line Impedance Network	Kikusui	LIN40MA-PCR-L	LM002352	2011/03/14
20	ESD Tester	Kikusui	KES4021	LM003537	2011/03/14
21	EMC PRO System	EM Test	UCS-500-M4	V0648102026	2011/03/14
22	Signal Generator	IFR	2032	203002/100	2011/03/14
23	Amplifier	A&R	150W1000	301584	2011/03/14
24	CDN	FCC	FCC-801-M2-25	47	2011/03/14
25	CDN	FCC	FCC-801-M3-25	107	2011/03/14
26	EM Injection Clamp	FCC	F-203I-23mm	403	2011/03/14
27	RF Cable	MIYAZAKI	N/A	No.1/No.2	2011/03/14
28	Universal Radio Communication Tester	ROHDE&SCHWARZ	CMU200	0304789	2011/03/14
29	Telecommunication Antenna	European Antennas	PSA 75301R/170	0304213	2011/03/14
30	Spectrum Analyzer	Agilent	E4408	MY41440460	2011/03/14
31	Horn Antenna	SCHWARZBECK	BBHA9120D	D69250	2011/03/14

NOTE: Equipments listed above have been calibrated and are in the period of validation.

5. 47 CFR Part 2, Part 24E Requirements

5.1 General Information

5.1.1 Conducted Related Tests

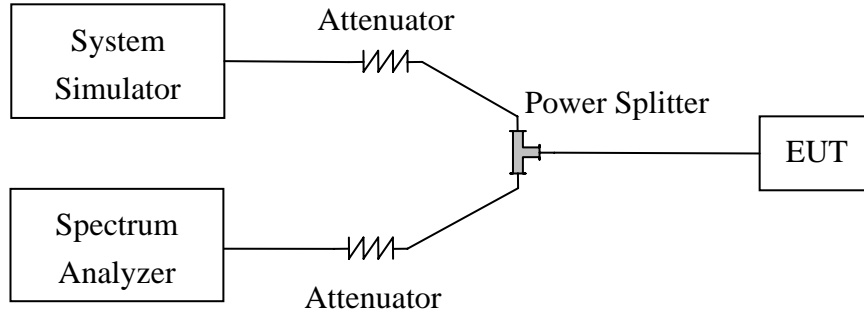

1. The EUT is coupled to the Spectrum Analyzer and the System Simulator with the suitable Attenuators through the Power Splitter; the path loss is calibrated to correct the reading.
2. The EUT is configured here as MS + Battery.
3. The EUT is commanded via the System Simulator (SS) to operate at the maximum output power i.e. Power Control Level (PCL) = 0 and Power Class = 1.
4. The BCCH number of the SS used here is 520. A communication link is established between the EUT and the SS.
5. The Spectrum Analyzer is set to max-peak detector function and maximum hold mode.

5.1.2 Radiated Power and Spurious Emission Tests

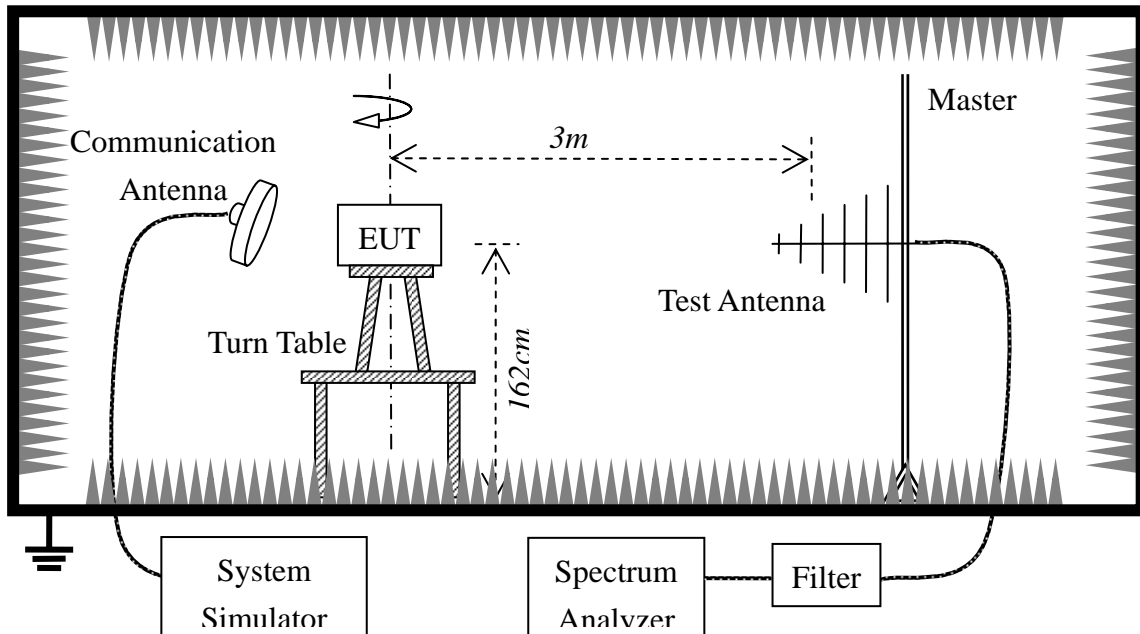

1. The test is performed in a full-Anechoic Chamber; the air loss of the site and the factors of the test system are pre-calibrated using the substitution method.
2. The EUT is configured as MS + Battery.
3. The EUT is placed on the vertical axis of a Turn Table 1.62 meters above the ground.
4. The Test Antenna is a bi-log one or a horn one, and the Test Antenna is at the same height as the EUT.
5. The EUT is commanded via the System Simulator (SS) to operate at the maximum output power i.e. Power Control Level (PCL) = 0 and Power Class = 1.
6. The BCCH number of the SS used here is 520. A communication link is established between the EUT and the SS.
7. The Spectrum Analyzer is set to max-peak detector function and maximum hold mode.

5.1.3 Frequency Stability Test

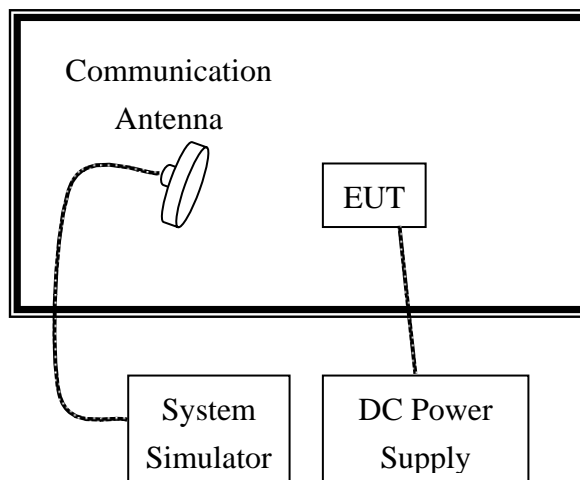

1. The test is performed in a Temperature Chamber.
2. The EUT is configured as MS + DC Power Supply.
3. The BCCH number of the SS used here is 520.

6. FREQUENCIES

6.1. Requirement

According to FCC §24.229, the frequencies available in the Broadband PCS services are listed as below, in accordance with the frequency allocations table of FCC §2.106.

(a) The following frequency blocks are available for assignment on an MTA basis:

Block A: 1850 - 1865MHz paired with 1930 - 1945MHz;

Block B: 1870 - 1885MHz paired with 1950 - 1965MHz.

(b) The following frequency blocks are available for assignment on a BTA basis:

Block C: 1895 - 1910 MHz paired with 1975 - 1990MHz;

Block D: 1865 - 1870 MHz paired with 1945 - 1950MHz;

Block E: 1885 - 1890 MHz paired with 1965 - 1970MHz;

Block F: 1890 - 1895 MHz paired with 1970 - 1975MHz.

6.2 Test Procedure

1. Perform test system setup as section 5.1.1.
2. The resolution bandwidth of the Spectrum Analyzer is set to at least one percent of the emission bandwidth of the fundamental emission of the transmitter, e.g. for GSM modulated signal (here used): $RBW=VBW=3kHz$, for CDMA modulated signal: $RBW=VBW=30kHz$.
3. The lowest and the highest channels are selected to perform tests respectively. Set the TCH number to 512 via the SS as the lowest channel.
4. Set the frequency range of the Spectrum Analyzer suitably to capture the waveform; search peak and mark it; finally record the plot.
5. Set the TCH number to 810 as the highest channel, then repeat step 4.

6.3 Test Result

The transmitter (Tx) frequency arrangement of the PCS 1900MHz band is represented with a formula

$F(n)=1850.2+0.2*(n-512)$, $512 \leq n \leq 810$. The frequencies of the lowest channel and the highest channel are listed as follows.

1. Plot when the TCH number set to 512:

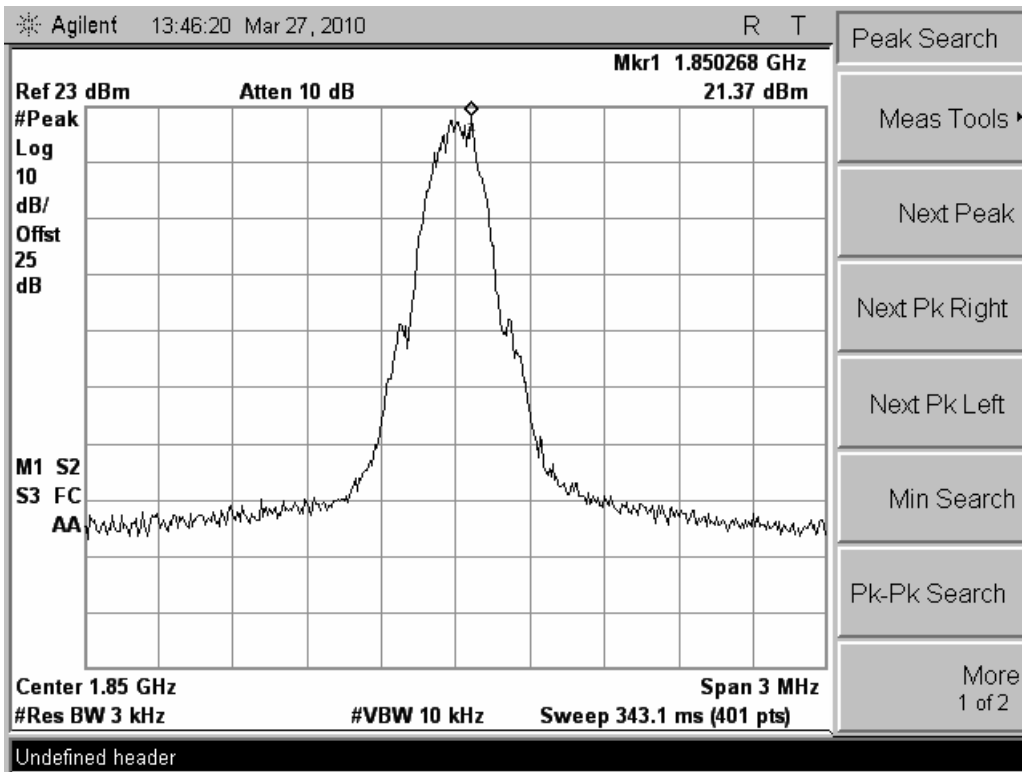

2. Plot when the TCH number set to 810:

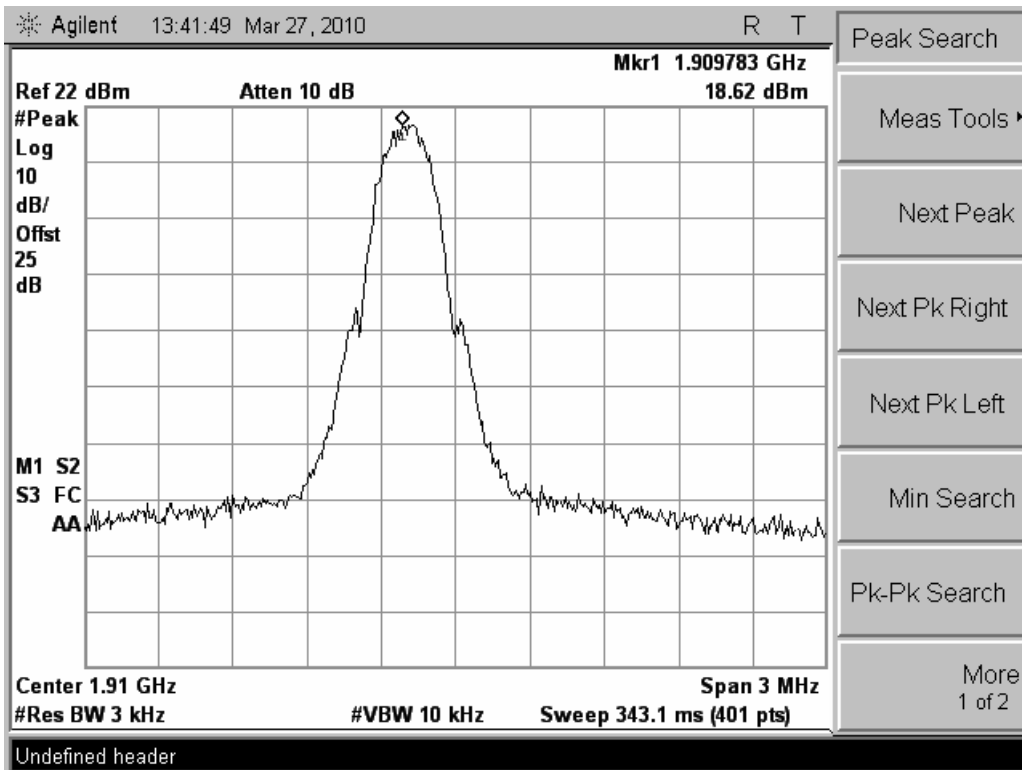

7. Conducted RF Output Power

7.1 Requirement

According to FCC §2.1046(a), for transmitters other than single sideband, independent sideband and controlled carrier radiotelephone, power output shall be measured at the RF output terminals when the transmitter is adjusted in accordance with the tune-up procedure to give the values of current and voltage on the circuit elements specified in §2.1033(c)(8). The electrical characteristics of the radio frequency load attached to the output terminals when this test is made shall be stated.

7.2 Test Procedure

1. Perform test system setup as section 5.1.1 (the radio frequency load attached to the EUT antenna terminal is 50Ω).
2. The resolution bandwidth of the Spectrum Analyzer is set to be comparable to the emission bandwidth of the transmitter, e.g. for GSM modulated signal (here used): RBW=VBW=1MHz, for CDMA modulated signal: RBW=VBW=3MHz.
3. The low, middle and the high channels are selected to perform tests respectively. Set the TCH number to 512 as the low channel.
4. Set the frequency range of the Spectrum Analyzer suitably to capture the waveform; search peak and mark it; finally record the peak and the plot.
5. Set the TCH number to 661 as the middle channel, then repeat step 4.
6. Set the TCH number to 810 as the high channel, then repeat step 4.

7.3 Test Result

No.	Channel Number	Frequency (MHz)	Measured Power		Rated Power	
			dBm	W	dBm	W
1	512	1850.2	27.26	0.532	30	1
2	661	1880.0	27.34	0.542	30	1
3	810	1909.8	28.98	0.791	30	1

1. Plot when the TCH number set to 512:

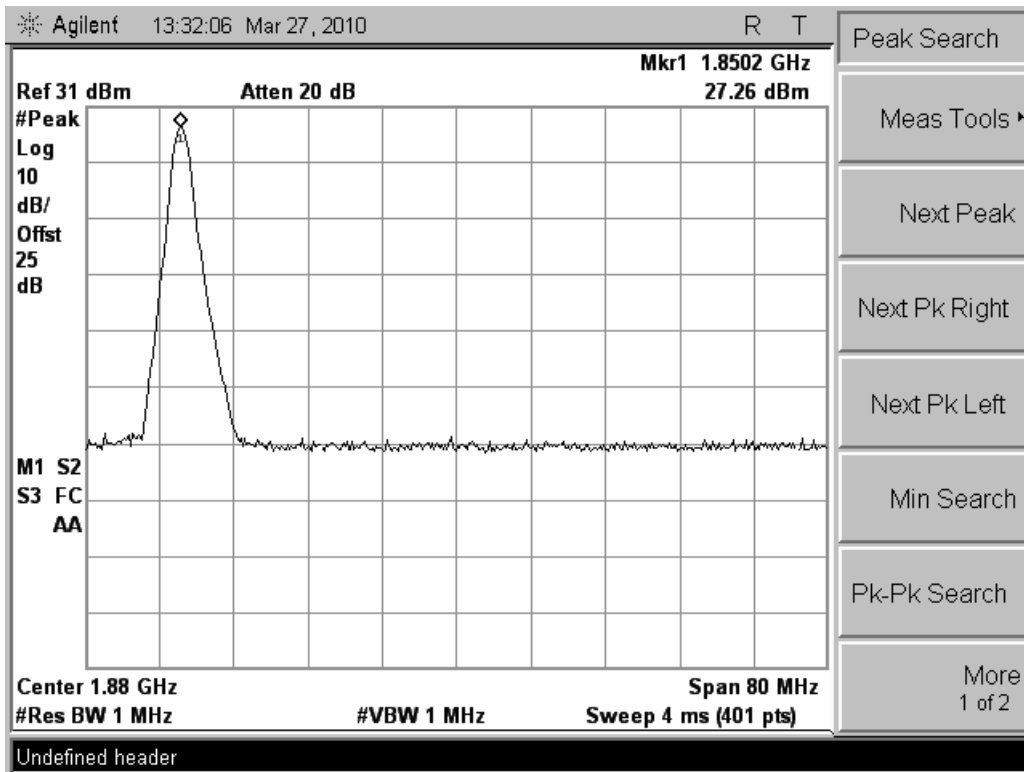

2. Plot when the TCH number set to 661:

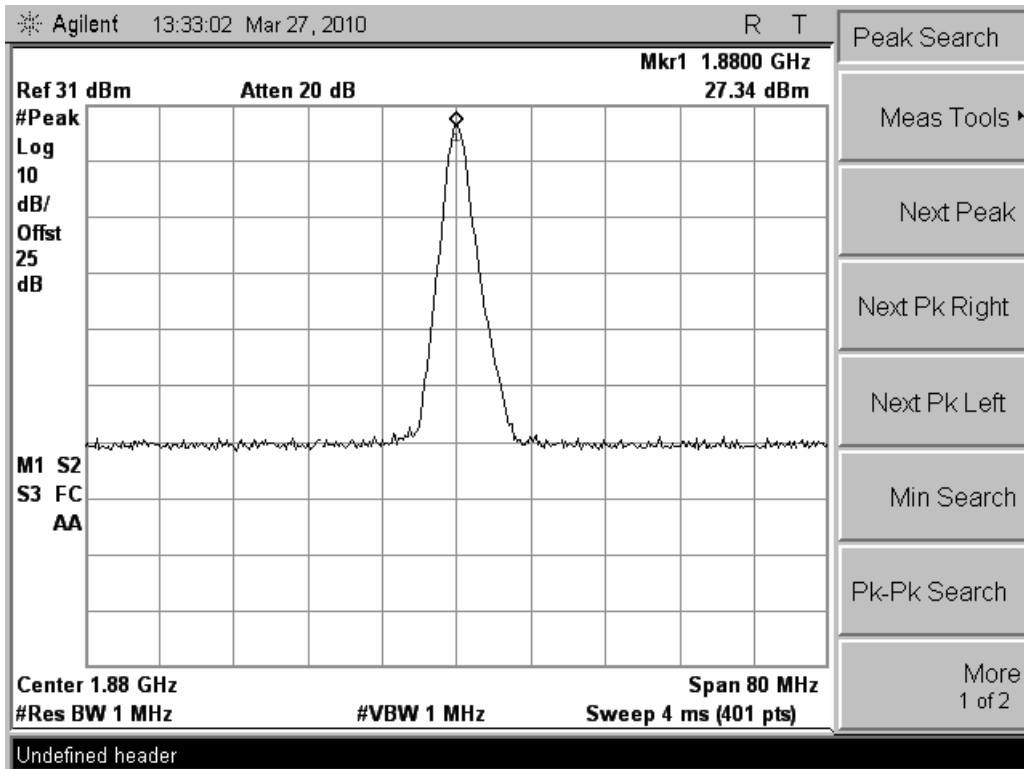

3. Plot when the TCH number set to 810:

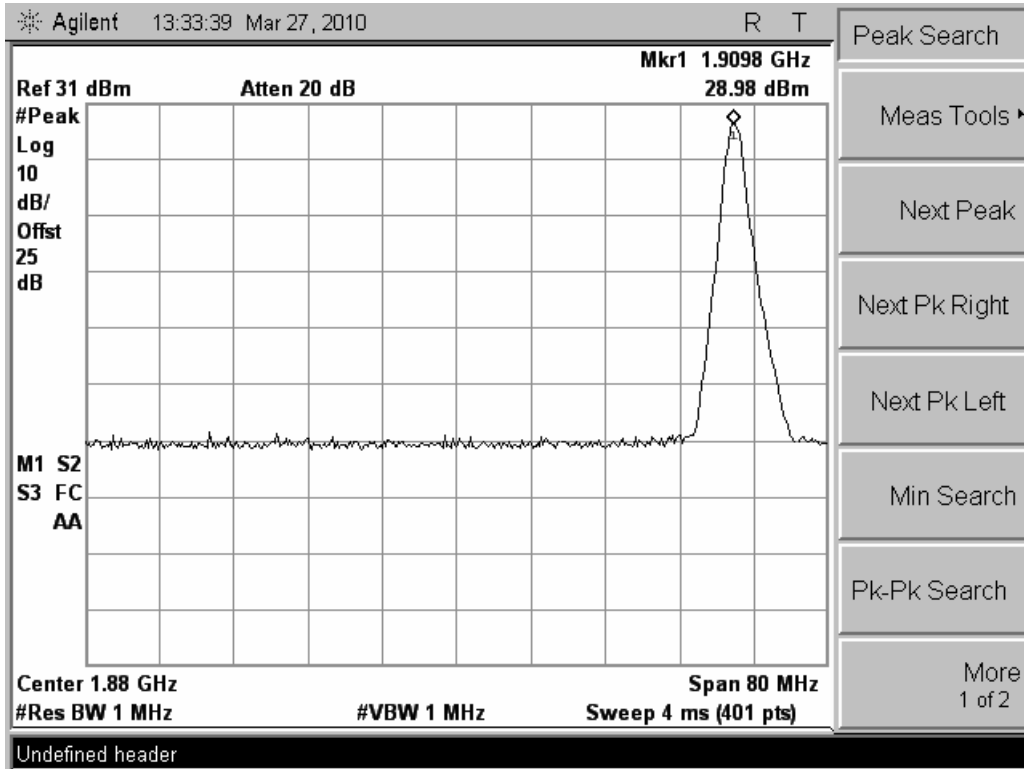

8. OCCUPIED BANDWIDTH

8.1 Occupied Bandwidth Definition

According to FCC §2.1049, the occupied bandwidth is the frequency bandwidth such that, below its lower and above its upper frequency limits, the mean powers radiated are each equal to 0.5 percent of the total mean power radiated by a given emission.

Occupied bandwidth is also known as the 99% emission bandwidth, or 20dB bandwidth ($10 \cdot \log 1\%$ is equal to 20dB) taking the total RF output power as reference.

8.2 Test Procedure

1. Perform test system setup as section 5.1.1
2. The resolution bandwidth of the Spectrum Analyzer is set to at least one percent of the emission bandwidth, e.g. for GSM modulated signal (here used): RBW=VBW=3 kHz, for CDMA modulated signal: RBW=VBW=30 kHz.
3. The low, middle and the high channels are selected to perform tests respectively. Set the TCH number to 512 as the low channel.
4. Set the frequency range of the Spectrum Analyzer suitably to capture the waveform; search peak; make a line whose value is 20dB lower than the peak; mark two points which the line intersected the waveform at; finally record the delta of the two points as the occupied bandwidth and the plot.
5. Set the TCH number to 661 as middle channel, then repeat step 4.
6. Set the TCH number to 810 as high channel, then repeat step 4.

8.3 Test Result

No.	Channel	Frequency (MHz)	Measured Occupied Bandwidth (kHz)
1	512	1850.2	278.0
2	661	1880.0	293.0
3	810	1909.8	300.0

1. Plot when the TCH number set to 512:

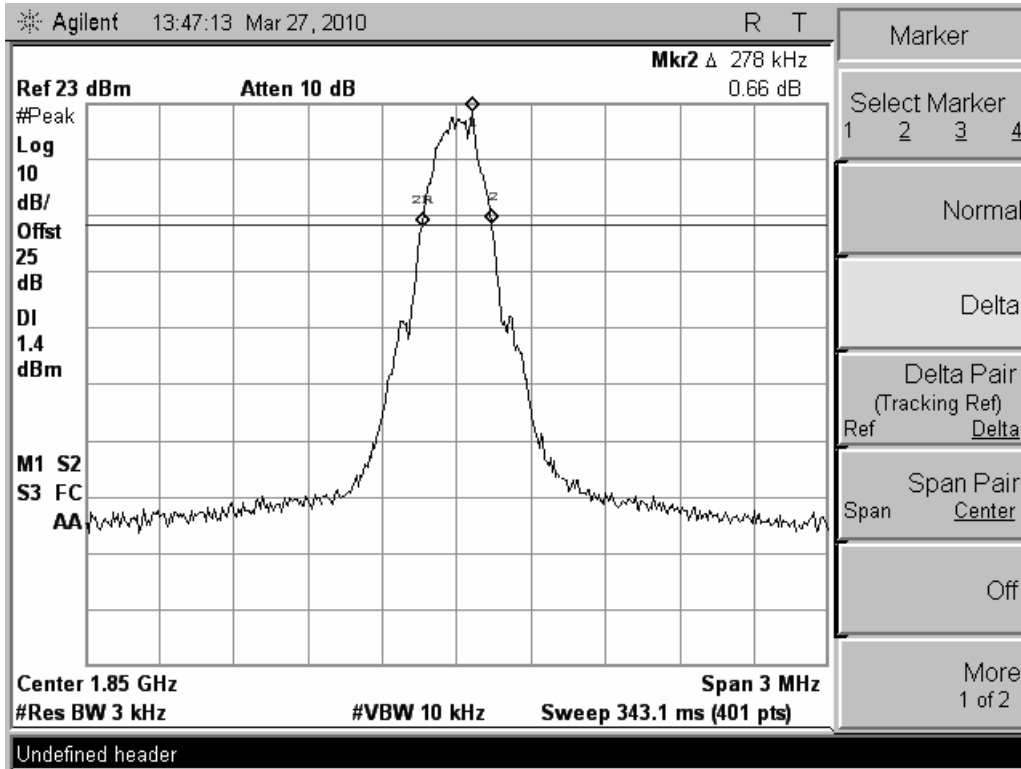

2. Plot when the TCH number set to 661:

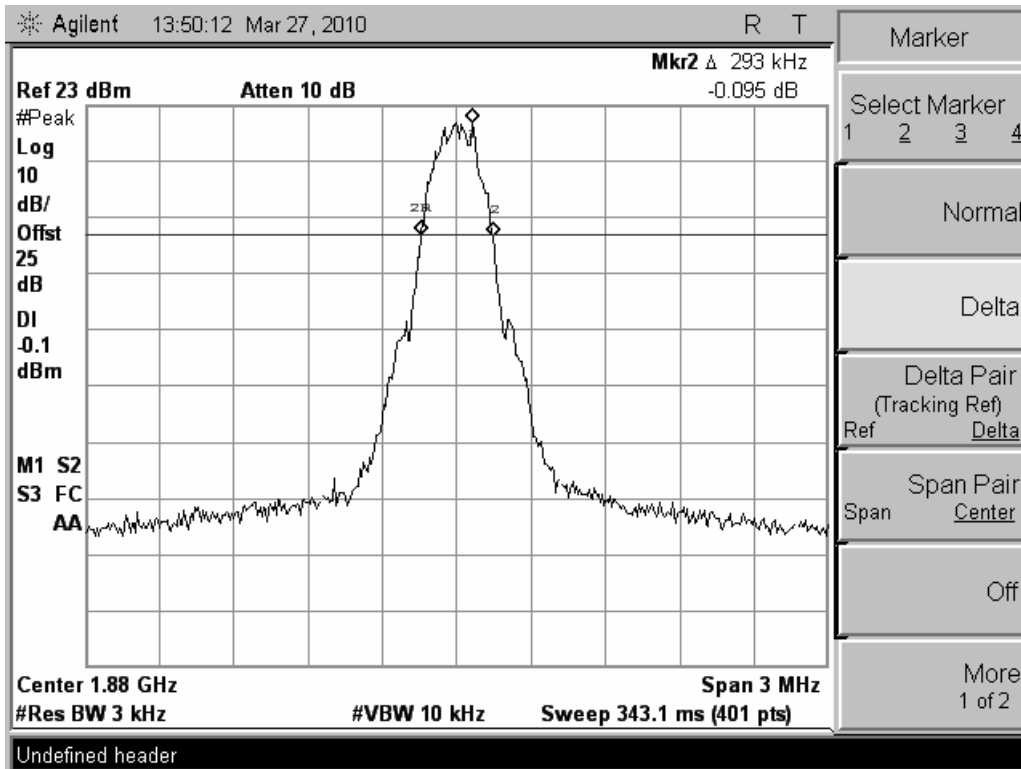

3. Plot when the TCH number set to 810:

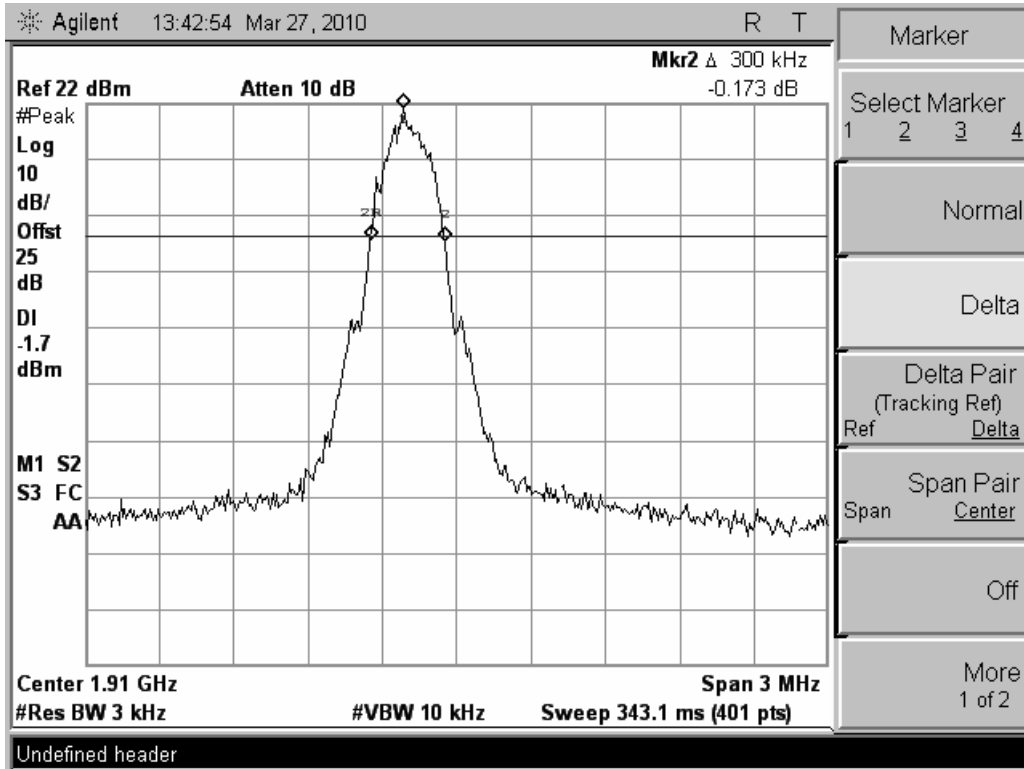

9. CONDUCTED SPURIOUS EMISSION

9.1 Requirement

1. According to FCC §24.238(a), the power of any emission outside of the authorized operating frequency ranges must be attenuated below the transmitting power (P) by a factor of at least $43+10*\log(P)$ dB. This calculated to be -13dBm.
2. According to FCC §24.238(b), in the 1MHz bands immediately outside and adjacent to the frequency block a resolution bandwidth of at least one percent of the emission bandwidth of the fundamental emission of the transmitter may be employed. Thus the 26dB emission bandwidth is measurement for showing compliance at the band-edge.

9.2 Test Procedure

1. Perform test system setup as section section 5.1.1.
2. Make a limit line whose value is -13dBm on the Spectrum Analyzer.
3. The lowest, middle and the highest channels are selected to perform tests respectively. Set the TCH number to 512 as the lowest channel.
4. Set the RBW of the Spectrum Analyzer to 1MHz, and the measuring frequency range from 9kHz to 10th harmonic of the fundamental frequency (here used 26.5GHz); mark the fundamental frequency and the harmonics thereof; finally record the harmonics and the plot. Note, the measuring frequency range can be divided into several parts to perform tests.
5. In the 1MHz bands immediately outside and adjacent to the frequency black, the RBW of the Spectrum Analyzer was set to at least one percent of the emission bandwidth of the fundamental emission of the transmitter, e.g. for GSM modulated signal (here used): RBW=3kHz, for CDMA modulated signal: RBW=30kHz.
6. Set the TCH number to 661 as the middle channel, then repeat step 4.
7. Set the TCH number to 810 as the highest channel, then repeat step 4 and 5.

9.3 Test Result

Table for the Harmonics and Plots for the Spurious Emission

1. Table for the Harmonics:

NOTE: “---” in the table following means that the emission power was too small to be measured and was at least 12dB below the limit.

No.	Frequency (MHz)	Emission Power (dBm)	Limit (dBm)
TCH number set to 512 (1850.20MHz)			
1	3690.00	-24.20	-13
2	5550.60	---	-13
3	7400.80	---	-13
4	9251.00	---	-13
5	11101.20	---	-13
6	12951.40	---	-13
7	14801.60	---	-13
8	16651.80	---	-13
9	18502.00	---	-13
TCH number set to 661 (1880.00MHz)			
10	3750.00	-24.50	-13
11	5640.00	---	-13
12	7520.00	---	-13
13	9400.00	---	-13
14	11280.00	---	-13
15	13160.00	---	-13
16	15040.00	---	-13
17	16920.00	---	-13
18	18800.00	---	-13
TCH number set to 810 (1909.80MHz)			
19	3810.00	-25.74	-13
20	5729.40	---	-13
21	7639.20	---	-13
22	9549.00	---	-13
23	11458.80	---	-13
24	13368.60	---	-13
25	15278.40	---	-13
26	17188.20	---	-13
27	19098.00	---	-13

2. Plot for Spurious Emission:

The measuring frequency range was from 9 kHz to 20GHz.

NOTE: The marker points are the Mobile Phone and/or System Simulator transmitting frequencies which should be ignored.

2.1 Plot when the TCH number set to 512:

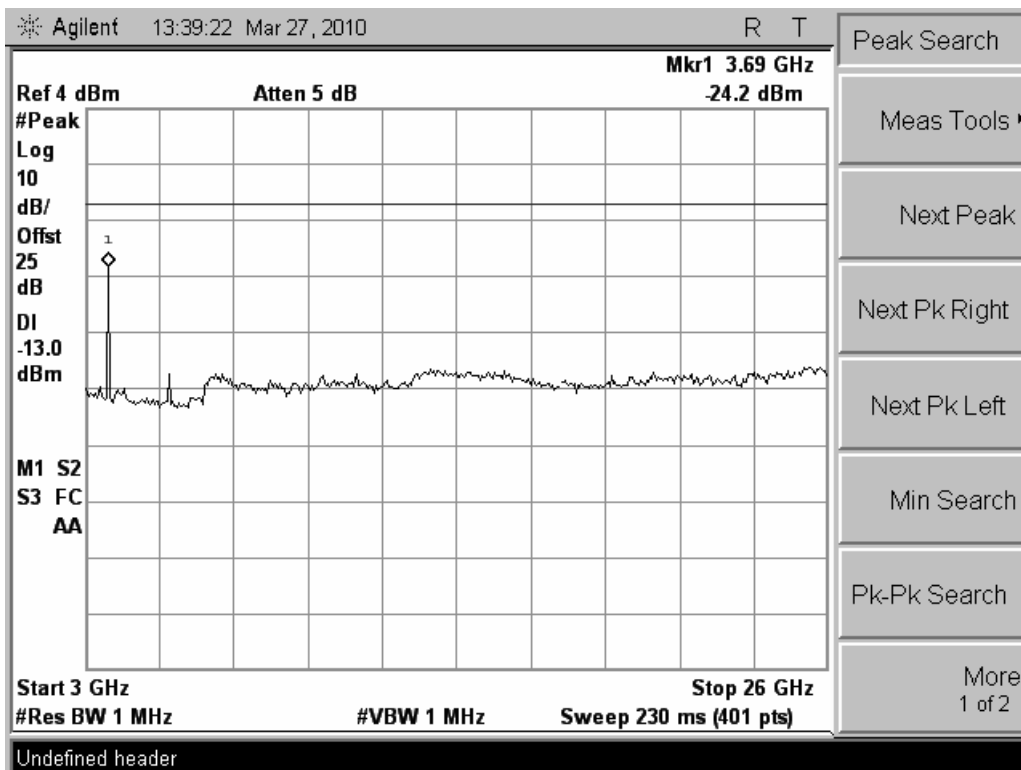
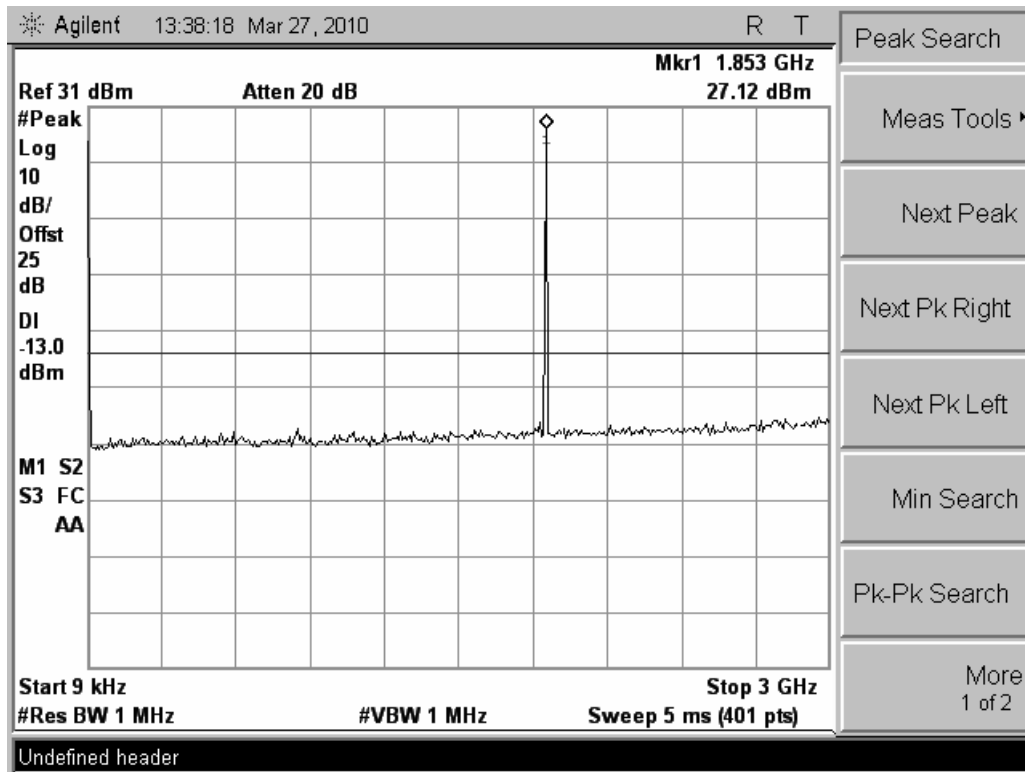

2.2 Plot when the TCH number set to 661:

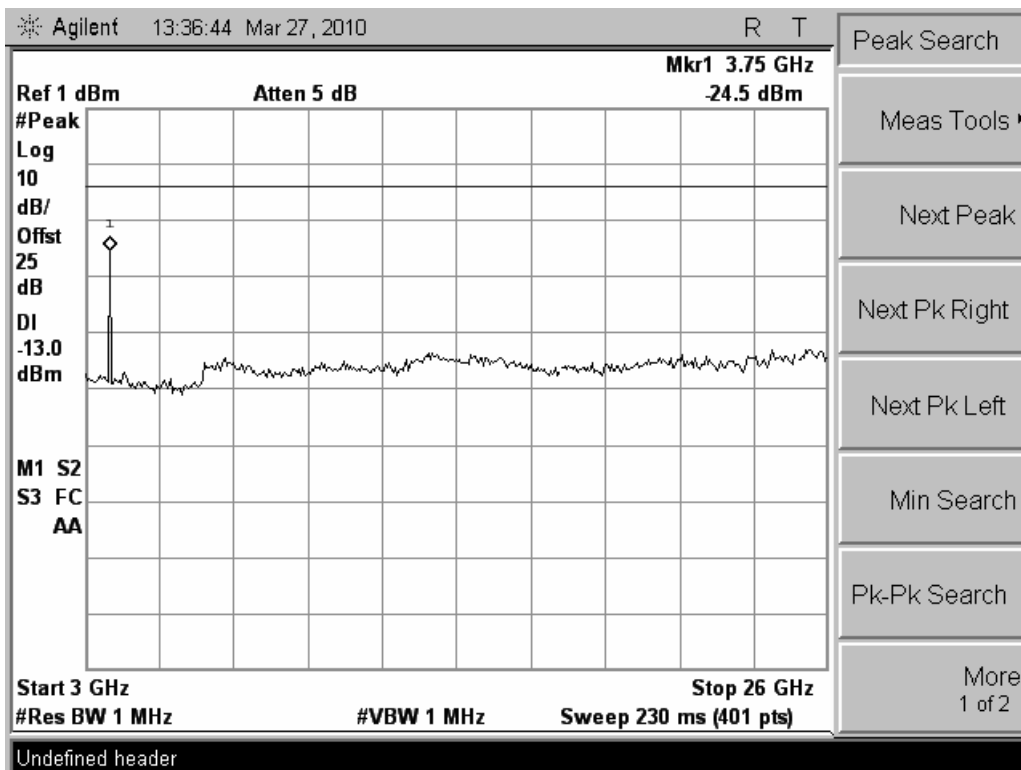
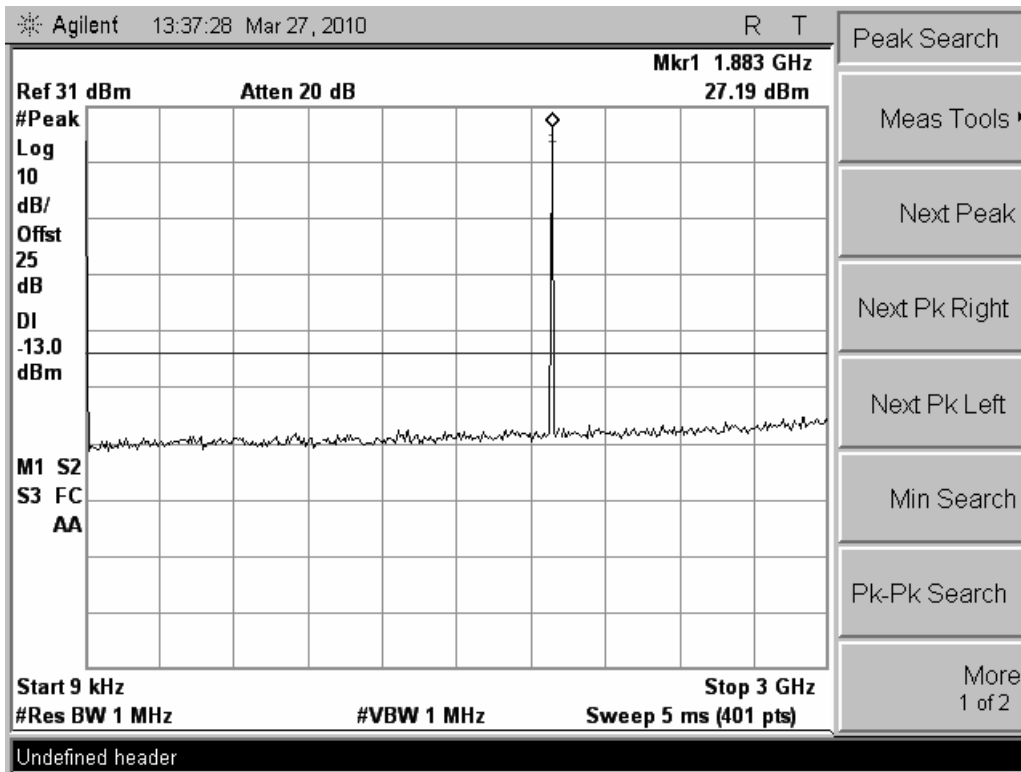

2.3 Plot when the TCH number set to 810:

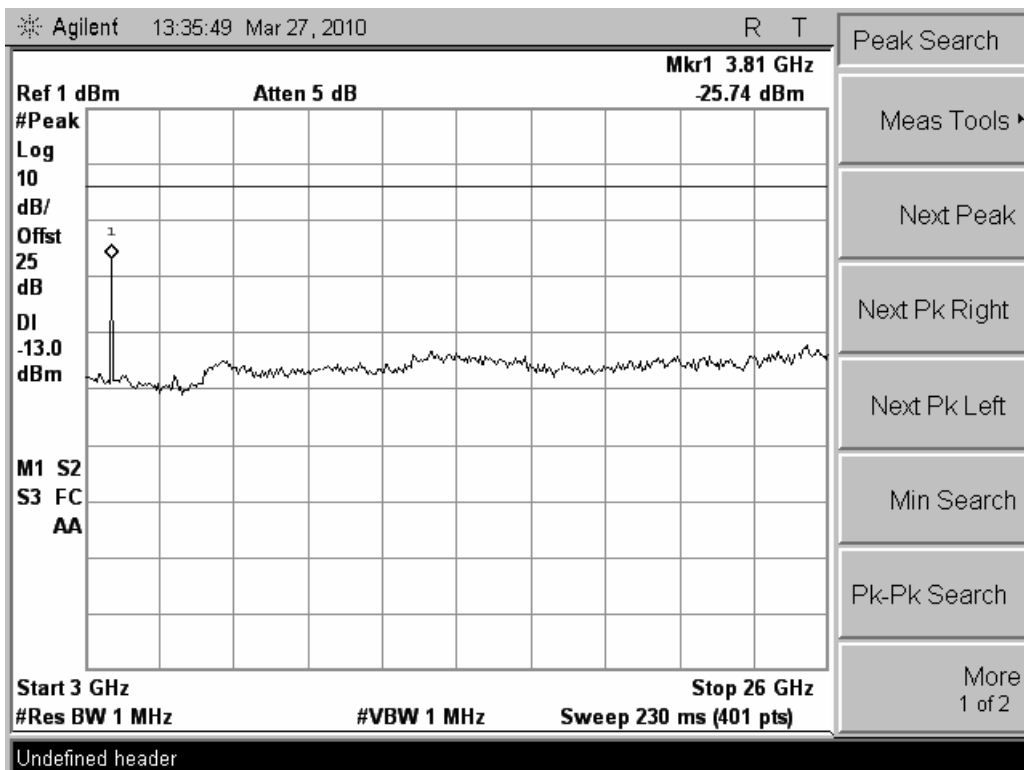
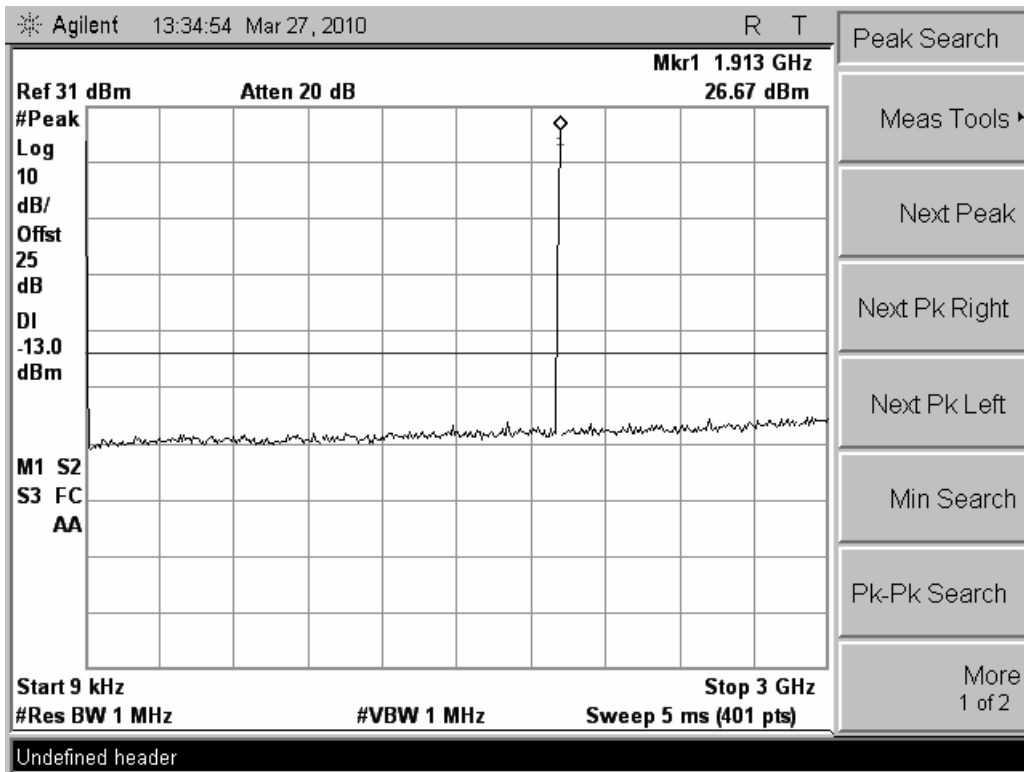

3. Plot for Band-edge

3.1 Plot when the TCH number set to 512:

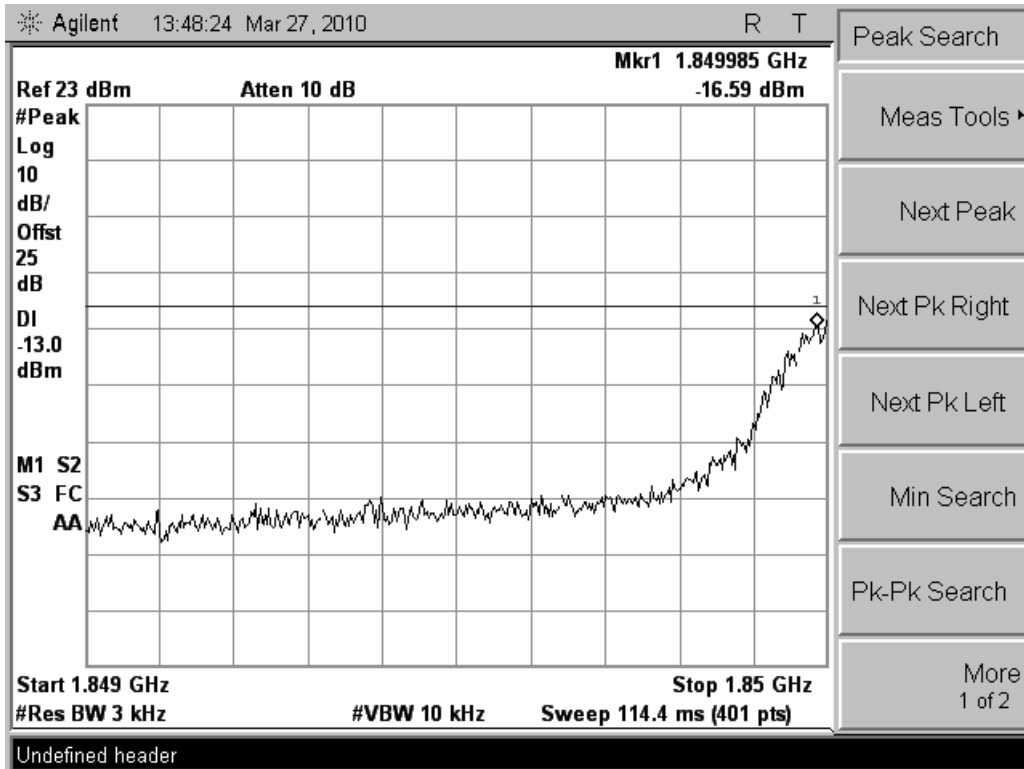

3.2 Plot when the TCH number set to 810:

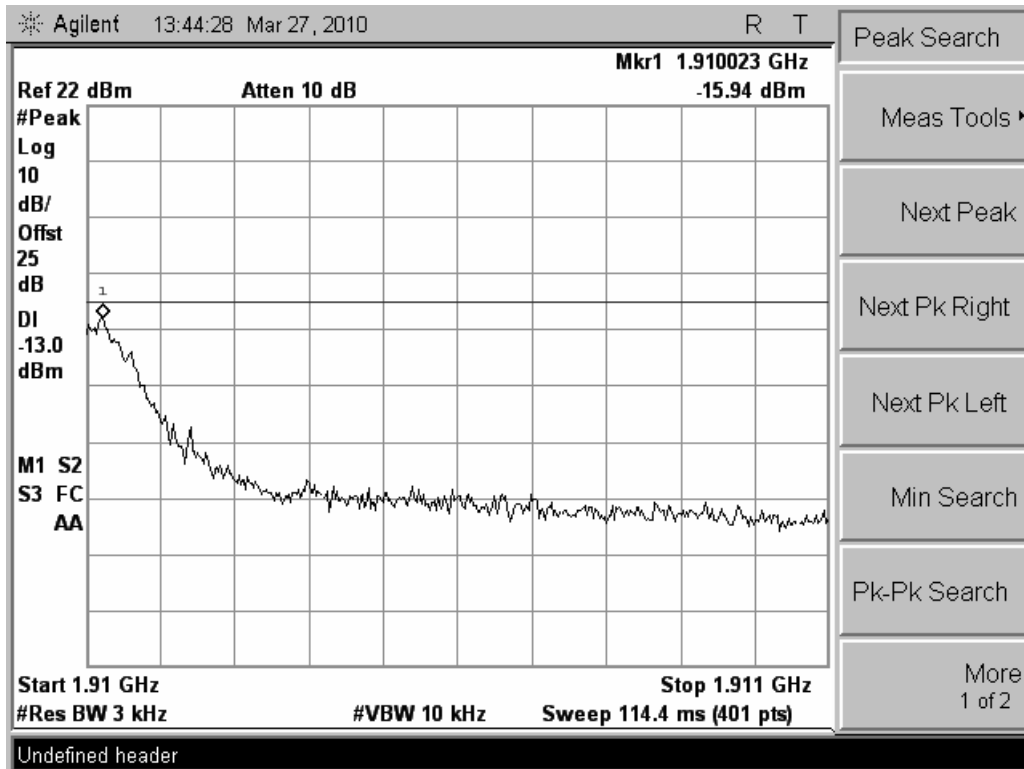

10. Transmitter Radiated Power (EIRP/ERP)

10.1 Requirement

According to FCC §24.232, the EIRP of Cellular mobile transmitters must not exceed 2 Watts (33dBm) e.i.r.p peak power.

10.2 Test Procedure

1. Perform test system setup as section 5.1.1.
2. The resolution bandwidth of the Spectrum Analyzer is set to be comparable to the emission bandwidth of the transmitter, e.g. for GSM modulated signal (here used): RBW=VBW=1MHz, for CDMA modulated signal: RBW=VBW=3MHz.
3. The low, middle and the high channels are selected to perform tests respectively. Set the TCH number to 512 as the low channel.
4. Employ the bi-log Test Antenna as the test system receiving antenna; set the polarization of the Test Antenna to be the same as that of the EUT transmitting antenna.
5. Set the frequency range of the Spectrum Analyzer suitably to capture the waveform; actuate the Turn Table to turn from 0 degrees to 360 degrees to find the maximum reading via the Spectrum Analyzer, mark the peak; finally record the peak and the plot.
6. Set the TCH number to 661 as the middle channel, then repeat step 5.
7. Set the TCH number to 810 as the high channel, then repeat step 5.

10.3 Test Result

No.	Channel	Frequency (MHz)	Measured EIRP		Limit EIRP		Result
			dBm	W	dBm	W	
1	512	1850.20	28.08	0.643	< 33.0	< 2	PASS
2	661	1880.00	28.11	0.647	< 33.0	< 2	PASS
3	810	1909.80	29.03	0.800	< 33.0	< 2	PASS

11. Radiated Spurious Emission

11.1 Requirement

According to FCC §24.238(a), the power of any emission outside of the authorized operating frequency ranges must be attenuated below the transmitting power (P) by a factor of at least $43+10*\log(P)$ dB. This calculated to be -13dBm.

11.2 Test Procedure

1. Perform test system setup as section 5.1.2.
2. Make a limit line whose value is -13dBm on the Spectrum Analyzer, and set the RBW of the Spectrum Analyzer to 1MHz.
3. The low, middle and the high channels are selected to perform tests respectively. Set the TCH number to 512 as the low channel.
4. Employ the bi-log Test Antenna as the test system receiving antenna and set the frequency range of the Spectrum Analyzer from 30MHz to 3GHz.
5. The measurement is performed with the Test Antenna at both horizontal and vertical polarization respectively. Set the polarization of the Test Antenna to be horizontal.
6. Actuate the Turn Table to turn from 0 degrees to 360 degrees to find the maximum reading via the Spectrum Analyzer, mark the fundamental frequency and the harmonics thereof, after then record the harmonics and the plot.
7. Set the polarization of the Test Antenna to be vertical, then repeat step 6.
8. Employ the horn Test Antenna as the test system receiving antenna and set the frequency range of the Spectrum Analyzer from 3GHz to 10th harmonic of the fundamental frequency (here used 10GHz), then repeat step 5 to 7.
9. Set the TCH number to 661 as the middle channel, then repeat step 4 to 8.
10. Set the TCH number to 810 as the high channel, then repeat step 4 to 8.

11.3 Test Result

Table for the Harmonics

NOTE: “---” in the table following means that the emission power was too small to be measured and was at least 12dB below the limit.

No.	Frequency (MHz)	Emission Power (dBm)		Limit (dBm)
		Test Antenna Vertical	Test Antenna Horizontal	
TCH number set to 512 (1850.20MHz)				
1	3700.40	-31.16	-38.65	-13
2	5550.60	---	---	-13
3	7400.80	---	---	-13
4	9251.00	---	---	-13
5	11101.20	---	---	-13
6	12951.40	---	---	-13
7	14801.60	---	---	-13
8	16651.80	---	---	-13
9	18502.00	---	---	-13
TCH number set to 661 (1880.0MHz)				
10	3760.00	-33.20	-39.82	-13
11	5640.00	---	---	-13
12	7520.00	---	---	-13
13	9400.00	---	---	-13
14	11280.00	---	---	-13
15	13160.00	---	---	-13
16	15040.00	---	---	-13
17	16920.00	---	---	-13
18	18800.00	---	---	-13
TCH number set to 810 (1909.80MHz)				
19	3819.60	-30.59	-38.12	-13
20	5729.40	---	---	-13
21	7639.20	---	---	-13
22	9549.00	---	---	-13
23	11458.80	---	---	-13
24	13368.60	---	---	-13
25	15278.40	---	---	-13
26	17188.20	---	---	-13
27	19098.00	---	---	-13

12. Frequency Stability

12.1 Frequency Stability Requirement

According to FCC §24.235, the frequency stability shall be sufficient to ensure that the fundamental emission stays within the authorized frequency block.

According to FCC §2.1055, the test conditions are:

(a) Temperature:

The temperature is varied from -30°C to $+50^{\circ}\text{C}$ at intervals of not more than 10°C .

(b) Primary Supply Voltage:

For hand carried battery powered equipment, the primary supply voltage is reduced to the battery operating end point which shall be specified by the manufacture. The supply voltage shall be measured at the input to the cable normally provided with the equipment, or at the power supply terminals if cables are not normally provided.

12.2 Test Procedure

1. Perform test system setup as section 5.1.3.
2. Set the voltage of the DC Power Supply to normal supply voltage (here used 3.7V) and the temperature of the Temperature Chamber to vary from -30°C to $+50^{\circ}\text{C}$ at intervals of 10°C .
3. At each temperature level, the EUT is powered off and kept in the Temperature Chamber for two hours. 4. After sufficient stabilization, turn on the EUT, command it via the System Simulator (SS) to operate at the maximum output power i.e. Power Control Level (PCL) = 0 and Power Class = 1, and then establish a communication link between the EUT and the SS.
5. The low, middle and the high channels are selected to perform tests respectively. Set the TCH number to 512 as the low channel.
6. The frequency deviation is measured (directly read from the SS, which can report the parameter) within three minutes.
7. Set the TCH number to 661 as the middle channel, then repeat step 5.
8. Set the TCH number to 810 as the high channel, then repeat step 5.
9. Adjust the temperature of the Temperature Chamber as specified in step 2, then repeat step 3 to 7.
10. Set the voltage of the DC Power Supply to high extreme supply voltage (here used 4.2V) and the temperature of the Temperature Chamber to normal (here used $+22^{\circ}\text{C}$), then repeat step 3 to 8.
11. Set the voltage of the DC Power Supply to low extreme supply voltage (here used 3.6V) and the temperature of the Temperature Chamber to normal (here used $+22^{\circ}\text{C}$), then repeat step 3 to 8.

12.3 Test Result

No.	Test Conditions		Frequency Deviation (Hz) at Channels Used			
	Voltage	Temperature	512	661	810	Limit (± 2.5 ppm)
1	V-nor	-30°C	-46.24	-43.11	-42.58	(a) ± 1850 Hz at 512 Channel (b) ± 1880 Hz at 661 Channel (c) ± 1910 Hz at 810 Channel
2		-20°C	-40.16	-42.72	-44.20	
3		-10°C	-35.43	-39.57	-37.41	
4		0°C	-35.02	-37.39	-34.82	
5		+10°C	-26.98	-30.54	-27.76	
6		+20°C	-27.13	-29.88	-33.43	
7		+30°C	-35.43	-35.53	-36.88	
8		+40°C	-33.35	-36.67	-39.90	
9		+50°C	-35.71	-40.00	-37.34	
10	V-high	+22°C	-40.90	-35.87	-34.85	
11	V-low	+22°C	-36.04	-37.54	-40.11	

Result: PASS

APPENDIX 1
PHOTOGRAPHS OF TEST SETUP

CONDUCTED TEST SETUP



RADIATED EMISSION TEST SETUP

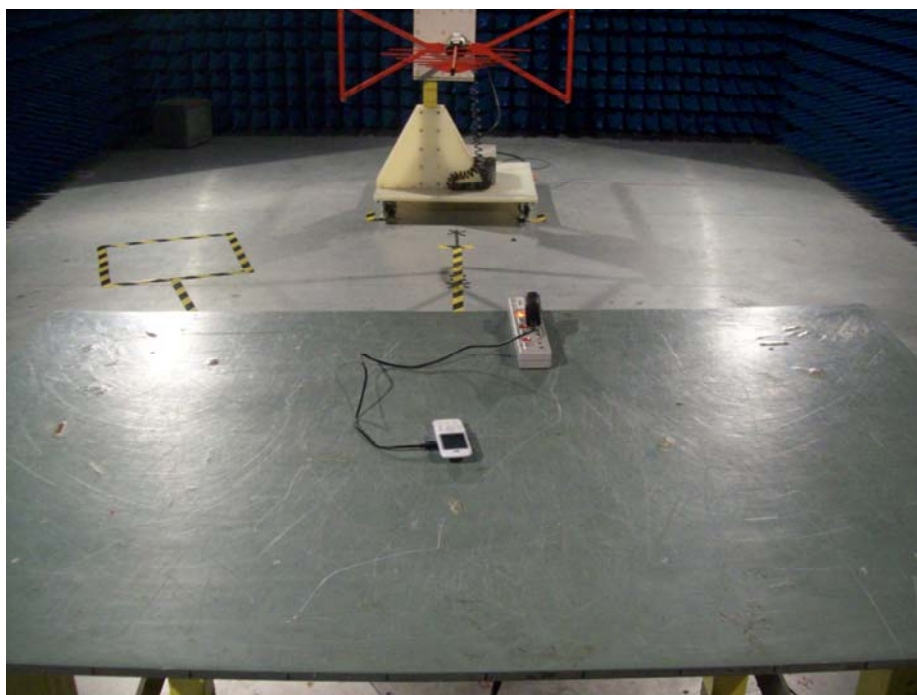

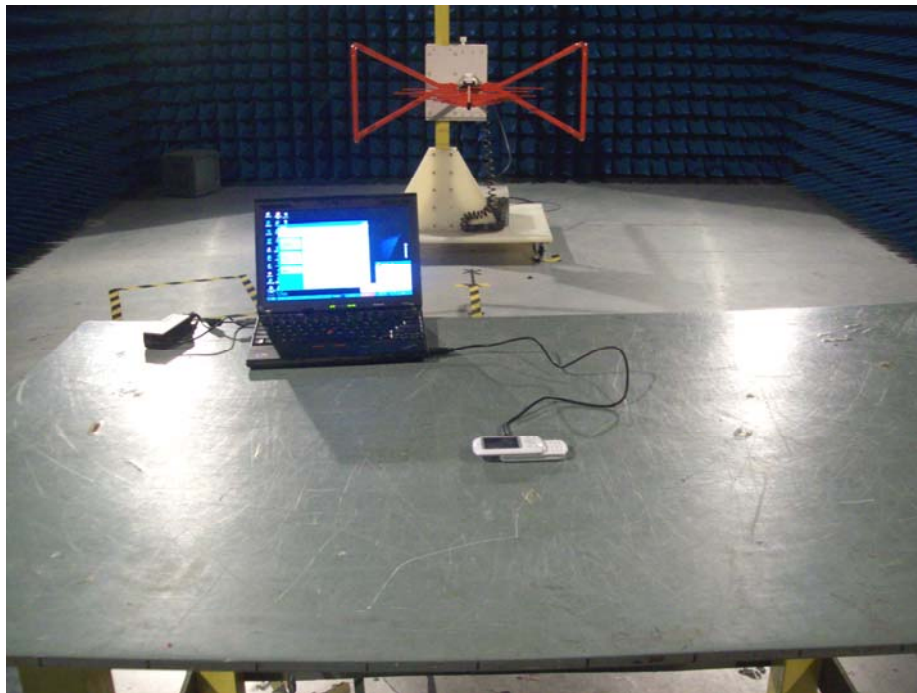

**APPENDIX 2
PHOTOGRAPHS OF EUT**

FRONT VIEW OF SAMPLE



BACK VIEW OF SAMPLE



LEFT VIEW OF SAMPLE



RIGHT VIEW OF SAMPLE



TOP VIEW OF SAMPLE



BOTTOM VIEW OF SAMPLE



PHOTO OF OPEN SAMPLE



PHOTO OF POWER SUPPLY



PHOTO OF USB CABLE



PHOTO OF BATTERY



PHOTO OF THE ENTIRE SAMPLE



INTERNAL PHOTO OF SAMPLE - 1

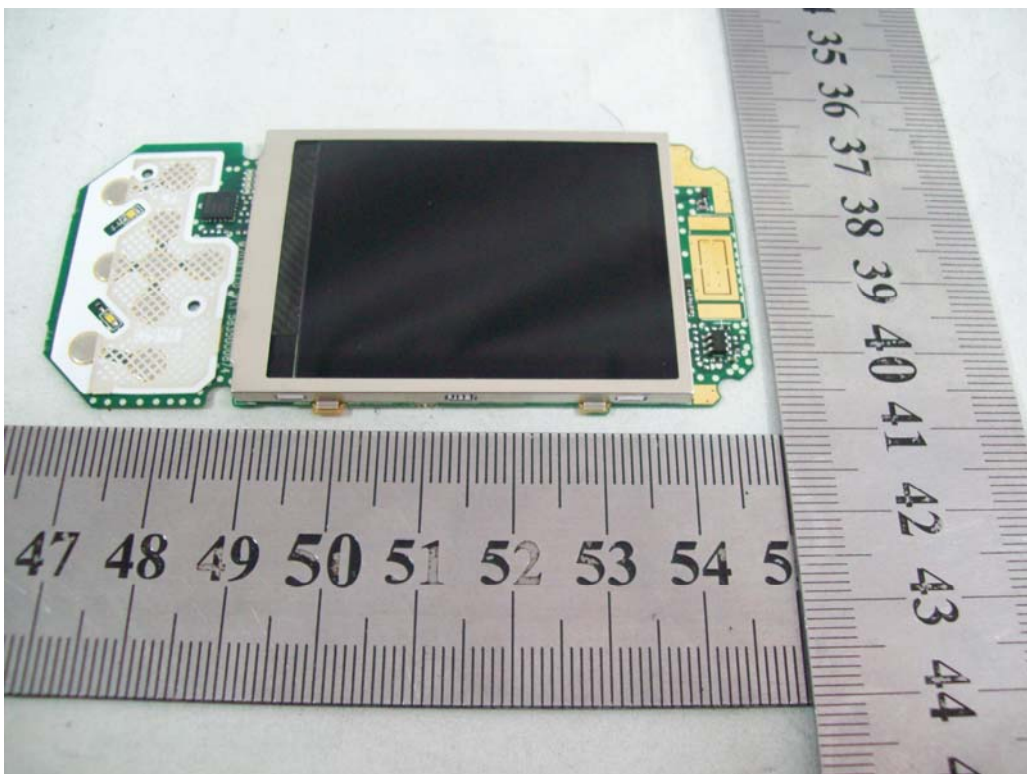

INTERNAL PHOTO OF SAMPLE -2

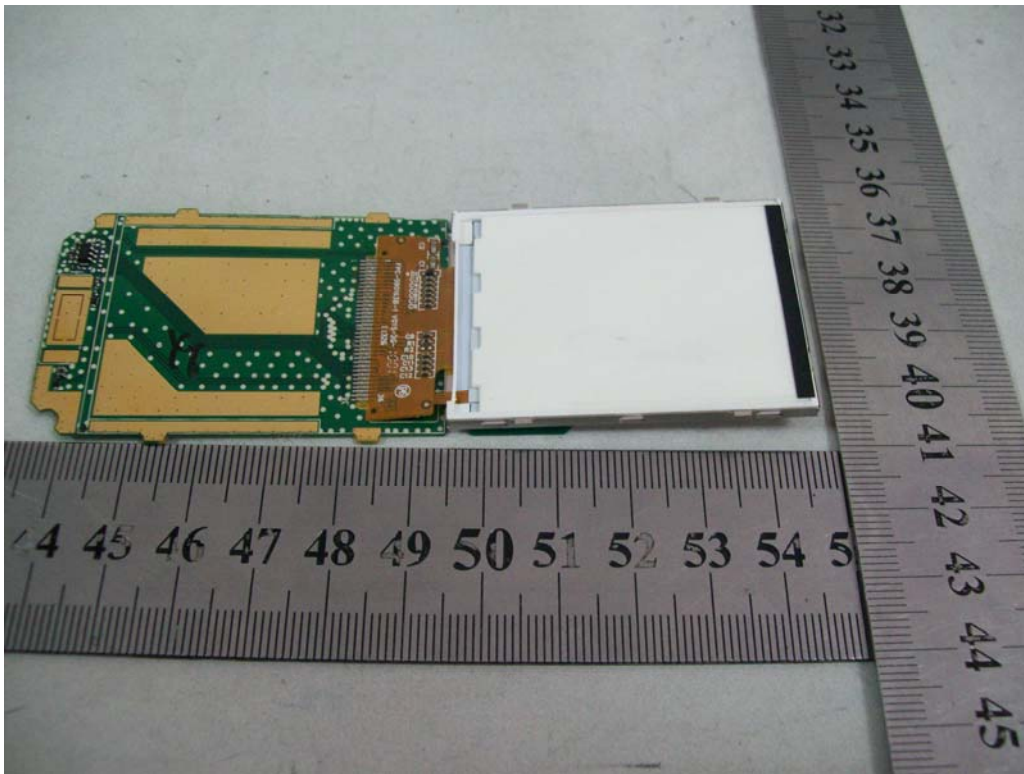

INTERNAL PHOTO OF SAMPLE -3

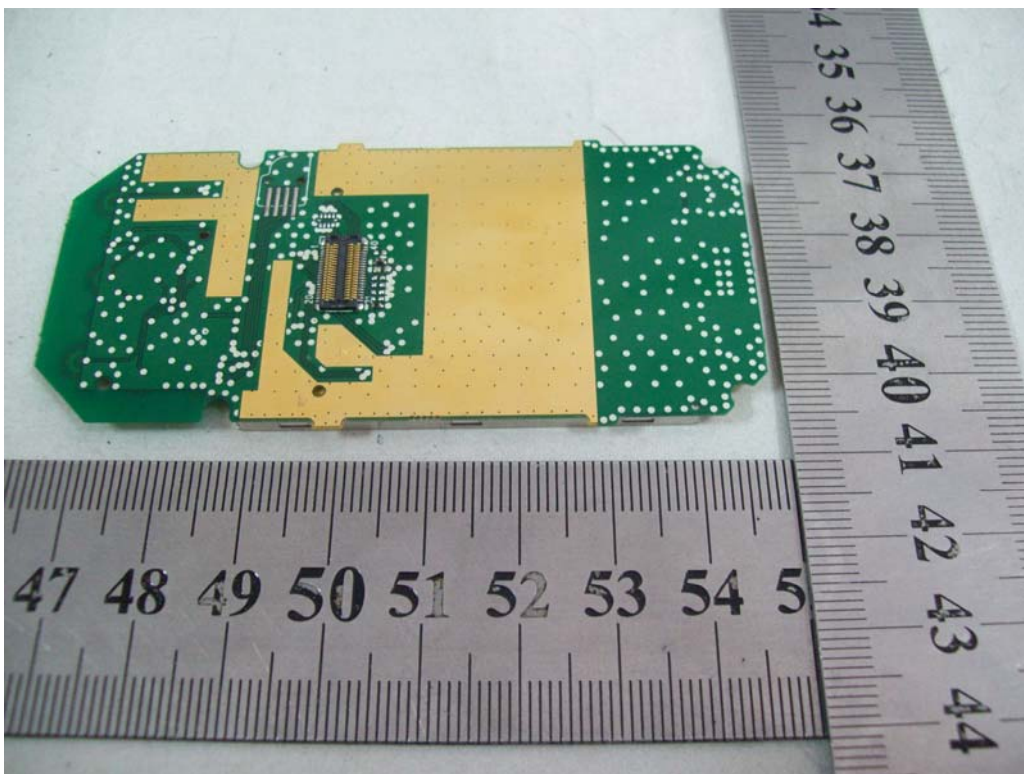

INTERNAL PHOTO OF SAMPLE -4

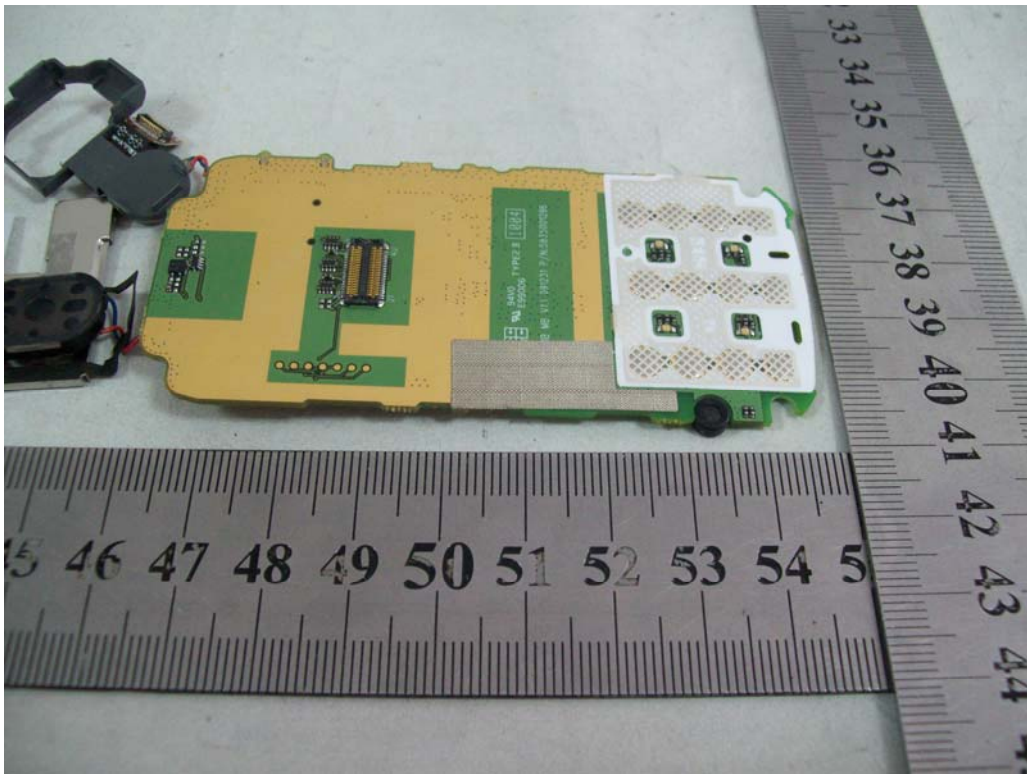

INTERNAL PHOTO OF SAMPLE - 5

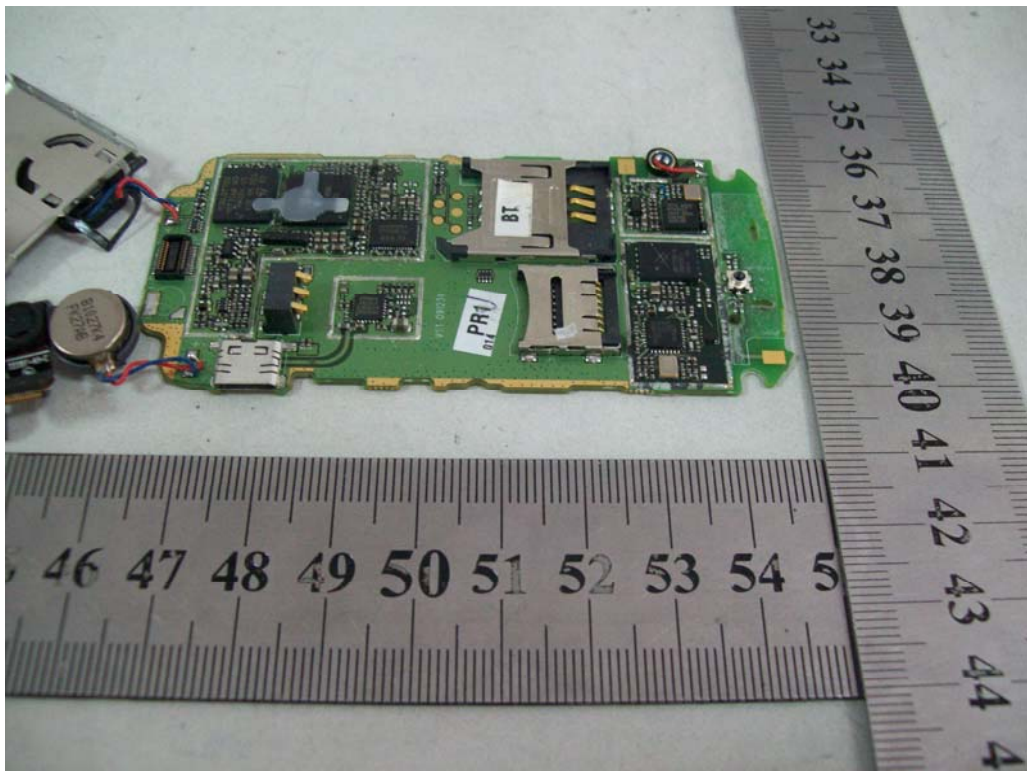

INTERNAL PHOTO OF POWER SUPPLY-1

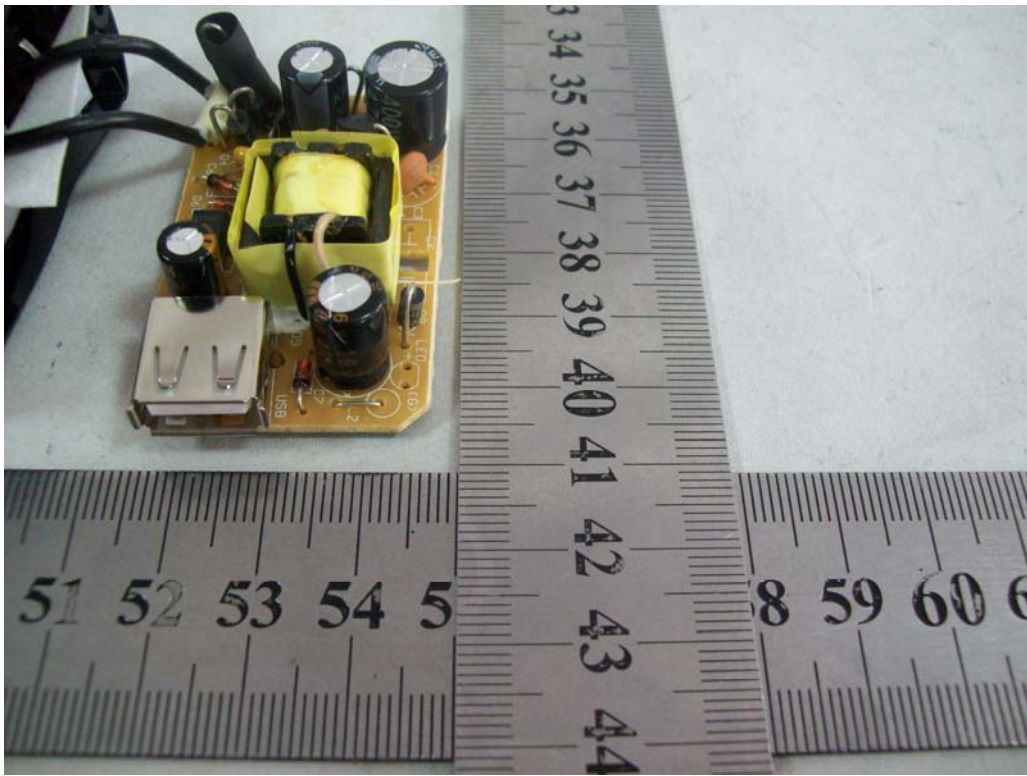

INTERNAL PHOTO OF POWER SUPPLY-2

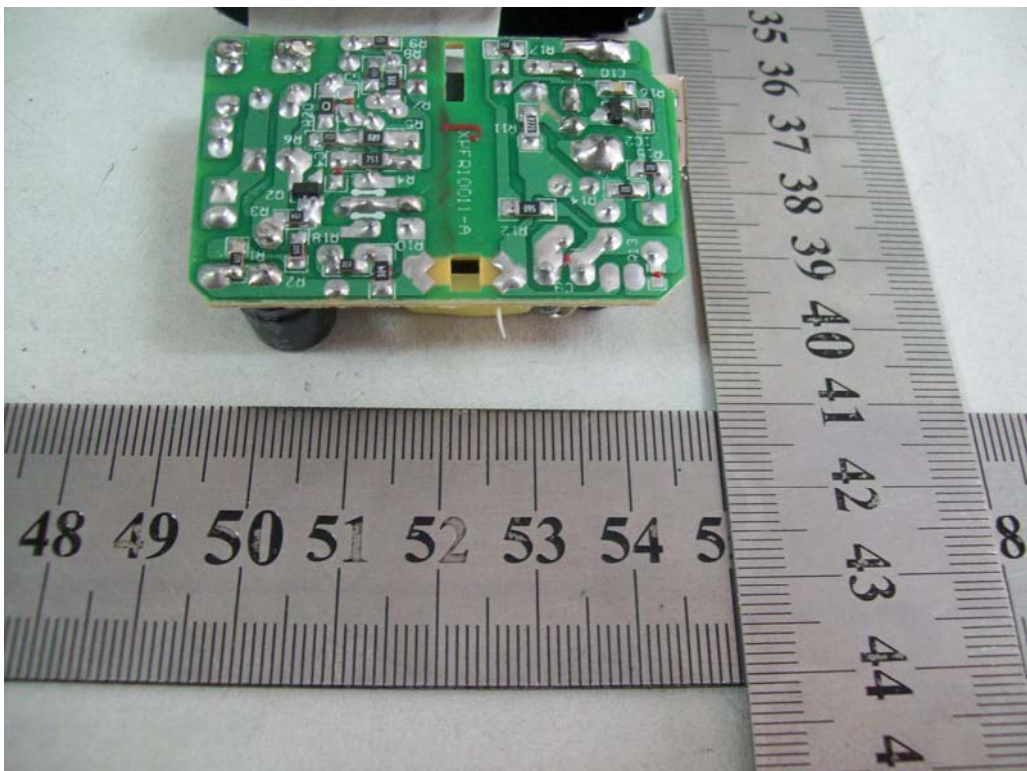

-----END OF REPORT-----