

6

5

4

3

2

1

REVISION RECORD			
LTN	ECO NO.	APPROVED	DATE

D

C

B

A

D

C

B

A

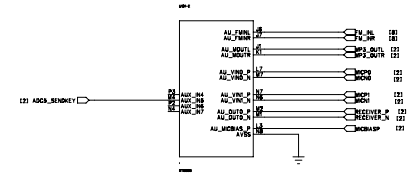
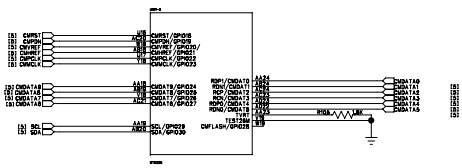
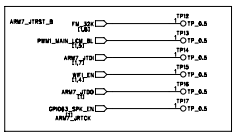
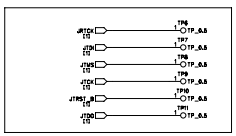
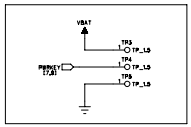
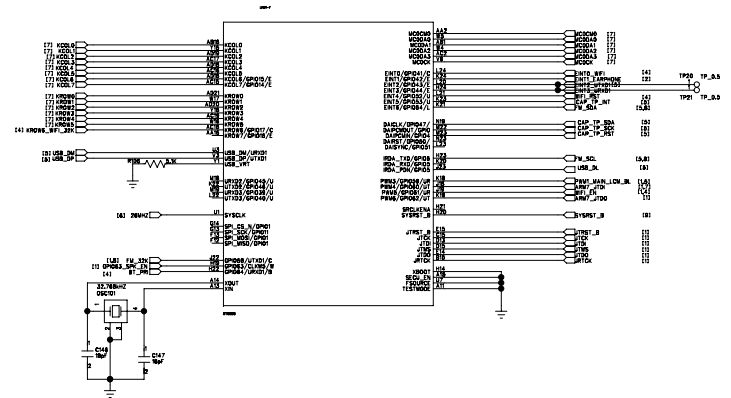
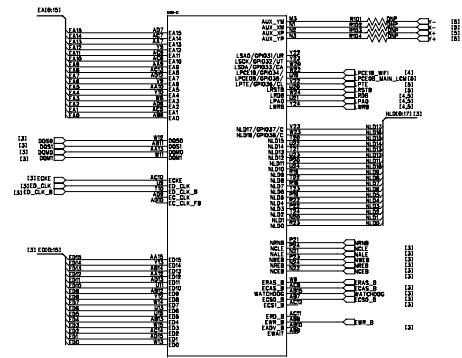

DRAWN:		DATED:		COMPANY:	
CHECKED:		DATED:		TITLE:	
QUALITY CONTROL:		DATED:		CODE:	SIZE:
RELEASED:		DATED:		DRAWING NO.	
				SCALE:	SHEET: OF

6

5

4

3

2

1

REVISION RECORD			
LTN	ECO NO.	APPROVED:	DATE:

D

C

B

A

HEADSET / DIGITAL AUDIO

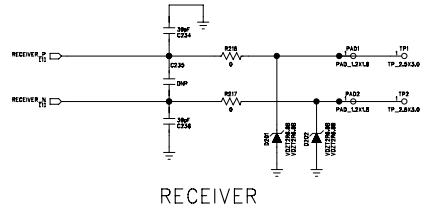
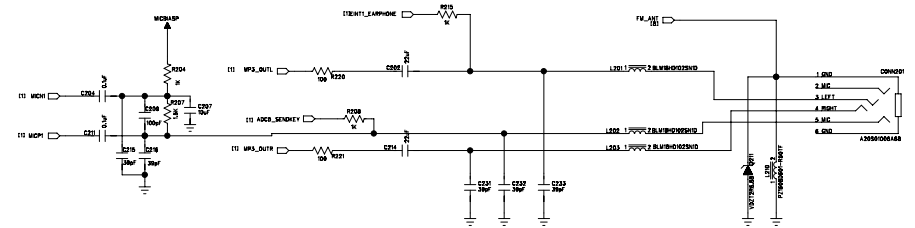
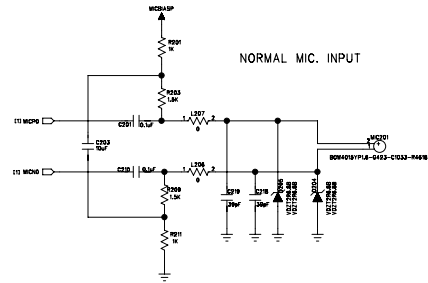

D

C

B

A

DRAWN:				DATED:				COMPANY:				
CHECKER:				DATED:				TITLE:				
QUALITY CONTROL:				DATED:				CODE:	SIZE:	DRAWING NO.:		REV:
RELEASED:				DATED:				SCALE:		SHEET: OF		

6

5

4

3

2

1

REVISION RECORD			
LT#	ECO NO.	APPROVED	DATE

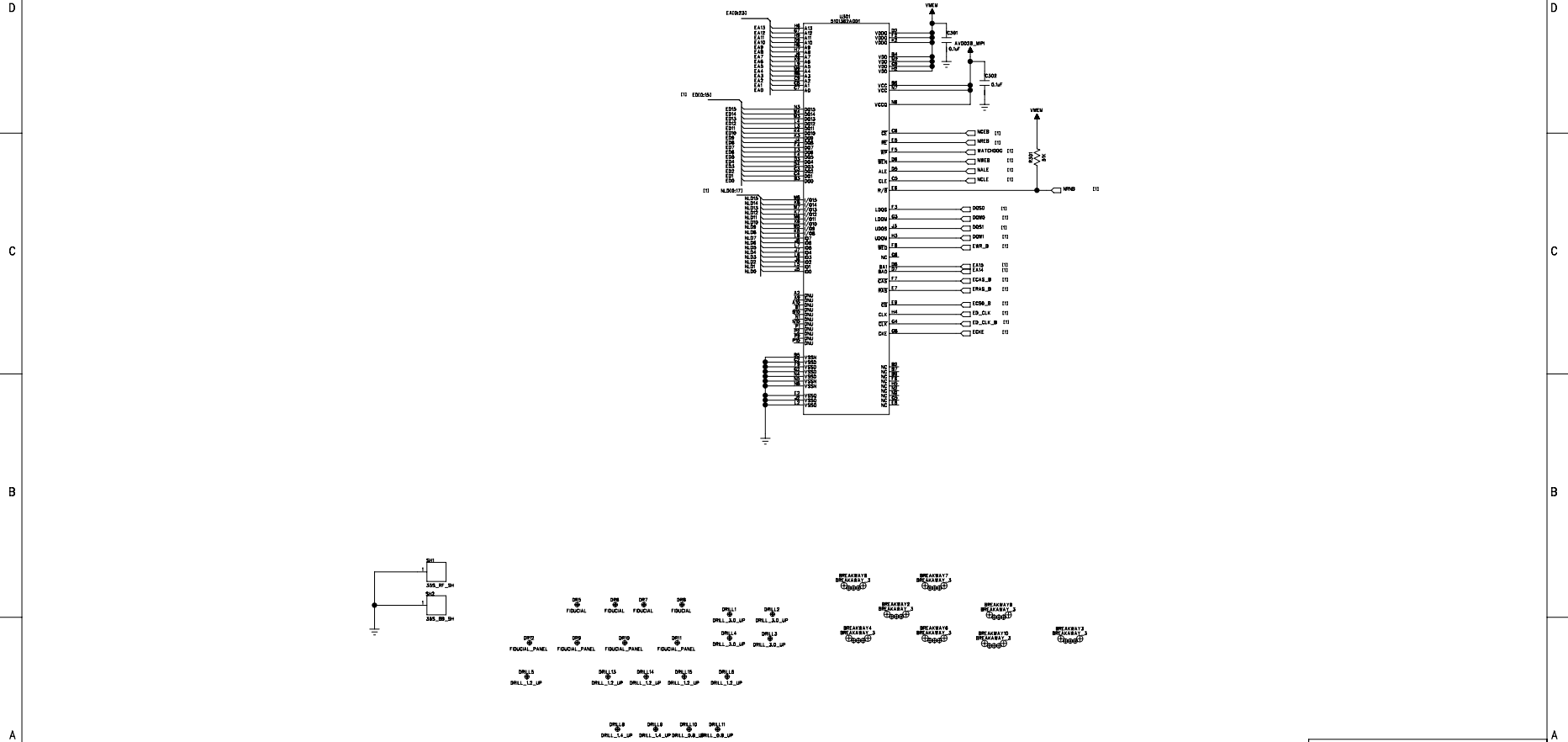

COMPANY:				
TITLE:				
DRAWN:	DATED:	CODE:	SIZE:	DRAWING NO.
CHECKER:	DATED:			REV.
QUALITY CONTROL:	DATED:			
RELEASED:	DATED:	SCALE:	SHEET: OF	

6

5

4

3

2

1

REVISION RECORD			
LTN	ECO NO.	APPROVED:	DATE:

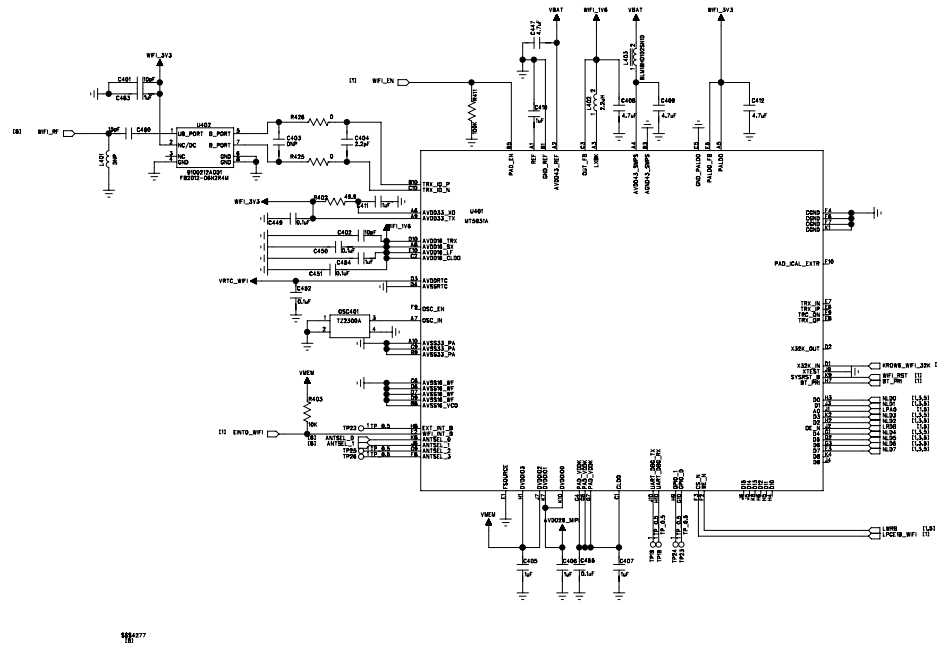

924777
101

DRAWN:		DATED:		COMPANY:	
CHECKED:		DATED:		TITLE:	
QUALITY CONTROL:		DATED:		CODE:	SIZE:
RELEASED:		DATED:		DRAWING NO. REV.	
SCALE:				SHEET: OF	

6

5

4

3

2

1

REVISION RECORD			
LT#	ECO NO.	APPROVED:	DATE:

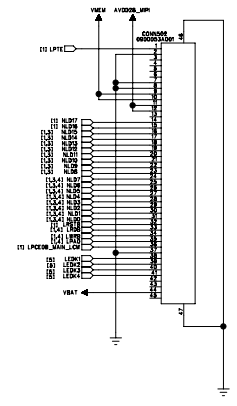
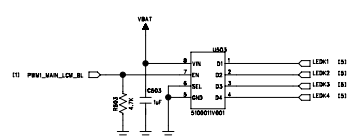
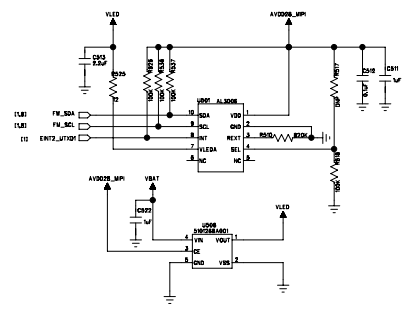
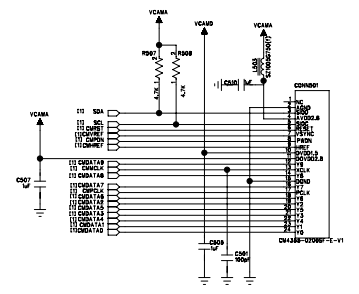
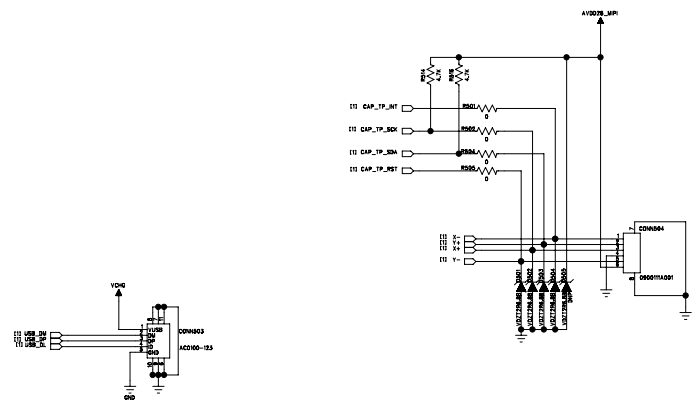

LCD MODULE

DRAWN:		DATED:		COMPANY:	
CHECKED:		DATED:		TITLE:	
QUALITY CONTROL:		DATED:		CODE:	SIZE:
RELEASED:		DATED:		DRAWING NO.	
					REV.
				SHEET: OF	

6

5

4

3

2

1

REVISION RECORD			
LT#	ECO NO.	APPROVED:	DATE:

Ant. GSM850/1900

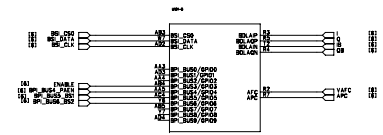
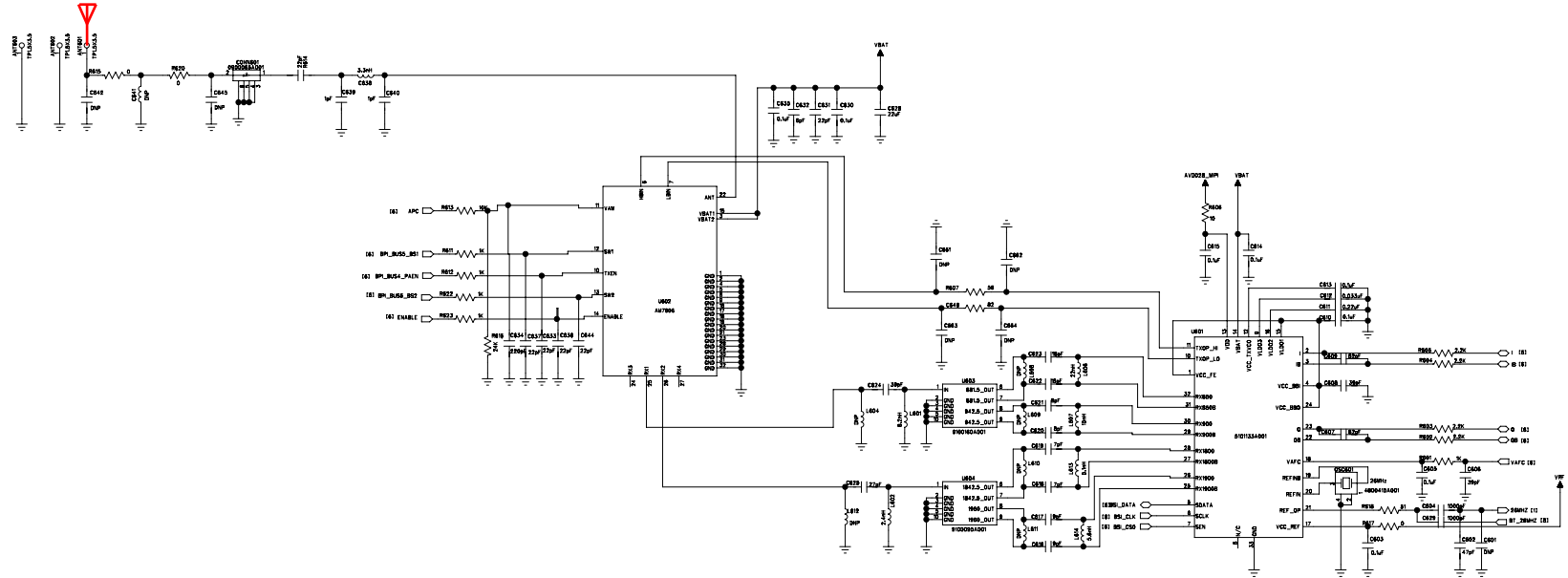

COMPANY:				
TITLE:				
DRAWN:	DATED:	CODE:	SIZE:	DRAWING NO.
CHECKED:	DATED:			REV:
QUALITY CONTROL:	DATED:			
RELEASED:	DATED:	SCALE:		SHEET: OF

D
C
B
A

D
C
B
A

6

5

4

3

2

1

REVISION RECORD			
LTN	ECO NO.	APPROVED:	DATE:

D

C

B

A

D

C

B

A

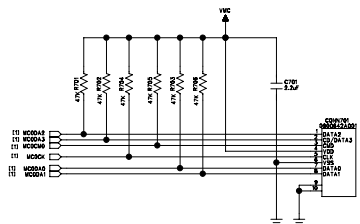
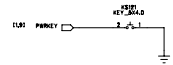
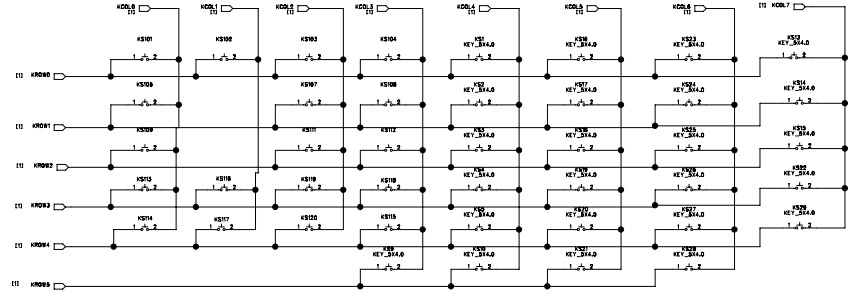
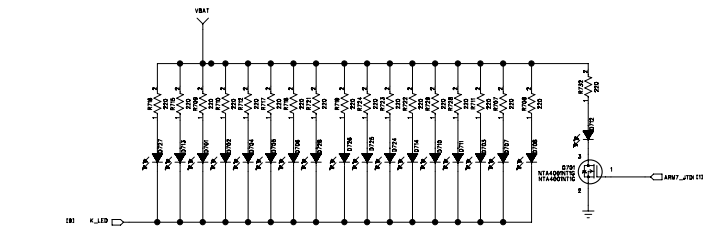

DRAWN:		DATED:		COMPANY:	
CHECKED:		DATED:		TITLE:	
QUALITY CONTROL:		DATED:		CODE:	SIZE:
RELEASED:		DATED:		DRAWING NO.	
					REV.
				SHEET: OF	

6 5 4 3 2 1

REVISION RECORD			
LTR	ECO NO.	APPROVED	DATE

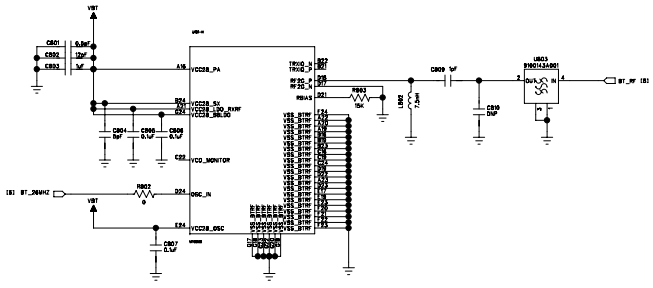

BLUETOOTH

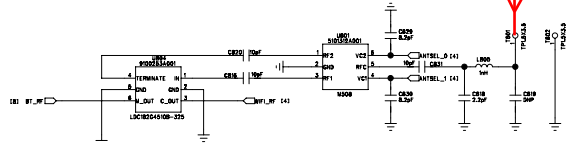

Ant. 2402-2480MHz
2412-2462MHz

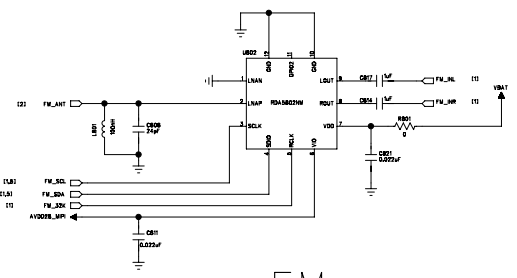

FM

DRAWN:		DATED:		COMPANY:			
CHECKED:		DATED:		TITLE:			
QUALITY CONTROL:		DATED:		CODE:	SIZE:	DRAWING NO.:	REV.:
RELEASED:		DATED:		SCALE:		SHEET: OF	

D
C
B
A

REVISION RECORD			
LT#	ECO NO.	APPROVED:	DATE:

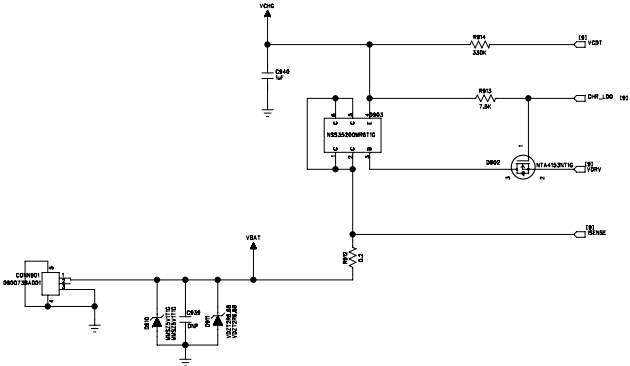
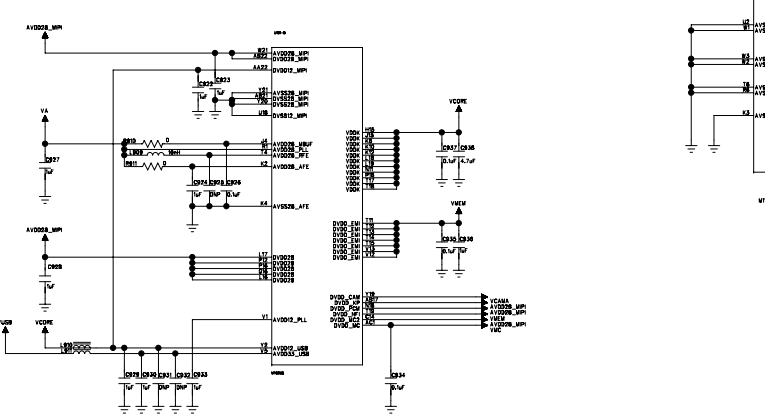
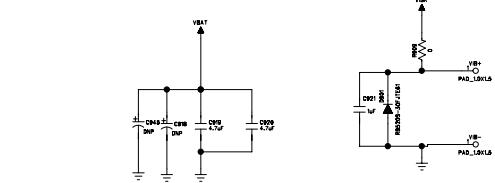
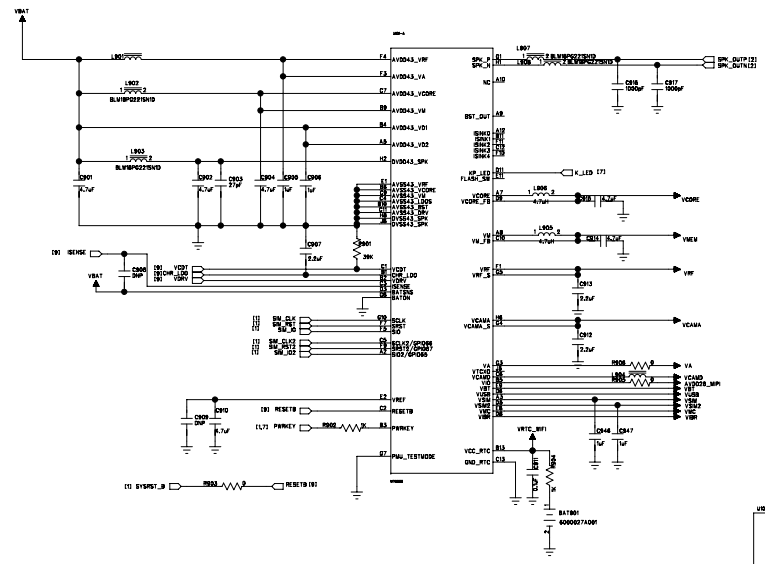

DRAWN:		DATED:		COMPANY:	
CHECKED:		DATED:		TITLE:	
QUALITY CONTROL:		DATED:		CODE:	SIZE:
RELEASED:		DATED:		DRAWING NO. REV.	
SCALE:				SHEET: OF	