

SAR EVALUATION REPORT

For

Verykool USA Inc.

4350 Executive Dr. #100, San Diego, CA 92121, USA.

FCC ID: WA6I650

Report Type: Original Report	Product Type: GSM&GPRS Dual Standby Mobile Phone
Test Engineer: <u>Chris You</u> <i>Chris You</i>	
Report Number: <u>RSZ10110205-SAR</u>	
Report Date: <u>2010-12-09</u>	
Reviewed By: <u>William Chen</u> <u>EMC Engineer</u> <i>William Chen</i>	
Prepared By: Bay Area Compliance Laboratories Corp. (Shenzhen) 6/F, the 3rd Phase of WanLi Industrial Building, ShiHua Road, FuTian Free Trade Zone Shenzhen, Guangdong, China Tel: +86-755-33320018 Fax: +86-755-33320008	

Note: This test report is prepared for the customer shown above and for the device described herein. It may not be duplicated or used in part without prior written consent from Bay Area Compliance Laboratories Corp. (Shenzhen). This report **must not** be used by the customer to claim product certification, approval, or endorsement by NVLAP*, NIST, or any agency of the Federal Government.

* This report may contain data that are not covered by the NVLAP accreditation and are marked with an asterisk “*”

Summary of Test Results	
Rule Part(s):	CFR 47 §2.1093
Test Procedure(s):	FCC OET Bulletin 65-C IEEE 1528-2003
Device Type:	Portable device
Exposure Category	Population/Uncontrolled
Modulation:	GMSK
TX Frequency Range:	824.2-848.8 MHz (Cellular Band) 1850.2-1909.8 MHz (PCS Band)
Maximum Conducted Power Tested:	31.46 dBm (Cellular Band) 28.88 dBm (PCS Band)
Antenna Type(s):	Internal Antenna
Body-Worn Accessories:	Headset
Face-Head Accessories:	None
Battery Type(s) Tested:	3.7 VDC/1200mAh Rechargeable Battery
Max. SAR Level(s) Measured:	0.298 W/Kg, 1g Head Tissue (Cellular Band) 0.898 W/Kg, 1g Body Tissue (Cellular Band) 0.653 W/Kg, 1g Head Tissue (PCS Band) 0.847 W/Kg, 1g Body Tissue (PCS Band)

This wireless device has been shown to be capable of compliance for localized specific absorption rate (SAR) for General Population/Uncontrolled Exposure limits specified in ANSI/IEEE Standards and has been tested in accordance with the measurement procedures specified in FCC OET 65 Supplement C and IEEE 1528-2003.

The results and statements contained in this report pertain only to the device(s) evaluated.



EUT Photo

DOCUMENT REVISION HISTORY

Revision Number	Report Number	Description of Revision	Date of Revision
0	RSZ10110205-SAR	Original Report	2010-12-09

TABLE OF CONTENTS

REFERENCE, STANDARDS AND GUIDELINES5
 SAR LIMITS.....6
EUT DESCRIPTION.....7
 TECHNICAL SPECIFICATION.....7
FACILITIES AND ACCREDITATION8
DESCRIPTION OF TEST SYSTEM9
EQUIPMENT LIST AND CALIBRATION 16
 EQUIPMENTS LIST & CALIBRATION INFO 16
SAR MEASUREMENT SYSTEM VERIFICATION 17
 LIQUID VERIFICATION 17
 SYSTEM ACCURACY VERIFICATION 20
EUT TEST STRATEGY AND METHODOLOGY..... 21
 TEST POSITIONS FOR DEVICE OPERATING NEXT TO A PERSON’S EAR 21
 CHEEK/TOUCH POSITION 22
 EAR/TILT POSITION 22
 TEST POSITIONS FOR BODY-WORN AND OTHER CONFIGURATIONS 23
 SAR EVALUATION PROCEDURE 24
SAR SIMULTANEOUS TRANSMISSION EVALUATION 25
 CONCLUSION 25
SAR MEASUREMENT RESULTS 26
 SAR TEST DATA 26
APPENDIX A – MEASUREMENT UNCERTAINTY 28
APPENDIX B – PROBE CALIBRATION CERTIFICATES..... 29
APPENDIX C – DIPOLE CALIBRATION CERTIFICATES..... 69
APPENDIX D – SAR SYSTEM VALIDATION DATA 79
APPENDIX E – EUT SCAN RESULTS 83
APPENDIX F – CONDUCTED OUTPUT POWER MEASUREMENT..... 103
 TEST BLOCK DIAGRAM AND PROCEDURE 103
 TEST EQUIPMENT LIST AND DETAILS 103
 TEST RESULTS 103
APPENDIX G – EUT TEST POSITION PHOTOS 105
 LIQUID DEPTH \geq 15 CM 105
 BODY-WORN BACK SETUP PHOTO 105
 LEFT HEAD TOUCH SETUP PHOTO 106
 LEFT HEAD TILT SETUP PHOTO 106
 RIGHT HEAD TOUCH SETUP PHOTO 107
 RIGHT HEAD TILT SETUP PHOTO 107
APPENDIX H – EUT PHOTOS..... 108
 EUT – FRONT SIDE VIEW 108
 EUT – BACK SIDE VIEW 108
 EUT- BATTERY OFF VIEW..... 109
 EUT - HEADSET..... 110
APPENDIX I - INFORMATIVE REFERENCES 111

REFERENCE, STANDARDS AND GUIDELINES

FCC:

The Report and Order requires routine SAR evaluation prior to equipment authorization of portable transmitter devices, including portable telephones. For consumer products, the applicable limit is 1.6 mW/g as recommended by the ANSI/IEEE standard C95.1-1992 [6] for an uncontrolled environment (Paragraph 65). According to the Supplement C of OET Bulletin 65 "Evaluating Compliance with FCC Guide-lines for Human Exposure to Radio frequency Electromagnetic Fields", released on Jun 29, 2001 by the FCC, the device should be evaluated at maximum output power (radiated from the antenna) under "worst-case" conditions for normal or intended use, incorporating normal antenna operating positions, device peak performance frequencies and positions for maximum RF energy coupling.

This report describes the methodology and results of experiments performed on wireless data terminal. The objective was to determine if there is RF radiation and if radiation is found, what is the extent of radiation with respect to safety limits. SAR (Specific Absorption Rate) is the measure of RF exposure determined by the amount of RF energy absorbed by human body (or its parts) – to determine how the RF energy couples to the body or head which is a primary health concern for body worn devices. The limit below which the exposure to RF is considered safe by regulatory bodies in North America is 1.6 mW/g average over 1 gram of tissue mass.

CE:

The order requires routine SAR evaluation prior to equipment authorization of portable transmitter devices, including portable telephones. For consumer products, the applicable limit is 2 mW/g as recommended by the EN50360 for an uncontrolled environment. According to the Standard, the device should be evaluated at maximum output power (radiated from the antenna) under "worst-case" conditions for normal or intended use, incorporating normal antenna operating positions, device peak performance frequencies and positions for maximum RF energy coupling.

This report describes the methodology and results of experiments performed on wireless data terminal. The objective was to determine if there is RF radiation and if radiation is found, what is the extent of radiation with respect to safety limits. SAR (Specific Absorption Rate) is the measure of RF exposure determined by the amount of RF energy absorbed by human body (or its parts) – to determine how the RF energy couples to the body or head which is a primary health concern for body worn devices. The limit below which the exposure to RF is considered safe by regulatory bodies in Europe is 2 mW/g average over 10 gram of tissue mass.

The test configurations were laid out on a specially designed test fixture to ensure the reproducibility of measurements. Each configuration was scanned for SAR. Analysis of each scan was carried out to characterize the above effects in the device.

SAR Limits

FCC Limit (1g Tissue)

EXPOSURE LIMITS	SAR (W/kg)	
	(General Population / Uncontrolled Exposure Environment)	(Occupational / Controlled Exposure Environment)
Spatial Average (averaged over the whole body)	0.08	0.4
Spatial Peak (averaged over any 1 g of tissue)	1.60	8.0
Spatial Peak (hands/wrists/feet/ankles averaged over 10 g)	4.0	20.0

CE Limit (10g Tissue)

EXPOSURE LIMITS	SAR (W/kg)	
	(General Population / Uncontrolled Exposure Environment)	(Occupational / Controlled Exposure Environment)
Spatial Average (averaged over the whole body)	0.08	0.4
Spatial Peak (averaged over any 1 g of tissue)	2.0	10
Spatial Peak (hands/wrists/feet/ankles averaged over 10 g)	4.0	20.0

Population/Uncontrolled Environments are defined as locations where there is the exposure of individual who have no knowledge or control of their exposure.

Occupational/Controlled Environments are defined as locations where there is exposure that may be incurred by people who are aware of the potential for exposure (i.e. as a result of employment or occupation).

General Population/Uncontrolled environments Spatial Peak limit 1.6W/kg (FCC) & 2 W/kg (CE) applied to the EUT.

EUT DESCRIPTION

This Bay Area Compliance Laboratories Corp. test report has been prepared on behalf of Verykool USA Inc, and their product, Model: I650, FCC ID: WA6I650 or the EUT (Equipment Under Test) as referred to in the rest of this report.

Technical Specification

Item	Content
Modulation	GMSK
Frequency Band	Cellular Band: 824-849 MHz 869-894 MHz PCS Band: 1850-1910 MHz 1930-1990 MHz
Dimensions (L*W*H)	114 mm (L)× 63 mm (W)×13 mm (H)
Weight	130 g
Power Source	3.7 VDC/ 1200mAh Rechargeable Battery
Normal Operation	Head and Body-worn

FACILITIES AND ACCREDITATION

The test site used by Bay Area Compliance Laboratories Corp. (Shenzhen) to collect data is located at

6/F, the 3rd Phase of WanLi Industrial Building,
Shi Hua Road, Fu Tian Free Trade Zone,
Shenzhen, Guangdong, P.R. of China

Additionally, Bay Area Compliance Laboratories Corp. (Shenzhen) is a National Institute of Standards and Technology (NIST) accredited laboratory, under the National Voluntary Laboratory Accredited Program (Lab Code 200707-0).



The current scope of accreditations can be found at <http://ts.nist.gov/Standards/scopes/2007070.htm>

DESCRIPTION OF TEST SYSTEM

These measurements were performed with ALSAS 10 Universal Integrated SAR Measurement system from APREL Laboratories.



ALSAS-10U System Description

ALSAS-10-U is fully compliant with the technical and scientific requirements of IEEE 1528, IEC 62209, CENELEC, ARIB, ACA, and the Federal Communications Commission. The system comprises of a six axes articulated robot which utilizes a dedicated controller. ALSAS-10U uses the latest methodologies. And FDTD modeling to provide a platform which is repeatable with minimum uncertainty.

Applications

Predefined measurement procedures compliant with the guidelines of CENELEC, IEEE, IEC, FCC, etc are utilized during the assessment for the device. Automatic detection for all SAR maxima are embedded within the core architecture for the system, ensuring that peak locations used for centering the zoom scan are within a 1mm resolution and a 0.05mm repeatable position. System operation range currently available up-to 6 GHz in simulated tissue.

Area Scans

Area scans are defined prior to the measurement process being executed with a user defined variable spacing between each measurement point (integral) allowing low uncertainty measurements to be conducted. Scans defined for FCC applications utilize a 10mm² step integral, with 1mm interpolation used to locate the peak SAR area used for zoom scan assessments.

Where the system identifies multiple SAR peaks (which are within 25% of peak value) the system will provide the user with the option of assessing each peak location individually for zoom scan averaging.

Zoom Scan (Cube Scan Averaging)

The averaging zoom scan volume utilized in the ALSAS-10U software is in the shape of a cube and the side dimension of a 1 g or 10 g mass is dependent on the density of the liquid representing the simulated tissue. A density of 1000 kg/m³ is used to represent the head and body tissue density and not the phantom liquid density, in order to be consistent with the definition of the liquid dielectric properties, i.e. the side length of the 1 g cube is 10mm, with the side length of the 10 g cube 21,5mm.

When the cube intersects with the surface of the phantom, it is oriented so that 3 vertices touch the surface of the shell or the center of a face is tangent to the surface. The face of the cube closest to the surface is modified in order to conform to the tangent surface.

The zoom scan integer steps can be user defined so as to reduce uncertainty, but normal practice for typical test applications (including FCC) utilize a physical step of 5x5x8 (8mmx8mmx5mm) providing a volume of 32mm in the X & Y axis, and 35mm in the Z axis.

ALSAS-10U Interpolation and Extrapolation Uncertainty

The overall uncertainty for the methodology and algorithms the used during the SAR calculation was evaluated using the data from IEEE 1528 based on the example f3 algorithm:

$$f_3(x, y, z) = A \frac{a^2}{\frac{a^2}{4} + x'^2 + y'^2} \cdot \left(e^{-\frac{2z}{a}} + \frac{a^2}{2(a + 2z)^2} \right)$$

Isotropic E-Field Probe

The isotropic E-Field probe has been fully calibrated and assessed for isotropicity, and boundary effect within a controlled environment. Depending on the frequency for which the probe is calibrated the method utilized for calibration will change.

The E-Field probe utilizes a triangular sensor arrangement as detailed in the diagram below:

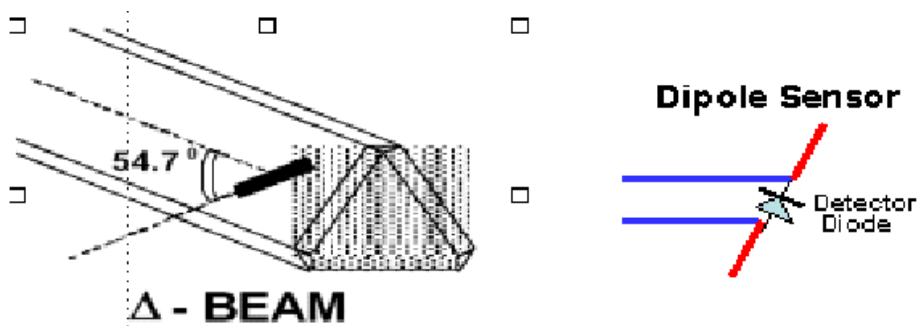

SAR is assessed with a calibrated probe which moves at a default height of 5mm from the center of the diode, which is mounted to the sensor, to the phantom surface (in the Z Axis). The 5mm offset height has been selected so as to minimize any resultant boundary effect due to the probe being in close proximity to the phantom surface.

The following algorithm is an example of the function used by the system for linearization of the output from the probe when measuring complex modulation schemes.

$$V_i = U_i + U_i^2 \cdot \frac{cf}{dcp_i}$$

Isotropic E-Field Probe Specification

Calibration in Air	Frequency Dependent Below 2 GHz Calibration in air performed in a TEM Cell Above 2 GHz Calibration in air performed in waveguide
Sensitivity	0.70 $\mu\text{V}/(\text{V}/\text{m})^2$ to 0.85 $\mu\text{V}/(\text{V}/\text{m})^2$
Dynamic Range	0.0005 W/kg to 100 W/kg
Isotropic Response	Better than 0.2 dB
Diode Compression Point (DCP)	Calibration for Specific Frequency
Probe Tip Radius	< 5 mm
Sensor Offset	1.56 (+/- 0.02 mm)
Probe Length	290 mm
Video Bandwidth	@ 500 Hz: 1 dB @ 1.02 kHz: 3 dB
Boundary Effect	Less than 2% for distance greater than 2.4 mm
Spatial Resolution	Diameter less than 5 mm Compliant with Standards

Boundary Detection Unit and Probe Mounting Device

ALSAS-10U incorporates a boundary detection unit with a sensitivity of 0.05mm for detecting all types of surfaces. The robust design allows for detection during probe tilt (probe normalize) exercises, and utilizes a second stage emergency stop. The signal electronics are fed directly into the robot controller for high accuracy surface detection in lateral and axial detection modes (X, Y, & Z).

The probe is mounted directly onto the Boundary Detection unit for accurate tooling and displacement calculations controlled by the robot kinematics. The probe is connect to an isolated probe interconnect where the output stage of the probe is fed directly into the amplifier stage of the Daq-Paq.

Daq-Paq (Analog to Digital Electronics)

ALSAS-10U incorporates a fully calibrated Daq-Paq (analog to digital conversion system) which has a 4 channel input stage, sent via a 2 stage auto-set amplifier module. The input signal is amplified accordingly so as to offer a dynamic range from 5 μV to 800mV. Integration of the fields measured is carried out at board level utilizing a Co-Processor which then sends the measured fields down into the main computational module in digitized form via an RS232 communications port. Probe linearity and duty cycle compensation is carried out within the main Daq-Paq module.

ADC	12 Bit
Amplifier Range	20 mV to 200 mV and 150 mV to 800 mV
Field Integration	Local Co-Processor utilizing proprietary integration algorithms
Number of Input Channels	4 in total 3 dedicated and 1 spare
Communication	Packet data via RS232

Axis Articulated Robot

ALSAS-10U utilizes a six axis articulated robot, which is controlled using a Pentium based real-time movement controller. The movement kinematics engine utilizes proprietary (Thermo CRS) interpolation and extrapolation algorithms, which allow full freedom of movement for each of the six joints within the working envelope. Utilization of joint 6 allows for full probe rotation with a tolerance better than 0.05mm around the central axis.



Robot/Controller Manufacturer	Thermo CRS
Number of Axis	Six independently controlled axis
Positioning Repeatability	0.05 mm
Controller Type	Single phase Pentium based C500C
Robot Reach	710 mm
Communication	RS232 and LAN compatible

ALSAS Universal Workstation

ALSAS Universal workstation allows for repeatability and fast adaptability. It allows users to do calibration, testing and measurements using different types of phantoms with one set up, which significantly speeds up the measurement process.

Universal Device Positioner

The universal device positioner allows complete freedom of movement of the EUT. Developed to hold a EUT in a free-space scenario any additional loading attributable to the material used in the construction of the positioner has been eliminated. Repeatability has been enhanced through the linear scales which form the design used to indicate positioning for any given test scenario in all major axes. A 15° tilt indicator is included for the of aid cheek to tilt movements for head SAR analysis. Overall uncertainty for measurements have been reduced due to the design of the Universal device positioner, which allows positioning of a device in as near to a free-space scenario as possible, and by providing the means for complete repeatability.



Phantom Types

The ALSAS-10U allows the integration of multiple phantom types. SAM Phantoms fully compliant with IEEE 1528, Universal Phantom, and Universal Flat.

APREL SAM Phantoms

The SAM phantoms developed using the IEEE SAM CAD file. They are fully compliant with the requirements for both IEEE 1528 and FCC Supplement C. Both the left and right SAM phantoms are interchangeable, transparent and include the IEEE 1528 grid with visible NF and MB lines.

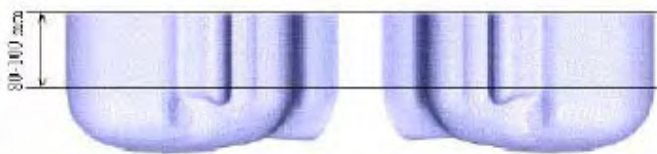

APREL Laboratories Universal Phantom

The Universal Phantom is used on the ALSAS-10U as a system validation phantom. The Universal Phantom has been fully validated both experimentally from 800MHz to 6GHz and numerically using XFDTD numerical software.

The shell thickness is 2mm overall, with a 4mm spacer located at the NF/MB intersection providing an overall thickness of 6mm in line with the requirements of IEEE-1528.

The design allows for fast and accurate measurements, of handsets, by allowing the conservative SAR to be evaluated at on frequency for both left and right head experiments in one measurement.



Tissue Dielectric Parameters for Head and Body Phantoms

The head tissue dielectric parameters recommended by the IEEE SCC-34/SC-2 in P1528 have been incorporated in the following table. These head parameters are derived from planar layer models simulating the highest expected SAR for the dielectric properties and tissue thickness variations in a human head. Other head and body tissue parameters that have not been specified in P1528 are derived from the tissue dielectric parameters computed from the 4-Cole-Cole equations described in Reference [12] and extrapolated according to the head parameters specified in P1528.

Ingredients (% by weight)	Frequency (MHz)									
	450		835		915		1900		2450	
Tissue Type	Head	Body	Head	Body	Head	Body	Head	Body	Head	Body
Water	38.56	51.16	41.45	52.4	41.05	56.0	54.9	40.4	62.7	73.2
Salt (Nacl)	3.95	1.49	1.45	1.4	1.35	0.76	0.18	0.5	0.5	0.04
Sugar	56.32	46.78	56.0	45.0	56.5	41.76	0.0	58.0	0.0	0.0
HEC	0.98	0.52	1.0	1.0	1.0	1.21	0.0	1.0	0.0	0.0
Bactericide	0.19	0.05	0.1	0.1	0.1	0.27	0.0	0.1	0.0	0.0
Triton x-100	0.0	0.0	0.0	0.0	0.0	0.0	0.0	0.0	36.8	0.0
DGBE	0.0	0.0	0.0	0.0	0.0	0.0	44.92	0.0	0.0	26.7
Dielectric Constant	43.42	58.0	42.54	56.1	42.0	56.8	39.9	54.0	39.8	52.5
Conductivity (s/m)	0.85	0.83	0.91	0.95	1.0	1.07	1.42	1.45	1.88	1.78

IEEE SCC-34/SC-2 P1528 Recommended Tissue Dielectric Parameters

Frequency (MHz)	Head Tissue		Body Tissue	
	ϵ_r	σ (S/m)	ϵ_r	σ (S/m)
150	52.3	0.76	61.9	0.80
300	45.3	0.87	58.2	0.92
450	43.5	0.87	56.7	0.94
835	41.5	0.90	55.2	0.97
900	41.5	0.97	55.0	1.05
915	41.5	0.98	55.0	1.06
1450	40.5	1.20	54.0	1.30
1610	40.3	1.29	53.8	1.40
1800-2000	40.0	1.40	53.3	1.52
2450	39.2	1.80	52.7	1.95
3000	38.5	2.40	52.0	2.73
5800	35.3	5.27	48.2	6.00

EQUIPMENT LIST AND CALIBRATION

Equipments List & Calibration Info

Equipment	Model	Calibration Date	S/N
CRS F3 robot	ALS-F3	N/A	RAF0805352
CRS F3 Software	ALS-F3-SW	N/A	N/A
CRS C500C controller	ALS-C500	N/A	RCF0805379
Probe mounting device & Boundary Detection Sensor System	ALS-PMDPS-3	N/A	120-00270
Universal Work Station	ALS-UWS	N/A	100-00157
Data Acquisition Package	ALS-DAQ-PAQ-3	N/A	110-00212
Miniature E-Field Probe	ALS-E-020	2010-08-20	273
Dipole, 835 MHz	ALS-D-835-S-2	2010-09-20	180-00558
Dipole, 1900 MHz	ALS-D-1900-S-2	2010-09-20	210-00710
Dipole Spacer	ALS-DS-U	N/A	250-00907
R&S, universal Communication Tester	CMD200	2010-06-28	1100.0008.02
Device holder/Positioner	ALS-H-E-SET-2	N/A	170-00510
Left ear SAM phantom	ALS-P-SAM-L	N/A	130-00311
Right ear SAM phantom	ALS-P-SAM-R	N/A	140-00359
UniPhantom	ALS-P-UP-1	N/A	150-00413
Simulated Tissue 835 MHz Head	ALS-T-835-1-H	Each Time	270-01002
Simulated Tissue 835 MHz Body	ALS-T-835-1-B	Each Time	270-02101
Simulated Tissue 1900 MHz Head	ALS-T-1900-1-H	Each Time	295-01103
Simulated Tissue 1900 MHz Body	ALS-T-1900-1-B	Each Time	295-02102
Signal Generator	HP8648C	2010-09-18	3426A01345
Power Amplifier	5S1G4	N/A	71377
Spectrum Analyzer	FSEM30	2010-07-05	849720/019

SAR MEASUREMENT SYSTEM VERIFICATION

Liquid Verification

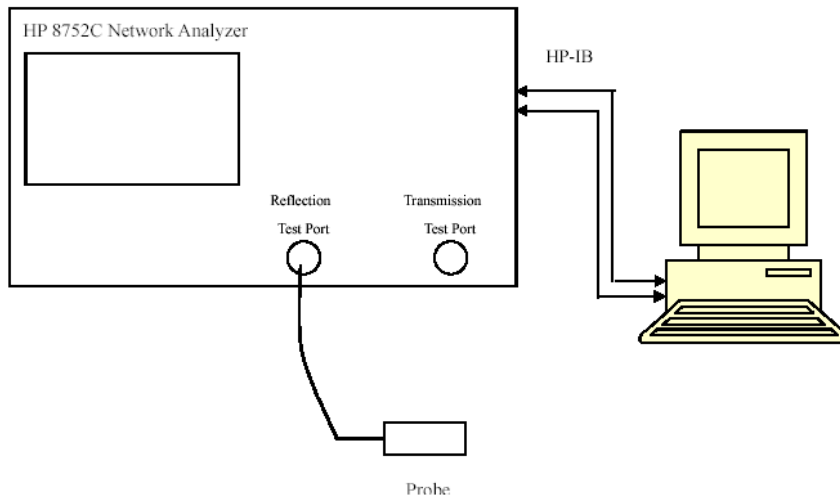

Liquid Verification Setup Block Diagram

Liquid Verification Results

Frequency (MHz)	Liquid Type	Liquid Parameter		Result
		ϵ_r	σ (S/m)	
835	Head	41.14	0.92	In Tolerance
835	Body	55.32	0.97	In Tolerance
1900	Head	40.05	1.45	In Tolerance
1900	Body	53.88	1.47	In Tolerance

**The liquid verification data is 2010-12-04.*

Please refer to the following tables

850 MHz Head			850 MHz Body		
Frequency	e'	e''	Frequency	e'	e''
824000000	41.196809	19.483208	824000000	55.359190	21.331874
824500000	41.165717	19.473958	824500000	55.332898	21.340491
825000000	41.149023	19.439583	825000000	55.321411	21.343613
825500000	41.043671	19.429564	825500000	55.257794	21.371684
826000000	41.062066	19.406907	826000000	55.242364	21.303725
826500000	41.084003	19.378031	826500000	55.330058	21.348075
827000000	41.060442	19.414494	827000000	55.352963	21.338393
827500000	41.107859	19.420840	827500000	55.366068	21.332314
828000000	41.127504	19.403127	828000000	55.312087	21.295648
828500000	41.133944	19.452302	828500000	55.306901	21.329776
829000000	41.184978	19.510155	829000000	55.326140	21.310280
829500000	41.133367	19.501491	829500000	55.340504	21.337026
830000000	41.169808	19.468491	830000000	55.386470	21.329639
830500000	41.129756	19.425201	830500000	55.310899	21.323540
831000000	41.102700	19.504388	831000000	55.271880	21.325888
831500000	41.122294	19.486598	831500000	55.327646	21.403349
832000000	41.084035	19.411522	832000000	55.289719	21.261480
832500000	41.058805	19.458624	832500000	55.254573	21.273533
833000000	41.099426	19.403667	833000000	55.294417	21.279391
833500000	41.130909	19.466293	833500000	55.373647	21.331006
834000000	41.128329	19.444269	834000000	55.321324	21.239256
834500000	41.126906	19.463698	834500000	55.365408	21.270879
835000000	41.143785	19.452918	835000000	55.323073	21.285883
835500000	41.185787	19.443483	835500000	55.368806	21.256023
836000000	41.116394	19.424621	836000000	55.308111	21.272339
836500000	41.111396	19.486594	836500000	55.313764	21.318345
837000000	41.128166	19.459205	837000000	55.327895	21.256749
837500000	41.122362	19.407033	837500000	55.415041	21.271557
838000000	41.145580	19.476494	838000000	55.392884	21.273220
838500000	41.104028	19.444816	838500000	55.353483	21.286932
839000000	41.093938	19.450965	839000000	55.307564	21.297670
839500000	41.096413	19.391470	839500000	55.368519	21.272952
840000000	41.107503	19.417535	840000000	55.333769	21.241216
840500000	41.096842	19.403199	840500000	55.341521	21.220510
841000000	41.080081	19.385452	841000000	55.315993	21.212630
841500000	41.109583	19.421688	841500000	55.363215	21.209481
842000000	41.111288	19.378113	842000000	55.317330	21.247632
842500000	41.114992	19.359775	842500000	55.366673	21.221774
843000000	41.109075	19.416223	843000000	55.342361	21.202600
843500000	41.032623	19.405237	843500000	55.320352	21.231489
844000000	41.109030	19.371370	844000000	55.297952	21.217044
844500000	41.063228	19.413388	844500000	55.293893	21.249829
845000000	40.989096	19.391615	845000000	55.279492	21.199776
845500000	41.004429	19.395666	845500000	55.298592	21.180172
846000000	40.958920	19.365880	846000000	55.227185	21.206547
846500000	40.999942	19.352380	846500000	55.298533	21.209940
847000000	40.980171	19.376687	847000000	55.325417	21.154839
847500000	40.983362	19.373966	847500000	55.314234	21.168640
848000000	40.956910	19.338925	848000000	55.263973	21.165253
848500000	40.961515	19.376603	848500000	55.262241	21.175343
849000000	40.921702	19.365841	849000000	55.303670	21.157778

1900 MHz Head			1900 MHz Body		
Frequency	e'	e''	Frequency	e'	e''
1850000000	40.285338	13.812149	1850000000	53.788904	13.952822
1851200000	40.299870	13.807234	1851200000	53.775482	13.974799
1852400000	40.296776	13.779107	1852400000	53.799759	13.955439
1853600000	40.231388	13.755756	1853600000	53.749320	13.898657
1854800000	40.221349	13.766171	1854800000	53.766381	13.941798
1856000000	40.233659	13.787513	1856000000	53.751384	13.957769
1857200000	40.258787	13.769757	1857200000	53.761404	13.910113
1858400000	40.242120	13.784407	1858400000	53.756489	13.961909
1859600000	40.218160	13.772539	1859600000	53.758853	13.947276
1860800000	40.228784	13.751426	1860800000	53.792241	13.942054
1862000000	40.208519	13.740434	1862000000	53.779808	13.910976
1863200000	40.212515	13.748308	1863200000	53.781769	13.945307
1864400000	40.213084	13.721148	1864400000	53.756776	13.929279
1865600000	40.173400	13.703838	1865600000	53.804820	13.944258
1866800000	40.151302	13.709531	1866800000	53.773929	13.929956
1868000000	40.183331	13.702868	1868000000	53.756280	13.925990
1869200000	40.173263	13.722736	1869200000	53.826274	13.973264
1870400000	40.163010	13.693173	1870400000	53.798001	13.986543
1871600000	40.161361	13.726261	1871600000	53.823715	13.976762
1872800000	40.179028	13.740969	1872800000	53.836483	13.993811
1874000000	40.186481	13.759033	1874000000	53.827116	14.023507
1875200000	40.174390	13.746121	1875200000	53.849105	14.009583
1876400000	40.156764	13.783089	1876400000	53.853246	14.045714
1877600000	40.158526	13.767594	1877600000	53.850941	14.050226
1878800000	40.153850	13.780934	1878800000	53.890947	14.072218
1880000000	40.165929	13.820744	1880000000	53.915346	14.048551
1881200000	40.130663	13.810171	1881200000	53.885520	14.104596
1882400000	40.135220	13.833072	1882400000	53.878485	14.083377
1883600000	40.150857	13.814989	1883600000	53.895671	14.092495
1884800000	40.166471	13.830899	1884800000	53.936240	14.102599
1886000000	40.152264	13.853368	1886000000	53.923133	14.135859
1887200000	40.143301	13.835420	1887200000	53.937512	14.117437
1888400000	40.132164	13.852843	1888400000	53.914386	14.111164
1889600000	40.112247	13.841894	1889600000	53.911503	14.134930
1890800000	40.107543	13.830549	1890800000	53.896780	14.113383
1892000000	40.107639	13.865514	1892000000	53.929777	14.119039
1893200000	40.072212	13.839828	1893200000	53.933342	14.129428
1894400000	40.082707	13.828077	1894400000	53.901678	14.093601
1895600000	40.089052	13.877542	1895600000	53.891170	14.116953
1896800000	40.062243	13.855681	1896800000	53.871277	14.130251
1898000000	40.042300	13.854101	1898000000	53.870412	14.155924
1899200000	40.028711	13.823881	1899200000	53.903274	14.112834
1900400000	40.052837	13.841771	1900400000	53.881086	14.118084
1901600000	40.062090	13.829452	1901600000	53.891961	14.113195
1902800000	40.054954	13.838232	1902800000	53.888607	14.103759
1904000000	40.053747	13.837042	1904000000	53.883874	14.133078
1905200000	40.039477	13.844225	1905200000	53.869828	14.096061
1906400000	40.059915	13.838389	1906400000	53.845303	14.083881
1907600000	40.062160	13.847307	1907600000	53.869098	14.075333
1908800000	40.060663	13.864744	1908800000	53.836041	14.086191
1910000000	40.110146	13.880157	1910000000	53.849410	14.098567

System Accuracy Verification

Prior to the assessment, the system validation kit was used to test whether the system was operating within its specifications of $\pm 10\%$. The validation results are tabulated below. And also the corresponding SAR plot is attached as well in the SAR plots files.

System Verification Setup Block Diagram

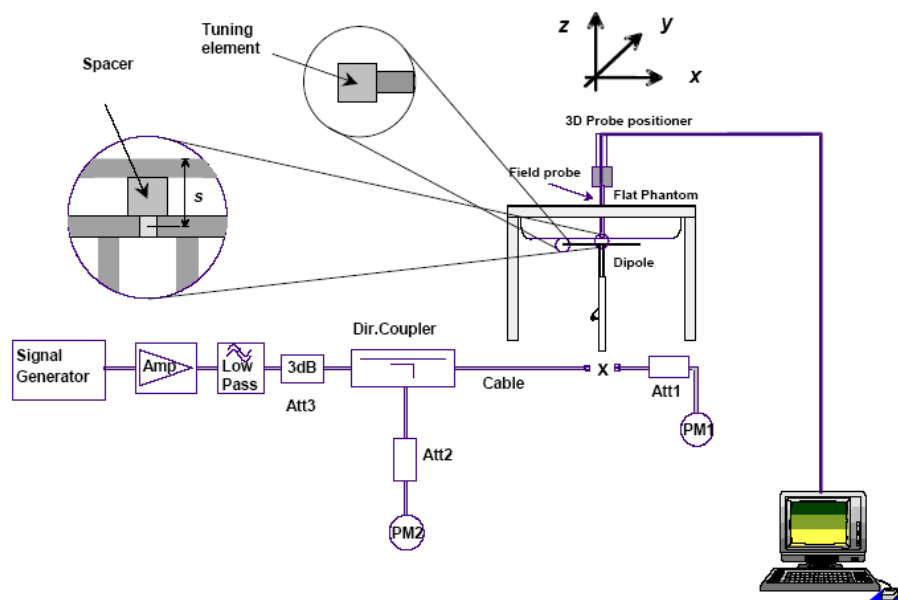

System Accuracy Check Results

Frequency (MHz)	1 g SAR (W/Kg)	10 g SAR (W/Kg)	Result
835	9.630	6.027	In Tolerance
1900	40.346	20.526	In Tolerance

- Note: The system verification data is 2010-12-05
All SAR values are normalized to 1 Watt forward power.

IEEE P1528 recommended reference value for Head Tissue

Frequency (MHz)	1 g SAR (W/Kg)	10 g SAR (W/Kg)	Local SAR at surface (above feed point)	Local SAR at surface (v=2cm offset from feed point)
300	3.0	2.0	4.4	2.1
450	4.9	3.3	7.2	3.2
835	9.5	6.2	14.1	4.9
900	10.8	6.9	16.4	5.4
1450	29.0	16.0	50.2	6.5
1800	38.1	19.8	69.5	6.8
1900	39.7	20.5	72.1	6.6
2000	41.1	21.1	74.6	6.5
2450	52.4	24.0	104.2	7.7
3000	63.8	25.7	140.2	9.5

EUT TEST STRATEGY AND METHODOLOGY

Test Positions for Device Operating Next to a Person’s Ear

This category includes most wireless handsets with fixed, retractable or internal antennas located toward the top half of the device, with or without a foldout, sliding or similar keypad cover. The handset should have its earpiece located within the upper ¼ of the device, either along the centerline or off-centered, as perceived by its users. This type of handset should be positioned in a normal operating position with the “test device reference point” located along the “vertical centerline” on the front of the device aligned to the “ear reference point”. The “test device reference point” should be located at the same level as the center of the earpiece region. The “vertical centerline” should bisect the front surface of the handset at its top and bottom edges. A “ear reference point” is located on the outer surface of the head phantom on each ear spacer. It is located 1.5 cm above the center of the ear canal entrance in the “phantom reference plane” defined by the three lines joining the center of each “ear reference point” (left and right) and the tip of the mouth.

A handset should be initially positioned with the earpiece region pressed against the ear spacer of a head phantom. For the SCC-34/SC-2 head phantom, the device should be positioned parallel to the “N-F” line defined along the base of the ear spacer that contains the “ear reference point”. For interim head phantoms, the device should be positioned parallel to the cheek for maximum RF energy coupling. The “test device reference point” is aligned to the “ear reference point” on the head phantom and the “vertical centerline” is aligned to the “phantom reference plane”. This is called the “initial ear position”. While maintaining these three alignments, the body of the handset is gradually adjusted to each of the following positions for evaluating SAR:

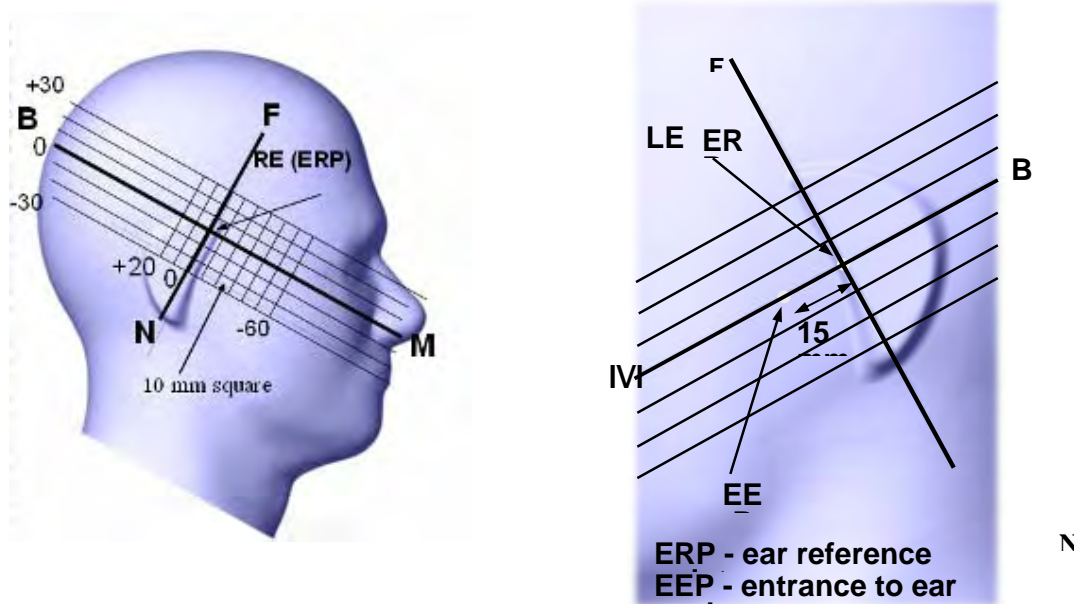

Check/Touch Position

The device is brought toward the mouth of the head phantom by pivoting against the “ear reference point” or along the “N-F” line for the SCC-34/SC-2 head phantom.

This test position is established:

- When any point on the display, keypad or mouthpiece portions of the handset is in contact with the phantom.
- (or) When any portion of a foldout, sliding or similar keypad cover opened to its intended self-adjusting normal use position is in contact with the cheek or mouth of the phantom.

For existing head phantoms – when the handset loses contact with the phantom at the pivoting point, rotation should continue until the device touches the cheek of the phantom or breaks its last contact from the ear spacer.

Check /Touch Position

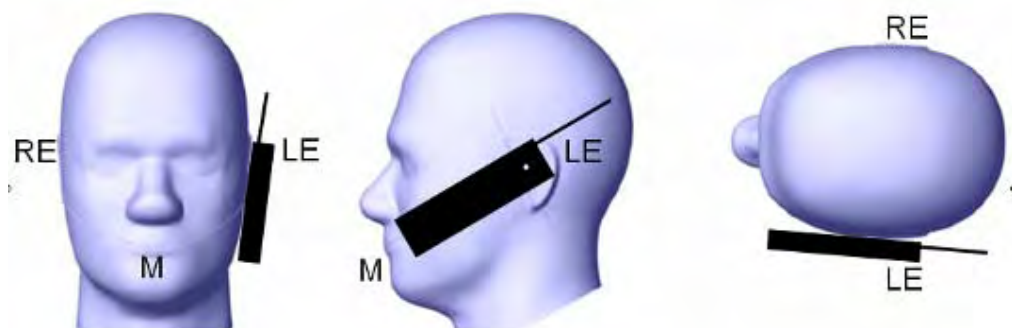

Ear/Tilt Position

With the handset aligned in the “Cheek/Touch Position”:

1) If the earpiece of the handset is not in full contact with the phantom’s ear spacer (in the “Cheek/Touch position”) and the peak SAR location for the “Cheek/Touch” position is located at the ear spacer region or corresponds to the earpiece region of the handset, the device should be returned to the “initial ear position” by rotating it away from the mouth until the earpiece is in full contact with the ear spacer.

2) (otherwise) The handset should be moved (translated) away from the cheek perpendicular to the line passes through both “ear reference points” (note: one of these ear reference points may not physically exist on a split head model) for approximate 2-3 cm. While it is in this position, the device handset is tilted away from the mouth with respect to the “test device reference point” until the inside angle between the vertical centerline on the front surface of the phone and the horizontal line passing through the ear reference point is by 15 80°. After the tilt, it is then moved (translated) back toward the head perpendicular to the line passes through both “ear reference points” until the device touches the phantom or the ear spacer. If the antenna touches the head first, the positioning process should be repeated with a tilt angle less than 15° so that the device and its antenna would touch the phantom simultaneously. This test position may require a device holder or positioner to achieve the translation and tilting with acceptable positioning repeatability.

If a device is also designed to transmit with its keypad cover closed for operating in the head position, such positions should also be considered in the SAR evaluation. The device should be tested on the left and right side of the head phantom in the “Cheek/Touch” and “Ear/Tilt” positions. When applicable, each configuration should be tested with the antenna in its fully extended and fully retracted positions. These test configurations should be tested at the high, middle and low frequency channels of each operating mode; for example, AMPS, CDMA, and TDMA. If the SAR measured at the middle channel for each test configuration (left, right, Cheek/Touch, Tile/Ear, extended and retracted) is at least 2.0 dB lower than the SAR limit, testing at the high and low channels is optional for such test configuration(s). If the transmission band of the test device is less than 10 MHz, testing at the high and low frequency channels is optional.

Ear /Tilt 15° Position

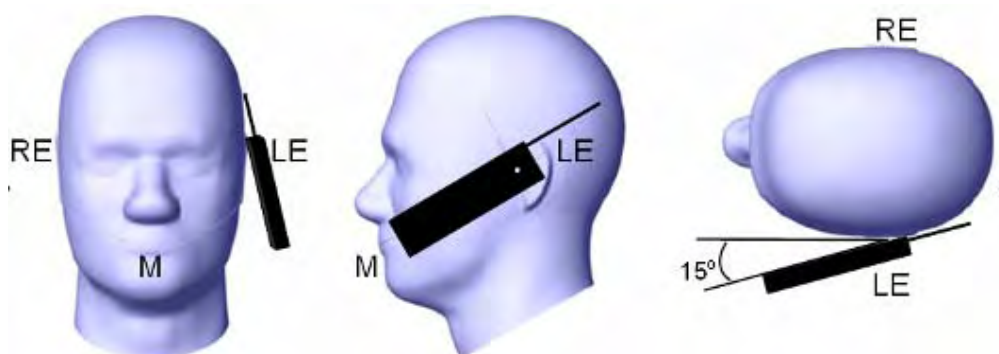

Test positions for body-worn and other configurations

Body-worn operating configurations should be tested with the belt-clips and holsters attached to the device and positioned against a flat phantom in normal use configurations. Devices with a headset output should be tested with a headset connected to the device. When multiple accessories that do not contain metallic components are supplied with the device, the device may be tested with only the accessory that dictates the closest spacing to the body. When multiple accessories that contain metallic components are supplied with the device, the device must be tested with each accessory that contains a unique metallic component. If multiple accessories share an identical metallic component (e.g., the same metallic belt-clip used with different holsters with no other metallic components), only the accessory that dictates the closest spacing to the body must be tested.

Body-worn accessories may not always be supplied or available as options for some devices that are intended to be authorized for body-worn use. A separation distance of 1.5 cm between the back of the device and a flat phantom is recommended for testing body-worn SAR compliance under such circumstances. Other separation distances may be used, but they should not exceed 2.5 cm. In these cases, the device may use body-worn accessories that provide a separation distance greater than that tested for the device provided however that the accessory contains no metallic components.

SAR Evaluation Procedure

The evaluation was performed with the following procedure:

Step 1: Measurement of the SAR value at a fixed location above the ear point or central position was used as a reference value for assessing the power drop. The SAR at this point is measured at the start of the test and then again at the end of the testing.

Step 2: The SAR distribution at the exposed side of the head was measured at a distance of 4 mm from the inner surface of the shell. The area covered the entire dimension of the head or EUT and the horizontal grid spacing was 15 mm x 15 mm. Based on these data, the area of the maximum absorption was determined by spline interpolation. The first Area Scan covers the entire dimension of the EUT to ensure that the hotspot was correctly identified.

Step 3: Around this point, a volume of 30 mm x 30 mm x 21 mm was assessed by measuring 5 x 5 x 7 points. On the basis of this data set, the spatial peak SAR value was evaluated under the following procedure:

- 1) The data at the surface were extrapolated, since the center of the dipoles is 1.2 mm away from the tip of the probe and the distance between the surface and the lowest measuring point is 1.3 mm. The extrapolation was based on a least square algorithm. A polynomial of the fourth order was calculated through the points in z-axes. This polynomial was then used to evaluate the points between the surface and the probe tip.
- 2) The maximum interpolated value was searched with a straightforward algorithm. Around this maximum the SAR values averaged over the spatial volumes (1 g or 10 g) were computed by the 3D-Spline interpolation algorithm. The 3D-Spline is composed of three one dimensional splines with the "Not a knot"-condition (in x, y and z-directions). The volume was integrated with the trapezoidal-algorithm. One thousand points (10 x 10 x 10) were interpolated to calculate the averages.

All neighboring volumes were evaluated until no neighboring volume with a higher average value was found.

Step 4: Re-measurement of the SAR value at the same location as in Step 1. If the value changed by more than 5%, the evaluation was repeated.

SAR SIMULTANEOUS TRANSMISSION EVALUATION

KDB648474 Simultaneous Transmission Consideration

Stand-alone and simultaneous SAR evaluation for a cell phone with multiple transmitters is based on the antennas distance of each radio.

BT and GSM Antenna Location

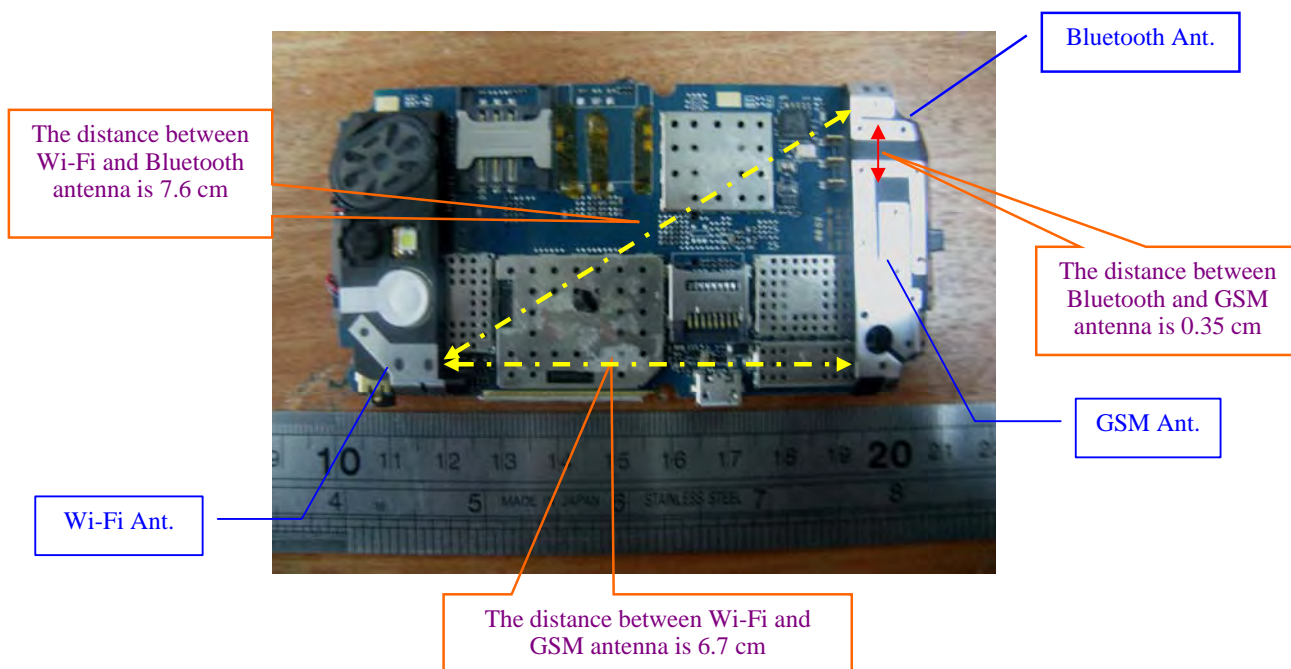

Conclusion

Individual transmitter	Stand-alone SAR	Simultaneous SAR
Bluetooth	Not required	GSM with Bluetooth is not required
Wi-Fi	Not required	GSM with Wi-Fi is not required
GSM	Required	Bluetooth with Wi-Fi is not required

Note:

- 1) The distance between BT and GSM antenna is 0.35 cm < 2.5 cm, the max EIRP output power of Bluetooth antenna is 0.581 mW ≤ P_{Ref} (12mW) .According to KDB648474, stand-alone SAR is not required for BT antenna.
- 2) The distance between Wi-Fi and GSM antenna is 6.7 cm > 5.0 cm, the max EIRP output power of Wi-Fi antenna is 22.44 mW ≤ 2*P_{Ref} (24 mW) .According to KDB648474, stand-alone SAR is not required for Wi-Fi antenna .

SAR MEASUREMENT RESULTS

This page summarizes the results of the performed dosimetric evaluation. The plots with the corresponding SAR distributions, which reveal information about the location of the maximum SAR with respect to the device, could be found in Appendix E.

SAR Test Data

Environmental Conditions

Temperature:	22° C
Relative Humidity:	52%
ATM Pressure:	1005 mbar

* Testing was performed by Chris You on 2010.12.05---2010.12.09.

Cellular Band:

EUT Position	Channel/Frequency		Test Mode	Antenna Type	1g SAR Value (W/Kg)	FCC Limit (W/Kg)
	Channel	(MHz)				
Left Head Cheek	128 (Low)	824.2	GSM	Integral	-	1.6
	190 (Middle)	836.6	GSM	Integral	0.244	1.6
	251 (High)	848.8	GSM	Integral	-	1.6
Left Head Tilt	128 (Low)	824.2	GSM	Integral	-	1.6
	190 (Middle)	836.6	GSM	Integral	0.186	1.6
	251 (High)	848.8	GSM	Integral	-	1.6
Right Head Cheek	128 (Low)	824.2	GSM	Integral	0.237	1.6
	190 (Middle)	836.6	GSM	Integral	0.298	1.6
	251 (High)	848.8	GSM	Integral	0.267	1.6
Right Head Tilt	128 (Low)	824.2	GSM	Integral	-	1.6
	190 (Middle)	836.6	GSM	Integral	0.196	1.6
	251 (High)	848.8	GSM	Integral	-	1.6
Body-Worn Back	190 (Middle)	836.6	GSM	Integral	0.458	1.6
	128 (Low)	824.2	GPRS	Integral	0.820	1.6
	190 (Middle)	836.6	GPRS	Integral	0.898	1.6
	251 (High)	848.8	GPRS	Integral	0.842	1.6

PCS Band:

EUT Position	Channel/Frequency		Test Mode	Antenna Type	1g SAR Value (W/Kg)	FCC Limit (W/Kg)
	Channel	(MHz)				
Left Head Cheek	512 (Low)	1850.2	GSM	Integral	-	1.6
	661 (Middle)	1880.0	GSM	Integral	-	1.6
	810 (High)	1909.8	GSM	Integral	0.642	1.6
Left Head Tilt	512 (Low)	1850.2	GSM	Integral	-	1.6
	661 (Middle)	1880.0	GSM	Integral	-	1.6
	810 (High)	1909.8	GSM	Integral	0.312	1.6
Right Head Cheek	512 (Low)	1850.2	GSM	Integral	0.637	1.6
	661 (Middle)	1880.0	GSM	Integral	0.608	1.6
	810 (High)	1909.8	GSM	Integral	0.653	1.6
Right Head Tilt	512 (Low)	1850.2	GSM	Integral	-	1.6
	661 (Middle)	1880.0	GSM	Integral	-	1.6
	810 (High)	1909.8	GSM	Integral	0.328	1.6
Body-Worn Back	810 (High)	1909.8	GSM	Integral	0.438	1.6
	512 (Low)	1850.2	GPRS	Integral	0.835	1.6
	661 (Middle)	1880.0	GPRS	Integral	0.803	1.6
	810 (High)	1909.8	GPRS	Integral	0.847	1.6

Note: 2 slots configuration of GPRS mode is the worse-case of body-worn position.

APPENDIX A – MEASUREMENT UNCERTAINTY

The uncertainty budget has been determined for the measurement system and is given in the following Table.

Exposure Assessment Measurement Uncertainty

Source of Uncertainty	Tolerance Value	Probability Distribution	Divisor	c_i^1 (1-g)	c_i^1 (10-g)	Standard Uncertainty (1-g) %	Standard Uncertainty (10-g) %
Measurement System							
Probe Calibration	3.5	normal	1	1	1	3.5	3.5
Axial Isotropy	3.7	rectangular	$\sqrt{3}$	$(1-cp)^{1/2}$	$(\frac{1-cp}{2})^{1/2}$	1.5	1.5
Hemispherical Isotropy	10.9	rectangular	$\sqrt{3}$	\sqrt{cp}	\sqrt{cp}	4.4	4.4
Boundary Effect	1.0	rectangular	$\sqrt{3}$	1	1	0.6	0.6
Linearity	4.7	rectangular	$\sqrt{3}$	1	1	2.7	2.7
Detection Limit	1.0	rectangular	$\sqrt{3}$	1	1	0.6	0.6
Readout Electronics	1.0	normal	1	1	1	1.0	1.0
Response Time	0.8	rectangular	$\sqrt{3}$	1	1	0.5	0.5
Integration Time	1.7	rectangular	$\sqrt{3}$	1	1	1.0	1.0
RF Ambient Condition	3.0	rectangular	$\sqrt{3}$	1	1	1.7	1.7
Probe Positioner Mech.	0.4	rectangular	$\sqrt{3}$	1	1	0.2	0.2
Restriction							
Probe Positioning with respect to Phantom Shell	2.9	rectangular	$\sqrt{3}$	1	1	1.7	1.7
Extrapolation and Integration	3.7	rectangular	$\sqrt{3}$	1	1	2.1	2.1
Test Sample Positioning	4.0	normal	1	1	1	4.0	4.0
Device Holder Uncertainty	2.0	normal	1	1	1	2.0	2.0
Drift of Output Power	3.2	rectangular	$\sqrt{3}$	1	1	1.8	1.8
Phantom and Setup							
Phantom Uncertainty(shape & thickness tolerance)	3.4	rectangular	$\sqrt{3}$	1	1	2.0	2.0
Liquid Conductivity(target)	5.0	rectangular	$\sqrt{3}$	0.7	0.5	2.0	1.4
Liquid Conductivity(meas.)	0.0	normal	1	0.7	0.5	0.0	0.0
Liquid Permittivity(target)	5.0	rectangular	$\sqrt{3}$	0.6	0.5	1.7	1.4
Liquid Permittivity(meas.)	0.0	normal	1	0.6	0.5	0.0	0.0
Combined Uncertainty		RSS				9.4	9.2
Combined Uncertainty (coverage factor=2)		Normal(k=2)				18.8	18.5

APPENDIX B – PROBE CALIBRATION CERTIFICATES

NCL CALIBRATION LABORATORIES

Calibration File No.: CP-1139

Client.: BACL

CERTIFICATE OF CALIBRATION

It is certified that the equipment identified below has been calibrated in the **NCL CALIBRATION LABORATORIES** by qualified personnel following recognized procedures and using transfer standards traceable to NRC/NIST.

Equipment: Miniature Isotropic RF Probe 835 MHz

Manufacturer: APREL Laboratories

Model No.: E-020

Serial No.: 273

Calibration in Head Tissue

Calibration Procedure: SSI/DRB-TP-D01-032-E020-V2

Project No: BACB-E020-5537

Calibrated: 20th August 2010

Released on: 24th August 2010

This Calibration Certificate is Incomplete Unless Accompanied with the Calibration Results Summary

Released By: _____

NCL CALIBRATION LABORATORIES

51 SPECTRUM WAY
NEPEAN, ONTARIO
CANADA K2R 1E6

Division of APREL Lab.
TEL: (613) 820-4988
FAX: (613) 820-4161

NCL Calibration Laboratories

Division of APREL Laboratories.

Introduction

This Calibration Report reproduces the results of the calibration performed in line with the SSI/DRB-TP-D01-032-E020-V2 E-Field Probe Calibration Procedure. The results contained within this report are for APREL E-Field Probe E-020 273.

References

SSI/DRB-TP-D01-032-E020-V2 E-Field Probe Calibration Procedure
IEEE 1528 "Recommended Practice for Determining the Peak Spatial-Average Specific Absorption Rate (SAR) in the Human Body Due to Wireless Communications Devices: Experimental Techniques"
SSI-TP-011 Tissue Calibration Procedure

Conditions

Probe 273 was a re-calibration.

Ambient Temperature of the Laboratory: 22 °C +/- 0.5°C
Temperature of the Tissue: 21 °C +/- 0.5°C

We the undersigned attest that to the best of our knowledge the calibration of this probe has been accurately conducted and that all information contained within this report has been reviewed for accuracy.

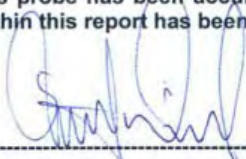

Stuart Nicol



Jesse Hones

Page 2 of 10
This page has been reviewed for content and attested to on Page 2 of this document.

NCL Calibration Laboratories

Division of APREL Laboratories.

Calibration Results Summary

Probe Type:	E-Field Probe E-020
Serial Number:	273
Frequency:	835 MHz
Sensor Offset:	1.56 mm
Sensor Length:	2.5 mm
Tip Enclosure:	Ertalyte*
Tip Diameter:	<5 mm
Tip Length:	60 mm
Total Length:	290 mm

*Resistive to recommended tissue recipes per IEEE-1528

Sensitivity in Air

Channel X:	1.2 $\mu\text{V}/(\text{V}/\text{m})^2$
Channel Y:	1.2 $\mu\text{V}/(\text{V}/\text{m})^2$
Channel Z:	1.2 $\mu\text{V}/(\text{V}/\text{m})^2$
Diode Compression Point:	95 mV

Page 3 of 10

This page has been reviewed for content and attested to on Page 2 of this document.

NCL Calibration Laboratories

Division of APREL Laboratories.

Sensitivity in Head Tissue Measured

Frequency: 835 MHz
Epsilon: 41.04 (+/-5%) **Sigma:** 0.89 S/m (+/-5%)

ConvF

Channel X: 6.5
Channel Y: 6.5
Channel Z: 6.5

Tissue sensitivity values were calculated using the load impedance of the APREL Laboratories Daq-Paq.

Boundary Effect:

Uncertainty resulting from the boundary effect is less than 2% for the distance between the tip of the probe and the tissue boundary, when less than 2.44mm.

Spatial Resolution:

The measured probe tip diameter is 5 mm (+/- 0.01 mm) and therefore meets the requirements of SSI/DRB-TP-D01-032 for spatial resolution.

Page 4 of 10

This page has been reviewed for content and attested to on Page 2 of this document.

NCL Calibration Laboratories

Division of APREL Laboratories.

Receiving Pattern 835 MHz (Air)

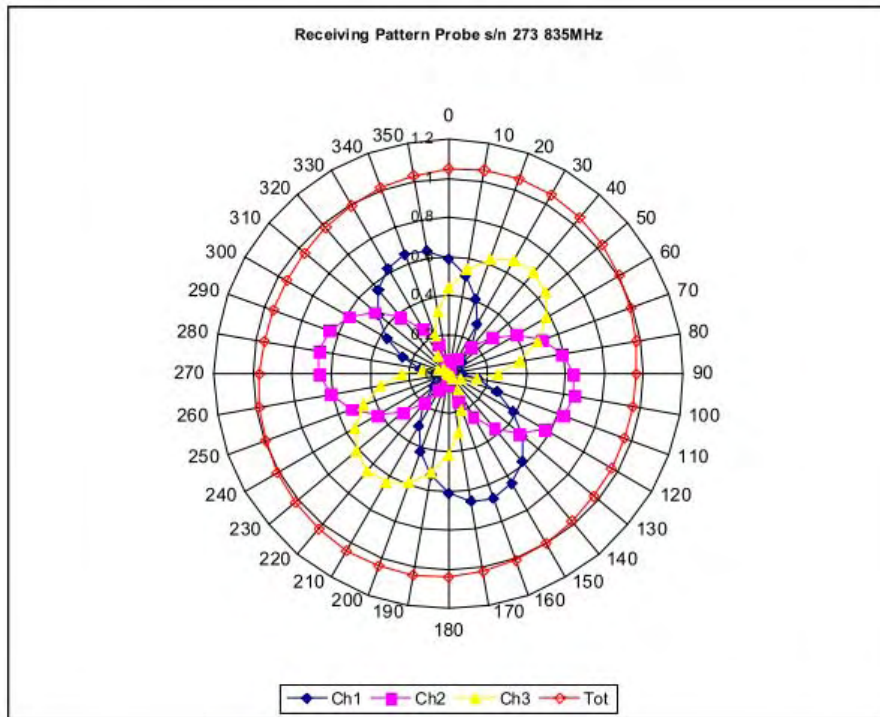

NCL Calibration Laboratories

Division of APREL Laboratories.

Isotropy Error 835 MHz (Air)

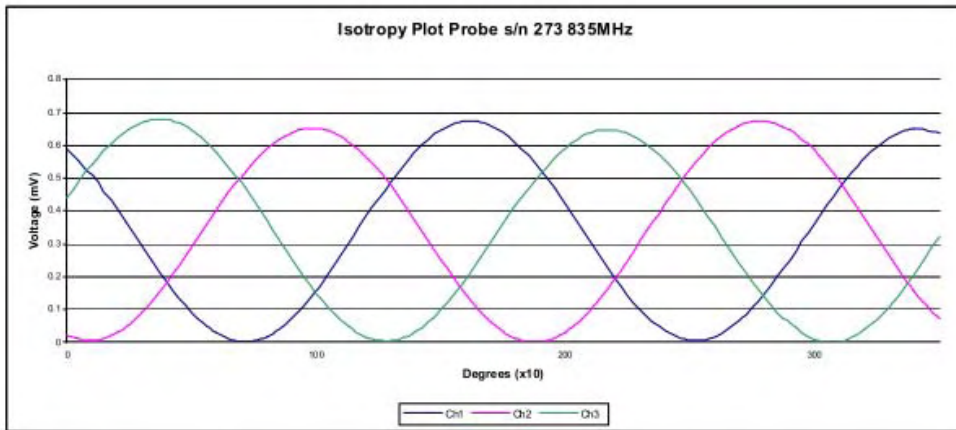
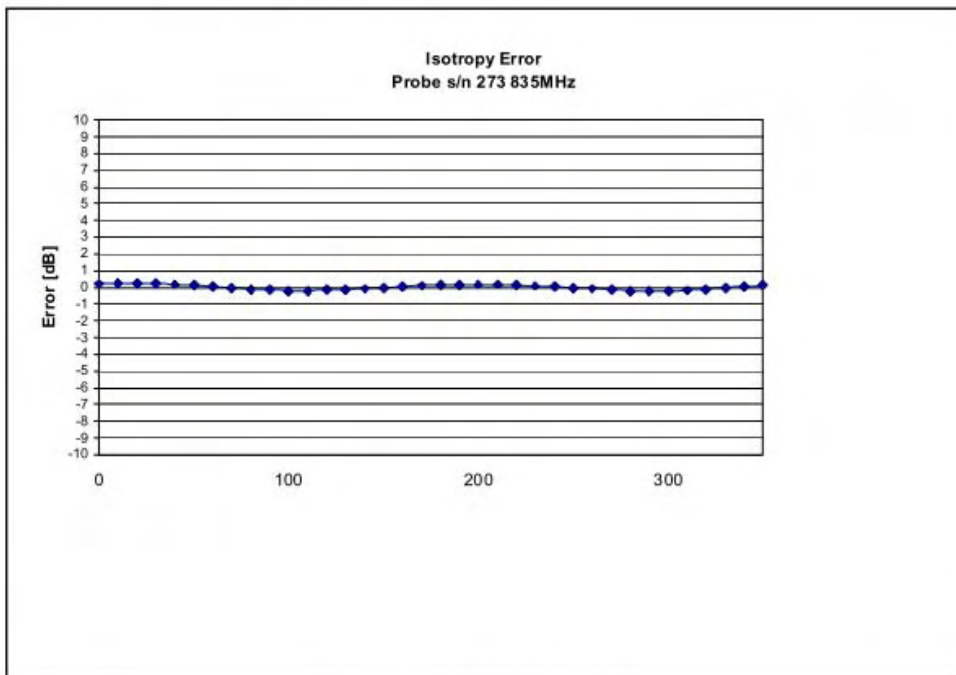

Isotropicity Tissue: 0.10 dB

Page 6 of 10
This page has been reviewed for content and attested to on Page 2 of this document.

NCL Calibration Laboratories

Division of APREL Laboratories.

Dynamic Range

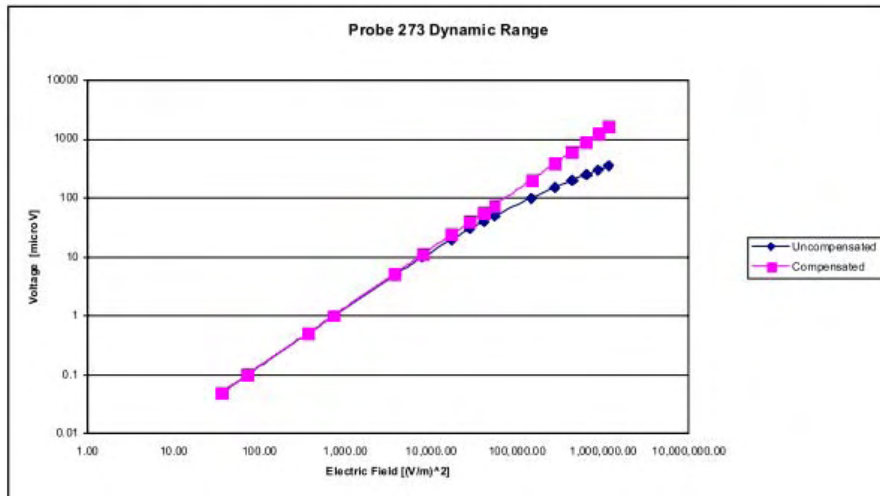

NCL Calibration Laboratories

Division of APREL Laboratories.

Video Bandwidth

Probe Frequency Characteristics

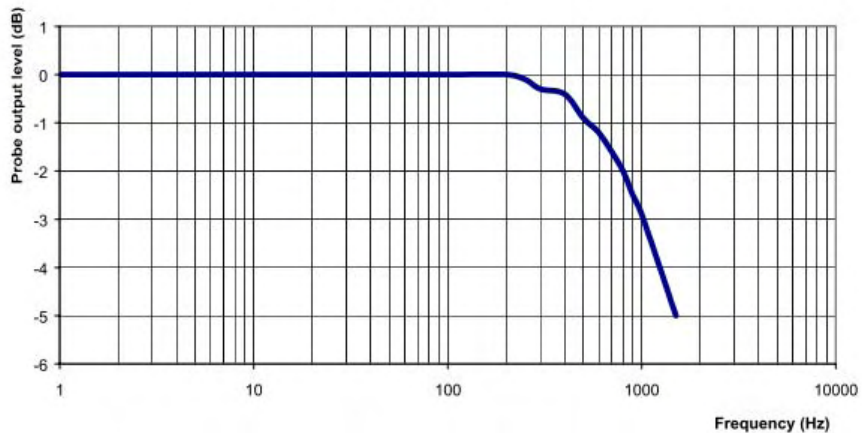

Video Bandwidth at 500 Hz 1 dB
Video Bandwidth at 1.02 KHz: 3 dB

Page 8 of 10
This page has been reviewed for content and attested to on Page 2 of this document.

NCL Calibration Laboratories

Division of APREL Laboratories.

Conversion Factor Uncertainty Assessment

Frequency: 835MHz
Epsilon: 41.04 (+/-5%) **Sigma:** 0.89 S/m (+/-5%)

ConvF

Channel X: 6.5 7%(K=2)
Channel Y: 6.5 7%(K=2)
Channel Z: 6.5 7%(K=2)

To minimize the uncertainty calculation all tissue sensitivity values were calculated using a load impedance of 5 M Ω .

Boundary Effect:

For a distance of 2.5mm the evaluated uncertainty (increase in the probe sensitivity) is less than 2%.

Page 9 of 10

This page has been reviewed for content and attested to on Page 2 of this document.

NCL Calibration Laboratories

Division of APREL Laboratories.

Test Equipment

The test equipment used during Probe Calibration, manufacturer, model number and, current calibration status are listed and located on the main APREL server R:\NCL\Calibration Equipment\Instrument List May 2010.

Page 10 of 10

This page has been reviewed for content and attested to on Page 2 of this document.

NCL CALIBRATION LABORATORIES

Calibration File No.: CP-1140

Client.: BACL

CERTIFICATE OF CALIBRATION

It is certified that the equipment identified below has been calibrated in the **NCL CALIBRATION LABORATORIES** by qualified personnel following recognized procedures and using transfer standards traceable to NRC/NIST.

Equipment: Miniature Isotropic RF Probe 835 MHz

Manufacturer: APREL Laboratories

Model No.: E-020

Serial No.: 273

Calibration in Body Tissue

Calibration Procedure: SSI/DRB-TP-D01-032-E020-V2

Project No: BACB-E020-5537

Calibrated: 20th August 2010
Released on: 24th August 2010

This Calibration Certificate is Incomplete Unless Accompanied with the Calibration Results Summary

Released By: _____

NCL CALIBRATION LABORATORIES

51 SPECTRUM WAY
NEPEAN, ONTARIO
CANADA K2R 1E6

Division of APREL Lab.
TEL: (613) 820-4988
FAX: (613) 820-4161

NCL Calibration Laboratories

Division of APREL Laboratories.

Introduction

This Calibration Report reproduces the results of the calibration performed in line with the SSI/DRB-TP-D01-032-E020-V2 E-Field Probe Calibration Procedure. The results contained within this report are for APREL E-Field Probe E-020 273.

References

SSI/DRB-TP-D01-032-E020-V2 E-Field Probe Calibration Procedure
IEEE 1528 "Recommended Practice for Determining the Peak Spatial-Average Specific Absorption Rate (SAR) in the Human Body Due to Wireless Communications Devices: Experimental Techniques"
SSI-TP-011 Tissue Calibration Procedure

Conditions

Probe 273 was a re- calibration.

Ambient Temperature of the Laboratory: 22 °C +/- 0.5°C

Temperature of the Tissue: 21 °C +/- 0.5°C

We the undersigned attest that to the best of our knowledge the calibration of this probe has been accurately conducted and that all information contained within this report has been reviewed for accuracy.

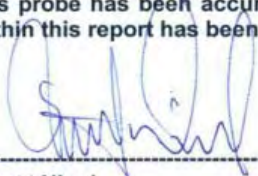

Stuart Nicol

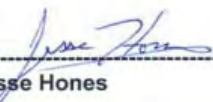

Jesse Hones

Page 2 of 10

This page has been reviewed for content and attested to on Page 2 of this document.

NCL Calibration Laboratories

Division of APREL Laboratories.

Calibration Results Summary

Probe Type: E-Field Probe E-020
Serial Number: 273
Frequency: 835 MHz
Sensor Offset: 1.56 mm
Sensor Length: 2.5 mm
Tip Enclosure: Ertalyte*
Tip Diameter: <5 mm
Tip Length: 60 mm
Total Length: 290 mm

*Resistive to recommended tissue recipes per IEEE-1528

Sensitivity in Air

Channel X: 1.2 $\mu\text{V}/(\text{V}/\text{m})^2$
Channel Y: 1.2 $\mu\text{V}/(\text{V}/\text{m})^2$
Channel Z: 1.2 $\mu\text{V}/(\text{V}/\text{m})^2$
Diode Compression Point: 95 mV

Page 3 of 10
This page has been reviewed for content and attested to on Page 2 of this document.

NCL Calibration Laboratories

Division of APREL Laboratories.

Sensitivity in Body Tissue Measured**Frequency:** 835 MHz**Epsilon:** 55.91 (+/-5%) **Sigma:** 0.98 S/m (+/-5%)**ConvF****Channel X:** 6.7**Channel Y:** 6.7**Channel Z:** 6.7

Tissue sensitivity values were calculated using the load impedance of the APREL Laboratories Daq-Paq.

Boundary Effect:

Uncertainty resulting from the boundary effect is less than 2% for the distance between the tip of the probe and the tissue boundary, when less than 2.44mm.

Spatial Resolution:

The measured probe tip diameter is 5 mm (+/- 0.01 mm) and therefore meets the requirements of SSI/DRB-TP-D01-032 for spatial resolution.

Page 4 of 10

This page has been reviewed for content and attested to on Page 2 of this document.

NCL Calibration Laboratories

Division of APREL Laboratories.

Receiving Pattern 835 MHz (Air)

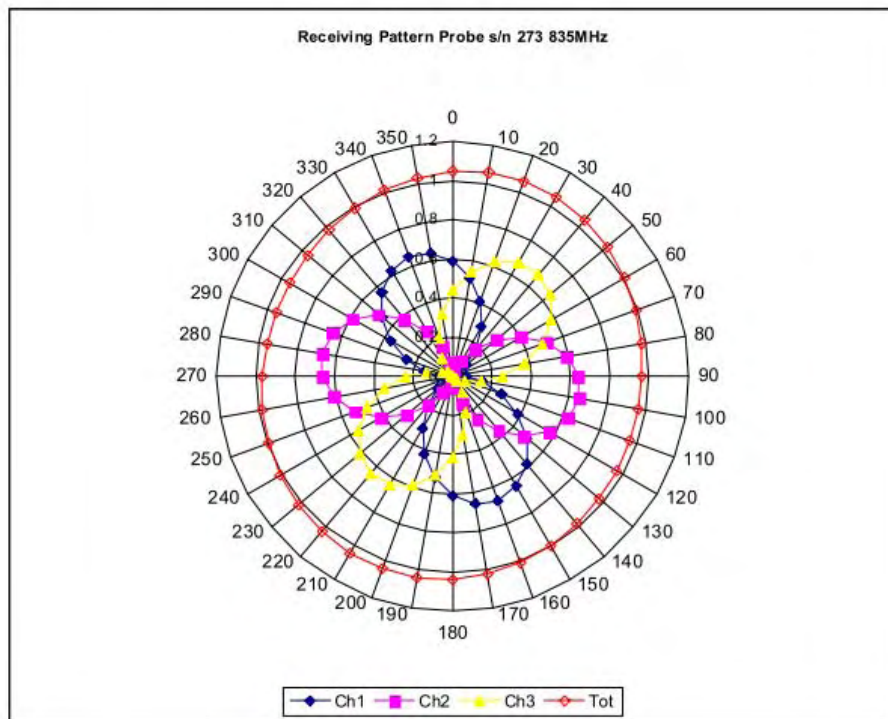

Page 5 of 10

This page has been reviewed for content and attested to on Page 2 of this document.

NCL Calibration Laboratories

Division of APREL Laboratories.

Isotropy Error 835 MHz (Air)

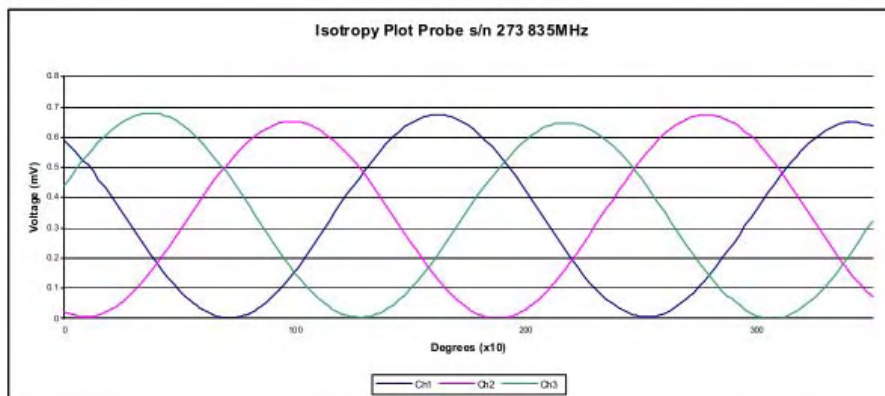
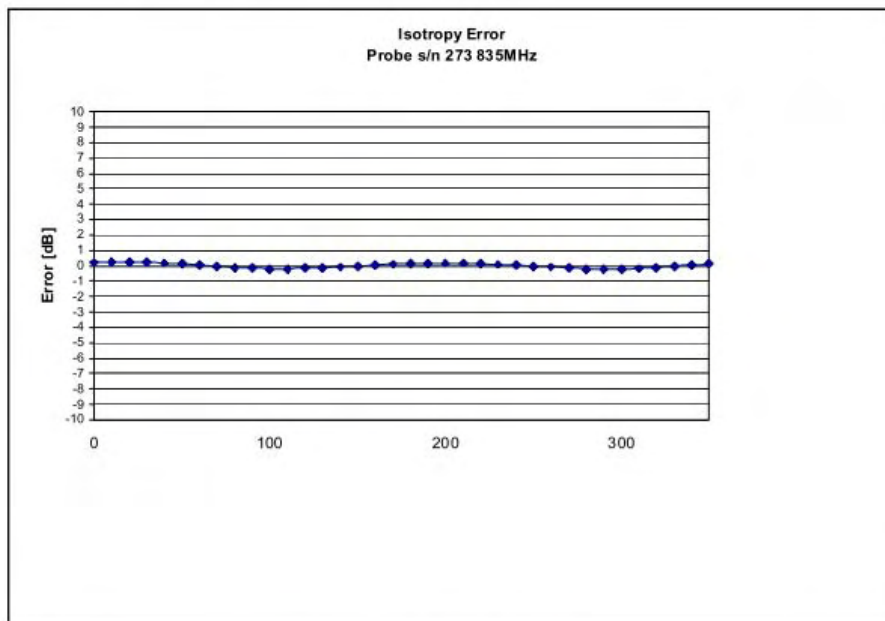

Isotropicity in Tissue: 0.10 dB

Page 6 of 10
This page has been reviewed for content and attested to on Page 2 of this document.

NCL Calibration Laboratories

Division of APREL Laboratories.

Dynamic Range

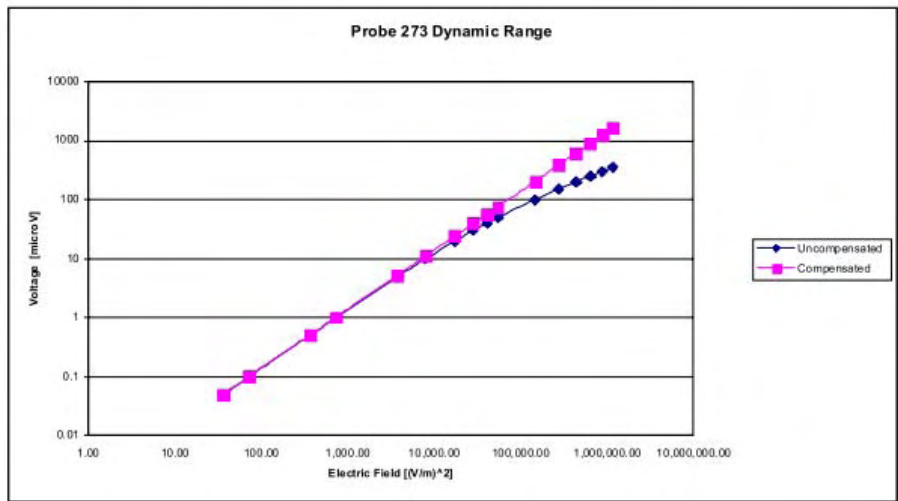

Page 7 of 10
This page has been reviewed for content and attested to on Page 2 of this document.

NCL Calibration Laboratories

Division of APREL Laboratories.

Video Bandwidth

Probe Frequency Characteristics

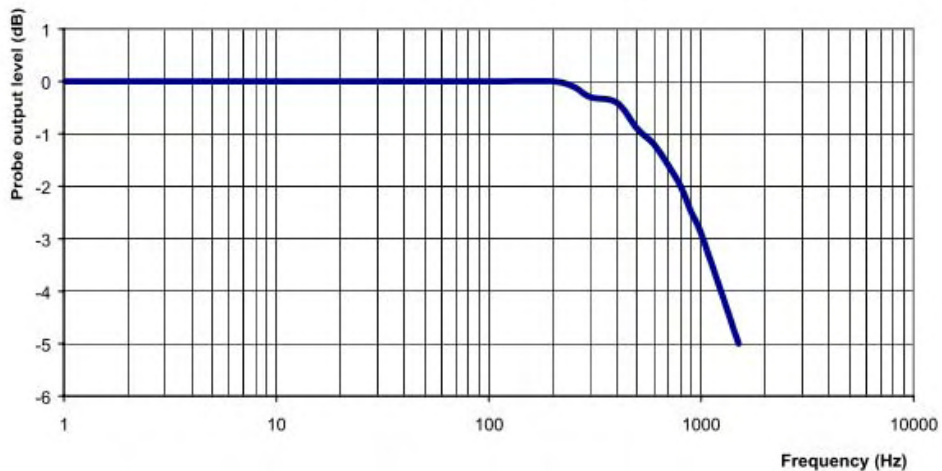

Video Bandwidth at 500 Hz 1 dB
Video Bandwidth at 1.02 KHz: 3 dB

NCL Calibration Laboratories

Division of APREL Laboratories.

Conversion Factor Uncertainty Assessment

Frequency: 835MHz
Epsilon: 55.91 (+/-5%) **Sigma:** 0.98 S/m (+/-5%)

ConvF

Channel X: 6.7 7%(K=2)
Channel Y: 6.7 7%(K=2)
Channel Z: 6.7 7%(K=2)

To minimize the uncertainty calculation all tissue sensitivity values were calculated using a load impedance of 5 MΩ.

Boundary Effect:

For a distance of 2.4mm the evaluated uncertainty (increase in the probe sensitivity) is less than 2%.

Page 9 of 10
This page has been reviewed for content and attested to on Page 2 of this document.

NCL Calibration Laboratories

Division of APREL Laboratories.

Test Equipment

The test equipment used during Probe Calibration, manufacturer, model number and, current calibration status are listed and located on the main APREL server R:\NCL\Calibration Equipment\Instrument List May 2010.

Page 10 of 10

This page has been reviewed for content and attested to on Page 2 of this document.

NCL CALIBRATION LABORATORIES

Calibration File No.: CP-1141

Client.: BACL

CERTIFICATE OF CALIBRATION

It is certified that the equipment identified below has been calibrated in the **NCL CALIBRATION LABORATORIES** by qualified personnel following recognized procedures and using transfer standards traceable to NRC/NIST.

Equipment: Miniature Isotropic RF Probe 1900 MHz

Manufacturer: APREL Laboratories

Model No.: E-020

Serial No.: 273

Calibration in Head Tissue

Calibration Procedure: SSI/DRB-TP-D01-032-E020-V2

Project No: BACB-E020-5537

Calibrated: 21st August 2010

Released on: 24th August 2010

This Calibration Certificate is incomplete unless accompanied with the Calibration Results Summary

Released By: _____

NCL CALIBRATION LABORATORIES

51 SPECTRUM WAY
NEPEAN, ONTARIO
CANADA K2R 1E6

Division of APREL Lab.
TEL: (613) 820-4988
FAX: (613) 820-4161

NCL Calibration Laboratories

Division of APREL Laboratories.

Introduction

This Calibration Report reproduces the results of the calibration performed in line with the SSI/DRB-TP-D01-032-E020-V2 E-Field Probe Calibration Procedure. The results contained within this report are for APREL E-Field Probe E-020 273.

References

SSI/DRB-TP-D01-032-E020-V2 E-Field Probe Calibration Procedure
IEEE 1528 "Recommended Practice for Determining the Peak Spatial-Average Specific Absorption Rate (SAR) in the Human Body Due to Wireless Communications Devices: Experimental Techniques"
SSI-TP-011 Tissue Calibration Procedure

Conditions

Probe 273 was a re-calibration.

Ambient Temperature of the Laboratory: 22 °C +/- 0.5°C
Temperature of the Tissue: 21 °C +/- 0.5°C

We the undersigned attest that to the best of our knowledge the calibration of this probe has been accurately conducted and that all information contained within this report has been reviewed for accuracy.



Stuart Nicol



Jesse Hones

Page 2 of 10
This page has been reviewed for content and attested to on Page 2 of this document.

NCL Calibration Laboratories

Division of APREL Laboratories.

Calibration Results Summary

Probe Type:	E-Field Probe E-020
Serial Number:	273
Frequency:	1900 MHz
Sensor Offset:	1.56 mm
Sensor Length:	2.5 mm
Tip Enclosure:	Ertalyte*
Tip Diameter:	<5 mm
Tip Length:	60 mm
Total Length:	290 mm

*Resistive to recommended tissue recipes per IEEE-1528

Sensitivity in Air

Channel X:	1.2 $\mu\text{V}/(\text{V}/\text{m})^2$
Channel Y:	1.2 $\mu\text{V}/(\text{V}/\text{m})^2$
Channel Z:	1.2 $\mu\text{V}/(\text{V}/\text{m})^2$
Diode Compression Point:	95 mV

Page 3 of 10

This page has been reviewed for content and attested to on Page 2 of this document.

NCL Calibration Laboratories

Division of APREL Laboratories.

Sensitivity in Head Tissue Measured**Frequency:** 1900 MHz**Epsilon:** 38.90 (+/-5%) **Sigma:** 1.39 S/m (+/-5%)**ConvF****Channel X:** 5.25**Channel Y:** 5.25**Channel Z:** 5.25

Tissue sensitivity values were calculated using the load impedance of the APREL Laboratories Daq-Paq.

Boundary Effect:

Uncertainty resulting from the boundary effect is less than 2% for the distance between the tip of the probe and the tissue boundary, when less than 2.44mm.

Spatial Resolution:

The measured probe tip diameter is 5 mm (+/- 0.01 mm) and therefore meets the requirements of SSI/DRB-TP-D01-032 for spatial resolution.

Page 4 of 10

This page has been reviewed for content and attested to on Page 2 of this document.

NCL Calibration Laboratories

Division of APREL Laboratories.

Receiving Pattern 1900 MHz (Air)

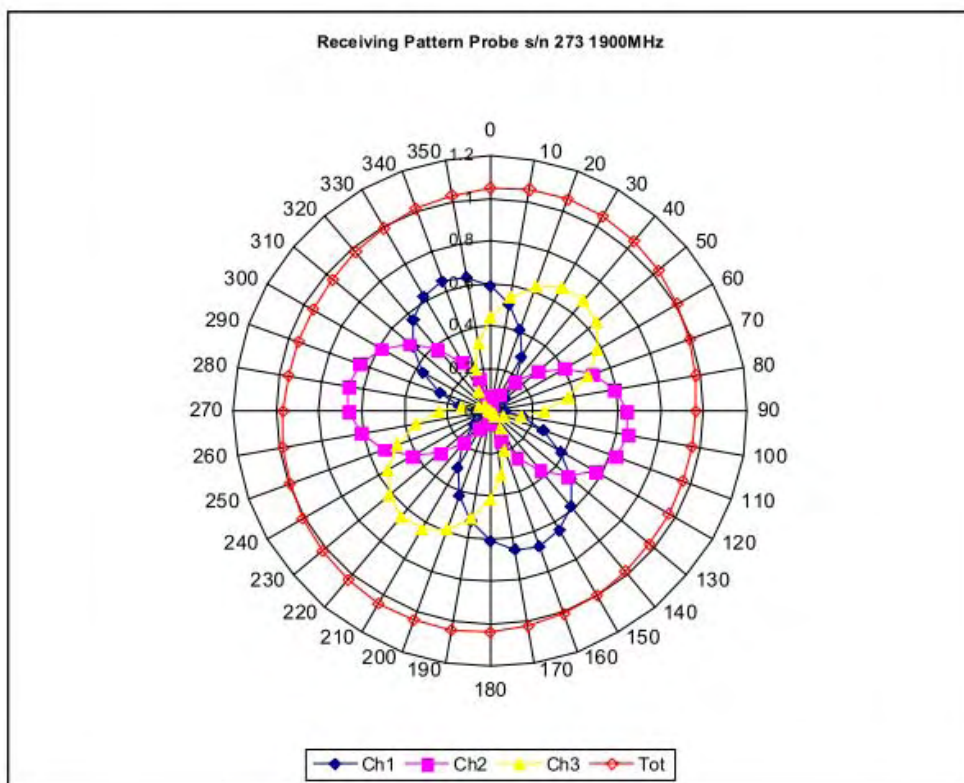

Page 5 of 10

This page has been reviewed for content and attested to on Page 2 of this document.

NCL Calibration Laboratories

Division of APREL Laboratories.

Isotropy Error 1900 MHz (Air)

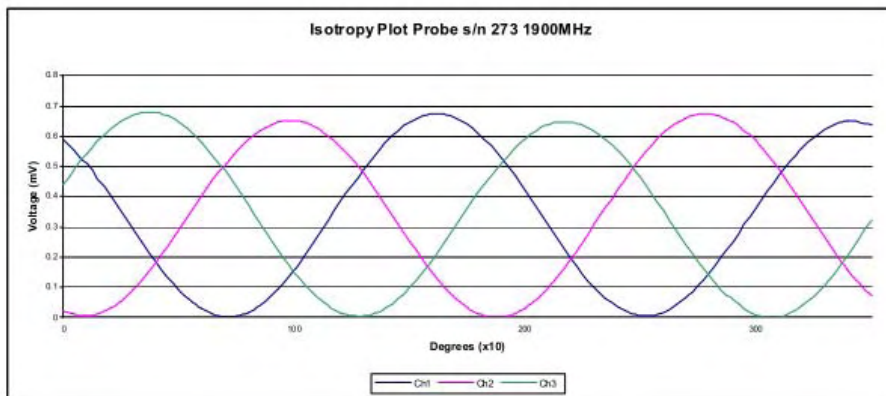
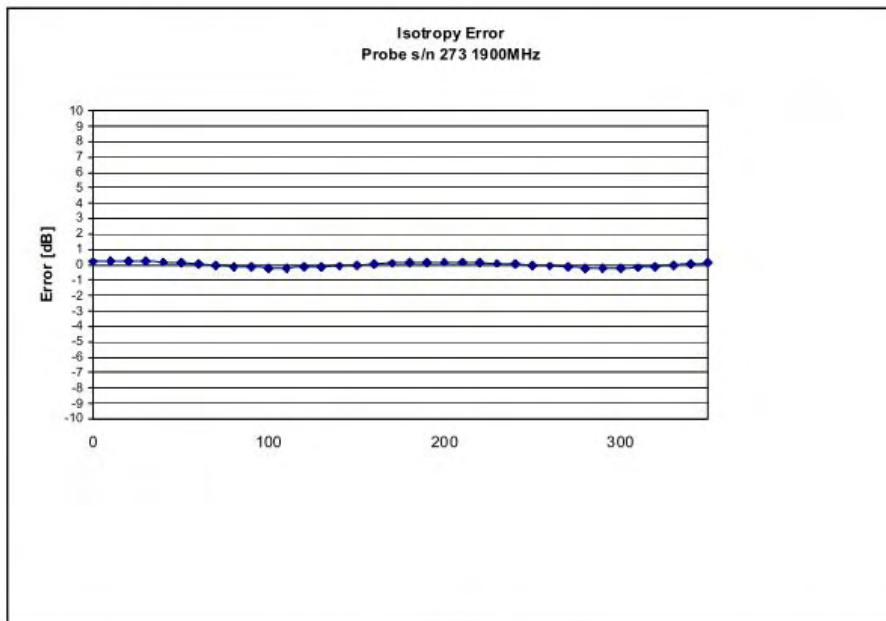

Isotropy in Tissue:

0.10 dB

Page 6 of 10

This page has been reviewed for content and attested to on Page 2 of this document.

NCL Calibration Laboratories

Division of APREL Laboratories.

Video Bandwidth

Probe Frequency Characteristics

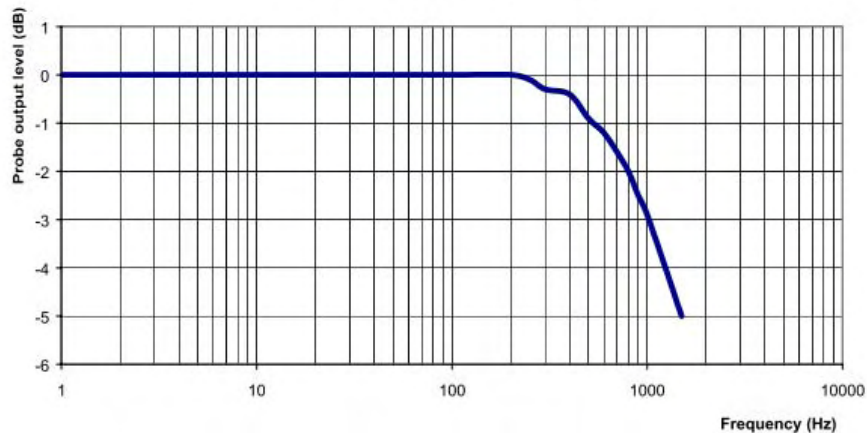

Video Bandwidth at 500 Hz 1 dB
Video Bandwidth at 1.02 KHz: 3 dB

Page 8 of 10
This page has been reviewed for content and attested to on Page 2 of this document.

NCL Calibration Laboratories

Division of APREL Laboratories.

Conversion Factor Uncertainty Assessment

Frequency: 1900MHz
Epsilon: 38.90 (+/-5%) **Sigma:** 1.39 S/m (+/-5%)

ConvF

Channel X: 5.25 7%(K=2)
Channel Y: 5.25 7%(K=2)
Channel Z: 5.25 7%(K=2)

To minimize the uncertainty calculation all tissue sensitivity values were calculated using a load impedance of 5 MΩ.

Boundary Effect:

For a distance of 2.4mm the evaluated uncertainty (increase in the probe sensitivity) is less than 2%.

Page 9 of 10
 This page has been reviewed for content and attested to on Page 2 of this document.

NCL Calibration Laboratories

Division of APREL Laboratories.

Test Equipment

The test equipment used during Probe Calibration, manufacturer, model number and, current calibration status are listed and located on the main APREL server R:\NCL\Calibration Equipment\Instrument List May 2010.

Page 10 of 10

This page has been reviewed for content and attested to on Page 2 of this document.

NCL CALIBRATION LABORATORIES

Calibration File No.: CP-1142

Client.: BACL

CERTIFICATE OF CALIBRATION

It is certified that the equipment identified below has been calibrated in the **NCL CALIBRATION LABORATORIES** by qualified personnel following recognized procedures and using transfer standards traceable to NRC/NIST.

Equipment: Miniature Isotropic RF Probe 1900 MHz

Manufacturer: APREL Laboratories

Model No.: E-020

Serial No.: 273

Calibration in Body Tissue

Calibration Procedure: SSI/DRB-TP-D01-032-E020-V2

Project No: BACB-E020-5537

Calibrated: 21st August 2010
Released on: 24th August 2010

This Calibration Certificate is Incomplete Unless Accompanied with the Calibration Results Summary

Released By: _____

NCL CALIBRATION LABORATORIES

51 SPECTRUM WAY
NEPEAN, ONTARIO
CANADA K2R 1E6

Division of APREL Lab.
TEL: (613) 820-4988
FAX: (613) 820-4161

NCL Calibration Laboratories

Division of APREL Laboratories.

Introduction

This Calibration Report reproduces the results of the calibration performed in line with the SSI/DRB-TP-D01-032-E020-V2 E-Field Probe Calibration Procedure. The results contained within this report are for APREL E-Field Probe E-020 273.

References

SSI/DRB-TP-D01-032-E020-V2 E-Field Probe Calibration Procedure
IEEE 1528 "Recommended Practice for Determining the Peak Spatial-Average Specific Absorption Rate (SAR) in the Human Body Due to Wireless Communications Devices: Experimental Techniques"
SSI-TP-011 Tissue Calibration Procedure

Conditions

Probe 273 was a re-calibration.

Ambient Temperature of the Laboratory: 22 °C +/- 0.5°C
Temperature of the Tissue: 21 °C +/- 0.5°C

We the undersigned attest that to the best of our knowledge the calibration of this probe has been accurately conducted and that all information contained within this report has been reviewed for accuracy.

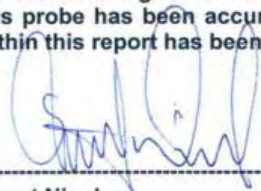

Stuart Nicol

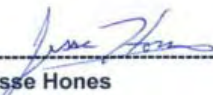

Jesse Hones

Page 2 of 10
This page has been reviewed for content and attested to on Page 2 of this document.

NCL Calibration Laboratories

Division of APREL Laboratories.

Calibration Results Summary

Probe Type:	E-Field Probe E-020
Serial Number:	273
Frequency:	1900 MHz
Sensor Offset:	1.56 mm
Sensor Length:	2.5 mm
Tip Enclosure:	Ertalyte*
Tip Diameter:	<5 mm
Tip Length:	60 mm
Total Length:	290 mm

*Resistive to recommended tissue recipes per IEEE-1528

Sensitivity in Air

Channel X:	1.2 $\mu\text{V}/(\text{V}/\text{m})^2$
Channel Y:	1.2 $\mu\text{V}/(\text{V}/\text{m})^2$
Channel Z:	1.2 $\mu\text{V}/(\text{V}/\text{m})^2$
Diode Compression Point:	95 mV

Page 3 of 10
This page has been reviewed for content and attested to on Page 2 of this document.

NCL Calibration Laboratories

Division of APREL Laboratories.

Sensitivity in Body Tissue Measured**Frequency:** 1900 MHz**Epsilon:** 53.11 (+/-5%) **Sigma:** 1.56 S/m (+/-5%)**ConvF****Channel X:** 5.15**Channel Y:** 5.15**Channel Z:** 5.15

Tissue sensitivity values were calculated using the load impedance of the APREL Laboratories Daq-Paq.

Boundary Effect:

Uncertainty resulting from the boundary effect is less than 2% for the distance between the tip of the probe and the tissue boundary, when less than 2.44mm.

Spatial Resolution:

The measured probe tip diameter is 5 mm (+/- 0.01 mm) and therefore meets the requirements of SSI/DRB-TP-D01-032 for spatial resolution.

Page 4 of 10

This page has been reviewed for content and attested to on Page 2 of this document.

NCL Calibration Laboratories

Division of APREL Laboratories.

Receiving Pattern 1900 MHz (Air)

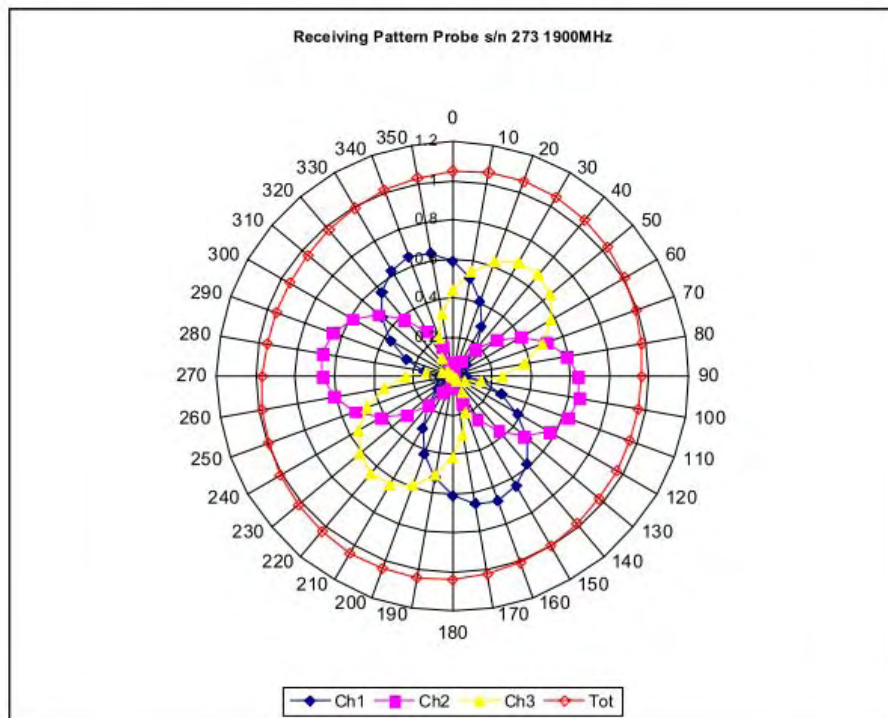

Page 5 of 10

This page has been reviewed for content and attested to on Page 2 of this document.

NCL Calibration Laboratories

Division of APREL Laboratories.

Isotropy Error 1900 MHz (Air)

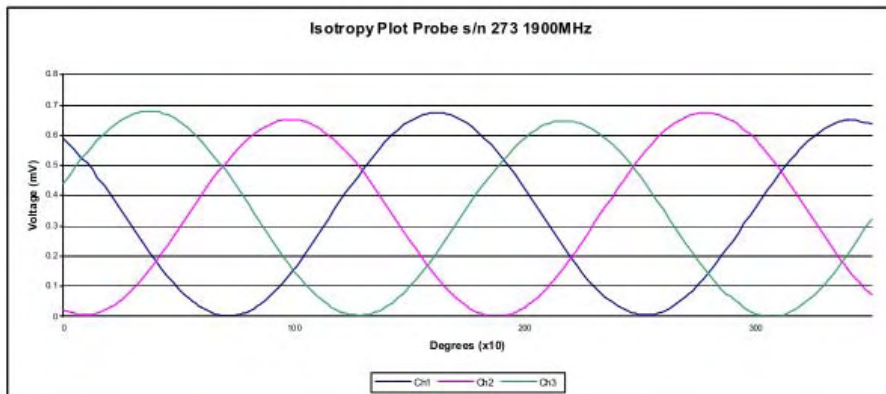
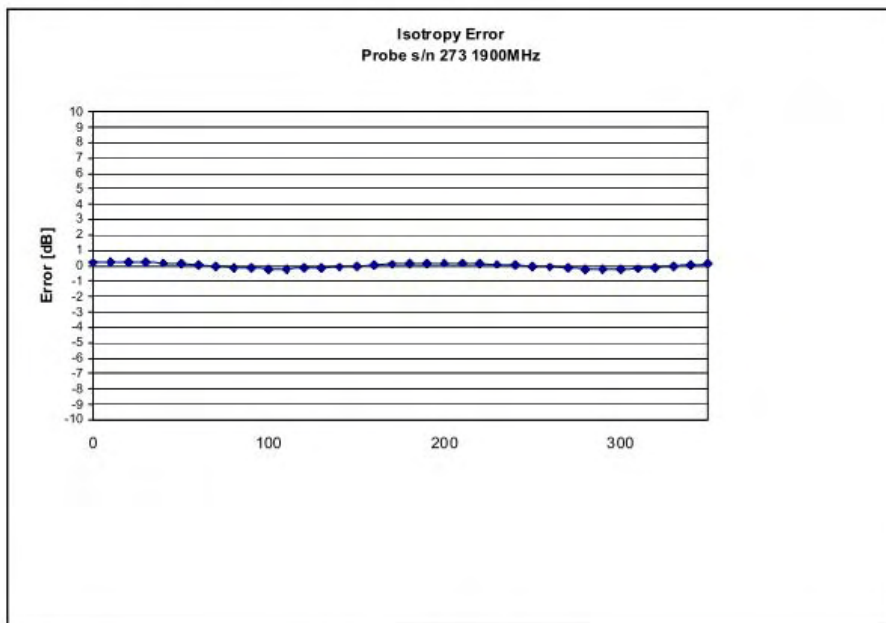

Isotropicity in Tissue:

0.10 dB

NCL Calibration Laboratories

Division of APREL Laboratories.

Dynamic Range

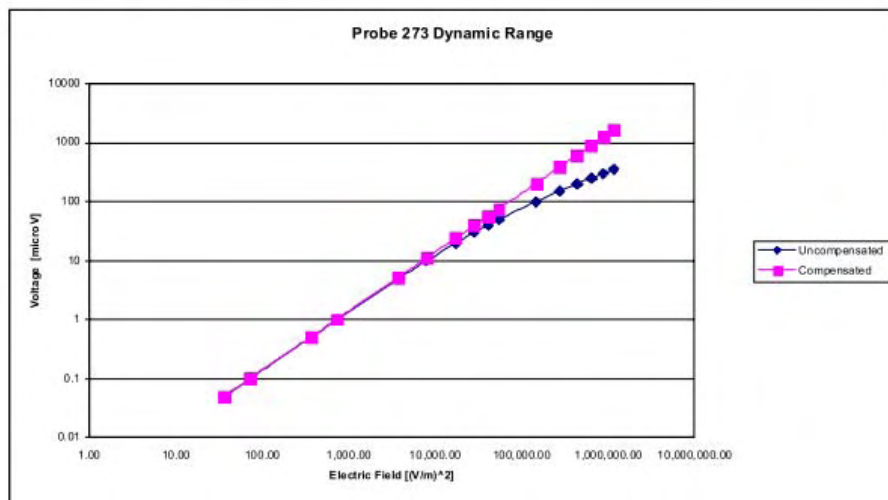

Page 7 of 10
This page has been reviewed for content and attested to on Page 2 of this document.

NCL Calibration Laboratories

Division of APREL Laboratories.

Video Bandwidth

Probe Frequency Characteristics

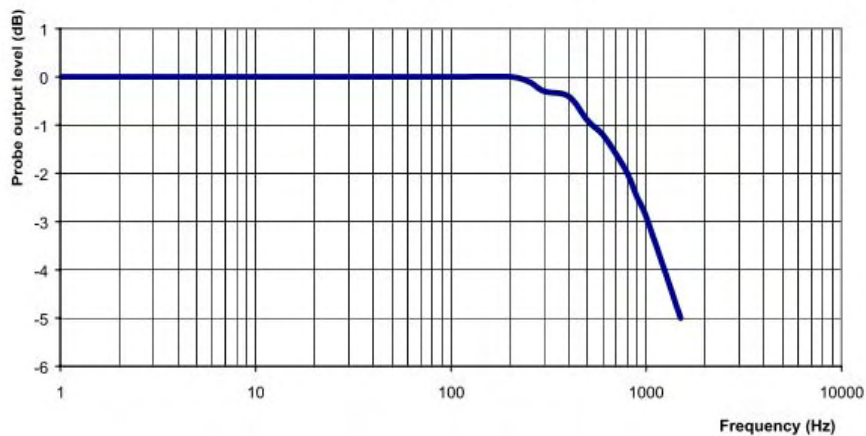

Video Bandwidth at 500 Hz 1 dB
Video Bandwidth at 1.02 KHz: 3 dB

Page 8 of 10
This page has been reviewed for content and attested to on Page 2 of this document.

NCL Calibration Laboratories

Division of APREL Laboratories.

Conversion Factor Uncertainty Assessment

Frequency:		1900MHz	
Epsilon:	53.11 (+/-5%)	Sigma:	1.56 S/m (+/-5%)
ConvF			
Channel X:	5.15	7%(K=2)	
Channel Y:	5.15	7%(K=2)	
Channel Z:	5.15	7%(K=2)	

To minimize the uncertainty calculation all tissue sensitivity values were calculated using a load impedance of 5 MΩ.

Boundary Effect:

For a distance of 2.4mm the evaluated uncertainty (increase in the probe sensitivity) is less than 2%.

Page 9 of 10
This page has been reviewed for content and attested to on Page 2 of this document.

NCL Calibration Laboratories

Division of APREL Laboratories.

Test Equipment

The test equipment used during Probe Calibration, manufacturer, model number and, current calibration status are listed and located on the main APREL server R:\NCL\Calibration Equipment\Instrument List May 2010.

Page 10 of 10

This page has been reviewed for content and attested to on Page 2 of this document.

APPENDIX C – DIPOLE CALIBRATION CERTIFICATES



Bay Area Compliance Laboratories Corp.
 1274 Anvilwood Ave, Sunnyvale, CA 94089
 Tel: (408)732-9162 / Fax: (408)732-9164

Verification of Calibration Report

Report Number: CAL 2010-09-20
Description: Dipole Antenna
Manufacturer: APREL Laboratories
Model Number: ALS-D-835-S-2
Serial Number: SN: 180-00558
Date of Calibration: 20 Sept 2010
Condition Received: In Tolerance
Condition Returned: In Tolerance

Conditions and results of calibration: See attachment

This device has been instrumented, measured and calibrated in accordance with the Bay Area Compliance Laboratories Corp. ("BACL") Quality Assurance Manual procedures and the results being traceable to the National Institute of Standards and Technology (NIST). The BACL Quality System is accredited by NVLAP to ISO/IEC 17025:2005. Unless stated otherwise; Measurement Uncertainties are derived from ISO Guide to the Determination of Uncertainties with a Coverage Factor of $k = 2$ for a 95% level of confidence, no sampling plan or other process was used for this calibration (unless stated otherwise), the results reported herein apply only to the calibration of the item described above, and limitations of use (if any) shall be stated this Calibration Report.

Calibrated By:	 _____ Quinn Jiang	9/20/2010 _____ Date
Reviewed By:	 _____ Victor Zhang	9/21/2010 _____ Date
Quality Assurance:	 _____ Hans Mellberg	21 SEP 2010 _____ Date

Attachment

Ambient Environment of Calibration

Temperature	Relative Humidity	Pressure
22 ° C	56.5 %	102.78 k Pa

Equipment List

Description	Manufacturer	Model	Serial #	Cal Date
Signal Generator	HP	8648C	3426A00417	2010-08-30
Network Analyzer	HP	8753D	3410A04346	2010-06-03
Power meter	Agilent	E4419B	MY41291511	2010-09-01
Power Sensor	Agilent	E9301A	MY41497252	2010-02-19
Reference Probe	SPEAG	ET3DV6	1604	2010-09-16

Measurement Conditions

DASY Version	DASY4	V4.7
Extrapolation	Advanced Extrapolation	
Phantom	Flat Phantom	
Distance Dipole Center-TSL	15 mm	With Spacer
Area Scan resolution	dx,dy = 15 mm	
Zoom Scan resolution	dx,dy,dz = 5 mm	
Frequency	835 MHz ± 1MHz	

Calibration is performed According to the Following Standards:

1. IEEE Std 1528-2003, "IEEE Recommended Practice for Determining the Peak Spatial-Averaged Specific Absorption Rate (SAR) in the Human Head from Wireless Communications Devices: Measurement Techniques", December 2003
2. IEC 62209-1, "Procedure to measure the Specific Absorption Rate (SAR) for hand-held devise used in close proximity to the ear (frequency range of 300 MHz to 3 GHz)", February 2005
3. DASY 4 System Handbook

Calibration Data:

Head TSL Parameters

The following parameters and calculations were applied

	Temperature	Permittivity	Conductivity
Nominal Head TSL Parameters	22.0°C	41.5	0.90
Measured Head TSL Parameters	22.0°C	41.5	0.89
Head TSL Temperature during test	23.0°C		

SAR result with Head TSL

SAR average over 1 cm ³ (1g) of Head TSL	Condition	
SAR measured	500 mW input power	4.77 mW / g
SAR normalized	Normalized to 1W	9.54 mW / g
SAR for nominal Head TSL parameters ¹	Normalized to 1W	9.5 mW / g ± 10%

SAR average over 10 cm ³ (10g) of Head TSL	Condition	
SAR measured	500 mW input power	3.02 mW / g
SAR normalized	Normalized to 1W	6.04 mW / g
SAR for nominal Head TSL parameters ¹	Normalized to 1W	6.2 mW / g ± 10%

Antenna Parameters with Head TSL

Impedance, transformed to feed point	56.174 Ω
Return Loss	-23.458 dB

DASY4 Validation Report for Head TSL

Test Laboratory: Bay Area Compliance Lab Corp.(BACL)

System Performance Test (835 MHz Head Tissue)

DUT: Dipole 835 MHz; Type: ALS-D835-S-2; Serial: SN: 180-00558

Communication System: CW; Frequency: 835 MHz; Duty Cycle: 1:1
Medium parameters used: $f = 835 \text{ MHz}$; $\sigma = 0.89 \text{ mho/m}$; $\epsilon_r = 41.5$; $\rho = 1000 \text{ kg/m}^3$
Phantom section: Flat Section

DASY4 Configuration:

- Probe: ET3DV6 - SN1604; ConvF(6.26, 6.26, 6.26); Calibrated: 9/16/2010
- Sensor-Surface: 4mm (Mechanical Surface Detection)
- Electronics: DAE3 Sn456; Calibrated: 11/8/2007
- Phantom: SAM with CRP; Type: Twin SAM; Serial: TP-1032
- Measurement SW: DASY4, V4.6 Build 23; Post processing SW: SEMCAD, V1.8 Build 184

d =15 mm, Pin = 0.5W /Area Scan (81x121x1): Measurement grid: dx=15mm, dy=15mm
Maximum value of SAR (interpolated) = 5.08 mW/g

d =15 mm, Pin = 0.5W /Zoom Scan (8x8x7)/Cube 0: Measurement grid: dx=5mm, dy=5mm, dz=5mm
Reference Value = 77.8 V/m; Power Drift = -0.113 dB
Peak SAR (extrapolated) = 7.35 W/kg

SAR(1 g) = 4.77 mW/g; SAR(10 g) = 3.02 mW/g
Maximum value of SAR (measured) = 5.16 mW/g

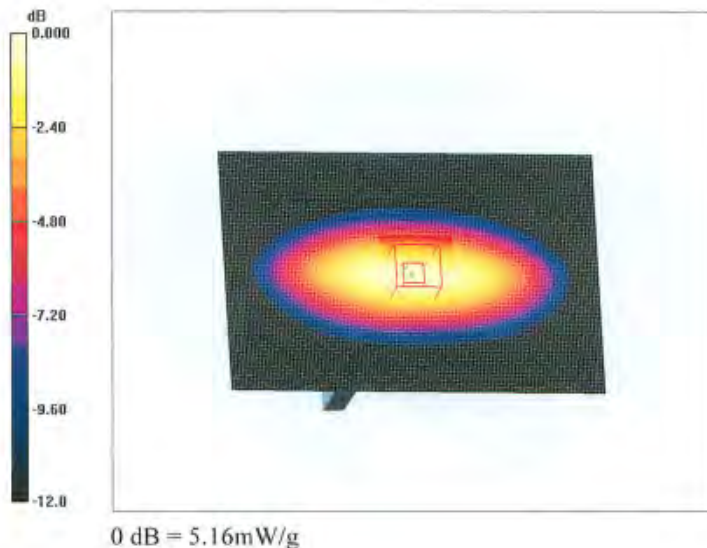

Impedance Measurement Plot for Head TSL

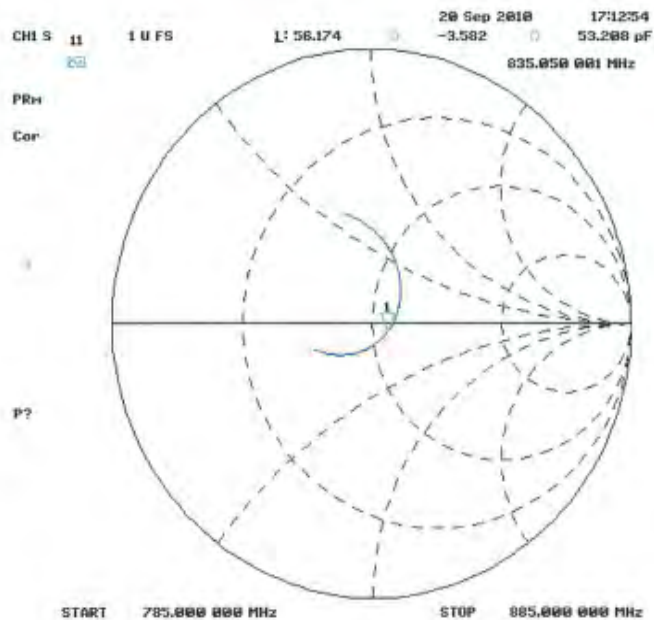

Return Loss Measurement Plot for Head TSL

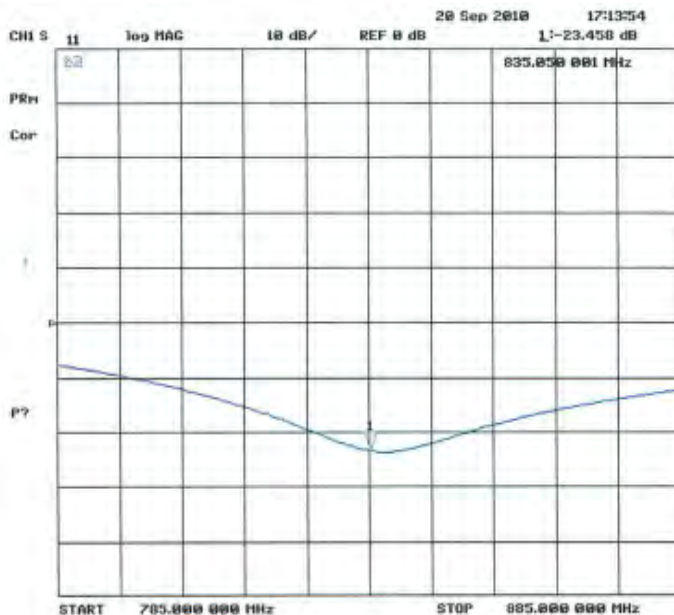



Bay Area Compliance Laboratories Corp.
 1274 Anvilwood Ave, Sunnyvale, CA 94089
 Tel: (408)732-9162 / Fax: (408)732-9164

Verification of Calibration Report

Report Number: CAL 2010-09-20
Description: Dipole Antenna
Manufacturer: APREL Laboratories
Model Number: ALS-D-1900-S-2
Serial Number: SN: 210-00710
Date of Calibration: 20 Sept 2010
Condition Received: In Tolerance
Condition Returned: In Tolerance

Conditions and results of calibration: See attachment

This device has been instrumented, measured and calibrated in accordance with the Bay Area Compliance Laboratories Corp. ("BACL") Quality Assurance Manual procedures and the results being traceable to the National Institute of Standards and Technology (NIST). The BACL Quality System is accredited by NVLAP to ISO/IEC 17025:2005. Unless stated otherwise; Measurement Uncertainties are derived from ISO Guide to the Determination of Uncertainties with a Coverage Factor of $k = 2$ for a 95% level of confidence, no sampling plan or other process was used for this calibration (unless stated otherwise), the results reported herein apply only to the calibration of the item described above, and limitations of use (if any) shall be stated this Calibration Report.

Calibrated By: Quinn Jiang 9/20/2010
 Quinn Jiang Date
Reviewed By: Victor Zhang 9/21/2010
 Victor Zhang Date
Quality Assurance: Hans Mellberg 21 SEP 2010
 Hans Mellberg Date

Attachment

Ambient Environment of Calibration

Temperature	Relative Humidity	Pressure
22 ° C	53.5 %	104.55 k Pa

Equipment List

Description	Manufacturer	Model	Serial #	Cal Date
Signal Generator	HP	8648C	3426A00417	2010-08-30
Network Analyzer	HP	8753D	3410A04346	2010-06-03
Power meter	Agilent	E4419B	MY41291511	2010-09-01
Power Sensor	Agilent	E9301A	MY41497252	2010-02-19
Reference Probe	SPEAG	ET3DV6	1604	2010-09-16

Measurement Conditions

DASY Version	DASY4	V4.7
Extrapolation	Advanced Extrapolation	
Phantom	Flat Phantom	
Distance Dipole Center-TSL	10 mm	With Spacer
Area Scan resolution	dx,dy = 15 mm	
Zoom Scan resolution	dx,dy,dz = 5 mm	
Frequency	1900 MHz ± 1MHz	

Calibration is performed According to the Following Standards:

1. IEEE Std 1528-2003, "IEEE Recommended Practice for Determining the Peak Spatial-Averaged Specific Absorption Rate (SAR) in the Human Head from Wireless Communications Devices: Measurement Techniques", December 2003
2. IEC 62209-1, "Procedure to measure the Specific Absorption Rate (SAR) for hand-held devise used in close proximity to the ear (frequency range of 300 MHz to 3 GHz)", February 2005
3. DASY 4 System Handbook

Calibration Data:

Head TSL Parameters

The following parameters and calculations were applied

	Temperature	Permittivity	Conductivity
Nominal Head TSL Parameters	22.0°C	40.0	1.40
Measured Head TSL Parameters	(22.0±0.3)°C	39.9	1.38
Head TSL Temperature during test	(23.0±0.3)°C		

SAR result with Head TSL

SAR average over 1 cm ³ (1g) of Head TSL	Condition	
SAR measured	500 mW input power	18.8 mW / g
SAR normalized	Normalized to 1W	37.6 mW / g
SAR for nominal Head TSL parameters ¹	Normalized to 1W	39.7 mW / g ± 10%

SAR average over 10 cm ³ (10g) of Head TSL	Condition	
SAR measured	500 mW input power	9.58 mW / g
SAR normalized	Normalized to 1W	19.16 mW / g
SAR for nominal Head TSL parameters ¹	Normalized to 1W	20.5 mW / g ± 10%

Antenna Parameters with Head TSL

Impedance, transformed to feed point	50.727 Ω
Return Loss	-35.881 dB

¹Correction to nominal TSL parameters according to DASY 4 System Handbook, chapter “SAR Sensitivities”

DASY4 Validation Report for Head TSL

Test Laboratory: Bay Area Compliance Lab Corp.(BACL)

System Performance Test (1900 MHz Head Tissue)

DUT: Dipole 1900 MHz; Type: ALS-D-1900-S-2; Serial: SN: 210-00710

Communication System: CW; Frequency: 1900 MHz; Duty Cycle: 1:1
Medium parameters used: $f = 1900$ MHz; $\sigma = 1.38$ mho/m; $\epsilon_r = 39.9$; $\rho = 1000$ kg/m³
Phantom section: Flat Section

DASY4 Configuration:

- Probe: ET3DV6 - SN1604; ConvF(5.04, 5.04, 5.04); Calibrated: 9/16/2010
- Sensor-Surface: 4mm (Mechanical Surface Detection)
- Electronics: DAE3 Sn456; Calibrated: 11/8/2007
- Phantom: SAM with CRP; Type: Twin SAM; Serial: TP-1032
- Measurement SW: DASY4, V4.6 Build 23; Post processing SW: SEMCAD, V1.8 Build 184

d =10 mm, Pin = 0.5W /Area Scan (81x121x1): Measurement grid: dx=15mm, dy=15mm
Maximum value of SAR (interpolated) = 20.7 mW/g

d =10 mm, Pin = 0.5W /Zoom Scan (8x8x7)/Cube 0: Measurement grid: dx=5mm, dy=5mm, dz=5mm
Reference Value = 127.5 V/m; Power Drift = -0.054 dB
Peak SAR (extrapolated) = 34.7 W/kg

SAR(1 g) = 18.8 mW/g; SAR(10 g) = 9.58 mW/g
Maximum value of SAR (measured) = 21.3 mW/g

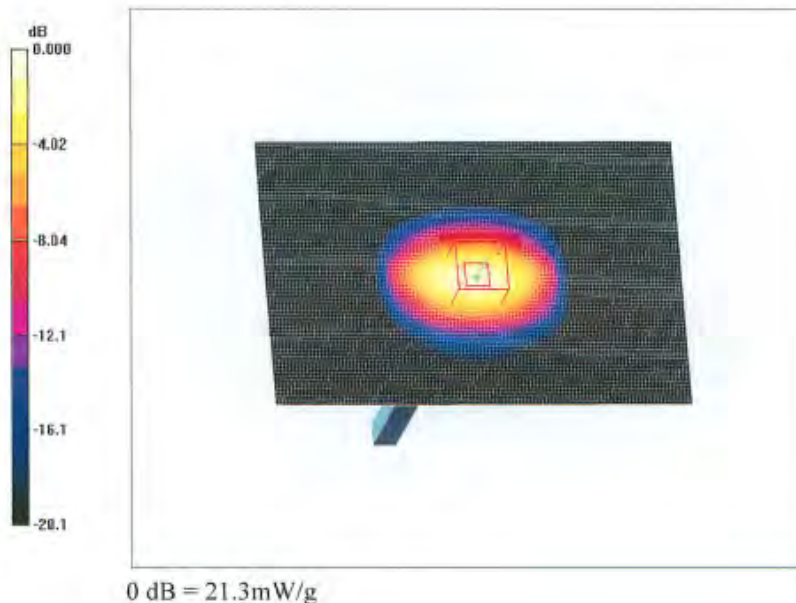

Impedance Measurement Plot for Head TSL

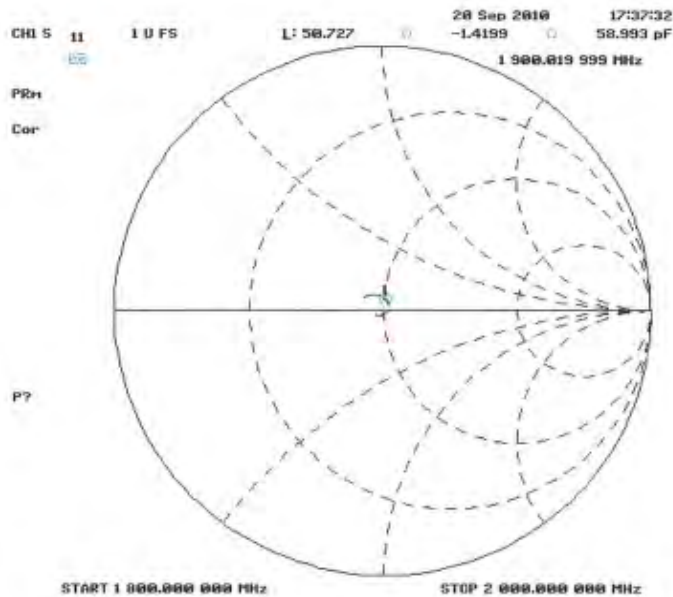

Return Loss Measurement Plot for Head TSL

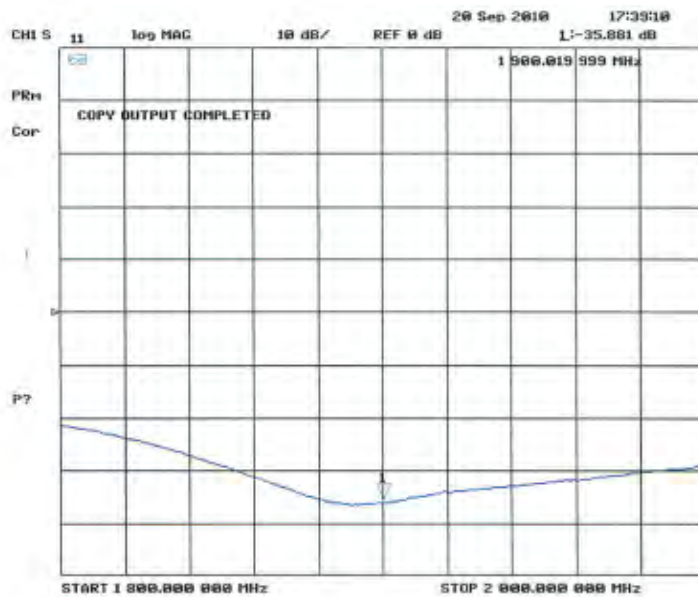

APPENDIX D – SAR SYSTEM VALIDATION DATA

Test Laboratory: Bay Area Compliance Lab Corp. (Shenzhen)

System Performance Check 835 MHz, Head Tissue

Dipole 835 MHz; Type: ALS-D-835-S-2; S/N: 180-00558

Product Data

Device Name : Dipole 835 MHz
 Serial No. : 180-00558
 Type : Dipole
 Model : ALS-D-835-S-2
 Frequency : 835.00 MHz
 Max. Transmit Pwr : 1 W
 Drift Time : 3 min(s)
 Power Drift-Start : 9.212 W/kg
 Power Drift-Finish : 9.253 W/kg
 Power Drift (%) : 1.137

Phantom Data

Name : APREL-Uni
 Type : Uni-Phantom
 Size (mm) : 280 x 280 x 200
 Serial No. : System Default
 Location : Center
 Description : Default
 Phantom Data

Tissue Data

Type : HEAD
 Serial No. : 270-01002
 Frequency : 835.00 MHz
 Last Calib. Date : 04-Dec -2010
 Temperature : 20.00 °C
 Ambient Temp. : 22.00 °C
 Humidity : 50.00 RH%
 Epsilon : 41.14 F/m
 Sigma : 0.92 S/m
 Density : 1000.00 kg/cu. m

Probe Data

Name : E-Field
 Model : E-020
 Type : E-Field Triangle
 Serial No. : 273
 Last Calib. Date : 20-Aug-2010
 Frequency : 835.00 MHz
 Duty Cycle Factor : 1
 Conversion Factor : 6.5
 Probe Sensitivity : 1.20 1.20 1.20 $\mu\text{V}/(\text{V}/\text{m})^2$
 Compression Point : 95.00 mV
 Offset : 1.56 mm

Measurement Data

Crest Factor : 1
 Scan Type : Complete
 Tissue Temp. : 21.00 °C
 Ambient Temp. : 21.00 °C
 Area Scan : 7x9x1 : Measurement x=10mm, y=10mm, z=4mm
 Zoom Scan : 7x7x7 : Measurement x=5mm, y=5mm, z=5mm

1 gram SAR value : 9.630 W/kg
10 gram SAR value : 6.027 W/kg
Area Scan Peak SAR : 9.876 W/kg
Zoom Scan Peak SAR : 14.328 W/kg

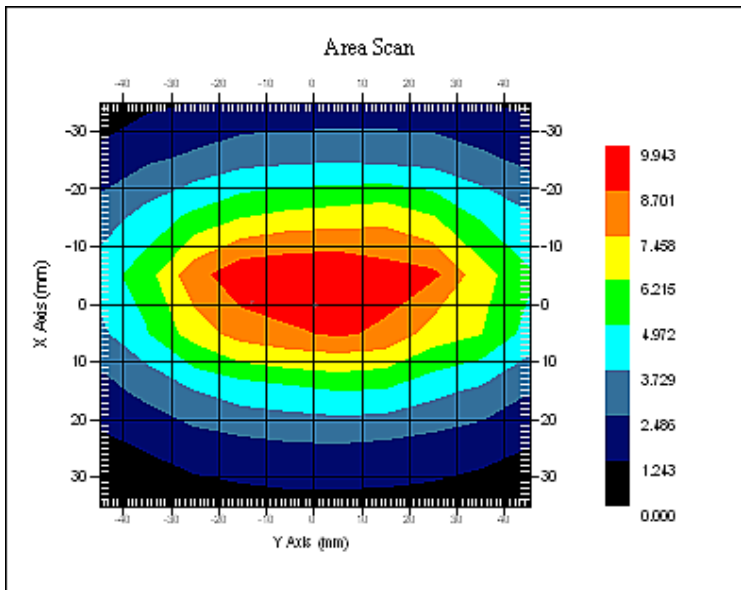

835 MHz System Validation

Test Laboratory: Bay Area Compliance Lab Corp. (Shenzhen)**System Performance Check 1900 MHz, Head Tissue****Dipole 1900 MHz; Type: ALS-D-1900-S-2; S/N: 210-00710**

Product Data

Device Name : Dipole 1900MHz
Serial No. : 210-00710
Type : Dipole
Model : ALS-D-1900-S-2
Frequency : 1900.00 MHz
Max. Transmit Pwr : 1 W
Drift Time : 3 min(s)
Power Drift-Start : 45.287 W/kg
Power Drift-Finish : 47.328 W/kg
Power Drift (%) : 3.637

Phantom Data

Name : APREL-Uni
Type : Uni-Phantom
Size (mm) : 280 x 280 x 200
Serial No. : System Default
Location : Center
Description : Default

Tissue Data

Type : HEAD
Serial No. : 295-01103
Frequency : 1900.00 MHz
Last Calib. Date : 04-Dec -2010
Temperature : 20.00 °C
Ambient Temp. : 22.00 °C
Humidity : 56.00 RH%
Epsilon : 40.05 F/m
Sigma : 1.45 S/m
Density : 1000.00 kg/cu. m

Probe Data

Name : E-Field
Model : E-020
Type : E-Field Triangle
Serial No. : 273
Last Calib. Date : 21-Aug-2010
Frequency : 1900.00 MHz
Duty Cycle Factor : 1
Conversion Factor : 5.25
Probe Sensitivity : 1.20 1.20 1.20 $\mu\text{V}/(\text{V}/\text{m})^2$
Compression Point : 95.00 mV
Offset : 1.56 mm

Measurement Data

Crest Factor : 1
Scan Type : Complete
Tissue Temp. : 20.00 °C
Ambient Temp. : 20.00 °C
Area Scan : 7x9x1 : Measurement x=10mm, y=10mm, z=4mm
Zoom Scan : 7x7x7 : Measurement x=5mm, y=5mm, z=5mm

1 gram SAR value : 40.346 W/kg
10 gram SAR value : 20.526 W/kg
Area Scan Peak SAR : 45.836 W/kg
Zoom Scan Peak SAR : 75.249 W/kg

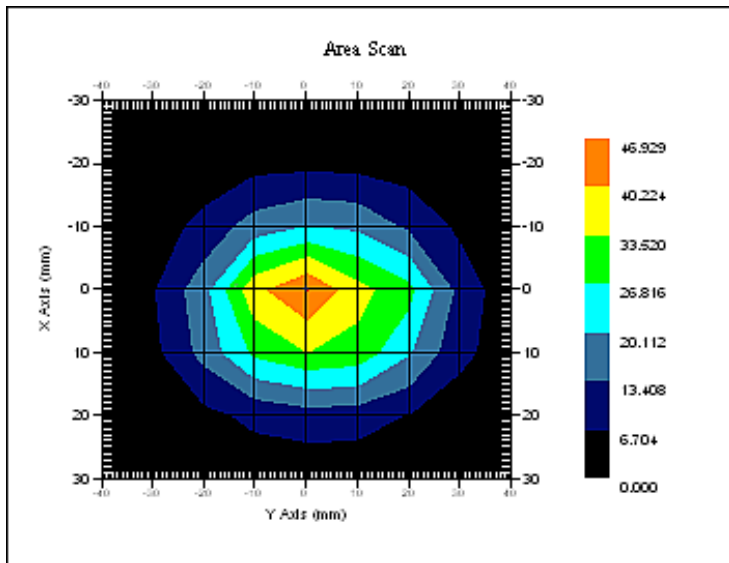

1900 MHz System Validation

APPENDIX E – EUT SCAN RESULTS

Test Laboratory: Bay Area Compliance Lab Corp. (Shenzhen)

Left Head Cheek (835 MHz Middle Channel)

Measurement Data

Test mode : GSM
 Crest Factor : 8
 Scan Type : Complete
 Area Scan : 11x7x1: Measurement x=10mm, y=10mm, z=4mm
 Zoom Scan : 7x7x7: Measurement x=5mm, y=5mm, z=5mm
 Power Drift-Start : 0.075 W/kg
 Power Drift-Finish : 0.073 W/kg
 Power Drift (%) : -3.681

Tissue Data

Type : HEAD
 Frequency : 835.00 MHz
 Epsilon : 41.14 F/m
 Sigma : 0.92 S/m
 Density : 1000.00 kg/cu. m

Probe Data

Serial No. : 273
 Frequency : 835.00 MHz
 Duty Cycle Factor : 8
 Conversion Factor : 6.5
 Probe Sensitivity : 1.20 1.20 1.20 $\mu\text{V}/(\text{V/m})^2$
 Compression Point : 95.00 mV
 Offset : 1.56 mm

1 gram SAR value : 0.244 W/kg
 10 gram SAR value : 0.167 W/kg
 Area Scan Peak SAR : 0.263 W/kg
 Zoom Scan Peak SAR : 0.550 W/kg

Plot 1#

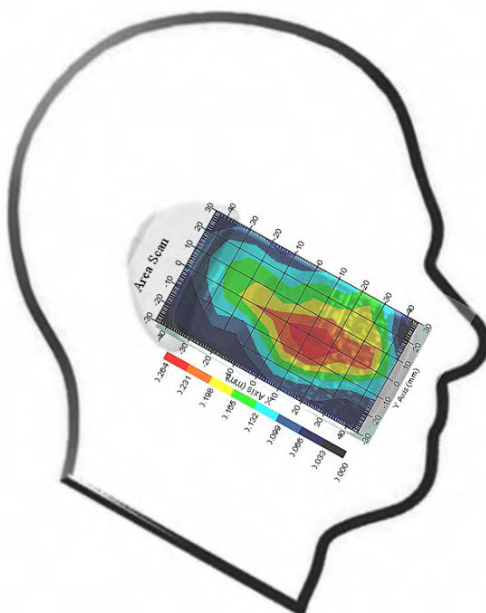

Test Laboratory: Bay Area Compliance Lab Corp. (Shenzhen)

Left Head Tilt (835 MHz Middle Channel)

Measurement Data

Test mode : GSM
 Crest Factor : 8
 Scan Type : Complete
 Area Scan : 11x7x1: Measurement x=10mm, y=10mm, z=4mm
 Zoom Scan : 7x7x7: Measurement x=5mm, y=5mm, z=5mm
 Power Drift-Start : 0.138 W/kg
 Power Drift-Finish : 0.137 W/kg
 Power Drift (%) : -0.568

Tissue Data

Type : HEAD
 Frequency : 835.00 MHz
 Epsilon : 41.14 F/m
 Sigma : 0.92 S/m
 Density : 1000.00 kg/cu. m

Probe Data

Serial No. : 273
 Frequency : 835.00 MHz
 Duty Cycle Factor : 8
 Conversion Factor : 6.5
 Probe Sensitivity : 1.20 1.20 1.20 $\mu\text{V}/(\text{V}/\text{m})^2$
 Compression Point : 95.00 mV
 Offset : 1.56 mm

1 gram SAR value : 0.186 W/kg
 10 gram SAR value : 0.125 W/kg
 Area Scan Peak SAR : 0.219 W/kg
 Zoom Scan Peak SAR : 0.290 W/kg

Plot 2#

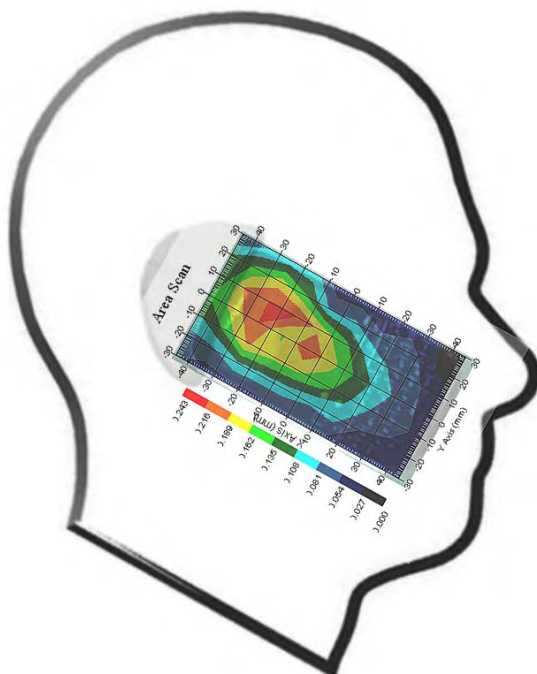

Test Laboratory: Bay Area Compliance Lab Corp. (Shenzhen)

Right Head Cheek (835 MHz Low Channel)

Measurement Data

Test mode : GSM
 Crest Factor : 8
 Scan Type : Complete
 Area Scan : 11x7x1: Measurement x=10mm, y=10mm, z=4mm
 Zoom Scan : 7x7x7: Measurement x=5mm, y=5mm, z=5mm
 Power Drift-Start : 0.068 W/kg
 Power Drift-Finish : 0.067 W/kg
 Power Drift (%) : -1.425

Tissue Data

Type : HEAD
 Frequency : 835.00 MHz
 Epsilon : 41.14 F/m
 Sigma : 0.92 S/m
 Density : 1000.00 kg/cu. m

Probe Data

Serial No. : 273
 Frequency : 835.00 MHz
 Duty Cycle Factor : 8
 Conversion Factor : 6.5
 Probe Sensitivity : 1.20 1.20 1.20 $\mu\text{V}/(\text{V}/\text{m})^2$
 Compression Point : 95.00 mV
 Offset : 1.56 mm

1 gram SAR value : 0.237 W/kg
 10 gram SAR value : 0.142 W/kg
 Area Scan Peak SAR : 0.275 W/kg
 Zoom Scan Peak SAR : 0.330 W/kg

Plot 3#

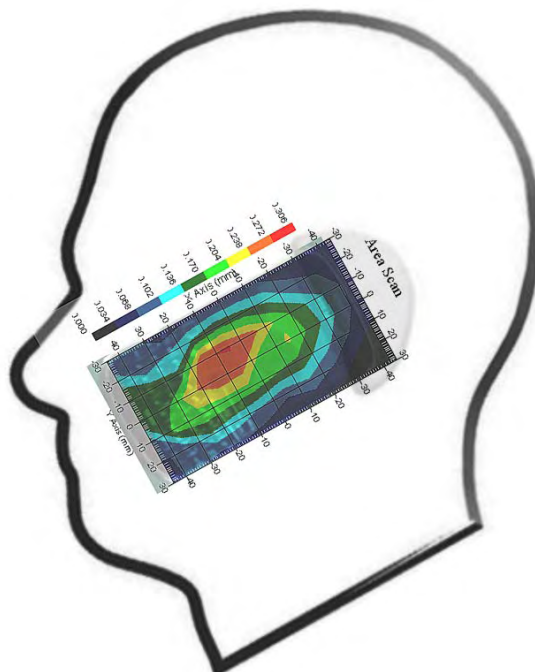

Test Laboratory: Bay Area Compliance Lab Corp. (Shenzhen)

Right Head Cheek (835 MHz Middle Channel)

Measurement Data

Test mode : GSM
Crest Factor : 8
Scan Type : Complete
Area Scan : 11x7x1 : Measurement x=10mm, y=10mm, z=4mm
Zoom Scan : 7x7x7 : Measurement x=5mm, y=5mm, z=5mm
Power Drift-Start : 0.117 W/kg
Power Drift-Finish : 0.115 W/kg
Power Drift (%) : -1.813

Tissue Data

Type : HEAD
Frequency : 835.00 MHz
Epsilon : 41.14 F/m
Sigma : 0.92 S/m
Density : 1000.00 kg/cu. m

Probe Data

Serial No. : 273
Frequency : 835.00 MHz
Duty Cycle Factor : 8
Conversion Factor : 6.5
Probe Sensitivity : 1.20 1.20 1.20 $\mu\text{V}/(\text{V/m})^2$
Compression Point : 95.00 mV
Offset : 1.56 mm

1 gram SAR value : 0.298 W/kg
10 gram SAR value : 0.203 W/kg
Area Scan Peak SAR : 0.336 W/kg
Zoom Scan Peak SAR : 0.570 W/kg

Plot 4#

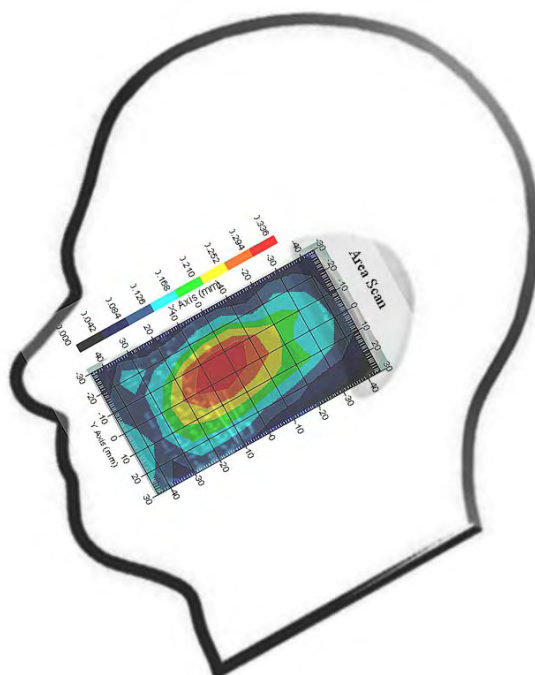

Test Laboratory: Bay Area Compliance Lab Corp. (Shenzhen)

Right Head Cheek (835 MHz High Channel)

Measurement Data

Test mode : GSM
Crest Factor : 8
Scan Type : Complete
Area Scan : 11x7x1 : Measurement x=10mm, y=10mm, z=4mm
Zoom Scan : 7x7x7 : Measurement x=5mm, y=5mm, z=5mm
Power Drift-Start : 0.112 W/kg
Power Drift-Finish : 0.111 W/kg
Power Drift (%) : -1.443

Tissue Data

Type : HEAD
Frequency : 835.00 MHz
Epsilon : 41.14 F/m
Sigma : 0.92 S/m
Density : 1000.00 kg/cu. m

Probe Data

Serial No. : 273
Frequency : 835.00 MHz
Duty Cycle Factor : 8
Conversion Factor : 6.5
Probe Sensitivity : 1.20 1.20 1.20 $\mu\text{V}/(\text{V}/\text{m})^2$
Compression Point : 95.00 mV
Offset : 1.56 mm

1 gram SAR value : 0.267 W/kg
10 gram SAR value : 0.176 W/kg
Area Scan Peak SAR : 0.307 W/kg
Zoom Scan Peak SAR : 0.560 W/kg

Plot 5#

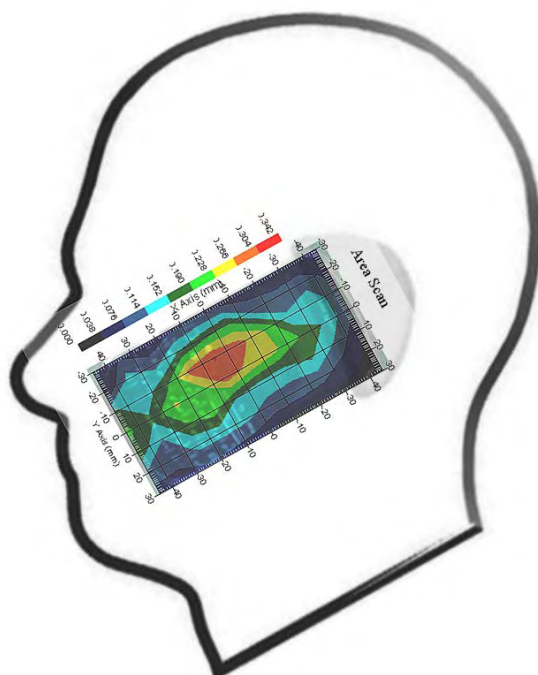

Test Laboratory: Bay Area Compliance Lab Corp. (Shenzhen)

Right Head Tilt (835 MHz Middle Channel)

Measurement Data

Test mode : GSM
Crest Factor : 8
Scan Type : Complete
Area Scan : 11x7x1 : Measurement x=10mm, y=10mm, z=4mm
Zoom Scan : 7x7x7 : Measurement x=5mm, y=5mm, z=5mm
Power Drift-Start : 0.122 W/kg
Power Drift-Finish : 0.121 W/kg
Power Drift (%) : -0.797

Tissue Data

Type : HEAD
Frequency : 835.00 MHz
Epsilon : 41.14 F/m
Sigma : 0.92 S/m
Density : 1000.00 kg/cu. m

Probe Data

Serial No. : 273
Frequency : 835.00 MHz
Duty Cycle Factor : 8
Conversion Factor : 6.5
Probe Sensitivity : 1.20 1.20 1.20 $\mu\text{V}/(\text{V}/\text{m})^2$
Compression Point : 95.00 mV
Offset : 1.56 mm

1 gram SAR value : 0.196 W/kg
10 gram SAR value : 0.146 W/kg
Area Scan Peak SAR : 0.247 W/kg
Zoom Scan Peak SAR : 0.330 W/kg

Plot 6#

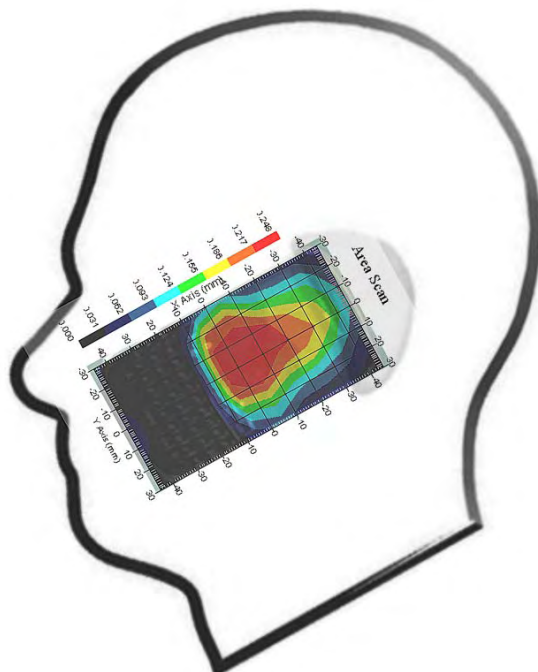

Test Laboratory: Bay Area Compliance Lab Corp. (Shenzhen)

Body- worn Back (835 MHz Middle Channel)

Measurement Data

Test mode : GSM
Crest Factor : 8
Scan Type : Complete
Area Scan : 7x11x1: Measurement x=10mm, y=10mm, z=4mm
Zoom Scan : 7x7x7 : Measurement x=5mm, y=5mm, z=5mm
Power Drift-Start : 0.298 W/kg
Power Drift-Finish : 0.301 W/kg
Power Drift (%) : 1.290

Tissue Data

Type : BODY
Frequency : 835.00 MHz
Epsilon : 55.32 F/m
Sigma : 0.97 S/m
Density : 1000.00 kg/cu. m

Probe Data

Serial No. : 273
Frequency : 835.00 MHz
Duty Cycle Factor : 8
Conversion Factor : 6.7
Probe Sensitivity : 1.20 1.20 1.20 $\mu\text{V}/(\text{V}/\text{m})^2$
Compression Point : 95.00 mV
Offset : 1.56 mm

1 gram SAR value : 0.458 W/kg
10 gram SAR value : 0.318 W/kg
Area Scan Peak SAR : 0.551 W/kg
Zoom Scan Peak SAR : 0.730 W/kg

Plot 7#

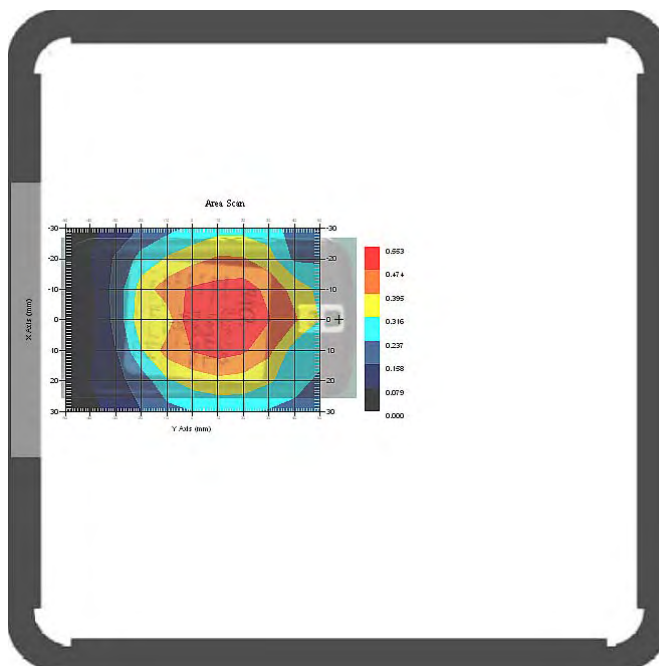

Test Laboratory: Bay Area Compliance Lab Corp. (Shenzhen)

Body- worn Back (835 MHz Low Channel)

Measurement Data

Test mode : GPRS
Crest Factor : 4
Scan Type : Complete
Area Scan : 7x11x1: Measurement x=10mm, y=10mm, z=4mm
Zoom Scan : 7x7x7 : Measurement x=5mm, y=5mm, z=5mm
Power Drift-Start : 0.569 W/kg
Power Drift-Finish : 0.568 W/kg
Power Drift (%) : -0.270

Tissue Data

Type : BODY
Frequency : 835.00 MHz
Epsilon : 55.32 F/m
Sigma : 0.97 S/m
Density : 1000.00 kg/cu. m

Probe Data

Serial No. : 273
Frequency : 835.00 MHz
Duty Cycle Factor : 4
Conversion Factor : 6.7
Probe Sensitivity : 1.20 1.20 1.20 $\mu\text{V}/(\text{V}/\text{m})^2$
Compression Point : 95.00 mV
Offset : 1.56 mm

1 gram SAR value : 0.820 W/kg
10 gram SAR value : 0.511 W/kg
Area Scan Peak SAR : 0.938 W/kg
Zoom Scan Peak SAR : 1.611 W/kg

Plot 8#

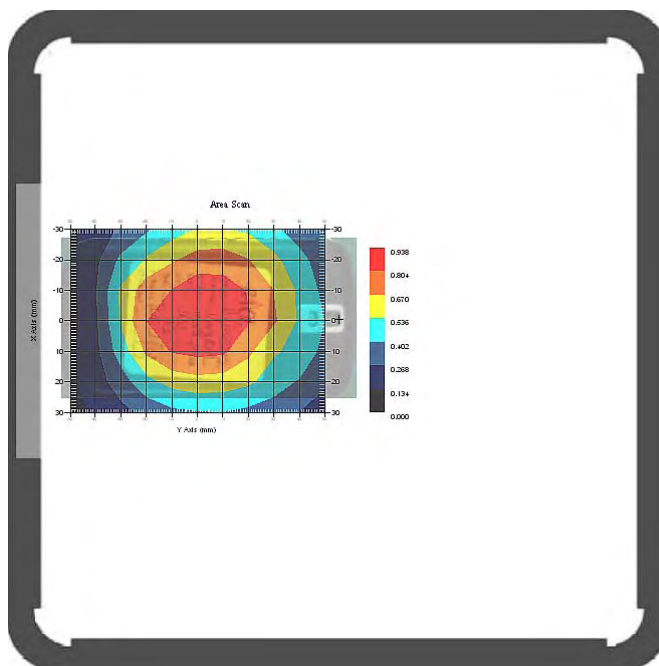

Test Laboratory: Bay Area Compliance Lab Corp. (Shenzhen)

Body- worn Back (835 MHz Middle Channel)

Measurement Data

Test mode : GPRS
 Crest Factor : 4
 Scan Type : Complete
 Area Scan : 7x11x1: Measurement x=10mm, y=10mm, z=4mm
 Zoom Scan : 7x7x7 : Measurement x=5mm, y=5mm, z=5mm
 Power Drift-Start : 0.638 W/kg
 Power Drift-Finish : 0.608 W/kg
 Power Drift (%) : -4.701

Tissue Data

Type : BODY
 Frequency : 835.00 MHz
 Epsilon : 55.32 F/m
 Sigma : 0.97 S/m
 Density : 1000.00 kg/cu. m

Probe Data

Serial No. : 273
 Frequency : 835.00 MHz
 Duty Cycle Factor : 4
 Conversion Factor : 6.7
 Probe Sensitivity : 1.20 1.20 1.20 $\mu\text{V}/(\text{V}/\text{m})^2$
 Compression Point : 95.00 mV
 Offset : 1.56 mm

1 gram SAR value : 0.898 W/kg
 10 gram SAR value : 0.620 W/kg
 Area Scan Peak SAR : 0.930 W/kg
 Zoom Scan Peak SAR : 1.201 W/kg

Plot 9#

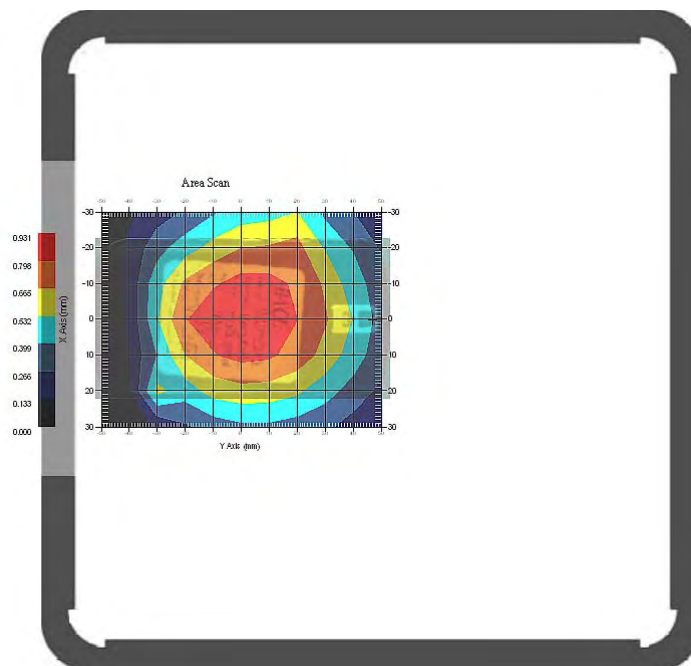

Test Laboratory: Bay Area Compliance Lab Corp. (Shenzhen)

Body- worn Back (835 MHz High Channel)

Measurement Data

Test mode : GPRS
Crest Factor : 4
Scan Type : Complete
Area Scan : 6x10x1: Measurement x=10mm, y=10mm, z=4mm
Zoom Scan : 7x7x7 : Measurement x=5mm, y=5mm, z=5mm
Power Drift-Start : 0.539 W/kg
Power Drift-Finish : 0.534 W/kg
Power Drift (%) : -0.964

Tissue Data

Type : BODY
Frequency : 835.00 MHz
Epsilon : 55.32 F/m
Sigma : 0.97 S/m
Density : 1000.00 kg/cu. m

Probe Data

Serial No. : 273
Frequency : 835.00 MHz
Duty Cycle Factor : 4
Conversion Factor : 6.7
Probe Sensitivity : 1.20 1.20 1.20 $\mu\text{V}/(\text{V}/\text{m})^2$
Compression Point : 95.00 mV
Offset : 1.56 mm

1 gram SAR value : 0.842 W/kg
10 gram SAR value : 0.604 W/kg
Area Scan Peak SAR : 0.865 W/kg
Zoom Scan Peak SAR : 1.131 W/kg

Plot 10#

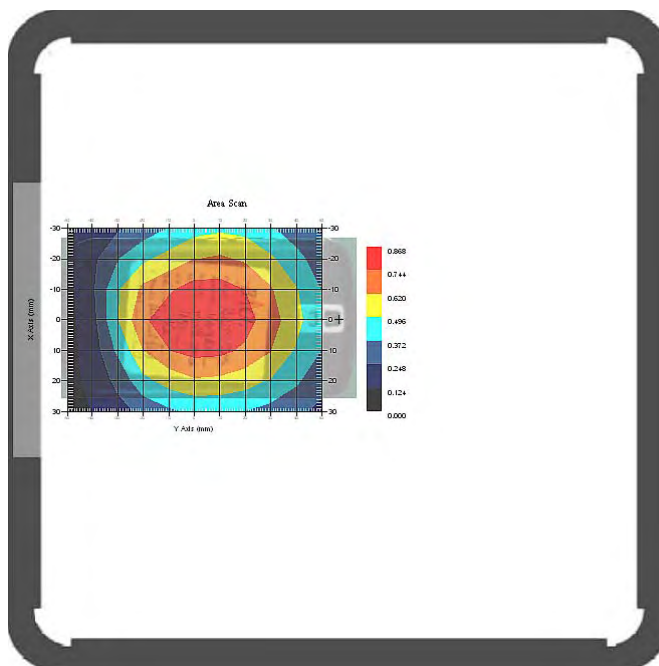

Test Laboratory: Bay Area Compliance Lab Corp. (Shenzhen)

Left Head Cheek (1900 MHz High Channel)

Measurement Data

Test mode : GSM
 Crest Factor : 8
 Scan Type : Complete
 Area Scan : 11x7x1: Measurement x=10mm, y=10mm, z=4mm
 Zoom Scan : 7x7x7: Measurement x=5mm, y=5mm, z=5mm
 Power Drift-Start : 0.059 W/kg
 Power Drift-Finish : 0.058 W/kg
 Power Drift (%) : -2.103

Tissue Data

Type : BODY
 Frequency : 835.00 MHz
 Epsilon : 55.32 F/m
 Sigma : 0.97 S/m
 Density : 1000.00 kg/cu. m

Probe Data

Serial No. : 273
 Frequency : 1900.00 MHz
 Duty Cycle Factor : 8
 Conversion Factor : 5.25
 Probe Sensitivity : 1.20 1.20 1.20 $\mu\text{V}/(\text{V}/\text{m})^2$
 Compression Point : 95.00 mV
 Offset : 1.56 mm

1 gram SAR value : 0.642 W/kg
 10 gram SAR value : 0.355 W/kg
 Area Scan Peak SAR : 0.847 W/kg
 Zoom Scan Peak SAR : 1.139 W/kg

Plot 11#

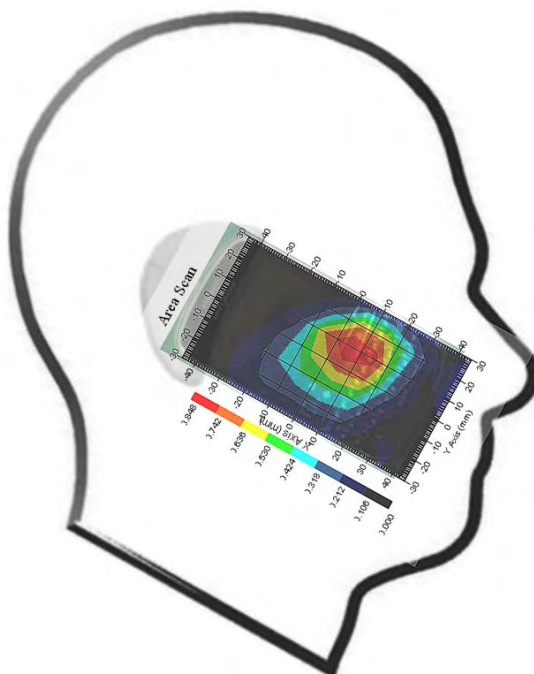

Test Laboratory: Bay Area Compliance Lab Corp. (Shenzhen)

Left Head Tilt (1900 MHz High Channel)

Measurement Data

Test mode : GSM
 Crest Factor : 8
 Scan Type : Complete
 Area Scan : 11x7x1 : Measurement x=10mm, y=10mm, z=4mm
 Zoom Scan : 7x7x7 : Measurement x=5mm, y=5mm, z=5mm
 Power Drift-Start : 0.027 W/kg
 Power Drift-Finish : 0.028W/kg
 Power Drift (%) : 3.612

Tissue Data

Type : HEAD
 Frequency : 1900.00 MHz
 Epsilon : 40.05 F/m
 Sigma : 1.45 S/m
 Density : 1000.00 kg/cu. m

Probe Data

Serial No. : 273
 Frequency : 1900.00 MHz
 Duty Cycle Factor : 8
 Conversion Factor : 5.25
 Probe Sensitivity : 1.20 1.20 1.20 $\mu\text{V}/(\text{V}/\text{m})^2$
 Compression Point : 95.00 mV
 Offset : 1.56 mm

1 gram SAR value : 0.312 W/kg
 10 gram SAR value : 0.168 W/kg
 Area Scan Peak SAR : 0.351 W/kg
 Zoom Scan Peak SAR : 0.557 W/kg

Plot 12#

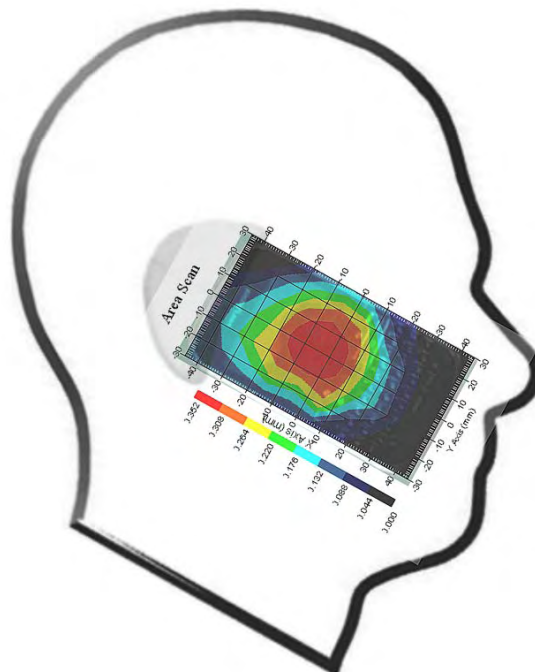

Test Laboratory: Bay Area Compliance Lab Corp. (Shenzhen)

Right Head Cheek (1900 MHz Low Channel)

Measurement Data

Test mode : GSM
 Crest Factor : 8
 Scan Type : Complete
 Area Scan : 11x7x1 : Measurement x=10mm, y=10mm, z=4mm
 Zoom Scan : 7x7x7 : Measurement x=5mm, y=5mm, z=5mm
 Power Drift-Start : 0.049 W/kg
 Power Drift-Finish : 0.047 W/kg
 Power Drift (%) : -3.429

Tissue Data

Type : HEAD
 Frequency : 1900.00 MHz
 Epsilon : 40.05 F/m
 Sigma : 1.45 S/m
 Density : 1000.00 kg/cu. m

Probe Data

Serial No. : 273
 Frequency : 1900.00 MHz
 Duty Cycle Factor : 8
 Conversion Factor : 5.25
 Probe Sensitivity : 1.20 1.20 1.20 $\mu\text{V}/(\text{V/m})^2$
 Compression Point : 95.00 mV
 Offset : 1.56 mm

1 gram SAR value : 0.637 W/kg
 10 gram SAR value : 0.329 W/kg
 Area Scan Peak SAR : 0.862 W/kg
 Zoom Scan Peak SAR : 1.161 W/kg

Plot 13#

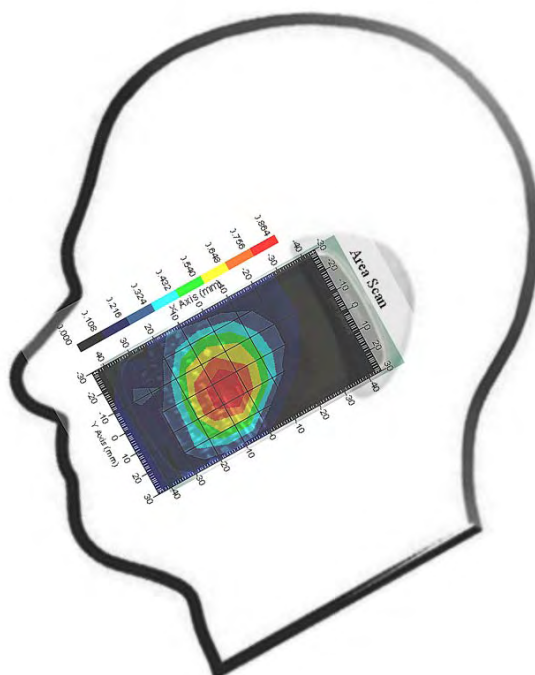

Test Laboratory: Bay Area Compliance Lab Corp. (Shenzhen)

Right Head Cheek (1900 MHz Middle Channel)

Measurement Data

Test mode : GSM
 Crest Factor : 8
 Scan Type : Complete
 Area Scan : 11x7x1 : Measurement x=10mm, y=10mm, z=4mm
 Zoom Scan : 7x7x7 : Measurement x=5mm, y=5mm, z=5mm
 Power Drift-Start : 0.024 W/kg
 Power Drift-Finish : 0.025 W/kg
 Power Drift (%) : 3.508

Tissue Data

Type : HEAD
 Frequency : 1900.00 MHz
 Epsilon : 40.05 F/m
 Sigma : 1.45 S/m
 Density : 1000.00 kg/cu. m

Probe Data

Serial No. : 273
 Frequency : 1900.00 MHz
 Duty Cycle Factor : 8
 Conversion Factor : 5.25
 Probe Sensitivity : 1.20 1.20 1.20 $\mu\text{V}/(\text{V/m})^2$
 Compression Point : 95.00 mV
 Offset : 1.56 mm

1 gram SAR value : 0.608 W/kg
 10 gram SAR value : 0.341 W/kg
 Area Scan Peak SAR : 0.674 W/kg
 Zoom Scan Peak SAR : 0.880 W/kg

Plot 14#

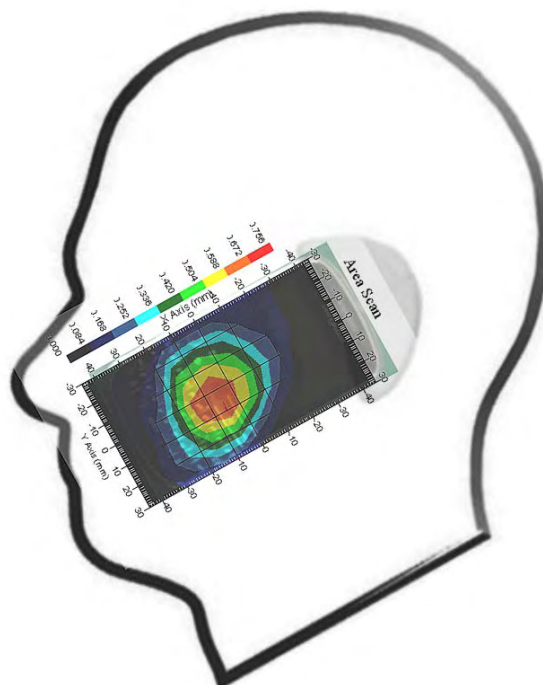

Test Laboratory: Bay Area Compliance Lab Corp. (Shenzhen)

Right Head Check (1900 MHz High Channel)

Measurement Data

Test mode : GSM
Crest Factor : 8
Scan Type : Complete
Area Scan : 11x7x1 : Measurement x=10mm, y=10mm, z=4mm
Zoom Scan : 7x7x7 : Measurement x=5mm, y=5mm, z=5mm
Power Drift-Start : 0.054 W/kg
Power Drift-Finish : 0.053 W/kg
Power Drift (%) : -2.949

Tissue Data

Type : HEAD
Frequency : 1900.00 MHz
Epsilon : 40.05 F/m
Sigma : 1.45 S/m
Density : 1000.00 kg/cu. m

Probe Data

Serial No. : 273
Frequency : 1900.00 MHz
Duty Cycle Factor : 8
Conversion Factor : 5.25
Probe Sensitivity : 1.20 1.20 1.20 $\mu\text{V}/(\text{V}/\text{m})^2$
Compression Point : 95.00 mV
Offset : 1.56 mm

1 gram SAR value : 0.653 W/kg
10 gram SAR value : 0.476 W/kg
Area Scan Peak SAR : 0.867 W/kg
Zoom Scan Peak SAR : 1.201 W/kg

Plot 15#

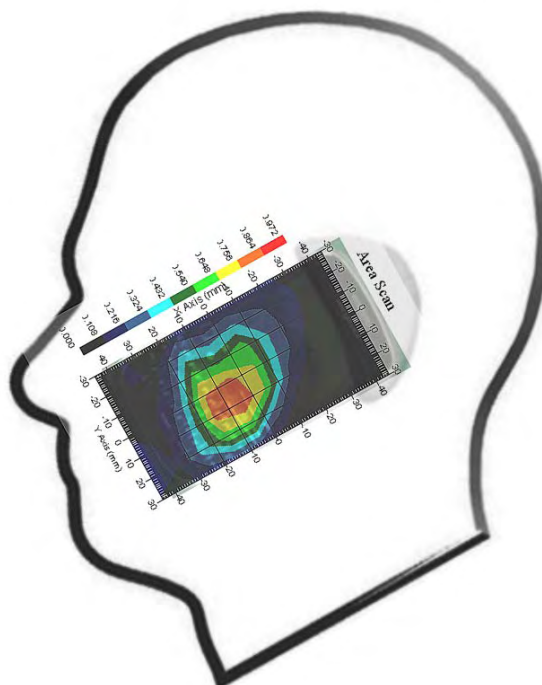

Test Laboratory: Bay Area Compliance Lab Corp. (Shenzhen)

Right Head Tilt (1900 MHz High Channel)

Measurement Data

Test mode : GSM
 Crest Factor : 8
 Scan Type : Complete
 Area Scan : 11x7x1 : Measurement x=10mm, y=10mm, z=4mm
 Zoom Scan : 7x7x7 : Measurement x=5mm, y=5mm, z=5mm
 Power Drift-Start : 0.021 W/kg
 Power Drift-Finish : 0.021 W/kg
 Power Drift (%) : 3.508

Tissue Data

Type : HEAD
 Frequency : 1900.00 MHz
 Epsilon : 40.05 F/m
 Sigma : 1.45 S/m
 Density : 1000.00 kg/cu. m

Probe Data

Serial No. : 273
 Frequency : 1900.00 MHz
 Duty Cycle Factor : 8
 Conversion Factor : 5.25
 Probe Sensitivity : 1.20 1.20 1.20 $\mu\text{V}/(\text{V/m})^2$
 Compression Point : 95.00 mV
 Offset : 1.56 mm

1 gram SAR value : 0.328 W/kg
 10 gram SAR value : 0.171 W/kg
 Area Scan Peak SAR : 0.374 W/kg
 Zoom Scan Peak SAR : 0.580 W/kg

Plot 16#

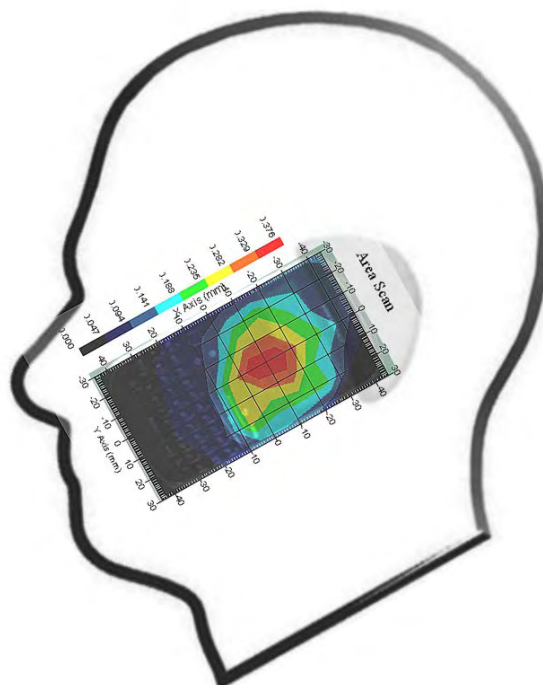

Test Laboratory: Bay Area Compliance Lab Corp. (Shenzhen)

Body- worn Back (1900 MHz High Channel)

Measurement Data

Test mode : GSM
 Crest Factor : 8
 Scan Type : Complete
 Area Scan : 7x11x1: Measurement x=10mm, y=10mm, z=4mm
 Zoom Scan : 7x7x7 : Measurement x=5mm, y=5mm, z=5mm
 Power Drift-Start : 0.065 W/kg
 Power Drift-Finish : 0.063 W/kg
 Power Drift (%) : -2.942

Tissue Data

Type : BODY
 Frequency : 1900.00 MHz
 Epsilon : 53.88 F/m
 Sigma : 1.47 S/m
 Density : 1000.00 kg/cu. m

Probe Data

Serial No. : 273
 Frequency : 1900.00 MHz
 Duty Cycle Factor : 8
 Conversion Factor : 5.15
 Probe Sensitivity : 1.20 1.20 1.20 $\mu\text{V}/(\text{V}/\text{m})^2$
 Compression Point : 95.00 mV
 Offset : 1.56 mm

1 gram SAR value : 0.438 W/kg
 10 gram SAR value : 0.213 W/kg
 Area Scan Peak SAR : 0.452 W/kg
 Zoom Scan Peak SAR : 0.680 W/kg

Plot 17#

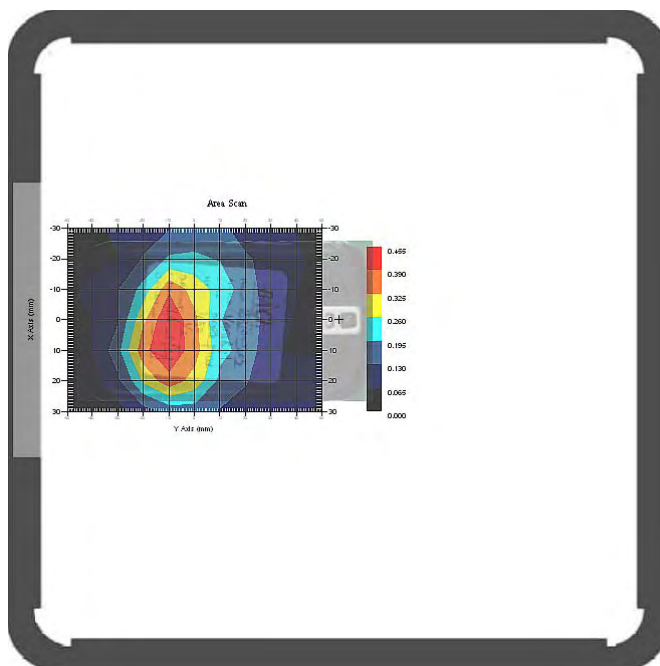

Test Laboratory: Bay Area Compliance Lab Corp. (Shenzhen)

Body- worn Back (1900 MHz Low Channel)

Measurement Data

Test mode : GPRS
 Crest Factor : 4
 Scan Type : Complete
 Area Scan : 7x11x1: Measurement x=10mm, y=10mm, z=4mm
 Zoom Scan : 7x7x7 : Measurement x=5mm, y=5mm, z=5mm
 Power Drift-Start : 0.166 W/kg
 Power Drift-Finish : 0.165 W/kg
 Power Drift (%) : -0.580

Tissue Data

Type : BODY
 Frequency : 1900.00 MHz
 Epsilon : 53.88 F/m
 Sigma : 1.47 S/m
 Density : 1000.00 kg/cu. m

Probe Data

Serial No. : 273
 Frequency : 1900.00 MHz
 Duty Cycle Factor : 4
 Conversion Factor : 5.15
 Probe Sensitivity : 1.20 1.20 1.20 $\mu\text{V}/(\text{V}/\text{m})^2$
 Compression Point : 95.00 mV
 Offset : 1.56 mm

1 gram SAR value : 0.835 W/kg
 10 gram SAR value : 0.374 W/kg
 Area Scan Peak SAR : 0.844 W/kg
 Zoom Scan Peak SAR : 1.141 W/kg

Plot 18#

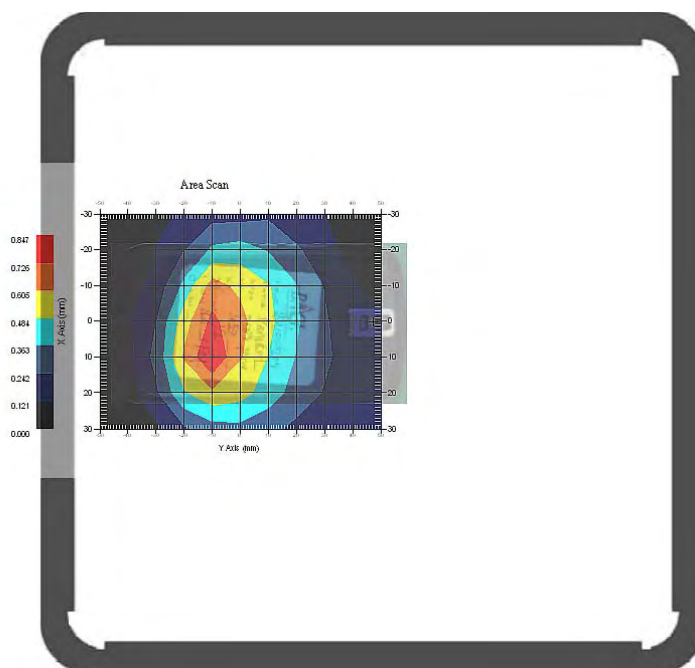

Test Laboratory: Bay Area Compliance Lab Corp. (Shenzhen)

Body- worn Back (1900 MHz Middle Channel)

Measurement Data

Test mode : GPRS
Crest Factor : 4
Scan Type : Complete
Area Scan : 7x11x1: Measurement x=10mm, y=10mm, z=4mm
Zoom Scan : 7x7x7 : Measurement x=5mm, y=5mm, z=5mm
Power Drift-Start : 0.087 W/kg
Power Drift-Finish : 0.086 W/kg
Power Drift (%) : -1.642

Tissue Data

Type : BODY
Frequency : 1900.00 MHz
Epsilon : 53.88 F/m
Sigma : 1.47 S/m
Density : 1000.00 kg/cu. m

Probe Data

Serial No. : 273
Frequency : 1900.00 MHz
Duty Cycle Factor : 4
Conversion Factor : 5.15
Probe Sensitivity : 1.20 1.20 1.20 $\mu\text{V}/(\text{V}/\text{m})^2$
Compression Point : 95.00 mV
Offset : 1.56 mm

1 gram SAR value : 0.803 W/kg
10 gram SAR value : 0.371 W/kg
Area Scan Peak SAR : 0.839 W/kg
Zoom Scan Peak SAR : 1.241 W/kg

Plot 19#

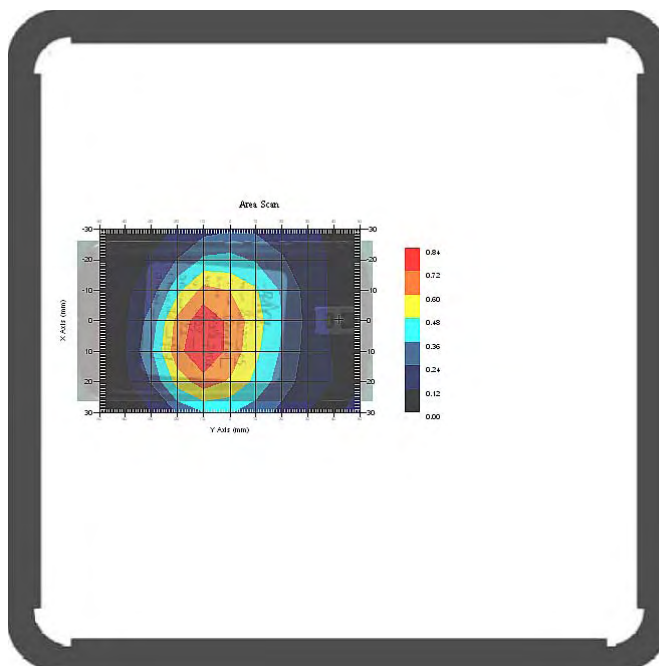

Test Laboratory: Bay Area Compliance Lab Corp. (Shenzhen)

Body- worn Back (1900 MHz High Channel)

Measurement Data

Test mode : GPRS
 Crest Factor : 4
 Scan Type : Complete
 Area Scan : 7x11x1: Measurement x=10mm, y=10mm, z=4mm
 Zoom Scan : 7x7x7 : Measurement x=5mm, y=5mm, z=5mm
 Power Drift-Start : 0.083 W/kg
 Power Drift-Finish : 0.082 W/kg
 Power Drift (%) : -1.888

Tissue Data

Type : BODY
 Frequency : 1900.00 MHz
 Epsilon : 53.88 F/m
 Sigma : 1.47 S/m
 Density : 1000.00 kg/cu. m

Probe Data

Serial No. : 273
 Frequency : 1900.00 MHz
 Duty Cycle Factor : 4
 Conversion Factor : 5.15
 Probe Sensitivity : 1.20 1.20 1.20 $\mu\text{V}/(\text{V}/\text{m})^2$
 Compression Point : 95.00 mV
 Offset : 1.56 mm

1 gram SAR value : 0.847 W/kg
 10 gram SAR value : 0.395 W/kg
 Area Scan Peak SAR : 0.852 W/kg
 Zoom Scan Peak SAR : 1.261 W/kg

Plot 20#

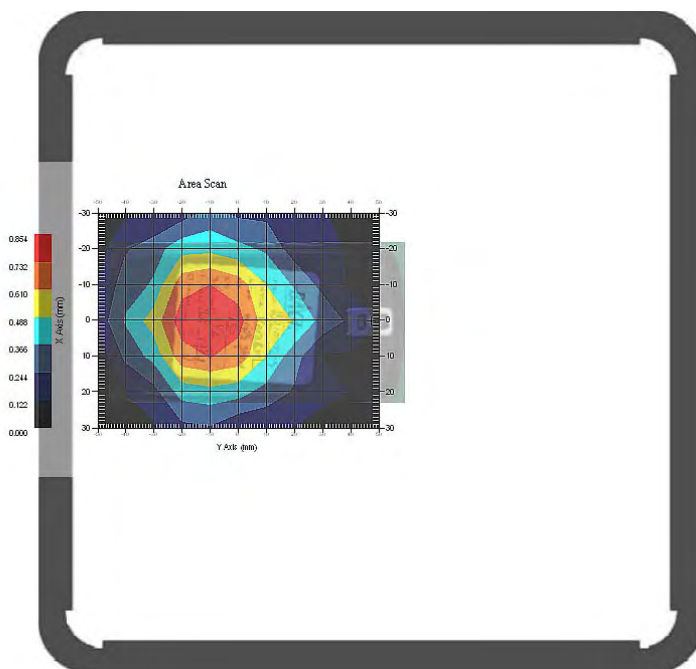

APPENDIX F – CONDUCTED OUTPUT POWER MEASUREMENT

Test Block Diagram and Procedure

The RF output of the transmitter was connected to the input of the spectrum analyzer through sufficient attenuation.

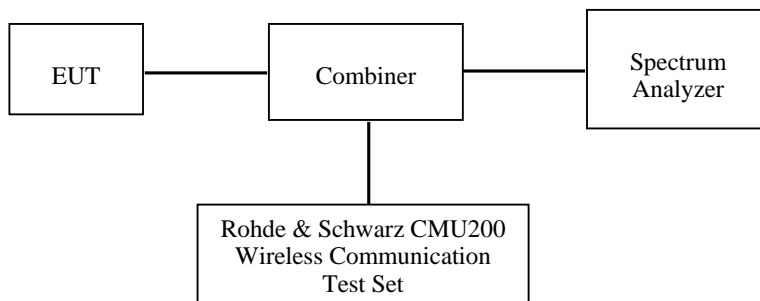

Test Equipment List and Details

Manufacturer	Equipment Description	Model No.	Serial No.	Calibration Date
Rohde & Schwarz	Communication Tester	CMU200	1100.0008.02	2010-06-28
Rohde & Schwarz	Spectrum Analyzer	FSEM30	849720/019	2010-07-05

Test Results

GSM Mode:

Band	Frequency (MHz)	Conducted Output Power (GSM Mode)	
		(dBm)	(Watt)
Cellular	824.2	31.25	1.334
	836.6	31.46	1.400
	848.8	31.46	1.400
PCS	1850.2	28.83	0.764
	1880.0	28.70	0.741
	1909.8	28.88	0.773

GPRS Mode:

Band	Channel No	Frequency (MHz)	Conducted Output Power (dBm)			
			1 slot	2 slots	3 slots	4 slots
Cellular	128	824.2	31.10	30.87	Not support	Not support
	190	836.6	31.27	31.04	Not support	Not support
	251	848.8	31.45	31.14	Not support	Not support
PCS	512	1850.2	28.67	28.39	Not support	Not support
	661	1880.0	28.59	28.32	Not support	Not support
	810	1909.8	28.80	28.51	Not support	Not support

For SAR, the time-based average power is relevant, the difference in between depends on the duty cycle of the TDMA signal.

Number of Time slot	1	2	3	4
Duty Cycle	1:8	1:4	1:2.66	1:2
Time-based Ave. power compared to slotted Ave. power	-9 dB	-6 dB	-4.25 dB	-3 dB
Crest Factor	8	4	2.66	2

The time-based average power

Band	Channel No	Frequency (MHz)	Time-based average Power (dBm)			
			1 slot	2 slots	3 slots	4 slots
Cellular	128	824.2	22.10 (31.10-9)	24.87 (30.87-6)	Not support	Not support
	190	836.6	22.27 (31.27-9)	25.04 (31.04-6)	Not support	Not support
	251	848.8	22.45 (31.45-9)	25.14 (31.14-6)	Not support	Not support
PCS	512	1850.2	19.67 (28.67-9)	22.39 (28.39-6)	Not support	Not support
	661	1880.0	19.59 (28.59-9)	22.32 (28.32-6)	Not support	Not support
	810	1909.8	19.80 (28.80-9)	22.51 (28.51-6)	Not support	Not support

APPENDIX G – EUT TEST POSITION PHOTOS

Liquid Depth ≥ 15 cm

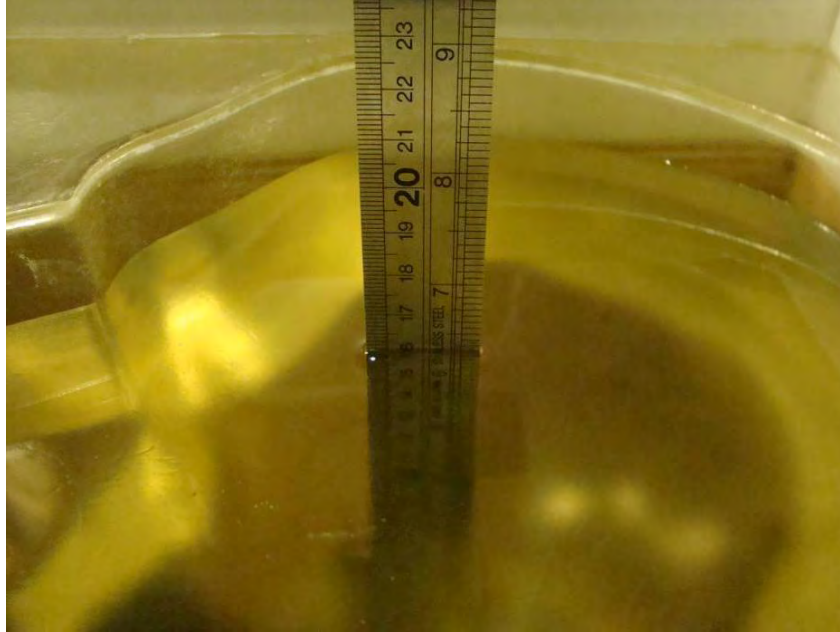

Body-worn Back Setup Photo

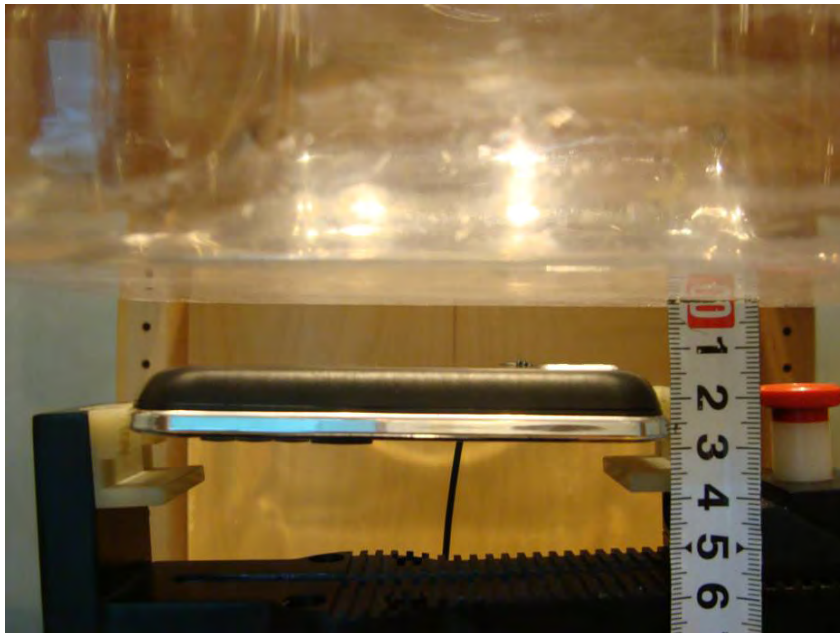

Left Head Touch Setup Photo

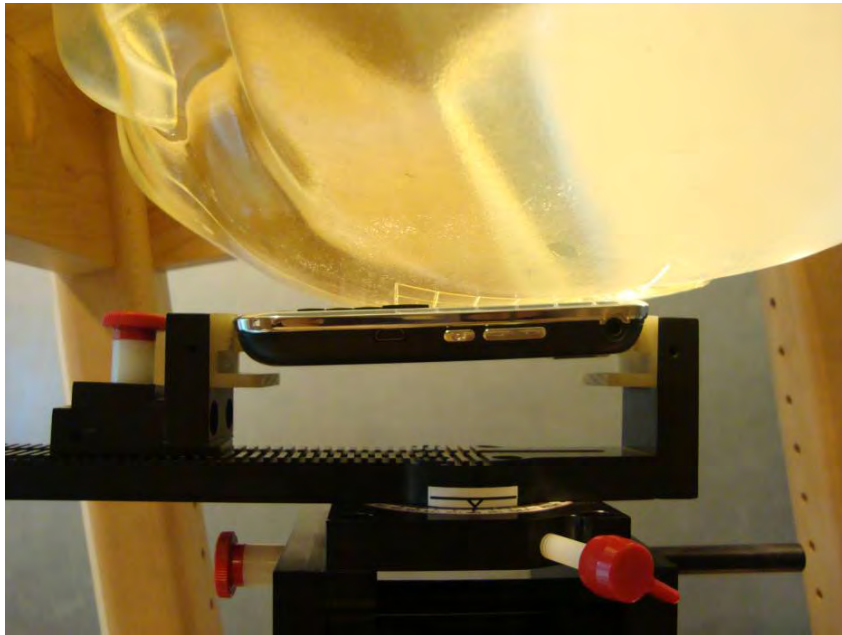

Left Head Tilt Setup Photo

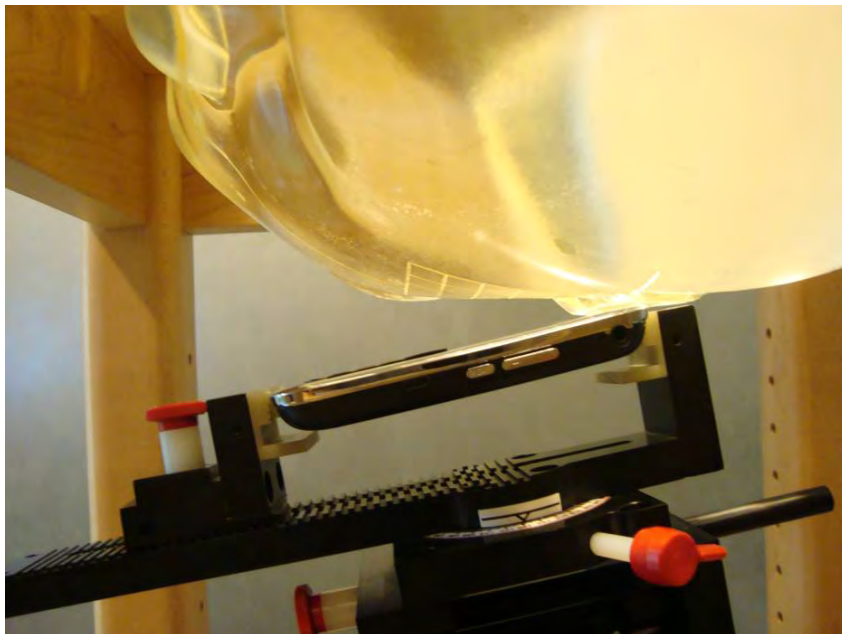

Right Head Touch Setup Photo

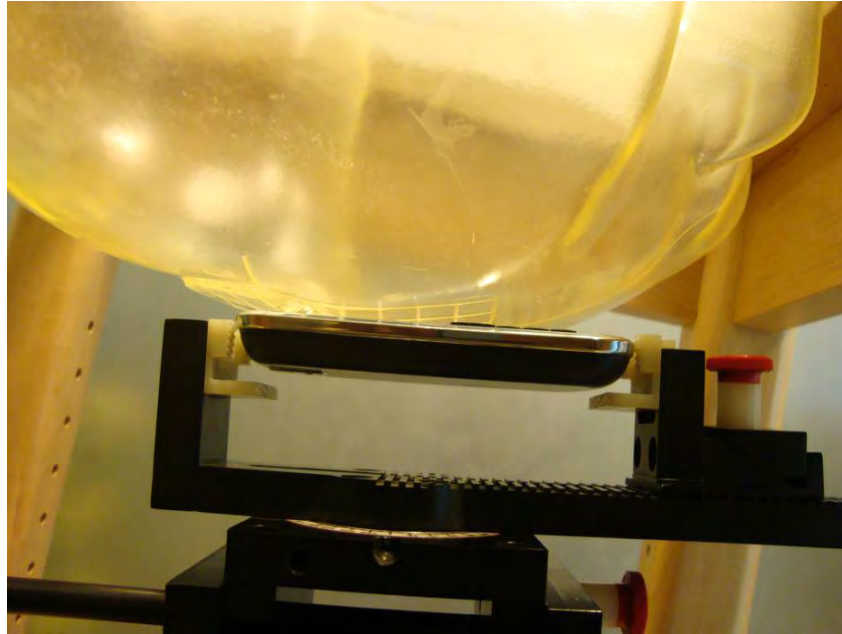

Right Head Tilt Setup Photo

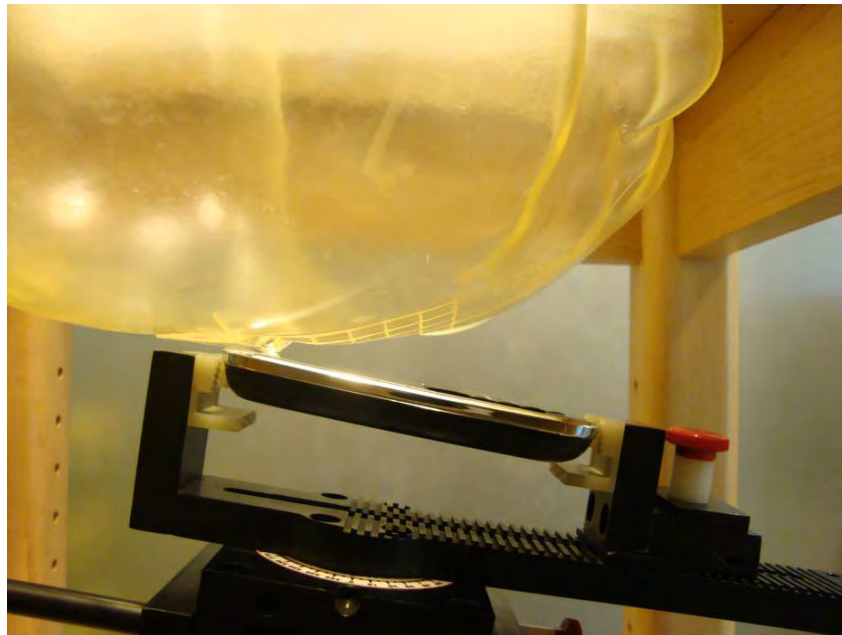

APPENDIX H – EUT PHOTOS

EUT – Front Side View



EUT – Back Side View



EUT- Battery off View



EUT- Bottom Side View



EUT- Right Side View



EUT - Headset



APPENDIX I - INFORMATIVE REFERENCES

- [1] Federal Communications Commission, \Report and order: Guidelines for evaluating the environmental effects of radiofrequency radiation", Tech. Rep. FCC 96-326, FCC, Washington, D.C. 20554, 1996.
- [2] David L. Means Kwok Chan, Robert F. Cleveland, \Evaluating compliance with FCC guidelines for human exposure to radiofrequency electromagnetic fields", Tech. Rep., Federal Communication Commission, Office of Engineering & Technology, Washington, DC, 1997.
- [3] Thomas Schmid, Oliver Egger, and Niels Kuster, \Automated E-field scanning system for dosimetric assessments", IEEE Transactions on Microwave Theory and Techniques, vol. 44, pp. 105-113, Jan. 1996.
- [4] Niels Kuster, Ralph Kastle, and Thomas Schmid, \Dosimetric evaluation of mobile communications equipment with known precision", IEEE Transactions on Communications, vol. E80-B, no. 5, pp. 645-652, May 1997.
- [5] CENELEC, \Considerations for evaluating of human exposure to electromagnetic fields (EMFs) from mobile telecommunication equipment (MTE) in the frequency range 30MHz - 6GHz", Tech. Rep., CENELEC, European Committee for Electrotechnical Standardization, Brussels, 1997.
- [6] ANSI, ANSI/IEEE C95.1-1992: IEEE Standard for Safety Levels with Respect to Human Exposure to Radio Frequency Electromagnetic Fields, 3 kHz to 300 GHz, The Institute of Electrical and Electronics Engineers, Inc., New York, NY 10017, 1992.
- [7] Katja Pokovic, Thomas Schmid, and Niels Kuster, \Robust setup for precise calibration of E-field probes in tissue simulating liquids at mobile communications frequencies", in ICECOM '97, Dubrovnik, October 15-17, 1997, pp. 120-24.
- [8] Katja Pokovic, Thomas Schmid, and Niels Kuster, \E-field probe with improved isotropy in brain simulating liquids", in Proceedings of the ELMAR, Zadar, Croatia, 23-25 June, 1996, pp. 172-175.
- [9] Volker Hombach, Klaus Meier, Michael Burkhardt, Eberhard Kuhn, and Niels Kuster, \The dependence of EM energy absorption upon human head modeling at 900 MHz", IEEE Transactions on Microwave Theory and Techniques, vol. 44, no. 10, pp. 1865-1873, Oct. 1996.
- [10] Klaus Meier, Ralf Kastle, Volker Hombach, Roger Tay, and Niels Kuster, \The dependence of EM energy absorption upon human head modeling at 1800 MHz", IEEE Transactions on Microwave Theory and Techniques, Oct. 1997, in press.
- [11] W. Gander, Computermathematik, Birkhaeuser, Basel, 1992.
- [12] W. H. Press, S. A. Teukolsky, W. T. Vetterling, and B. P. Flannery, Numerical Recipes in C, The Art of Scientific Computing, Second Edition, Cambridge University Press, 1992. Dosimetric Evaluation of Sample device, month 1998 9
- [13] NIS81 NAMAS, \The treatment of uncertainty in EMC measurement", Tech. Rep., NAMAS Executive, National Physical Laboratory, Teddington, Middlesex, England, 1994.
- [14] Barry N. Taylor and Christ E. Kuyatt, \Guidelines for evaluating and expressing the uncertainty of NIST measurement results", Tech. Rep., National Institute of Standards and Technology, 1994. Dosimetric Evaluation of Sample device, month 1998 10.

***** END OF REPORT *****