

## SAR EVALUATION REPORT

For

### Verykool USA Inc.

4350 Executive Dr. #100, San Diego, CA 92121, USA

**FCC ID: WA6I315**

<b>Report Type:</b> Original Report	<b>Product Type:</b> GSM&GPRS Dual Standby Mobile Phone
<b>Test Engineer:</b> Cabin Hu	<i>Cabin.Hu</i>
<b>Report Number:</b> RSZ11012701-SAR	
<b>Report Date:</b> 2011-03-10	
<b>Reviewed By:</b> William Chen EMC Engineer	<i>William.Chan.</i>
<b>Prepared By:</b>	Bay Area Compliance Laboratories Corp. (Shenzhen) 6/F, the 3rd Phase of WanLi Industrial Building, ShiHua Road, FuTian Free Trade Zone Shenzhen, Guangdong, China Tel: +86-755-33320018 Fax: +86-755-33320008

**Note:** This test report is prepared for the customer shown above and for the device described herein. It may not be duplicated or used in part without prior written consent from Bay Area Compliance Laboratories Corp. (Shenzhen). This report **must not** be used by the customer to claim product certification, approval, or endorsement by NVLAP\*, NIST, or any agency of the Federal Government.

\* This report contain data that are not covered by the NVLAP accreditation and are marked with an asterisk “\*”.

<b>Summary of Test Results</b>	
<b>Rule Part(s):</b>	FCC §2.1093
<b>Test Procedure(s):</b>	FCC OET Bulletin 65C IEEE 1528-2003
<b>Device Type:</b>	Portable Device
<b>Exposure Category</b>	Population/Uncontrolled
<b>Modulation:</b>	GMSK
<b>TX Frequency Range:</b>	824.2-848.8 MHz (Cellular Band) 1850.2-1909.8 MHz (PCS Band)
<b>Maximum Conducted Power Tested:</b>	32.84 dBm (GSM, Cellular Band) 30.23 dBm (GSM, PCS Band)
<b>Antenna Type(s):</b>	Integrated Antenna
<b>Body-Worn Accessories:</b>	Headset
<b>Face-Head Accessories:</b>	None
<b>Battery Type(s) Tested:</b>	3.7 VDC/430mAh, Rechargeable Battery
<b>Max. SAR Level(s) Measured:</b>	0.255 W/Kg, 1g Head Tissue (Cellular Band) 0.313 W/Kg, 1g Body Tissue (Cellular Band) 0.406 W/Kg, 1g Head Tissue (PCS Band) 0.601 W/Kg, 1g Body Tissue (PCS Band)
<p>This wireless device has been shown to be capable of compliance for localized specific absorption rate (SAR) for General Population/Uncontrolled Exposure limits specified in ANSI/IEEE Standards and has been tested in accordance with the measurement procedures specified in FCC OET 65 Supplement C and IEEE 1528-2003.</p> <p><b>The results and statements contained in this report pertain only to the device(s) evaluated.</b></p>	
	
<b>EUT Photo</b>	

**DOCUMENT REVISION HISTORY**

<b>Revision Number</b>	<b>Report Number</b>	<b>Description of Revision</b>	<b>Date of Revision</b>
0	RSZ11012701-SAR	Original Report	2011-03-06
1	RSZ11012701-SAR	Updated simultaneous issues	2011-03-10

**TABLE OF CONTENTS**

**REFERENCE, STANDARDS AND GUIDELINES ..... 5**  
     SAR LIMITS ..... 6  
**EUT DESCRIPTION ..... 7**  
     TECHNICAL SPECIFICATION ..... 7  
**FACILITIES AND ACCREDITATION ..... 8**  
**DESCRIPTION OF TEST SYSTEM ..... 9**  
**EQUIPMENT LIST AND CALIBRATION ..... 16**  
     EQUIPMENTS LIST & CALIBRATION INFO ..... 16  
**SAR MEASUREMENT SYSTEM VERIFICATION ..... 17**  
     LIQUID VERIFICATION ..... 17  
     SYSTEM ACCURACY VERIFICATION ..... 20  
**EUT TEST STRATEGY AND METHODOLOGY ..... 21**  
     TEST POSITIONS FOR DEVICE OPERATING NEXT TO A PERSON’S EAR ..... 21  
     CHEEK/TOUCH POSITION ..... 22  
     EAR/TILT POSITION ..... 22  
     TEST POSITIONS FOR BODY-WORN AND OTHER CONFIGURATIONS ..... 23  
     SAR EVALUATION PROCEDURE ..... 24  
**SAR SIMULTANEOUS TRANSMISSION EVALUATION ..... 25**  
     SIMULTANEOUS TRANSMISSION CONSIDERATION ..... 25  
**SAR MEASUREMENT RESULTS ..... 26**  
     SAR TEST DATA ..... 26  
**APPENDIX A – MEASUREMENT UNCERTAINTY ..... 28**  
**APPENDIX B – PROBE CALIBRATION CERTIFICATES ..... 29**  
**APPENDIX C – DIPOLE CALIBRATION CERTIFICATES ..... 69**  
**APPENDIX D – SAR SYSTEM VALIDATION DATA ..... 79**  
**APPENDIX E – EUT SCAN RESULTS ..... 83**  
**APPENDIX F – CONDUCTED OUTPUT POWER MEASUREMENT ..... 103**  
     TEST BLOCK DIAGRAM AND PROCEDURE ..... 103  
     TEST EQUIPMENT LIST AND DETAILS ..... 103  
     TEST RESULTS ..... 103  
**APPENDIX G – EUT TEST POSITION PHOTOS ..... 105**  
     LIQUID DEPTH  $\geq$  15 CM ..... 105  
     BODY-WORN BACK SETUP PHOTO ..... 105  
     LEFT HEAD TOUCH SETUP PHOTO ..... 106  
     LEFT HEAD TILT SETUP PHOTO ..... 106  
     RIGHT HEAD TOUCH SETUP PHOTO ..... 107  
     RIGHT HEAD TILT SETUP PHOTO ..... 107  
**APPENDIX H – EUT PHOTOS ..... 108**  
     EUT – FRONT SIDE VIEW ..... 108  
     EUT – BACK SIDE VIEW ..... 108  
     EUT- BATTERY UNCOVER VIEW ..... 109  
     EUT – HEADSET SIDE VIEW ..... 110  
**APPENDIX I - INFORMATIVE REFERENCES ..... 111**

---

## REFERENCE, STANDARDS AND GUIDELINES

---

### **FCC:**

The Report and Order requires routine SAR evaluation prior to equipment authorization of portable transmitter devices, including portable telephones. For consumer products, the applicable limit is 1.6 mW/g as recommended by the ANSI/IEEE standard C95.1-1992 [6] for an uncontrolled environment (Paragraph 65). According to the Supplement C of OET Bulletin 65 "Evaluating Compliance with FCC Guide-lines for Human Exposure to Radio frequency Electromagnetic Fields", released on Jun 29, 2001 by the FCC, the device should be evaluated at maximum output power (radiated from the antenna) under "worst-case" conditions for normal or intended use, incorporating normal antenna operating positions, device peak performance frequencies and positions for maximum RF energy coupling.

This report describes the methodology and results of experiments performed on wireless data terminal. The objective was to determine if there is RF radiation and if radiation is found, what is the extent of radiation with respect to safety limits. SAR (Specific Absorption Rate) is the measure of RF exposure determined by the amount of RF energy absorbed by human body (or its parts) – to determine how the RF energy couples to the body or head which is a primary health concern for body worn devices. The limit below which the exposure to RF is considered safe by regulatory bodies in North America is 1.6 mW/g average over 1 gram of tissue mass.

### **CE:**

The order requires routine SAR evaluation prior to equipment authorization of portable transmitter devices, including portable telephones. For consumer products, the applicable limit is 2 mW/g as recommended by the EN50360 for an uncontrolled environment. According to the Standard, the device should be evaluated at maximum output power (radiated from the antenna) under "worst-case" conditions for normal or intended use, incorporating normal antenna operating positions, device peak performance frequencies and positions for maximum RF energy coupling.

This report describes the methodology and results of experiments performed on wireless data terminal. The objective was to determine if there is RF radiation and if radiation is found, what is the extent of radiation with respect to safety limits. SAR (Specific Absorption Rate) is the measure of RF exposure determined by the amount of RF energy absorbed by human body (or its parts) – to determine how the RF energy couples to the body or head which is a primary health concern for body worn devices. The limit below which the exposure to RF is considered safe by regulatory bodies in Europe is 2 mW/g average over 10 gram of tissue mass.

The test configurations were laid out on a specially designed test fixture to ensure the reproducibility of measurements. Each configuration was scanned for SAR. Analysis of each scan was carried out to characterize the above effects in the device.

**SAR Limits**

## FCC Limit (1g Tissue)

EXPOSURE LIMITS	SAR (W/kg)	
	(General Population / Uncontrolled Exposure Environment)	(Occupational / Controlled Exposure Environment)
Spatial Average (averaged over the whole body)	0.08	0.4
Spatial Peak (averaged over any 1 g of tissue)	1.60	8.0
Spatial Peak (hands/wrists/feet/ankles averaged over 10 g)	4.0	20.0

## CE Limit (10g Tissue)

EXPOSURE LIMITS	SAR (W/kg)	
	(General Population / Uncontrolled Exposure Environment)	(Occupational / Controlled Exposure Environment)
Spatial Average (averaged over the whole body)	0.08	0.4
Spatial Peak (averaged over any 1 g of tissue)	2.0	10
Spatial Peak (hands/wrists/feet/ankles averaged over 10 g)	4.0	20.0

Population/Uncontrolled Environments are defined as locations where there is the exposure of individual who have no knowledge or control of their exposure.

Occupational/Controlled Environments are defined as locations where there is exposure that may be incurred by people who are aware of the potential for exposure (i.e. as a result of employment or occupation).

General Population/Uncontrolled environments Spatial Peak limit 1.6W/kg (FCC) & 2 W/kg (CE) applied to the EUT.

## EUT DESCRIPTION

---

This Bay Area Compliance Laboratories Corp. test report has been prepared on behalf of Verykool USA Inc, and their product, Model: I315, FCC ID: WA6I315 or the EUT (Equipment Under Test) as referred to in the rest of this report.

### Technical Specification

Item	Content
Modulation	GMSK
Frequency Band	Cellular Band: 824.2-848.8 MHz (TX) 869.2-893.8 MHz (RX) PCS Band: 1850.2-1909.8 MHz (TX) 1930.2-1989.8 MHz (RX)
Dimensions (L*W*H)	135 mm (L)× 38 mm (W)×21 mm (H)
Weight	80 g
Power Source	3.5~4.2 VDC/ 430mAh Rechargeable Battery
Normal Operation	Head and Body-worn

---

## FACILITIES AND ACCREDITATION

---

The test site used by Bay Area Compliance Laboratories Corp. (Shenzhen) to collect data is located at

6/F, the 3rd Phase of WanLi Industrial Building,  
Shi Hua Road, Fu Tian Free Trade Zone,  
Shenzhen, Guangdong, P.R. of China

Additionally, Bay Area Compliance Laboratories Corp. (Shenzhen) is a National Institute of Standards and Technology (NIST) accredited laboratory, under the National Voluntary Laboratory Accredited Program (Lab Code 200707-0).



The current scope of accreditations can be found at <http://ts.nist.gov/Standards/scopes/2007070.htm>



## DESCRIPTION OF TEST SYSTEM

---

These measurements were performed with ALSAS 10 Universal Integrated SAR Measurement system from APREL Laboratories.



### ALSAS-10U System Description

ALSAS-10-U is fully compliant with the technical and scientific requirements of IEEE 1528, IEC 62209, CENELEC, ARIB, ACA, and the Federal Communications Commission. The system comprises of a six axes articulated robot which utilizes a dedicated controller. ALSAS-10U uses the latest methodologies. And FDTD modeling to provide a platform which is repeatable with minimum uncertainty.

### Applications

Predefined measurement procedures compliant with the guidelines of CENELEC, IEEE, IEC, FCC, etc are utilized during the assessment for the device. Automatic detection for all SAR maxima are embedded within the core architecture for the system, ensuring that peak locations used for centering the zoom scan are within a 1mm resolution and a 0.05mm repeatable position. System operation range currently available up-to 6 GHz in simulated tissue.

### Area Scans

Area scans are defined prior to the measurement process being executed with a user defined variable spacing between each measurement point (integral) allowing low uncertainty measurements to be conducted. Scans defined for FCC applications utilize a 10mm<sup>2</sup> step integral, with 1mm interpolation used to locate the peak SAR area used for zoom scan assessments.

Where the system identifies multiple SAR peaks (which are within 25% of peak value) the system will provide the user with the option of assessing each peak location individually for zoom scan averaging.

### Zoom Scan (Cube Scan Averaging)

The averaging zoom scan volume utilized in the ALSAS-10U software is in the shape of a cube and the side dimension of a 1 g or 10 g mass is dependent on the density of the liquid representing the simulated tissue. A density of 1000 kg/m<sup>3</sup> is used to represent the head and body tissue density and not the phantom liquid density, in order to be consistent with the definition of the liquid dielectric properties, i.e. the side length of the 1 g cube is 10mm, with the side length of the 10 g cube 21,5mm.

When the cube intersects with the surface of the phantom, it is oriented so that 3 vertices touch the surface of the shell or the center of a face is tangent to the surface. The face of the cube closest to the surface is modified in order to conform to the tangent surface.

The zoom scan integer steps can be user defined so as to reduce uncertainty, but normal practice for typical test applications (including FCC) utilize a physical step of 5x5x8 (8mmx8mmx5mm) providing a volume of 32mm in the X & Y axis, and 35mm in the Z axis.

**ALSAS-10U Interpolation and Extrapolation Uncertainty**

The overall uncertainty for the methodology and algorithms the used during the SAR calculation was evaluated using the data from IEEE 1528 based on the example f3 algorithm:

$$f_3(x, y, z) = A \frac{a^2}{\frac{a^2}{4} + x'^2 + y'^2} \cdot \left( e^{-\frac{2z}{a}} + \frac{a^2}{2(a + 2z)^2} \right)$$

**Isotropic E-Field Probe**

The isotropic E-Field probe has been fully calibrated and assessed for isotropicity, and boundary effect within a controlled environment. Depending on the frequency for which the probe is calibrated the method utilized for calibration will change.

The E-Field probe utilizes a triangular sensor arrangement as detailed in the diagram below:

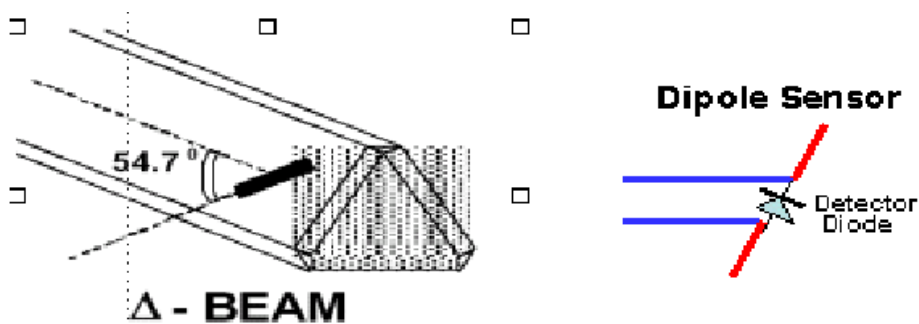

SAR is assessed with a calibrated probe which moves at a default height of 5mm from the center of the diode, which is mounted to the sensor, to the phantom surface (in the Z Axis). The 5mm offset height has been selected so as to minimize any resultant boundary effect due to the probe being in close proximity to the phantom surface.

The following algorithm is an example of the function used by the system for linearization of the output from the probe when measuring complex modulation schemes.

$$V_i = U_i + U_i^2 \cdot \frac{cf}{dcp_i}$$

### Isotropic E-Field Probe Specification

<b>Calibration in Air</b>	Frequency Dependent Below 2 GHz Calibration in air performed in a TEM Cell Above 2 GHz Calibration in air performed in waveguide
<b>Sensitivity</b>	0.70 $\mu\text{V}/(\text{V}/\text{m})^2$ to 0.85 $\mu\text{V}/(\text{V}/\text{m})^2$
<b>Dynamic Range</b>	0.0005 W/kg to 100 W/kg
<b>Isotropic Response</b>	Better than 0.2 dB
<b>Diode Compression Point (DCP)</b>	Calibration for Specific Frequency
<b>Probe Tip Radius</b>	< 5 mm
<b>Sensor Offset</b>	1.56 (+/- 0.02 mm)
<b>Probe Length</b>	290 mm
<b>Video Bandwidth</b>	@ 500 Hz: 1 dB @ 1.02 kHz: 3 dB
<b>Boundary Effect</b>	Less than 2% for distance greater than 2.4 mm
<b>Spatial Resolution</b>	Diameter less than 5 mm Compliant with Standards

### Boundary Detection Unit and Probe Mounting Device

ALSAS-10U incorporates a boundary detection unit with a sensitivity of 0.05mm for detecting all types of surfaces. The robust design allows for detection during probe tilt (probe normalize) exercises, and utilizes a second stage emergency stop. The signal electronics are fed directly into the robot controller for high accuracy surface detection in lateral and axial detection modes (X, Y, & Z).

The probe is mounted directly onto the Boundary Detection unit for accurate tooling and displacement calculations controlled by the robot kinematics. The probe is connect to an isolated probe interconnect where the output stage of the probe is fed directly into the amplifier stage of the Daq-Paq.

### Daq-Paq (Analog to Digital Electronics)

ALSAS-10U incorporates a fully calibrated Daq-Paq (analog to digital conversion system) which has a 4 channel input stage, sent via a 2 stage auto-set amplifier module. The input signal is amplified accordingly so as to offer a dynamic range from 5 $\mu\text{V}$  to 800mV. Integration of the fields measured is carried out at board level utilizing a Co-Processor which then sends the measured fields down into the main computational module in digitized form via an RS232 communications port. Probe linearity and duty cycle compensation is carried out within the main Daq-Paq module.

<b>ADC</b>	12 Bit
<b>Amplifier Range</b>	20 mV to 200 mV and 150 mV to 800 mV
<b>Field Integration</b>	Local Co-Processor utilizing proprietary integration algorithms
<b>Number of Input Channels</b>	4 in total 3 dedicated and 1 spare
<b>Communication</b>	Packet data via RS232

**Axis Articulated Robot**

ALSAS-10U utilizes a six axis articulated robot, which is controlled using a Pentium based real-time movement controller. The movement kinematics engine utilizes proprietary (Thermo CRS) interpolation and extrapolation algorithms, which allow full freedom of movement for each of the six joints within the working envelope. Utilization of joint 6 allows for full probe rotation with a tolerance better than 0.05mm around the central axis.



<b>Robot/Controller Manufacturer</b>	Thermo CRS
<b>Number of Axis</b>	Six independently controlled axis
<b>Positioning Repeatability</b>	0.05 mm
<b>Controller Type</b>	Single phase Pentium based C500C
<b>Robot Reach</b>	710 mm
<b>Communication</b>	RS232 and LAN compatible

**ALSAS Universal Workstation**

ALSAS Universal workstation allows for repeatability and fast adaptability. It allows users to do calibration, testing and measurements using different types of phantoms with one set up, which significantly speeds up the measurement process.

**Universal Device Positioner**

The universal device positioner allows complete freedom of movement of the EUT. Developed to hold a EUT in a free-space scenario any additional loading attributable to the material used in the construction of the positioner has been eliminated. Repeatability has been enhanced through the linear scales which form the design used to indicate positioning for any given test scenario in all major axes. A 15° tilt indicator is included for the of aid cheek to tilt movements for head SAR analysis. Overall uncertainty for measurements have been reduced due to the design of the Universal device positioner, which allows positioning of a device in as near to a free-space scenario as possible, and by providing the means for complete repeatability.



**Phantom Types**

The ALSAS-10U allows the integration of multiple phantom types. SAM Phantoms fully compliant with IEEE 1528, Universal Phantom, and Universal Flat.

**APREL SAM Phantoms**

The SAM phantoms developed using the IEEE SAM CAD file. They are fully compliant with the requirements for both IEEE 1528 and FCC Supplement C. Both the left and right SAM phantoms are interchangeable, transparent and include the IEEE 1528 grid with visible NF and MB lines.

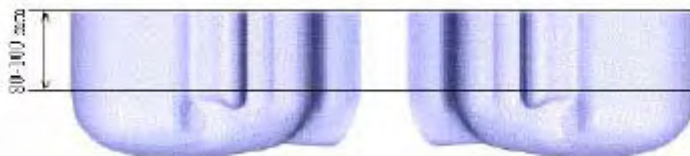

### **APREL Laboratories Universal Phantom**

The Universal Phantom is used on the ALSAS-10U as a system validation phantom. The Universal Phantom has been fully validated both experimentally from 800MHz to 6GHz and numerically using XFDTD numerical software.

The shell thickness is 2mm overall, with a 4mm spacer located at the NF/MB intersection providing an overall thickness of 6mm in line with the requirements of IEEE-1528.

The design allows for fast and accurate measurements, of handsets, by allowing the conservative SAR to be evaluated at on frequency for both left and right head experiments in one measurement.



### Tissue Dielectric Parameters for Head and Body Phantoms

The head tissue dielectric parameters recommended by the IEEE SCC-34/SC-2 in P1528 have been incorporated in the following table. These head parameters are derived from planar layer models simulating the highest expected SAR for the dielectric properties and tissue thickness variations in a human head. Other head and body tissue parameters that have not been specified in P1528 are derived from the tissue dielectric parameters computed from the 4-Cole-Cole equations described in Reference [12] and extrapolated according to the head parameters specified in P1528.

Ingredients (% by weight)	Frequency (MHz)									
	450		835		915		1900		2450	
Tissue Type	Head	Body	Head	Body	Head	Body	Head	Body	Head	Body
Water	38.56	51.16	41.45	52.4	41.05	56.0	54.9	40.4	62.7	73.2
Salt (Nacl)	3.95	1.49	1.45	1.4	1.35	0.76	0.18	0.5	0.5	0.04
Sugar	56.32	46.78	56.0	45.0	56.5	41.76	0.0	58.0	0.0	0.0
HEC	0.98	0.52	1.0	1.0	1.0	1.21	0.0	1.0	0.0	0.0
Bactericide	0.19	0.05	0.1	0.1	0.1	0.27	0.0	0.1	0.0	0.0
Triton x-100	0.0	0.0	0.0	0.0	0.0	0.0	0.0	0.0	36.8	0.0
DGBE	0.0	0.0	0.0	0.0	0.0	0.0	44.92	0.0	0.0	26.7
Dielectric Constant	43.42	58.0	42.54	56.1	42.0	56.8	39.9	54.0	39.8	52.5
Conductivity (s/m)	0.85	0.83	0.91	0.95	1.0	1.07	1.42	1.45	1.88	1.78

### IEEE SCC-34/SC-2 P1528 Recommended Tissue Dielectric Parameters

Frequency (MHz)	Head Tissue		Body Tissue	
	$\epsilon_r$	$\sigma$ (S/m)	$\epsilon_r$	$\sigma$ (S/m)
150	52.3	0.76	61.9	0.80
300	45.3	0.87	58.2	0.92
450	43.5	0.87	56.7	0.94
835	41.5	0.90	55.2	0.97
900	41.5	0.97	55.0	1.05
915	41.5	0.98	55.0	1.06
1450	40.5	1.20	54.0	1.30
1610	40.3	1.29	53.8	1.40
1800-2000	40.0	1.40	53.3	1.52
2450	39.2	1.80	52.7	1.95
3000	38.5	2.40	52.0	2.73
5800	35.3	5.27	48.2	6.00

## EQUIPMENT LIST AND CALIBRATION

### Equipments List & Calibration Info

Equipment	Model	Calibration Date	S/N
CRS F3 robot	ALS-F3	N/A	RAF0805352
CRS F3 Software	ALS-F3-SW	N/A	N/A
CRS C500C controller	ALS-C500	N/A	RCF0805379
Probe mounting device & Boundary Detection Sensor System	ALS-PMDPS-3	N/A	120-00270
Universal Work Station	ALS-UWS	N/A	100-00157
Data Acquisition Package	ALS-DAQ-PAQ-3	N/A	110-00212
Miniature E-Field Probe	ALS-E-020	2010-08-20	273
Dipole, 835 MHz	ALS-D-835-S-2	2010-09-20	180-00558
Dipole, 1900 MHz	ALS-D-1900-S-2	2010-09-20	210-00710
Dipole Spacer	ALS-DS-U	N/A	250-00907
R & S Universal Communication Tester	CMD200	2010-06-28	1100.0008.02
Device holder/Positioner	ALS-H-E-SET-2	N/A	170-00510
Left ear SAM phantom	ALS-P-SAM-L	N/A	130-00311
Right ear SAM phantom	ALS-P-SAM-R	N/A	140-00359
UniPhantom	ALS-P-UP-1	N/A	150-00413
Simulated Tissue 835 MHz Head	ALS-T-835-1-H	Each Time	270-01002
Simulated Tissue 835 MHz Body	ALS-T-835-1-B	Each Time	270-02101
Simulated Tissue 1900 MHz Head	ALS-T-1900-1-H	Each Time	295-01103
Simulated Tissue 1900 MHz Body	ALS-T-1900-1-B	Each Time	295-02102
Signal Generator	HP8648C	2010-09-18	3426A01345
Power Amplifier	5S1G4	N/A	71377
Spectrum Analyzer	FSEM30	2010-07-05	849720/019



# SAR MEASUREMENT SYSTEM VERIFICATION

## Liquid Verification

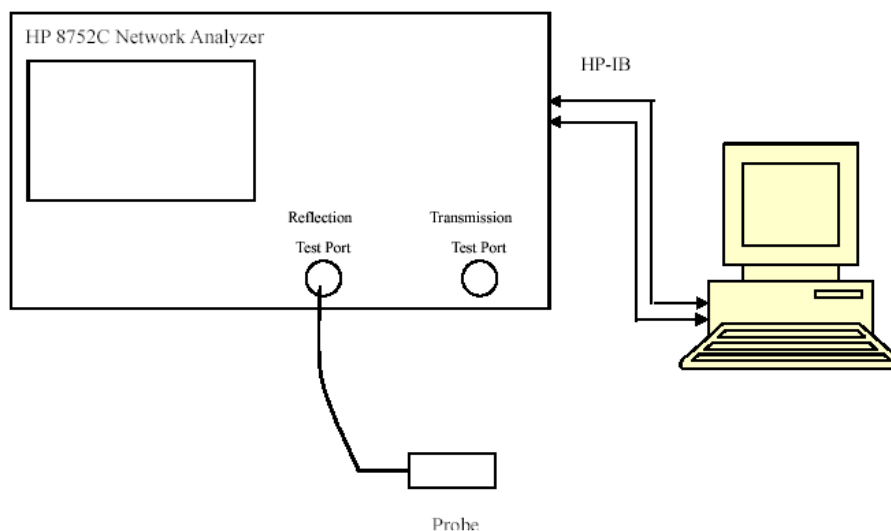

Liquid Verification Setup Block Diagram

## Liquid Verification Results

Frequency (MHz)	Liquid Type	Liquid Parameter		Result
		$\epsilon_r$	$\sigma$ (S/m)	
835	Head	41.15	0.91	In Tolerance
835	Body	55.33	0.98	In Tolerance
1900	Head	40.04	1.46	In Tolerance
1900	Body	53.87	1.48	In Tolerance

*\*The liquid verification data is 2011-03-01.*

Please refer to the following tables

850 MHz Head				850 MHz Body		
Frequency	e'	e''		Frequency	e'	e''
824000000	41.196809	19.483208		824000000	55.359190	21.331874
824500000	41.165717	19.473958		824500000	55.332898	21.340491
825000000	41.149023	19.439583		825000000	55.321411	21.343613
825500000	41.043671	19.429564		825500000	55.257794	21.371684
826000000	41.062066	19.406907		826000000	55.242364	21.303725
826500000	41.084003	19.378031		826500000	55.330058	21.348075
827000000	41.060442	19.414494		827000000	55.352963	21.338393
827500000	41.107859	19.420840		827500000	55.366068	21.332314
828000000	41.127504	19.403127		828000000	55.312087	21.295648
828500000	41.133944	19.452302		828500000	55.306901	21.329776
829000000	41.184978	19.510155		829000000	55.326140	21.310280
829500000	41.133367	19.501491		829500000	55.340504	21.337026
830000000	41.169808	19.468491		830000000	55.386470	21.329639
830500000	41.129756	19.425201		830500000	55.310899	21.323540
831000000	41.102700	19.504388		831000000	55.271880	21.325888
831500000	41.122294	19.486598		831500000	55.327646	21.403349
832000000	41.084035	19.411522		832000000	55.289719	21.261480
832500000	41.058805	19.458624		832500000	55.254573	21.273533
833000000	41.099426	19.403667		833000000	55.294417	21.279391
833500000	41.130909	19.466293		833500000	55.373647	21.331006
834000000	41.128329	19.444269		834000000	55.321324	21.239256
834500000	41.126906	19.463698		834500000	55.365408	21.270879
835000000	41.153785	19.452918		835000000	55.333073	21.285883
835500000	41.185787	19.443483		835500000	55.368806	21.256023
836000000	41.116394	19.424621		836000000	55.308111	21.272339
836500000	41.111396	19.486594		836500000	55.313764	21.318345
837000000	41.128166	19.459205		837000000	55.327895	21.256749
837500000	41.122362	19.407033		837500000	55.415041	21.271557
838000000	41.145580	19.476494		838000000	55.392884	21.273220
838500000	41.104028	19.444816		838500000	55.353483	21.286932
839000000	41.093938	19.450965		839000000	55.307564	21.297670
839500000	41.096413	19.391470		839500000	55.368519	21.272952
840000000	41.107503	19.417535		840000000	55.333769	21.241216
840500000	41.096842	19.403199		840500000	55.341521	21.220510
841000000	41.080081	19.385452		841000000	55.315993	21.212630
841500000	41.109583	19.421688		841500000	55.363215	21.209481
842000000	41.111288	19.378113		842000000	55.317330	21.247632
842500000	41.114992	19.359775		842500000	55.366673	21.221774
843000000	41.109075	19.416223		843000000	55.342361	21.202600
843500000	41.032623	19.405237		843500000	55.320352	21.231489
844000000	41.109030	19.371370		844000000	55.297952	21.217044
844500000	41.063228	19.413388		844500000	55.293893	21.249829
845000000	40.989096	19.391615		845000000	55.279492	21.199776
845500000	41.004429	19.395666		845500000	55.298592	21.180172
846000000	40.958920	19.365880		846000000	55.227185	21.206547
846500000	40.999942	19.352380		846500000	55.298533	21.209940
847000000	40.980171	19.376687		847000000	55.325417	21.154839
847500000	40.983362	19.373966		847500000	55.314234	21.168640
848000000	40.956910	19.338925		848000000	55.263973	21.165253
848500000	40.961515	19.376603		848500000	55.262241	21.175343
849000000	40.921702	19.365841		849000000	55.303670	21.157778

1900 MHz Head				1900 MHz Body		
Frequency	e'	e''		Frequency	e'	e''
185000000	40.285338	13.812149		185000000	53.788904	13.952822
185120000	40.299870	13.807234		185120000	53.775482	13.974799
185240000	40.296776	13.779107		185240000	53.799759	13.955439
185360000	40.231388	13.755756		185360000	53.749320	13.898657
185480000	40.221349	13.766171		185480000	53.766381	13.941798
185600000	40.233659	13.787513		185600000	53.751384	13.957769
185720000	40.258787	13.769757		185720000	53.761404	13.910113
185840000	40.242120	13.784407		185840000	53.756489	13.961909
185960000	40.218160	13.772539		185960000	53.758853	13.947276
186080000	40.228784	13.751426		186080000	53.792241	13.942054
186200000	40.208519	13.740434		186200000	53.779808	13.910976
186320000	40.212515	13.748308		186320000	53.781769	13.945307
186440000	40.213084	13.721148		186440000	53.756776	13.929279
186560000	40.173400	13.703838		186560000	53.804820	13.944258
186680000	40.151302	13.709531		186680000	53.773929	13.929956
186800000	40.183331	13.702868		186800000	53.756280	13.925990
186920000	40.173263	13.722736		186920000	53.826274	13.973264
187040000	40.163010	13.693173		187040000	53.798001	13.986543
187160000	40.161361	13.726261		187160000	53.823715	13.976762
187280000	40.179028	13.740969		187280000	53.836483	13.993811
187400000	40.186481	13.759033		187400000	53.827116	14.023507
187520000	40.174390	13.746121		187520000	53.849105	14.009583
187640000	40.156764	13.783089		187640000	53.853246	14.045714
187760000	40.158526	13.767594		187760000	53.850941	14.050226
187880000	40.153850	13.780934		187880000	53.890947	14.072218
188000000	40.165929	13.820744		188000000	53.915346	14.048551
188120000	40.130663	13.810171		188120000	53.885520	14.104596
188240000	40.135220	13.833072		188240000	53.878485	14.083377
188360000	40.150857	13.814989		188360000	53.895671	14.092495
188480000	40.166471	13.830899		188480000	53.936240	14.102599
188600000	40.152264	13.853368		188600000	53.923133	14.135859
188720000	40.143301	13.835420		188720000	53.937512	14.117437
188840000	40.132164	13.852843		188840000	53.914386	14.111164
188960000	40.112247	13.841894		188960000	53.911503	14.134930
189080000	40.107543	13.830549		189080000	53.896780	14.113383
189200000	40.107639	13.865514		189200000	53.929777	14.119039
189320000	40.072212	13.839828		189320000	53.933342	14.129428
189440000	40.082707	13.828077		189440000	53.901678	14.093601
189560000	40.089052	13.877542		189560000	53.891170	14.116953
189680000	40.062243	13.855681		189680000	53.871277	14.130251
189800000	40.042300	13.854101		189800000	53.870412	14.155924
189920000	40.028711	13.823881		189920000	53.903274	14.112834
190040000	40.042837	13.841771		190040000	53.871086	14.118084
190160000	40.062090	13.829452		190160000	53.891961	14.113195
190280000	40.054954	13.838232		190280000	53.888607	14.103759
190400000	40.053747	13.837042		190400000	53.883874	14.133078
190520000	40.039477	13.844225		190520000	53.869828	14.096061
190640000	40.059915	13.838389		190640000	53.845303	14.083881
190760000	40.062160	13.847307		190760000	53.869098	14.075333
190880000	40.060663	13.864744		190880000	53.836041	14.086191
191000000	40.110146	13.880157		191000000	53.849410	14.098567

### System Accuracy Verification

Prior to the assessment, the system validation kit was used to test whether the system was operating within its specifications of  $\pm 10\%$ . The validation results are tabulated below. And also the corresponding SAR plot is attached as well in the SAR plots files.

### System Verification Setup Block Diagram

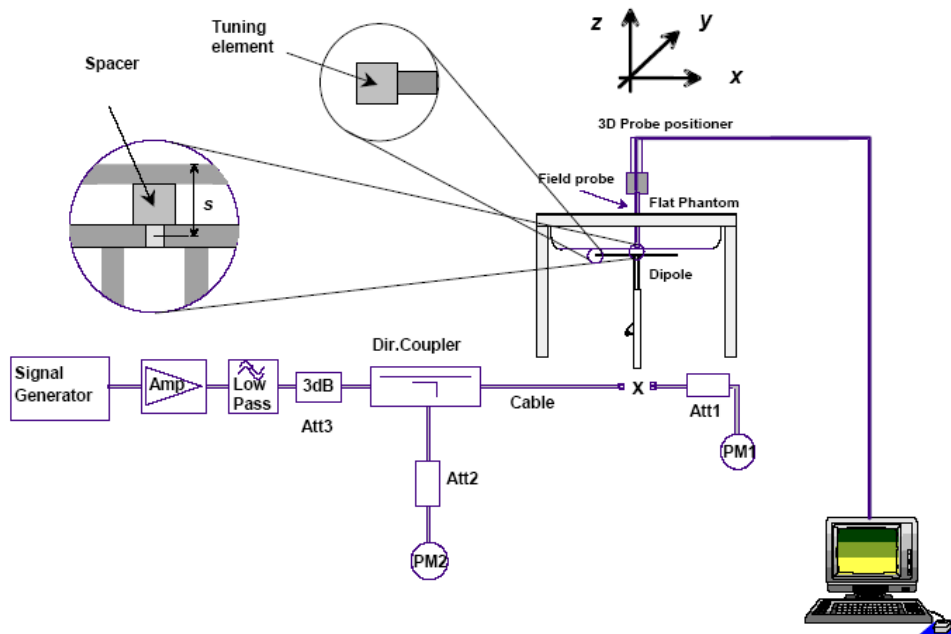

### System Accuracy Check Results

Frequency (MHz)	1 g SAR (W/Kg)	10 g SAR (W/Kg)	Result
835	9.621	6.037	In Tolerance
1900	40.245	20.421	In Tolerance

- Note: The system verification data is 2011-03-02.  
All SAR values are normalized to 1 Watt forward power.

### IEEE P1528 recommended reference value for Head Tissue

Frequency (MHz)	1 g SAR (W/Kg)	10 g SAR (W/Kg)	Local SAR at surface (above feed point)	Local SAR at surface ( $v=2\text{cm}$ offset from feed point)
300	3.0	2.0	4.4	2.1
450	4.9	3.3	7.2	3.2
835	9.5	6.2	14.1	4.9
900	10.8	6.9	16.4	5.4
1450	29.0	16.0	50.2	6.5
1800	38.1	19.8	69.5	6.8
1900	39.7	20.5	72.1	6.6
2000	41.1	21.1	74.6	6.5
2450	52.4	24.0	104.2	7.7
3000	63.8	25.7	140.2	9.5

## EUT TEST STRATEGY AND METHODOLOGY

### Test Positions for Device Operating Next to a Person’s Ear

This category includes most wireless handsets with fixed, retractable or internal antennas located toward the top half of the device, with or without a foldout, sliding or similar keypad cover. The handset should have its earpiece located within the upper ¼ of the device, either along the centerline or off-centered, as perceived by its users. This type of handset should be positioned in a normal operating position with the “test device reference point” located along the “vertical centerline” on the front of the device aligned to the “ear reference point”. The “test device reference point” should be located at the same level as the center of the earpiece region. The “vertical centerline” should bisect the front surface of the handset at its top and bottom edges. A “ear reference point” is located on the outer surface of the head phantom on each ear spacer. It is located 1.5 cm above the center of the ear canal entrance in the “phantom reference plane” defined by the three lines joining the center of each “ear reference point” (left and right) and the tip of the mouth.

A handset should be initially positioned with the earpiece region pressed against the ear spacer of a head phantom. For the SCC-34/SC-2 head phantom, the device should be positioned parallel to the “N-F” line defined along the base of the ear spacer that contains the “ear reference point”. For interim head phantoms, the device should be positioned parallel to the cheek for maximum RF energy coupling. The “test device reference point” is aligned to the “ear reference point” on the head phantom and the “vertical centerline” is aligned to the “phantom reference plane”. This is called the “initial ear position”. While maintaining these three alignments, the body of the handset is gradually adjusted to each of the following positions for evaluating SAR:

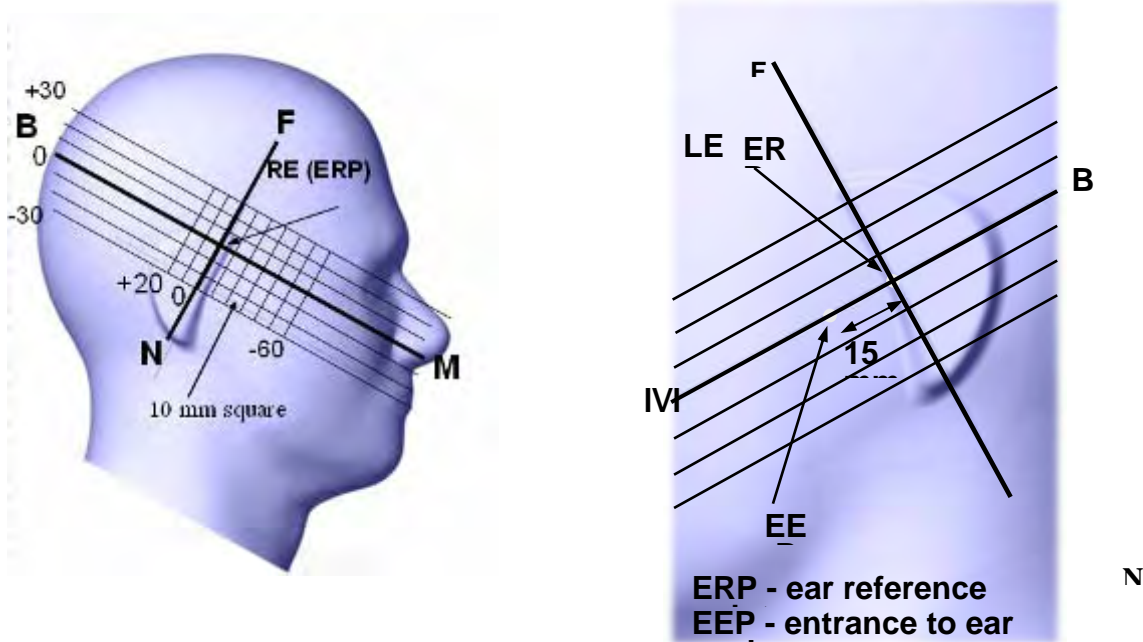

## Cheek/Touch Position

The device is brought toward the mouth of the head phantom by pivoting against the “ear reference point” or along the “N-F” line for the SCC-34/SC-2 head phantom.

This test position is established:

- When any point on the display, keypad or mouthpiece portions of the handset is in contact with the phantom.
- (or) When any portion of a foldout, sliding or similar keypad cover opened to its intended self-adjusting normal use position is in contact with the cheek or mouth of the phantom.

For existing head phantoms – when the handset loses contact with the phantom at the pivoting point, rotation should continue until the device touches the cheek of the phantom or breaks its last contact from the ear spacer.

### Check /Touch Position

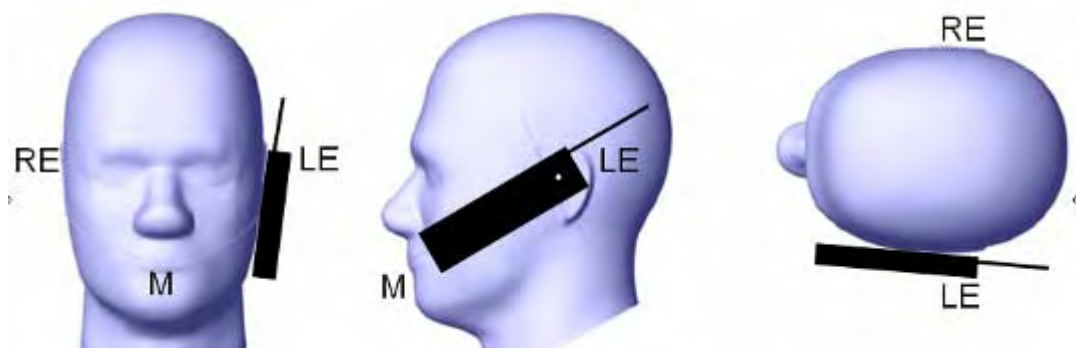

## Ear/Tilt Position

With the handset aligned in the “Cheek/Touch Position”:

1) If the earpiece of the handset is not in full contact with the phantom’s ear spacer (in the “Cheek/Touch position”) and the peak SAR location for the “Cheek/Touch” position is located at the ear spacer region or corresponds to the earpiece region of the handset, the device should be returned to the “initial ear position” by rotating it away from the mouth until the earpiece is in full contact with the ear spacer.

2) (otherwise) The handset should be moved (translated) away from the cheek perpendicular to the line passes through both “ear reference points” (note: one of these ear reference points may not physically exist on a split head model) for approximate 2-3 cm. While it is in this position, the device handset is tilted away from the mouth with respect to the “test device reference point” until the inside angle between the vertical centerline on the front surface of the phone and the horizontal line passing through the ear reference point is by 15 80°. After the tilt, it is then moved (translated) back toward the head perpendicular to the line passes through both “ear reference points” until the device touches the phantom or the ear spacer. If the antenna touches the head first, the positioning process should be repeated with a tilt angle less than 15° so that the device and its antenna would touch the phantom simultaneously. This test position may require a device holder or positioner to achieve the translation and tilting with acceptable positioning repeatability.

If a device is also designed to transmit with its keypad cover closed for operating in the head position, such positions should also be considered in the SAR evaluation. The device should be tested on the left and right side of the head phantom in the “Cheek/Touch” and “Ear/Tilt” positions. When applicable, each configuration should be tested with the antenna in its fully extended and fully retracted positions. These test configurations should be tested at the high, middle and low frequency channels of each operating mode; for example, AMPS, CDMA, and TDMA. If the SAR measured at the middle channel for each test configuration (left, right, Cheek/Touch, Tile/Ear, extended and retracted) is at least 2.0 dB lower than the SAR limit, testing at the high and low channels is optional for such test configuration(s). If the transmission band of the test device is less than 10 MHz, testing at the high and low frequency channels is optional.

### Ear /Tilt 15° Position

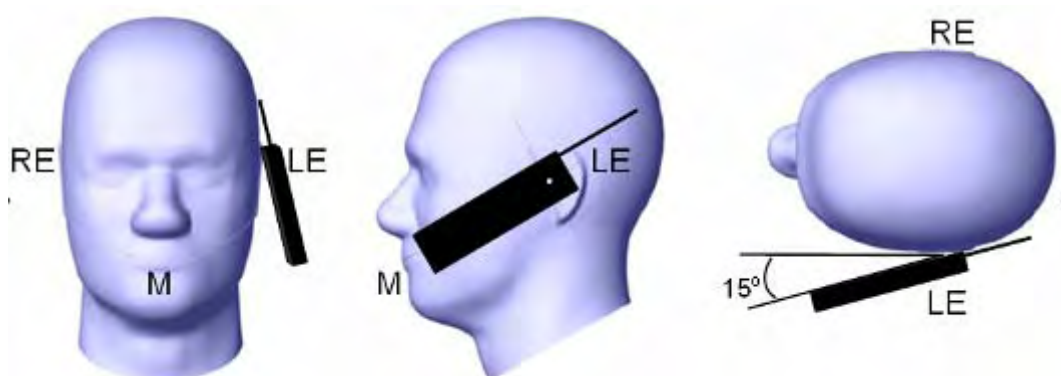

### **Test positions for body-worn and other configurations**

Body-worn operating configurations should be tested with the belt-clips and holsters attached to the device and positioned against a flat phantom in normal use configurations. Devices with a headset output should be tested with a headset connected to the device. When multiple accessories that do not contain metallic components are supplied with the device, the device may be tested with only the accessory that dictates the closest spacing to the body. When multiple accessories that contain metallic components are supplied with the device, the device must be tested with each accessory that contains a unique metallic component. If multiple accessories share an identical metallic component (e.g., the same metallic belt-clip used with different holsters with no other metallic components), only the accessory that dictates the closest spacing to the body must be tested.

Body-worn accessories may not always be supplied or available as options for some devices that are intended to be authorized for body-worn use. A separation distance of 1.5 cm between the back of the device and a flat phantom is recommended for testing body-worn SAR compliance under such circumstances. Other separation distances may be used, but they should not exceed 2.5 cm. In these cases, the device may use body-worn accessories that provide a separation distance greater than that tested for the device provided however that the accessory contains no metallic components.

## SAR Evaluation Procedure

The evaluation was performed with the following procedure:

- Step 1: Measurement of the SAR value at a fixed location above the ear point or central position was used as a reference value for assessing the power drop. The SAR at this point is measured at the start of the test and then again at the end of the testing.
- Step 2: The SAR distribution at the exposed side of the head was measured at a distance of 4 mm from the inner surface of the shell. The area covered the entire dimension of the head or EUT and the horizontal grid spacing was 15 mm x 15 mm. Based on these data, the area of the maximum absorption was determined by spline interpolation. The first Area Scan covers the entire dimension of the EUT to ensure that the hotspot was correctly identified.
- Step 3: Around this point, a volume of 30 mm x 30 mm x 21 mm was assessed by measuring 5 x 5 x 7 points. On the basis of this data set, the spatial peak SAR value was evaluated under the following procedure:
- 1) The data at the surface were extrapolated, since the center of the dipoles is 1.2 mm away from the tip of the probe and the distance between the surface and the lowest measuring point is 1.3 mm. The extrapolation was based on a least square algorithm. A polynomial of the fourth order was calculated through the points in z-axes. This polynomial was then used to evaluate the points between the surface and the probe tip.
  - 2) The maximum interpolated value was searched with a straightforward algorithm. Around this maximum the SAR values averaged over the spatial volumes (1 g or 10 g) were computed by the 3D-Spline interpolation algorithm. The 3D-Spline is composed of three one dimensional splines with the "Not a knot"-condition (in x, y and z-directions). The volume was integrated with the trapezoidal-algorithm. One thousand points (10 x 10 x 10) were interpolated to calculate the averages.
- All neighboring volumes were evaluated until no neighboring volume with a higher average value was found.
- Step 4: Re-measurement of the SAR value at the same location as in Step 1. If the value changed by more than 5%, the evaluation was repeated.



## SAR SIMULTANEOUS TRANSMISSION EVALUATION

### Simultaneous Transmission Consideration

According to FCC KDB648474, the stand-alone and simultaneous SAR evaluation for a cell phone with multiple transmitters is base on the antennas distance and output power of each radio.

BT and GSM Antenna Location

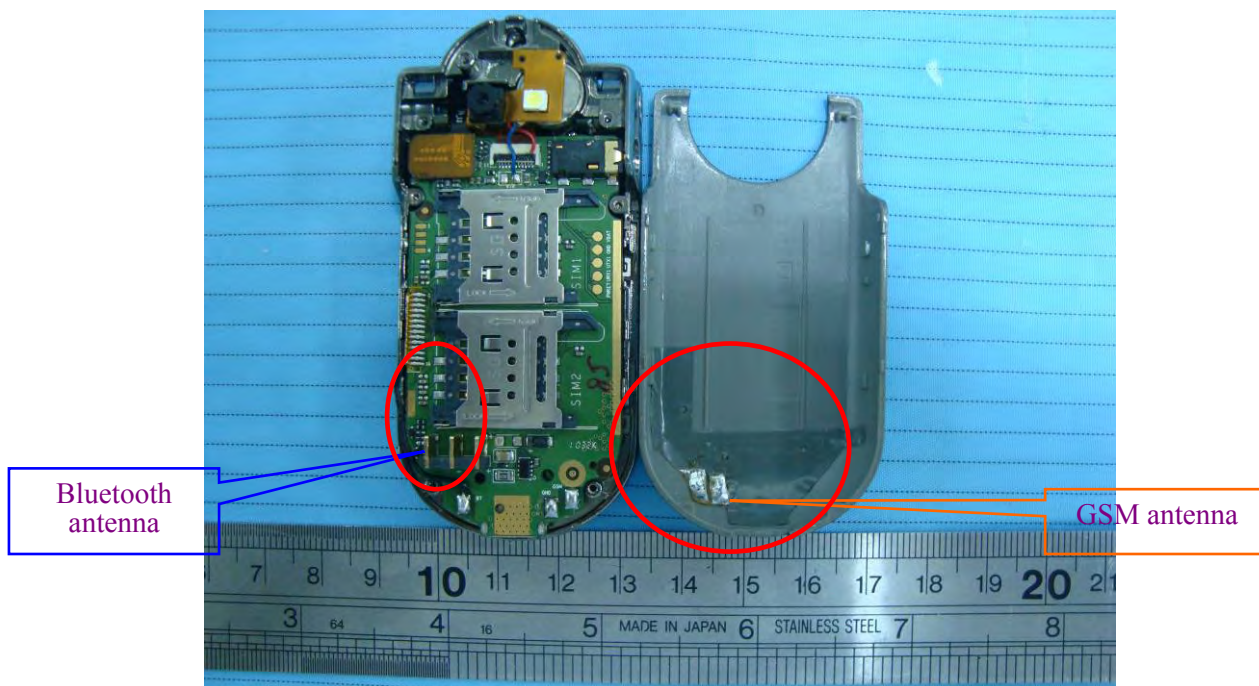

Individual transmitter	Stand-alone SAR	Simultaneous SAR
Bluetooth	Not required	GSM with Bluetooth is not required
GSM	Required	GSM with Bluetooth is not required

Note:

- 1) The distance between BT and GSM antenna is about 0.7 cm < 2.5 cm, the max output power of Bluetooth antenna is 2.37 mw < PRef (12 mw), According to KDB648474, stand-alone SAR is not required for BT antenna.
- 2) The stand-alone SAR for GSM antenna is required, due to the maximum SAR of GSM antenna is less than 1.2 W/Kg. SAR evaluation of simultaneous transmission of BT and GSM antenna is not required.

## SAR MEASUREMENT RESULTS

This page summarizes the results of the performed dosimetric evaluation. The plots with the corresponding SAR distributions, which reveal information about the location of the maximum SAR with respect to the device, could be found in Appendix E.

### SAR Test Data

#### Environmental Conditions

<b>Temperature:</b>	21° C
<b>Relative Humidity:</b>	52%
<b>ATM Pressure:</b>	1005 mbar

\* Testing was performed by Cabin Hu on 2011.03.04----2011.03.06.

#### Cellular Band:

EUT Position	Frequency (MHz)		Test Mode	Antenna Type	1g SAR Value (W/Kg)	FCC Limit (W/Kg)
	Channel	MHz				
Left Head Cheek	128 (Low)	824.2	GSM	Integral	-	1.6
	190 (Middle)	836.6	GSM	Integral	-	1.6
	251 (High)	848.8	GSM	Integral	0.229	1.6
Left Head Tilt	128 (Low)	824.2	GSM	Integral	-	1.6
	190 (Middle)	836.6	GSM	Integral	-	1.6
	251 (High)	848.8	GSM	Integral	0.156	1.6
Right Head Cheek	128 (Low)	824.2	GSM	Integral	0.244	1.6
	190 (Middle)	836.6	GSM	Integral	0.245	1.6
	251 (High)	848.8	GSM	Integral	0.255	1.6
Right Head Tilt	128 (Low)	824.2	GSM	Integral	-	1.6
	190 (Middle)	836.6	GSM	Integral	-	1.6
	251 (High)	848.8	GSM	Integral	0.187	1.6
Body-Worn Back	251 (High)	848.8	GSM	Integral	0.151	1.6
	128 (Low)	824.2	GPRS	Integral	0.291	1.6
	190 (Middle)	836.6	GPRS	Integral	0.282	1.6
	251 (High)	848.8	GPRS	Integral	0.313	1.6

**PCS Band:**

EUT Position	Frequency (MHz)		Test Mode	Antenna Type	1g SAR Value (W/Kg)	FCC Limit (W/Kg)
	Channel	MHz				
Left Head Cheek	512 (Low)	1850.2	GSM	Integral	0.406	1.6
	661 (Middle)	1880.0	GSM	Integral	0.395	1.6
	810 (High)	1909.8	GSM	Integral	0.404	1.6
Left Head Tilt	512 (Low)	1850.2	GSM	Integral	0.219	1.6
	661 (Middle)	1880.0	GSM	Integral	-	1.6
	810 (High)	1909.8	GSM	Integral	-	1.6
Right Head Cheek	512 (Low)	1850.2	GSM	Integral	0.403	1.6
	661 (Middle)	1880.0	GSM	Integral	-	1.6
	810 (High)	1909.8	GSM	Integral	-	1.6
Right Head Tilt	512 (Low)	1850.2	GSM	Integral	0.203	1.6
	661 (Middle)	1880.0	GSM	Integral	-	1.6
	810 (High)	1909.8	GSM	Integral	-	1.6
Body-Worn Back	512 (Low)	1850.2	GSM	Integral	0.298	1.6
	512 (Low)	1850.2	GPRS	Integral	0.601	1.6
	661 (Middle)	1880.0	GPRS	Integral	0.567	1.6
	810 (High)	1909.8	GPRS	Integral	0.564	1.6

**Note:**

1. 2slot configuration of GPRS is the worse-case of body position.
2. GPRS was tested with 2slot configuration.

## APPENDIX A – MEASUREMENT UNCERTAINTY

The uncertainty budget has been determined for the measurement system and is given in the following Table.

### Exposure Assessment Measurement Uncertainty

Source of Uncertainty	Tolerance Value	Probability Distribution	Divisor	$c_i^1$ (1-g)	$c_i^1$ (10-g)	Standard Uncertainty (1-g) %	Standard Uncertainty (10-g) %
<b>Measurement System</b>							
Probe Calibration	3.5	normal	1	1	1	3.5	3.5
Axial Isotropy	3.7	rectangular	$\sqrt{3}$	$(1-cp)^{1/2}$	$(\frac{1-cp}{2})^1$	1.5	1.5
Hemispherical Isotropy	10.9	rectangular	$\sqrt{3}$	$\sqrt{cp}$	$\sqrt{cp}$	4.4	4.4
Boundary Effect	1.0	rectangular	$\sqrt{3}$	1	1	0.6	0.6
Linearity	4.7	rectangular	$\sqrt{3}$	1	1	2.7	2.7
Detection Limit	1.0	rectangular	$\sqrt{3}$	1	1	0.6	0.6
Readout Electronics	1.0	normal	1	1	1	1.0	1.0
Response Time	0.8	rectangular	$\sqrt{3}$	1	1	0.5	0.5
Integration Time	1.7	rectangular	$\sqrt{3}$	1	1	1.0	1.0
RF Ambient Condition	3.0	rectangular	$\sqrt{3}$	1	1	1.7	1.7
Probe Positioner Mech.	0.4	rectangular	$\sqrt{3}$	1	1	0.2	0.2
<b>Restriction</b>							
Probe Positioning with respect to Phantom Shell	2.9	rectangular	$\sqrt{3}$	1	1	1.7	1.7
Extrapolation and Integration	3.7	rectangular	$\sqrt{3}$	1	1	2.1	2.1
Test Sample Positioning	4.0	normal	1	1	1	4.0	4.0
Device Holder Uncertainty	2.0	normal	1	1	1	2.0	2.0
Drift of Output Power	3.2	rectangular	$\sqrt{3}$	1	1	1.8	1.8
<b>Phantom and Setup</b>							
Phantom Uncertainty(shape & thickness tolerance)	3.4	rectangular	$\sqrt{3}$	1	1	2.0	2.0
Liquid Conductivity(target)	5.0	rectangular	$\sqrt{3}$	0.7	0.5	2.0	1.4
Liquid Conductivity(meas.)	0.0	normal	1	0.7	0.5	0.0	0.0
Liquid Permittivity(target)	5.0	rectangular	$\sqrt{3}$	0.6	0.5	1.7	1.4
Liquid Permittivity(meas.)	0.0	normal	1	0.6	0.5	0.0	0.0
Combined Uncertainty		RSS				9.4	9.2
Combined Uncertainty (coverage factor=2)		Normal(k=2)				18.8	18.5

---

## APPENDIX B – PROBE CALIBRATION CERTIFICATES

---

### NCL CALIBRATION LABORATORIES

Calibration File No.: CP-1139

Client.: BACL

## CERTIFICATE OF CALIBRATION

It is certified that the equipment identified below has been calibrated in the **NCL CALIBRATION LABORATORIES** by qualified personnel following recognized procedures and using transfer standards traceable to NRC/NIST.

Equipment: Miniature Isotropic RF Probe 835 MHz

Manufacturer: APREL Laboratories

Model No.: E-020

Serial No.: 273

Calibration in Head Tissue

Calibration Procedure: SSI/DRB-TP-D01-032-E020-V2

Project No: BACB-E020-5537

Calibrated: 20<sup>th</sup> August 2010

Released on: 24<sup>th</sup> August 2010

This Calibration Certificate is Incomplete Unless Accompanied with the Calibration Results Summary

Released By: \_\_\_\_\_

### **NCL** CALIBRATION LABORATORIES

51 SPECTRUM WAY  
NEPEAN, ONTARIO  
CANADA K2R 1E6

Division of APREL Lab.  
TEL: (613) 820-4988  
FAX: (613) 820-4161

**NCL Calibration Laboratories**

Division of APREL Laboratories.

**Introduction**

This Calibration Report reproduces the results of the calibration performed in line with the SSI/DRB-TP-D01-032-E020-V2 E-Field Probe Calibration Procedure. The results contained within this report are for APREL E-Field Probe E-020 273.

**References**

SSI/DRB-TP-D01-032-E020-V2 E-Field Probe Calibration Procedure  
IEEE 1528 "Recommended Practice for Determining the Peak Spatial-Average Specific Absorption Rate (SAR) in the Human Body Due to Wireless Communications Devices: Experimental Techniques"  
SSI-TP-011 Tissue Calibration Procedure

**Conditions**

Probe 273 was a re-calibration.

**Ambient Temperature of the Laboratory:** 22 °C +/- 0.5°C

**Temperature of the Tissue:** 21 °C +/- 0.5°C

We the undersigned attest that to the best of our knowledge the calibration of this probe has been accurately conducted and that all information contained within this report has been reviewed for accuracy.

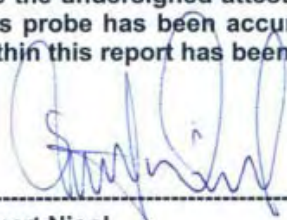

-----  
Stuart Nicol



-----  
Jesse Hones

Page 2 of 10

This page has been reviewed for content and attested to on Page 2 of this document.

**NCL Calibration Laboratories**

Division of APREL Laboratories.

**Calibration Results Summary**

<b>Probe Type:</b>	E-Field Probe E-020
<b>Serial Number:</b>	273
<b>Frequency:</b>	835 MHz
<b>Sensor Offset:</b>	1.56 mm
<b>Sensor Length:</b>	2.5 mm
<b>Tip Enclosure:</b>	Ertalyte*
<b>Tip Diameter:</b>	<5 mm
<b>Tip Length:</b>	60 mm
<b>Total Length:</b>	290 mm

\*Resistive to recommended tissue recipes per IEEE-1528

**Sensitivity in Air**

<b>Channel X:</b>	1.2 $\mu\text{V}/(\text{V}/\text{m})^2$
<b>Channel Y:</b>	1.2 $\mu\text{V}/(\text{V}/\text{m})^2$
<b>Channel Z:</b>	1.2 $\mu\text{V}/(\text{V}/\text{m})^2$
<b>Diode Compression Point:</b>	95 mV

---

Page 3 of 10

This page has been reviewed for content and attested to on Page 2 of this document.

**NCL Calibration Laboratories**

Division of APREL Laboratories.

**Sensitivity in Head Tissue Measured****Frequency:** 835 MHz**Epsilon:** 41.04 (+/-5%)**Sigma:** 0.89 S/m (+/-5%)**ConvF****Channel X:** 6.5**Channel Y:** 6.5**Channel Z:** 6.5

Tissue sensitivity values were calculated using the load impedance of the APREL Laboratories Daq-Paq.

**Boundary Effect:**

Uncertainty resulting from the boundary effect is less than 2% for the distance between the tip of the probe and the tissue boundary, when less than 2.44mm.

**Spatial Resolution:**

The measured probe tip diameter is 5 mm (+/- 0.01 mm) and therefore meets the requirements of SSI/DRB-TP-D01-032 for spatial resolution.

---

Page 4 of 10

This page has been reviewed for content and attested to on Page 2 of this document.



**NCL Calibration Laboratories**

Division of APREL Laboratories.

**Receiving Pattern 835 MHz (Air)**

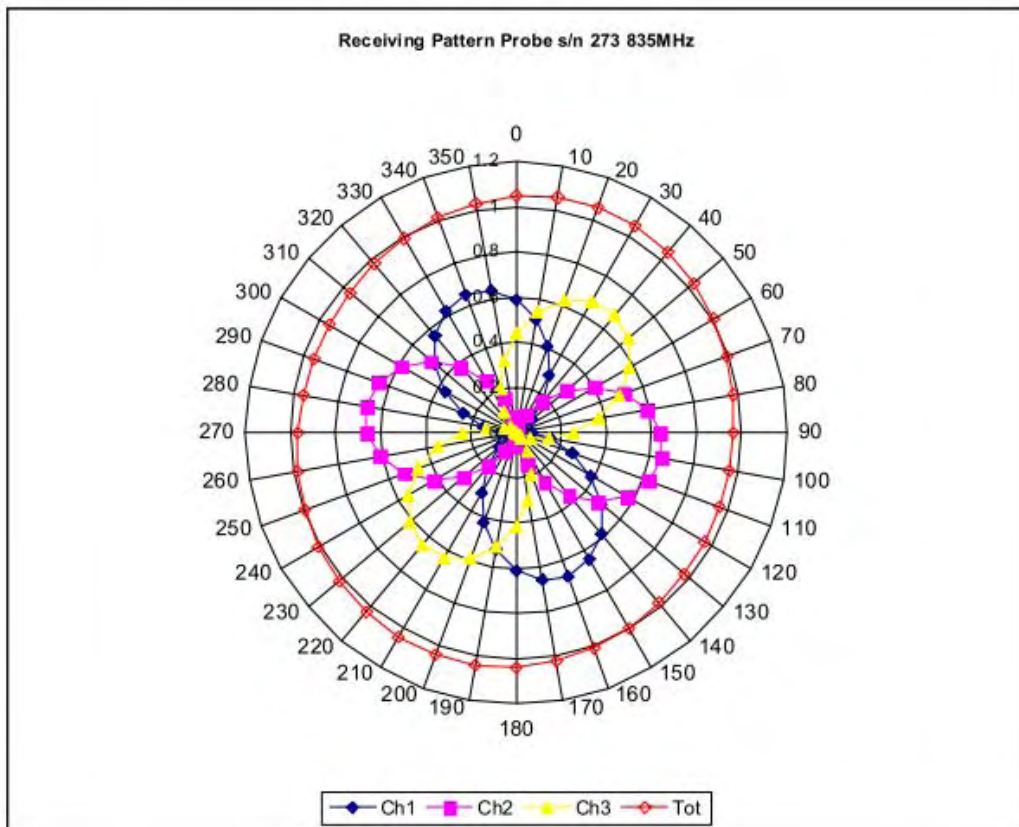

Page 5 of 10

This page has been reviewed for content and attested to on Page 2 of this document.

**NCL Calibration Laboratories**

Division of APREL Laboratories.

**Isotropy Error 835 MHz (Air)**

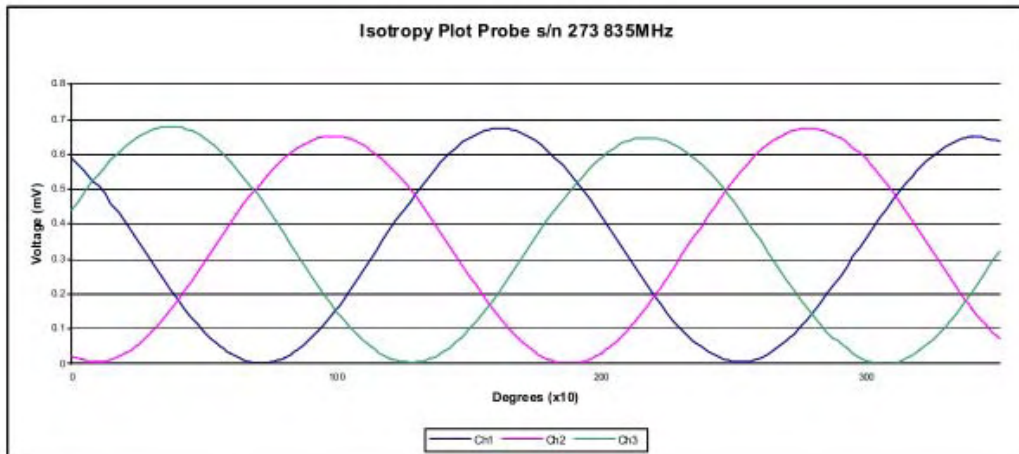
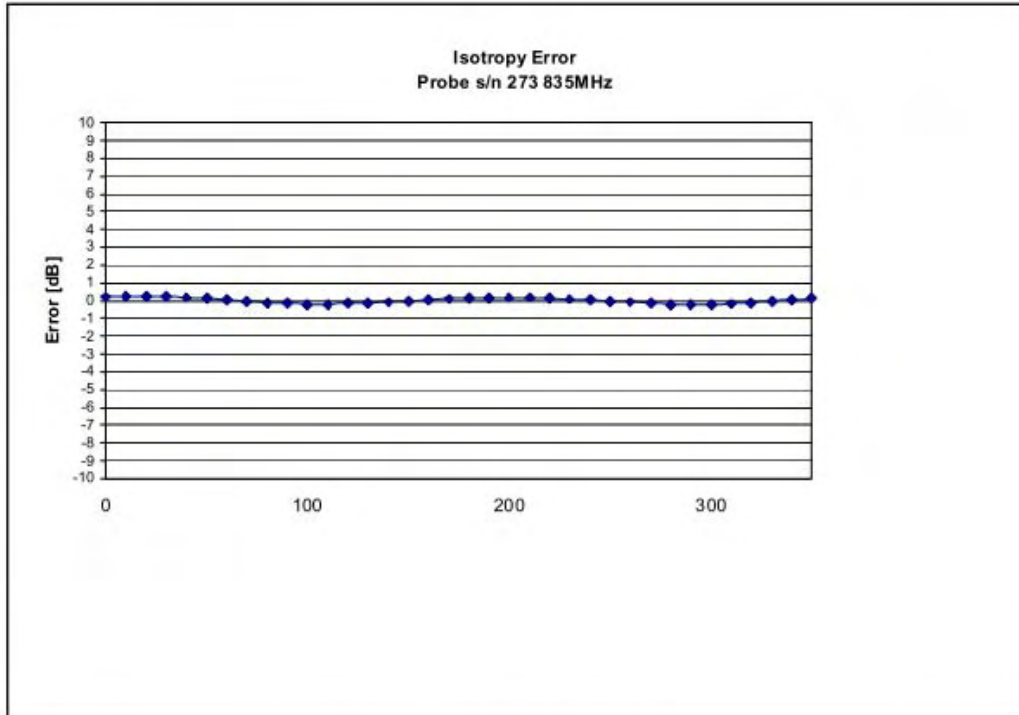

**Isotropicity Tissue:** 0.10 dB

**NCL Calibration Laboratories**

Division of APREL Laboratories.

**Dynamic Range**

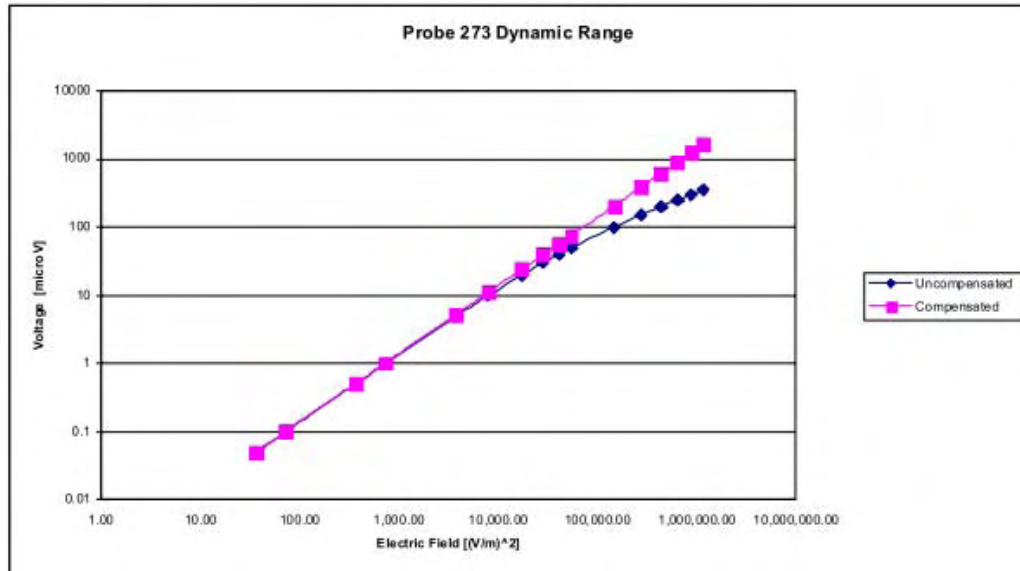

**NCL Calibration Laboratories**

Division of APREL Laboratories.

**Video Bandwidth**

**Probe Frequency Characteristics**

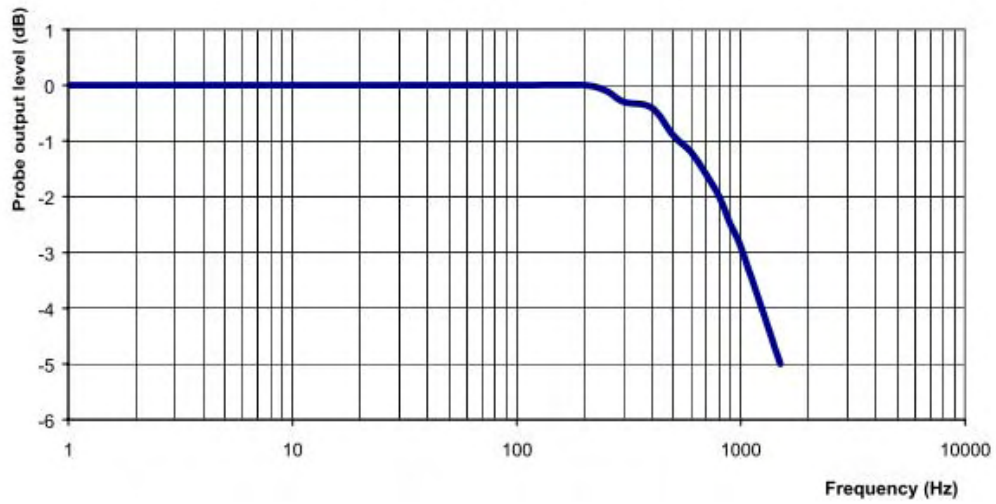

**Video Bandwidth at 500 Hz**                    1 dB  
**Video Bandwidth at 1.02 KHz:**            3 dB

**NCL Calibration Laboratories**

Division of APREL Laboratories.

**Conversion Factor Uncertainty Assessment**

**Frequency:** 835MHz  
**Epsilon:** 41.04 (+/-5%)      **Sigma:** 0.89 S/m (+/-5%)

**ConvF**

**Channel X:** 6.5      7%(K=2)

**Channel Y:** 6.5      7%(K=2)

**Channel Z:** 6.5      7%(K=2)

To minimize the uncertainty calculation all tissue sensitivity values were calculated using a load impedance of 5 MΩ.

**Boundary Effect:**

For a distance of 2.5mm the evaluated uncertainty (increase in the probe sensitivity) is less than 2%.

---

Page 9 of 10

This page has been reviewed for content and attested to on Page 2 of this document.

**NCL Calibration Laboratories**

---

Division of APREL Laboratories.

**Test Equipment**

The test equipment used during Probe Calibration, manufacturer, model number and, current calibration status are listed and located on the main APREL server R:\NCL\Calibration Equipment\Instrument List May 2010.

---

Page 10 of 10

This page has been reviewed for content and attested to on Page 2 of this document.

**NCL CALIBRATION LABORATORIES**

Calibration File No.: CP-1140

Client.: BACL

**CERTIFICATE OF CALIBRATION**

It is certified that the equipment identified below has been calibrated in the **NCL CALIBRATION LABORATORIES** by qualified personnel following recognized procedures and using transfer standards traceable to NRC/NIST.

Equipment: Miniature Isotropic RF Probe 835 MHz

Manufacturer: APREL Laboratories

Model No.: E-020

Serial No.: 273

Calibration in Body Tissue

Calibration Procedure: SSI/DRB-TP-D01-032-E020-V2

Project No: BACB-E020-5537

Calibrated: 20<sup>th</sup> August 2010

Released on: 24<sup>th</sup> August 2010

This Calibration Certificate is incomplete unless accompanied with the Calibration Results Summary

Released By: \_\_\_\_\_

**NCL CALIBRATION LABORATORIES**

51 SPECTRUM WAY  
NEPEAN, ONTARIO  
CANADA K2R 1E6

Division of APREL Lab.  
TEL: (613) 820-4988  
FAX: (613) 820-4161

**NCL Calibration Laboratories**

Division of APREL Laboratories.

**Introduction**

This Calibration Report reproduces the results of the calibration performed in line with the SSI/DRB-TP-D01-032-E020-V2 E-Field Probe Calibration Procedure. The results contained within this report are for APREL E-Field Probe E-020 273.

**References**

SSI/DRB-TP-D01-032-E020-V2 E-Field Probe Calibration Procedure  
IEEE 1528 "Recommended Practice for Determining the Peak Spatial-Average Specific Absorption Rate (SAR) in the Human Body Due to Wireless Communications Devices: Experimental Techniques"  
SSI-TP-011 Tissue Calibration Procedure

**Conditions**

Probe 273 was a re- calibration.

**Ambient Temperature of the Laboratory:** 22 °C +/- 0.5°C  
**Temperature of the Tissue:** 21 °C +/- 0.5°C

We the undersigned attest that to the best of our knowledge the calibration of this probe has been accurately conducted and that all information contained within this report has been reviewed for accuracy.

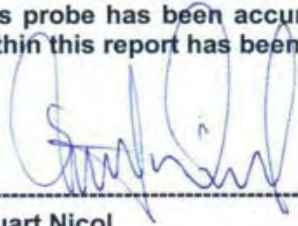

---

Stuart Nicol



---

Jesse Hones

---

Page 2 of 10

This page has been reviewed for content and attested to on Page 2 of this document.



**NCL Calibration Laboratories**

Division of APREL Laboratories.

**Calibration Results Summary**

<b>Probe Type:</b>	E-Field Probe E-020
<b>Serial Number:</b>	273
<b>Frequency:</b>	835 MHz
<b>Sensor Offset:</b>	1.56 mm
<b>Sensor Length:</b>	2.5 mm
<b>Tip Enclosure:</b>	Ertalyte*
<b>Tip Diameter:</b>	<5 mm
<b>Tip Length:</b>	60 mm
<b>Total Length:</b>	290 mm

\*Resistive to recommended tissue recipes per IEEE-1528

**Sensitivity in Air**

<b>Channel X:</b>	1.2 $\mu\text{V}/(\text{V}/\text{m})^2$
<b>Channel Y:</b>	1.2 $\mu\text{V}/(\text{V}/\text{m})^2$
<b>Channel Z:</b>	1.2 $\mu\text{V}/(\text{V}/\text{m})^2$
<b>Diode Compression Point:</b>	95 mV

---

Page 3 of 10

This page has been reviewed for content and attested to on Page 2 of this document.

**NCL Calibration Laboratories**

Division of APREL Laboratories.

**Sensitivity in Body Tissue Measured****Frequency:** 835 MHz**Epsilon:** 55.91 (+/-5%)      **Sigma:** 0.98 S/m (+/-5%)**ConvF****Channel X:** 6.7**Channel Y:** 6.7**Channel Z:** 6.7

Tissue sensitivity values were calculated using the load impedance of the APREL Laboratories Daq-Paq.

**Boundary Effect:**

Uncertainty resulting from the boundary effect is less than 2% for the distance between the tip of the probe and the tissue boundary, when less than 2.44mm.

**Spatial Resolution:**

The measured probe tip diameter is 5 mm (+/- 0.01 mm) and therefore meets the requirements of SSI/DRB-TP-D01-032 for spatial resolution.

---

Page 4 of 10

This page has been reviewed for content and attested to on Page 2 of this document.

**NCL Calibration Laboratories**

Division of APREL Laboratories.

**Receiving Pattern 835 MHz (Air)**

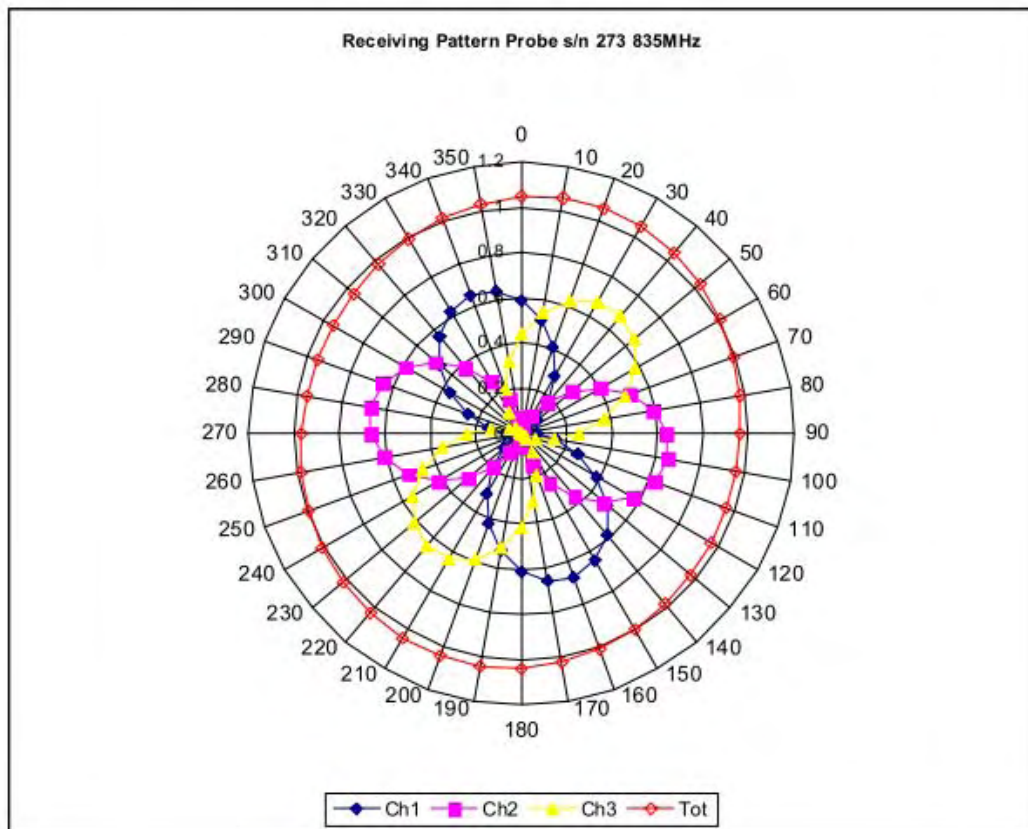

**NCL Calibration Laboratories**

Division of APREL Laboratories.

**Isotropy Error 835 MHz (Air)**

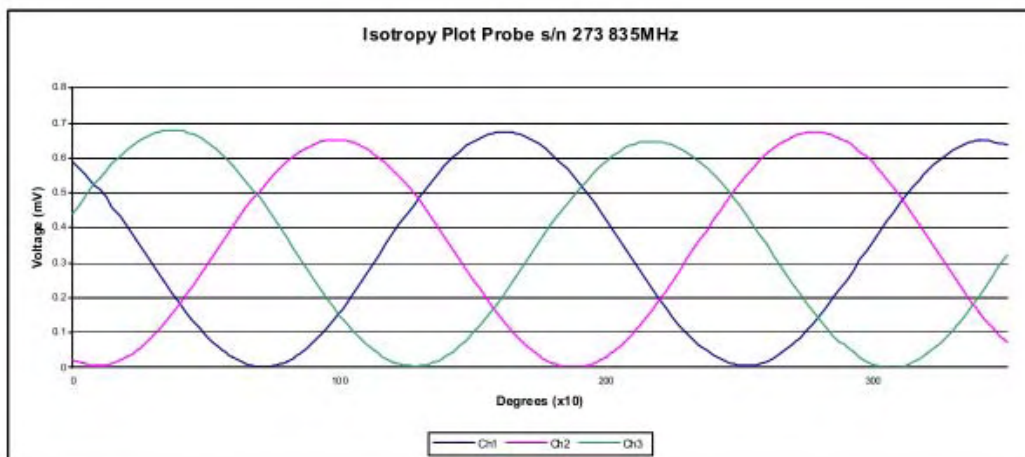
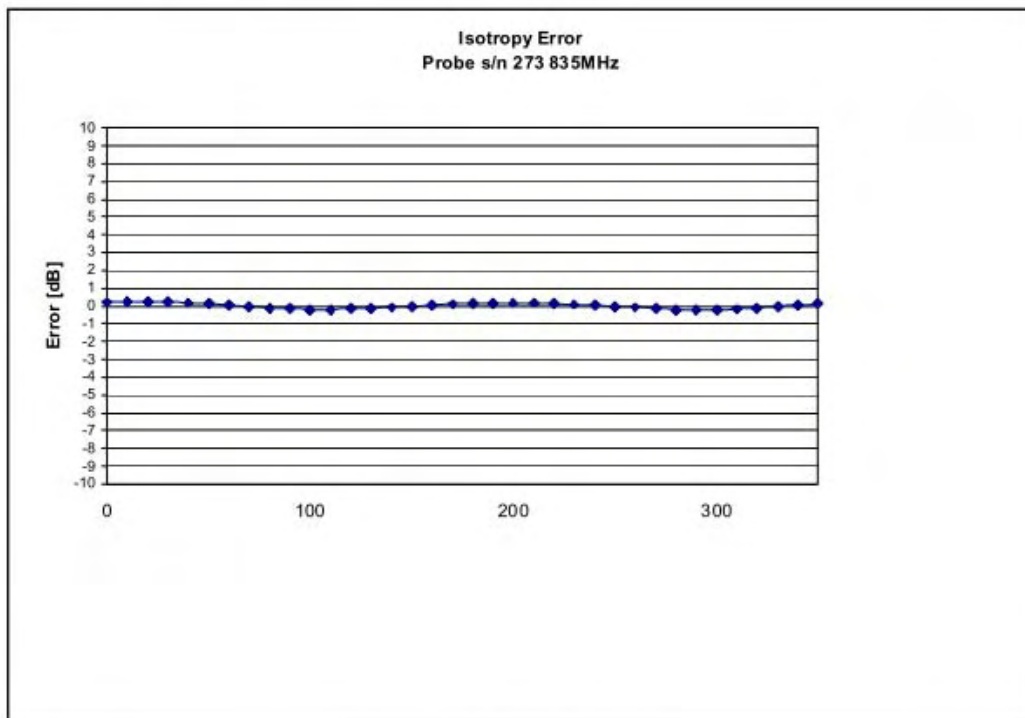

**Isotropicity in Tissue: 0.10 dB**

**NCL Calibration Laboratories**

Division of APREL Laboratories.

**Dynamic Range**

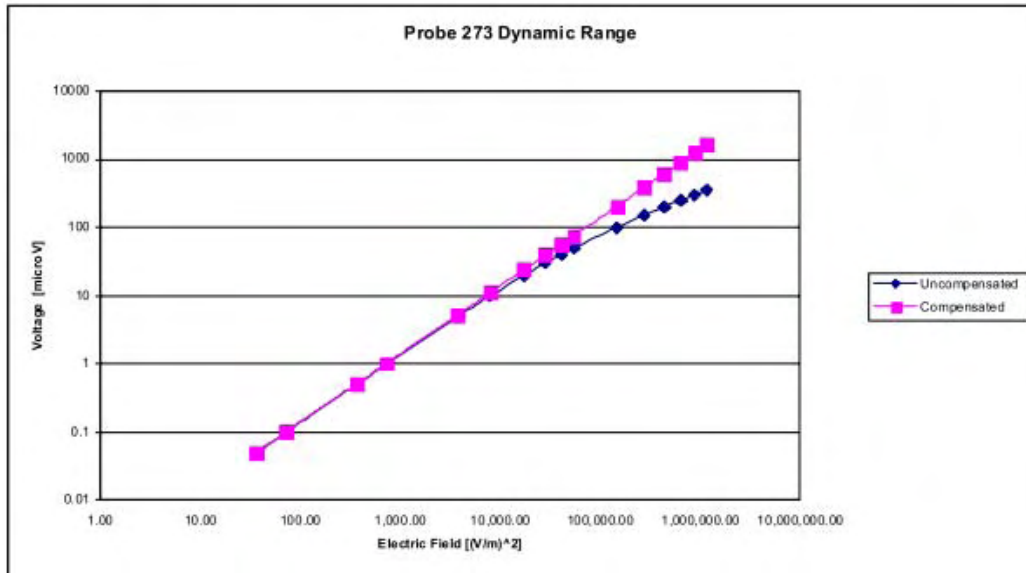

**NCL Calibration Laboratories**

Division of APREL Laboratories.

**Video Bandwidth**

**Probe Frequency Characteristics**

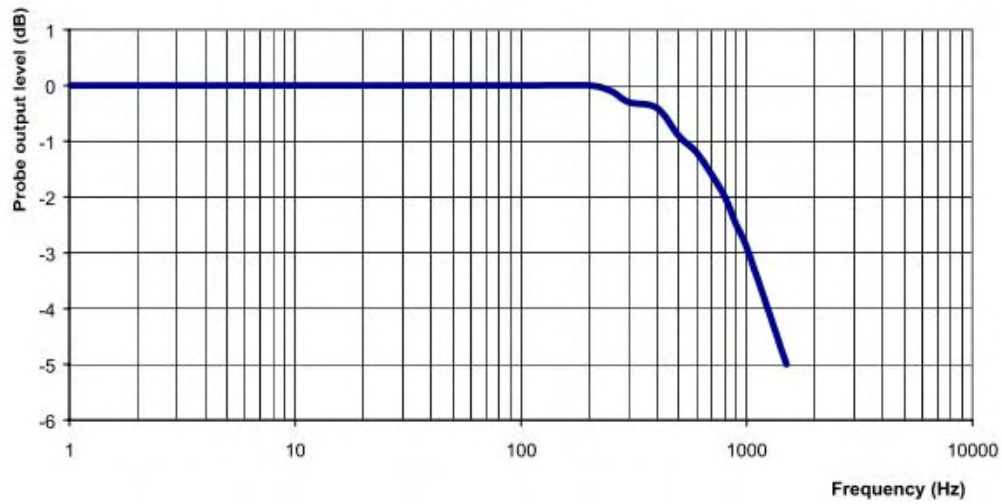

**Video Bandwidth at 500 Hz**            1 dB  
**Video Bandwidth at 1.02 KHz:**        3 dB

**NCL Calibration Laboratories**

Division of APREL Laboratories.

**Conversion Factor Uncertainty Assessment**

**Frequency:** 835MHz  
**Epsilon:** 55.91 (+/-5%)      **Sigma:** 0.98 S/m (+/-5%)

**ConvF****Channel X:** 6.7      7%(K=2)**Channel Y:** 6.7      7%(K=2)**Channel Z:** 6.7      7%(K=2)

To minimize the uncertainty calculation all tissue sensitivity values were calculated using a load impedance of 5 MΩ.

**Boundary Effect:**

For a distance of 2.4mm the evaluated uncertainty (increase in the probe sensitivity) is less than 2%.

---

Page 9 of 10

This page has been reviewed for content and attested to on Page 2 of this document.

**NCL Calibration Laboratories**

---

Division of APREL Laboratories.

**Test Equipment**

The test equipment used during Probe Calibration, manufacturer, model number and, current calibration status are listed and located on the main APREL server R:\NCL\Calibration Equipment\Instrument List May 2010.

---

Page 10 of 10

This page has been reviewed for content and attested to on Page 2 of this document.



## NCL CALIBRATION LABORATORIES

Calibration File No.: CP-1141

Client.: BACL

# CERTIFICATE OF CALIBRATION

It is certified that the equipment identified below has been calibrated in the **NCL CALIBRATION LABORATORIES** by qualified personnel following recognized procedures and using transfer standards traceable to NRC/NIST.

Equipment: Miniature Isotropic RF Probe 1900 MHz

Manufacturer: APREL Laboratories

Model No.: E-020

Serial No.: 273

Calibration in Head Tissue

Calibration Procedure: SSI/DRB-TP-D01-032-E020-V2

Project No: BACB-E020-5537

Calibrated: 21<sup>st</sup> August 2010  
Released on: 24<sup>th</sup> August 2010

This Calibration Certificate is Incomplete Unless Accompanied with the Calibration Results Summary

Released By: \_\_\_\_\_

### **NCL** CALIBRATION LABORATORIES

51 SPECTRUM WAY  
NEPEAN, ONTARIO  
CANADA K2R 1E6

Division of APREL Lab.  
TEL: (613) 820-4988  
FAX: (613) 820-4161

**NCL Calibration Laboratories**

Division of APREL Laboratories.

**Introduction**

This Calibration Report reproduces the results of the calibration performed in line with the SSI/DRB-TP-D01-032-E020-V2 E-Field Probe Calibration Procedure. The results contained within this report are for APREL E-Field Probe E-020 273.

**References**

SSI/DRB-TP-D01-032-E020-V2 E-Field Probe Calibration Procedure  
IEEE 1528 "Recommended Practice for Determining the Peak Spatial-Average Specific Absorption Rate (SAR) in the Human Body Due to Wireless Communications Devices: Experimental Techniques"  
SSI-TP-011 Tissue Calibration Procedure

**Conditions**

Probe 273 was a re-calibration.

**Ambient Temperature of the Laboratory:** 22 °C +/- 0.5°C  
**Temperature of the Tissue:** 21 °C +/- 0.5°C

**We the undersigned attest that to the best of our knowledge the calibration of this probe has been accurately conducted and that all information contained within this report has been reviewed for accuracy.**

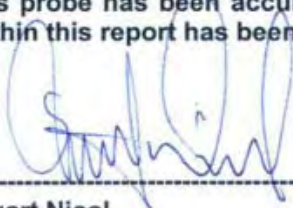

-----  
**Stuart Nicol**

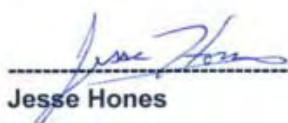

-----  
**Jesse Hones**

Page 2 of 10

This page has been reviewed for content and attested to on Page 2 of this document.

**NCL Calibration Laboratories**

Division of APREL Laboratories.

**Calibration Results Summary**

<b>Probe Type:</b>	E-Field Probe E-020
<b>Serial Number:</b>	273
<b>Frequency:</b>	1900 MHz
<b>Sensor Offset:</b>	1.56 mm
<b>Sensor Length:</b>	2.5 mm
<b>Tip Enclosure:</b>	Ertalyte*
<b>Tip Diameter:</b>	<5 mm
<b>Tip Length:</b>	60 mm
<b>Total Length:</b>	290 mm

\*Resistive to recommended tissue recipes per IEEE-1528

**Sensitivity in Air**

<b>Channel X:</b>	1.2 $\mu\text{V}/(\text{V}/\text{m})^2$
<b>Channel Y:</b>	1.2 $\mu\text{V}/(\text{V}/\text{m})^2$
<b>Channel Z:</b>	1.2 $\mu\text{V}/(\text{V}/\text{m})^2$
<b>Diode Compression Point:</b>	95 mV

---

Page 3 of 10

This page has been reviewed for content and attested to on Page 2 of this document.

**NCL Calibration Laboratories**

Division of APREL Laboratories.

**Sensitivity in Head Tissue Measured****Frequency:** 1900 MHz**Epsilon:** 38.90 (+/-5%)**Sigma:** 1.39 S/m (+/-5%)**ConvF****Channel X:** 5.25**Channel Y:** 5.25**Channel Z:** 5.25

Tissue sensitivity values were calculated using the load impedance of the APREL Laboratories Daq-Paq.

**Boundary Effect:**

Uncertainty resulting from the boundary effect is less than 2% for the distance between the tip of the probe and the tissue boundary, when less than 2.44mm.

**Spatial Resolution:**

The measured probe tip diameter is 5 mm (+/- 0.01 mm) and therefore meets the requirements of SSI/DRB-TP-D01-032 for spatial resolution.

---

Page 4 of 10

This page has been reviewed for content and attested to on Page 2 of this document.

**NCL Calibration Laboratories**

Division of APREL Laboratories.

**Receiving Pattern 1900 MHz (Air)**

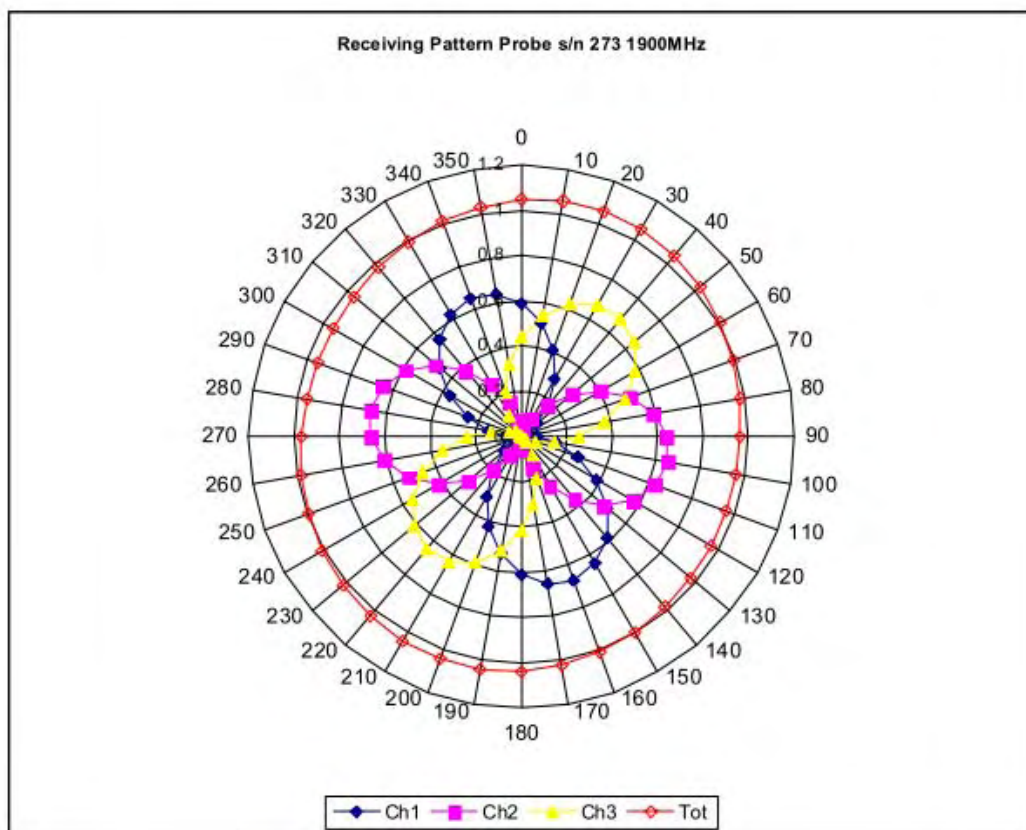

Page 5 of 10

This page has been reviewed for content and attested to on Page 2 of this document.

**NCL Calibration Laboratories**

Division of APREL Laboratories.

**Isotropy Error 1900 MHz (Air)**

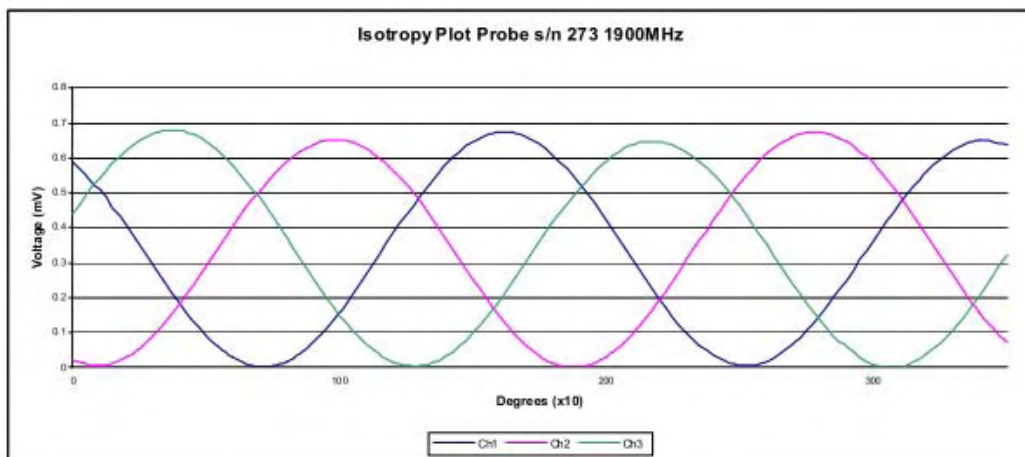
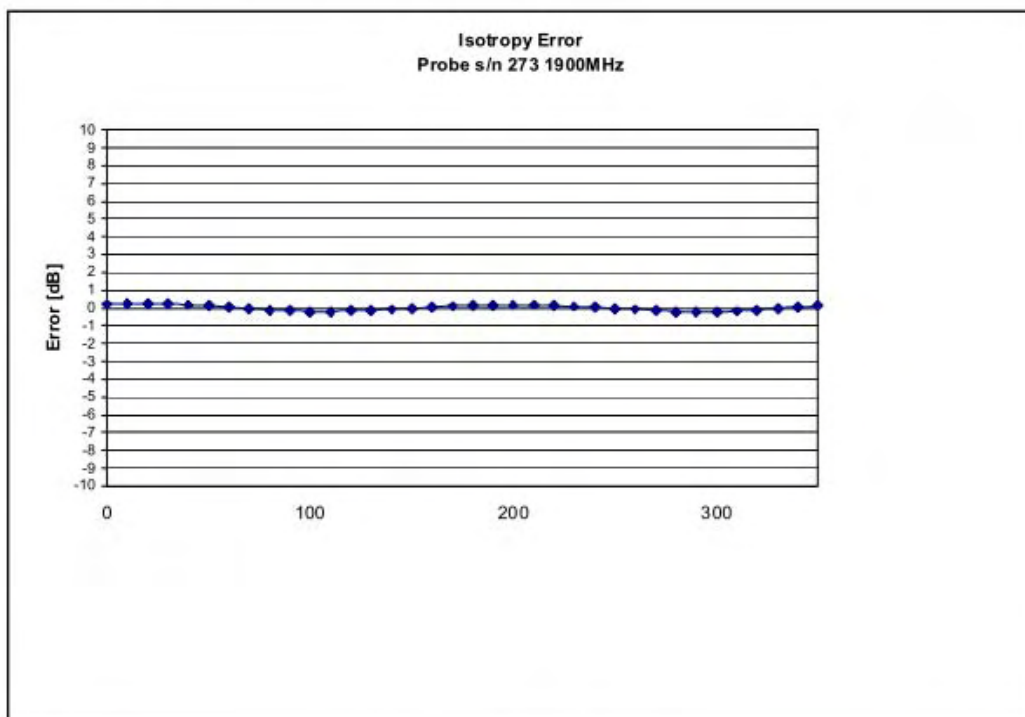

**Isotropicity in Tissue:**

**0.10 dB**

Page 6 of 10

This page has been reviewed for content and attested to on Page 2 of this document.

**NCL Calibration Laboratories**

Division of APREL Laboratories.

**Dynamic Range**

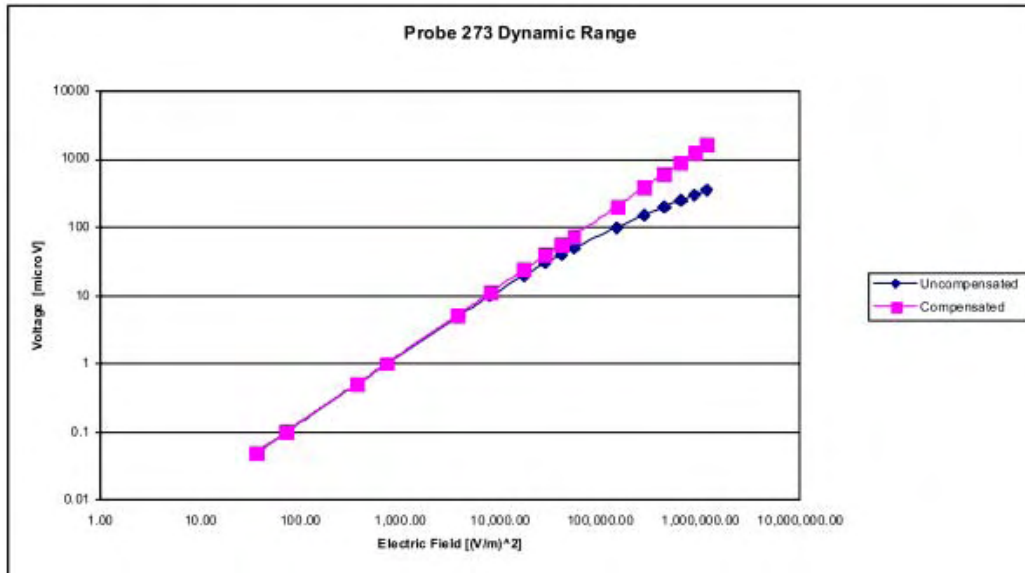

Page 7 of 10

This page has been reviewed for content and attested to on Page 2 of this document.

**NCL Calibration Laboratories**

Division of APREL Laboratories.

**Video Bandwidth**

**Probe Frequency Characteristics**

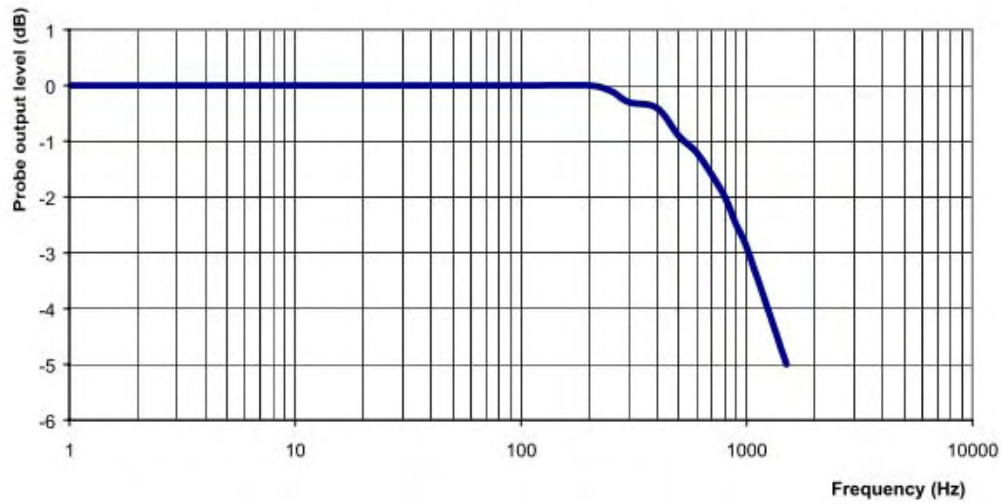

**Video Bandwidth at 500 Hz**                      1 dB  
**Video Bandwidth at 1.02 KHz:**                3 dB



**NCL Calibration Laboratories**

Division of APREL Laboratories.

**Conversion Factor Uncertainty Assessment****Frequency:** 1900MHz**Epsilon:** 38.90 (+/-5%)**Sigma:** 1.39 S/m (+/-5%)**ConvF****Channel X:** 5.25 7%(K=2)**Channel Y:** 5.25 7%(K=2)**Channel Z:** 5.25 7%(K=2)

To minimize the uncertainty calculation all tissue sensitivity values were calculated using a load impedance of 5 M $\Omega$ .

**Boundary Effect:**

For a distance of 2.4mm the evaluated uncertainty (increase in the probe sensitivity) is less than 2%.

---

Page 9 of 10

This page has been reviewed for content and attested to on Page 2 of this document.

**NCL Calibration Laboratories**

---

Division of APREL Laboratories.

**Test Equipment**

The test equipment used during Probe Calibration, manufacturer, model number and, current calibration status are listed and located on the main APREL server R:\NCL\Calibration Equipment\Instrument List May 2010.

---

Page 10 of 10

This page has been reviewed for content and attested to on Page 2 of this document.

**NCL CALIBRATION LABORATORIES**

Calibration File No.: CP-1142

Client.: BACL

**CERTIFICATE OF CALIBRATION**

It is certified that the equipment identified below has been calibrated in the **NCL CALIBRATION LABORATORIES** by qualified personnel following recognized procedures and using transfer standards traceable to NRC/NIST.

Equipment: Miniature Isotropic RF Probe 1900 MHz

Manufacturer: APREL Laboratories

Model No.: E-020

Serial No.: 273

Calibration in Body Tissue

Calibration Procedure: SSI/DRB-TP-D01-032-E020-V2

Project No: BACB-E020-5537

Calibrated: 21<sup>st</sup> August 2010  
Released on: 24<sup>th</sup> August 2010

This Calibration Certificate is Incomplete Unless Accompanied with the Calibration Results Summary

Released By: \_\_\_\_\_



**NCL CALIBRATION LABORATORIES**

51 SPECTRUM WAY  
NEPEAN, ONTARIO  
CANADA K2R 1E6

Division of APREL Lab.  
TEL: (613) 820-4988  
FAX: (613) 820-4161

**NCL Calibration Laboratories**

Division of APREL Laboratories.

**Introduction**

This Calibration Report reproduces the results of the calibration performed in line with the SSI/DRB-TP-D01-032-E020-V2 E-Field Probe Calibration Procedure. The results contained within this report are for APREL E-Field Probe E-020 273.

**References**

SSI/DRB-TP-D01-032-E020-V2 E-Field Probe Calibration Procedure  
IEEE 1528 "Recommended Practice for Determining the Peak Spatial-Average Specific Absorption Rate (SAR) in the Human Body Due to Wireless Communications Devices: Experimental Techniques"  
SSI-TP-011 Tissue Calibration Procedure

**Conditions**

Probe 273 was a re-calibration.

**Ambient Temperature of the Laboratory:** 22 °C +/- 0.5°C

**Temperature of the Tissue:** 21 °C +/- 0.5°C

**We the undersigned attest that to the best of our knowledge the calibration of this probe has been accurately conducted and that all information contained within this report has been reviewed for accuracy.**

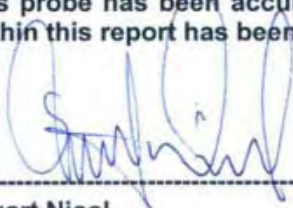

-----  
**Stuart Nicol**

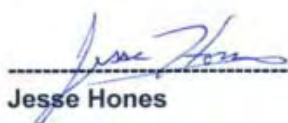

-----  
**Jesse Hones**

Page 2 of 10

This page has been reviewed for content and attested to on Page 2 of this document.

**NCL Calibration Laboratories**

Division of APREL Laboratories.

**Calibration Results Summary**

<b>Probe Type:</b>	E-Field Probe E-020
<b>Serial Number:</b>	273
<b>Frequency:</b>	1900 MHz
<b>Sensor Offset:</b>	1.56 mm
<b>Sensor Length:</b>	2.5 mm
<b>Tip Enclosure:</b>	Ertalyte*
<b>Tip Diameter:</b>	<5 mm
<b>Tip Length:</b>	60 mm
<b>Total Length:</b>	290 mm

\*Resistive to recommended tissue recipes per IEEE-1528

**Sensitivity in Air**

<b>Channel X:</b>	1.2 $\mu\text{V}/(\text{V}/\text{m})^2$
<b>Channel Y:</b>	1.2 $\mu\text{V}/(\text{V}/\text{m})^2$
<b>Channel Z:</b>	1.2 $\mu\text{V}/(\text{V}/\text{m})^2$
<b>Diode Compression Point:</b>	95 mV

---

Page 3 of 10

This page has been reviewed for content and attested to on Page 2 of this document.

**NCL Calibration Laboratories**

Division of APREL Laboratories.

**Sensitivity in Body Tissue Measured****Frequency:** 1900 MHz**Epsilon:** 53.11 (+/-5%)      **Sigma:** 1.56 S/m (+/-5%)**ConvF****Channel X:** 5.15**Channel Y:** 5.15**Channel Z:** 5.15

Tissue sensitivity values were calculated using the load impedance of the APREL Laboratories Daq-Paq.

**Boundary Effect:**

Uncertainty resulting from the boundary effect is less than 2% for the distance between the tip of the probe and the tissue boundary, when less than 2.44mm.

**Spatial Resolution:**

The measured probe tip diameter is 5 mm (+/- 0.01 mm) and therefore meets the requirements of SSI/DRB-TP-D01-032 for spatial resolution.

---

Page 4 of 10

This page has been reviewed for content and attested to on Page 2 of this document.

**NCL Calibration Laboratories**

Division of APREL Laboratories.

**Receiving Pattern 1900 MHz (Air)**

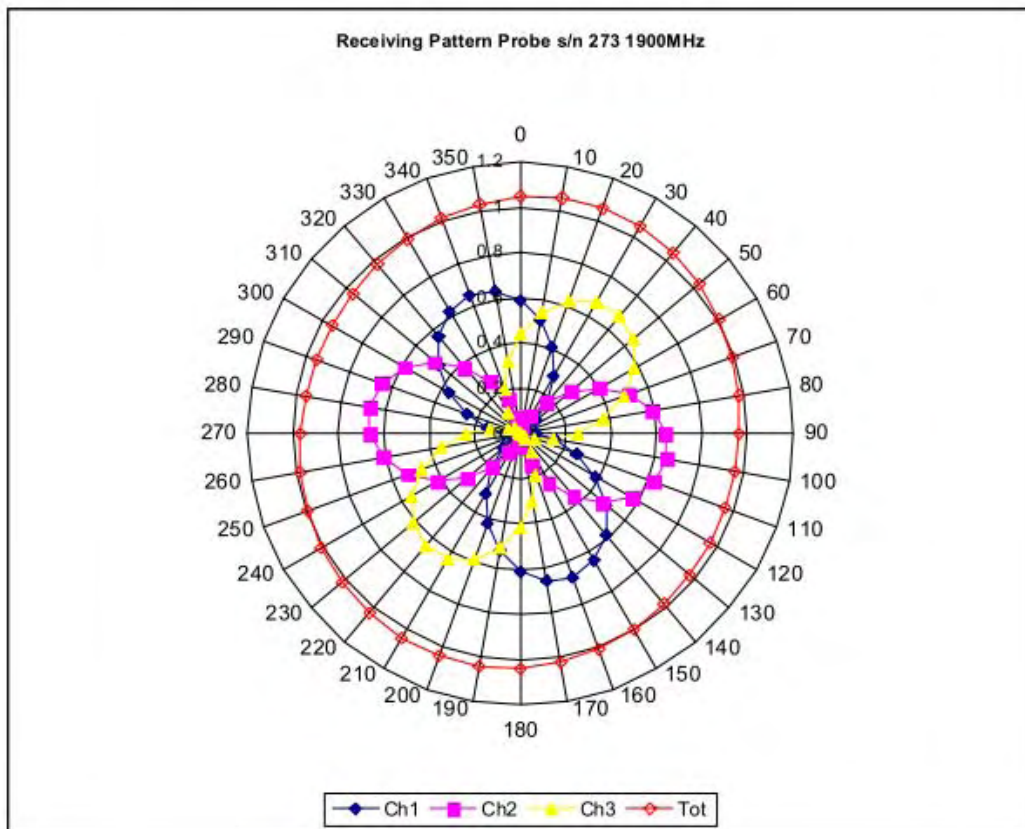

Page 5 of 10

This page has been reviewed for content and attested to on Page 2 of this document.

**NCL Calibration Laboratories**

Division of APREL Laboratories.

**Isotropy Error 1900 MHz (Air)**

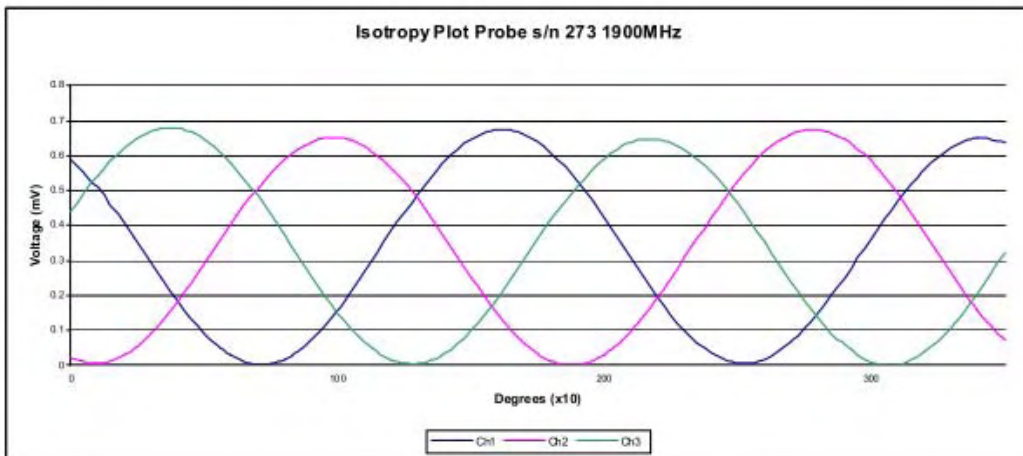
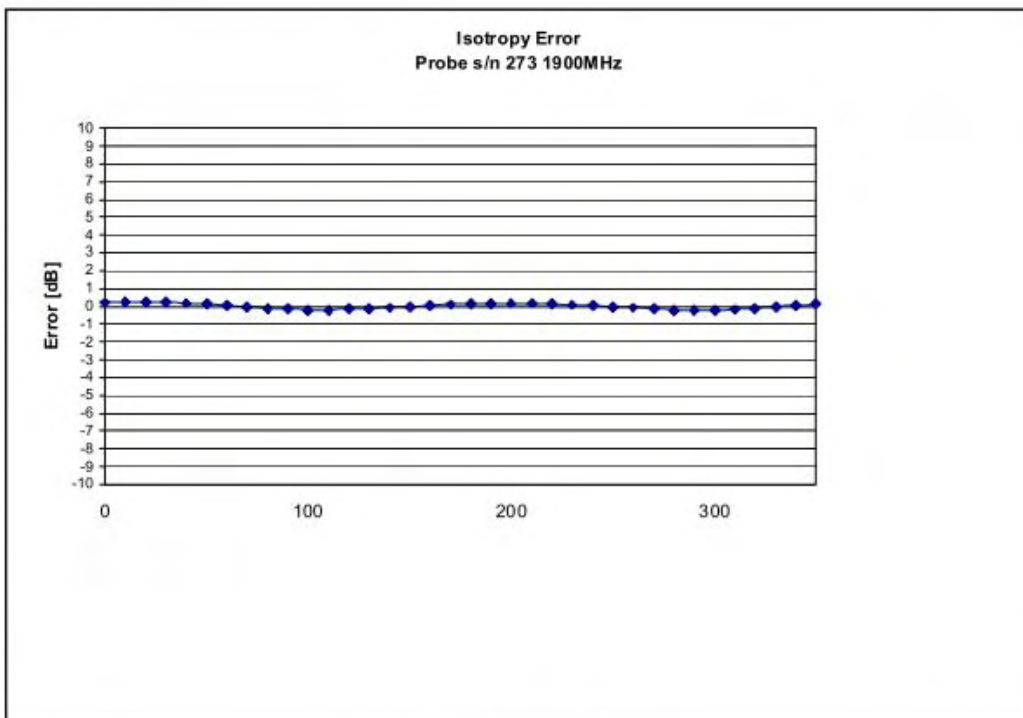

**Isotropicity in Tissue:**

**0.10 dB**



**NCL Calibration Laboratories**

Division of APREL Laboratories.

**Dynamic Range**

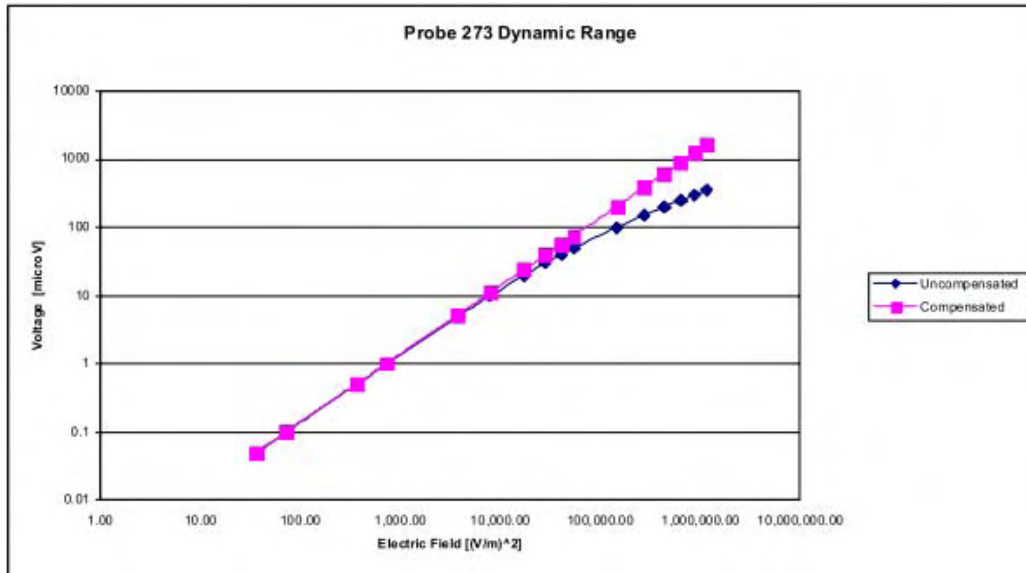

Page 7 of 10

This page has been reviewed for content and attested to on Page 2 of this document.

**NCL Calibration Laboratories**

Division of APREL Laboratories.

**Video Bandwidth**

**Probe Frequency Characteristics**

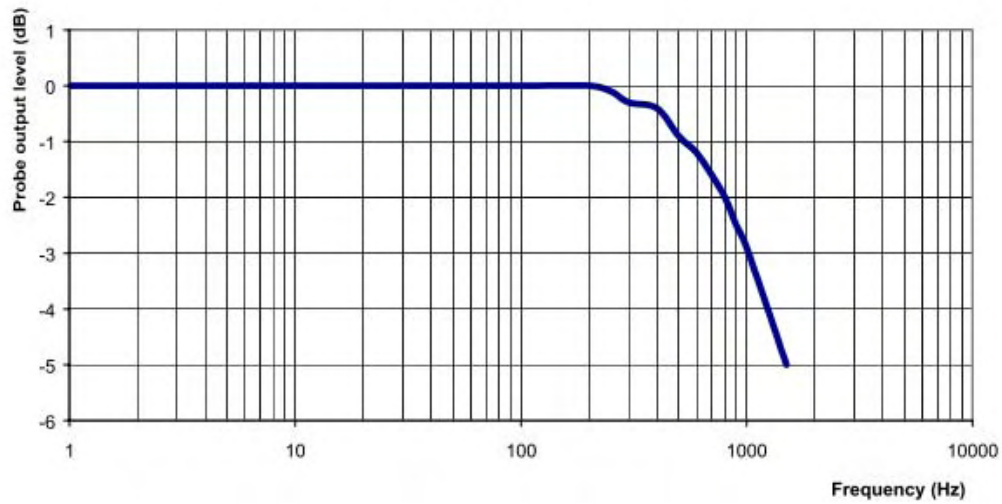

**Video Bandwidth at 500 Hz**                      1 dB  
**Video Bandwidth at 1.02 KHz:**                3 dB

**NCL Calibration Laboratories**

Division of APREL Laboratories.

**Conversion Factor Uncertainty Assessment**

**Frequency:** 1900MHz  
**Epsilon:** 53.11 (+/-5%)      **Sigma:** 1.56 S/m (+/-5%)

**ConvF**

**Channel X:** 5.15      7%(K=2)

**Channel Y:** 5.15      7%(K=2)

**Channel Z:** 5.15      7%(K=2)

To minimize the uncertainty calculation all tissue sensitivity values were calculated using a load impedance of 5 MΩ.

**Boundary Effect:**

For a distance of 2.4mm the evaluated uncertainty (increase in the probe sensitivity) is less than 2%.

---

Page 9 of 10

This page has been reviewed for content and attested to on Page 2 of this document.

**NCL Calibration Laboratories**

---

Division of APREL Laboratories.

**Test Equipment**

The test equipment used during Probe Calibration, manufacturer, model number and, current calibration status are listed and located on the main APREL server R:\NCL\Calibration Equipment\Instrument List May 2010.

---

Page 10 of 10

This page has been reviewed for content and attested to on Page 2 of this document.

# APPENDIX C – DIPOLE CALIBRATION CERTIFICATES



Bay Area Compliance Laboratories Corp.  
 1274 Anvilwood Ave, Sunnyvale, CA 94089  
 Tel: (408)732-9162 / Fax: (408)732-9164

## Verification of Calibration Report

**Report Number:** CAL 2010-09-20  
**Description:** Dipole Antenna  
**Manufacturer:** APREL Laboratories  
**Model Number:** ALS-D-835-S-2  
**Serial Number:** SN: 180-00558  
**Date of Calibration:** 20 Sept 2010  
**Condition Received:** In Tolerance  
**Condition Returned:** In Tolerance

**Conditions and results of calibration:** See attachment

This device has been instrumented, measured and calibrated in accordance with the Bay Area Compliance Laboratories Corp. ("BACL") Quality Assurance Manual procedures and the results being traceable to the National Institute of Standards and Technology (NIST). The BACL Quality System is accredited by NVLAP to ISO/IEC 17025:2005. Unless stated otherwise; Measurement Uncertainties are derived from ISO Guide to the Determination of Uncertainties with a Coverage Factor of  $k = 2$  for a 95% level of confidence, no sampling plan or other process was used for this calibration (unless stated otherwise), the results reported herein apply only to the calibration of the item described above, and limitations of use (if any) shall be stated this Calibration Report.

<b>Calibrated By:</b>	 _____ Quinn Jiang	9/20/2010 _____ Date
<b>Reviewed By:</b>	 _____ Victor Zhang	9/21/2010 _____ Date
<b>Quality Assurance:</b>	 _____ Hans Mellberg	21 SEP 2010 _____ Date

## Attachment

### Ambient Environment of Calibration

Temperature	Relative Humidity	Pressure
22 ° C	56.5 %	102.78 k Pa

### Equipment List

Description	Manufacturer	Model	Serial #	Cal Date
Signal Generator	HP	8648C	3426A00417	2010-08-30
Network Analyzer	HP	8753D	3410A04346	2010-06-03
Power meter	Agilent	E4419B	MY41291511	2010-09-01
Power Sensor	Agilent	E9301A	MY41497252	2010-02-19
Reference Probe	SPEAG	ET3DV6	1604	2010-09-16

### Measurement Conditions

<b>DASY Version</b>	DASY4	V4.7
<b>Extrapolation</b>	Advanced Extrapolation	
<b>Phantom</b>	Flat Phantom	
<b>Distance Dipole Center-TSL</b>	15 mm	With Spacer
<b>Area Scan resolution</b>	dx,dy = 15 mm	
<b>Zoom Scan resolution</b>	dx,dy,dz = 5 mm	
<b>Frequency</b>	835 MHz ± 1MHz	

### Calibration is performed According to the Following Standards:

1. IEEE Std 1528-2003, "IEEE Recommended Practice for Determining the Peak Spatial-Averaged Specific Absorption Rate (SAR) in the Human Head from Wireless Communications Devices: Measurement Techniques", December 2003
2. IEC 62209-1, "Procedure to measure the Specific Absorption Rate (SAR) for hand-held devise used in close proximity to the ear (frequency range of 300 MHz to 3 GHz)", February 2005
3. DASY 4 System Handbook

**Calibration Data:**

**Head TSL Parameters**

The following parameters and calculations were applied

	Temperature	Permittivity	Conductivity
Nominal Head TSL Parameters	22.0°C	41.5	0.90
Measured Head TSL Parameters	22.0°C	41.5	0.89
Head TSL Temperature during test	23.0°C		

**SAR result with Head TSL**

SAR average over 1 cm <sup>3</sup> (1g) of Head TSL	Condition	
SAR measured	500 mW input power	4.77 mW / g
SAR normalized	Normalized to 1W	9.54 mW / g
SAR for nominal Head TSL parameters <sup>1</sup>	Normalized to 1W	9.5 mW / g ± 10%

SAR average over 10 cm <sup>3</sup> (10g) of Head TSL	Condition	
SAR measured	500 mW input power	3.02 mW / g
SAR normalized	Normalized to 1W	6.04 mW / g
SAR for nominal Head TSL parameters <sup>1</sup>	Normalized to 1W	6.2 mW / g ± 10%

**Antenna Parameters with Head TSL**

Impedance, transformed to feed point	56.174 Ω
Return Loss	-23.458 dB

**DASY4 Validation Report for Head TSL**

**Test Laboratory: Bay Area Compliance Lab Corp.(BACL)**

**System Performance Test (835 MHz Head Tissue)**

**DUT: Dipole 835 MHz; Type: ALS-D835-S-2; Serial: SN: 180-00558**

Communication System: CW; Frequency: 835 MHz; Duty Cycle: 1:1  
 Medium parameters used:  $f = 835 \text{ MHz}$ ;  $\sigma = 0.89 \text{ mho/m}$ ;  $\epsilon_r = 41.5$ ;  $\rho = 1000 \text{ kg/m}^3$   
 Phantom section: Flat Section

DASY4 Configuration:

- Probe: ET3DV6 - SN1604; ConvF(6.26, 6.26, 6.26); Calibrated: 9/16/2010
- Sensor-Surface: 4mm (Mechanical Surface Detection)
- Electronics: DAE3 Sn456; Calibrated: 11/8/2007
- Phantom: SAM with CRP; Type: Twin SAM; Serial: TP-1032
- Measurement SW: DASY4, V4.6 Build 23; Post processing SW: SEMCAD, V1.8 Build 184

**d =15 mm, Pin = 0.5W /Area Scan (81x121x1):** Measurement grid: dx=15mm, dy=15mm  
 Maximum value of SAR (interpolated) = 5.08 mW/g

**d =15 mm, Pin = 0.5W /Zoom Scan (8x8x7)/Cube 0:** Measurement grid: dx=5mm, dy=5mm, dz=5mm  
 Reference Value = 77.8 V/m; Power Drift = -0.113 dB  
 Peak SAR (extrapolated) = 7.35 W/kg

**SAR(1 g) = 4.77 mW/g; SAR(10 g) = 3.02 mW/g**  
 Maximum value of SAR (measured) = 5.16 mW/g

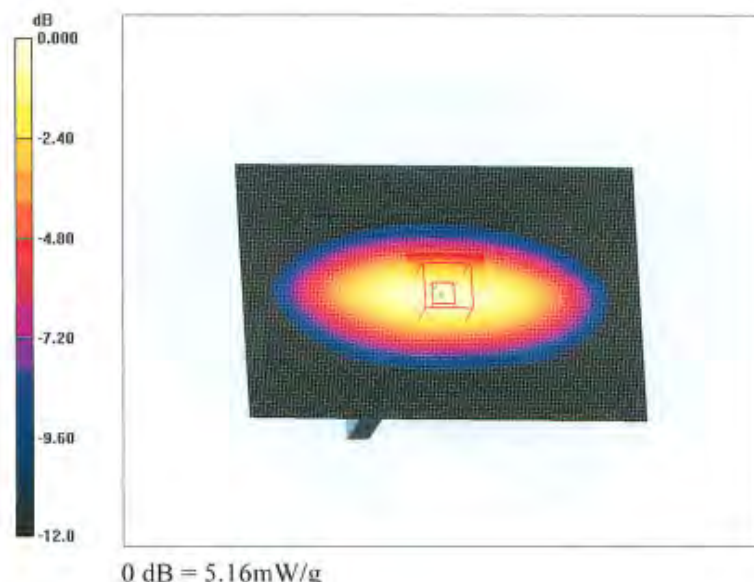



### Impedance Measurement Plot for Head TSL

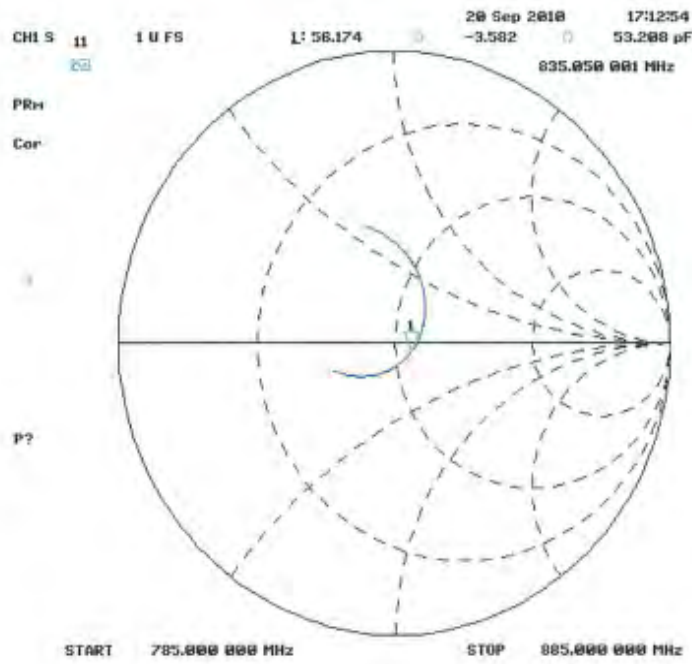

### Return Loss Measurement Plot for Head TSL

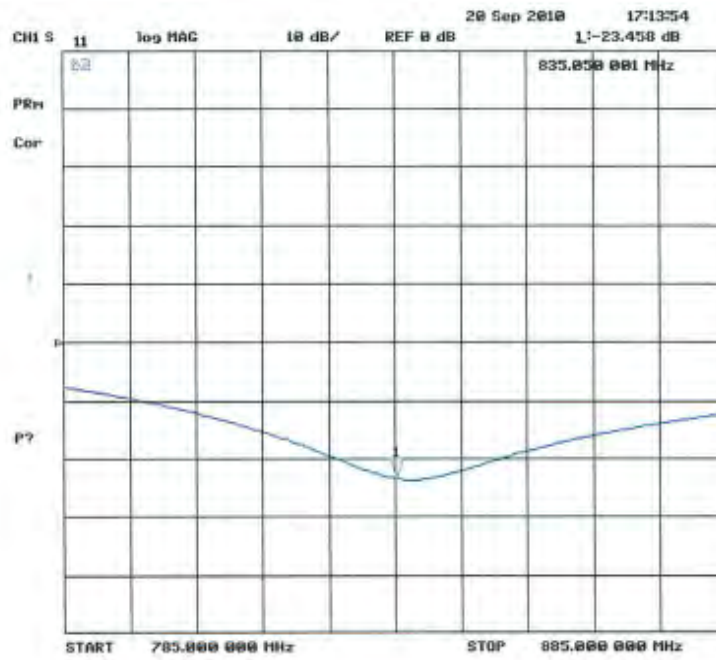



Bay Area Compliance Laboratories Corp.  
 1274 Anvilwood Ave, Sunnyvale, CA 94089  
 Tel: (408)732-9162 / Fax: (408)732-9164

### Verification of Calibration Report

**Report Number:** CAL 2010-09-20  
**Description:** Dipole Antenna  
**Manufacturer:** APREL Laboratories  
**Model Number:** ALS-D-1900-S-2  
**Serial Number:** SN: 210-00710  
**Date of Calibration:** 20 Sept 2010  
**Condition Received:** In Tolerance  
**Condition Returned:** In Tolerance

**Conditions and results of calibration:** See attachment

This device has been instrumented, measured and calibrated in accordance with the Bay Area Compliance Laboratories Corp. ("BACL") Quality Assurance Manual procedures and the results being traceable to the National Institute of Standards and Technology (NIST). The BACL Quality System is accredited by NVLAP to ISO/IEC 17025:2005. Unless stated otherwise; Measurement Uncertainties are derived from ISO Guide to the Determination of Uncertainties with a Coverage Factor of  $k = 2$  for a 95% level of confidence, no sampling plan or other process was used for this calibration (unless stated otherwise), the results reported herein apply only to the calibration of the item described above, and limitations of use (if any) shall be stated this Calibration Report.

**Calibrated By:**  9/20/2010  
 Quinn Jiang Date  
**Reviewed By:**  9/21/2010  
 Victor Zhang Date  
**Quality Assurance:**  21 SEP 2010  
 Hans Mellberg Date

## Attachment

### Ambient Environment of Calibration

Temperature	Relative Humidity	Pressure
22 ° C	53.5 %	104.55 k Pa

### Equipment List

Description	Manufacturer	Model	Serial #	Cal Date
Signal Generator	HP	8648C	3426A00417	2010-08-30
Network Analyzer	HP	8753D	3410A04346	2010-06-03
Power meter	Agilent	E4419B	MY41291511	2010-09-01
Power Sensor	Agilent	E9301A	MY41497252	2010-02-19
Reference Probe	SPEAG	ET3DV6	1604	2010-09-16

### Measurement Conditions

DASY Version	DASY4	V4.7
Extrapolation	Advanced Extrapolation	
Phantom	Flat Phantom	
Distance Dipole Center-TSL	10 mm	With Spacer
Area Scan resolution	dx,dy = 15 mm	
Zoom Scan resolution	dx,dy,dz = 5 mm	
Frequency	1900 MHz ± 1MHz	

### Calibration is performed According to the Following Standards:

1. IEEE Std 1528-2003, "IEEE Recommended Practice for Determining the Peak Spatial-Averaged Specific Absorption Rate (SAR) in the Human Head from Wireless Communications Devices: Measurement Techniques", December 2003
2. IEC 62209-1, "Procedure to measure the Specific Absorption Rate (SAR) for hand-held devise used in close proximity to the ear (frequency range of 300 MHz to 3 GHz)", February 2005
3. DASY 4 System Handbook

**Calibration Data:**

**Head TSL Parameters**

The following parameters and calculations were applied

	Temperature	Permittivity	Conductivity
Nominal Head TSL Parameters	22.0°C	40.0	1.40
Measured Head TSL Parameters	(22.0±0.3)°C	39.9	1.38
Head TSL Temperature during test	(23.0±0.3)°C		

**SAR result with Head TSL**

SAR average over 1 cm <sup>3</sup> (1g) of Head TSL	Condition	
SAR measured	500 mW input power	18.8 mW / g
SAR normalized	Normalized to 1W	37.6 mW / g
SAR for nominal Head TSL parameters <sup>1</sup>	Normalized to 1W	39.7 mW / g ± 10%

SAR average over 10 cm <sup>3</sup> (10g) of Head TSL	Condition	
SAR measured	500 mW input power	9.58 mW / g
SAR normalized	Normalized to 1W	19.16 mW / g
SAR for nominal Head TSL parameters <sup>1</sup>	Normalized to 1W	20.5 mW / g ± 10%

**Antenna Parameters with Head TSL**

Impedance, transformed to feed point	50.727 Ω
Return Loss	-35.881 dB

<sup>1</sup>Correction to nominal TSL parameters according to DASY 4 System Handbook, chapter "SAR Sensitivities"

**DASY4 Validation Report for Head TSL**

**Test Laboratory: Bay Area Compliance Lab Corp.(BACL)**

**System Performance Test (1900 MHz Head Tissue)**

**DUT: Dipole 1900 MHz; Type: ALS-D-1900-S-2; Serial: SN: 210-00710**

Communication System: CW; Frequency: 1900 MHz; Duty Cycle: 1:1  
 Medium parameters used:  $f = 1900 \text{ MHz}$ ;  $\sigma = 1.38 \text{ mho/m}$ ;  $\epsilon_r = 39.9$ ;  $\rho = 1000 \text{ kg/m}^3$   
 Phantom section: Flat Section

DASY4 Configuration:

- Probe: ET3DV6 - SN1604; ConvF(5.04, 5.04, 5.04); Calibrated: 9/16/2010
- Sensor-Surface: 4mm (Mechanical Surface Detection)
- Electronics: DAE3 Sn456; Calibrated: 11/8/2007
- Phantom: SAM with CRP; Type: Twin SAM; Serial: TP-1032
- Measurement SW: DASY4, V4.6 Build 23; Post processing SW: SEMCAD, V1.8 Build 184

**d =10 mm, Pin = 0.5W /Area Scan (81x121x1):** Measurement grid: dx=15mm, dy=15mm  
 Maximum value of SAR (interpolated) = 20.7 mW/g

**d =10 mm, Pin = 0.5W /Zoom Scan (8x8x7)/Cube 0:** Measurement grid: dx=5mm, dy=5mm, dz=5mm  
 Reference Value = 127.5 V/m; Power Drift = -0.054 dB  
 Peak SAR (extrapolated) = 34.7 W/kg

**SAR(1 g) = 18.8 mW/g; SAR(10 g) = 9.58 mW/g**  
 Maximum value of SAR (measured) = 21.3 mW/g

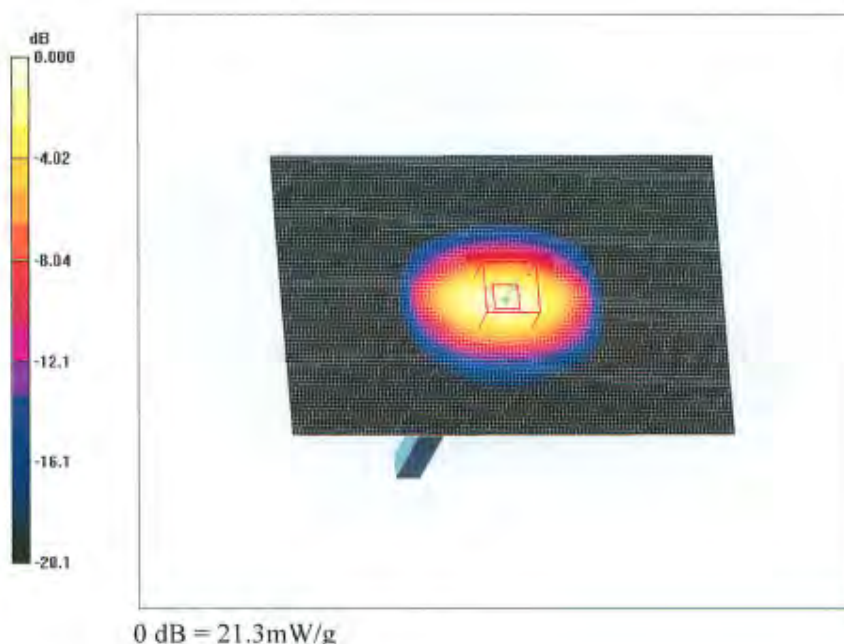

### Impedance Measurement Plot for Head TSL

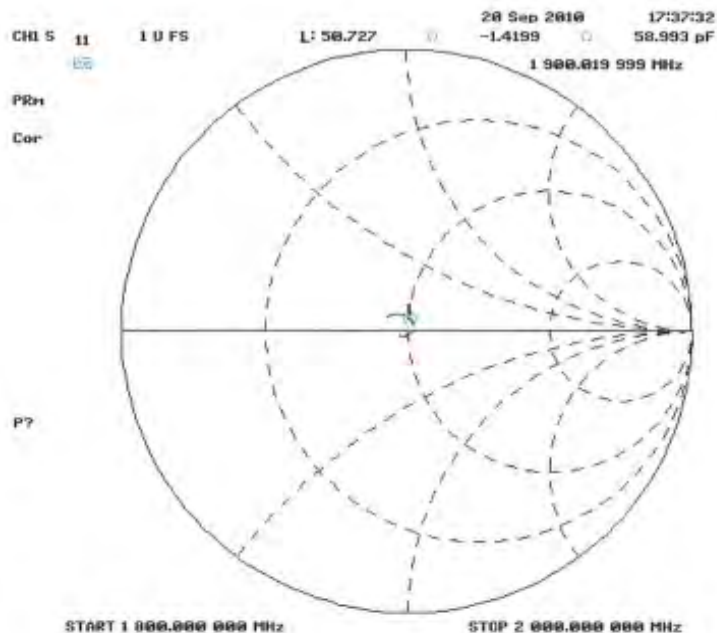

### Return Loss Measurement Plot for Head TSL

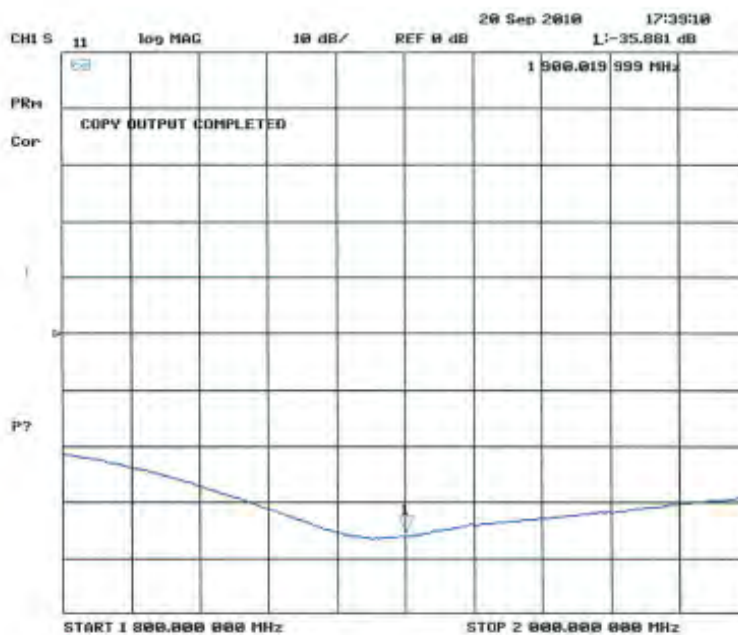

---

**APPENDIX D – SAR SYSTEM VALIDATION DATA**

---

**Test Laboratory: Bay Area Compliance Lab Corp. (Shenzhen)****System Performance Check 835 MHz, Head Tissue****Dipole 835 MHz; Type: ALS-D-835-S-2; S/N: 180-00558**

## Product Data

Device Name : Dipole 835 MHz  
Serial No. : 180-00558  
Type : Dipole  
Model : ALS-D-835-S-2  
Frequency : 835.00 MHz  
Max. Transmit Pwr : 1 W  
Drift Time : 3 min(s)  
Power Drift-Start : 9.212 W/kg  
Power Drift-Finish : 9.253 W/kg  
Power Drift (%) : 1.137

## Phantom Data

Name : APREL-Uni  
Type : Uni-Phantom  
Size (mm) : 280 x 280 x 200  
Serial No. : System Default  
Location : Center  
Description : Default  
Phantom Data

## Tissue Data

Type : HEAD  
Serial No. : 270-01002  
Frequency : 835.00 MHz  
Last Calib. Date : 01-Mar -2010  
Temperature : 20.00 °C  
Ambient Temp. : 21.00 °C  
Humidity : 50.00 RH%  
Epsilon : 41.15 F/m  
Sigma : 0.91 S/m  
Density : 1000.00 kg/cu. m

## Probe Data

Name : E-Field  
Model : E-020  
Type : E-Field Triangle  
Serial No. : 273  
Last Calib. Date : 20-Aug-2010  
Frequency : 835.00 MHz  
Duty Cycle Factor : 1  
Conversion Factor : 6.5  
Probe Sensitivity : 1.20 1.20 1.20  $\mu\text{V}/(\text{V}/\text{m})^2$   
Compression Point : 95.00 mV  
Offset : 1.56 mm

## Measurement Data

Crest Factor : 1  
Scan Type : Complete  
Tissue Temp. : 20.00 °C  
Ambient Temp. : 21.00 °C  
Area Scan : 7x9x1 : Measurement x=10mm, y=10mm, z=4mm  
Zoom Scan : 7x7x7 : Measurement x=5mm, y=5mm, z=5mm

1 gram SAR value : 9.621 W/kg  
 10 gram SAR value : 6.037 W/kg  
 Area Scan Peak SAR : 9.876 W/kg  
 Zoom Scan Peak SAR : 14.328 W/kg

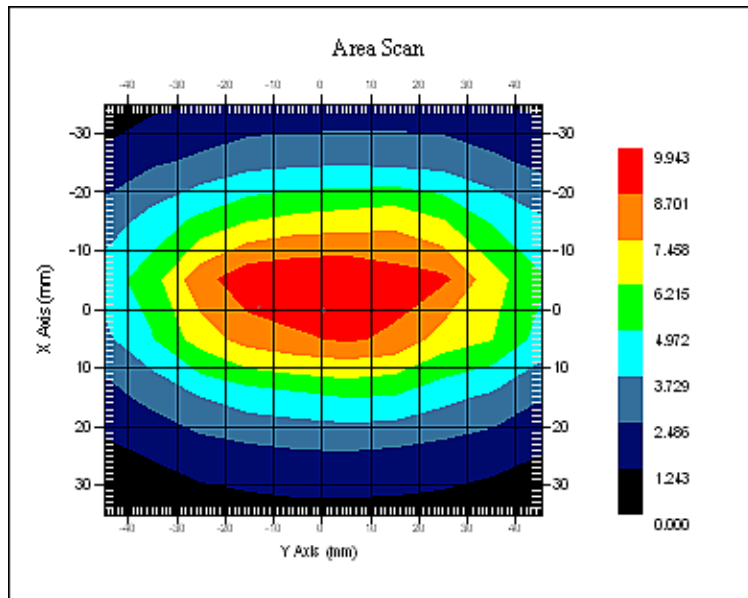

**835 MHz System Validation**



**Test Laboratory: Bay Area Compliance Lab Corp. (Shenzhen)****System Performance Check 1900 MHz, Head Tissue****Dipole 1900 MHz; Type: ALS-D-1900-S-2; S/N: 210-00710**

## Product Data

Device Name : Dipole 1900MHz  
Serial No. : 210-00710  
Type : Dipole  
Model : ALS-D-1900-S-2  
Frequency : 1900.00 MHz  
Max. Transmit Pwr : 1 W  
Drift Time : 3 min(s)  
Power Drift-Start : 45.287 W/kg  
Power Drift-Finish : 47.328 W/kg  
Power Drift (%) : 3.637

## Phantom Data

Name : APREL-Uni  
Type : Uni-Phantom  
Size (mm) : 280 x 280 x 200  
Serial No. : System Default  
Location : Center  
Description : Default

## Tissue Data

Type : HEAD  
Serial No. : 295-01103  
Frequency : 1900.00 MHz  
Last Calib. Date : 01-Mar -2011  
Temperature : 20.00 °C  
Ambient Temp. : 21.00 °C  
Humidity : 56.00 RH%  
Epsilon : 40.04 F/m  
Sigma : 1.46 S/m  
Density : 1000.00 kg/cu. m

## Probe Data

Name : E-Field  
Model : E-020  
Type : E-Field Triangle  
Serial No. : 273  
Last Calib. Date : 21-Aug-2010  
Frequency : 1900.00 MHz  
Duty Cycle Factor : 1  
Conversion Factor : 5.25  
Probe Sensitivity : 1.20 1.20 1.20  $\mu\text{V}/(\text{V}/\text{m})^2$   
Compression Point : 95.00 mV  
Offset : 1.56 mm

## Measurement Data

Crest Factor : 1  
Scan Type : Complete  
Tissue Temp. : 20.00 °C  
Ambient Temp. : 21.00 °C  
Area Scan : 7x9x1 : Measurement x=10mm, y=10mm, z=4mm  
Zoom Scan : 7x7x7 : Measurement x=5mm, y=5mm, z=5mm

1 gram SAR value : 40.245 W/kg  
 10 gram SAR value : 20.421 W/kg  
 Area Scan Peak SAR : 45.836 W/kg  
 Zoom Scan Peak SAR : 75.249 W/kg

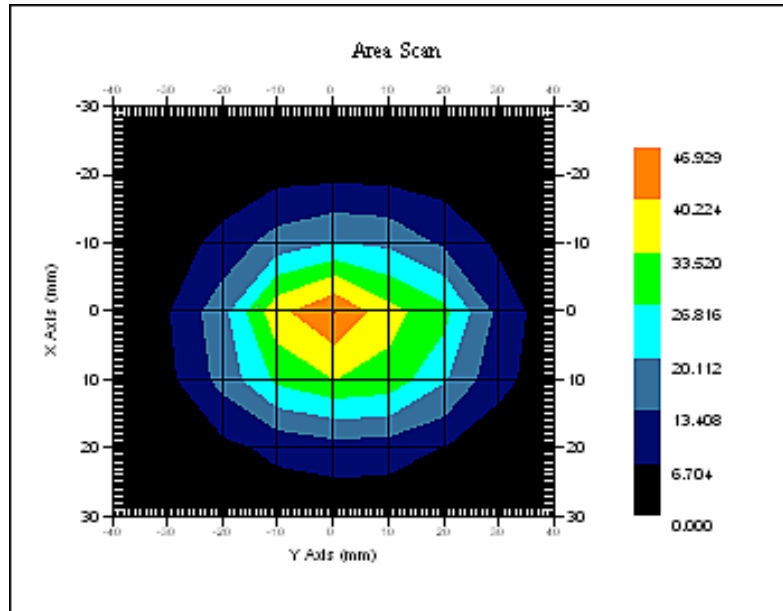

**1900 MHz System Validation**

## APPENDIX E – EUT SCAN RESULTS

**Test Laboratory: Bay Area Compliance Lab Corp. (Shenzhen)**

### Left Head Cheek (835 MHz High Channel)

**Measurement Data**

Test mode : GSM  
 Crest Factor : 8  
 Scan Type : Complete  
 Area Scan : 11x6x1: Measurement x=10mm, y=10mm, z=4mm  
 Zoom Scan : 7x7x7: Measurement x=5mm, y=5mm, z=5mm  
 Power Drift-Start : 0.008 W/kg  
 Power Drift-Finish : 0.008 W/kg  
 Power Drift (%) : 0.653

**Tissue Data**

Type : HEAD  
 Frequency : 835.00 MHz  
 Epsilon : 41.15 F/m  
 Sigma : 0.91 S/m0  
 Density : 1000.00 kg/cu. m

**Probe Data**

Serial No. : 273  
 Frequency : 835.00 MHz  
 Duty Cycle Factor : 8  
 Conversion Factor : 6.5  
 Probe Sensitivity : 1.20 1.20 1.20  $\mu\text{V}/(\text{V}/\text{m})^2$   
 Compression Point : 95.00 mV  
 Offset : 1.56 mm

1 gram SAR value : 0.229 W/kg  
 10 gram SAR value : 0.127 W/kg  
 Area Scan Peak SAR : 0.230 W/kg  
 Zoom Scan Peak SAR : 0.390 W/kg

**Plot 1#**

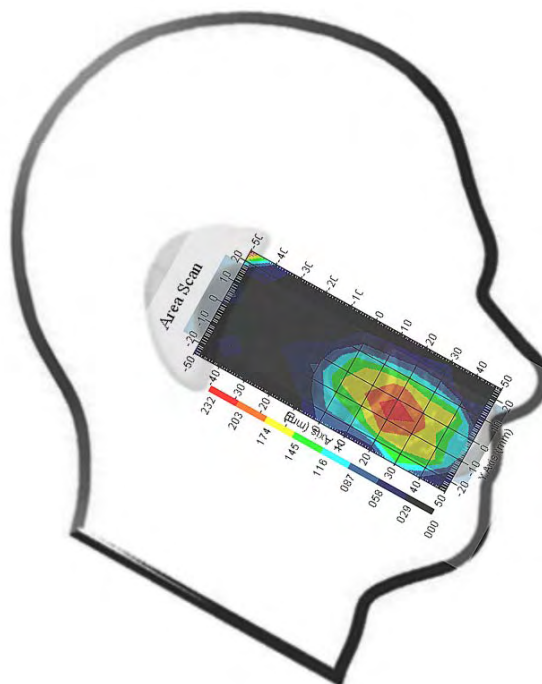

**Test Laboratory: Bay Area Compliance Lab Corp. (Shenzhen)**

**Left Head Tilt (835 MHz High Channel)**

Measurement Data

Test mode : GSM  
 Crest Factor : 8  
 Scan Type : Complete  
 Area Scan : 11x6x1: Measurement x=10mm, y=10mm, z=4mm  
 Zoom Scan : 7x7x7: Measurement x=5mm, y=5mm, z=5mm  
 Power Drift-Start : 0.010 W/kg  
 Power Drift-Finish : 0.009 W/kg  
 Power Drift (%) : -3.302

Tissue Data

Type : HEAD  
 Frequency : 835.00 MHz  
 Epsilon : 41.15 F/m  
 Sigma : 0.91 S/m  
 Density : 1000.00 kg/cu. m

Probe Data

Serial No. : 273  
 Frequency : 835.00 MHz  
 Duty Cycle Factor : 8  
 Conversion Factor : 6.5  
 Probe Sensitivity : 1.20 1.20 1.20  $\mu\text{V}/(\text{V}/\text{m})^2$   
 Compression Point : 95.00 mV  
 Offset : 1.56 mm

1 gram SAR value : 0.156 W/kg  
 10 gram SAR value : 0.093 W/kg  
 Area Scan Peak SAR : 0.169 W/kg  
 Zoom Scan Peak SAR : 0.240 W/kg

**Plot 2#**

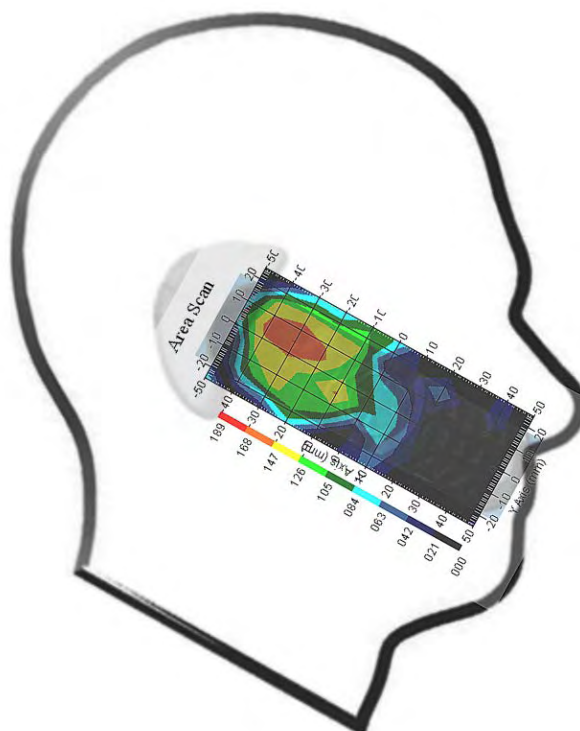

**Test Laboratory: Bay Area Compliance Lab Corp. (Shenzhen)**

**Right Head Cheek (835 MHz Low Channel)**

Measurement Data

Test mode : GSM  
 Crest Factor : 8  
 Scan Type : Complete  
 Area Scan : 11x6x1: Measurement x=10mm, y=10mm, z=4mm  
 Zoom Scan : 7x7x7: Measurement x=5mm, y=5mm, z=5mm  
 Power Drift-Start : 0.007 W/kg  
 Power Drift-Finish : 0.008 W/kg  
 Power Drift (%) : 3.901

Tissue Data

Type : HEAD  
 Frequency : 835.00 MHz  
 Epsilon : 41.15 F/m  
 Sigma : 0.91 S/m  
 Density : 1000.00 kg/cu. m

Probe Data

Serial No. : 273  
 Frequency : 835.00 MHz  
 Duty Cycle Factor : 8  
 Conversion Factor : 6.5  
 Probe Sensitivity : 1.20 1.20 1.20  $\mu\text{V}/(\text{V/m})^2$   
 Compression Point : 95.00 mV  
 Offset : 1.56 mm

1 gram SAR value : 0.244 W/kg  
 10 gram SAR value : 0.150 W/kg  
 Area Scan Peak SAR : 0.265 W/kg  
 Zoom Scan Peak SAR : 0.430 W/kg

**Plot 3#**

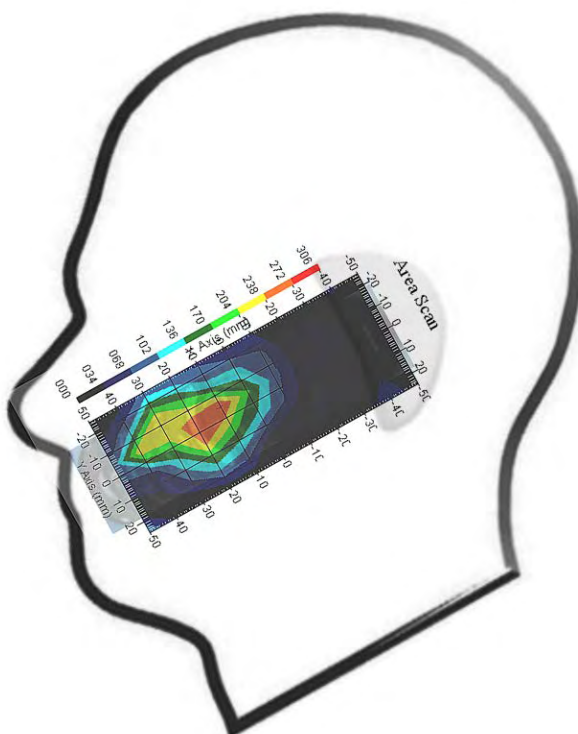

**Test Laboratory: Bay Area Compliance Lab Corp. (Shenzhen)****Right Head Cheek (835 MHz Middle channel)**

## Measurement Data

Test mode : GSM  
Crest Factor : 8  
Scan Type : Complete  
Area Scan : 11x6x1 : Measurement x=10mm, y=10mm, z=4mm  
Zoom Scan : 7x7x7 : Measurement x=5mm, y=5mm, z=5mm  
Power Drift-Start : 0.004 W/kg  
Power Drift-Finish : 0.004 W/kg  
Power Drift (%) : 0.541

## Tissue Data

Type : HEAD  
Frequency : 835.00 MHz  
Epsilon : 41.15 F/m  
Sigma : 0.91 S/m  
Density : 1000.00 kg/cu. m

## Probe Data

Serial No. : 273  
Frequency : 835.00 MHz  
Duty Cycle Factor : 8  
Conversion Factor : 6.5  
Probe Sensitivity : 1.20 1.20 1.20  $\mu\text{V}/(\text{V}/\text{m})^2$   
Compression Point : 95.00 mV  
Offset : 1.56 mm

1 gram SAR value : 0.245 W/kg  
10 gram SAR value : 0.095 W/kg  
Area Scan Peak SAR : 0.242 W/kg  
Zoom Scan Peak SAR : 0.340 W/kg

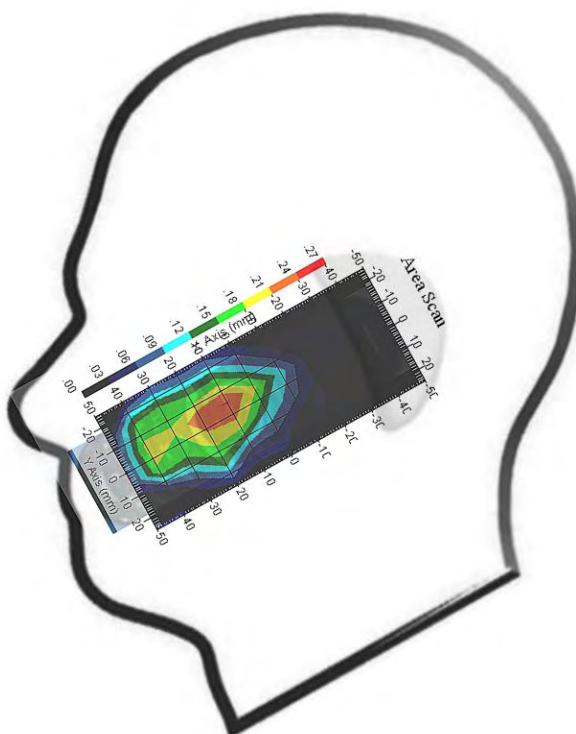
**Plot 4#**

**Test Laboratory: Bay Area Compliance Lab Corp. (Shenzhen)**

**Right Head Cheek (835 MHz High Channel)**

Measurement Data

Test mode : GSM  
 Crest Factor : 8  
 Scan Type : Complete  
 Area Scan : 11x6x1 : Measurement x=10mm, y=10mm, z=4mm  
 Zoom Scan : 7x7x7 : Measurement x=5mm, y=5mm, z=5mm  
 Power Drift-Start : 0.007 W/kg  
 Power Drift-Finish : 0.008 W/kg  
 Power Drift (%) : 2.404

Tissue Data

Type : HEAD  
 Frequency : 835.00 MHz  
 Epsilon : 41.15 F/m  
 Sigma : 0.91 S/m  
 Density : 1000.00 kg/cu. m

Probe Data

Serial No. : 273  
 Frequency : 835.00 MHz  
 Duty Cycle Factor : 8  
 Conversion Factor : 6.5  
 Probe Sensitivity : 1.20 1.20 1.20  $\mu\text{V}/(\text{V/m})^2$   
 Compression Point : 95.00 mV  
 Offset : 1.56 mm

1 gram SAR value : 0.255 W/kg  
 10 gram SAR value : 0.096 W/kg  
 Area Scan Peak SAR : 0.262 W/kg  
 Zoom Scan Peak SAR : 0.380 W/kg

**Plot 5#**

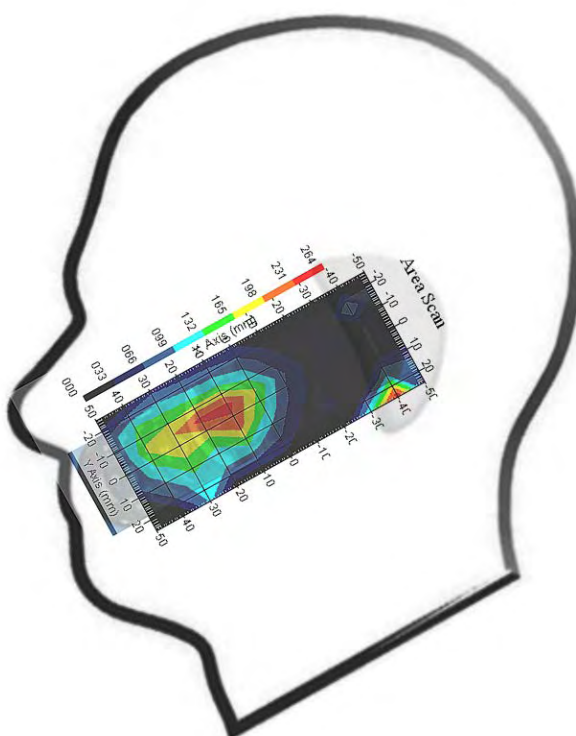

**Test Laboratory: Bay Area Compliance Lab Corp. (Shenzhen)****Right Head Tilt (835 MHz High Channel)**

## Measurement Data

Test mode : GSM  
Crest Factor : 8  
Scan Type : Complete  
Area Scan : 11x6x1 : Measurement x=10mm, y=10mm, z=4mm  
Zoom Scan : 7x7x7 : Measurement x=5mm, y=5mm, z=5mm  
Power Drift-Start : 0.131 W/kg  
Power Drift-Finish : 0.133 W/kg  
Power Drift (%) : 1.337

## Tissue Data

Type : HEAD  
Frequency : 835.00 MHz  
Epsilon : 41.15 F/m  
Sigma : 0.91 S/m  
Density : 1000.00 kg/cu. m

## Probe Data

Serial No. : 273  
Frequency : 835.00 MHz  
Duty Cycle Factor : 8  
Conversion Factor : 6.5  
Probe Sensitivity : 1.20 1.20 1.20  $\mu\text{V}/(\text{V/m})^2$   
Compression Point : 95.00 mV  
Offset : 1.56 mm

1 gram SAR value : 0.187 W/kg  
10 gram SAR value : 0.101 W/kg  
Area Scan Peak SAR : 0.187 W/kg  
Zoom Scan Peak SAR : 0.300 W/kg

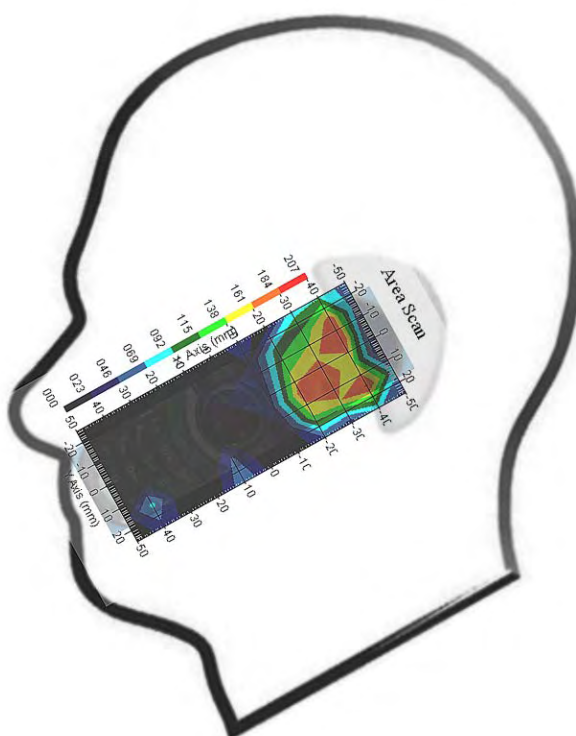
**Plot 6#**



**Test Laboratory: Bay Area Compliance Lab Corp. (Shenzhen)**

**Body- worn Back (835 MHz High Channel)**

Measurement Data

Test mode : GSM  
 Crest Factor : 8  
 Scan Type : Complete  
 Area Scan : 6x9x1: Measurement x=10mm, y=10mm, z=4mm  
 Zoom Scan : 7x7x7 : Measurement x=5mm, y=5mm, z=5mm  
 Power Drift-Start : 0.152 W/kg  
 Power Drift-Finish : 0.160 W/kg  
 Power Drift (%) : 2.306

Tissue Data

Type : BODY  
 Frequency : 835.00 MHz  
 Epsilon : 55.33 F/m  
 Sigma : 0.98 S/m  
 Density : 1000.00 kg/cu. m

Probe Data

Serial No. : 273  
 Frequency : 835.00 MHz  
 Duty Cycle Factor : 8  
 Conversion Factor : 6.7  
 Probe Sensitivity : 1.20 1.20 1.20  $\mu\text{V}/(\text{V/m})^2$   
 Compression Point : 95.00 mV  
 Offset : 1.56 mm

1 gram SAR value : 0.151 W/kg  
 10 gram SAR value : 0.058 W/kg  
 Area Scan Peak SAR : 0.202 W/kg  
 Zoom Scan Peak SAR : 0.500 W/kg

**Plot 7#**

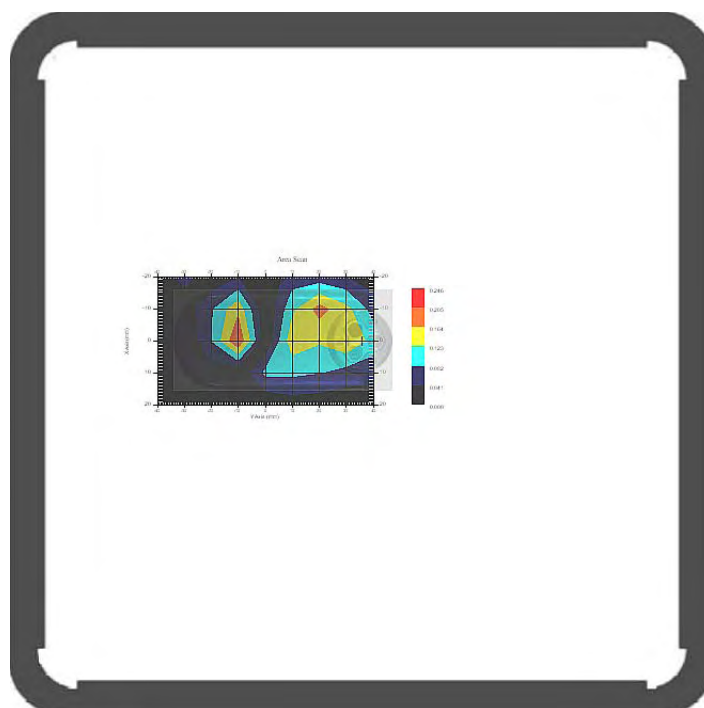

**Test Laboratory: Bay Area Compliance Lab Corp. (Shenzhen)**

**Body- worn Back (835 MHz Low Channel)**

Measurement Data

Test mode : GPRS  
 Crest Factor : 4  
 Scan Type : Complete  
 Area Scan : 6x9x1: Measurement x=10mm, y=10mm, z=4mm  
 Zoom Scan : 7x7x7 : Measurement x=5mm, y=5mm, z=5mm  
 Power Drift-Start : 0.207 W/kg  
 Power Drift-Finish : 0.206 W/kg  
 Power Drift (%) : -0.513

Tissue Data

Type : BODY  
 Frequency : 835.00 MHz  
 Epsilon : 55.33 F/m  
 Sigma : 0.98 S/m  
 Density : 1000.00 kg/cu. m

Probe Data

Serial No. : 273  
 Frequency : 835.00 MHz  
 Duty Cycle Factor : 4  
 Conversion Factor : 6.7  
 Probe Sensitivity : 1.20 1.20 1.20  $\mu\text{V}/(\text{V/m})^2$   
 Compression Point : 95.00 mV  
 Offset : 1.56 mm

1 gram SAR value : 0.291 W/kg  
 10 gram SAR value : 0.108 W/kg  
 Area Scan Peak SAR : 0.302 W/kg  
 Zoom Scan Peak SAR : 0.600 W/kg

**Plot 8#**

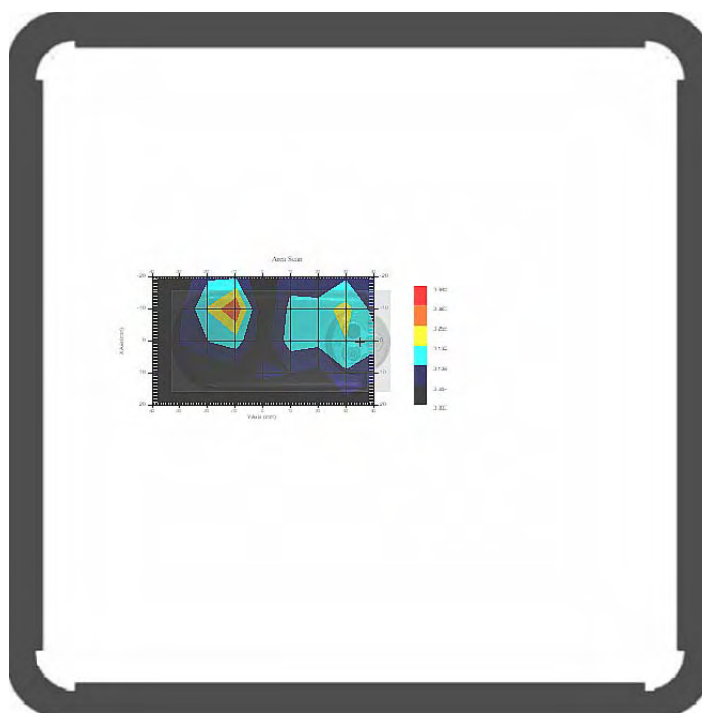

**Test Laboratory: Bay Area Compliance Lab Corp. (Shenzhen)**

**Body- worn Back (835 MHz Middle Channel)**

Measurement Data

Test mode : GPRS  
 Crest Factor : 4  
 Scan Type : Complete  
 Area Scan : 6x9x1: Measurement x=10mm, y=10mm, z=4mm  
 Zoom Scan : 7x7x7 : Measurement x=5mm, y=5mm, z=5mm  
 Power Drift-Start : 0.150 W/kg  
 Power Drift-Finish : 0.157 W/kg  
 Power Drift (%) : 1.825

Tissue Data

Type : BODY  
 Frequency : 835.00 MHz  
 Epsilon : 55.33 F/m  
 Sigma : 0.98 S/m  
 Density : 1000.00 kg/cu. m

Probe Data

Serial No. : 273  
 Frequency : 835.00 MHz  
 Duty Cycle Factor : 4  
 Conversion Factor : 6.7  
 Probe Sensitivity : 1.20 1.20 1.20  $\mu\text{V}/(\text{V}/\text{m})^2$   
 Compression Point : 95.00 mV  
 Offset : 1.56 mm

1 gram SAR value : 0.282 W/kg  
 10 gram SAR value : 0.117 W/kg  
 Area Scan Peak SAR : 0.284 W/kg  
 Zoom Scan Peak SAR : 0.610 W/kg

**Plot 9#**

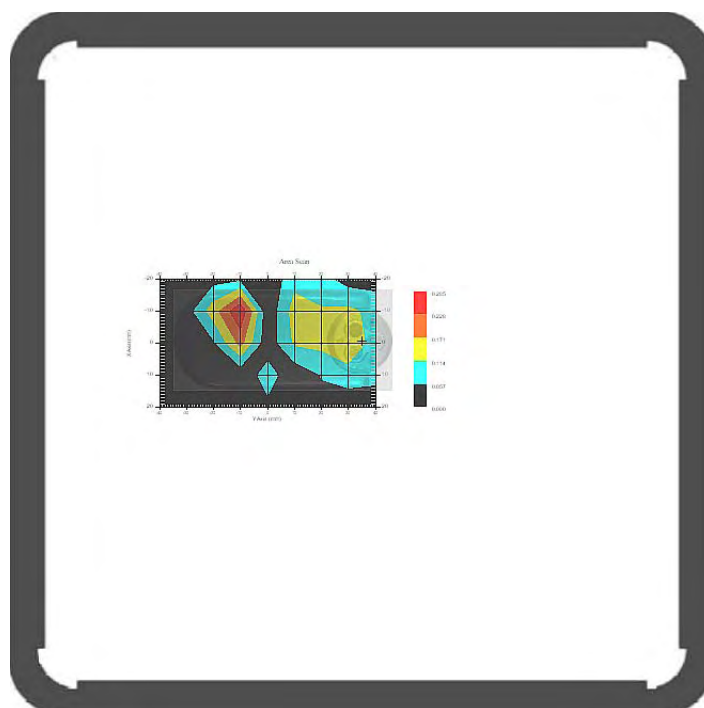

**Test Laboratory: Bay Area Compliance Lab Corp. (Shenzhen)**

**Body- worn Back (835 MHz High Channel)**

Measurement Data

Test mode : GPRS  
 Crest Factor : 4  
 Scan Type : Complete  
 Area Scan : 6x9x1: Measurement x=10mm, y=10mm, z=4mm  
 Zoom Scan : 7x7x7 : Measurement x=5mm, y=5mm, z=5mm  
 Power Drift-Start : 0.103 W/kg  
 Power Drift-Finish : 0.101 W/kg  
 Power Drift (%) : -2.112

Tissue Data

Type : BODY  
 Frequency : 835.00 MHz  
 Epsilon : 55.33 F/m  
 Sigma : 0.98 S/m  
 Density : 1000.00 kg/cu. m

Probe Data

Serial No. : 273  
 Frequency : 835.00 MHz  
 Duty Cycle Factor : 4  
 Conversion Factor : 6.7  
 Probe Sensitivity : 1.20 1.20 1.20  $\mu\text{V}/(\text{V/m})^2$   
 Compression Point : 95.00 mV  
 Offset : 1.56 mm

1 gram SAR value : 0.313 W/kg  
 10 gram SAR value : 0.126 W/kg  
 Area Scan Peak SAR : 0.296 W/kg  
 Zoom Scan Peak SAR : 0.581 W/kg

**Plot 10#**

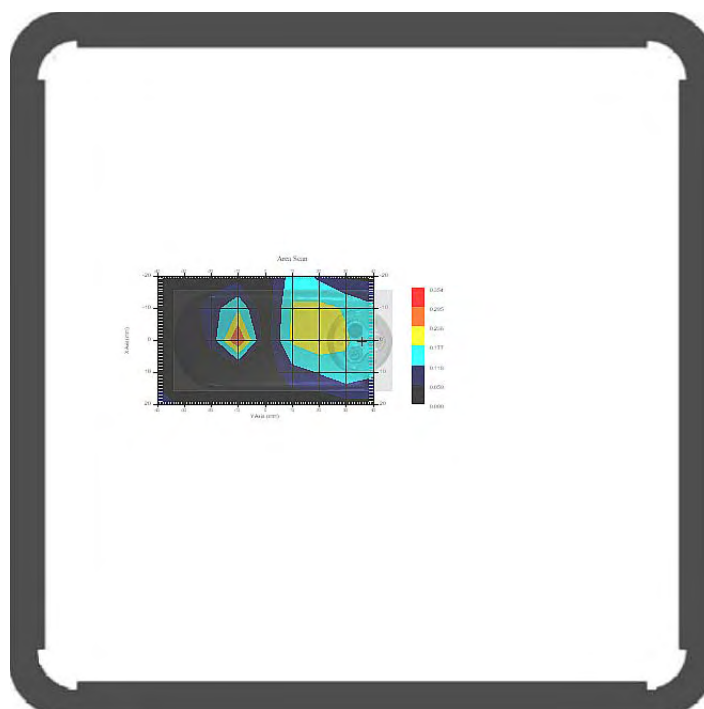

**Test Laboratory: Bay Area Compliance Lab Corp. (Shenzhen)****Left Head Cheek (1900 MHz Low Channel)**

## Measurement Data

Test mode : GSM  
Crest Factor : 8  
Scan Type : Complete  
Area Scan : 11x6x1: Measurement x=10mm, y=10mm, z=4mm  
Zoom Scan : 7x7x7: Measurement x=5mm, y=5mm, z=5mm  
Power Drift-Start : 0.317 W/kg  
Power Drift-Finish : 0.322 W/kg  
Power Drift (%) : 1.658

## Tissue Data

Type : HEAD  
Frequency : 1900.00 MHz  
Epsilon : 40.04 F/m  
Sigma : 1.46 S/m  
Density : 1000.00 kg/cu. m

## Probe Data

Serial No. : 273  
Frequency : 1900.00 MHz  
Duty Cycle Factor : 8  
Conversion Factor : 5.25  
Probe Sensitivity : 1.20 1.20 1.20  $\mu\text{V}/(\text{V}/\text{m})^2$   
Compression Point : 95.00 mV  
Offset : 1.56 mm

1 gram SAR value : 0.406 W/kg  
10 gram SAR value : 0.216 W/kg  
Area Scan Peak SAR : 0.418 W/kg  
Zoom Scan Peak SAR : 0.560 W/kg

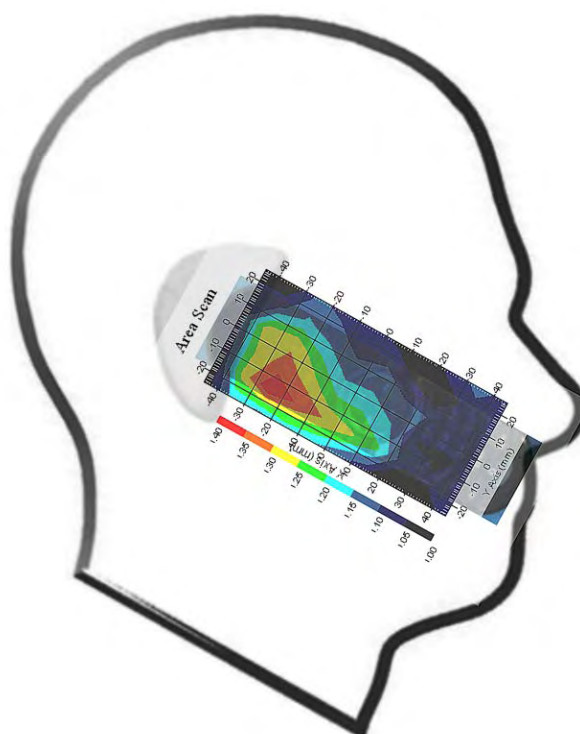
**Plot 11#**

**Test Laboratory: Bay Area Compliance Lab Corp. (Shenzhen)****Left Head Cheek (1900 MHz Middle Channel)**

## Measurement Data

Test mode : GSM  
Crest Factor : 8  
Scan Type : Complete  
Area Scan : 11x6x1 : Measurement x=10mm, y=10mm, z=4mm  
Zoom Scan : 7x7x7 : Measurement x=5mm, y=5mm, z=5mm  
Power Drift-Start : 0.272 W/kg  
Power Drift-Finish : 0.265 W/kg  
Power Drift (%) : -1.982

## Tissue Data

Type : HEAD  
Frequency : 1900.00 MHz  
Epsilon : 40.04 F/m  
Sigma : 1.46 S/m  
Density : 1000.00 kg/cu. m

## Probe Data

Serial No. : 273  
Frequency : 1900.00 MHz  
Duty Cycle Factor : 8  
Conversion Factor : 5.25  
Probe Sensitivity : 1.20 1.20 1.20  $\mu\text{V}/(\text{V/m})^2$   
Compression Point : 95.00 mV  
Offset : 1.56 mm

1 gram SAR value : 0.395 W/kg  
10 gram SAR value : 0.219 W/kg  
Area Scan Peak SAR : 0.410 W/kg  
Zoom Scan Peak SAR : 0.700 W/kg

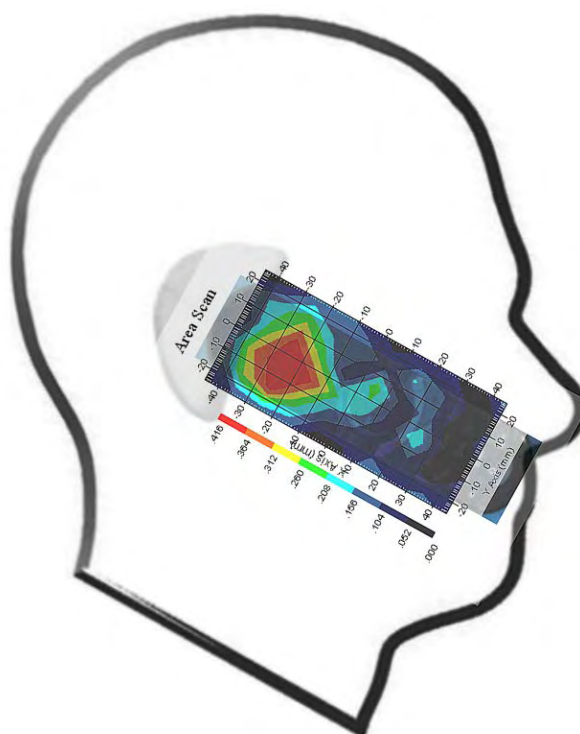
**Plot 12#**

**Test Laboratory: Bay Area Compliance Lab Corp. (Shenzhen)****Left Head Cheek (1900 MHz High Channel)**

## Measurement Data

Test mode : GSM  
Crest Factor : 8  
Scan Type : Complete  
Area Scan : 11x6x1 : Measurement x=10mm, y=10mm, z=4mm  
Zoom Scan : 7x7x7 : Measurement x=5mm, y=5mm, z=5mm  
Power Drift-Start : 0.131 W/kg  
Power Drift-Finish : 0.134 W/kg  
Power Drift (%) : 1.916

## Tissue Data

Type : HEAD  
Frequency : 1900.00 MHz  
Epsilon : 40.04 F/m  
Sigma : 1.46 S/m  
Density : 1000.00 kg/cu. m

## Probe Data

Serial No. : 273  
Frequency : 1900.00 MHz  
Duty Cycle Factor : 8  
Conversion Factor : 5.25  
Probe Sensitivity : 1.20 1.20 1.20  $\mu\text{V}/(\text{V}/\text{m})^2$   
Compression Point : 95.00 mV  
Offset : 1.56 mm

1 gram SAR value : 0.404 W/kg  
10 gram SAR value : 0.225 W/kg  
Area Scan Peak SAR : 0.425 W/kg  
Zoom Scan Peak SAR : 1.030 W/kg

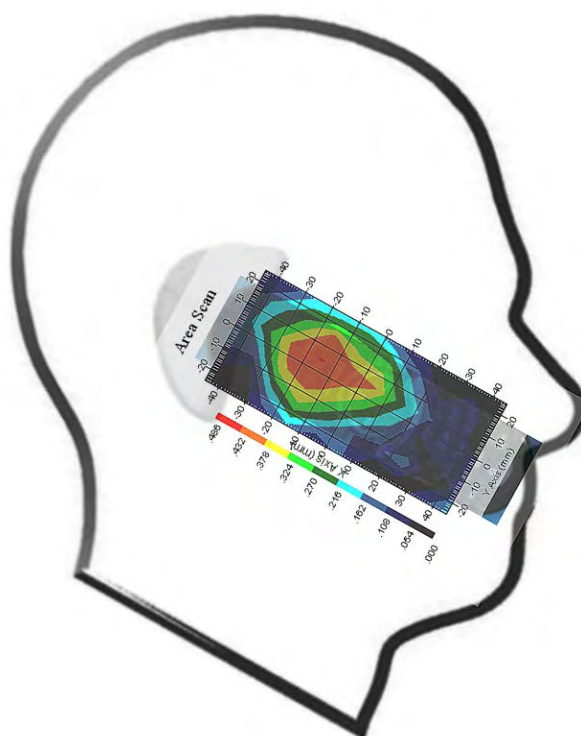
**Plot 13#**

**Test Laboratory: Bay Area Compliance Lab Corp. (Shenzhen)**

**Left Head Tilt (1900 MHz Low Channel)**

Measurement Data

Test mode : GSM  
 Crest Factor : 8  
 Scan Type : Complete  
 Area Scan : 11x6x1 : Measurement x=10mm, y=10mm, z=4mm  
 Zoom Scan : 7x7x7 : Measurement x=5mm, y=5mm, z=5mm  
 Power Drift-Start : 0.051 W/kg  
 Power Drift-Finish : 0.054 W/kg  
 Power Drift (%) : 1.940

Tissue Data

Type : HEAD  
 Frequency : 1900.00 MHz  
 Epsilon : 40.04 F/m  
 Sigma : 1.46 S/m  
 Density : 1000.00 kg/cu. m

Probe Data

Serial No. : 273  
 Frequency : 1900.00 MHz  
 Duty Cycle Factor : 8  
 Conversion Factor : 5.25  
 Probe Sensitivity : 1.20 1.20 1.20  $\mu\text{V}/(\text{V}/\text{m})^2$   
 Compression Point : 95.00 mV  
 Offset : 1.56 mm

1 gram SAR value : 0.219 W/kg  
 10 gram SAR value : 0.124 W/kg  
 Area Scan Peak SAR : 0.244 W/kg  
 Zoom Scan Peak SAR : 0.471 W/kg

**Plot 14#**

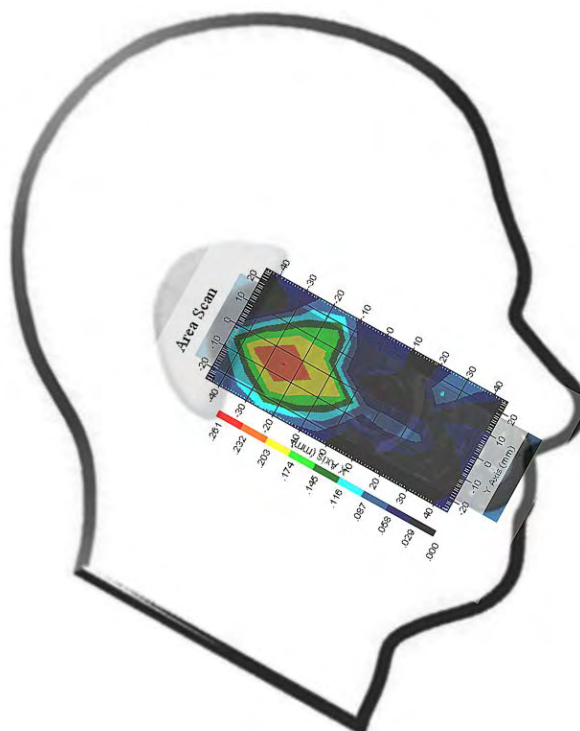



**Test Laboratory: Bay Area Compliance Lab Corp. (Shenzhen)****Right Head Cheek (1900 MHz Low Channel)**

## Measurement Data

Test mode : GSM  
Crest Factor : 8  
Scan Type : Complete  
Area Scan : 11x6x1 : Measurement x=10mm, y=10mm, z=4mm  
Zoom Scan : 7x7x7 : Measurement x=5mm, y=5mm, z=5mm  
Power Drift-Start : 0.051 W/kg  
Power Drift-Finish : 0.054 W/kg  
Power Drift (%) : 1.940

## Tissue Data

Type : HEAD  
Frequency : 1900.00 MHz  
Epsilon : 40.04 F/m  
Sigma : 1.46 S/m  
Density : 1000.00 kg/cu. m

## Probe Data

Serial No. : 273  
Frequency : 1900.00 MHz  
Duty Cycle Factor : 8  
Conversion Factor : 5.25  
Probe Sensitivity : 1.20 1.20 1.20  $\mu\text{V}/(\text{V/m})^2$   
Compression Point : 95.00 mV  
Offset : 1.56 mm

1 gram SAR value : 0.403 W/kg  
10 gram SAR value : 0.203 W/kg  
Area Scan Peak SAR : 0.407 W/kg  
Zoom Scan Peak SAR : 0.690 W/kg

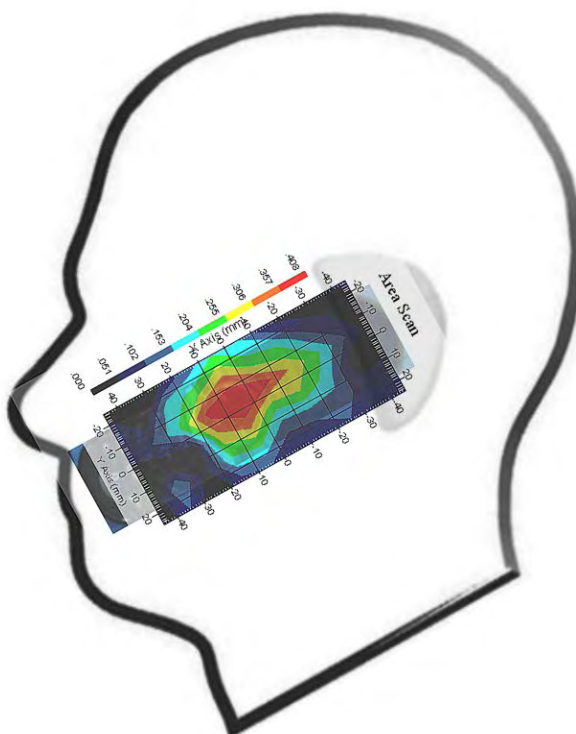
**Plot 15#**

**Test Laboratory: Bay Area Compliance Lab Corp. (Shenzhen)****Right Head Tilt (1900 MHz Low Channel)**

## Measurement Data

Test mode : GSM  
Crest Factor : 8  
Scan Type : Complete  
Area Scan : 11x6x1 : Measurement x=10mm, y=10mm, z=4mm  
Zoom Scan : 7x7x7 : Measurement x=5mm, y=5mm, z=5mm  
Power Drift-Start : 0.051 W/kg  
Power Drift-Finish : 0.058 W/kg  
Power Drift (%) : 3.491

## Tissue Data

Type : HEAD  
Frequency : 1900.00 MHz  
Epsilon : 40.04 F/m  
Sigma : 1.46 S/m  
Density : 1000.00 kg/cu. m

## Probe Data

Serial No. : 273  
Frequency : 1900.00 MHz  
Duty Cycle Factor : 8  
Conversion Factor : 5.25  
Probe Sensitivity : 1.20 1.20 1.20  $\mu\text{V}/(\text{V}/\text{m})^2$   
Compression Point : 95.00 mV  
Offset : 1.56 mm

1 gram SAR value : 0.203 W/kg  
10 gram SAR value : 0.108 W/kg  
Area Scan Peak SAR : 0.208 W/kg  
Zoom Scan Peak SAR : 0.620 W/kg

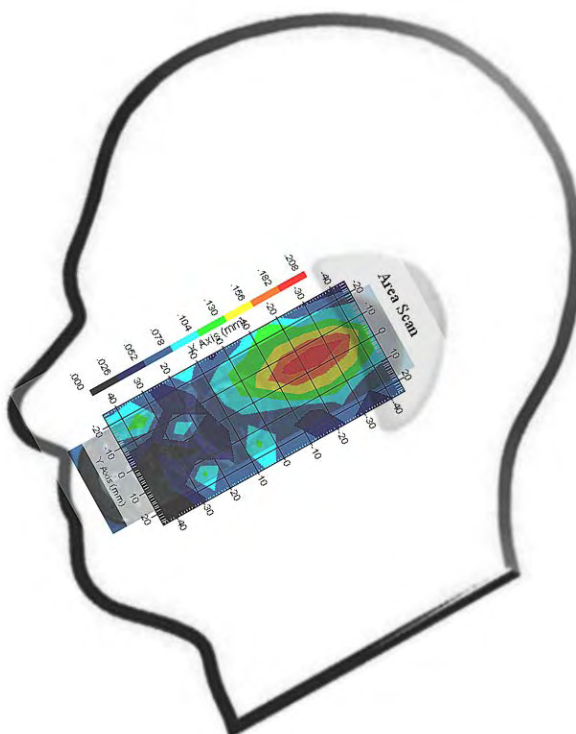
**Plot 16#**

**Test Laboratory: Bay Area Compliance Lab Corp. (Shenzhen)**

**Body- worn Back (1900 MHz Low Channel)**

Measurement Data

Test mode : GSM  
 Crest Factor : 8  
 Scan Type : Complete  
 Area Scan : 6x9x1: Measurement x=10mm, y=10mm, z=4mm  
 Zoom Scan : 7x7x7 : Measurement x=5mm, y=5mm, z=5mm  
 Power Drift-Start : 0.141 W/kg  
 Power Drift-Finish : 0.144 W/kg  
 Power Drift (%) : 1.608

Tissue Data

Type : BODY  
 Frequency : 1900.00 MHz  
 Epsilon : 53.87 F/m  
 Sigma : 1.48 S/m  
 Density : 1000.00 kg/cu. m

Probe Data

Serial No. : 273  
 Frequency : 1900.00 MHz  
 Duty Cycle Factor : 8  
 Conversion Factor : 5.15  
 Probe Sensitivity : 1.20 1.20 1.20  $\mu\text{V}/(\text{V}/\text{m})^2$   
 Compression Point : 95.00 mV  
 Offset : 1.56 mm

1 gram SAR value : 0.298 W/kg  
 10 gram SAR value : 0.151 W/kg  
 Area Scan Peak SAR : 0.310 W/kg  
 Zoom Scan Peak SAR : 0.610 W/kg

**Plot 17#**

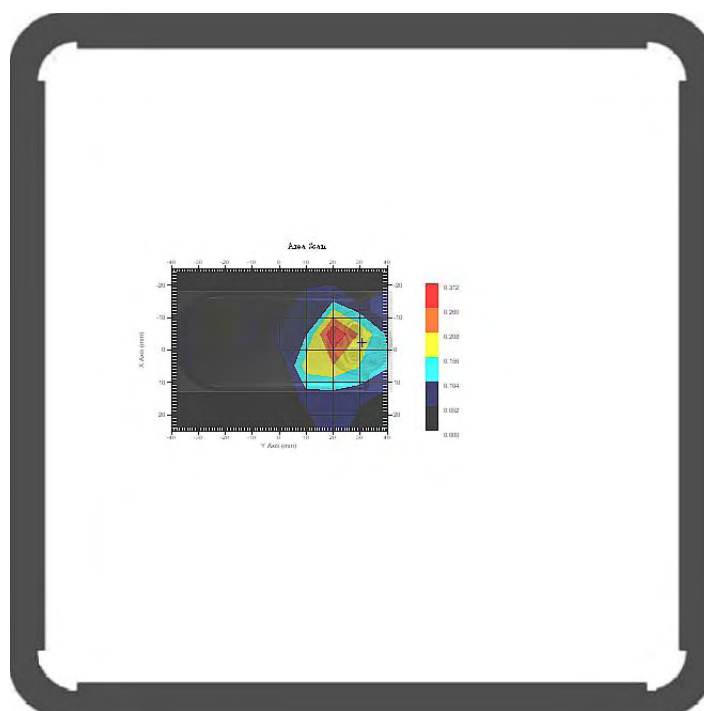

**Test Laboratory: Bay Area Compliance Lab Corp. (Shenzhen)**

**Body- worn Back (1900 MHz Low Channel)**

Measurement Data

Test mode : GPRS  
 Crest Factor : 4  
 Scan Type : Complete  
 Area Scan : 6x9x1: Measurement x=10mm, y=10mm, z=4mm  
 Zoom Scan : 7x7x7 : Measurement x=5mm, y=5mm, z=5mm  
 Power Drift-Start : 0.301 W/kg  
 Power Drift-Finish : 0.306 W/kg  
 Power Drift (%) : 0.980

Tissue Data

Type : BODY  
 Frequency : 1900.00 MHz  
 Epsilon : 53.87 F/m  
 Sigma : 1.48 S/m  
 Density : 1000.00 kg/cu. m

Probe Data

Serial No. : 273  
 Frequency : 1900.00 MHz  
 Duty Cycle Factor : 4  
 Conversion Factor : 5.15  
 Probe Sensitivity : 1.20 1.20 1.20  $\mu\text{V}/(\text{V/m})^2$   
 Compression Point : 95.00 mV  
 Offset : 1.56 mm

1 gram SAR value : 0.601 W/kg  
 10 gram SAR value : 0.265 W/kg  
 Area Scan Peak SAR : 0.606 W/kg  
 Zoom Scan Peak SAR : 1.191 W/kg

**Plot 18#**

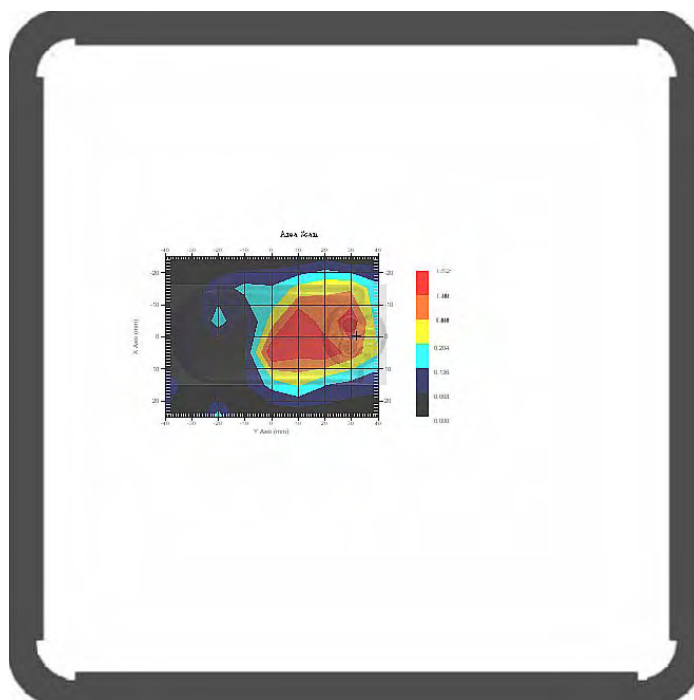

**Test Laboratory: Bay Area Compliance Lab Corp. (Shenzhen)**

**Body- worn Back (1900 MHz Middle Channel)**

Measurement Data

Test mode : GPRS  
 Crest Factor : 4  
 Scan Type : Complete  
 Area Scan : 6x9x1: Measurement x=10mm, y=10mm, z=4mm  
 Zoom Scan : 7x7x7 : Measurement x=5mm, y=5mm, z=5mm  
 Power Drift-Start : 0.354 W/kg  
 Power Drift-Finish : 0.339 W/kg  
 Power Drift (%) : -3.348

Tissue Data

Type : BODY  
 Frequency : 1900.00 MHz  
 Epsilon : 53.87 F/m  
 Sigma : 1.48 S/m  
 Density : 1000.00 kg/cu. m

Probe Data

Serial No. : 273  
 Frequency : 1900.00 MHz  
 Duty Cycle Factor : 4  
 Conversion Factor : 5.15  
 Probe Sensitivity : 1.20 1.20 1.20  $\mu\text{V}/(\text{V}/\text{m})^2$   
 Compression Point : 95.00 mV  
 Offset : 1.56 mm

1 gram SAR value : 0.567 W/kg  
 10 gram SAR value : 0.223 W/kg  
 Area Scan Peak SAR : 0.610 W/kg  
 Zoom Scan Peak SAR : 1.101 W/kg

**Plot 19#**

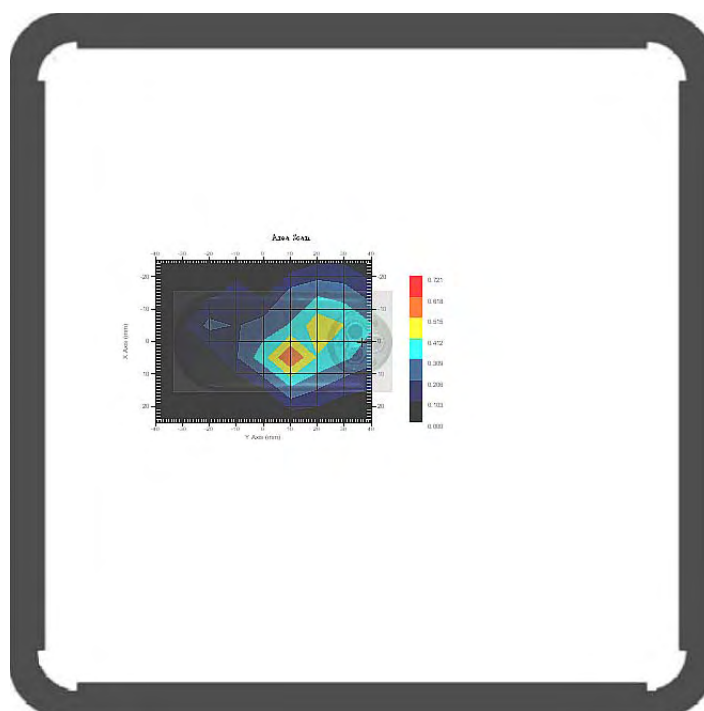

**Test Laboratory: Bay Area Compliance Lab Corp. (Shenzhen)**

**Body- worn Back (1900 MHz High Channel)**

Measurement Data

Test mode : GPRS  
 Crest Factor : 4  
 Scan Type : Complete  
 Area Scan : 6x11x1: Measurement x=10mm, y=10mm, z=4mm  
 Zoom Scan : 7x7x7 : Measurement x=5mm, y=5mm, z=5mm  
 Power Drift-Start : 0.223 W/kg  
 Power Drift-Finish : 0.226 W/kg  
 Power Drift (%) : 1.049

Tissue Data

Type : BODY  
 Frequency : 1900.00 MHz  
 Epsilon : 53.87 F/m  
 Sigma : 1.48 S/m  
 Density : 1000.00 kg/cu. m

Probe Data

Serial No. : 273  
 Frequency : 1900.00 MHz  
 Duty Cycle Factor : 4  
 Conversion Factor : 5.15  
 Probe Sensitivity : 1.20 1.20 1.20  $\mu\text{V}/(\text{V}/\text{m})^2$   
 Compression Point : 95.00 mV  
 Offset : 1.56 mm

1 gram SAR value : 0.564 W/kg  
 10 gram SAR value : 0.231 W/kg  
 Area Scan Peak SAR : 0.596 W/kg  
 Zoom Scan Peak SAR : 1.040 W/kg

**Plot 20#**

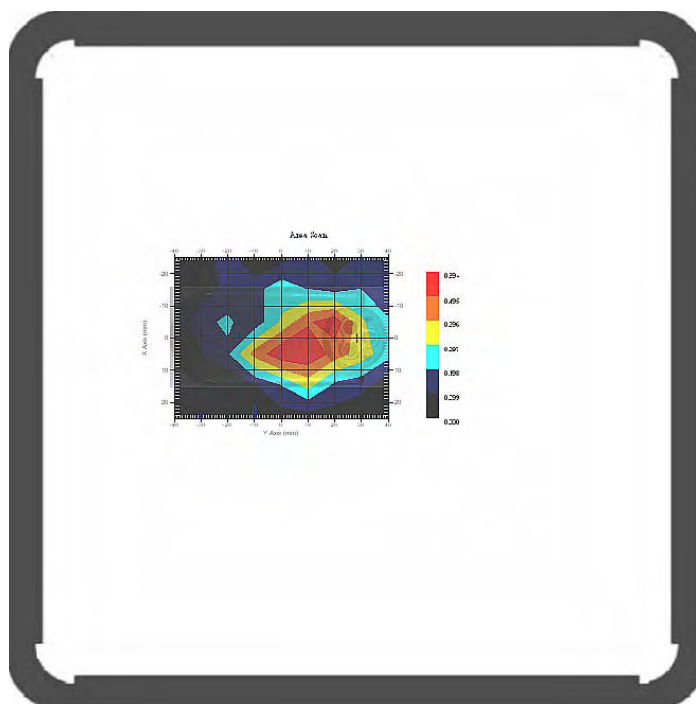

## APPENDIX F – CONDUCTED OUTPUT POWER MEASUREMENT

### Test Block Diagram and Procedure

The RF output of the transmitter was connected to the input of the spectrum analyzer through sufficient attenuation.

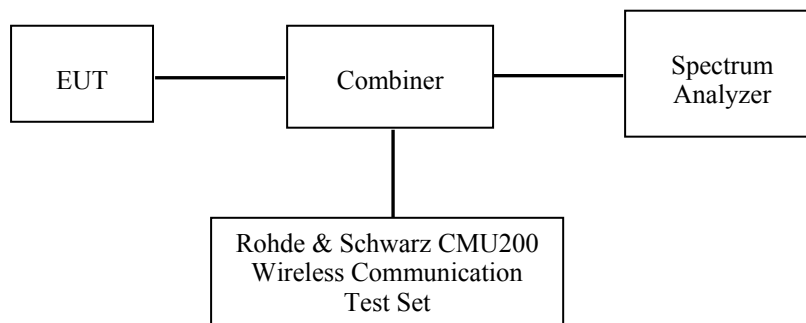

### Test Equipment List and Details

Manufacturer	Equipment Description	Model No.	Serial No.	Calibration Date
Rohde & Schwarz	Communication Tester	CMU200	1100.0008.02	2010-06-28
Rohde & Schwarz	Spectrum Analyzer	FSEM30	849720/019	2010-07-05

### Test Results

Band	Frequency (MHz)	Conducted Output Power (GSM Mode)	
		(dBm)	(Watt)
Cellular	824.2	32.66	1.845
	836.6	32.79	1.901
	848.8	32.84	1.923
PCS	1850.2	30.23	1.054
	1880.0	29.72	0.938
	1909.8	29.46	0.883

GPRS Mode:

Mode	Channel No	Frequency (MHz)	RF Output Power (dBm)			
			1 slot	2 slots	3 slots	4 slots
Cellular	128	824.2	32.59	32.18	Not support	Not support
	190	836.6	32.72	32.00	Not support	Not support
	251	848.8	32.77	32.13	Not support	Not support
PCS	512	1850.2	30.13	28.45	Not support	Not support
	661	1880.0	29.58	28.71	Not support	Not support
	810	1909.8	29.40	29.25	Not support	Not support

For SAR, the time-based average power is relevant, the difference in between depends on the duty cycle of the TDMA signal.

Number of Time slot	1	2	3	4
Duty Cycle	1:8	1:4	1:2.66	1:2
Time-based Ave. power compared to slotted Ave. power	-9 dB	-6 dB	-4.25 dB	-3 dB
Crest Factor	8	4	2.66	2

The time-based average power

Mode	Channel No	Frequency (MHz)	Time-based average Power (dBm)			
			1 slot	2 slots	3 slots	4 slots
Cellular	128	824.2	23.59 (32.59-9)	26.18 (32.18-6)	Not support	Not support
	190	836.6	23.72 (32.72-9)	26.00 (32.00-6)	Not support	Not support
	251	848.8	23.77 (32.77-9)	26.13 (32.13-6)	Not support	Not support
PCS	512	1850.2	21.13 (30.13-9)	22.45 (28.45-6)	Not support	Not support
	661	1880.0	20.58 (29.58-9)	22.71 (28.71-6)	Not support	Not support
	810	1909.8	20.40 (29.40-9)	23.25 (29.25-6)	Not support	Not support



## APPENDIX G – EUT TEST POSITION PHOTOS

Liquid Depth  $\geq$  15 cm

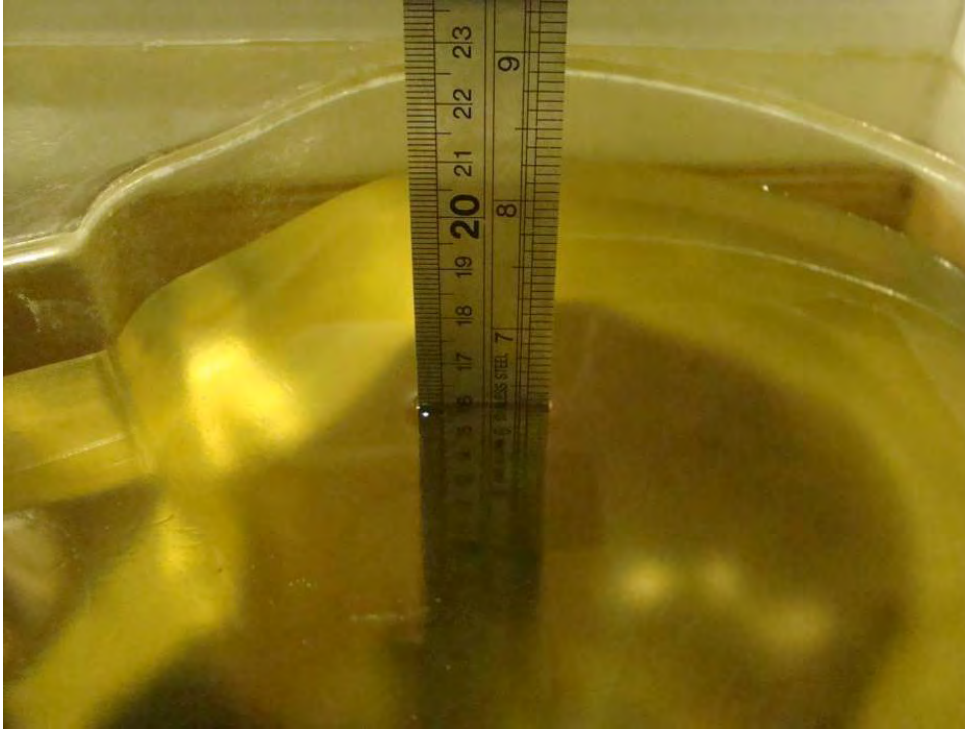

Body-worn Back Setup Photo



**Left Head Touch Setup Photo**

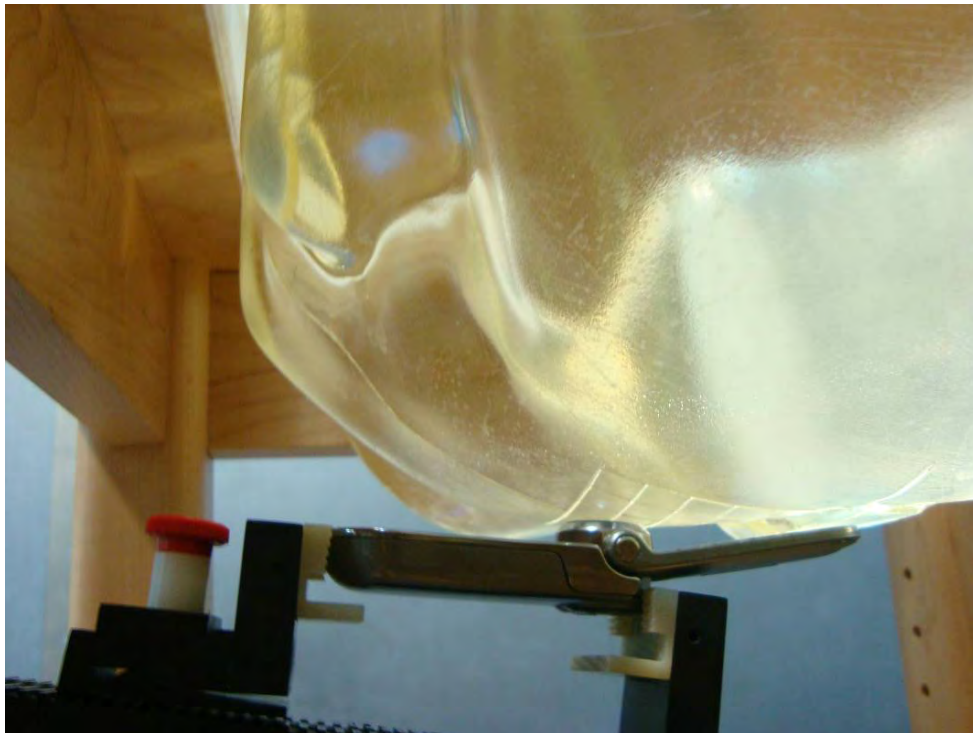

**Left Head Tilt Setup Photo**

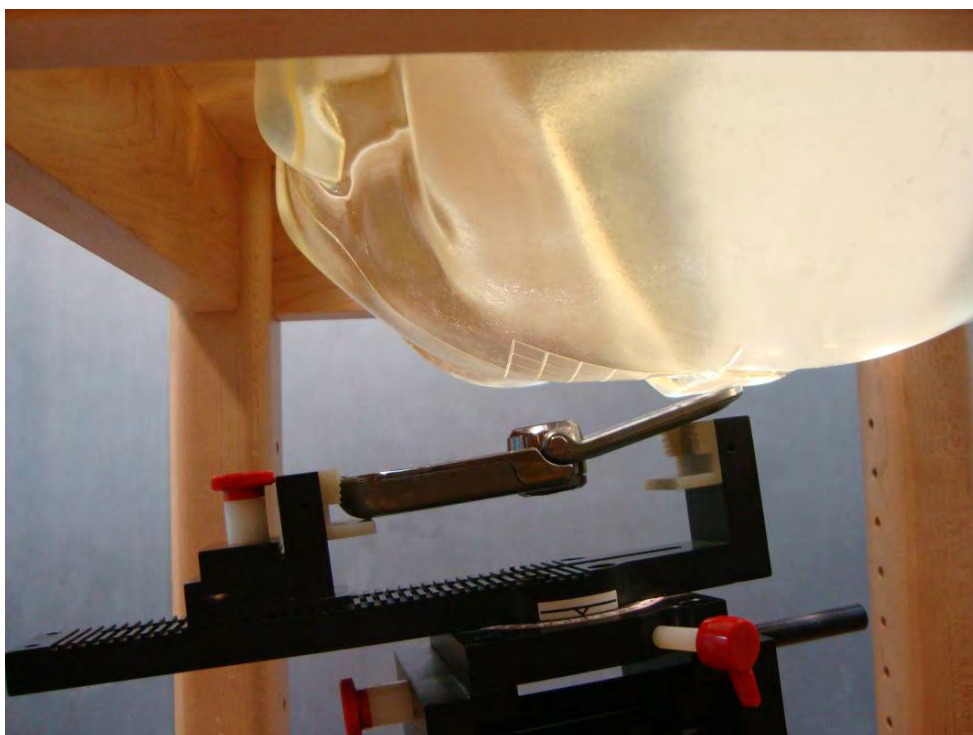

**Right Head Touch Setup Photo**



**Right Head Tilt Setup Photo**



## APPENDIX H – EUT PHOTOS

**EUT – Front Side View**



**EUT – Back Side View**



### EUT- Battery Uncover View



### EUT- Right Side View



**EUT- Bottom Side View**



**EUT – Headset Side View**



## APPENDIX I - INFORMATIVE REFERENCES

---

- [1] Federal Communications Commission, "Report and order: Guidelines for evaluating the environmental effects of radiofrequency radiation", Tech. Rep. FCC 96-326, FCC, Washington, D.C. 20554, 1996.
- [2] David L. Means Kwok Chan, Robert F. Cleveland, "Evaluating compliance with FCC guidelines for human exposure to radiofrequency electromagnetic fields", Tech. Rep., Federal Communication Commission, Office of Engineering & Technology, Washington, DC, 1997.
- [3] Thomas Schmid, Oliver Egger, and Niels Kuster, "Automated E-field scanning system for dosimetric assessments", IEEE Transactions on Microwave Theory and Techniques, vol. 44, pp. 105-113, Jan. 1996.
- [4] Niels Kuster, Ralph Kastle, and Thomas Schmid, "Dosimetric evaluation of mobile communications equipment with known precision", IEEE Transactions on Communications, vol. E80-B, no. 5, pp. 645-652, May 1997.
- [5] CENELEC, "Considerations for evaluating of human exposure to electromagnetic fields (EMFs) from mobile telecommunication equipment (MTE) in the frequency range 30MHz - 6GHz", Tech. Rep., CENELEC, European Committee for Electrotechnical Standardization, Brussels, 1997.
- [6] ANSI, ANSI/IEEE C95.1-1992: IEEE Standard for Safety Levels with Respect to Human Exposure to Radio Frequency Electromagnetic Fields, 3 kHz to 300 GHz, The Institute of Electrical and Electronics Engineers, Inc., New York, NY 10017, 1992.
- [7] Katja Pokovic, Thomas Schmid, and Niels Kuster, "Robust setup for precise calibration of E-field probes in tissue simulating liquids at mobile communications frequencies", in ICECOM '97, Dubrovnik, October 15-17, 1997, pp. 120-24.
- [8] Katja Pokovic, Thomas Schmid, and Niels Kuster, "E-field probe with improved isotropy in brain simulating liquids", in Proceedings of the ELMAR, Zadar, Croatia, 23-25 June, 1996, pp. 172-175.
- [9] Volker Hombach, Klaus Meier, Michael Burkhardt, Eberhard Kuhn, and Niels Kuster, "The dependence of EM energy absorption upon human head modeling at 900 MHz", IEEE Transactions on Microwave Theory and Techniques, vol. 44, no. 10, pp. 1865-1873, Oct. 1996.
- [10] Klaus Meier, Ralf Kastle, Volker Hombach, Roger Tay, and Niels Kuster, "The dependence of EM energy absorption upon human head modeling at 1800 MHz", IEEE Transactions on Microwave Theory and Techniques, Oct. 1997, in press.
- [11] W. Gander, Computermathematik, Birkhaeuser, Basel, 1992.
- [12] W. H. Press, S. A. Teukolsky, W. T. Vetterling, and B. P. Flannery, Numerical Recipes in C, The Art of Scientific Computing, Second Edition, Cambridge University Press, 1992. Dosimetric Evaluation of Sample device, month 1998 9
- [13] NIS81 NAMAS, "The treatment of uncertainty in EMC measurement", Tech. Rep., NAMAS Executive, National Physical Laboratory, Teddington, Middlesex, England, 1994.
- [14] Barry N. Taylor and Christ E. Kuyatt, "Guidelines for evaluating and expressing the uncertainty of NIST measurement results", Tech. Rep., National Institute of Standards and Technology, 1994. Dosimetric Evaluation of Sample device, month 1998 10.

\*\*\*\*\* END OF REPORT \*\*\*\*\*