



TEST REPORT

Report No.: SRMC2008-H024-E0016

Product Name: GSM/GPRS/EDGE Digital Mobile Phone

Product Model: i250

Applicant: verykool USA, Inc.

Manufacture: Longcheer technologyCo.ltd

Specification: FCC Part 24, Part 22, Part 2, Part 15

FCC ID: WA6I250

The State Radio Monitoring Center, Equipment Testing Division

The State Radio Spectrum Monitoring and Testing Center

No.80 Beilishi Road Xicheng District Beijing, China

Tel: 86-10-68009202 Fax: 86-10-68009205

CONTENTS

1. General information	3
1.1 Notes of the test report	3
1.2 Information about the testing laboratory	3
1.3 Applicant's details	3
1.4 Manufacturer's details	3
1.5 Application details	4
1.6 Reference specification	4
1.7 Information of EUT	4
1.7.1 General information	4
1.7.2 EUT details	5
1.7.3 Auxiliary equipment details	5
2. Test information:	6
2.1 Summary of the test results:	6
2.2 Test result	7
2.2.1 GSM850	7
2.2.1.1 RF Power Output –FCC Part2.1046	7
2.2.1.2 Effective Radiated Power-FCC Part22.913	9
2.2.1.3 Occupied Bandwidth-FCC Part2.1049	11
2.2.1.4 Spurious Emissions at antenna terminals-FCC Part2.1051/22.917	15
2.2.1.5 Band Edges Compliance- FCC Part2.1051/22.917	20
2.2.1.6 Frequency Stability-FCC Part2.1055/Part22.355	23
2.2.1.7 Radiated Spurious Emissions-FCC Part2.1053/22.917	25
2.2.1.8 Conducted Emissions-FCC Part15.107	29
2.2.1.9 Radiated Emissions -FCC Part15.109	31
2.2.1 PCS1900	33
2.2.1.1 RF Power Output –FCC Part2.1046	33
2.2.1.2 Effective Isotropic Radiated Power-FCC Part24.232	35
2.2.1.3 Occupied Bandwidth-FCC Part2.1049	37
2.2.1.4 Spurious Emissions at antenna terminals-FCC Part2.1051/24.238	41
2.2.1.5 Band Edges Compliance- FCC Part2.1051/24.238	45
2.2.1.6 Frequency Stability-FCC Part2.1055/Part24.235	48
2.2.1.7 Radiated Spurious Emissions-FCC Part2.1053/24.238	50
2.2.1.8 Conducted Emissions-FCC Part15.107	54
2.2.1.9 Radiated Emissions -FCC Part15.109	56
2.3. List of test equipments	58
Appendix	59

1. General information

1.1 Notes of the test report

The test report may only be reproduced or published in full. Reproduction or publication of extracts from the report requires the prior written permission of The State Radio Monitoring Center.

The test results relate only to individual items of the samples which have been tested.

1.2 Information about the testing laboratory

Company: The State Radio Monitoring Center, Equipment Testing Division
The State Radio Spectrum Monitoring and Testing Center
Address: No.80 Beilishi Road, Xicheng District, Beijing China
City: Beijing
Country or Region: China
Contacted person: Wang Junfeng
Tel: +86 10 68009181
Fax: +86 10 68009195
Email: Wangjf@srrc.org.cn

1.3 Applicant's details

Company: verykool USA, Inc.
Address: 4350 Executive Drive. Suite 100, San Diego, CA 92121,
USA
City: San Diego
Country or Region: USA
Grantee Code: WA6
Contacted person: Sunny Choi
Tel: +1-858-373-1600 / +1-858-2489036
Fax: +1-858-373-1505
Email: sunny.choi@infosonics.com

1.4 Manufacturer's details

Company: Longcheer technologyCo.ltd
Address: Building NO.401 Caobao RD ,Xuhui District Shanghai,
200233, P.R.China
City: Shanghai
Country or Region: P.R.China
Grantee Code: WA6
Contacted person: Wang Lei
Tel: 021-64088898-4116
Fax: 021-54970876
Email: wangleilc@longcheer.net

1.5 Application details

Date of receipt of application: 5th May. 2008
Date of receipt of test sample: 5th May. 2008
Date of test: 9th May. 2008 to 23rd May. 2008

1.6 Reference specification

FCC Part 24, Part22, Part 2, Part 15

1.7 Information of EUT

1.7.1 General information

Name of EUT	GSM/GPRS/EDGE Digital Mobile Phone
FCC ID	WA6I250
Frequency range	GSM850: Tx:824~849MHz Rx:869~894MHz PCS1900: Tx:1850~1910MHz Rx:1930~1990MHz
Rated output power	GSM850:33.0dBm PCS1900:30.0dBm
Modulation type	GMSK/8PSK
Duplex mode	FDD
Duplex spacing:	GSM850:45MHz PCS1900:80MHz
Antenna type	Integral
Power Supply	Battery or charger
Rated Power Supply Voltage	3.7V
Extreme Temperature	-30°C~+50°C

1.7.2 EUT details

Name	Model	IMEI
GSM/GPRS/EDGE Digital Mobile Phone	i250	135790246811220

1.7.3 Auxiliary equipment details

Equipment	Charger
Manufacturer	Something high electronic(Xiameng) Co,Ltd
Model Number	AC/DC P-032B

Equipment	Battery
Manufacturer	Shenzhen bak battery CO.LTD
Model Number	AD381
Capacity	-----
Rated Voltage	3.7V

2. Test information:

2.1 Summary of the test results:

No.	Test case	FCC reference	Verdict
1	RF Power Output	2.1046	Pass
2	Effective Isotropic Radiated Power	22.913/24.232	Pass
3	Occupied Bandwidth,	2.1049	Pass
4	Spurious Emissions at antenna terminals	2.1051/22.917/24.238	Pass
5	Band Edges Compliance	2.1051/22.917/24.238	Pass
6	Frequency Stability	2.1055/24.235/22.355	Pass
7	Radiated Spurious Emissions	2.1053/22.917/24.238	Pass
8	Conducted emissions	15.107	Pass
9	Radiated emissions	15.109	Pass

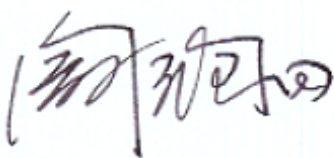
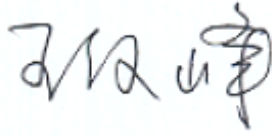
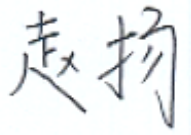
This Test Report Is Issued by: 	Checked by: 
Tested by: 	Issued date: 2008.6.6

2.2 Test result

2.2.1 GSM850

2.2.1.1 RF Power Output –FCC Part2.1046

Ambient condition:

Temperature	Relative humidity	Pressure
20°C	54%	100.5kPa

Test Setup:

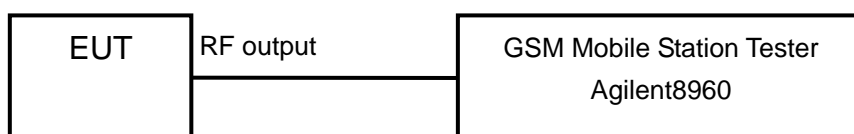

Test procedure:

After a radio link has been established between EUT and Tester, the output power of the cell signal of the testing equipment will be decreased until the output power of the EUT reach a maximum value. Then the test data can be read at the tester screen. The loss between RF output port of the EUT and the input port of the tester will be taken into consideration.

The measurement will be conducted at three channels No128, No189 and No251 (Bottom, middle and top channels of GSM850 band)

Limits	$\leq 33\text{dBm}$
--------	---------------------

Test result:

GSM/GPRS MODE:

Carrier frequency (MHz)	Channel No.	RF Power Output (dBm)
824.2	128	32.0
836.4	189	32.5
848.8	251	32.9

EDGE MODE:

Carrier frequency (MHz)	Channel No.	RF Power Output (dBm)
824.2	128	27.6
836.4	189	27.9
848.8	251	28.0

2.2.1.2 Effective Radiated Power-FCC Part22.913

Ambient condition:

Temperature	Relative humidity	Pressure
20°C	54%	100.5kPa

Test setup

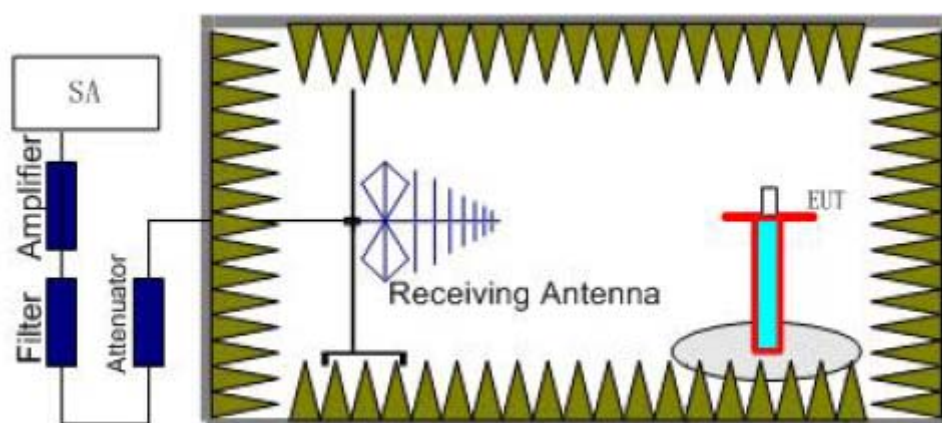

Step 1

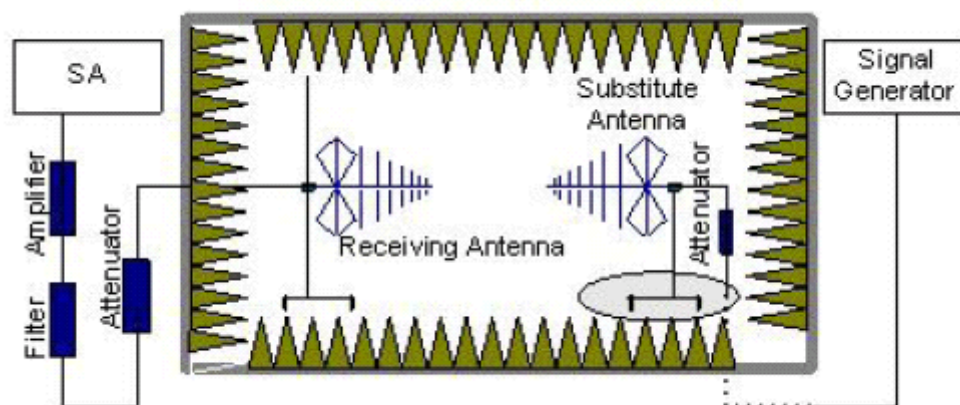

Step 2

Test procedure:

Step 1:

The measurement is carried out in the fully anechoic chamber. EUT was placed on a 2.4 meters high non-conductive table at a 3 meters test distance from the test receive antenna. A receiving antenna was placed on the antenna mast 3 meters from the EUT. The height of receiving antenna is 2.4m and varies in certain range to find the maximum power value. A radio link shall be established between EUT and Tester. The output power of the cell signal of

the tester will be decreased until the output power of the EUT reach a maximum value. A RMS detector is used and RBW is set to 3MHz. Then the antenna height and turn table rotation is adjusted till the maximum power value is founded on spectrum analyzer or receiver.

Step 2:

A log-periodic antenna or double-ridged waveguide horn antenna shall be substituted in place of the EUT. The log-periodic antenna will be driven by a signal generator. To repeat the same procedure as step1 and the level of signal generator will be adjusted till the same power value on the spectrum analyzer or receiver. The ERP/EIRP of the EUT can be calculated through the level of the signal generator, cable loss, the gain of the substitution antenna and the reading of the spectrum analyzer or receiver.

The measurement will be conducted at three channels No128, No189 and No251 (Bottom, middle and top channels of GSM850 band)

Limits	≤ 38.5dBm
--------	-----------

Test result:

GSM/GPRS MODE:

Carrier frequency (MHz)	Channel No.	E.R.P. (dBm)
824.2	128	29.6
836.4	189	29.2
848.8	251	29.6

EDGE MODE:

Carrier frequency (MHz)	Channel No.	E.R.P. (dBm)
824.2	128	16.8
836.4	189	12.0
848.8	251	10.3

2.2.1.3 Occupied Bandwidth-FCC Part2.1049

Ambient condition:

Temperature	Relative humidity	Pressure
20°C	54%	100.5kPa

Test Setup:

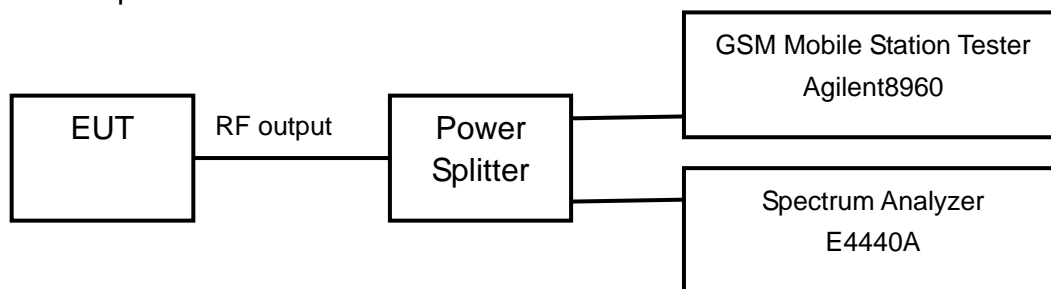

Test procedure:

After a radio link has been established between EUT and Tester, the output power of the cell signal of the testing equipment will be decreased until the output power of the EUT reach a maximum value. The occupied bandwidth is measured using spectrum analyzer. RBW is set to 3kHz on spectrum analyzer. The bandwidth of 99% power can be read on spectrum analyzer. The measurement will be conducted at three channels No128, No189 and No251 (Bottom, middle and top channels of GSM850 band)

Limits: No specific occupied bandwidth requirements in part 2.1049

Test result:

GSM/GPRS MODE:

Carrier frequency (MHz)	Channel No.	Bandwidth of 99% Power (kHz)
824.2	128	245.8
836.4	189	244.3
848.8	251	245.7

EDGE MODE:

Carrier frequency (MHz)	Channel No.	Bandwidth of 99% Power (kHz)
824.2	128	241.3
836.4	189	240.2
848.8	251	239.5

GSM/GPRS MODE:

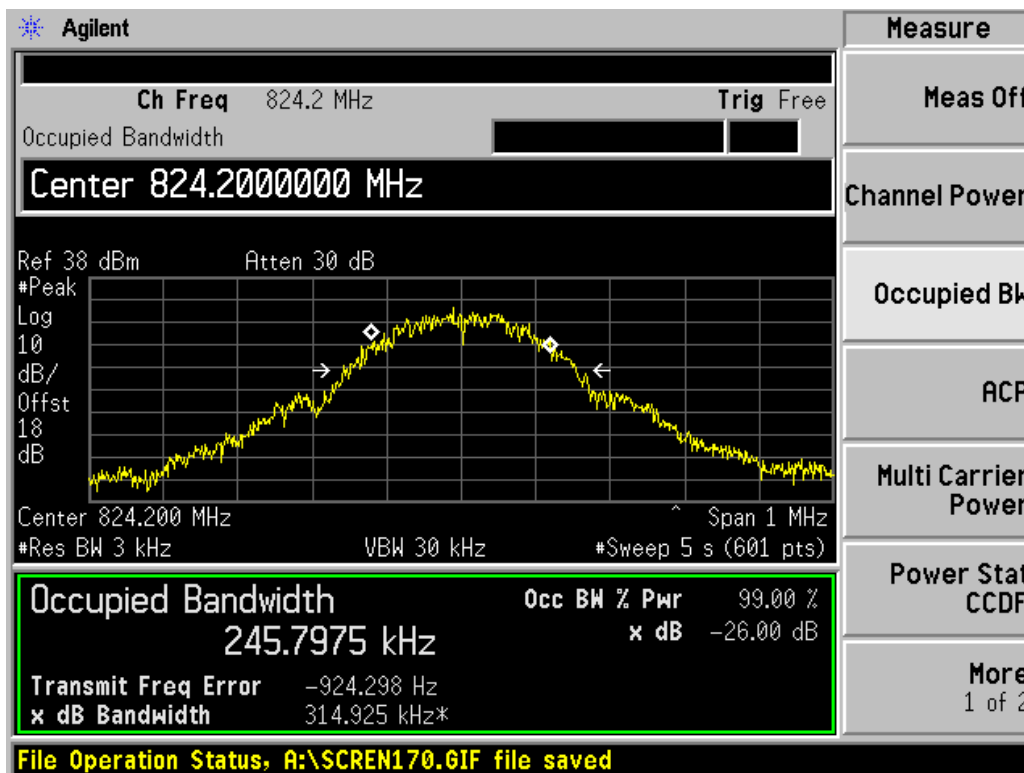

Channel 128

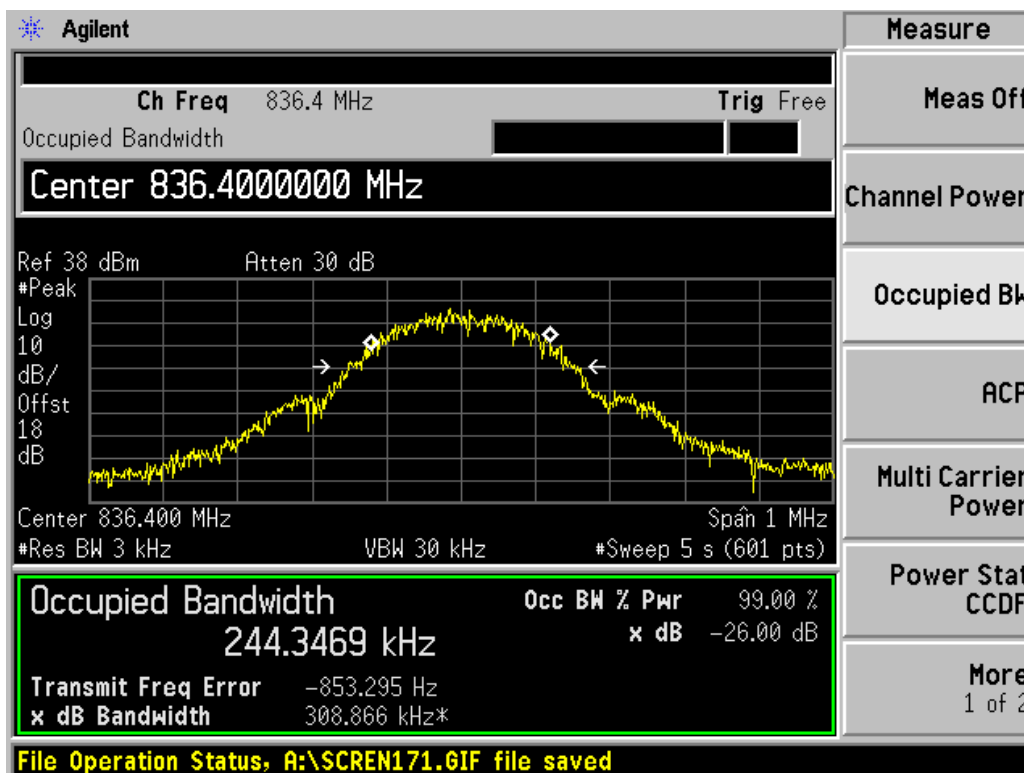

Channel 189

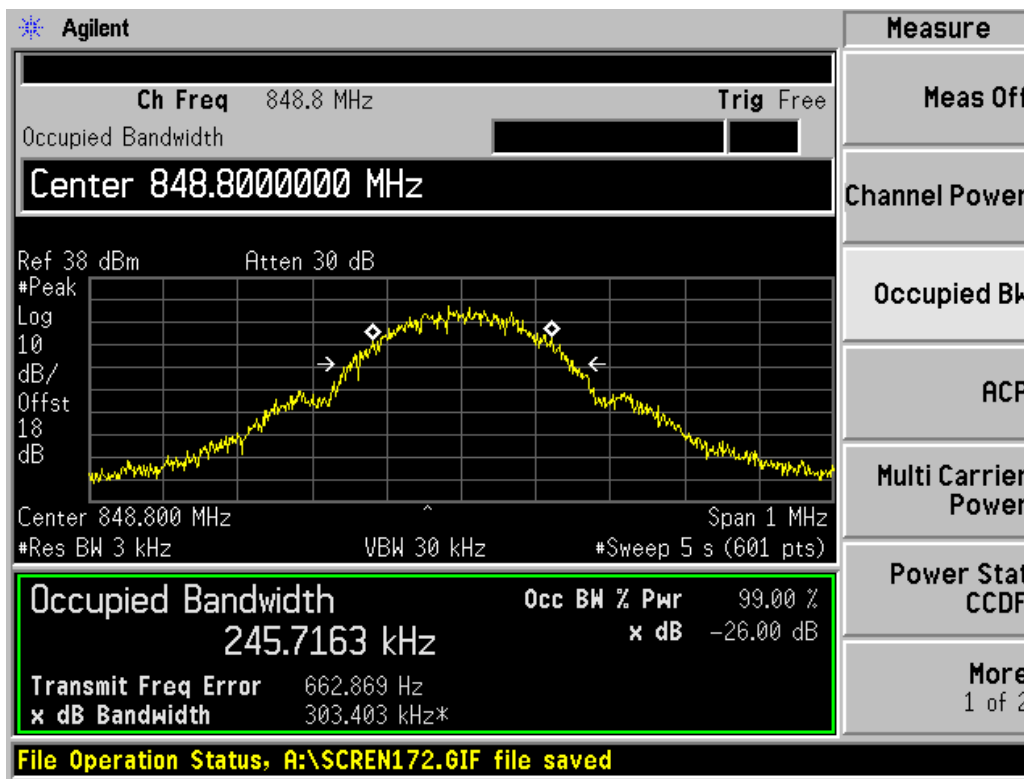

Channel 251

EDGE MODE:

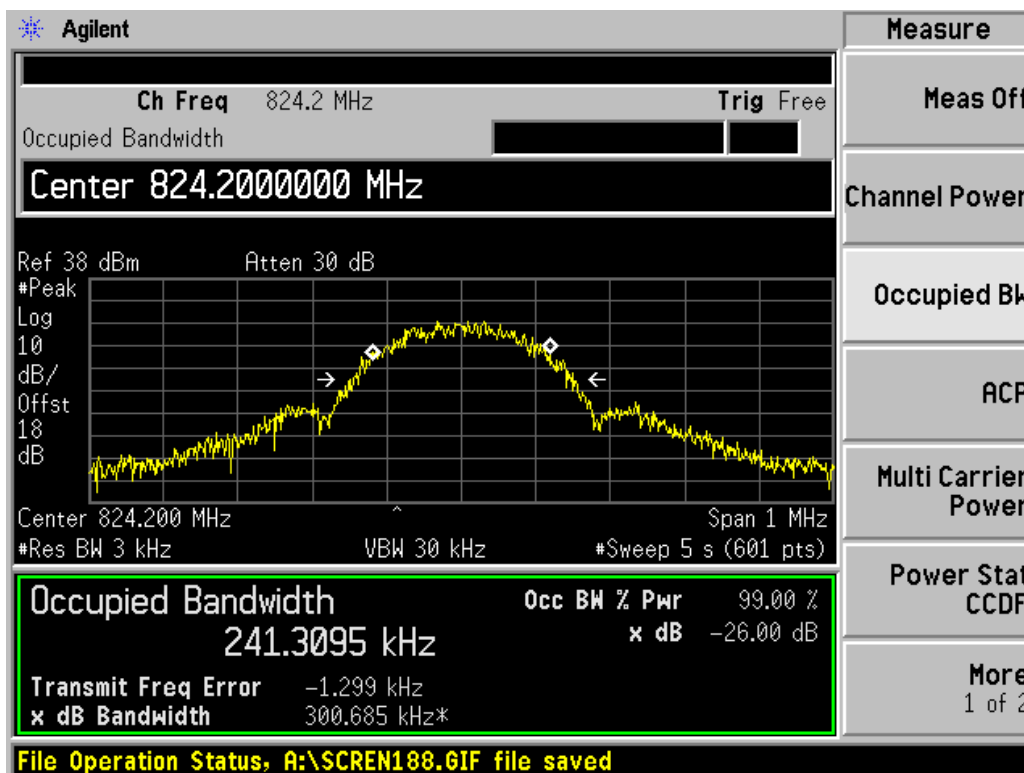

Channel 128

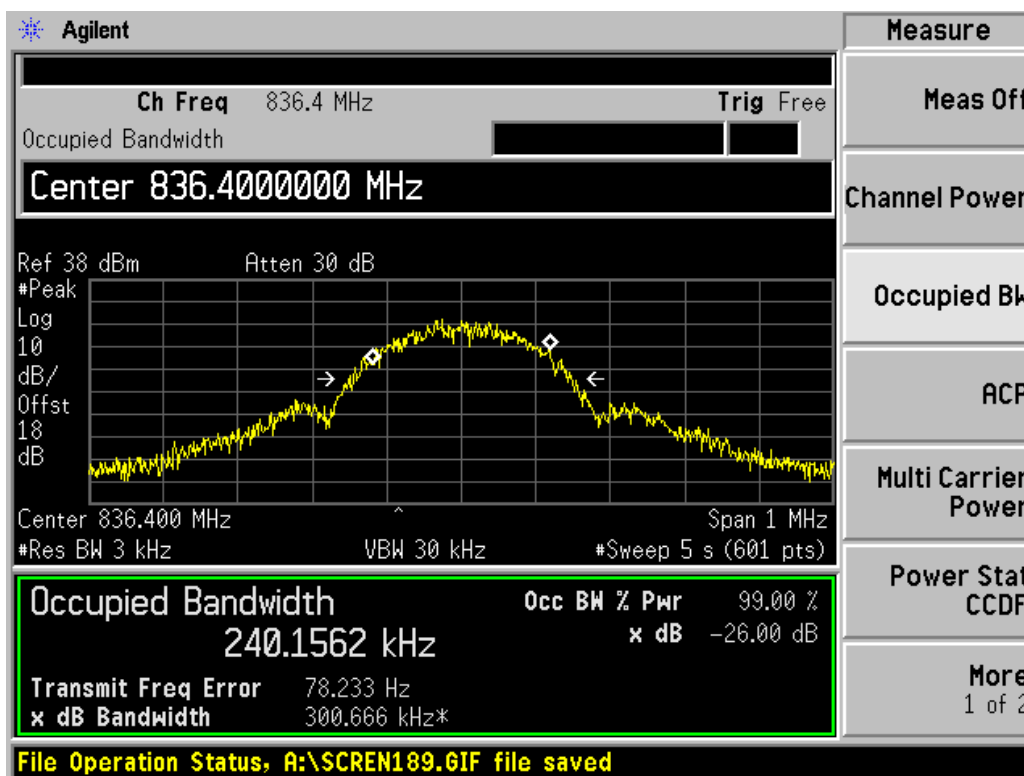

Channel 189

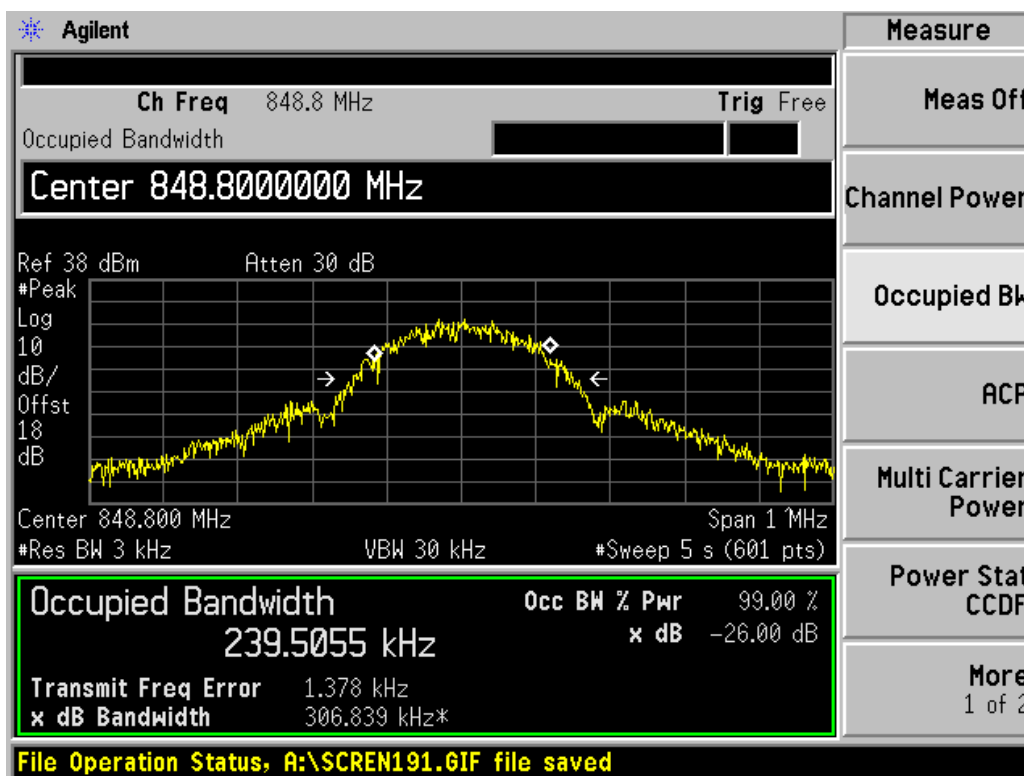

Channel 251

2.2.1.4 Spurious Emissions at antenna terminals-FCC Part2.1051/22.917

Ambient condition:

Temperature	Relative humidity	Pressure
20°C	54%	100.5kPa

Test Setup:

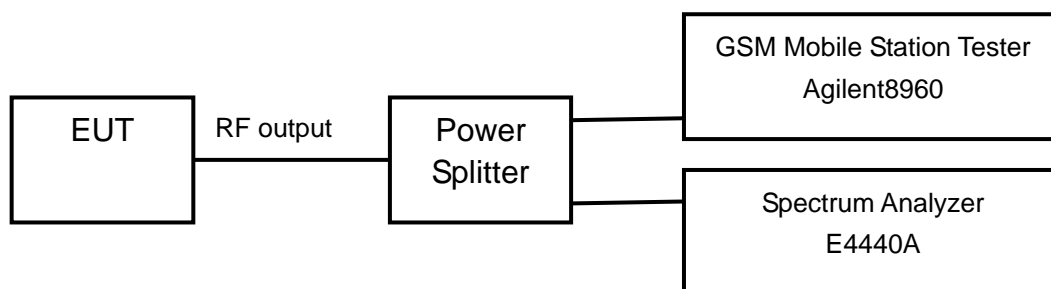

Test procedure:

After a radio link has been established between EUT and Tester, the output power of the cell signal of the testing equipment will be decreased until the output power of the EUT reach a maximum value. The measurement is carried out using a spectrum analyzer. The spectrum analyzer scans from 30MHz to 20GHz (higher than the 10th harmonic of the carrier). The peak detector is used and RBW is set to 1MHz on spectrum analyzer. The measurement will be conducted at one channel No189 (middle channel of GSM850 band)

Limits	≤ -13dBm
--------	----------

Test result:

Refer to the following figures.

GSM/GPRS MODE:

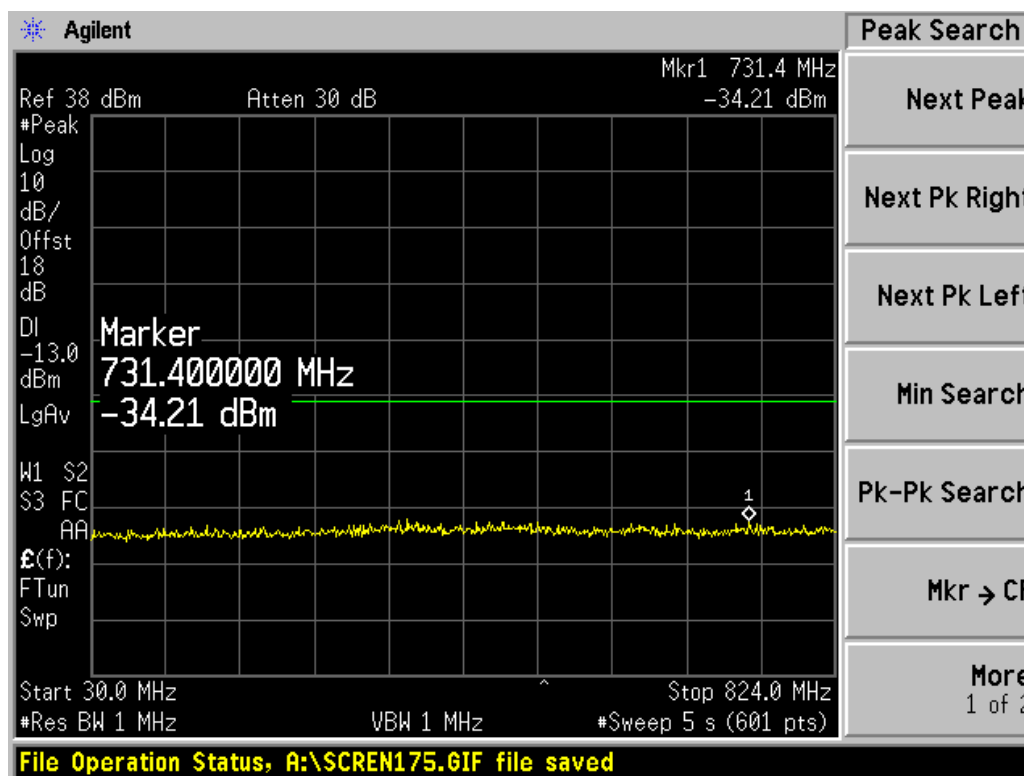

Channel 189, 30MHz~824MHz

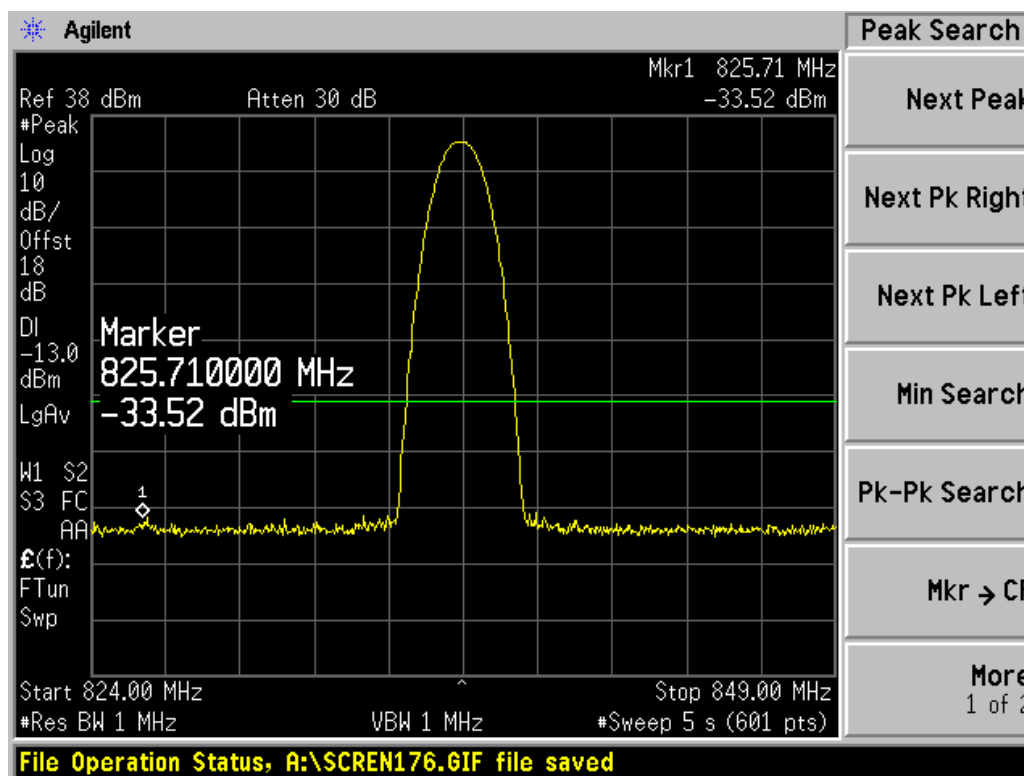

Channel 189, 824MHz~849MHz

Note: The signal beyond the limit is the base station simulator carrier.

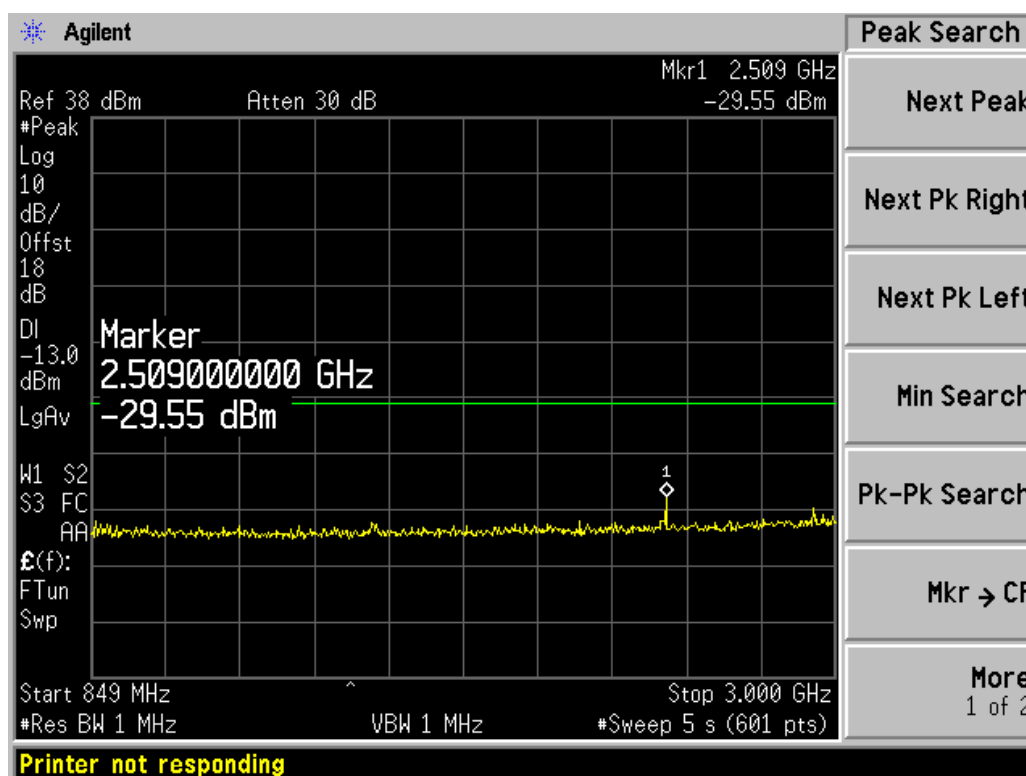

Channel 189, 849MHz~3GHz

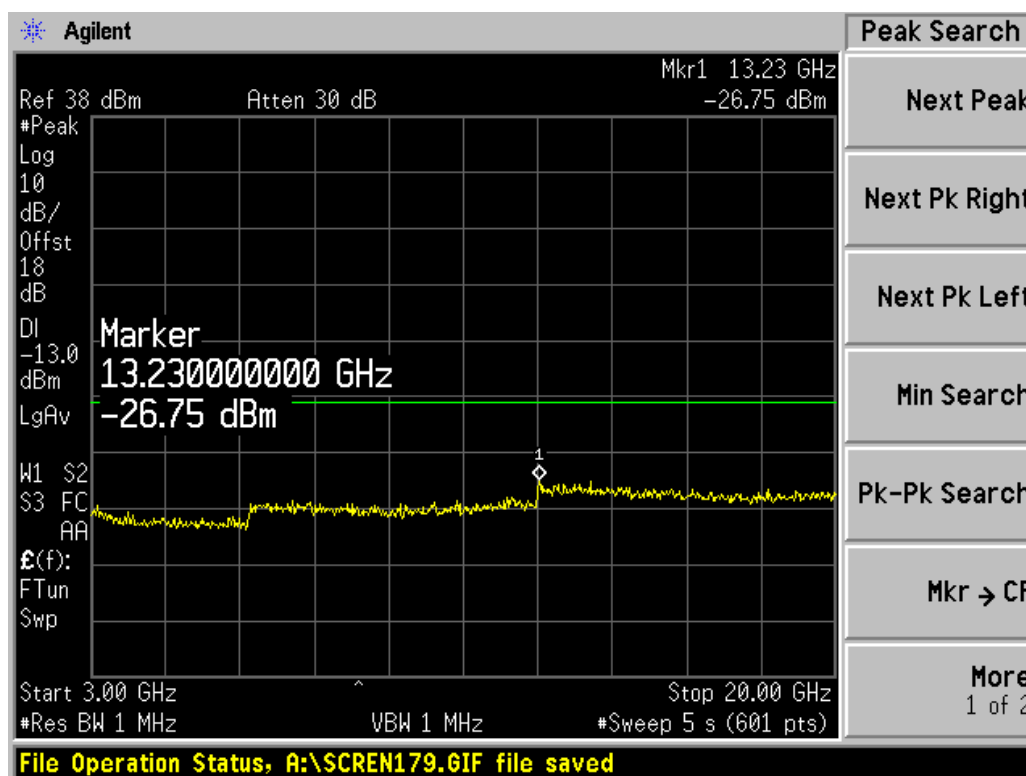

Channel 189, 3GHz ~20 GHz

EDGE MODE:

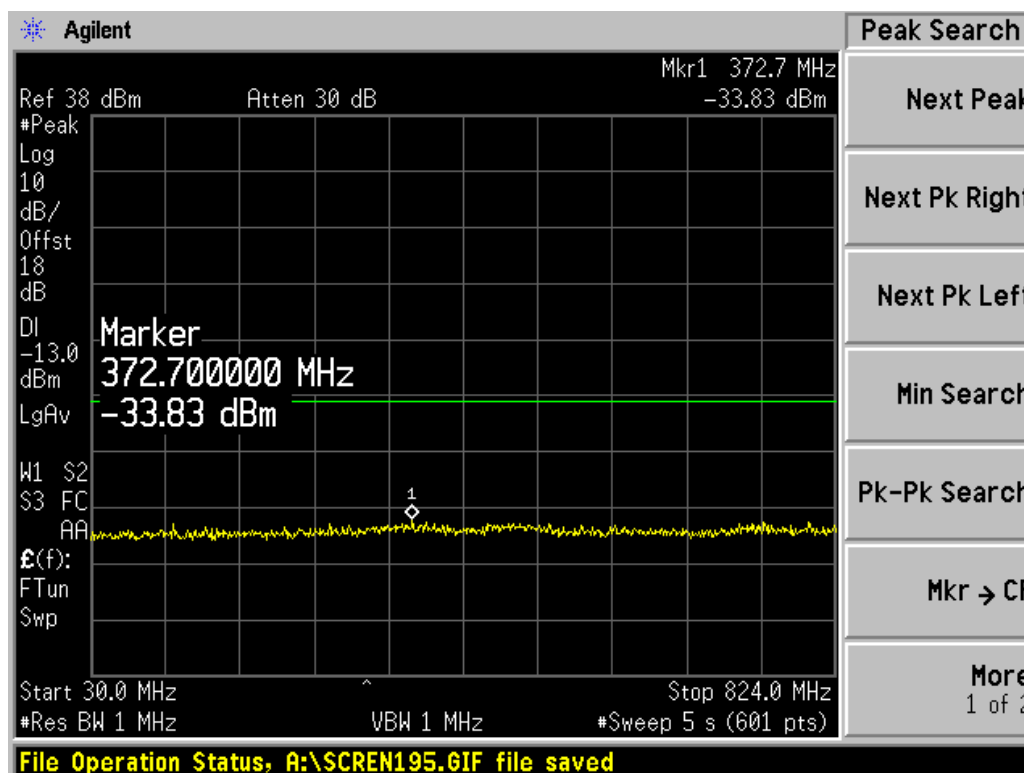

Channel 189, 30MHz~824MHz

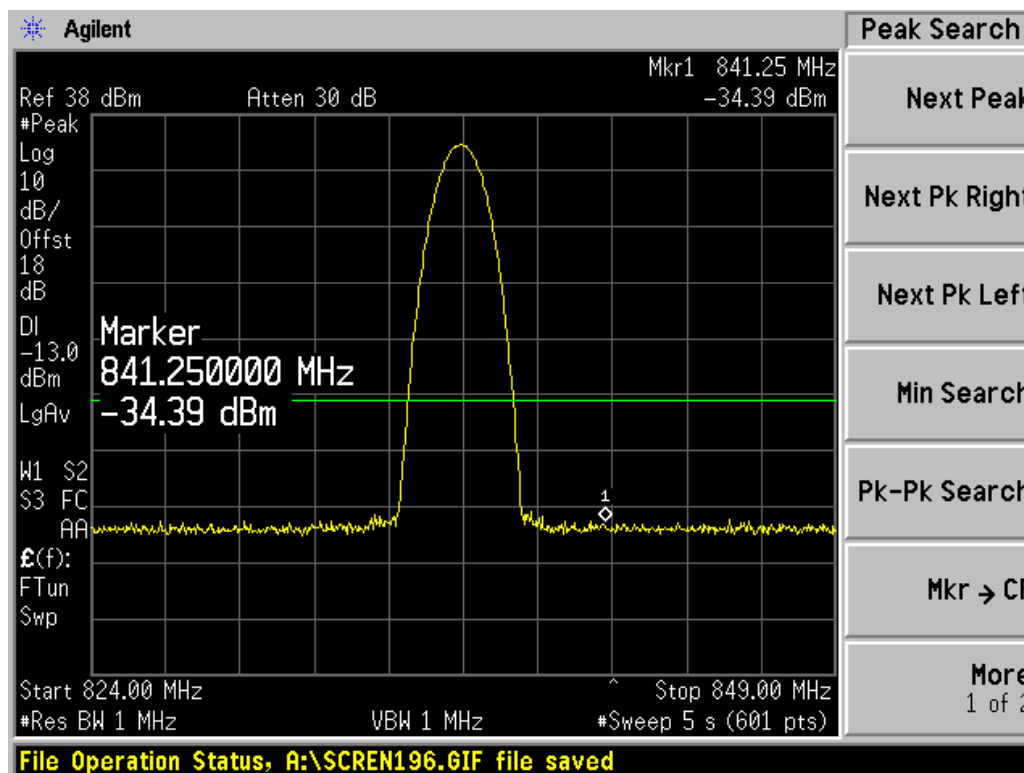

Channel 189, 824MHz~849MHz

Note: The signal beyond the limit is the base station simulator carrier.

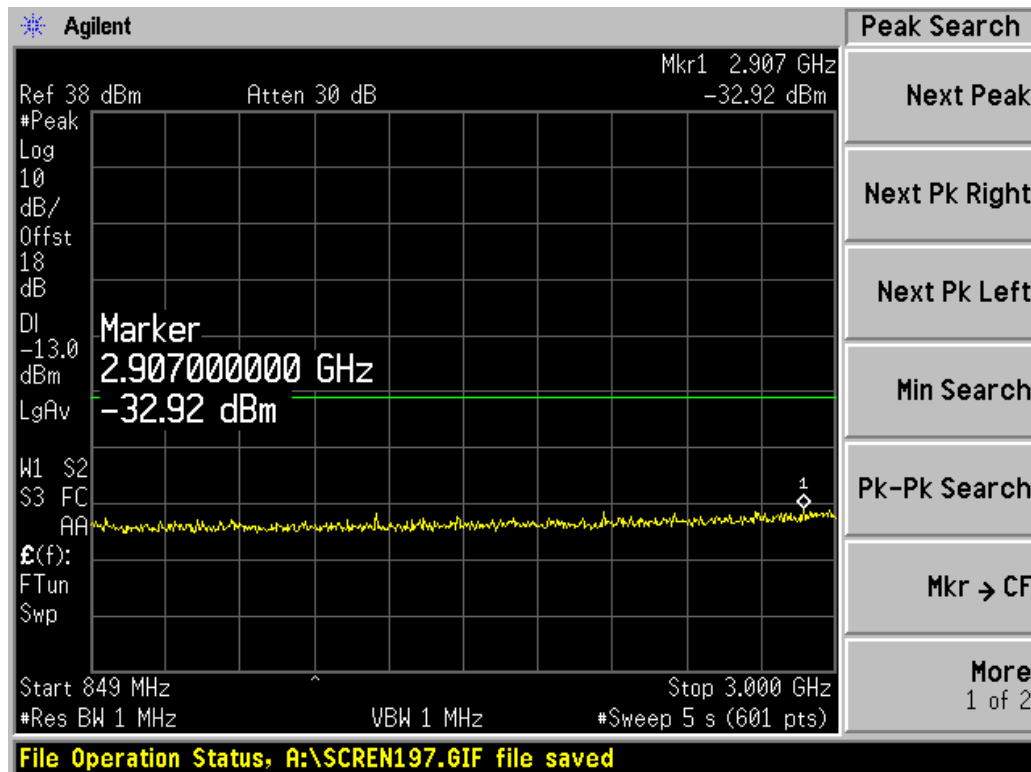

Channel 189, 849MHz~3GHz

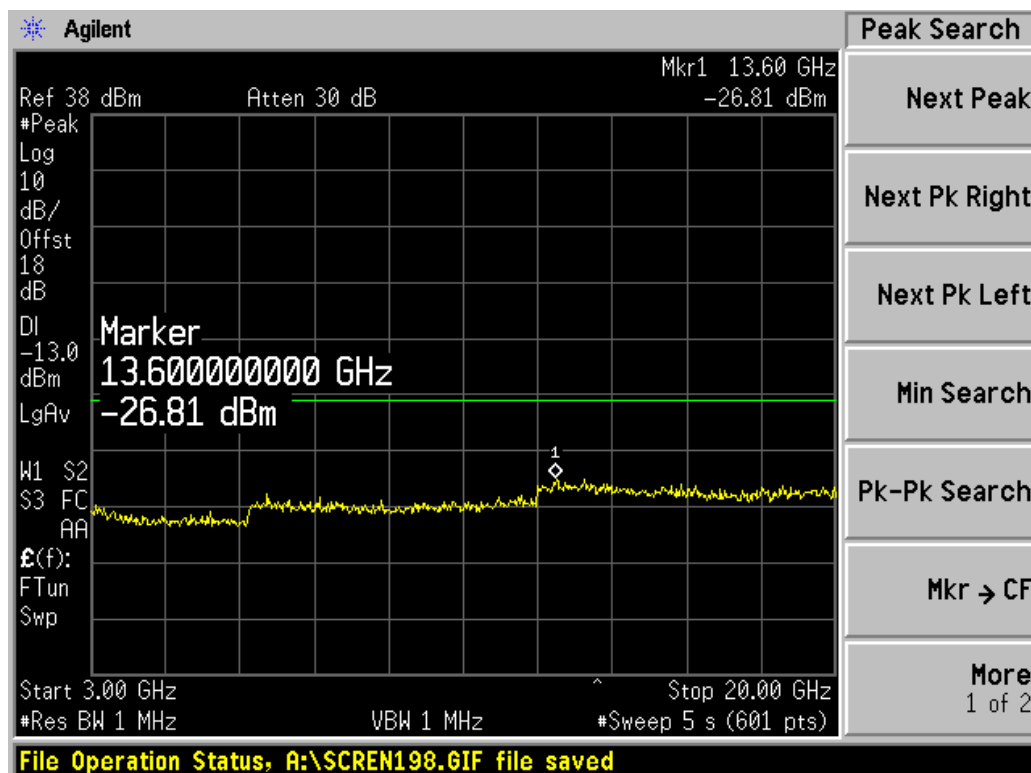

Channel 189, 3GHz ~20 GHz

2.2.1.5 Band Edges Compliance- FCC Part2.1051/22.917

Ambient condition:

Temperature	Relative humidity	Pressure
20°C	54%	100.5kPa

Test Setup:

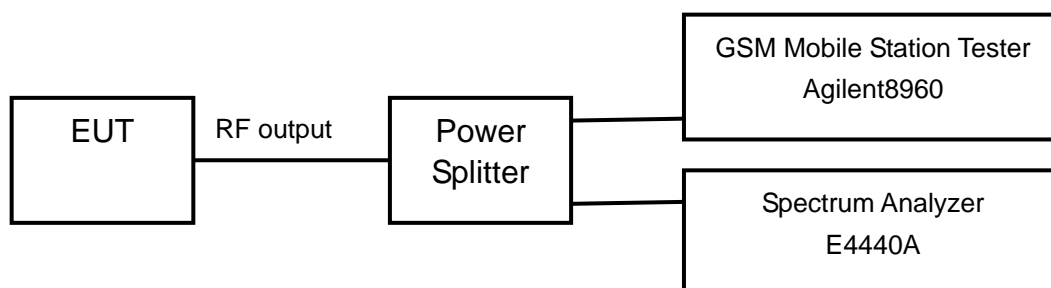

Test procedure:

After a radio link has been established between EUT and Tester, the output power of the cell signal of the testing equipment will be decreased until the output power of the EUT reach a maximum value. The measurement is carried out using a spectrum analyzer. The peak detector is used and RBW is set to 3KHz on spectrum analyzer.

The measurement will be conducted at two channels No128 and No251 (Bottom and top channels of GSM850 band)

Limits	≤ -13dBm
--------	----------

Test result:

Refer to the following figures.

GSM/GPRS MODE:

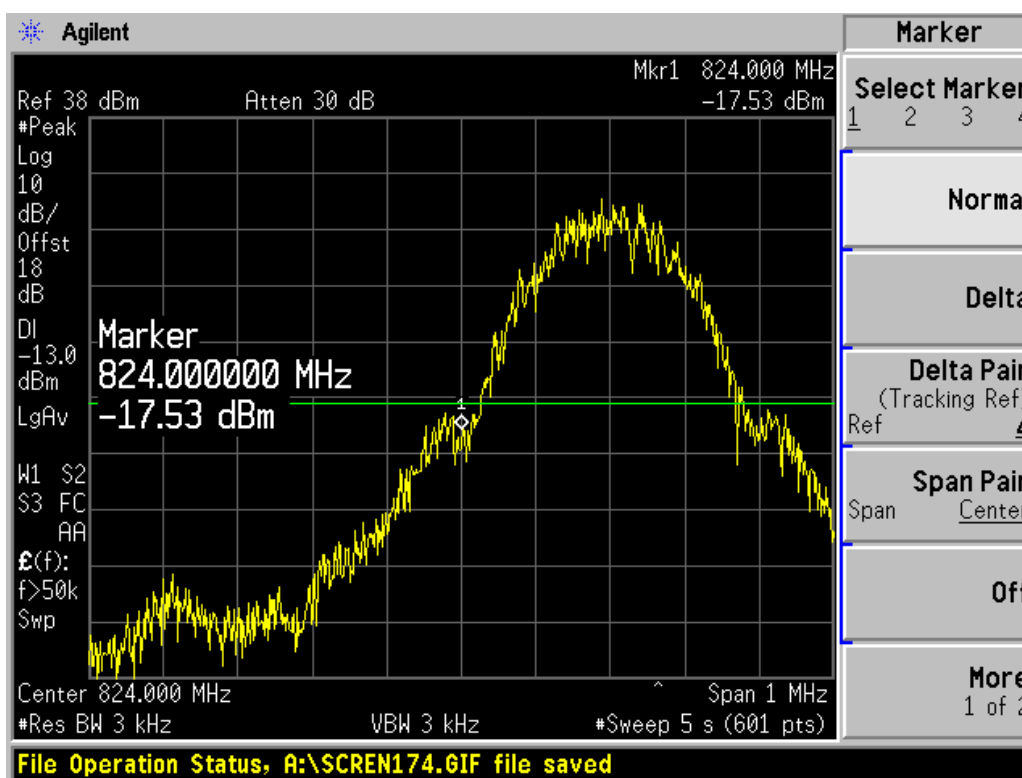

Channel 128

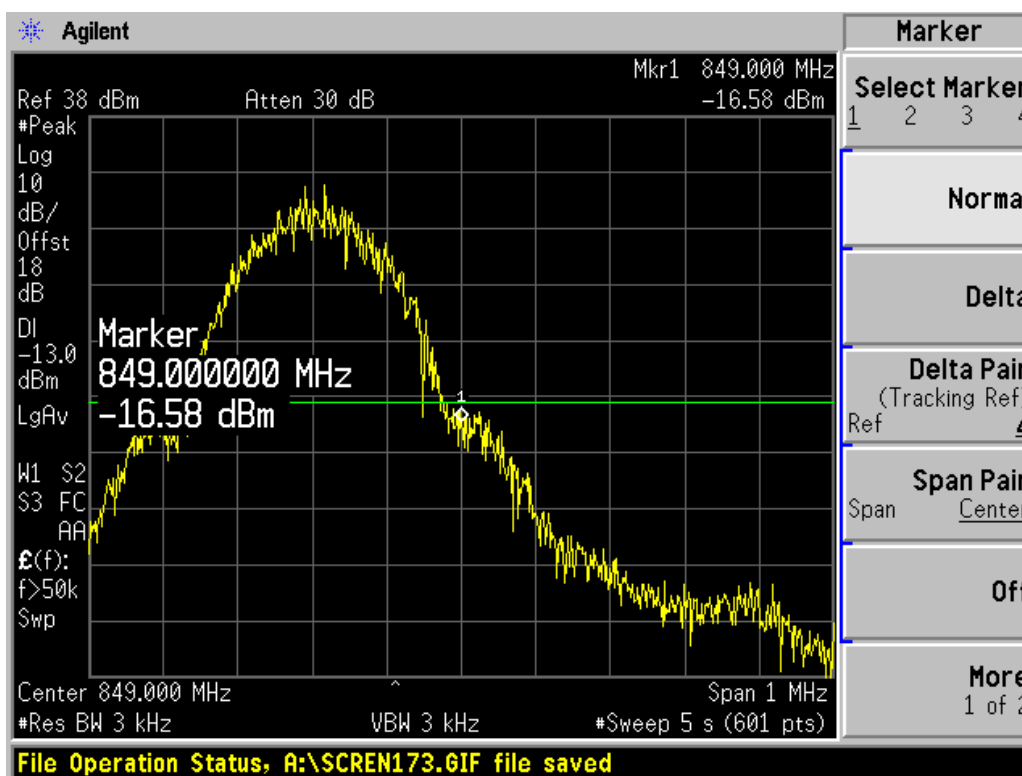

Channel 251

EDGE MODE:

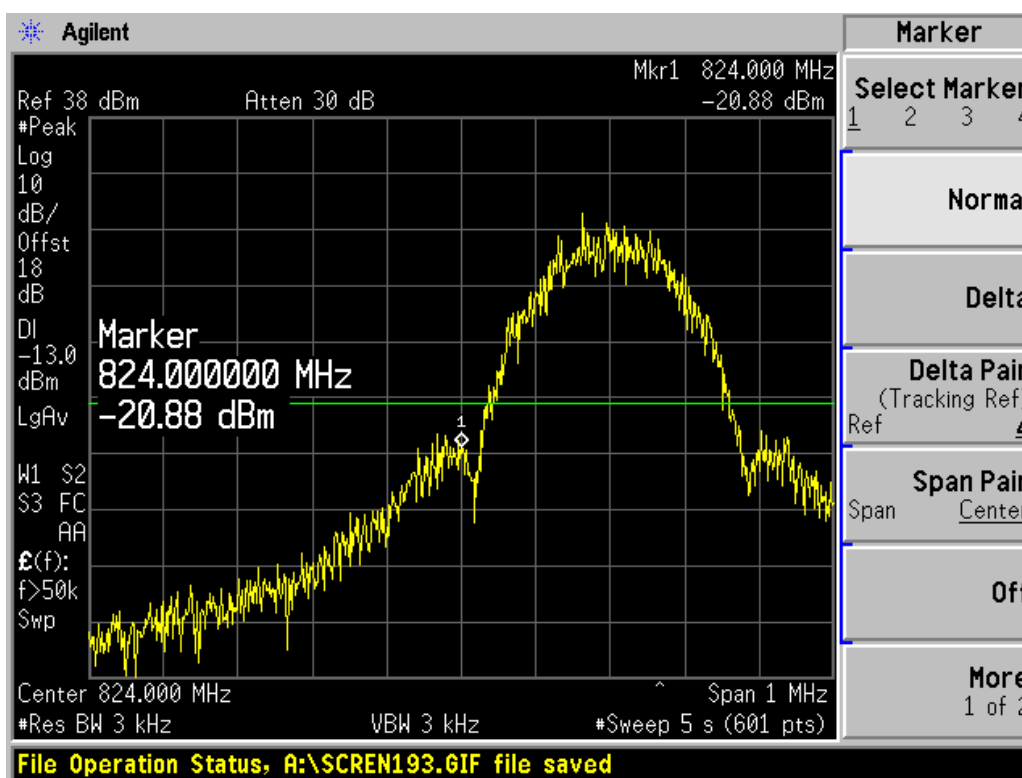

Channel 128

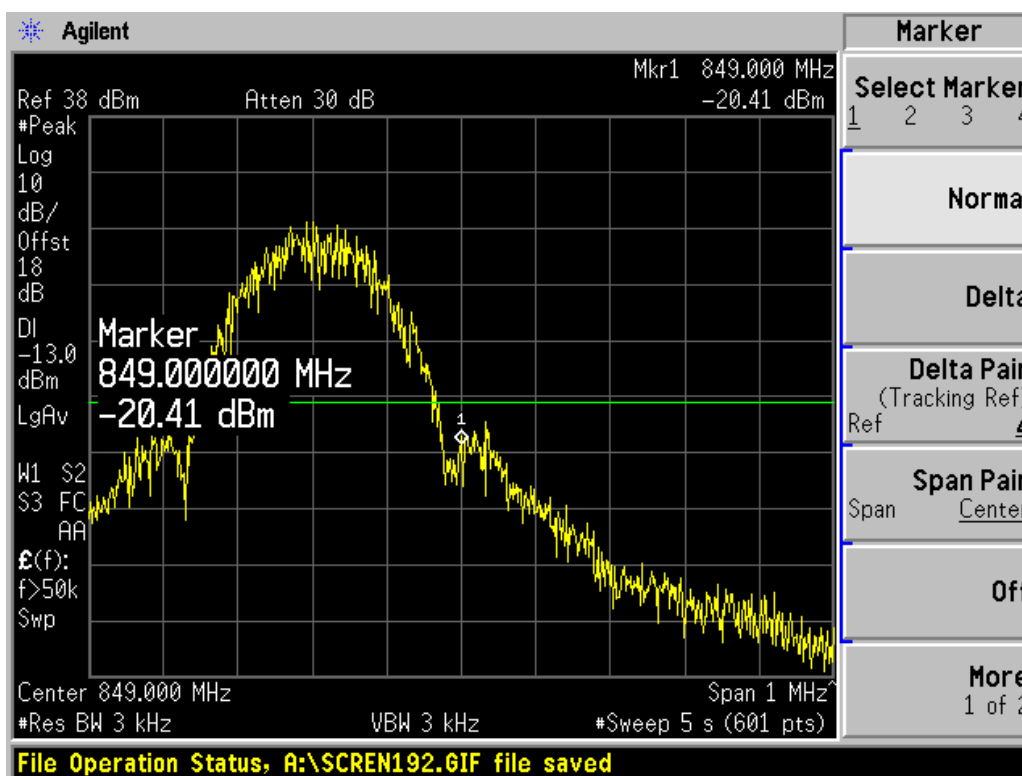

Channel 251

2.2.1.6 Frequency Stability-FCC Part2.1055/Part22.355

Ambient condition:

Temperature	Relative humidity	Pressure
20°C	54%	100.5kPa

Test setup:

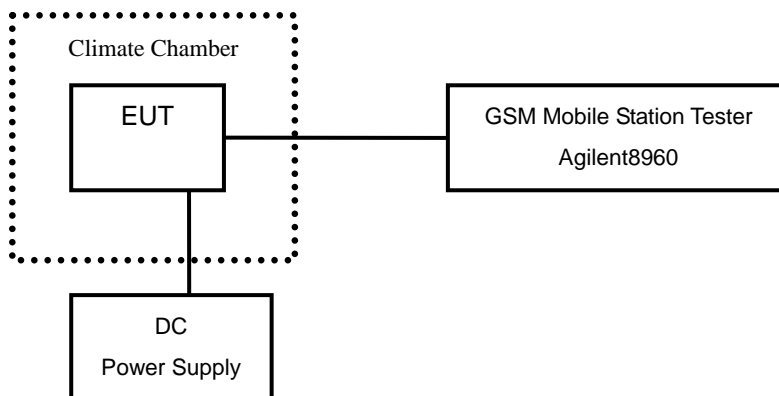

Test Procedure:

A radio link shall be established between EUT and Tester. The tester will sample the transmitter RF output signal and measure its frequency. The temperature inside the climate chamber is varied from -30 to +50° C in 10° C step size, and also the DC power supply voltage to the EUT is varied from 3.4 to 4.2 V.

Limits: No specific frequency stability requirements in part 2.1055 and part 22.355

Test Result:

GSM/GPRS MODE:

Temperature(° C)	Test Result (ppm)		
	Channel 128	Channel 189	Channel 251
-30	---	0.003	---
-20	---	0.019	---
-10	---	0.037	---
0	---	0.008	---
+10	---	0.007	---
+20	---	0.006	---
+30	---	0.010	---
+40	---	0.009	---
+50	---	0.005	---

Voltage (V)	Test Result (ppm)		
	Channel 128	Channel 189	Channel 251
3.4	---	0.009	---
4.2	---	0.016	---

EDGE MODE:

Temperature(° C)	Test Result (ppm)		
	Channel 128	Channel 189	Channel 251
-30	---	0.052	---
-20	---	0.028	---
-10	---	0.008	---
0	---	0.002	---
+10	---	0.003	---
+20	---	0.013	---
+30	---	0.020	---
+40	---	0.009	---
+50	---	0.008	---

Voltage (V)	Test Result (ppm)		
	Channel 128	Channel 189	Channel 251
3.4	---	0.003	---
4.2	---	0.006	---

2.2.1.7 Radiated Spurious Emissions-FCC Part2.1053/22.917

Ambient condition

Temperature	Relative humidity	Pressure
20°C	54%	100.5kPa

Test Setup:

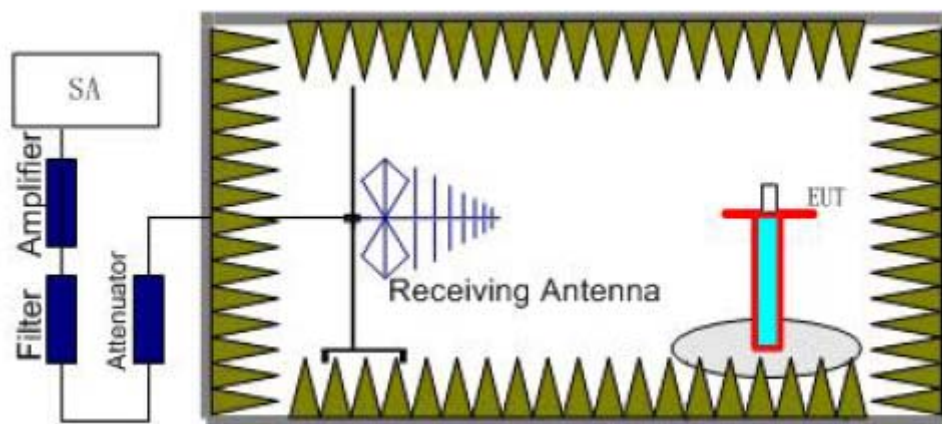

Step 1

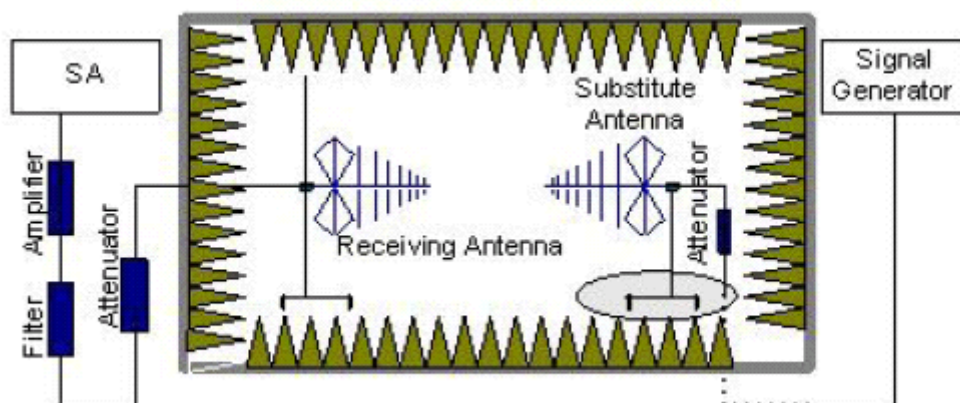

Step 2

Test procedure:

Step 1:

The measurement is carried out in the fully anechoic chamber. EUT was placed on a 2.4 meter high non-conductive table at a 3 meter test distance from the test receive antenna. A receiving antenna was placed on the antenna mast 3 meters from the EUT. The height of receiving antenna is 2.4m and

varies in certain range to find the maximum power value. A radio link shall be established between EUT and Tester. The output power of the cell signal of the tester will be decreased until the output power of the EUT reach a maximum value. The measurement is carried out using a spectrum analyzer or receiver. The spectrum analyzer scans from 30MHz to 20GHz (higher than the 10th harmonic of the carrier). The peak detector is used and RBW is set to 1MHz on spectrum analyzer. Then the antenna height and turn table rotation is adjusted till the maximum power value is founded on spectrum analyzer or receiver. A notch filter is necessary in the band near to the carrier frequency. A high pass filter is needed to avoid the distortion of the testing equipment in the band above the carrier frequency.

Step 2:

A log-periodic antenna or double-ridged waveguide horn antenna shall be substituted in place of the EUT. The log-periodic antenna will be driven by a signal generator and the level will be adjusted till the same power value on the spectrum analyzer or receiver. The level of the spurious emissions can be calculated through the level of the signal generator, cable loss, the gain of the substitution antenna and the reading of the spectrum analyzer or receiver.

Calculation procedure:

The data of cable loss, antenna gain and air loss has been calibrated in full testing frequency range before the testing.

The power of the Radiated Spurious Emissions is calculated by adding the cable loss, antenna gain and air loss. The basic equation with a sample calculation is as followed:

$$P = P_R + L_C + L_A - G$$

Where

P: Power of the Radiated Spurious Emissions (dBm)

P_R: reading of the receiver (dBm)

L_C: Cable Lose (dB)

L_A: Air loss (dB)

G: Antenna Gain (dBi)

Assumed the reading of the receiver is -60dBm. A cable lose of 10dB, an air lose of 30dB and an antenna gain of 11dBi are added.

$$P = P_R + L_C + L_A - G = -60 + 10 + 30 - 11 = -31 \text{ dBm}$$

The measurement will be conducted at one channel No189 (middle channels of GSM850 band)

Limits	≤ -13dBm
--------	----------

Test result:

Refer to the following figures.

GSM/GPRS MODE:

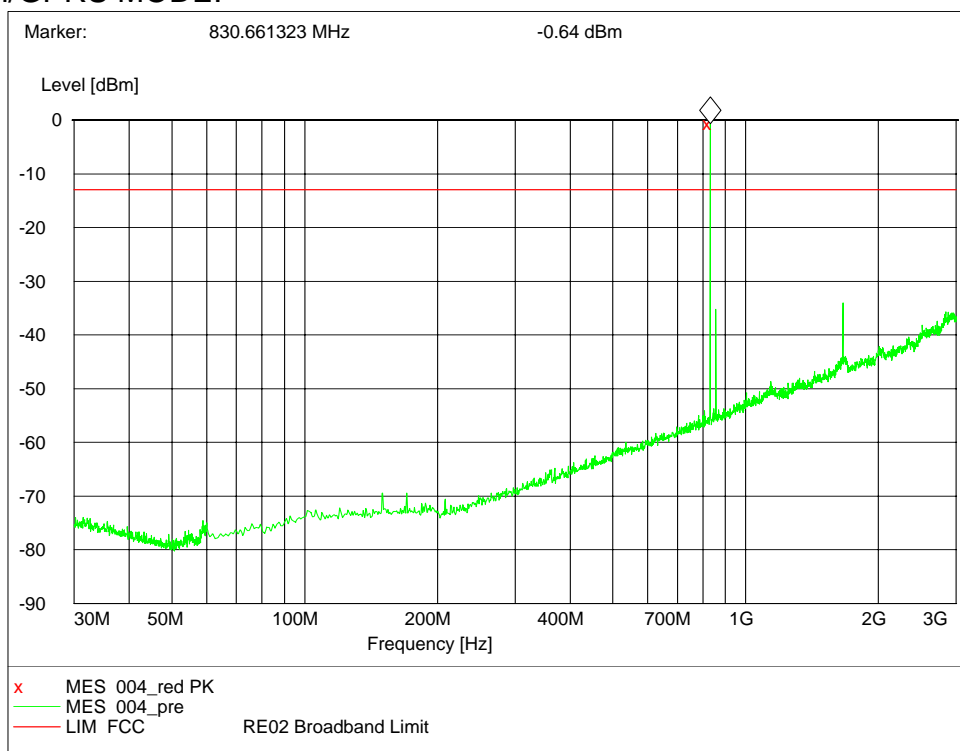

Channel 189, 30MHz~3GHz (Traffic Mode)

Note: The signal beyond the limit is the base station simulator carrier.

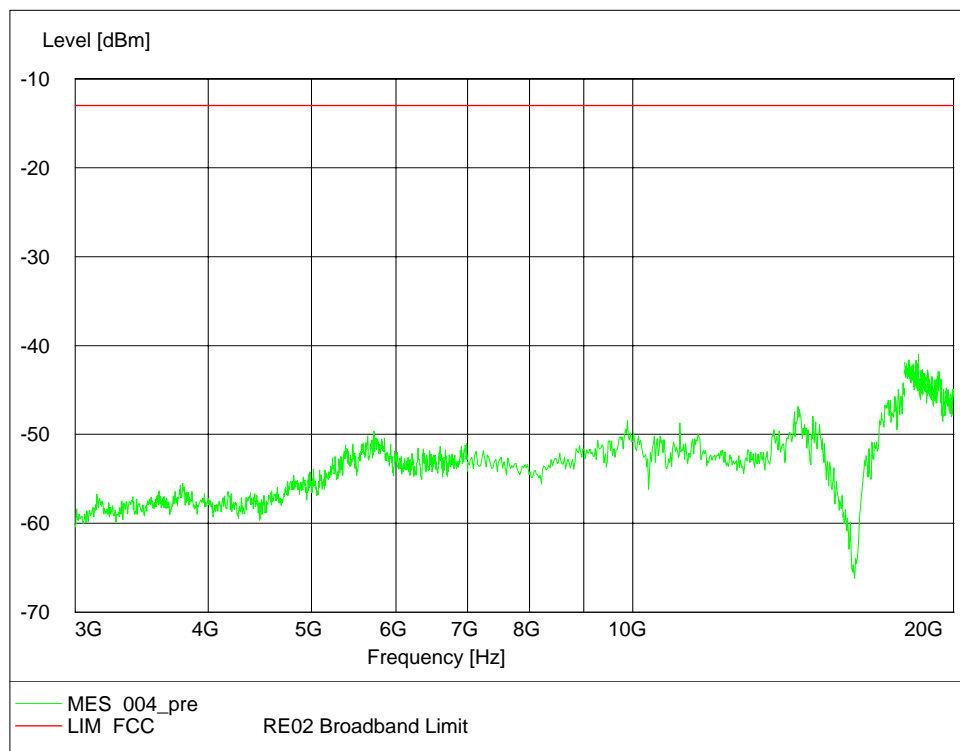

Channel 189, 3GHz~20GHz (Traffic Mode)

EDGE MODE:

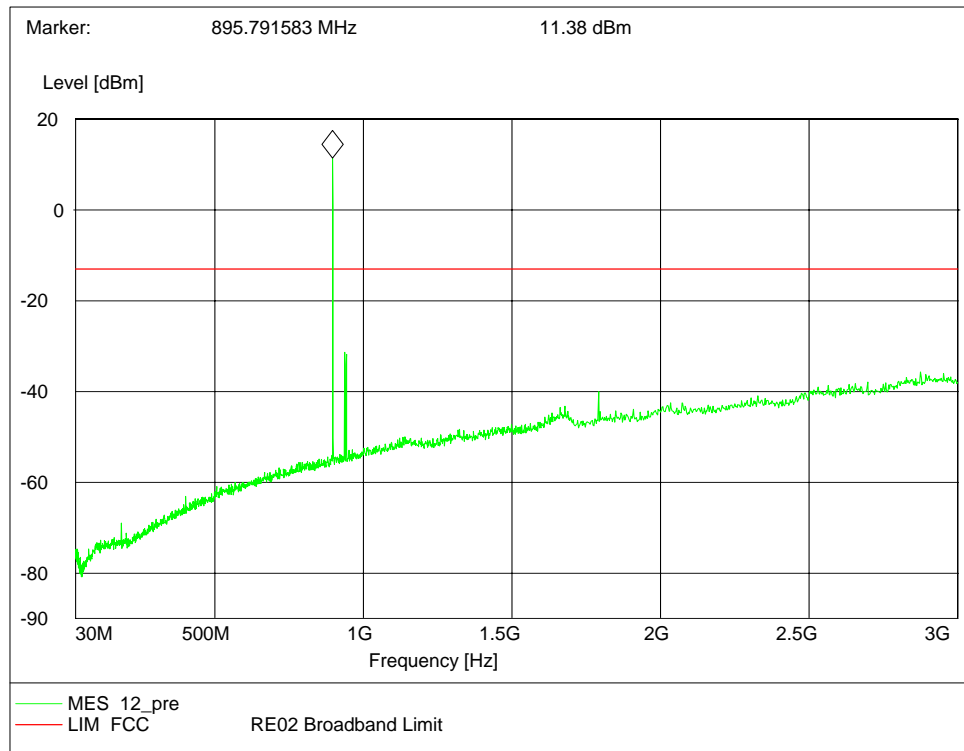

Channel 189, 30MHz~3GHz (Traffic Mode)

Note: The signal beyond the limit is the base station simulator carrier.

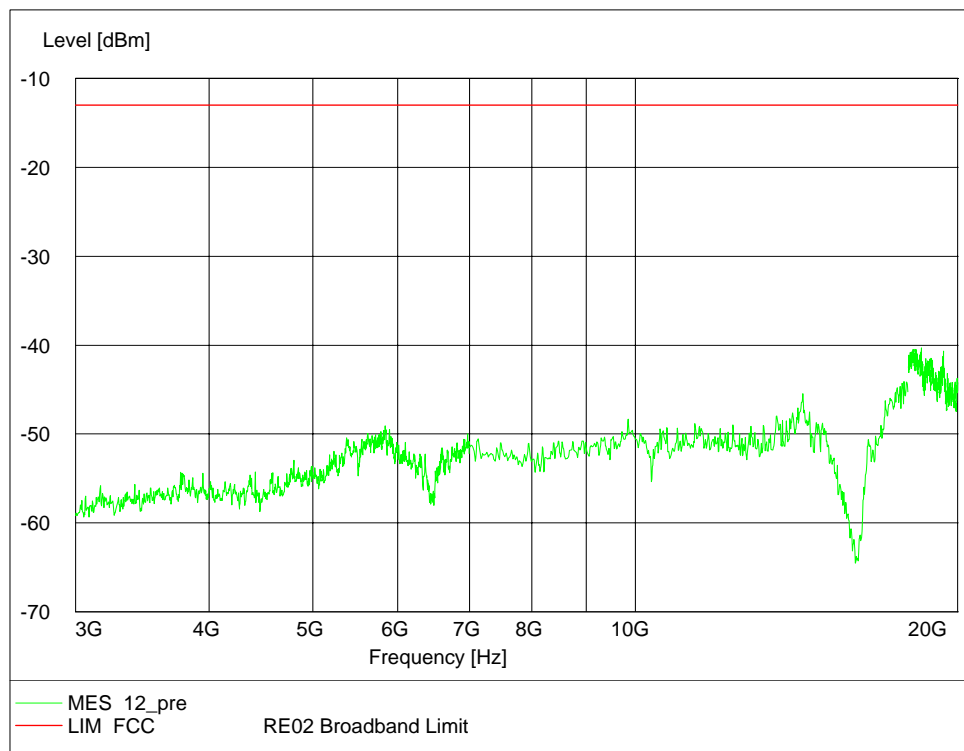

Channel 189, 3GHz~20GHz (Traffic Mode)

2.2.1.8 Conducted Emissions-FCC Part15.107

Ambient condition:

Temperature	Relative humidity	Pressure
20°C	54%	100.5kPa

Test Setup:

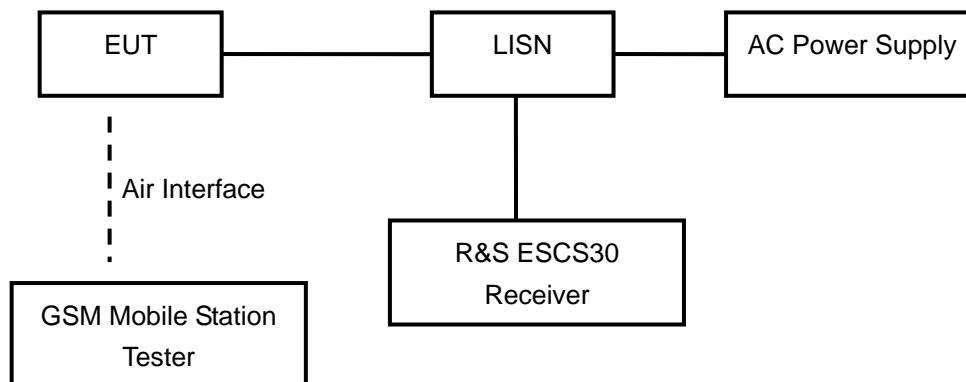

Test Procedure:

The EUT is placed on a non-metallic table 0.8m above the horizontal metal reference ground plane. The EUT is connected to LISN and LISN is connected to the reference ground. All other supplemental devices are connected with EUT through other LISN. The distance between EUT and LISN is 80cm. The measurement should be done both L line and N line. The receiver uses both average detector and quasi-peak detector. The EUT is worked in idle mode. The output power of the EUT is controlled by the tester and driven to maximum value.

Frequency of Emission(MHz)	Limits(dB μ V)	
	Quasi-peak	Average
0.15~0.5	66 to 56*	56 to 46*
0.5~5	56	46
5~30	60	50

Note: * Decreases with the logarithm of the frequency

Test result:

Refer to the following figures.

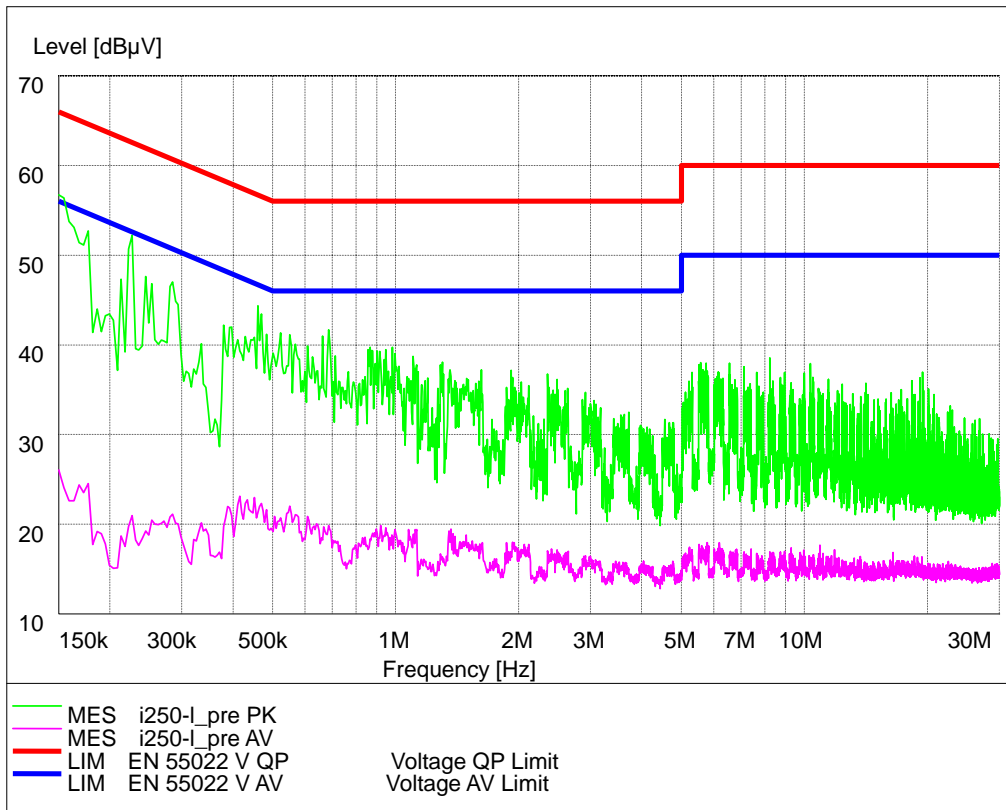

L Line

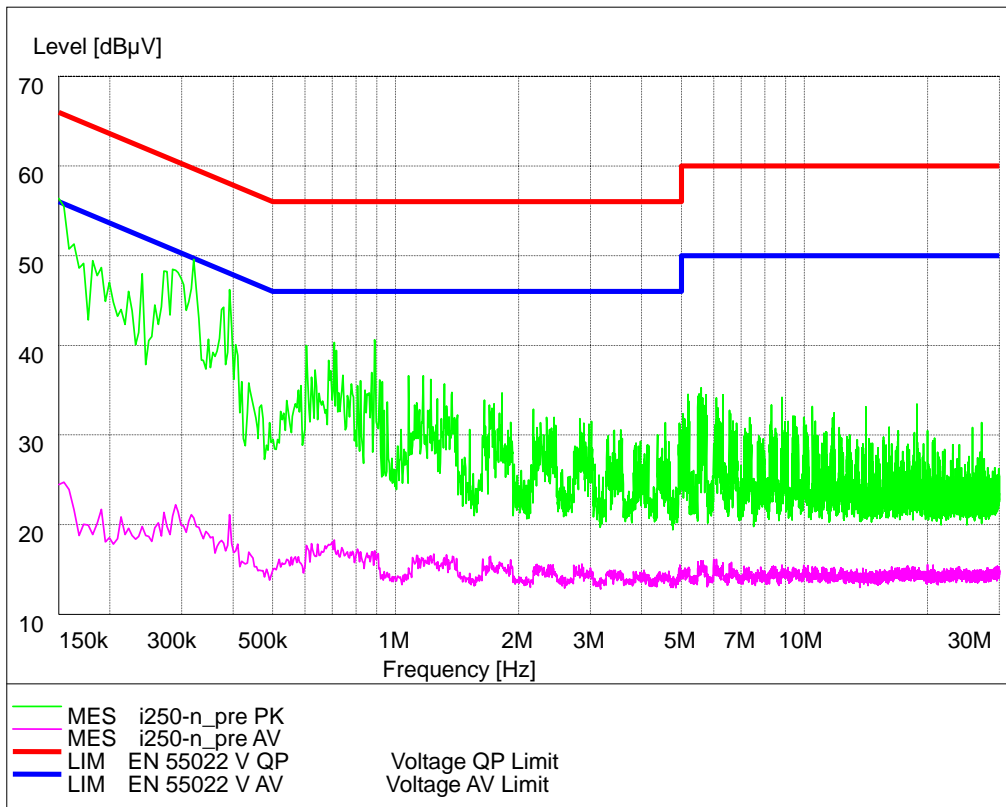

N Line

2.2.1.9 Radiated Emissions -FCC Part15.109

Ambient condition:

Temperature	Relative humidity	Pressure
20°C	54%	100.5kPa

Test Setup:

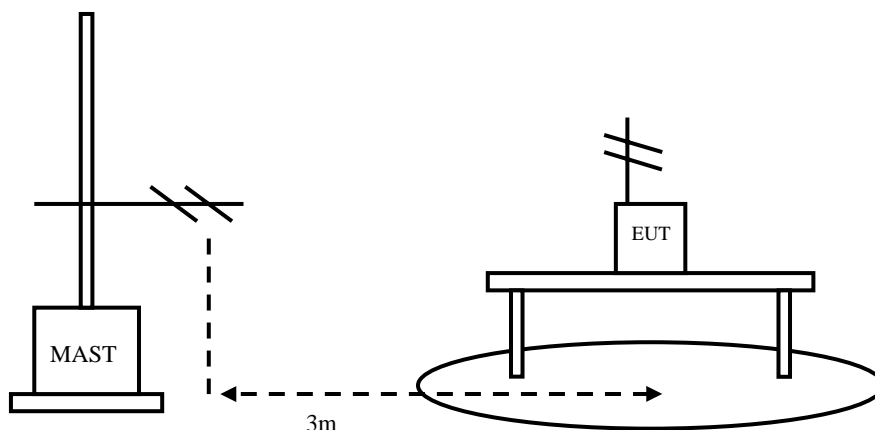

Test Procedure:

The EUT and receive antenna shall be placed to SAC (semi anechoic chamber) upon a non-metallic turn table. The receive antennas shall be moved from 1 to 4 meters. The distance between equipment and receive antenna shall be 3 meters.

Testing shall operate the EUT in idle modes of operation and cable positions in a test set-up which is representative of typical system configurations, as declared by the manufacturer. The output port shall be terminated with 50 ohms.

Then start the test software ES-K1. Sweep the whole frequency band through the range from 30MHz to 1GHz, using receive log period antenna HL562.

During the test, the height of receive antenna shall be moved from 1 to 4 meters, and the antenna shall be performed under horizontal and vertical polarization. The turn table shall be rotated from 0 to 360 degrees for detecting the maximum of radiated spurious signal level. The measurements shall be repeated with orthogonal polarization of the test antenna.

The data of cable loss and antenna factor has been calibrated in full testing frequency range before the testing.

Frequency of Emission(MHz)	Limits	
	Unit(μ V/m)	Average(dB μ V/m)
30~88	100	40
88~216	150	43.5
216~960	200	46
960~1000	500	54

Test result:
 Refer to the following figures.

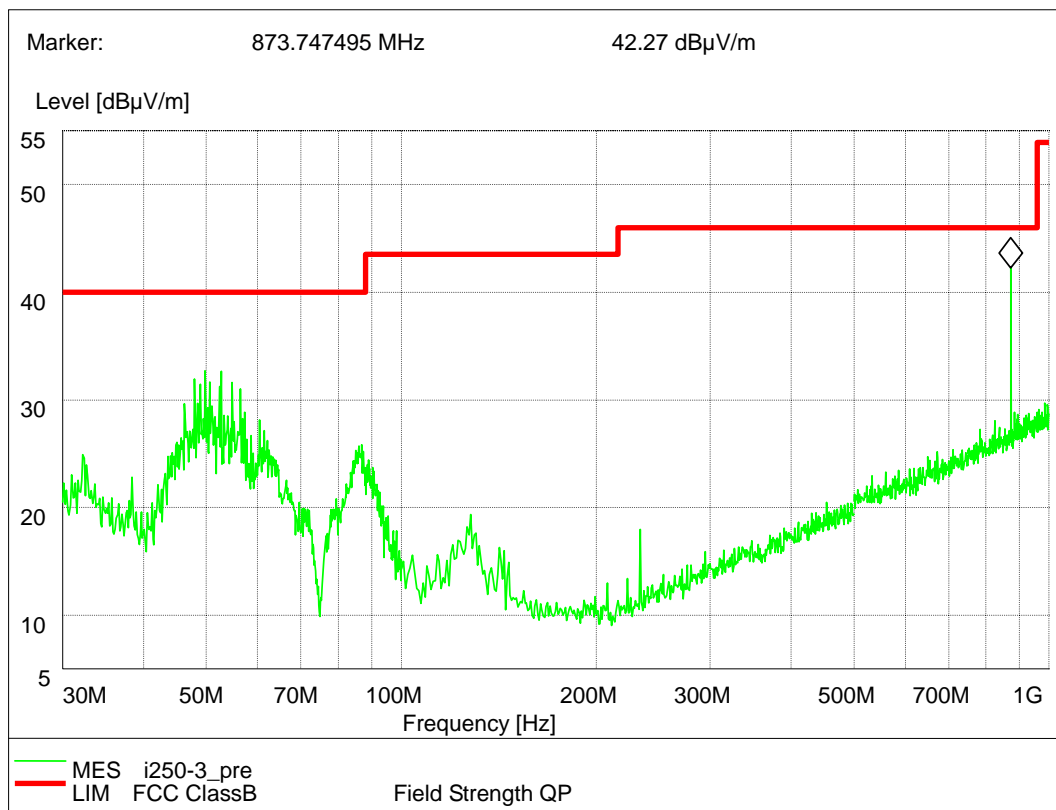

2.2.1 PCS1900

2.2.1.1 RF Power Output –FCC Part2.1046

Ambient condition:

Temperature	Relative humidity	Pressure
20°C	54%	100.5kPa

Test Setup:

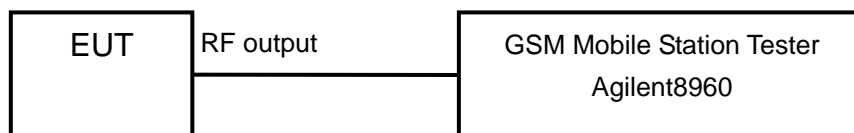

Test procedure:

After a radio link has been established between EUT and Tester, the output power of the cell signal of the testing equipment will be decreased until the output power of the EUT reach a maximum value. Then the test data can be read at the tester screen. The loss between RF output port of the EUT and the input port of the tester will be taken into consideration.

The measurement will be conducted at three channels No512, No661 and No810 (Bottom, middle and top channels of PCS1900 band)

Limits	$\leq 30\text{dBm}$
--------	---------------------

Test result:

GSM/GPRS MODE:

Carrier frequency (MHz)	Channel No.	RF Power Output (dBm)
1850.2	512	30.4
1880.0	661	30.2
1909.8	810	29.7

EDGE MODE:

Carrier frequency (MHz)	Channel No.	RF Power Output (dBm)
1850.2	512	24.2
1880.0	661	24.1
1909.8	810	24.0

2.2.1.2 Effective Isotropic Radiated Power-FCC Part24.232

Ambient condition:

Temperature	Relative humidity	Pressure
20°C	54%	100.5kPa

Test setup

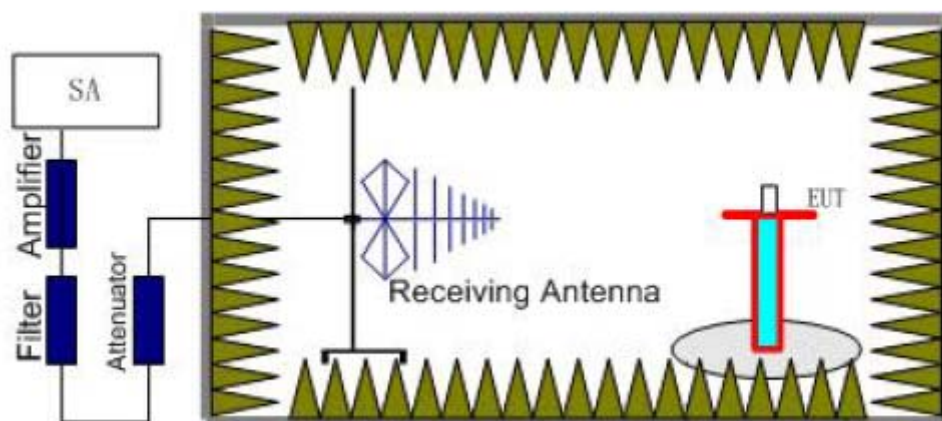

Step 1

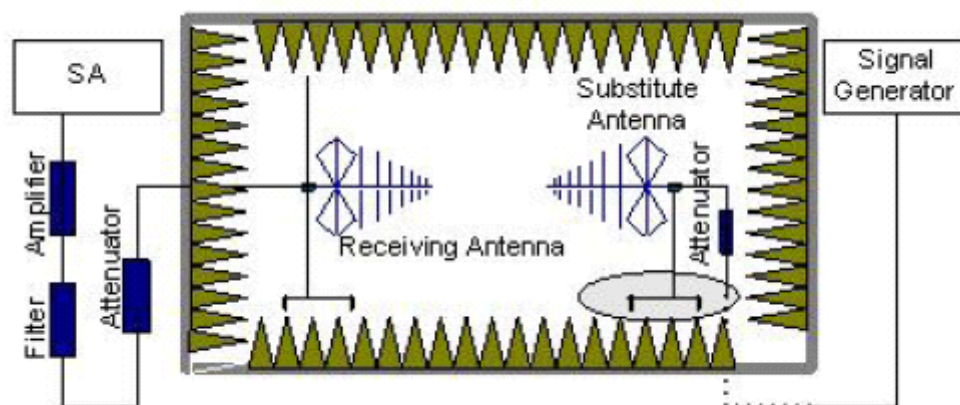

Step 2

Test procedure:

Step 1:

The measurement is carried out in the fully anechoic chamber. EUT was placed on a 2.4 meters high non-conductive table at a 3 meters test distance from the test receive antenna. A receiving antenna was placed on the antenna mast 3 meters from the EUT. The height of receiving antenna is 2.4m and varies in certain range to find the maximum power value. A radio link shall be established between EUT and Tester. The output power of the cell signal of

the tester will be decreased until the output power of the EUT reach a maximum value. A RMS detector is used and RBW is set to 3MHz. Then the antenna height and turn table rotation is adjusted till the maximum power value is founded on spectrum analyzer or receiver.

Step 2:

A log-periodic antenna or double-ridged waveguide horn antenna shall be substituted in place of the EUT. The log-periodic antenna will be driven by a signal generator. To repeat the same procedure as step1 and the level of signal generator will be adjusted till the same power value on the spectrum analyzer or receiver. The ERP/EIRP of the EUT can be calculated through the level of the signal generator, cable loss, the gain of the substitution antenna and the reading of the spectrum analyzer or receiver.

The measurement will be conducted at three channels No512, No661 and No810 (Bottom, middle and top channels of PCS1900 band)

Limits	≤ 33dBm
--------	---------

Test result:

GSM/GPRS MODE:

Carrier frequency (MHz)	Channel No.	E.I.R.P. (dBm)
1850.2	512	28.3
1880.0	661	27.8
1909.8	810	27.7

EDGE MODE:

Carrier frequency (MHz)	Channel No.	E.I.R.P. (dBm)
1850.2	512	9.6
1880.0	661	10.09
1909.8	810	9.80

2.2.1.3 Occupied Bandwidth-FCC Part2.1049

Ambient condition:

Temperature	Relative humidity	Pressure
20°C	54%	100.5kPa

Test Setup:

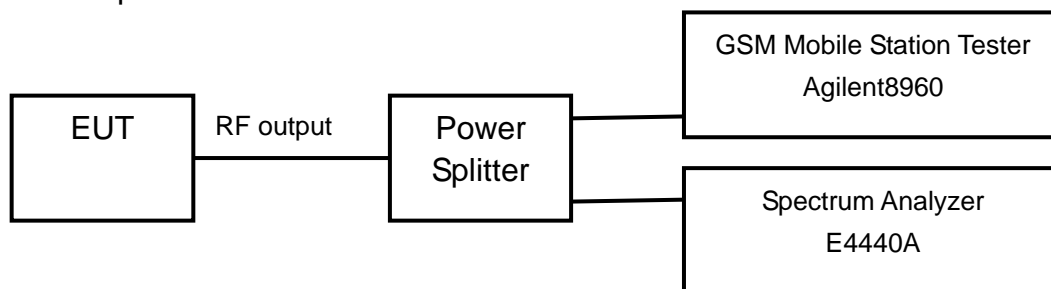

Test procedure:

After a radio link has been established between EUT and Tester, the output power of the cell signal of the testing equipment will be decreased until the output power of the EUT reach a maximum value. The occupied bandwidth is measured using spectrum analyzer. RBW is set to 3kHz on spectrum analyzer. The bandwidth of 99% power can be read on spectrum analyzer. The measurement will be conducted at three channels No512, No661 and No810 (Bottom, middle and top channels of PCS1900 band)

Limits: No specific occupied bandwidth requirements in part 2.1049

Test result:

GSM/GPRS MODE:

Carrier frequency (MHz)	Channel No.	Bandwidth of 99% Power (kHz)
1850.2	512	243.4
1880.0	661	245.6
1909.8	810	240.5

EDGE MODE:

Carrier frequency (MHz)	Channel No.	Bandwidth of 99% Power (kHz)
1850.2	512	240.2
1880.0	661	240.5
1909.8	810	243.1

GSM/GPRS MODE:

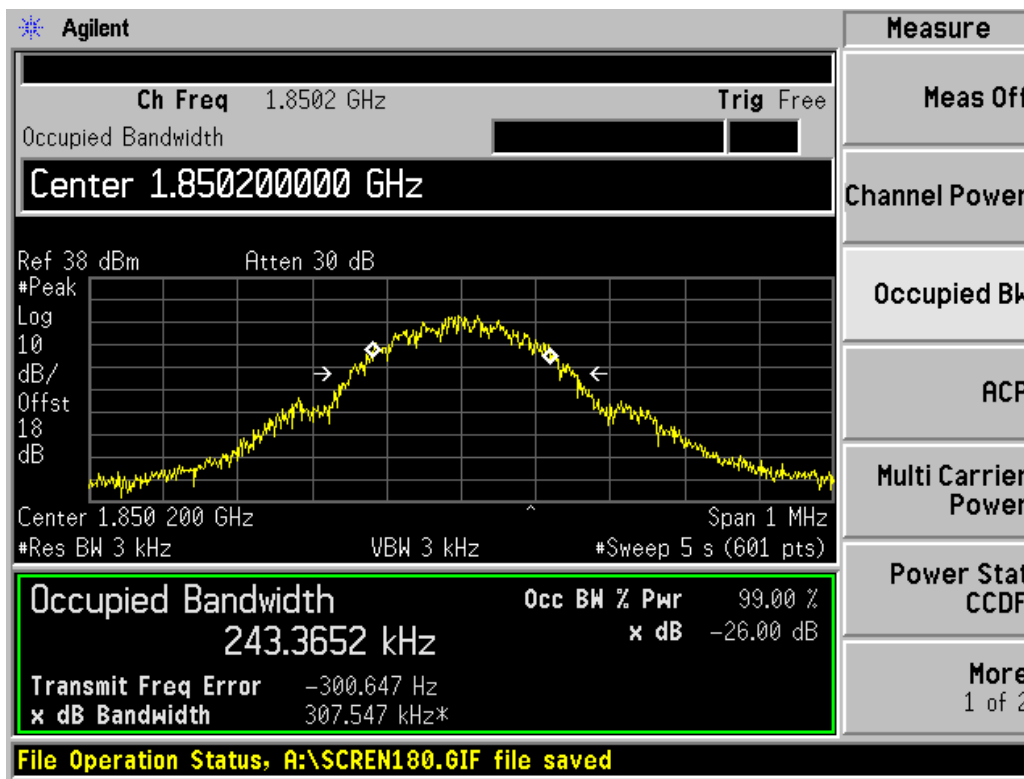

Channel 512

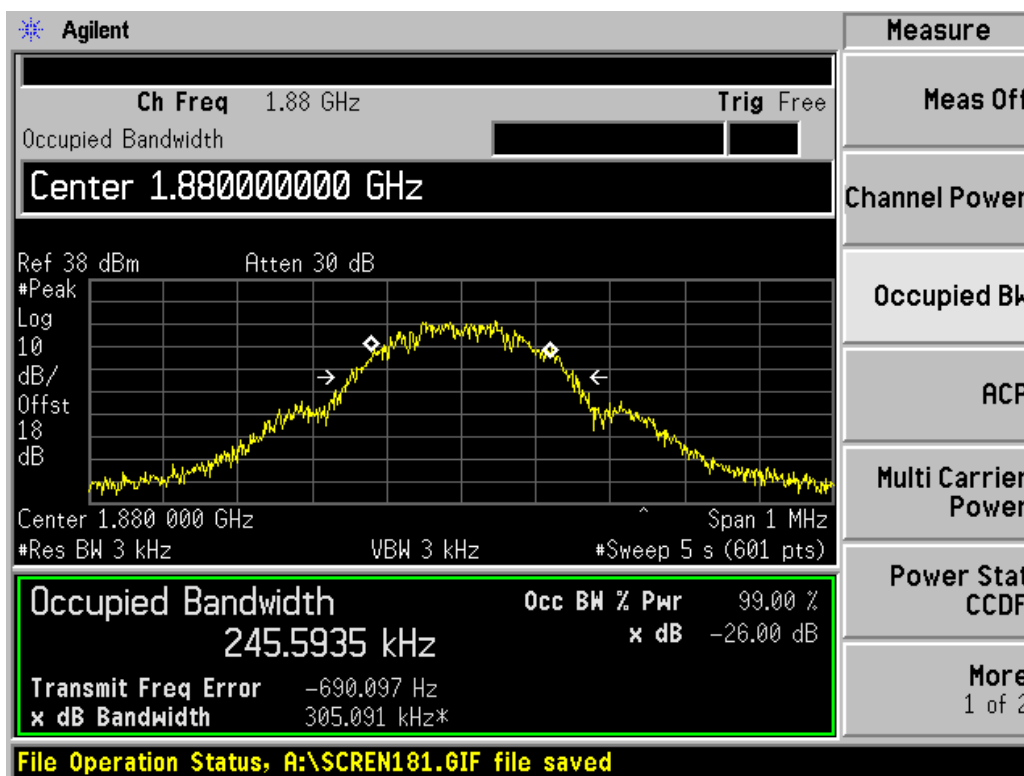

Channel 661

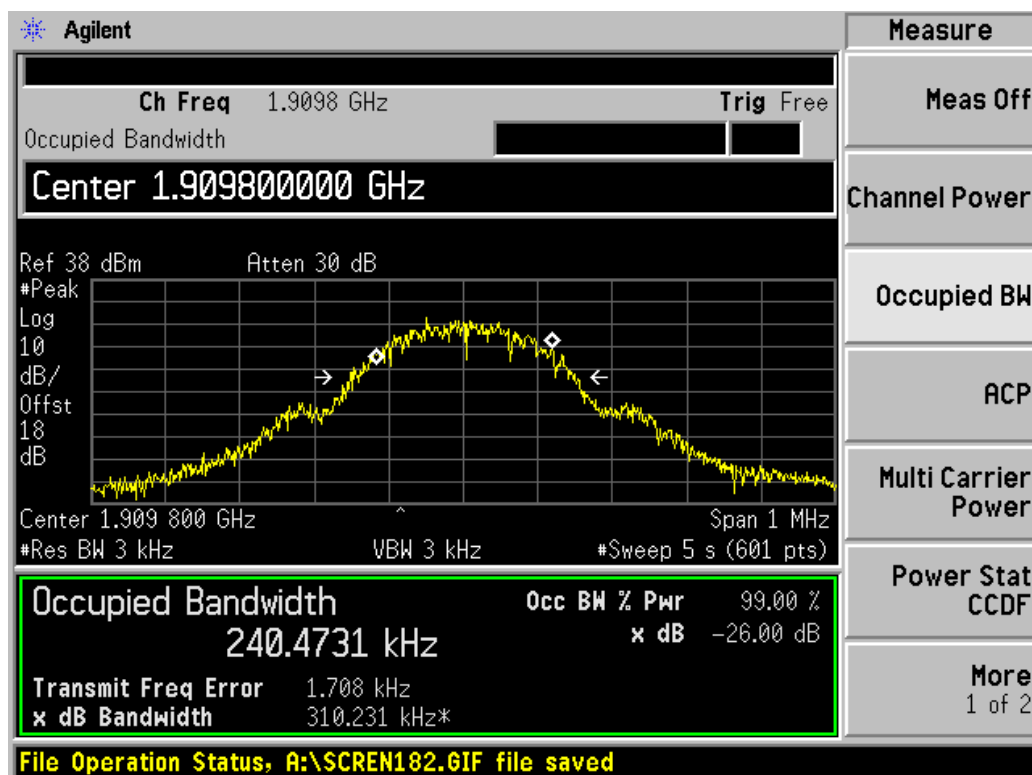

Channel 810

EDGE MODE:

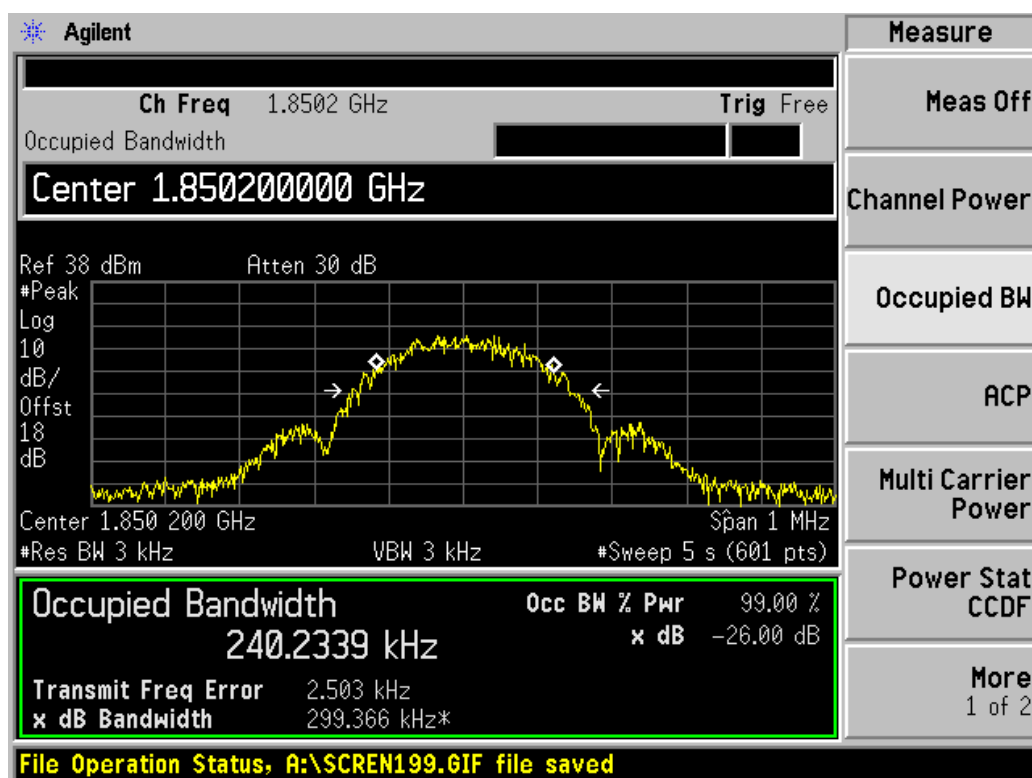

Channel 512

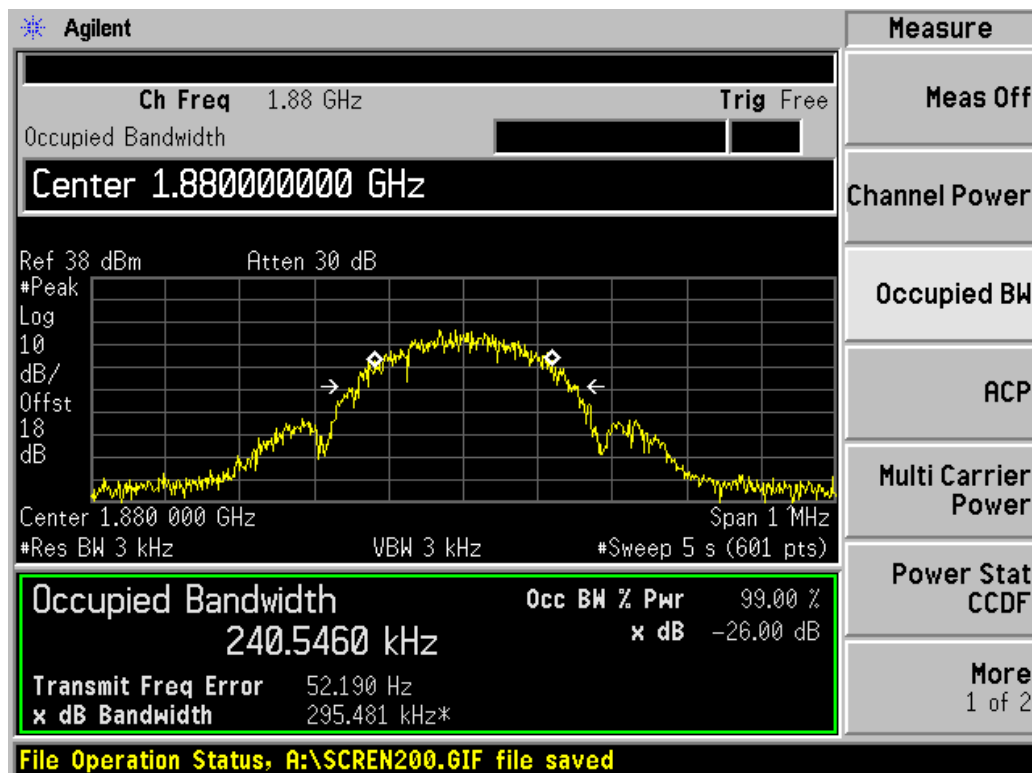

Channel 661

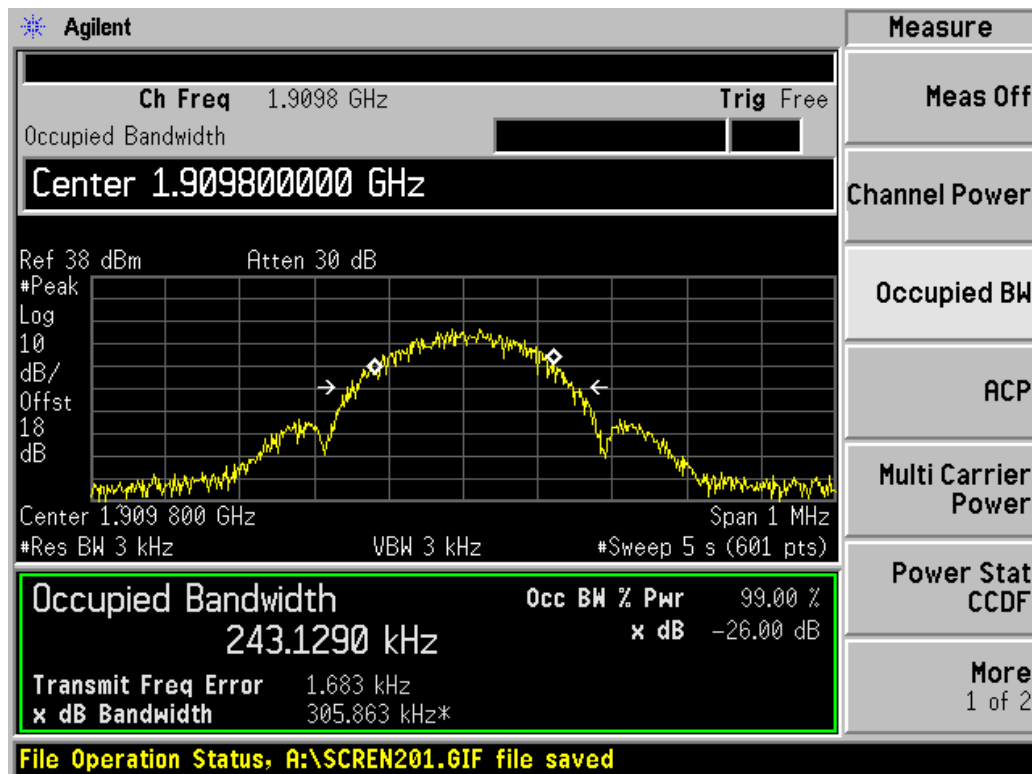

Channel 810

2.2.1.4 Spurious Emissions at antenna terminals-FCC Part2.1051/24.238

Ambient condition:

Temperature	Relative humidity	Pressure
20°C	54%	100.5kPa

Test Setup:

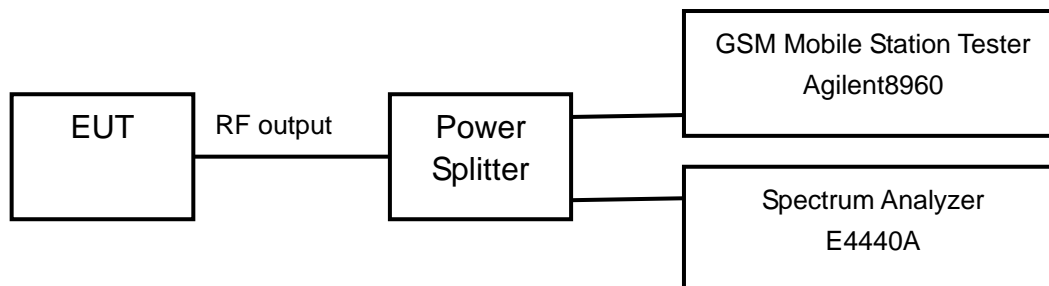

Test procedure:

After a radio link has been established between EUT and Tester, the output power of the cell signal of the testing equipment will be decreased until the output power of the EUT reach a maximum value. The measurement is carried out using a spectrum analyzer. The spectrum analyzer scans from 30MHz to 20GHz (higher than the 10th harmonic of the carrier). The peak detector is used and RBW is set to 1MHz on spectrum analyzer.

The measurement will be conducted at one channel No661 (middle channel of PCS1900 band)

Limits	≤ -13dBm
--------	----------

Test result:

Refer to the following figures.

GSM/GPRS MODE:

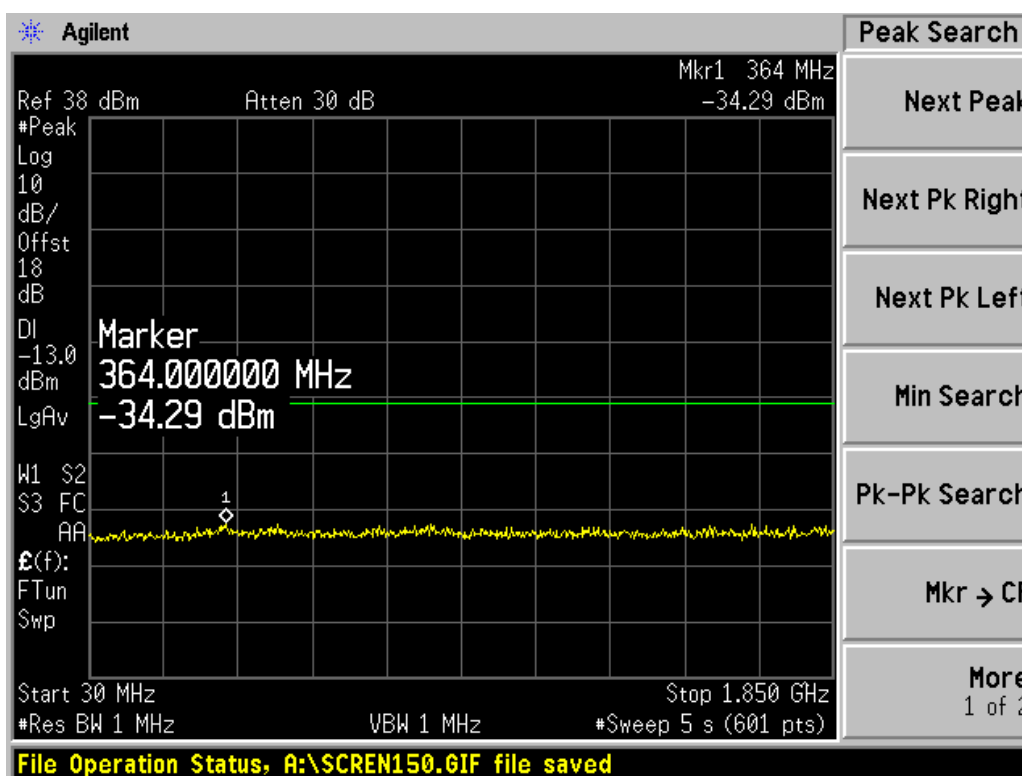

Channel 661, 30MHz~1850MHz

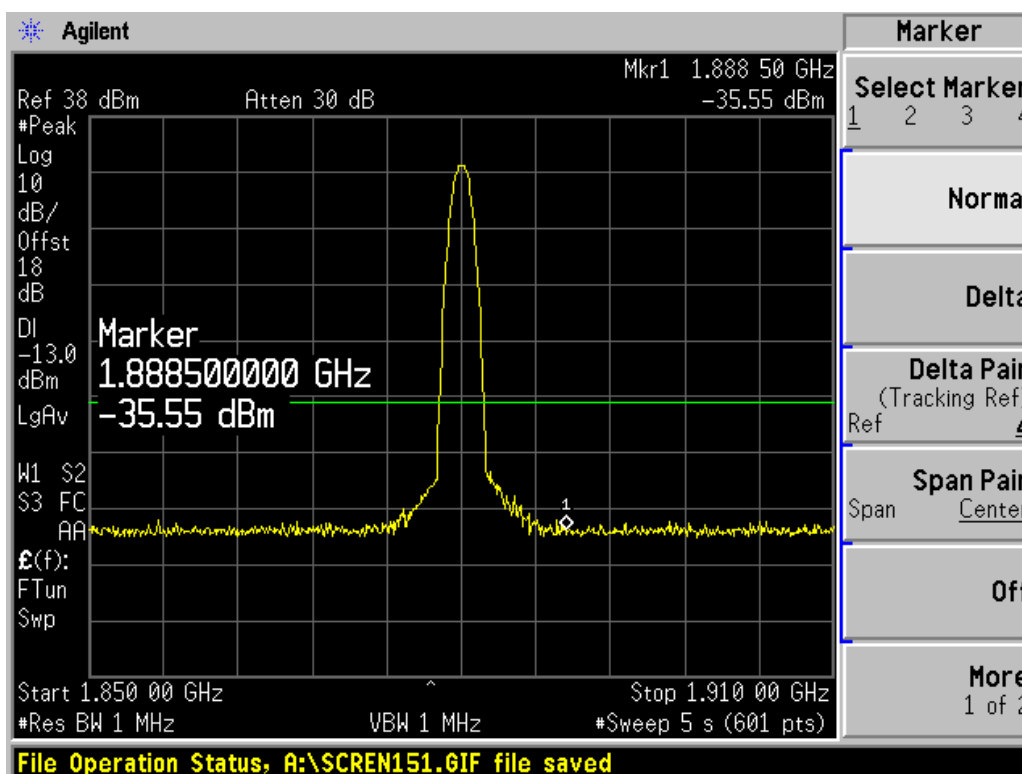

Channel 661, 1850MHz~1910MHz

Note: The signal beyond the limit is the base station simulator carrier.

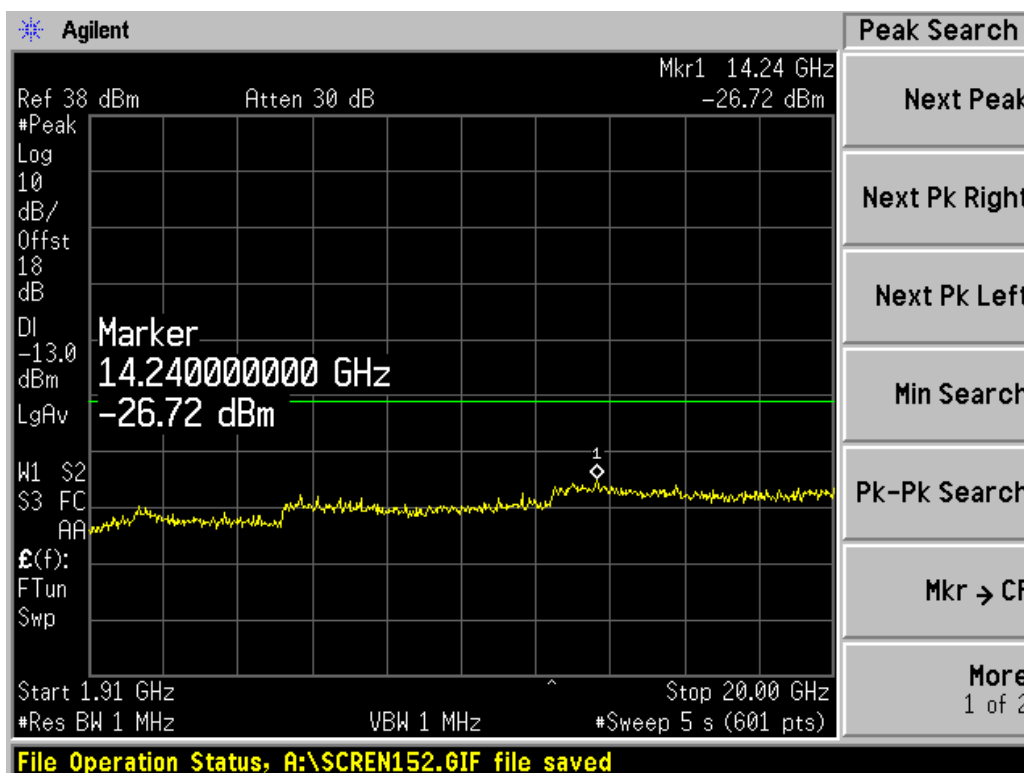

Channel 661, 1910MHz~20GHz

EDGE MODE:

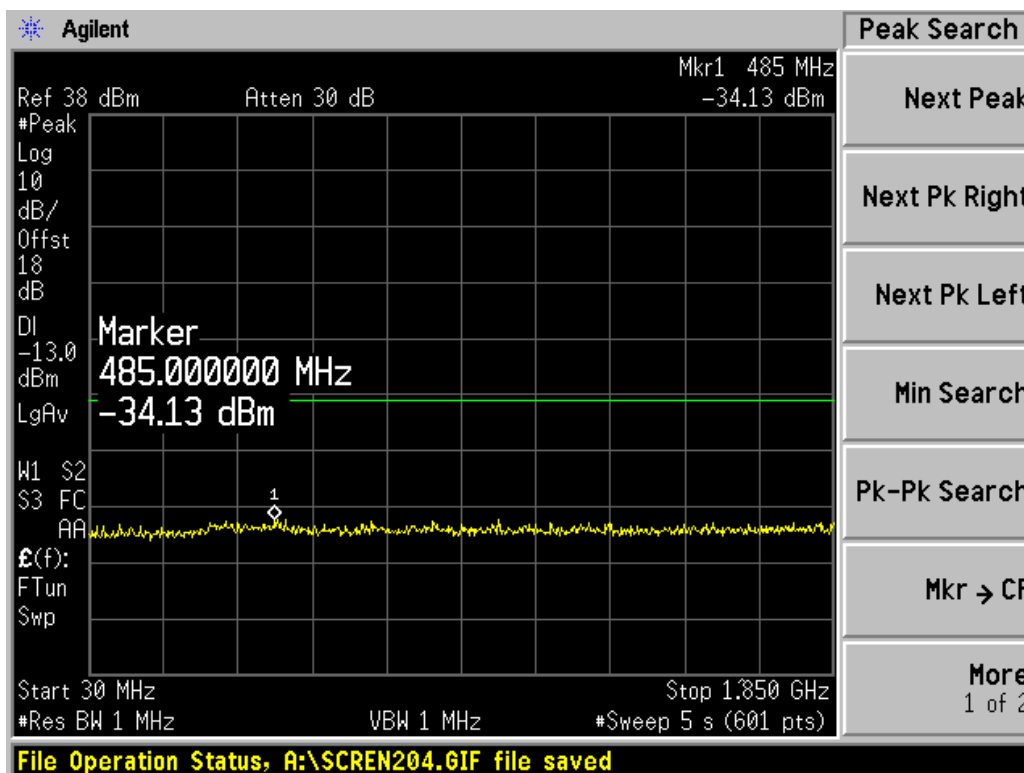

Channel 661, 30MHz~1850MHz

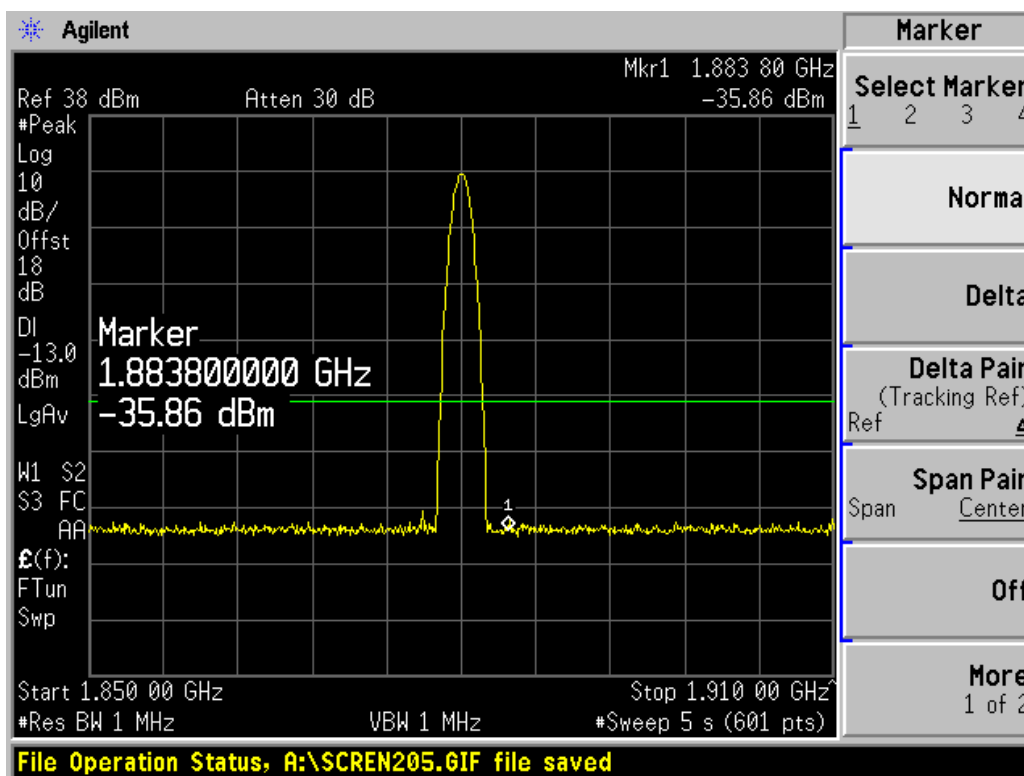

Channel 661, 1850MHz~1910MHz

Note: The signal beyond the limit is the base station simulator carrier.

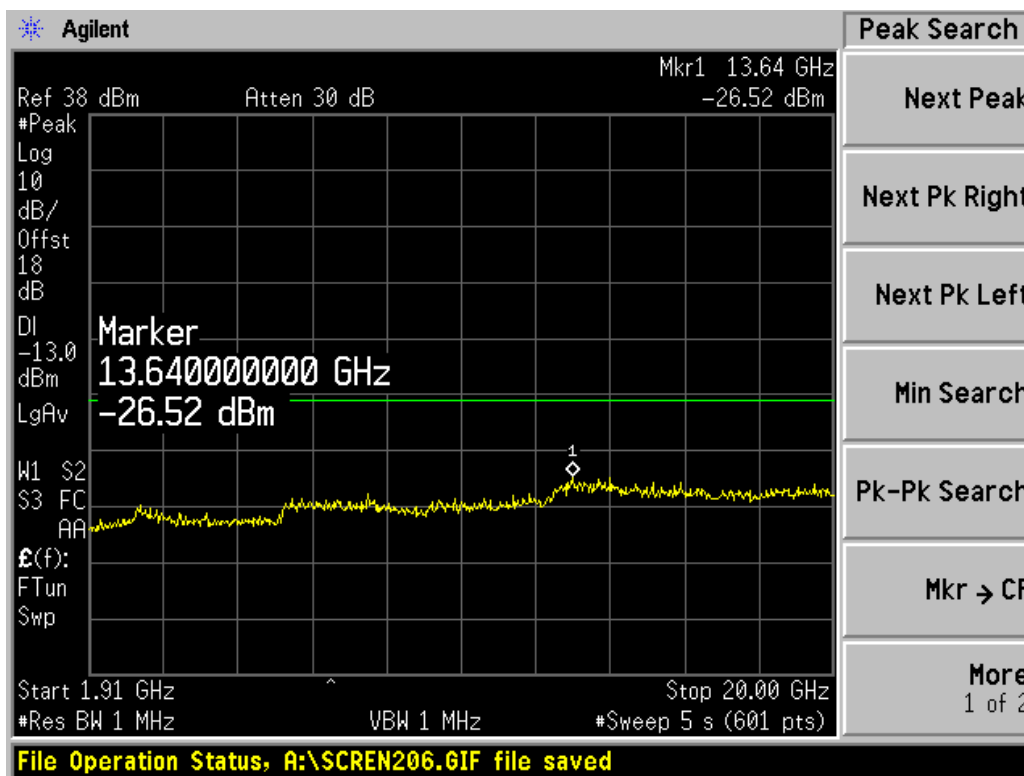

Channel 661, 1910MHz~20GHz

2.2.1.5 Band Edges Compliance- FCC Part2.1051/24.238

Ambient condition:

Temperature	Relative humidity	Pressure
20°C	54%	100.5kPa

Test Setup:

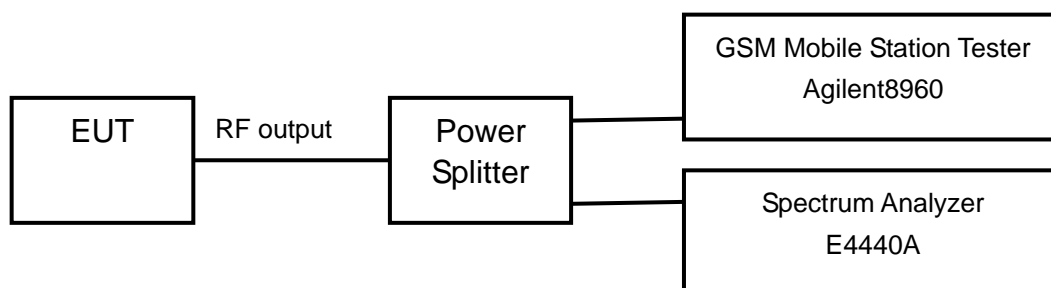

Test procedure:

After a radio link has been established between EUT and Tester, the output power of the cell signal of the testing equipment will be decreased until the output power of the EUT reach a maximum value. The measurement is carried out using a spectrum analyzer. The peak detector is used and RBW is set to 3KHz on spectrum analyzer.

The measurement will be conducted at two channels No512 and No810 (Bottom and top channels of PCS1900 band)

Limits	≤ -13dBm
--------	----------

Test result:

Refer to the following figures.

GSM/GPRS MODE:

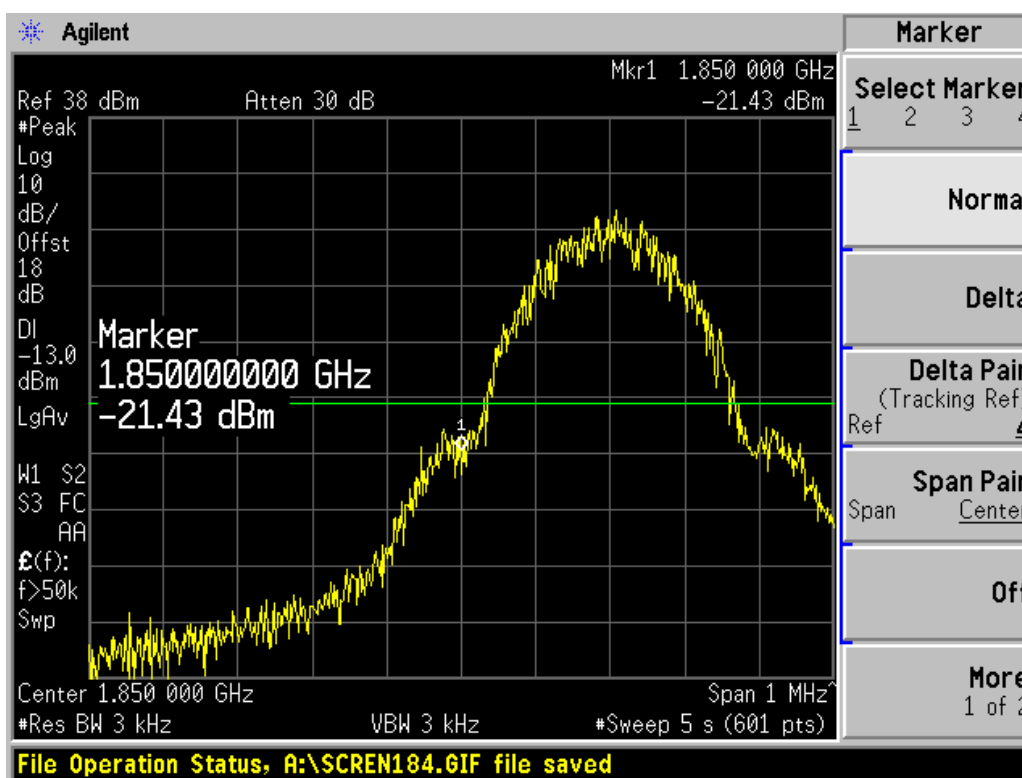

Channel 512

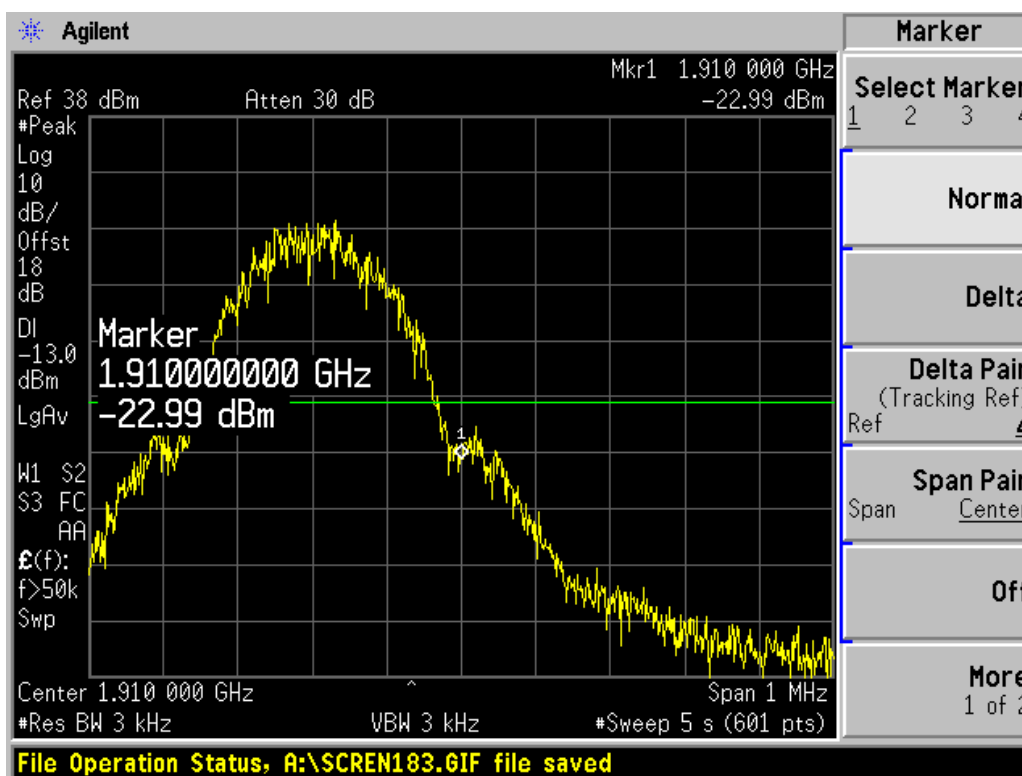

Channel 810

EDGE MODE:

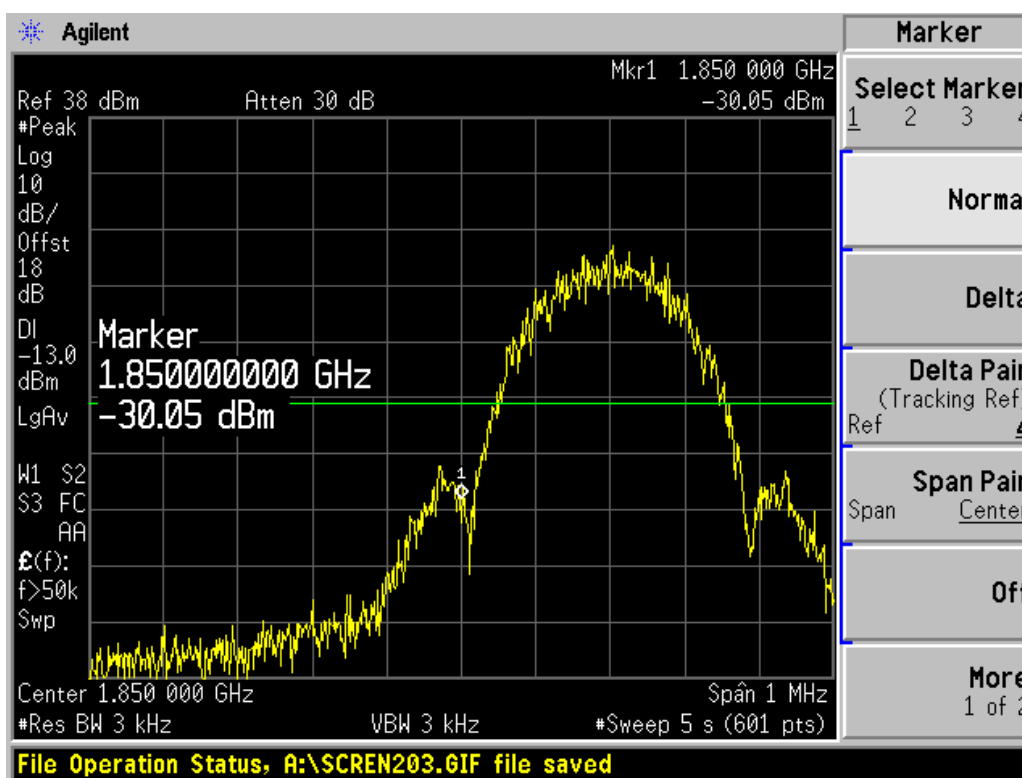

Channel 512

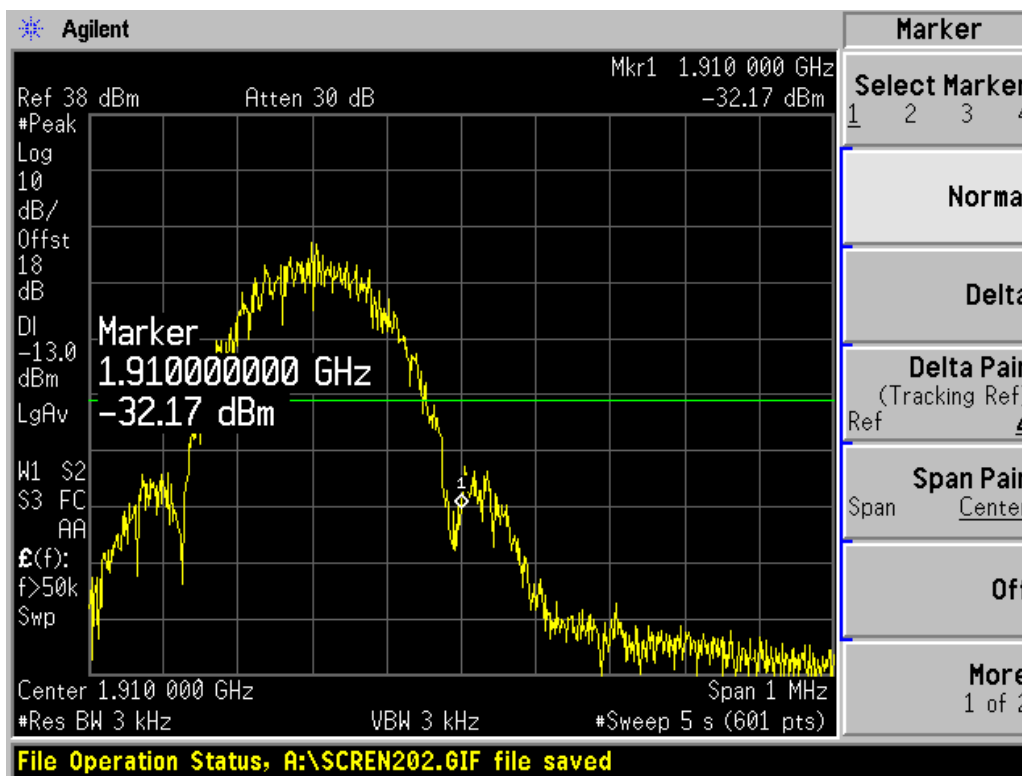

Channel 810

2.2.1.6 Frequency Stability-FCC Part2.1055/Part24.235

Ambient condition:

Temperature	Relative humidity	Pressure
20°C	54%	100.5kPa

Test setup:

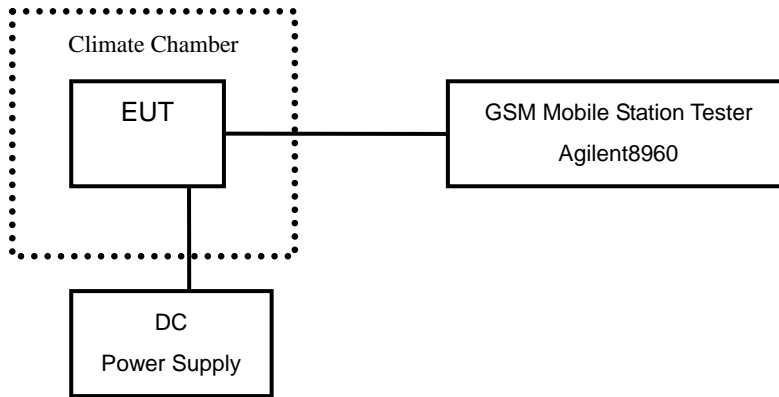

Test Procedure:

A radio link shall be established between EUT and Tester. The tester will sample the transmitter RF output signal and measure its frequency. The temperature inside the climate chamber is varied from -30 to +50° C in 10° C step size, and also the DC power supply voltage to the EUT is varied from 3.4 to 4.2 V.

Limits: No specific frequency stability requirements in part 2.1055 and part 24.235

Test Result:

GSM/GPRS MODE:

Temperature(° C)	Test Result (ppm)		
	Channel 512	Channel 661	Channel 810
-30	---	0.022	---
-20	---	0.024	---
-10	---	0.019	---
0	---	0.005	---
+10	---	0.021	---
+20	---	0.012	---
+30	---	0.032	---
+40	---	0.017	---
+50	---	0.025	---

Voltage (V)	Test Result (ppm)		
	Channel 512	Channel 661	Channel 810
3.4	---	0.006	---
4.2	---	0.034	---

EDGE MODE:

Temperature(° C)	Test Result (ppm)		
	Channel 512	Channel 661	Channel 810
-30	---	0.026	---
-20	---	0.028	---
-10	---	0.015	---
0	---	0.000	---
+10	---	0.004	---
+20	---	0.033	---
+30	---	0.017	---
+40	---	0.020	---
+50	---	0.011	---

Voltage (V)	Test Result (ppm)		
	Channel 512	Channel 661	Channel 810
3.4	---	0.012	---
4.2	---	0.014	---

2.2.1.7 Radiated Spurious Emissions-FCC Part2.1053/24.238

Ambient condition

Temperature	Relative humidity	Pressure
20°C	54%	100.5kPa

Test Setup:

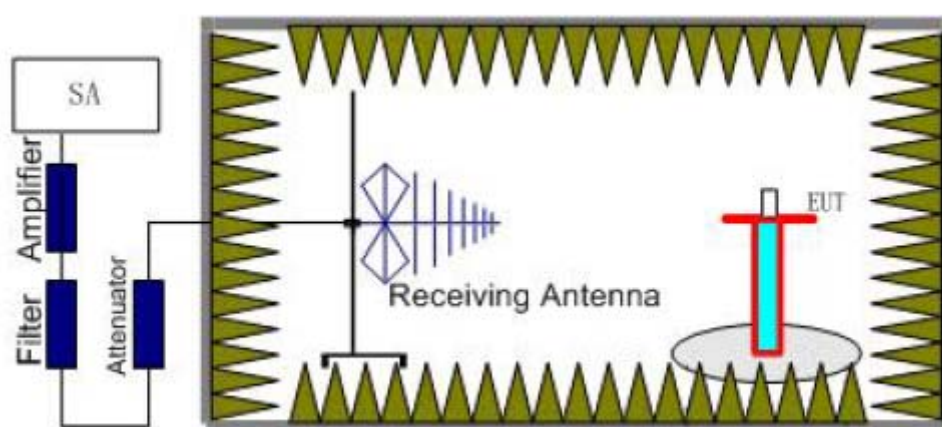

Step 1

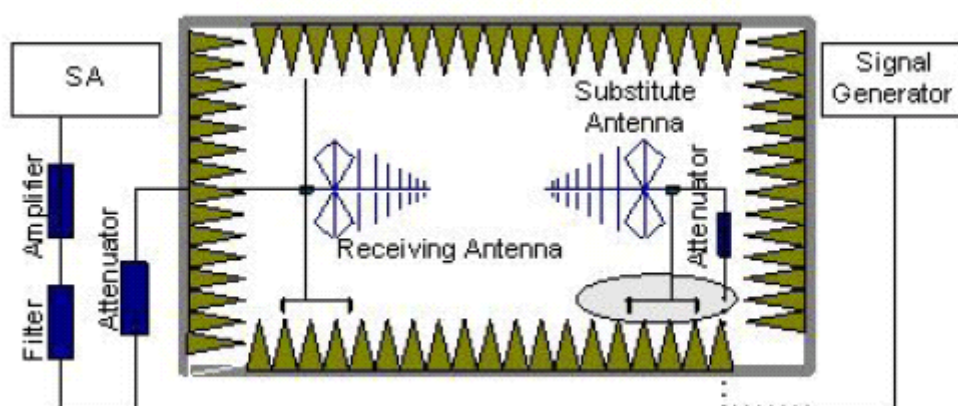

Step 2

Test procedure:

Step 1:

The measurement is carried out in the fully anechoic chamber. EUT was placed on a 2.4 meter high non-conductive table at a 3 meter test distance from the test receive antenna. A receiving antenna was placed on the antenna mast 3 meters from the EUT. The height of receiving antenna is 2.4m and

varies in certain range to find the maximum power value. A radio link shall be established between EUT and Tester. The output power of the cell signal of the tester will be decreased until the output power of the EUT reach a maximum value. The measurement is carried out using a spectrum analyzer or receiver. The spectrum analyzer scans from 30MHz to 20GHz (higher than the 10th harmonic of the carrier). The peak detector is used and RBW is set to 1MHz on spectrum analyzer. Then the antenna height and turn table rotation is adjusted till the maximum power value is founded on spectrum analyzer or receiver. A notch filter is necessary in the band near to the carrier frequency. A high pass filter is needed to avoid the distortion of the testing equipment in the band above the carrier frequency.

Step 2:

A log-periodic antenna or double-ridged waveguide horn antenna shall be substituted in place of the EUT. The log-periodic antenna will be driven by a signal generator and the level will be adjusted till the same power value on the spectrum analyzer or receiver. The level of the spurious emissions can be calculated through the level of the signal generator, cable loss, the gain of the substitution antenna and the reading of the spectrum analyzer or receiver.

Calculation procedure:

The data of cable loss, antenna gain and air loss has been calibrated in full testing frequency range before the testing.

The power of the Radiated Spurious Emissions is calculated by adding the cable loss, antenna gain and air loss. The basic equation with a sample calculation is as followed:

$$P = P_R + L_C + L_A - G$$

Where

P: Power of the Radiated Spurious Emissions (dBm)

P_R: reading of the receiver (dBm)

L_C: Cable Lose (dB)

L_A: Air loss (dB)

G: Antenna Gain (dBi)

Assumed the reading of the receiver is -60dBm. A cable lose of 10dB, an air lose of 30dB and an antenna gain of 11dBi are added.

$$P = P_R + L_C + L_A - G = -60 + 10 + 30 - 11 = -31 \text{dBm}$$

The measurement will be conducted at one channel No661 (middle channels of PCS1900 band)

Limits	≤ -13dBm
--------	----------

Test result:
Refer to the following figures.

GSM/GPRS MODE:

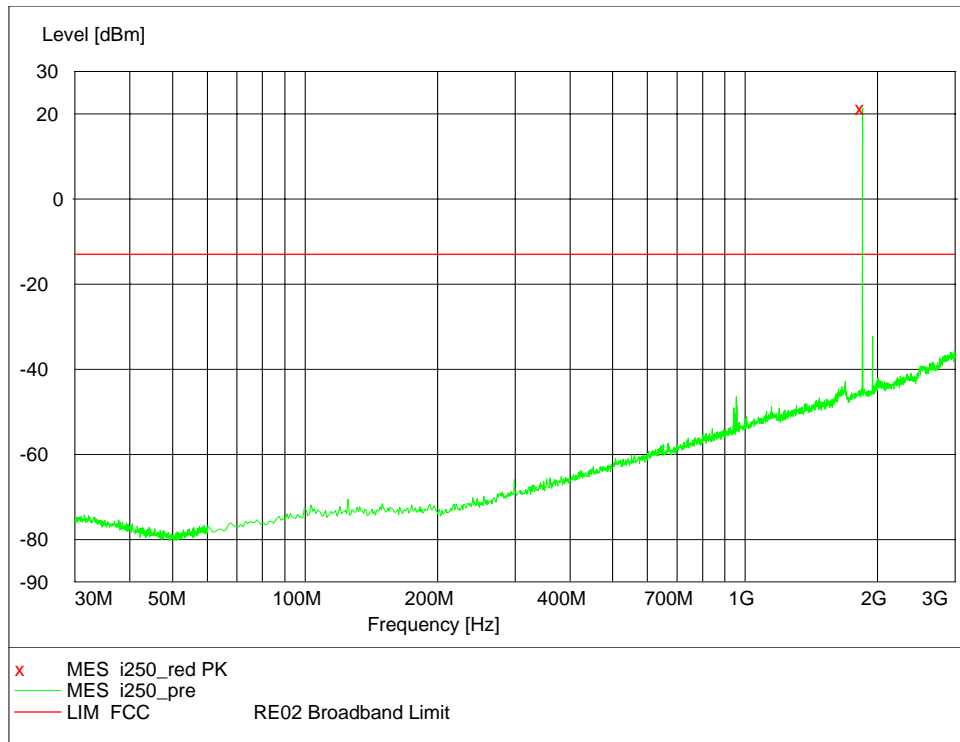

Channel 661, 30MHz~3GHz (Traffic Mode)

Note: The signal beyond the limit is the base station simulator carrier.

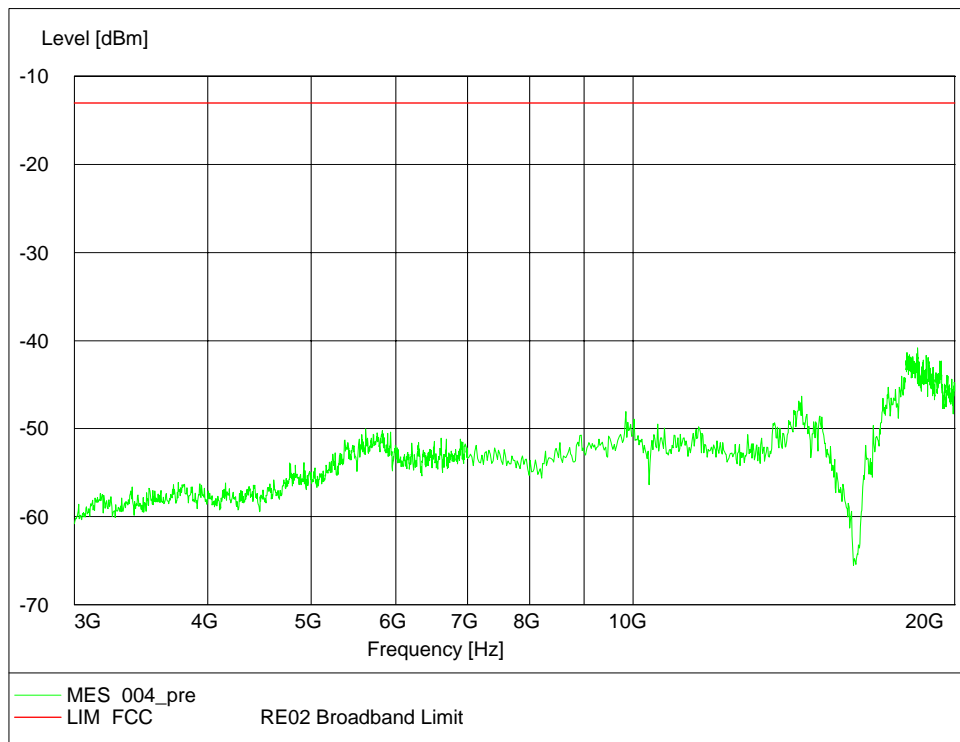

Channel 661, 3GHz~20GHz(Traffic Mode)

EDGE MODE:

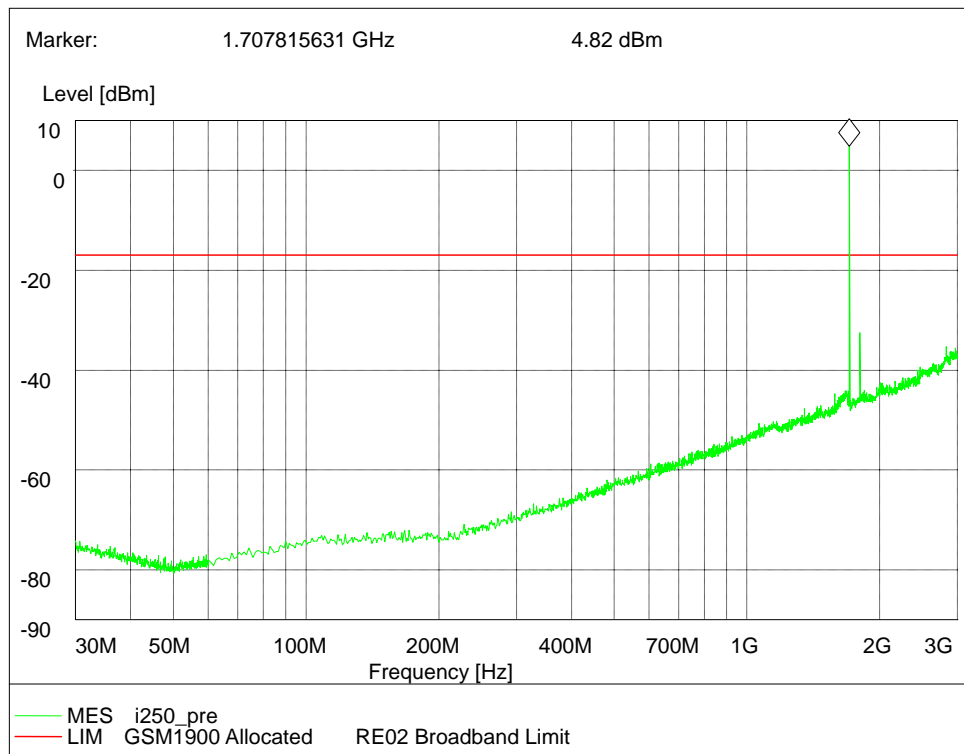

Channel 661, 30MHz~3GHz (Traffic Mode)

Note: The signal beyond the limit is the base station simulator carrier.

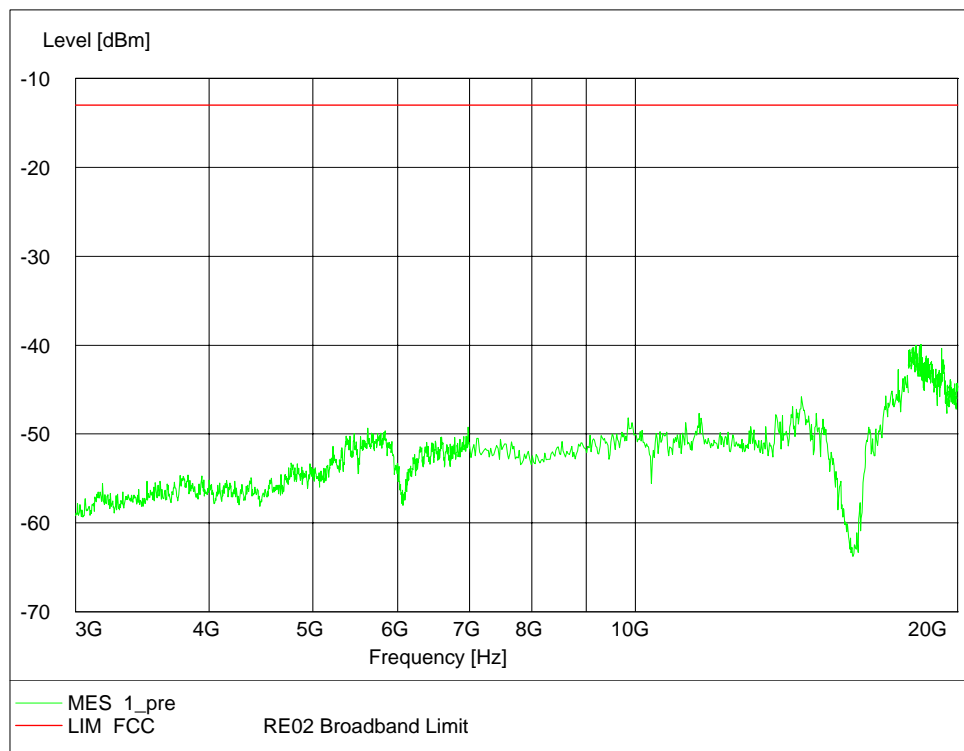

Channel 661, 3GHz~20GHz(Traffic Mode)

2.2.1.8 Conducted Emissions-FCC Part15.107

Ambient condition:

Temperature	Relative humidity	Pressure
20°C	54%	100.5kPa

Test Setup:

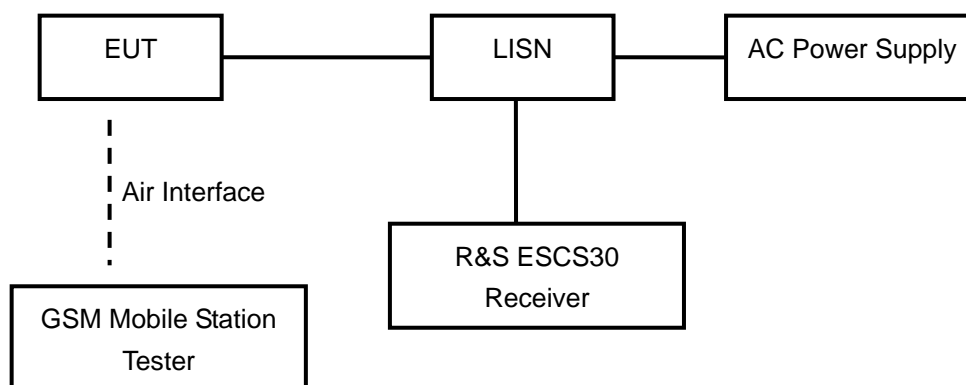

Test Procedure:

The EUT is placed on a non-metallic table 0.8m above the horizontal metal reference ground plane. The EUT is connected to LISN and LISN is connected to the reference ground. All other supplemental devices are connected with EUT through other LISN. The distance between EUT and LISN is 80cm. The measurement should be done both L line and N line. The receiver uses both average detector and quasi-peak detector. The EUT is worked in idle mode. The output power of the EUT is controlled by the tester and driven to maximum value.

Frequency of Emission(MHz)	Limits(dBμV)	
	Quasi-peak	Average
0.15~0.5	66 to 56*	56 to 46*
0.5~5	56	46
5~30	60	50

Note: * Decreases with the logarithm of the frequency

Test result:

Refer to the following figures.

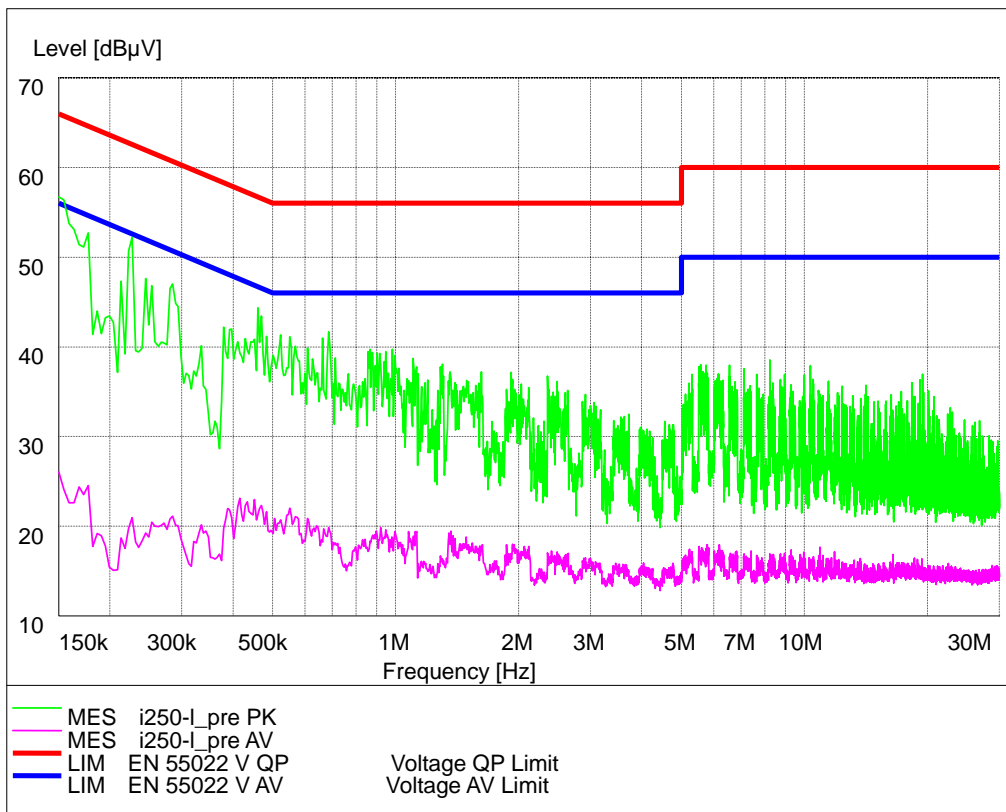

L Line

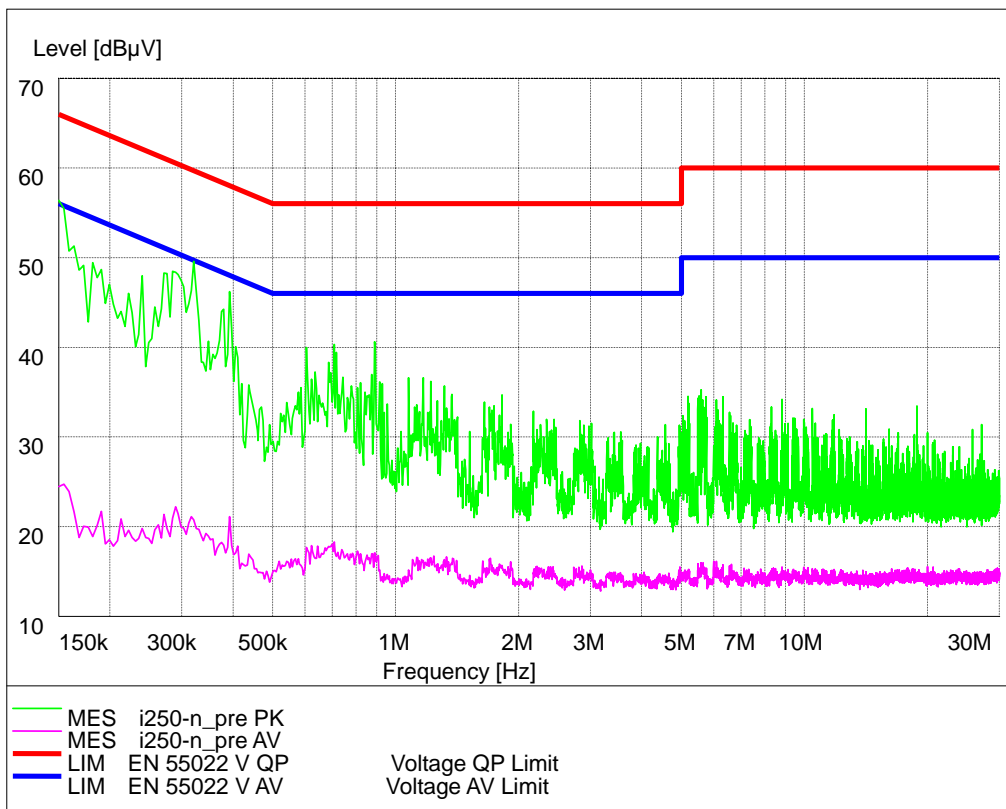

N Line

2.2.1.9 Radiated Emissions -FCC Part15.109

Ambient condition:

Temperature	Relative humidity	Pressure
20°C	54%	100.5kPa

Test Setup:

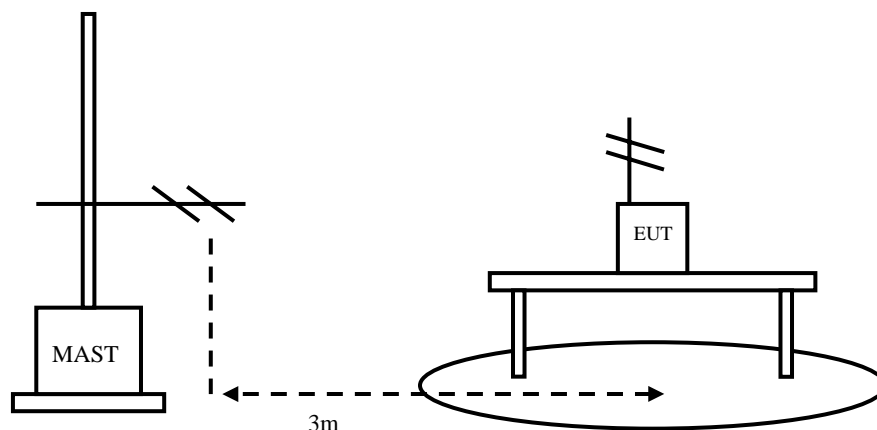

Test Procedure:

The EUT and receive antenna shall be placed to SAC (semi anechoic chamber) upon a non-metallic turn table. The receive antennas shall be moved from 1 to 4 meters. The distance between equipment and receive antenna shall be 3 meters.

Testing shall operate the EUT in idle modes of operation and cable positions in a test set-up which is representative of typical system configurations, as declared by the manufacturer. The output port shall be terminated with 50 ohms.

Then start the test software ES-K1. Sweep the whole frequency band through the range from 30MHz to 1GHz, using receive log period antenna HL562.

During the test, the height of receive antenna shall be moved from 1 to 4 meters, and the antenna shall be performed under horizontal and vertical polarization. The turn table shall be rotated from 0 to 360 degrees for detecting the maximum of radiated spurious signal level. The measurements shall be repeated with orthogonal polarization of the test antenna.

The data of cable loss and antenna factor has been calibrated in full testing frequency range before the testing.

Frequency of Emission(MHz)	Limits	
	Unit($\mu\text{V/m}$)	Average($\text{dB}\mu\text{V/m}$)
30~88	100	40
88~216	150	43.5
216~960	200	46
960~1000	500	54

Test result:
 Refer to the following figures.

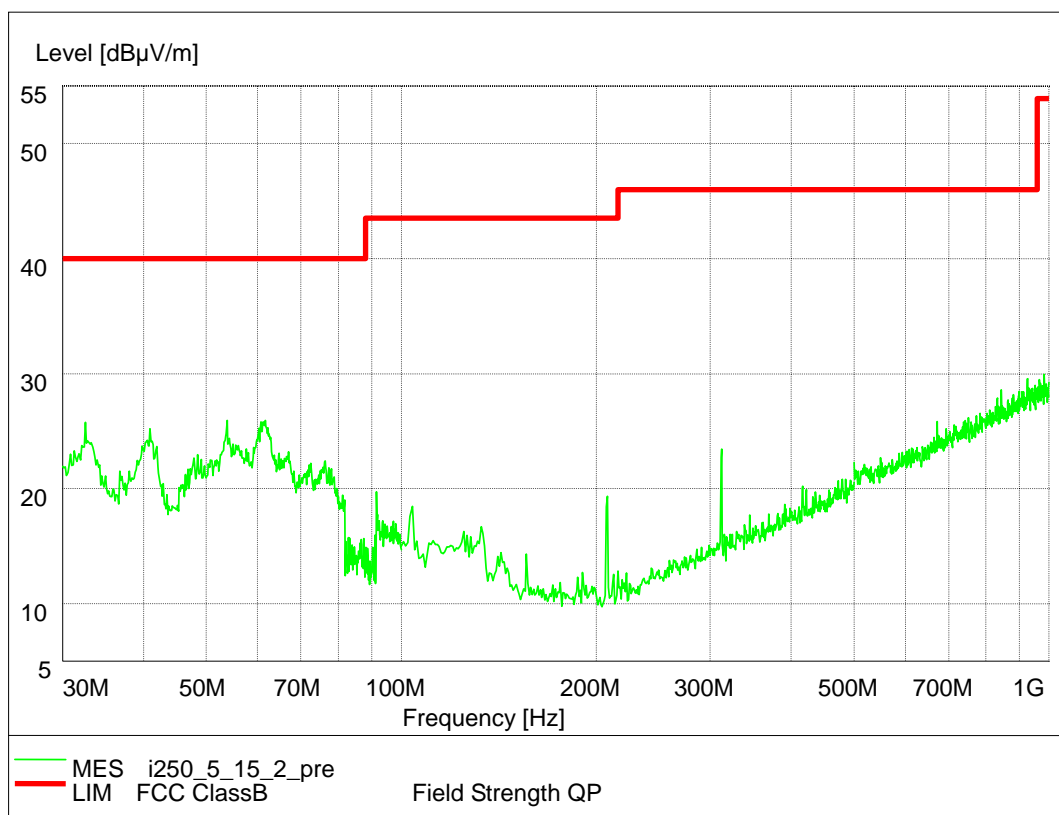

2.3. List of test equipments

No.	Name/Model	Manufacturer	S/N	Calibration Date
1	8960 E5515C Mobile Station Tester	Agilent	GB44050904	Mar. 2008
2	E4440A Spectrum Analyzer	Aglient	MY46186799	Mar. 2008
5	66309B DC Power Supply	Agilent	MY43000461	Aug. 2007
6	1506A Power Splitter	Weinschel	MN154	Aug. 2007
7	9.080m×5.255m×3.525m Shielding room	FRANKONIA	-----	Aug. 2007
8	ESI 40 EMI test receiver	R&S	100015	Aug. 2007
9	SMR 20 Signal generator	R&S	100086	Aug. 2007
10	CMU 200 Radio tester	R&S	100313	Aug. 2007
11	12.65m*8.03m*7.50m Fully-Anechoic Chamber	FRANKONIA	-----	Aug. 2007
12	HL562 Ultra log test antenna	R&S	100016	Aug. 2007
13	ESH3-Z2 Pulse limiter	R&S	10002	Aug. 2007
14	ESH3-Z5 Attenuator	R&S	100020	Aug. 2007
15	ESH2Z11 LISN	R&S	50FH-020-10	Aug. 2007
16	CMU 200 Radio tester	R&S	100313	Aug. 2007
17	HF 906 Double-Ridged Waveguide Horn Antenna	R&S	100030	Aug. 2007
18	HF 906 Double-Ridged Waveguide Horn Antenna	R&S	100029	Aug. 2007
19	PS2000 Turn Table	FRANKONIA	-----	Aug. 2007
20	MA260 Antenna Master	FRANKONIA	-----	Aug. 2007
21	SH-241 Climatic Chamber	ESPEC	92000389	Aug. 2007
22	E5515C Mobile Station Tester	Agilent	GB45071696	Aug. 2007
23	ES-K1 EMI test software	R&S	-----	Aug. 2007
24	HL562 Receive antenna	R&S	100167	Aug. 2007

Appendix

Appendix1 Test Setup