

6 5 4 3 2 1

REVISION RECORD			
LTN	ECO NO.	APPROVED	DATE

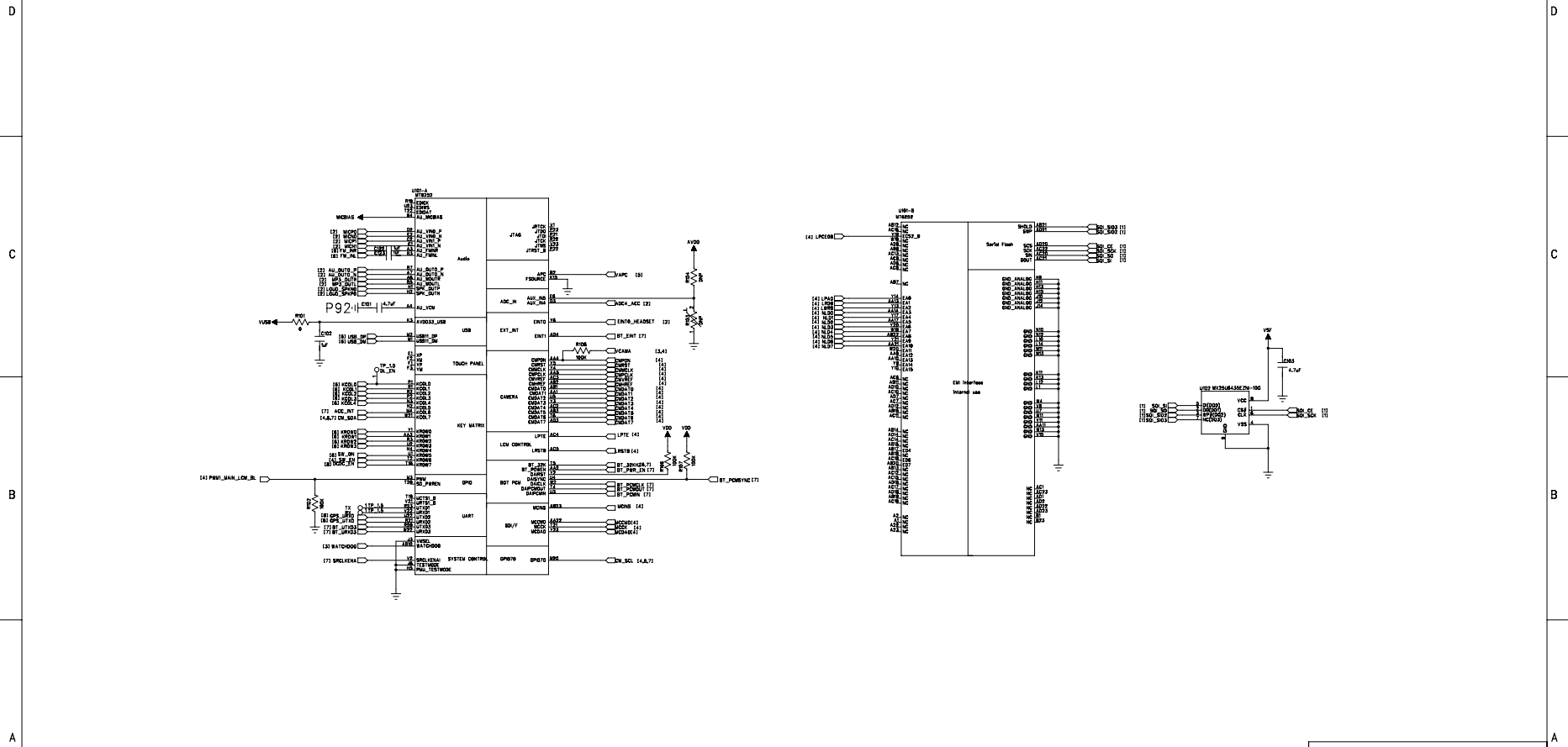

COMPANY:			
TITLE:			
BB_MEMORY			
DRAWN:	DATED:	CODE:	SIZE:
CHECKED:	DATED:	DRAWING NO.	REV.
QUALITY CONTROL:	DATED:		
RELEASED:	DATED:	SCALE:	SHEET: OF

REVISION RECORD			
LTN	ECO NO.	APPROVED:	DATE:

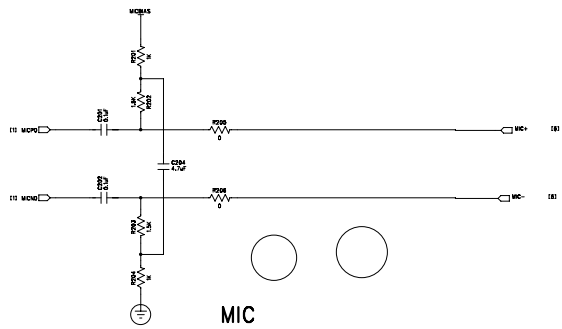

MIC

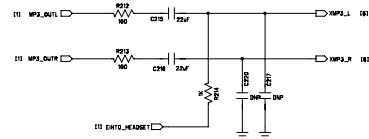

Headset spk

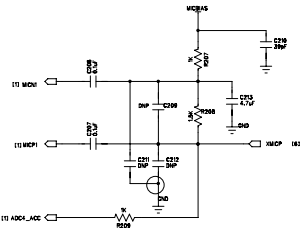

REVISION RECORD			
LT#	ECO NO.	APPROVED:	DATE:

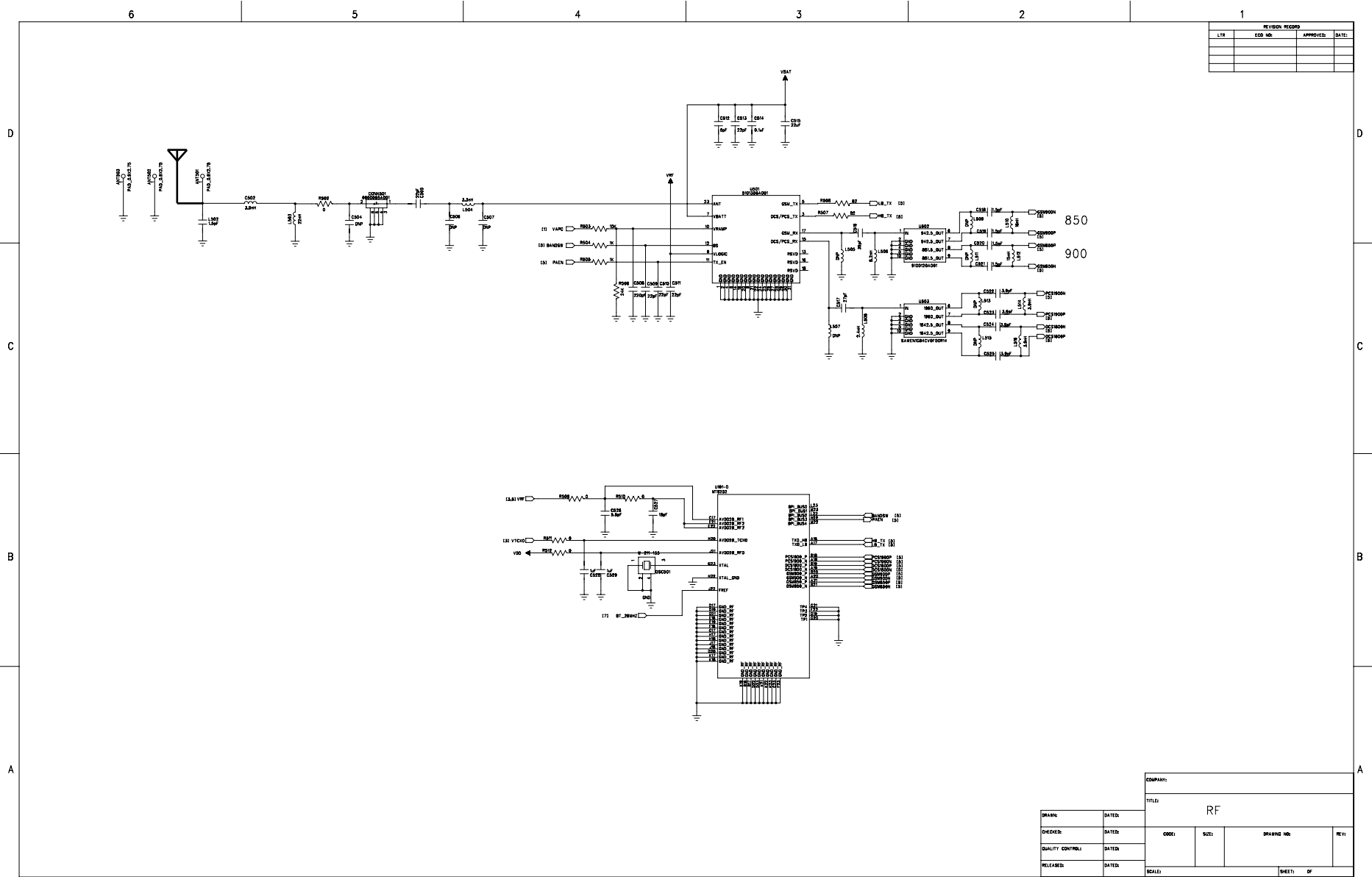

COMPANY:				
TITLE: RF				
DRAWN:	DATED:	CODE:	SIZE:	DRAWING NO.:
CHECKED:	DATED:			REV:
QUALITY CONTROL:	DATED:			
RELEASED:	DATED:	SCALE:	SHEET: OF	

6 5 4 3 2 1

REVISION RECORD			
LTN	ECO NO.	APPROVED:	DATE

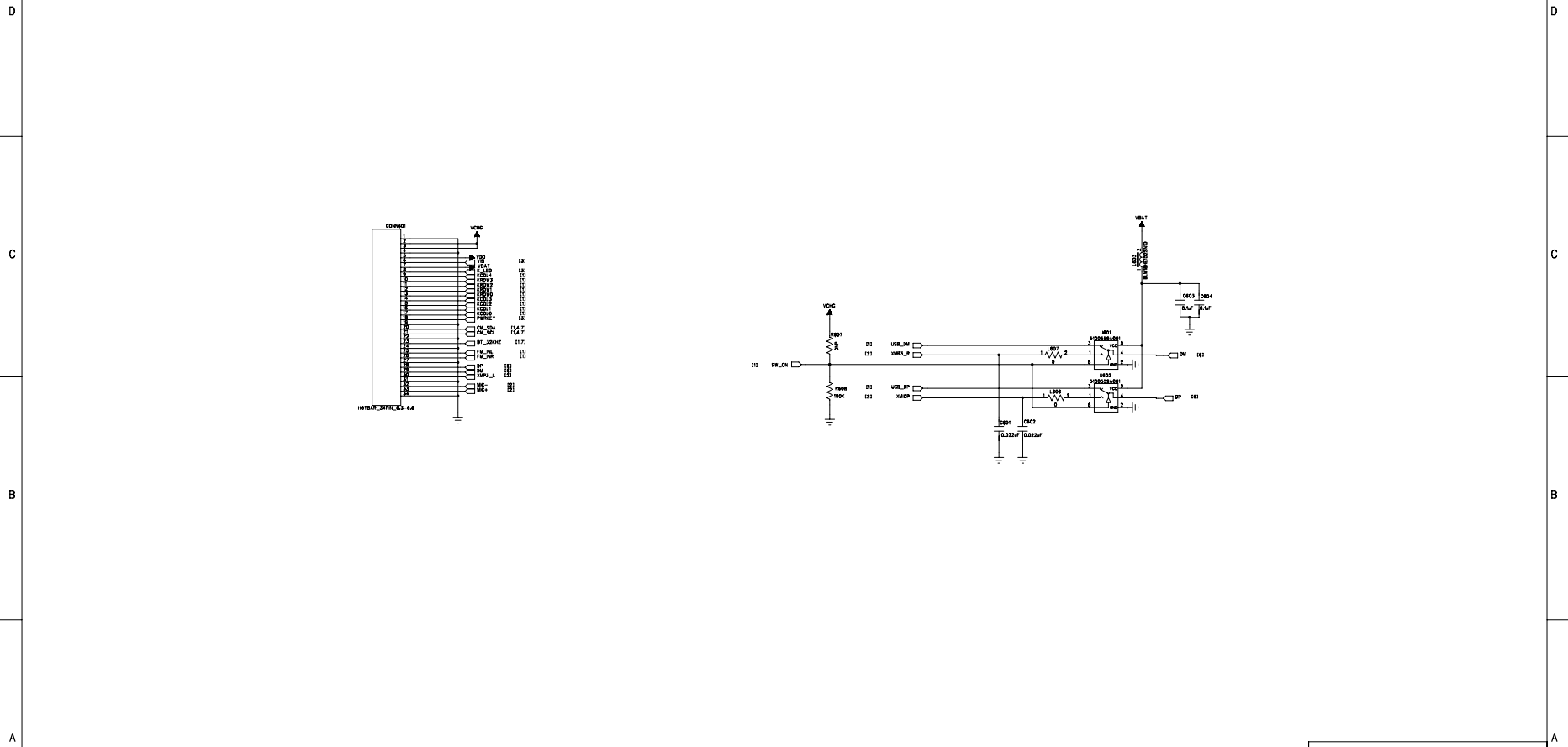

DRAWN:		DATED:		COMPANY:			
CHECKED:		DATED:		TITLE: KEYPAD_IO			
QUALITY CONTROL:		DATED:		CODE:	SIZE:	DRAWING NO.:	REV:
RELEASED:		DATED:		SCALE:		SHEET: OF	

6

5

4

3

2

1

REVISION RECORD			
LTN	ECO NO.	APPROVED:	DATE:

D

C

B

A

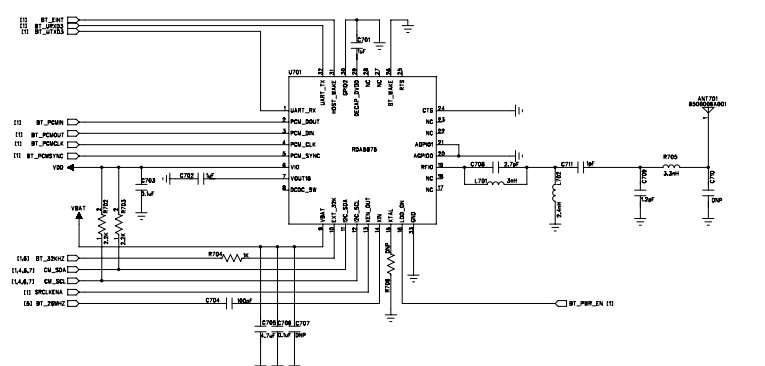

BLUETOOTH

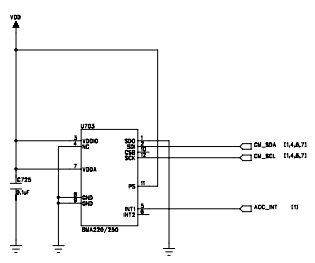

DRAWN:		DATED:		COMPANY:			
CHECKED:		DATED:		TITLE:			
QUALITY CONTROL:		DATED:		FM_BT			
RELEASED:		DATED:		CODE:	SIZE:	DRAWING NO:	REV:
				SCALE:		SHEET: OF	

REVISION RECORD			
LTN	ECO NO.	APPROVED	DATE

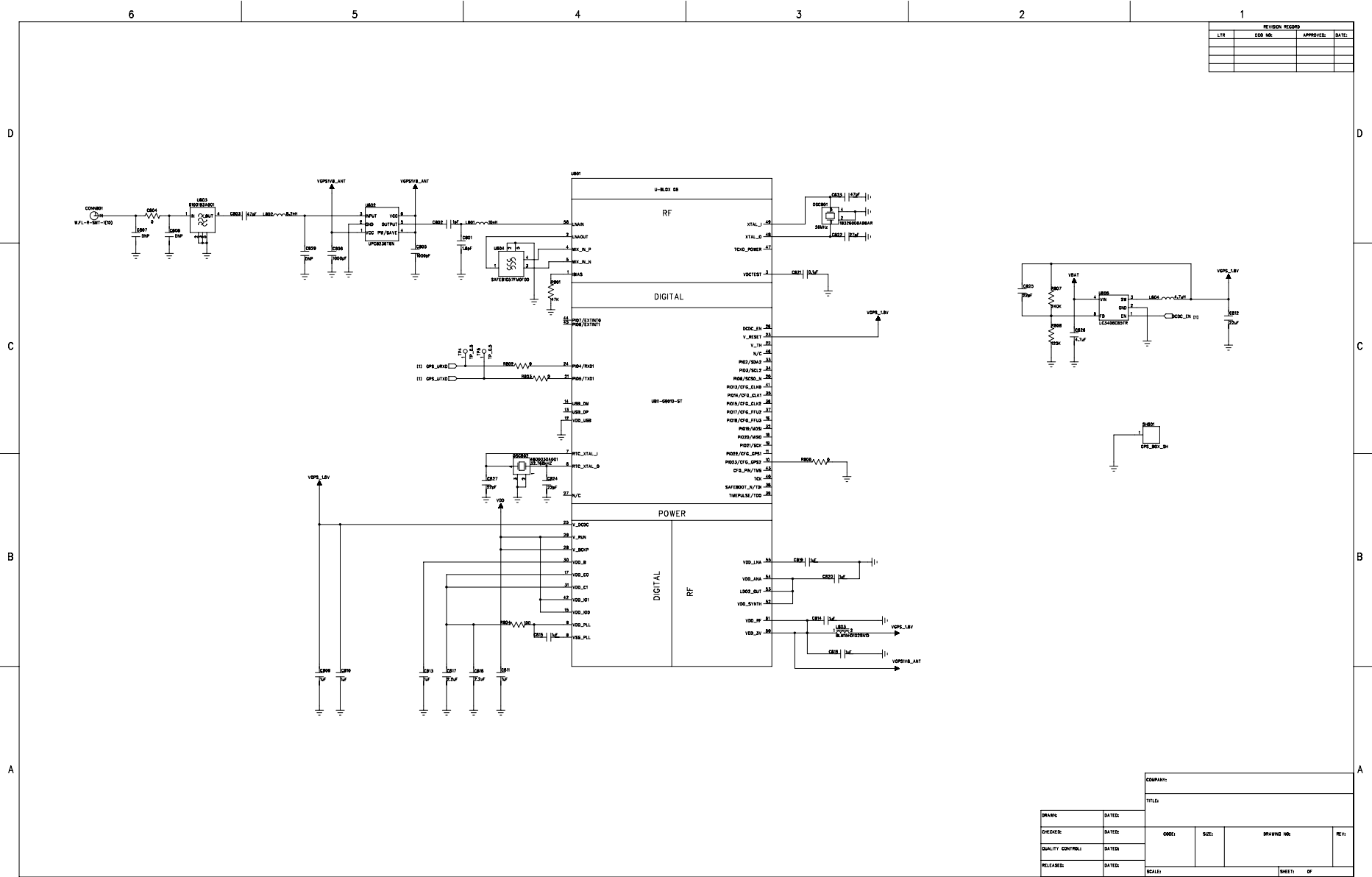

COMPANY:				
TITLE:				
DRAWN:	DATE:	CODE:	SIZE:	DRAWING NO. REV.
CHECKED:	DATE:			
QUALITY CONTROL:	DATE:			
RELEASED:	DATE:	SCALE:	SHEET: OF	