

FCC PART 22H, PART 24E

MEASUREMENT AND TEST REPORT

For

Verykool USA Inc.

4350 Executive Dr. #100, San Diego, CA 92121, USA

FCC ID: WA6I119D

Report Type: Original Report	Product Type: GSM Mobile Phone
Test Engineer: Back Huang	<i>Back Huang</i>
Report Number: RSZ10121702-22H&24E	
Report Date: 2010-12-31	
Reviewed By: EMC Engineer	Merry Zhao <i>Merry Zhao</i>
Prepared By:	Bay Area Compliance Laboratories Corp. (Shenzhen) 6/F, the 3rd Phase of WanLi Industrial Building, ShiHua Road, FuTian Free Trade Zone Shenzhen, Guangdong, China Tel: +86-755-33320018 Fax: +86-755-33320008

Note: This test report is prepared for the customer shown above and for the device described herein. It may not be duplicated or used in part without prior written consent from Bay Area Compliance Laboratories Corp. This report **must not** be used by the customer to claim product certification, approval, or endorsement by NVLAP*, NIST, or any agency of the Federal Government.

* This report contains data that are not covered by the NVLAP accreditation and are marked with an asterisk "★" (Rev.2)

TABLE OF CONTENTS

GENERAL INFORMATION.....4

 PRODUCT DESCRIPTION FOR EQUIPMENT UNDER TEST (EUT)4

 OBJECTIVE4

 RELATED SUBMITTAL(S)/GRANT(S).....4

 TEST METHODOLOGY4

 TEST FACILITY5

SYSTEM TEST CONFIGURATION.....6

 JUSTIFICATION6

 EQUIPMENT MODIFICATIONS6

 CONFIGURATION OF TEST SETUP6

 BLOCK DIAGRAM OF TEST SETUP6

SUMMARY OF TEST RESULTS7

FCC §1.1307 & §2.1093 - RF EXPOSURE.....8

 APPLICABLE STANDARDS.....8

 TEST RESULT8

FCC §2.1047 - MODULATION CHARACTERISTIC9

FCC §2.1046, §22.913 (A) & §24.232 (C) - RF OUTPUT POWER.....10

 APPLICABLE STANDARDS.....10

 TEST PROCEDURE10

 TEST EQUIPMENT LIST AND DETAILS.....10

 TEST DATA11

FCC §2.1049, §22.917, §22.905 & §24.238 - OCCUPIED BANDWIDTH13

 APPLICABLE STANDARDS.....13

 TEST PROCEDURE13

 TEST EQUIPMENT LIST AND DETAILS.....13

 TEST DATA13

FCC §2.1051, §22.917(A) & §24.238(A) - SPURIOUS EMISSIONS AT ANTENNA TERMINALS17

 APPLICABLE STANDARDS.....17

 TEST PROCEDURE17

 TEST EQUIPMENT LIST AND DETAILS.....17

 TEST DATA18

FCC §2.1053, §22.917 & §24.238 - SPURIOUS RADIATED EMISSIONS21

 APPLICABLE STANDARDS.....21

 TEST PROCEDURE21

 TEST EQUIPMENT LIST AND DETAILS.....21

 TEST DATA22

FCC §22.917(A) & §24.238(A) - BAND EDGES.....24

 APPLICABLE STANDARDS.....24

 TEST PROCEDURE24

 TEST EQUIPMENT LIST AND DETAILS.....24

 TEST DATA24

FCC §2.1055, §22.355 & §24.235 - FREQUENCY STABILITY.....	28
APPLICABLE STANDARDS.....	28
TEST PROCEDURE	28
TEST EQUIPMENT LIST AND DETAILS.....	29
TEST DATA	29

GENERAL INFORMATION

Product Description for Equipment under Test (EUT)

The *Verykool USA Inc's* product, model number: *i119D (FCC ID: WA6I119D)* or the "EUT" as referred to in this report is a *GSM Mobile Phone*, which measures approximately: 10.40 cm (L) x 4.50 cm (W) x 1.30 cm (H), rated input voltage: DC 3.7 V battery.

All measurement and test data in this report was gathered from production sample serial number: 1012076 (Assigned by BACL, Shenzhen). The EUT was received on 2010-12-24.

Objective

This type approval report is prepared on behalf of *Verykool USA Inc* in accordance with Part 2, Subpart J, Part 22 Subpart H, and Part 24 Subpart E of the Federal Communication Commissions rules.

The objective is to determine compliance with FCC rules for output power, modulation characteristic, occupied bandwidth, and spurious emission at antenna terminal, spurious radiated emission, frequency stability, band edge and radiated margin.

Related Submittal(s)/Grant(s)

None.

Test Methodology

All tests and measurements indicated in this document were performed in accordance with the Code of Federal Regulations Title 47 Part 2, Sub-part J as well as the following parts:

Part 22 Subpart H - Public Mobile Services
Part 24 Subpart E - Personal Communication Services

Applicable Standards: TIA/EIA 603-C, ANSI C63.4-2009.

All radiated and conducted emissions measurements were performed at Bay Area Compliance Laboratories Corp. The radiated testing was performed at an antenna-to-EUT distance of 3 meters.

The uncertainty of any RF tests which use conducted method measurement is ± 0.96 dB, the uncertainty of any radiation emissions measurement is ± 4.0 dB.

Test Facility

The Test site used by Bay Area Compliance Laboratories Corp.(Shenzhen) to collect test data is located in the 6/F, the 3rd Phase of WanLi Industrial Building, ShiHua Road, FuTian Free Trade Zone Shenzhen, Guangdong, China.

Test site at Bay Area Compliance Laboratories Corp. (Shenzhen) has been fully described in reports submitted to the Federal Communication Commission (FCC). The details of these reports have been found to be in compliance with the requirements of Section 2.948 of the FCC Rules on December 31, 2010. The facility also complies with the radiated and AC line conducted test site criteria set forth in ANSI C63.4-2009.

The Federal Communications Commission has the reports on file and is listed under FCC Registration No.: 382179. The test site has been approved by the FCC for public use and is listed in the FCC Public Access Link (PAL) database.

Additionally, Bay Area Compliance Laboratories Corp. (Shenzhen) is a National Institute of Standards and Technology (NIST) accredited laboratory, under the National Voluntary Laboratory Accredited Program (Lab Code 200707-0).



The current scope of accreditations can be found at <http://ts.nist.gov/Standards/scopes/2007070.htm>

SYSTEM TEST CONFIGURATION

Justification

The EUT was configured for testing according to TIA/EIA-603-C.

The GSM/PCS item test was performed with the EUT operating at normal mode.

The GPRS item test was performed with the EUT operating at engineering mode.

Equipment Modifications

No modifications were made to the EUT.

Configuration of Test Setup

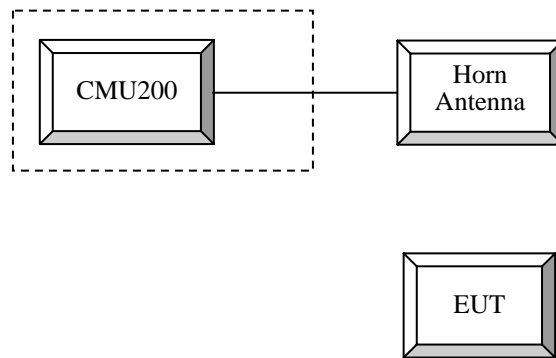

Block Diagram of Test Setup

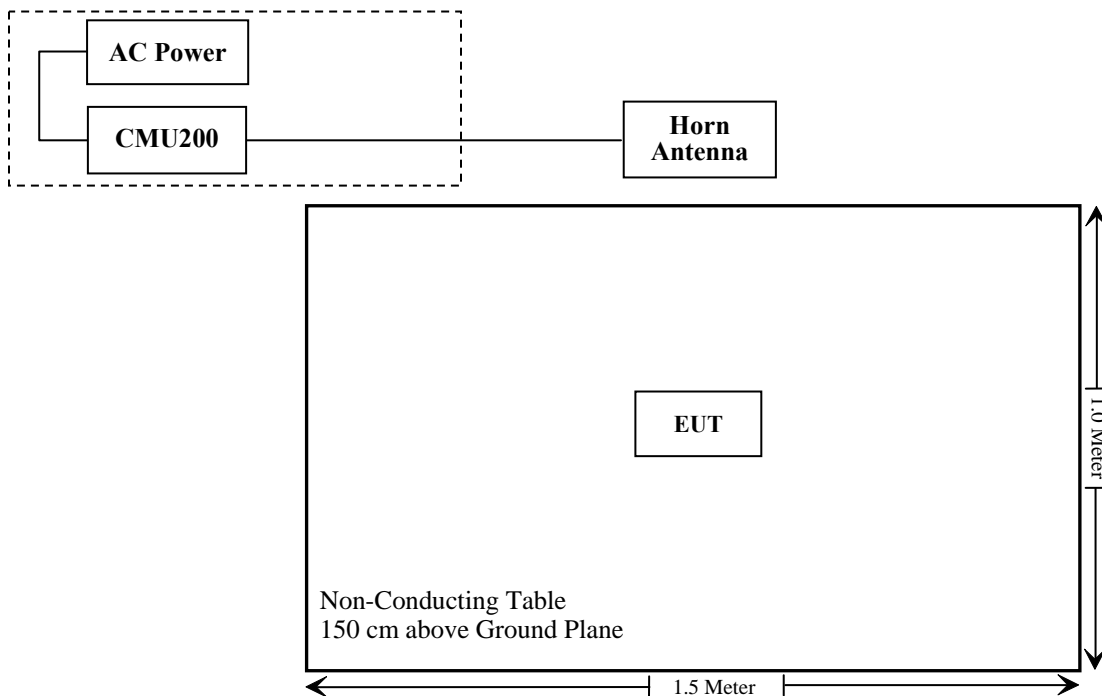

SUMMARY OF TEST RESULTS

FCC Rules	Description of Test	Result
§1.1307, §2.1093	RF Exposure (SAR)	Compliance*
§2.1046; §22.913 (a); §24.232 (c)	RF Output Power	Compliance
§ 2.1047	Modulation Characteristics	N/A
§2.1049; §22.905 §22.917; §24.238	99% & -26 dB Occupied Bandwidth	Compliance
§2.1051, §22.917 (a); §24.238 (a)	Spurious Emissions at Antenna Terminal	Compliance
§2.1053 §22.917 (a); §24.238 (a)	Field Strength of Spurious Radiation	Compliance
§22.917 (a); §24.238 (a)	Out of band emission, Band Edge	Compliance
§2.1055 §22.355; §24.235	Frequency stability vs. temperature Frequency stability vs. voltage	Compliance

* SAR report released by BAEL, Report Number: RSZ10121702-SAR

FCC §1.1307 & §2.1093 - RF EXPOSURE

Applicable Standards

FCC§1.1307 and §2.1093.

Test Result

Compliance

The EUT is a portable device, thus requires SAR evaluation; please refer to BA CL SAR Report: RSZ10121702-SAR.

FCC §2.1047 - MODULATION CHARACTERISTIC

According to FCC § 2.1047(d), Part 22H & 24E there is no specific requirement for digital modulation, therefore modulation characteristic is not presented.

FCC §2.1046, §22.913 (a) & §24.232 (c) - RF OUTPUT POWER

Applicable Standards

According to FCC §2.1046 and §22.913 (a), the ERP of mobile transmitters and auxiliary test transmitters must not exceed 7 watts.

According to FCC §2.1046 and §24.232 (C), mobile and portable stations are limited to 2 watts EIRP and the equipment must employ a means for limiting power to the minimum necessary for successful communications..

Test Procedure

Conducted method:

The RF output of the transmitter was connected to the wireless test set and the spectrum analyzer through sufficient attenuation.

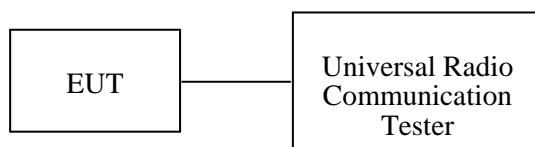

Radiated method:

TIA 603-C section 2.2.17

Test Equipment List and Details

Manufacturer	Description	Model	Serial Number	Calibration Date	Calibration Due Date
Sunol Sciences	Horn Antenna	DRH-118	A052604	2010-05-05	2011-05-04
Rohde & Schwarz	Spectrum Analyzer	FSEM30	849720/019	2010-07-08	2011-07-07
Sunol Sciences	Broadband Antenna	JB1	A040904-1	2010-03-11	2011-03-11
HP	Amplifier	2VA-213+	T-E27H	2010-03-08	2011-03-07
HP	Signal Generator	HP8657A	2849U00982	2010-10-28	2011-10-27
HP	Amplifier	HP8447D	2944A09795	2010-08-02	2011-08-02
HP	Synthesized Sweeper	8341B	2624A00116	2010-11-07	2011-11-06
COM POWER	Dipole Antenna	AD-100	041000	2010-09-25	2011-09-25
A.H. System	Horn Antenna	SAS-200/571	135	2010-05-17	2011-05-17
Rohde & Schwarz	Universal Radio Communication Tester	CMU200	109038	2010-06-11	2011-06-10

* **Statement of Traceability:** Bay Area Compliance Laboratories Corp. (Shenzhen) attests that all calibrations have been performed in accordance to NVLAP requirements, traceable to the NIST.

Test Data**Environmental Conditions**

Temperature:	25 °C
Relative Humidity:	56 %
ATM Pressure:	100.0kPa

The testing was performed by Back Huang on 2010-12-30.

Conducted Power:

Cellular Band (Part 22H)

Mode	Channel	Frequency (MHz)	Output Power (dBm)	Limit (dBm)
GSM	128	824.2	31.98	38.45
	190	836.6	31.93	38.45
	251	848.8	32.04	38.45

Mode	Channel No	Frequency (MHz)	Output Power (dBm)		Limit (dBm)
			1 uplink slot	2 uplink slot	
GPRS	128	824.2	31.94	31.68	38.45
	190	836.6	31.71	31.56	38.45
	251	848.8	31.82	31.63	38.45

PCS Band (Part 24E)

Mode	Channel	Frequency (MHz)	Output Power (dBm)	Limit (dBm)
GSM	512	1850.2	29.46	33
	661	1880.0	29.72	33
	810	1909.8	29.51	33

Mode	Channel No	Frequency (MHz)	Output Power (dBm)		Limit (dBm)
			1 uplink slot	2 uplink slot	
GPRS	512	1850.2	28.91	28.79	33
	661	1880.0	29.16	29.04	33
	810	1909.8	29.02	28.91	33

ERP & EIRP (worst case):

ERP for Cellular Band (Part 22H)

Indicated		Table Angle Degree	Test Antenna		Substituted			Antenna Gain Correction (dBd)	Cable Loss (dB)	Absolute Level (dBm)	Part 22H Limit (dBm)
Frequency (MHz)	S.A. Reading (dBμV)		Height (m)	Polar (H/V)	Frequency (MHz)	S.G. Level (dBm)	Ant. Polar (H/V)				
High Channel											
848.8	101.21	271	2.6	H	848.8	28.8	H	0	0.9	27.90	38.45
848.8	106.90	225	2.1	V	848.8	20.1	V	0	0.9	19.20	38.45

EIRP for PCS Band (Part 24E)

Indicated		Table Angle Degree	Test Antenna		Substituted			Antenna Gain Correction (dBi)	Cable Loss (dB)	Absolute Level (dBm)	Part 24E Limit (dBm)
Frequency (MHz)	S.A. Reading (dBμV)		Height (m)	Polar (H/V)	Frequency (MHz)	S.G. Level (dBm)	Ant. Polar (H/V)				
Middle Channel											
1880.0	91.51	185	2.0	H	1880.0	21.4	H	6.2	2.53	25.07	33
1880.0	93.79	124	2.5	V	1880.0	16.3	V	6.2	2.53	19.97	33

Note: all above data were tested with no amplifier.

FCC §2.1049, §22.917, §22.905 & §24.238 - OCCUPIED BANDWIDTH

Applicable Standards

FCC §2.1049, §22.917, §22.905 and §24.238.

Test Procedure

The RF output of the transmitter was connected to the simulator and the spectrum analyzer through sufficient attenuation.

The resolution bandwidth of the spectrum analyzer was set at 30 kHz (Cellular /PCS) and the 26 dB & 99% bandwidth was recorded.

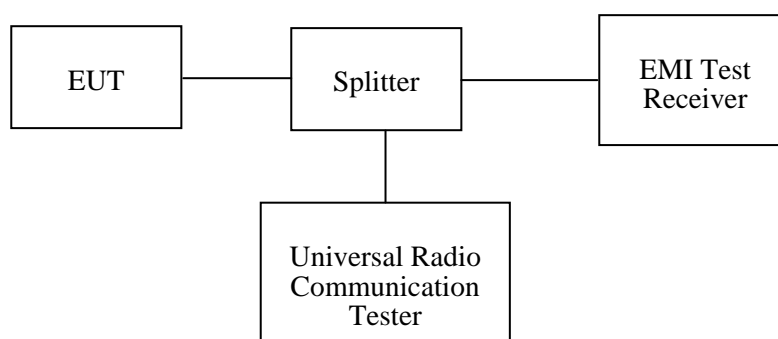

Test Equipment List and Details

Manufacturer	Description	Model	Serial Number	Calibration Date	Calibration Due Date
Rohde & Schwarz	EMI Test Receiver	ESCI	100224	2009-11-24	2010-11-23
Rohde & Schwarz	Universal Radio Communication Tester	CMU200	109038	2010-06-11	2011-06-10

* **Statement of Traceability:** Bay Area Compliance Laboratories Corp. (Shenzhen) attests that all calibrations have been performed in accordance to NVLAP requirements, traceable to the NIST.

Test Data

Environmental Conditions

Temperature:	25 °C
Relative Humidity:	56%
ATM Pressure:	100.0kPa

The testing was performed by Back Huang on 2010-12-27.

GMSK:

Cellular Band (Part 22H)

Channel	Frequency (MHz)	99% Occupied Bandwidth (kHz)	26 dB Bandwidth (kHz)
190	836.6	252.0	336.0

PCS Band (Part 24E)

Channel	Frequency (MHz)	99% Occupied Bandwidth (kHz)	26 dB Bandwidth (kHz)
661	1880.0	252.0	336.0

Please refer to the following plots.

Cellular Band (Part 22H)

99% Occupied Bandwidth

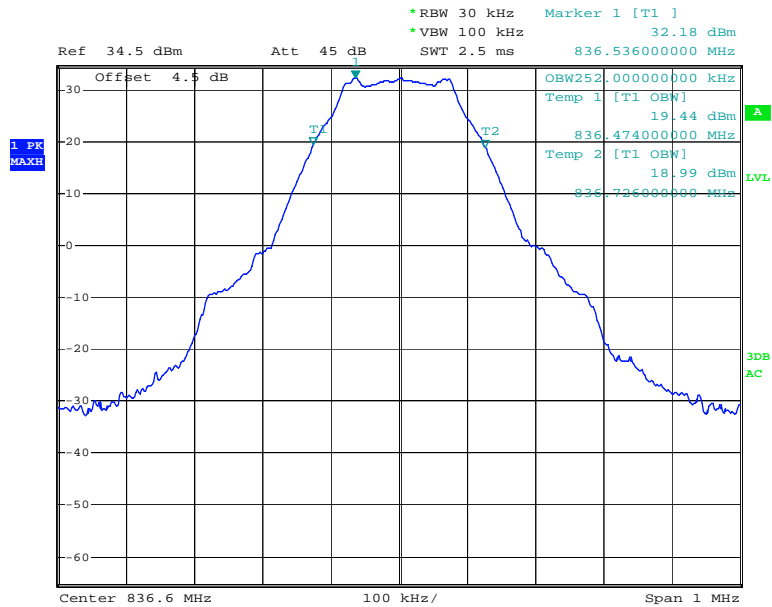

Date: 27.DEC.2010 17:53:37

26 dB Occupied Bandwidth

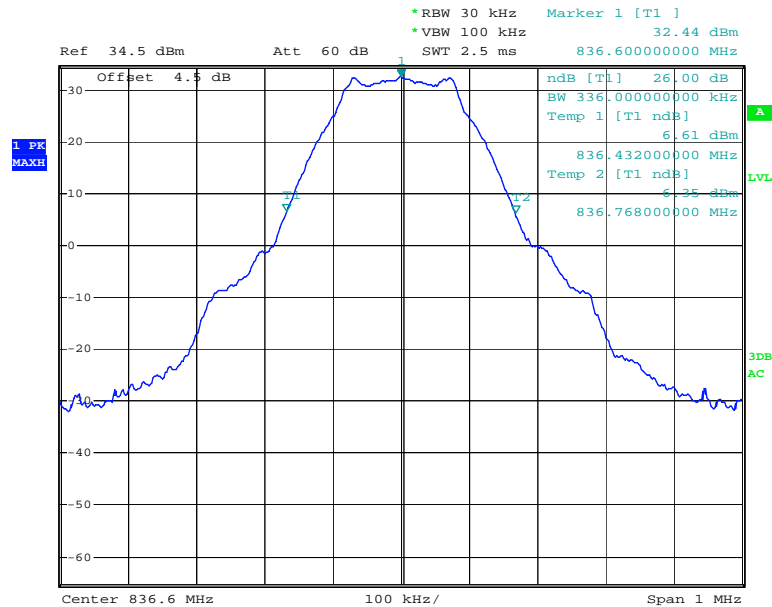

Date: 27.DEC.2010 17:52:20

PCS Band (Part 24E)

99% Occupied Bandwidth

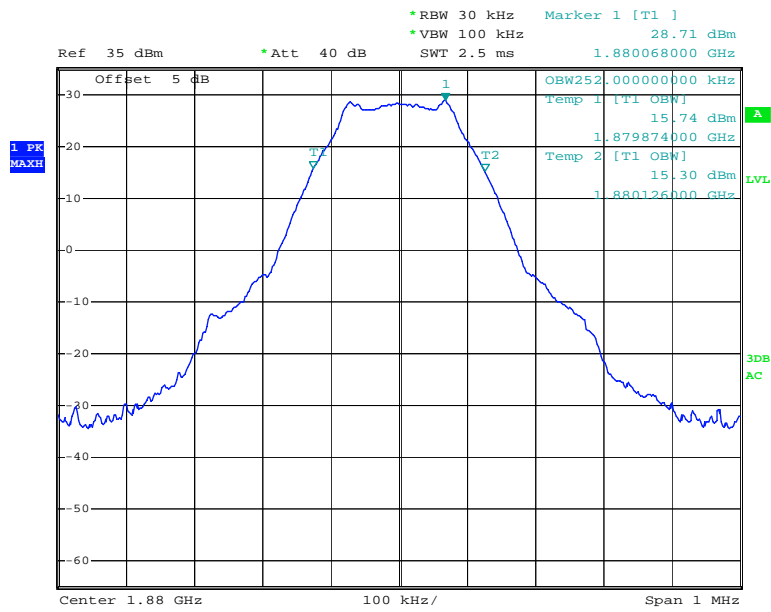

Date: 27.DEC.2010 17:49:50

26 dB Occupied Bandwidth

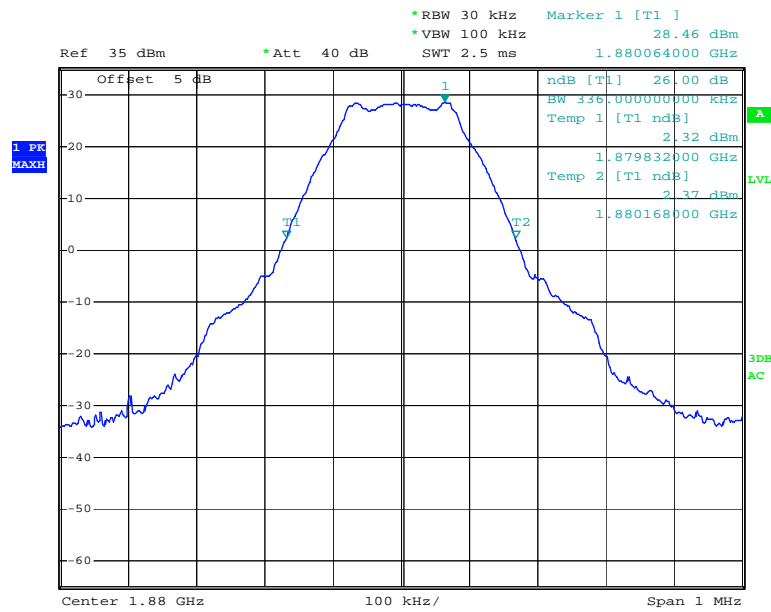

Date: 27.DEC.2010 17:48:38

FCC §2.1051, §22.917(a) & §24.238(a) - SPURIOUS EMISSIONS AT ANTENNA TERMINALS

Applicable Standards

FCC§2.1051, §22.917(a) and §24.238(a).

The spectrum was to be investigated to the tenth harmonics of the highest fundamental frequency as specified in § 2.1051.

Test Procedure

The RF output of the transceiver was connected to a spectrum analyzer and simulator through appropriate attenuation. The resolution bandwidth of the spectrum analyzer was set at 100 kHz. Sufficient scans were taken to show any out of band emissions up to 10th harmonic.

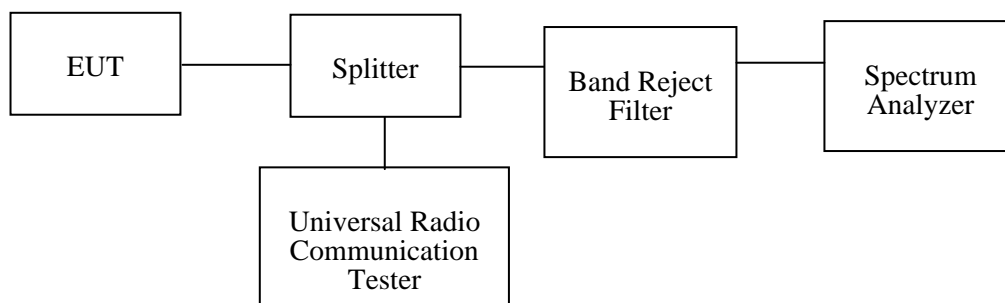

Test Equipment List and Details

Manufacturer	Description	Model	Serial Number	Calibration Date	Calibration Due Date
Rohde & Schwarz	Spectrum Analyzer	FSEM30	849720/019	2010-07-08	2011-07-07
Rohde & Schwarz	Universal Radio Communication Tester	CMU200	109038	2010-06-11	2011-06-10
Rohde & Schwarz	EMI Test Receiver	ESCI	100224	2010-11-25	2011-11-24
Wainwright Germany	Band Reject Filter	WRCG1850/1910-1835/1925-40/8SS	22	2010-02-28	2011-02-28
Wainwright Germany	Band Reject Filter	WRCG823/850-813/860-40/8SS	7	2010-02-28	2011-02-28

* **Statement of Traceability:** Bay Area Compliance Laboratories Corp. (Shenzhen) attests that all calibrations have been performed in accordance to NVLAP requirements, traceable to the NIST.

Test Data

Environmental Conditions

Temperature:	25 °C
Relative Humidity:	56 %
ATM Pressure:	100.0kPa

The testing was performed by Back Huang on 2010-12-28.

Cellular Band (Part 22H)

30 – 1000 MHz - Middle Channel

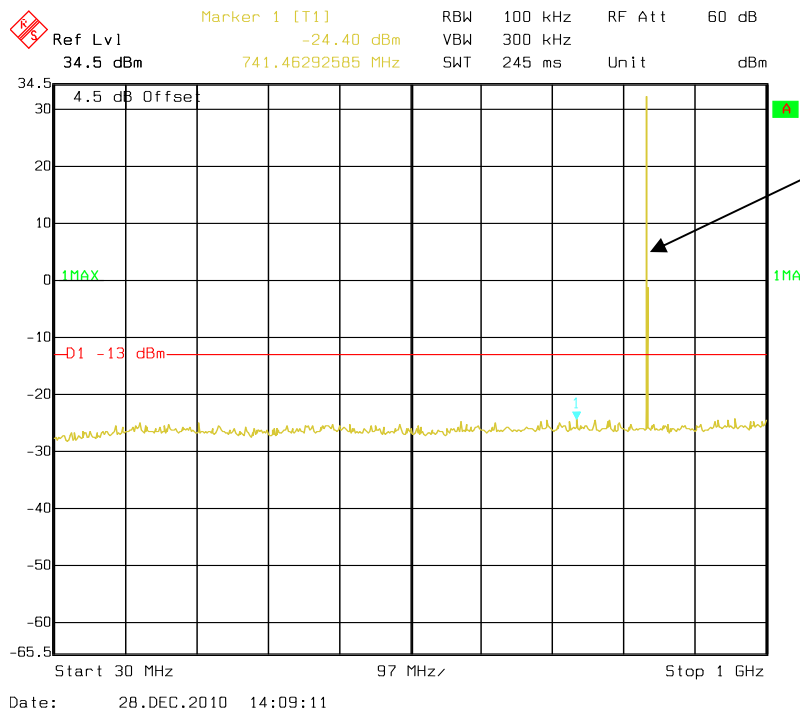

Fundamental test with band reject filter

1 – 10 GHz - Middle Channel

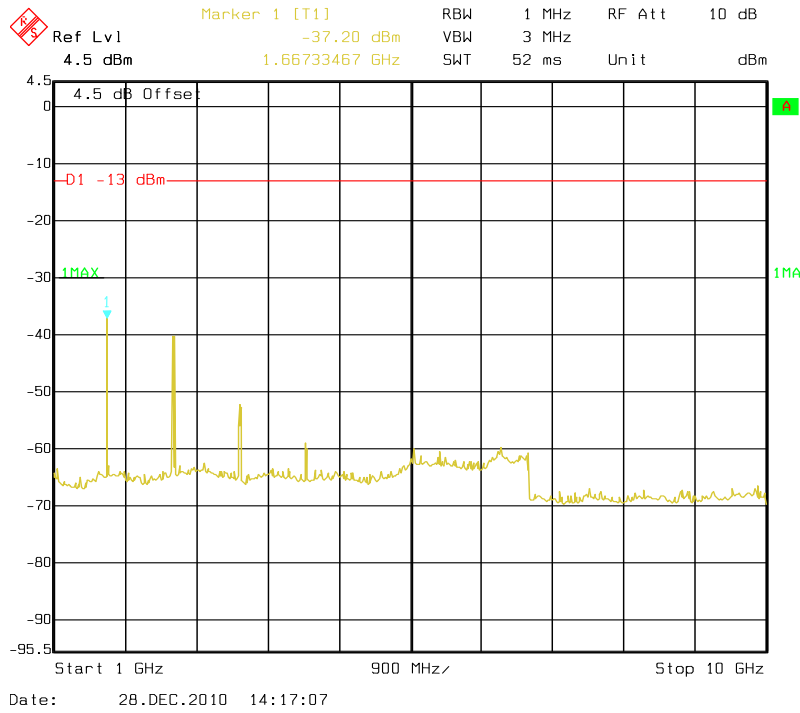

PCS Band (Part24E)

30 – 1000 MHz - Middle Channel

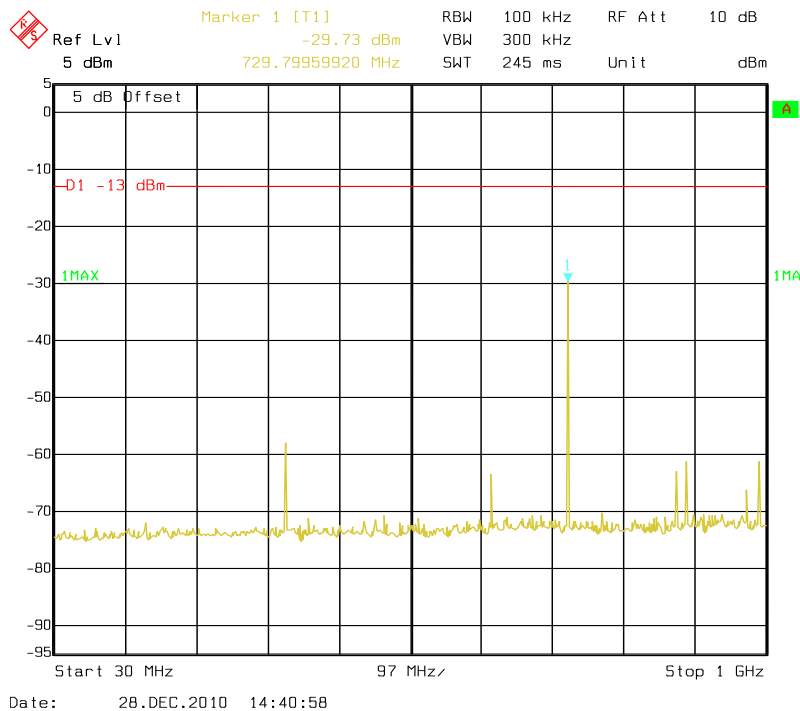

1 - 2 GHz - Middle Channel

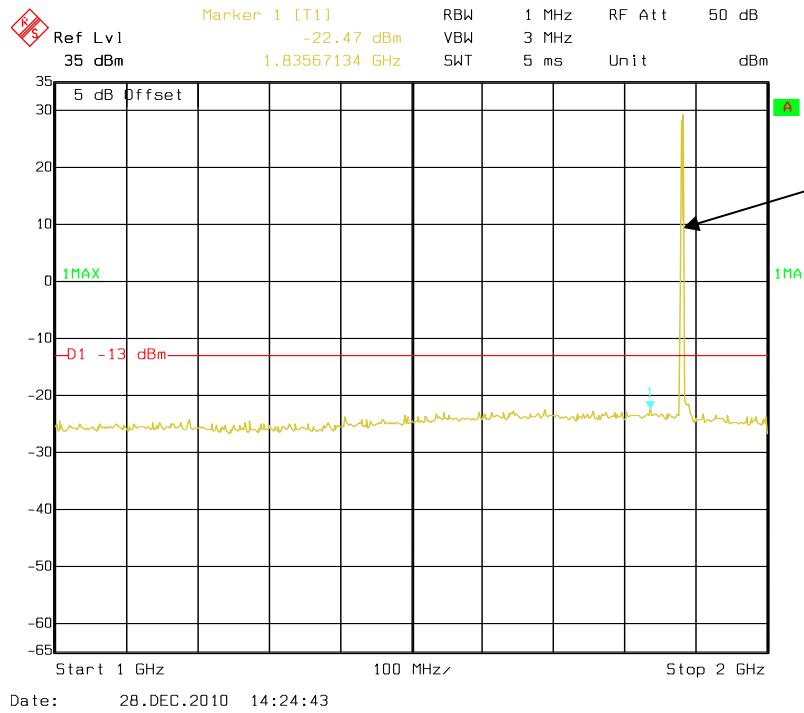

2 - 20 GHz - Middle Channel

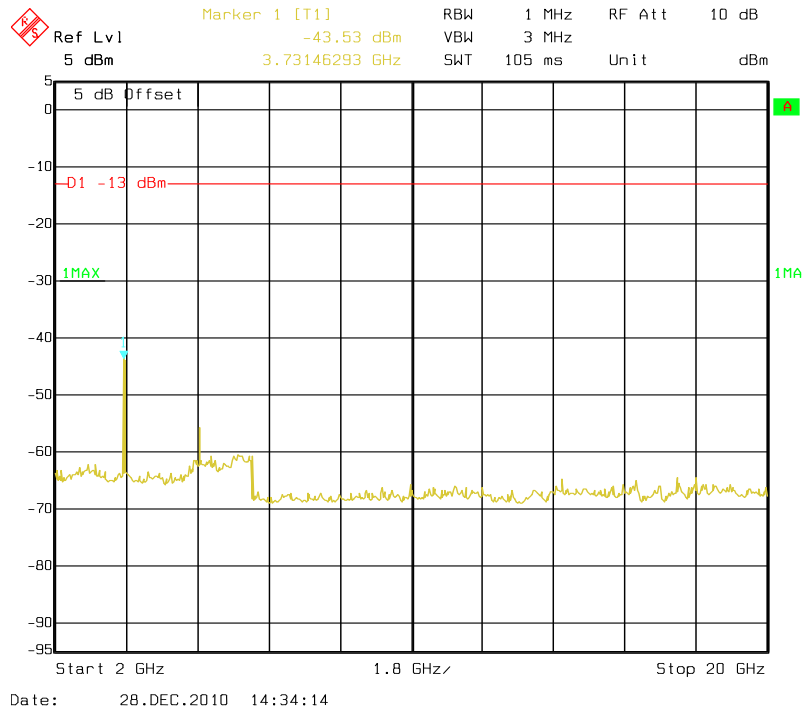

FCC §2.1053, §22.917 & §24.238 - SPURIOUS RADIATED EMISSIONS

Applicable Standards

FCC§ 2.1053, §22.917 and § 24.238.

Test Procedure

The transmitter was placed on a wooden turntable, and it was transmitting into a non-radiating load which was also placed on the turntable.

The measurement antenna was placed at a distance of 3 meters from the EUT. During the tests, the antenna height and polarization as well as EUT azimuth were varied in order to identify the maximum level of emissions from the EUT. The test was performed by placing the EUT on 3-orthogonal axis.

The frequency range up to tenth harmonic of the fundamental frequency was investigated.

Remove the EUT and replace it with substitution antenna. A signal generator was connected to the substitution antenna by a non-radiating cable. The absolute levels of the spurious emissions were measured by the substitution.

Spurious emissions in dB = $10 \lg(\text{TXpwr in Watts}/0.001)$ – the absolute level

Spurious attenuation limit in dB = $43 + 10 \text{Log}_{10}(\text{power out in Watts})$

Test Equipment List and Details

Manufacturer	Description	Model	Serial Number	Calibration Date	Calibration Due Date
Sunol Sciences	Horn Antenna	DRH-118	A052604	2010-05-05	2011-05-04
Sunol Sciences	Broadband Antenna	JB1	A040904-1	2010-03-11	2011-03-11
Rohde & Schwarz	Spectrum Analyzer	FSEM30	849720/019	2010-07-08	2011-07-07
HP	Amplifier	2VA-213+	T-E27H	2010-03-08	2011-03-07
HP	Signal Generator	HP8657A	2849U00982	2010-10-28	2011-10-27
HP	Amplifier	HP8447D	2944A09795	2010-08-02	2011-08-02
HP	Synthesized Sweeper	8341B	2624A00116	2010-11-07	2011-11-06
COM POWER	Dipole Antenna	AD-100	041000	2010-09-25	2011-09-25
A.H. System	Horn Antenna	SAS-200/571	135	2010-05-17	2011-05-17
Rohde & Schwarz	Universal Radio Communication Tester	CMU200	109038	2010-06-11	2011-06-10

* **Statement of Traceability:** Bay Area Compliance Laboratories Corp. (Shenzhen) attests that all calibrations have been performed in accordance to NVLAP requirements, traceable to the NIST.

Test Data**Environmental Conditions**

Temperature:	25 °C
Relative Humidity:	56 %
ATM Pressure:	100.0kPa

The testing was performed by Back Huang on 2010-12-29.

Test mode: Transmitting

Cellular Band (Part 22H)

Indicated		Table Angle Degree	Test Antenna		Substituted				Absolute Level (dBm)	Limit (dBm)	Margin (dB)
Frequency (MHz)	S.A. Reading (dBμV)		Height (m)	Polar (H/V)	Frequency (MHz)	Level (dBm)	Ant. Gain (dBi)	Cable Loss (dB)			
High Channel, Below 1 GHz											
470.86	46.77	213	1.6	V	470.86	-50.8	0	0.65	-51.45	-13	38.45
249.22	45.66	152	1.5	V	249.22	-51.8	0	0.55	-52.35	-13	39.35
470.86	44.36	249	1.2	H	470.86	-52.4	0	0.65	-53.05	-13	40.05
249.22	43.13	171	1.3	H	249.22	-53.5	0	0.55	-54.05	-13	41.05
High Channel, Above 1 GHz											
1697.6	59.36	352	1.8	H	1697.6	-39.5	6.2	2.40	-35.70	-13	22.70
1697.6	64.16	187	1.4	V	1697.6	-41.1	6.2	2.40	-37.30	-13	24.30
2546.4	47.76	294	1.8	H	2546.4	-50.4	7.3	3.21	-46.31	-13	33.31
2546.4	52.81	188	1.5	V	2546.4	-51.8	7.3	3.21	-47.71	-13	34.71
3395.2	37.84	157	1.6	H	3395.2	-53.7	6.7	3.58	-50.58	-13	37.58
3395.2	40.97	286	1.4	V	3395.2	-55.1	6.7	3.58	-51.98	-13	38.98

PCS Band (Part 24E)

Indicated		Table Angle Degree	Test Antenna		Substituted				Absolute Level (dBm)	Limit (dBm)	Margin (dB)
Frequency (MHz)	S.A. Reading (dB μ V)		Height (m)	Polar (H/V)	Frequency (MHz)	Level (dBm)	Ant. Gain (dBi)	Cable Loss (dB)			
Middle Channel, Below 1 GHz											
415.33	44.37	243	1.2	V	415.33	-55.2	0	0.63	-55.83	-13	42.83
199.26	45.79	122	1.5	V	199.26	-55.7	0	0.50	-56.20	-13	43.20
199.26	43.24	187	1.4	H	199.26	-57.9	0	0.50	-58.40	-13	45.40
415.33	42.62	72	1.5	H	415.33	-57.9	0	0.63	-58.53	-13	45.53
Middle Channel, Above 1 GHz											
5640	46.34	174	1.6	H	5640	-40.7	8.3	4.66	-37.06	-13	24.06
5640	50.48	83	1.2	V	5640	-42.1	8.3	4.66	-38.46	-13	25.46
7520	35.74	181	1.3	H	7520	-48.7	7.6	5.33	-46.43	-13	33.43
3760	55.25	246	1.6	H	3760	-50.1	6.9	3.75	-46.95	-13	33.95
7520	38.36	117	1.5	V	7520	-49.3	7.6	5.33	-47.03	-13	34.03
3760	59.45	193	1.5	V	3760	-51.5	6.9	3.75	-48.35	-13	35.35

FCC §22.917(a) & §24.238(a) - BAND EDGES

Applicable Standards

According to § 22.917(a), the power of any emissions outside of the authorized operating frequency ranges must be attenuated below the transmitting power (P) by a factor of at least $43 + 10 \log(P)$ dB.

According to §24.238(a), the power of any emissions outside of the authorized operating frequency ranges must be attenuated below the transmitting power (P) by a factor of at least $43 + 10 \log(P)$ dB.

Test Procedure

The RF output of the transmitter was connected to the input of the spectrum analyzer through sufficient attenuation.

The center of the spectrum analyzer was set to block edge frequency, RBW set to 10 kHz.

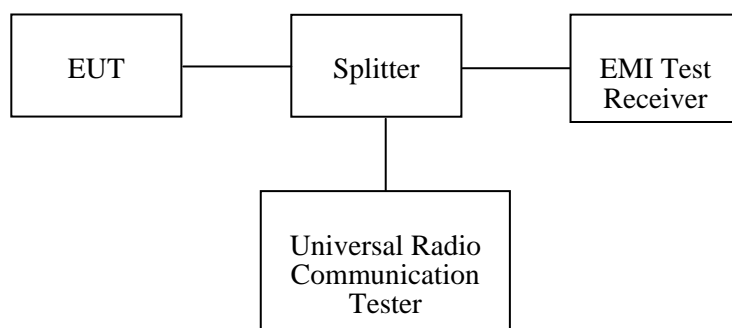

Test Equipment List and Details

Manufacturer	Description	Model	Serial Number	Calibration Date	Calibration Due Date
Rohde & Schwarz	EMI Test Receiver	ESCI	100224	2010-11-24	2011-11-23
Rohde & Schwarz	Universal Radio Communication Tester	CMU200	109038	2010-06-11	2011-06-10

* **Statement of Traceability:** Bay Area Compliance Laboratories Corp. (Shenzhen) attests that all calibrations have been performed in accordance to NVLAP requirements, traceable to the NIST.

Test Data

Environmental Conditions

Temperature:	25 °C
Relative Humidity:	56 %
ATM Pressure:	100.0kPa

The testing was performed by Back Huang on 2010-12-27.

Please refer to the following tables and plots.

Cellular Band (Part 22H)

Frequency (MHz)	Emission (dBm)	Limit (dBm)
823.996	-13.73	-13
849.004	-13.86	-13

PCS Band (Part 24E)

Frequency (MHz)	Emission (dBm)	Limit (dBm)
1849.996	-17.17	-13
1910.024	-17.98	-13

Cellular Band, Lowest Channel

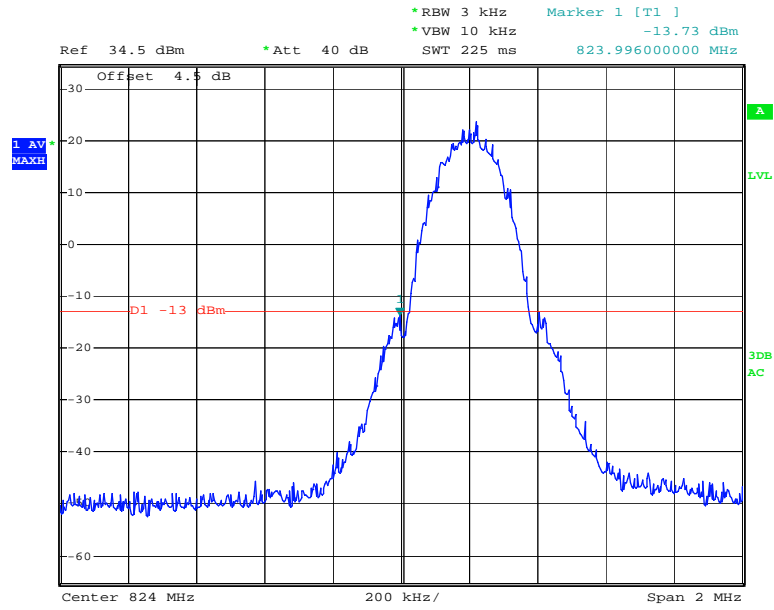

Date: 27.DEC.2010 17:11:26

Cellular Band, Highest Channel

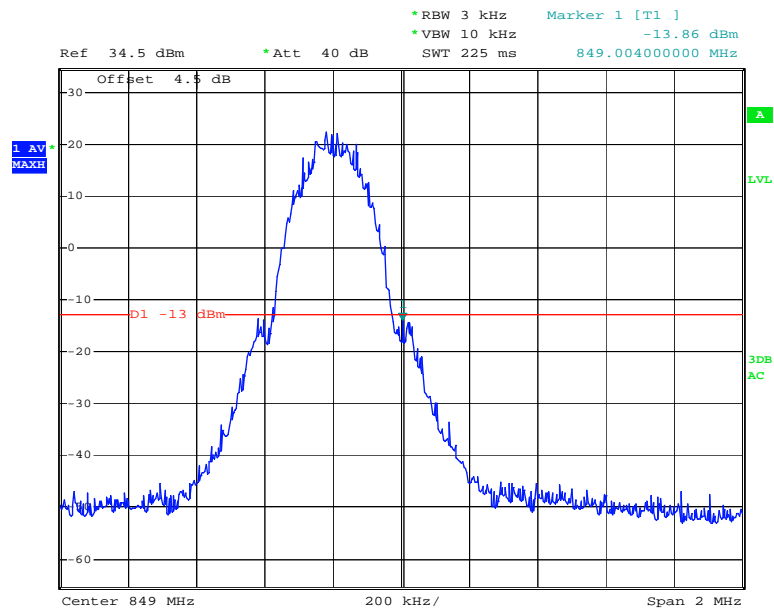

Date: 27.DEC.2010 17:25:54

PCS Band, Lowest Channel

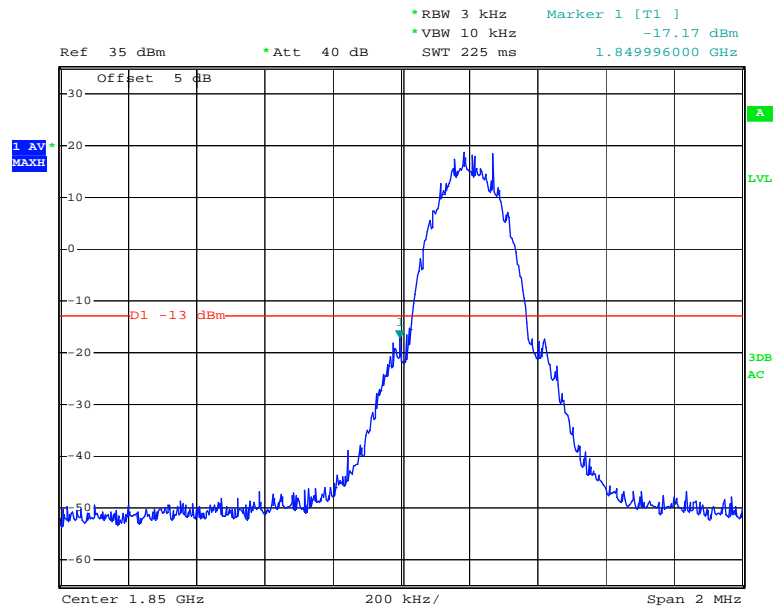

Date: 27.DEC.2010 17:38:22

PCS Band, Highest Channel

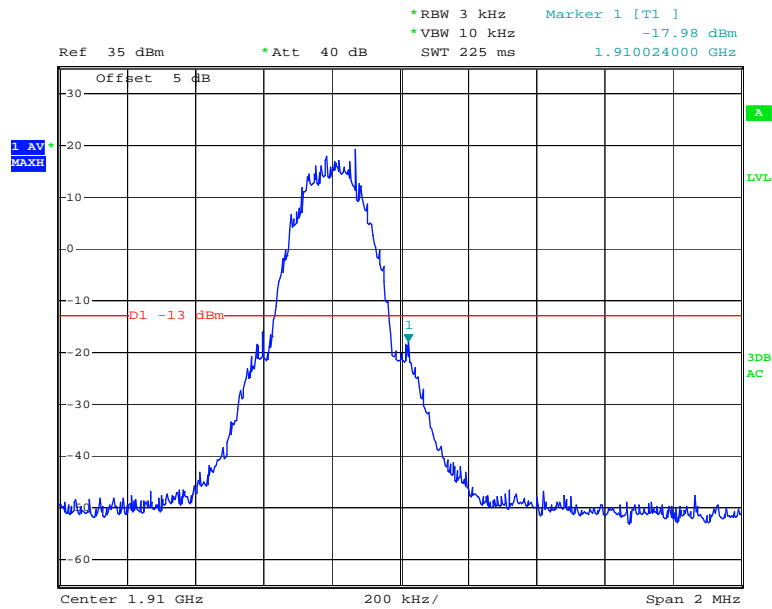

Date: 27.DEC.2010 17:40:57

FCC §2.1055, §22.355 & §24.235 - FREQUENCY STABILITY

Applicable Standards

FCC§ 2.1055 (a), § 2.1055 (d), §22.355, §24.235

According to §22.355, the carrier frequency of each transmitter in the Public Mobile Services must be maintained within the tolerances given in Table below:

Frequency Tolerance for Transmitters in the Public Mobile Services

Frequency Range (MHz)	Base, fixed (ppm)	Mobile ≤ 3 watts (ppm)	Mobile ≤ 3 watts (ppm)
25 to 50	20.0	20.0	50.0
50 to 450	5.0	5.0	50.0
450 to 512	2.5	5.0	5.0
821 to 896	1.5	2.5	2.5
928 to 929.	5.0	N/A	N/A
929 to 960.	1.5	N/A	N/A
2110 to 2220	10.0	N/A	N/A

According to §24.235, the frequency stability shall be sufficient to ensure that the fundamental emissions stays within the authorized frequency block.

Test Procedure

Frequency Stability vs. Temperature: The equipment under test was connected to an external DC power supply and the RF output was connected to communication test set via feed-through attenuators. The EUT was placed inside the temperature chamber. The DC leads and RF output cable exited the chamber through an opening made for the purpose.

After the temperature stabilized for approximately 20 minutes, the frequency output was recorded from the communication test set.

Frequency Stability vs. Voltage: An external variable DC power supply was connected to the battery terminals of the equipment under test. The voltage was set to 115% of the nominal value and was then decreased until the transmitter light no longer illuminated; i.e., the battery end point. The output frequency was recorded for each battery voltage.

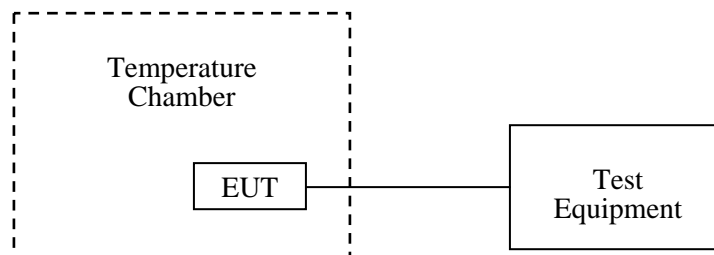

Test Equipment List and Details

Manufacturer	Description	Model	Serial Number	Calibration Date	Calibration Due Date
WUHUAN	Temperature & Humidity Chamber	HTP205	20021115	2010-06-04	2011-06-03
Rohde & Schwarz	Universal Radio Communication Tester	CMU200	109038	2010-06-11	2011-06-10

* **Statement of Traceability:** Bay Area Compliance Laboratories Corp. (Shenzhen) attests that all calibrations have been performed in accordance to NVLAP requirements, traceable to the NIST.

Test Data

Environmental Conditions

Temperature:	25 °C
Relative Humidity:	56 %
ATM Pressure:	100.0kPa

The testing was performed by Back Huang on 2010-12-28.

Cellular Band (Part 22H)

Middle Channel, $f_0 = 836.6$ MHz				
Test Environment		Frequency Error (Hz)	Frequency Error (ppm)	Limit (ppm)
Temperature (°C)	Power Supplied (V_{DC})			
-10	3.7	-17	-0.02032	2.5
0		-15	-0.01793	2.5
10		-17	-0.02032	2.5
20		-15	-0.01793	2.5
30		-17	-0.02032	2.5
40		-14	-0.01673	2.5
50		-13	-0.01554	2.5
55		-18	-0.02152	2.5
25		4.2	-13	-0.01554
	3.6	-14	-0.01673	2.5

PCS Band (Part 24E)

Middle Channel, $f_0 = 1880$ MHz				
Test Environment		Frequency Error (Hz)	Frequency Error (ppm)	Results
Temperature ($^{\circ}$ C)	Power Supplied (V_{DC})			
-10	3.7	-15	-0.00798	Pass
0		-19	-0.01011	Pass
10		-13	-0.00691	Pass
20		-24	-0.01277	Pass
30		-17	-0.00904	Pass
40		-16	-0.00851	Pass
50		-18	-0.00957	Pass
55		-25	-0.0133	Pass
25	4.2	-17	-0.00904	Pass
	3.6	-16	-0.00851	Pass

***** END OF REPORT *****