

**SGS**

# **Internal photos of EUT**

## Internal view of EUT

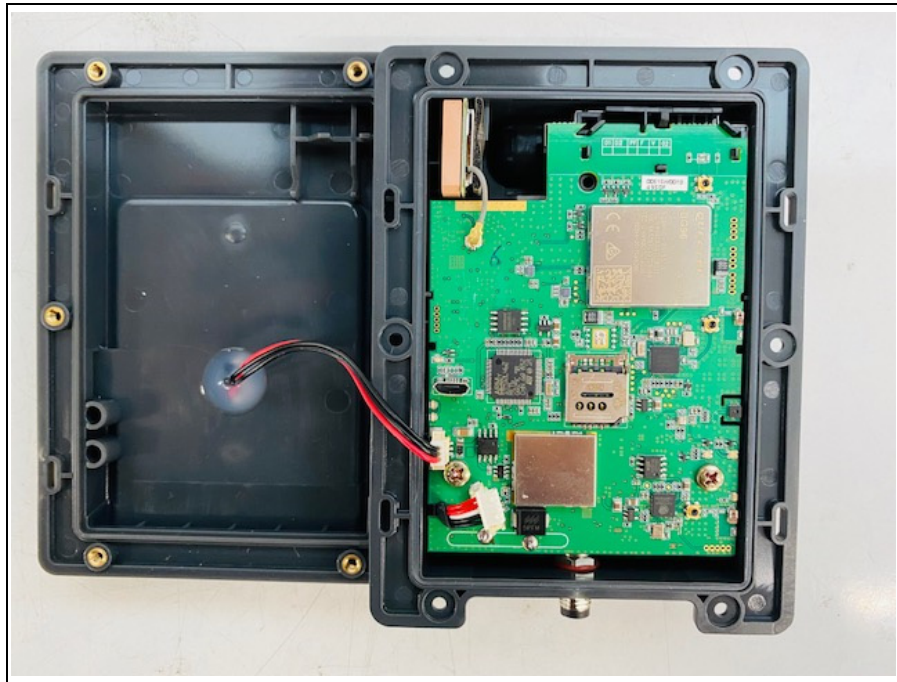

## Top view of Main PCB

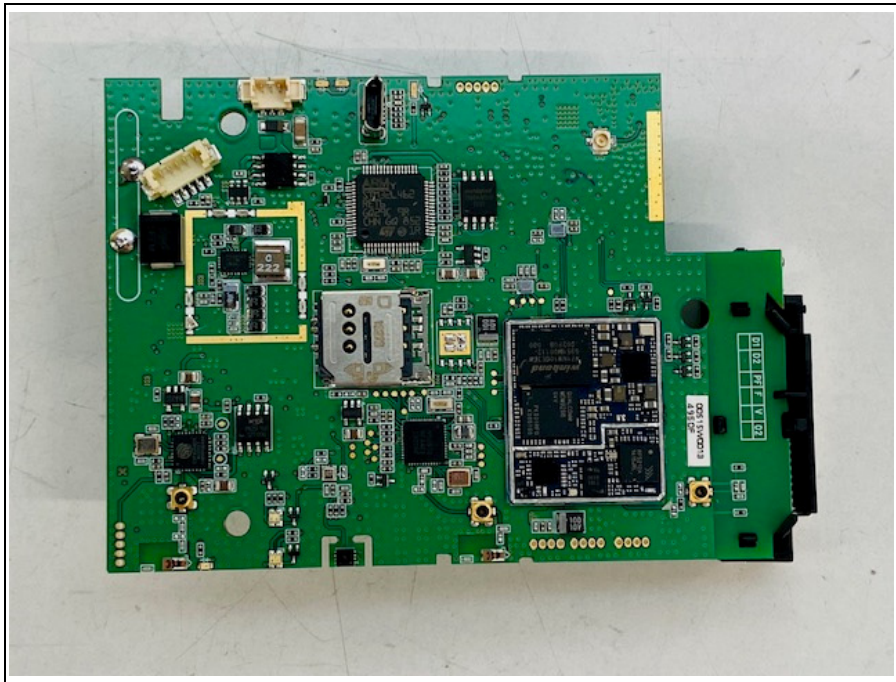

## Bottom view of Main PCB

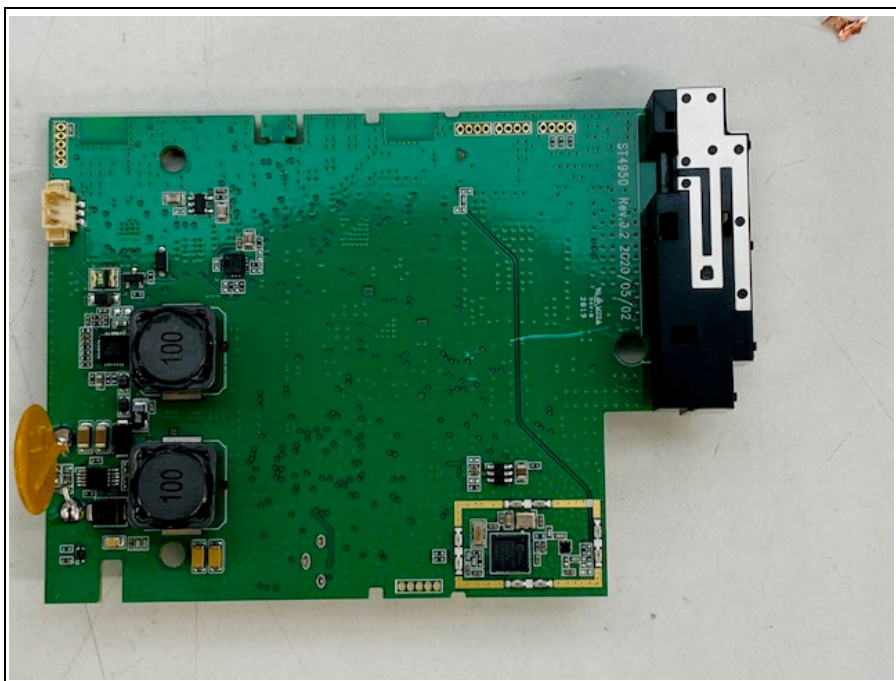

## View of Module

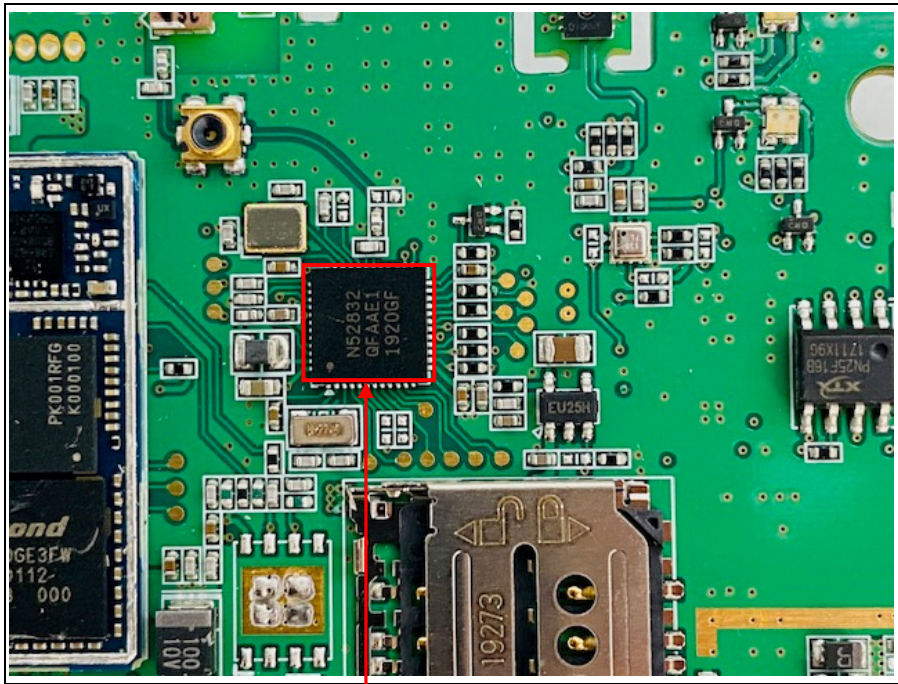

Bluetooth Low Energy Module

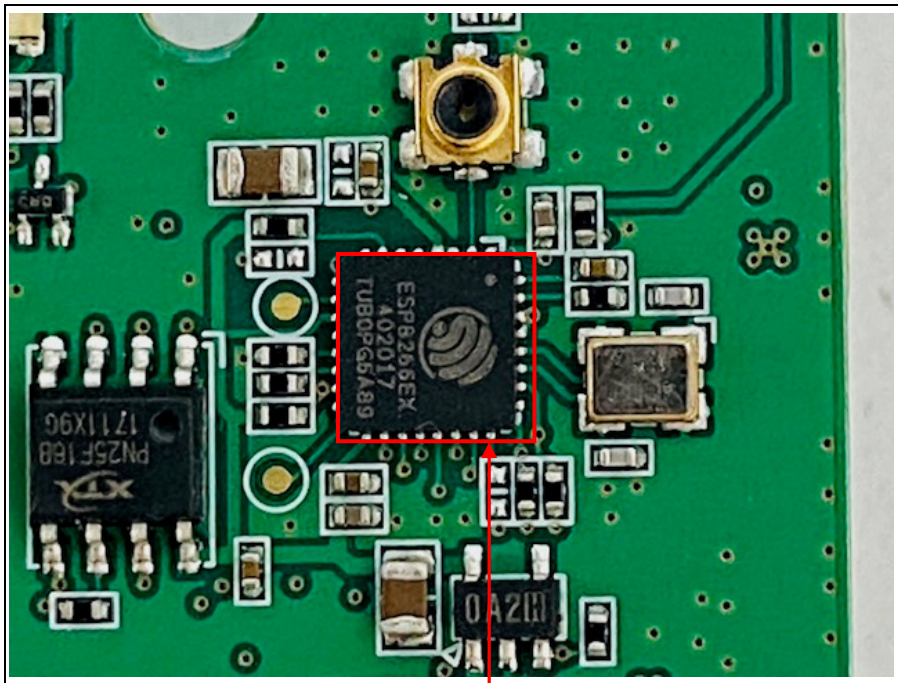

WiFi Module

## View of Antenna

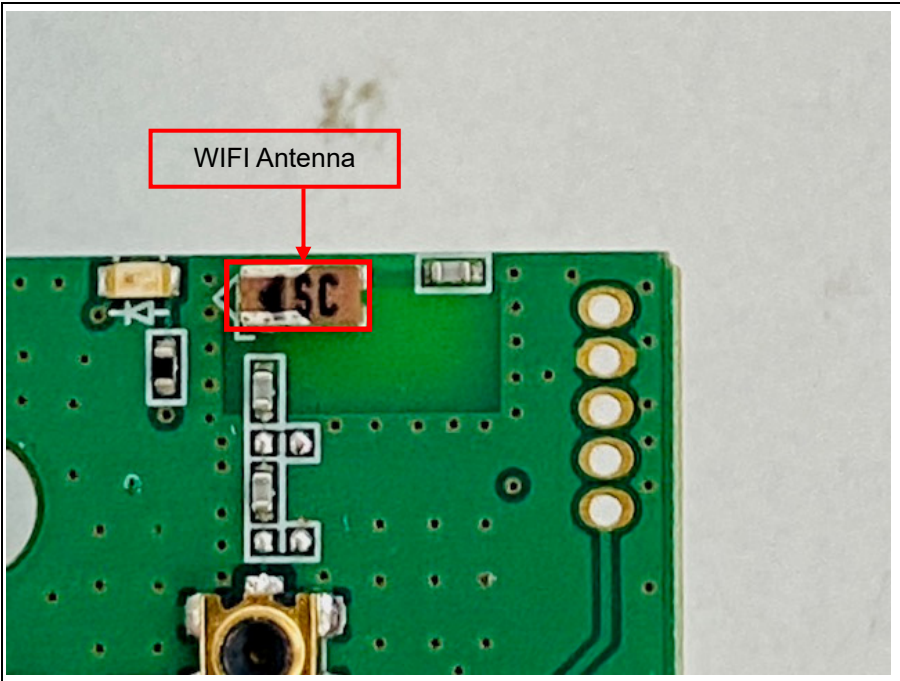
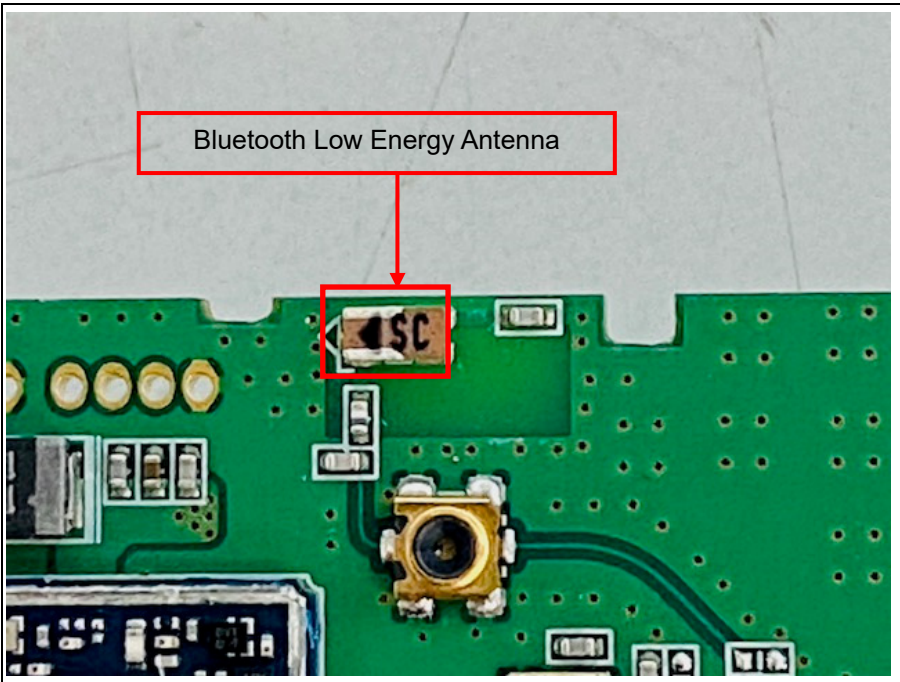

Approved the module with the shielding cover



Approved the module without the shielding cover

