

ELECTROMAGNETIC EMISSION COMPLIANCE REPORT FOR LICENSED TRANSMITTER

Test Report No. : OT-192-RWD-041
AGR No. : A192A-045
Applicant : Suntech International Ltd.
Address : (Gasan-dong, Greatvally), B-1506, 32, Digital-ro9-gil, Geumchon-gu, Seoul, Korea
Manufacturer : Suntech International Ltd.
Address : (Gasan-dong, Greatvally), B-1506, 32, Digital-ro9-gil, Geumchon-gu, Seoul, Korea
Type of Equipment : Tracking Device
FCC ID. : WA2ST4500
Model Name : ST4500
Serial number : N/A
Total page of Report : 81 pages (including this page)
Date of Incoming : February 13, 2019
Date of issue : February 28, 2019

SUMMARY

The equipment complies with the regulation; **Part 2, Part 27 Subpart C**

This test report only contains the result of a single test of the sample supplied for the examination.

It is not a generally valid assessment of the features of the respective products of the mass-production.

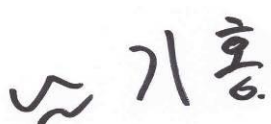
Reviewed by: 

 Ki-Hong, Nam / Chief Engineer
 ONETECH Corp.

Approved by: 

 Keun-Young, Choi / Vice President
 ONETECH Corp.

CONTENTS

PAGE

1. VERIFICATION OF COMPLIANCE	7
2. TEST SUMMARY.....	8
2.1 TEST ITEMS AND RESULTS	8
2.2 ADDITIONS, DEVIATIONS, EXCLUSIONS FROM STANDARDS.....	8
2.3 RELATED SUBMITTAL(S) / GRANT(S)	8
2.4 PURPOSE OF THE TEST	8
2.5 TEST METHODOLOGY.....	8
2.6 TEST FACILITY.....	8
3. GENERAL INFORMATION.....	9
3.1 PRODUCT DESCRIPTION.....	9
3.2 ALTERNATIVE TYPE(S)/MODEL(S); ALSO COVERED BY THIS TEST REPORT.....	9
4. EUT MODIFICATIONS.....	9
5. SYSTEM TEST CONFIGURATION	10
5.1 JUSTIFICATION.....	10
5.2 PERIPHERAL EQUIPMENT	10
5.3 MODE OF OPERATION DURING THE TEST	11
5.5 CONFIGURATION OF TEST SYSTEM.....	16
6. PRELIMINARY TEST	16
6.1 AC POWER LINE CONDUCTED EMISSIONS TESTS.....	16
6.2 GENERAL RADIATED EMISSIONS TESTS	16
7. CONDUCTED OUTPUT POWER	17
7.1 OPERATING ENVIRONMENT	17
7.2 TEST SET-UP	17
7.3 TEST EQUIPMENT USED.....	17
7.4 TEST DATA.....	18
8. EQUIVALENT ISOTROPIC RADIATED POWER	20
8.1 OPERATING ENVIRONMENT	20
8.2 METHODS OF MEASUREMENT	20
8.3 LIMITS	20
8.4 TEST SET-UP	20
8.5 TEST EQUIPMENT USED.....	21

8.6 TEST DATA FOR LTE BAND 4 QPSK	22
8.7 TEST DATA FOR LTE BAND 4 16QAM	22
9. EFFECTIVE RADIATED POWER	23
9.1 OPERATING ENVIRONMENT	23
9.2 METHODS OF MEASUREMENT	23
9.3 LIMITS	23
9.4 TEST SET-UP	23
9.5 TEST EQUIPMENT USED	24
9.6 TEST DATA FOR LTE BAND 12 QPSK	25
9.7 TEST DATA FOR LTE BAND 12 16QAM	25
9.8 TEST DATA FOR LTE BAND 13 QPSK	26
9.9 TEST DATA FOR LTE BAND 13 16QAM	26
10. RADIATED SPURIOUS EMISSIONS	27
10.1 OPERATING ENVIRONMENT	27
10.2 TEST SET-UP	27
10.3 TEST EQUIPMENT USED	29
10.4 TEST DATA	30
10.4.1 Test data for LTE Band 4 QPSK	30
10.4.2 Test data for LTE Band 12 QPSK	31
10.4.2 Test data for LTE Band 13 QPSK	32
11. PEAK-TO-AVERAGE RATIO	33
11.1 OPERATING ENVIRONMENT	33
11.2 TEST SET-UP	33
11.3 TEST EQUIPMENT USED	34
11.4 TEST DATA	34
11.4.1 Test data LTE Band 4	34
11.4.2 Test data LTE Band 12	37
11.4.3 Test data LTE Band 13	40
12. OCCUPIED BANDWIDTH	42
12.1 OPERATING ENVIRONMENT	42
12.2 TEST SET-UP	42
12.3 TEST EQUIPMENT USED	42
12.4 TEST DATA	43
12.4.1 Test data for LTE Band 4	43
12.4.2 Test data for LTE Band 12	46
12.4.3 Test data for LTE Band 13	49

13. CONDUCTED BAND EDGE	51
13.1 OPERATING ENVIRONMENT	51
13.2 TEST SET-UP	51
13.3 METHODS OF MEASUREMENT	51
13.4 LIMITS	51
13.5 TEST EQUIPMENT USED	52
13.6 TEST DATA	53
<i>13.6.1 Test data for LTE Band 4</i>	<i>53</i>
<i>13.6.2 Test data for LTE Band 4 QPSK</i>	<i>54</i>
<i>13.6.3 Test data for LTE Band 4 16QAM</i>	<i>55</i>
<i>13.6.4 Test data for LTE Band 12</i>	<i>56</i>
<i>13.6.5 Test data for LTE Band 12 QPSK</i>	<i>57</i>
<i>13.6.6 Test data for LTE Band 12 16QAM</i>	<i>58</i>
<i>13.6.7 Test data for LTE Band 13</i>	<i>59</i>
<i>13.6.8 Test data for LTE Band 13 QPSK</i>	<i>60</i>
<i>13.6.9 Test data for LTE Band 13 16QAM</i>	<i>61</i>
14. CONDUCTED SPURIOUS AND HARMONIC EMISSIONS AT ANTENNA TERMIANL	62
14.1 OPERATING ENVIRONMENT	62
14.2 TEST SET-UP	62
14.3 LIMITS	62
14.4 TEST EQUIPMENT USED	63
14.5 TEST DATA	64
<i>14.5.1 Test data for LTE Band 4 QPSK</i>	<i>64</i>
<i>14.5.2 Test data for LTE Band 4 16QAM</i>	<i>67</i>
<i>14.5.3 Test data for LTE Band 12 QPSK</i>	<i>70</i>
<i>14.5.4 Test data for LTE Band 12 16QAM</i>	<i>73</i>
<i>14.5.5 Test data for LTE Band 13 QPSK</i>	<i>76</i>
<i>14.5.6 Test data for LTE Band 13 16QAM</i>	<i>77</i>
15. FREQUENCY STABILITY / VARIATION OF AMBIENT TEMPERATURE	78
15.1 OPERATING ENVIRONMENT	78
15.2 TEST SET-UP	78
15.3 TEST EQUIPMENT USED	78
15.4 TEST DATA	79
<i>15.4.1 Test data for Voltage(V) _LTE Band 4</i>	<i>79</i>
<i>15.4.2 Test data for Temperature(°C) _LTE Band 4</i>	<i>79</i>
<i>15.4.3 Test data for Voltage(V) _LTE Band 12</i>	<i>80</i>

15.4.4 Test data for Temperature(°C) _LTE Band 1280
15.4.5 Test data for Voltage(V) _LTE Band 1381
15.4.6 Test data for Temperature(°C) _LTE Band 1381

Revision History

Rev. No.	Issue Report No.	Issued Date	Revisions	Section Affected
0	OT-192-RWD-041	February 28, 2019	Initial Release	All

1. VERIFICATION OF COMPLIANCE

Applicant : Suntech International Ltd.
 Address : (Gasan-dong, Greatvally), B-1506, 32, Digital-ro9-gil, Geumchon-gu, Seoul, Korea
 Contact Person : Yohan Kim / Manager
 Telephone No. : 82-2-6327-5661
 FCC ID : WA2ST4500
 Model Name : ST4500
 Serial Number : N/A
 Date : February 28, 2019

EQUIPMENT CLASS	PCB-PCS Licensed Transmitter
EQUIPMENT DESCRIPTION	Tracking Device
THIS REPORT CONCERNS	Original Grant
MEASUREMENT PROCEDURES	ANSI C63.26:2015, KDB Publication 971168 D01
TYPE OF EQUIPMENT TESTED	Pre-Production
KIND OF EQUIPMENT AUTHORIZATION REQUESTED	Certification
EQUIPMENT WILL BE OPERATED UNDER FCC RULES PART(S)	FCC Part 2, Part 27 Subpart C
Modifications on the Equipment to Achieve Compliance	None
Final Test was Conducted On	3 m Semi Anechoic Chamber

-. The above equipment was tested by ONETECH Corp. for compliance with the requirement set forth in the FCC Rules and Regulations. This said equipment in the configuration described in this report, shows the maximum emission levels emanating from equipment are within the compliance requirements.

2. TEST SUMMARY

2.1 Test items and results

SECTION	TEST ITEMS	RESULTS
2.1049	Occupied Bandwidth	Met the Limit / PASS
2.1051, 27.53(g), 27.53(f), 27.53(h)	Band Edge / Spurious and Harmonic Emissions at Antenna Terminal	Met the Limit / PASS
2.1046	Conducted Output Power	Met the Limit / PASS
27.50(d)(5), KDB Publication 971168 D01	Peak-to-Average Ratio	Met the Limit / PASS
2.1055, 27.54	Frequency stability	Met the Limit / PASS
27.50(d)(4)	Equivalent Isotropic Radiated Power	Met the Limit / PASS
27.50(b)(10), 27.50(c)(10)	EFFECTIVE RADIATED POWER	Met the Limit / PASS
2.1053, 27.53(g), 27.53(f), 27.53(h)	Radiated Spurious and Harmonic Emissions	Met the Limit / PASS

2.2 Additions, deviations, exclusions from standards

No additions, deviations or exclusions have been made from standard.

2.3 Related Submittal(s) / Grant(s)

Original submittal only

2.4 Purpose of the test

To determine whether the equipment under test fulfills the requirements of the regulation stated in Part 27 Subpart C.

2.5 Test Methodology

Both conducted and radiated testing was performed according to the procedures in ANSI C63.26:2015. Radiated testing was performed at a distance of 3 m from EUT to the antenna.

2.6 Test Facility

The Onetech Corp. has been designated to perform equipment testing in compliance with ISO/IEC 17025.

The Electromagnetic compatibility measurement facilities are located at 43-14, Jinsaegol-gil, Chowol-eup, Gwangju-si, Gyeonggi-do, 12735, Korea

-. Site Filing:

VCCI (Voluntary Control Council for Interference) – Registration No. R-4112/ C-14617/ G-10666 / T-1842

IC (Industry Canada) – Registration No. Site# 3736A-3

-. Site Accreditation:

KOLAS (Korea Laboratory Accreditation Scheme) - Accreditation NO. KT085

FCC (Federal Communications Commission) - Accreditation No. KR0013

RRA (Radio Research Agency) – Designation No. KR0013

3. GENERAL INFORMATION

3.1 Product Description

The Suntech International Ltd., Model ST4500 (referred to as the EUT in this report) is a Tracking Device. Product specification information described herein was obtained from product data sheet or user’s manual.

DEVICE TYPE	Tracking Device			
OPERATING FREQUENCY	LTE Band 2	TX	1 850 MHz ~ 1 910 MHz	
		RX	1 930 MHz ~ 1 990 MHz	
	LTE Band 4	TX	1 710 MHz ~ 1 755 MHz	
		RX	2 110 MHz ~ 2 155 MHz	
	LTE Band 5	TX	824 MHz ~ 849 MHz	
		RX	869 MHz ~ 894 MHz	
	LTE Band 12	TX	699 MHz ~ 716 MHz	
		RX	729 MHz ~ 746 MHz	
	LTE Band 13	TX	777 MHz ~ 787 MHz	
		RX	746 MHz ~ 756 MHz	
	LTE Channel Bandwidth	10 MHz		
	Modulation Type	QPSK, 16QAM		
Maximum EIRP Power	LTE Band 4	20.41 dBm		
Maximum ERP Power	LTE Band 12	21.34 dBm		
	LTE Band 13	21.41 dBm		
ANTENNA TYPE	PIFA Antenna			
ANTENNA GAIN	LTE Band 2	1.17 dBi		
	LTE Band 4	-0.72 dBi		
	LTE Band 5	0.41 dBi		
	LTE Band 12	-1.69 dBi		
	LTE Band 13	-0.31 dBi		
List of each Osc. or crystal Freq.(Freq. >= 1 MHz)	26 MHz			

3.2 Alternative type(s)/model(s); also covered by this test report.

-. None

4. EUT MODIFICATIONS

-. None

5. SYSTEM TEST CONFIGURATION

5.1 Justification

This device was configured for testing in a typical way as a normal customer is supposed to be used. During the test, the following components were installed inside of the EUT.

DEVICE TYPE	MANUFACTURER	MODEL/PART NUMBER	FCC ID
Main Board	N/A	N/A	N/A
Battery	N/A	N/A	N/A
Antenna	N/A	N/A	N/A

5.2 Peripheral equipment

Defined as equipment needed for correct operation of the EUT, but not considered as tested:

Model	Manufacturer	Description	Connected to
PWS-3003D	Protek	DC Power Supply	EUT

5.3 Mode of operation during the test

Pre-Scan has been conducted to determine the worst-case mode from all possible combinations between available modulations, data rates, XYZ axis, and antenna ports. The worst case was found when positioned as the table below.

Following channel(s) was (were) selected for the final test as listed below:

Band	EIRP	Radiated Emission
LTE Band 4	X-plane	X-axis
LTE Band 12	X-plane	X-axis
LTE Band 13	X-plane	X-axis

Test Mode : LTE Band 4

Test Item	Channel Bandwidth	Modulation	Mode	Test Channel
Conducted Output Power	10 MHz	QPSK, 16QAM	1 RB / 0 RB Offset / 0 RB Index	1 715 MHz 1 732.5 MHz 1 750 MHz
			1 RB / 5 RB Offset / 0 RB Index	
			1 RB / 0 RB Offset / 3 RB Index	
			1 RB / 5 RB Offset / 3 RB Index	
			1 RB / 0 RB Offset / 7 RB Index	
			1 RB / 5 RB Offset / 7 RB Index	
			3 RB / 0 RB Offset / 0 RB Index	
			3 RB / 3 RB Offset / 7 RB Index	
			6 RB / 0 RB Offset / 0 RB Index	
			6 RB / 0 RB Offset / 7 RB Index	
Equivalent Isotropic Radiated Power	10 MHz	QPSK, 16QAM	1 RB / 0 RB Offset / 0 RB Index	1 715 MHz
				1 732.5 MHz
				1 750 MHz
Frequency stability	10 MHz	QPSK	1 RB / 0 RB Offset / 0 RB Index	1 732.5 MHz

Test Item	Channel Bandwidth	Modulation	Mode	Test Channel			
Occupied Bandwidth	10 MHz	QPSK, 16QAM	6 RB / 0 RB Offset / 0 RB Index	1 715 MHz			
				1 732.5 MHz			
				1 750 MHz			
Peak-to-Average Ratio	10 MHz	QPSK, 16QAM	1 RB / 0 RB Offset / 0 RB Index 6 RB / 0 RB Offset / 0 RB Index	1 715 MHz			
				1 732.5 MHz			
				1 750 MHz			
Band Edge	10 MHz	QPSK, 16QAM	1 RB / 0 RB Offset / 0 RB Index 6 RB / 0 RB Offset / 0 RB Index	1 715 MHz			
				1 RB / 5 RB Offset / 0 RB Index 6 RB / 5 RB Offset / 0 RB Index	1 750 MHz		
			Spurious and Harmonic Emissions at Antenna Terminal		10 MHz	QPSK, 16QAM	1 RB / 0 RB Offset / 0 RB Index
				1 732.5 MHz			
1 750 MHz							
Radiated Spurious and Harmonic Emissions	10 MHz	QPSK, 16QAM	1 RB / 0 RB Offset / 0 RB Index	1 715 MHz			
				1 732.5 MHz			
				1 750 MHz			

Test Mode : LTE Band 12

Test Item	Channel Bandwidth	Modulation	Mode	Test Channel
Conducted Output Power	10 MHz	QPSK, 16QAM	1 RB / 0 RB Offset / 0 RB Index	704 MHz 707.5 MHz 711 MHz
			1 RB / 5 RB Offset / 0 RB Index	
			1 RB / 0 RB Offset / 3 RB Index	
			1 RB / 5 RB Offset / 3 RB Index	
			1 RB / 0 RB Offset / 7 RB Index	
			1 RB / 5 RB Offset / 7 RB Index	
			3 RB / 0 RB Offset / 0 RB Index	
			3 RB / 3 RB Offset / 7 RB Index	
			6 RB / 0 RB Offset / 0 RB Index	
			6 RB / 0 RB Offset / 7 RB Index	
Equivalent Isotropic Radiated Power	10 MHz	QPSK, 16QAM	1 RB / 0 RB Offset / 0 RB Index	704 MHz
				707.5 MHz
				711 MHz
Frequency stability	10 MHz	QPSK	1 RB / 0 RB Offset / 0 RB Index	707.5 MHz
Peak-to-Average Ratio	10 MHz	QPSK, 16QAM	1 RB / 0 RB Offset / 0 RB Index 6 RB / 0 RB Offset / 0 RB Index	704 MHz
				707.5 MHz
				711 MHz
Band Edge	10 MHz	QPSK, 16QAM	1 RB / 0 RB Offset / 0 RB Index	704 MHz
			6 RB / 0 RB Offset / 0 RB Index	
			1 RB / 5 RB Offset / 0 RB Index	711 MHz
			6 RB / 5 RB Offset / 0 RB Index	

Test Item	Channel Bandwidth	Modulation	Mode	Test Channel
Occupied Bandwidth	10 MHz	QPSK, 16QAM	6 RB / 0 RB Offset / 0 RB Index	704 MHz
				707.5 MHz
				711 MHz
Spurious and Harmonic Emissions at Antenna Terminal	10 MHz	QPSK, 16QAM	1 RB / 0 RB Offset / 0 RB Index	704 MHz
				707.5 MHz
				711 MHz
Radiated Spurious and Harmonic Emissions	10 MHz	QPSK, 16QAM	1 RB / 0 RB Offset / 0 RB Index	704 MHz
				707.5 MHz
				711 MHz

Test Mode : LTE Band 13

Test Item	Channel Bandwidth	Modulation	Mode	Test Channel
Conducted Output Power	10 MHz	QPSK, 16QAM	1 RB / 0 RB Offset / 0 RB Index	782 MHz
			1 RB / 5 RB Offset / 0 RB Index	
			1 RB / 0 RB Offset / 3 RB Index	
			1 RB / 5 RB Offset / 3 RB Index	
			1 RB / 0 RB Offset / 7 RB Index	
			1 RB / 5 RB Offset / 7 RB Index	
			3 RB / 0 RB Offset / 0 RB Index	
			3 RB / 3 RB Offset / 7 RB Index	
			6 RB / 0 RB Offset / 0 RB Index	
			6 RB / 0 RB Offset / 7 RB Index	
Equivalent Isotropic Radiated Power	10 MHz	QPSK, 16QAM	1 RB / 0 RB Offset / 0 RB Index	782 MHz
Frequency stability	10 MHz	QPSK	1 RB / 0 RB Offset / 0 RB Index	782 MHz
Occupied Bandwidth	10 MHz	QPSK, 16QAM	6 RB / 0 RB Offset / 0 RB Index	782 MHz
Peak-to-Average Ratio	10 MHz	QPSK, 16QAM	1 RB / 0 RB Offset / 0 RB Index	782 MHz
			6 RB / 0 RB Offset / 0 RB Index	
Band Edge	10 MHz	QPSK, 16QAM	1 RB / 0 RB Offset / 0 RB Index	782 MHz
			6 RB / 0 RB Offset / 0 RB Index	
			1 RB / 5 RB Offset / 0 RB Index	782 MHz
			6 RB / 5 RB Offset / 0 RB Index	
Spurious and Harmonic Emissions at Antenna Terminal	10 MHz	QPSK, 16QAM	1 RB / 0 RB Offset / 0 RB Index	782 MHz
Radiated Spurious and Harmonic Emissions	10 MHz	QPSK, 16QAM	1 RB / 0 RB Offset / 0 RB Index	782 MHz

5.4 Frequency List of Low/Middle/High Channels

LTE Band 4 Channel and Frequency List				
Bandwidth	Channel / Frequency	Low	Middle	High
10 MHz	Channel	20000	20175	20350
	Frequency	1 715 MHz	1 732.5 MHz	1 750 MHz

LTE Band 12 Channel and Frequency List				
Bandwidth	Channel / Frequency	Low	Middle	High
10 MHz	Channel	23060	23095	23130
	Frequency	704 MHz	707.5 MHz	711 MHz

LTE Band 13 Channel and Frequency List				
Bandwidth	Channel / Frequency	Low	Middle	High
10 MHz	Channel	-	23230	-
	Frequency	-	782 MHz	-

5.5 Configuration of Test System

Radiated Emission Test: Preliminary radiated emissions test were conducted using the procedure in ANSI C63.10: 2013 to determine the worse operating conditions. Final radiated emission tests were conducted at 3 m Semi Anechoic Chamber.

The turntable was rotated through 360 degrees and the EUT was tested by positioned three orthogonal planes to obtain the highest reading on the field strength meter. Once maximum reading was determined, the search antenna was raised and lowered in both vertical and horizontal polarization.

6. PRELIMINARY TEST

6.1 AC Power line Conducted Emissions Tests

As this product is only using DC power, AC conducted emission test has not been performed.

6.2 General Radiated Emissions Tests

During Preliminary Test, the following operating mode was investigated.

Operation Mode	The Worse operating condition (Please check one only)
Transmitting Mode	X

7. CONDUCTED OUTPUT POWER

7.1 Operating environment

Temperature : 23 °C
 Relative humidity : 47 % R.H.

7.2 Test set-up

Conducted Output Power is tested in accordance with KDB971168 D01 Power Meas License Digital Systems v04, April 9, 2018, Section 5.2.

A base station simulator was used to establish communication with the EUT, and Spectrum analyzer was used for test results. This device was tested under all configurations and the highest power is reported. Conducted Output Powers of EUT are reported below.

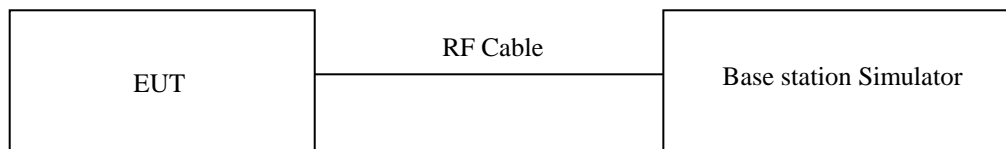

7.3 Test equipment used

	Model Number	Manufacturer	Description	Serial Number	Last Cal.
■ -	MT8821C	ANRITSU	Radio Communication Analyzer	6261849029	Aug. 22, 2018 (1Y)
■ -	PWS-3003D	Protek	DC Power Supply	4020409	Aug. 24, 2018 (1Y)

All test equipment used is calibrated on a regular basis.

7.4 Test data

- Test Date : February 13, 2019 ~ February 26, 2019
- Test Result : Pass

Conducted Average Output Power (dBm)

Band / Bandwidth	RB Size	RB Offset	RB Index	QPSK			16QAM		
				LOW	MIDDLE	HIGH	LOW	MIDDLE	HIGH
				1715 MHz	1732.5 MHz	1750 MHz	1715 MHz	1732.5 MHz	1750 MHz
Band 4 / 10 MHz	1	0	0	22.83	22.71	22.76	22.16	22.35	22.38
	1	5	0	22.74	22.64	22.68	22.11	22.10	22.12
	1	0	3	22.77	22.68	22.73	22.12	22.01	22.13
	1	5	3	22.77	22.65	22.72	22.10	22.05	22.10
	1	0	7	22.76	22.67	22.50	22.15	21.99	22.05
	1	5	7	22.68	22.62	22.48	22.05	21.96	21.96
	3	0	0	22.67	22.60	22.67	22.11	22.10	22.16
	3	3	7	22.78	22.61	22.55	22.15	22.03	22.05
	6	0	0	22.70	22.63	22.66	22.05	22.09	22.18
	6	0	7	22.59	22.53	22.63	22.02	22.12	22.13

Conducted Average Output Power (dBm)

Band / Bandwidth	RB Size	RB Offset	RB Index	QPSK			16QAM		
				LOW	MIDDLE	HIGH	LOW	MIDDLE	HIGH
				704 MHz	707.5 MHz	711 MHz	704 MHz	707.5 MHz	711 MHz
Band 12 / 10 MHz	1	0	0	23.15	23.08	23.07	22.44	22.46	22.32
	1	5	0	23.06	22.95	23.04	22.39	22.42	22.21
	1	0	3	22.92	23.01	23.02	22.43	22.39	22.19
	1	5	3	23.05	22.99	23.03	22.44	22.38	22.25
	1	0	7	22.98	22.91	22.96	22.33	22.29	22.03
	1	5	7	22.95	22.89	22.94	22.32	22.24	22.08
	3	0	0	22.89	22.90	23.01	22.41	22.38	22.31
	3	3	7	22.92	22.77	22.91	22.38	22.37	22.29
	6	0	0	22.80	23.05	22.94	22.39	22.41	22.28
	6	0	7	22.82	22.97	22.92	22.36	22.40	22.27

Conducted Average Output Power (dBm)

Band / Bandwidth	RB Size	RB Offset	RB Index	QPSK			16QAM		
				LOW	MIDDLE	HIGH	LOW	MIDDLE	HIGH
				-	782 MHz	-	-	782 MHz	-
Band 13 / 10 MHz	1	0	0	-	23.11	-	-	22.45	-
	1	5	0	-	23.08	-	-	22.44	-
	1	0	3	-	23.07	-	-	22.42	-
	1	5	3	-	23.05	-	-	22.42	-
	1	0	7	-	23.02	-	-	22.38	-
	1	5	7	-	22.97	-	-	22.36	-
	3	0	0	-	22.98	-	-	22.39	-
	3	3	7	-	22.85	-	-	22.38	-
	6	0	0	-	22.95	-	-	22.37	-
	6	0	7	-	22.83	-	-	22.39	-

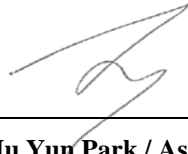

Tested by: Ju Yun Park / Assistant Manager

8. EQUIVALENT ISOTROPIC RADIATED POWER

8.1 Operating environment

Temperature : 22 °C
 Relative humidity : 48 % R.H.

8.2 Methods of Measurement

1. The testing follows ANSI C63.26 (2015) Section 5.5.3.
2. Substitution method is used for E.I.R.P measurement. In the semi-anechoic chamber, EUT placed on the 0.8 m (below or equal 1 GHz) and/or 1.5 m (above 1 GHz) height of Turn Table, rotated the table around 360 degrees to search the maximum radiation power and receiver antenna shall be rotated vertical and horizontal polarization and moved height from 1 m to 4 m to find the maximum polar radiated power. The “Read Value” is the spectrum reading the maximum power value.
3. The substitution antenna is substituted for EUT at the same position and signals generator export the CW signal to the substitution antenna via a tx cable. Rotated the Turn Table and moved receiving antenna to find the maximum radiation power. Adjust output power level of S.G to get a Value of spectrum reading equal to “Read Value” of step 2. Record the power level of S.G.
4. $EIRP = \text{Output power level of S.G} - \text{TX cable loss} + \text{Antenna gain of substitution antenna power}$ can be Calculated. $E.R.P \text{ power} = E.I.P.R \text{ power} - 2.15 \text{ dBi}$.

8.3 Limits

Rule Part 27.50(d) (4) specifies that “Fixed, mobile and portable (hand-held) stations operating in the 1710–1755 MHz band are limited to 1 watt EIRP”

Limit	1 W (30 dBm)
-------	--------------

8.4 Test set-up

The EUT and measurement equipment were set up as shown in the diagram below.

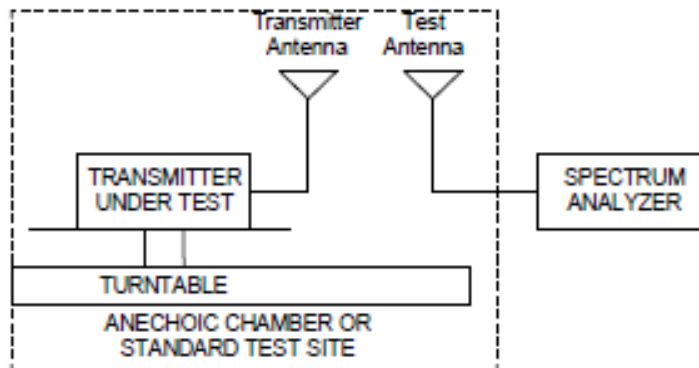

8.5 Test equipment used

	Model Number	Manufacturer	Description	Serial Number	Last Cal. (Interval)
☐ -	ESCI	Rohde & Schwarz	EMI Test Receiver	101012	Oct. 22, 2018 (1Y)
■ -	ESR	Rohde & Schwarz	EMI Test Receiver	101470	Oct. 22, 2018 (1Y)
■ -	310N	Sonoma Instrument	AMPLIFIER	312544	Mar. 28, 2018 (1Y)
■ -	FSV30	Rohde & Schwarz	Signal Analyzer	101372	Aug. 23, 2018 (1Y)
■ -	BBV9718B	Schwarzbeck	Broadband Preamplifier	009	Mar. 16, 2018 (1Y)
■ -	SCU-03	Rohde & Schwarz	Signal Conditioning Unit	100333	Mar. 15, 2018 (1Y)
☐ -	SCU-18	Rohde & Schwarz	Pre-Amplifier	102266	Aug. 24, 2018 (1Y)
■ -	MA-4000XPET	Innco Systems GmbH	Antenna Master	MA4000/509	N/A
☐ -	HD100	HD GmbH	Position Controller	N/A	N/A
■ -	DT3000-3t	Innco Systems GmbH	Turn Table	N/A	N/A
☐ -	FMZB 1513	Schwarzbeck	LOOP ANTENNA	1513-235	May. 13, 2018 (2Y)
■ -	VULB9163	Schwarzbeck	TRILOG Broadband Antenna	9163-255	Jun 05, 2018 (2Y)
■ -	VULB9163	Schwarzbeck	Hybrid Antenna	777	Apr. 13, 2018 (2Y)
■ -	BBHA9120D	Schwarzbeck	Horn Antenna	BBHA9120D295	Aug. 16, 2017 (2Y)
■ -	BBHA9120D	Schwarzbeck	Horn Antenna	9120D-1349	Dec. 04, 2017 (2Y)
☐ -	SCU40A	Rohde & Schwarz	Pre-Amplifier	100436	Mar. 15, 2018 (1Y)
■ -	MT8821C	ANRITSU	Radio Communication Analyzer	6261849029	Aug. 22, 2018 (1Y)

All test equipment used is calibrated on a regular basis.

8.6 Test data for LTE Band 4 QPSK

-. Test Date : February 13, 2019 ~ February 26, 2019

-. Test Result : Pass

Frequency (MHz)	Substituted Level (dBm)	Ant. Pol. (H/V)	Cable Loss (dB)	Ant Gain (dBi)	EIRP (dBm)	Limits (dBm)	Margin (dB)
Test Data for QPSK							
1715.0	14.12	H	1.21	7.40	20.31	30.00	9.69
1715.0	11.63	V	1.21	7.40	17.82	30.00	12.18
1732.5	14.22	H	1.23	7.30	20.29	30.00	9.71
1732.5	11.71	V	1.23	7.30	17.78	30.00	12.22
1750.0	14.54	H	1.23	7.10	20.41	30.00	9.59
1750.0	12.02	V	1.23	7.10	17.89	30.00	12.11

Remark: "H": Horizontal, "V": Vertical

8.7 Test data for LTE Band 4 16QAM

-. Test Date : February 13, 2019 ~ February 26, 2019

-. Test Result : Pass

Frequency (MHz)	Substituted Level (dBm)	Ant. Pol. (H/V)	Cable Loss (dB)	Ant Gain (dBi)	EIRP (dBm)	Limits (dBm)	Margin (dB)
Test Data for 16QAM							
1715.0	13.75	H	1.21	7.40	19.94	30.00	10.06
1715.0	11.07	V	1.21	7.40	17.26	30.00	12.74
1732.5	13.85	H	1.23	7.30	19.92	30.00	10.08
1732.5	11.18	V	1.23	7.30	17.25	30.00	12.75
1750.0	14.19	H	1.23	7.10	20.06	30.00	9.94
1750.0	11.44	V	1.23	7.10	17.31	30.00	12.69

Remark: "H": Horizontal, "V": Vertical



Tested by: Ju Yun Park / Assistant Manager

9. EFFECTIVE RADIATED POWER

9.1 Operating environment

Temperature : 25 °C
 Relative humidity : 46 % R.H.

9.2 Methods of Measurement

1. The testing follows ANSI C63.26 (2015) Section 5.5.3.
2. Substitution method is used for E.I.R.P measurement. In the semi-anechoic chamber, EUT placed on the 0.8 m (below or equal 1 GHz) and/or 1.5 m (above 1 GHz) height of Turn Table, rotated the table around 360 degrees to search the maximum radiation power and receiver antenna shall be rotated vertical and horizontal polarization and moved height from 1 m to 4 m to find the maximum polar radiated power. The “Read Value” is the spectrum reading the maximum power value.
3. The substitution antenna is substituted for EUT at the same position and signals generator export the CW signal to the substitution antenna via a tx cable. Rotated the Turn Table and moved receiving antenna to find the maximum radiation power. Adjust output power level of S.G to get a Value of spectrum reading equal to “Read Value” of step 2. Record the power level of S.G.
4. EIRP = Output power level of S.G – TX cable loss + Antenna gain of substitution antenna power can be Calculated. E.R.P power = E.I.P.R power - 2.15 dBi.

9.3 Limits

Rule Part 27.50(b) (10) specifies that “Portable stations (hand-held devices) transmitting in the 746-757 MHz, 776-788 MHz, and 805-806 MHz bands are limited to 3 watts ERP”

Rule Part 27.50(c) (10) specifies that “Portable stations (hand-held devices) in the 600 MHz uplink band and the 698-746 MHz band, and fixed and mobile stations in the 600 MHz uplink band are limited to 3 watts ERP”

Limit	3 W (34.77 dBm)
-------	-----------------

9.4 Test set-up

The EUT and measurement equipment were set up as shown in the diagram below.

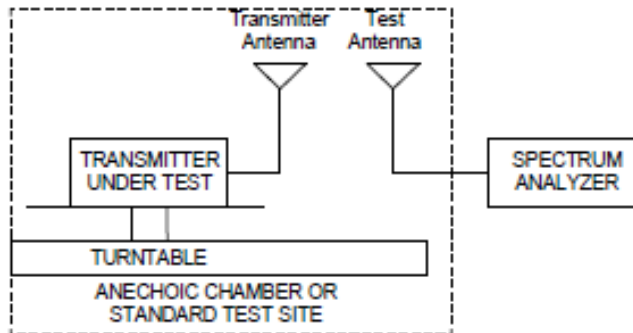

9.5 Test equipment used

	Model Number	Manufacturer	Description	Serial Number	Last Cal. (Interval)
<input type="checkbox"/>	ESCI	Rohde & Schwarz	EMI Test Receiver	101012	Oct. 22, 2018 (1Y)
<input checked="" type="checkbox"/>	ESR	Rohde & Schwarz	EMI Test Receiver	101470	Oct. 22, 2018 (1Y)
<input checked="" type="checkbox"/>	310N	Sonoma Instrument	AMPLIFIER	312544	Mar. 28, 2018 (1Y)
<input checked="" type="checkbox"/>	FSV30	Rohde & Schwarz	Signal Analyzer	101372	Aug. 23, 2018 (1Y)
<input checked="" type="checkbox"/>	BBV9718B	Schwarzbeck	Broadband Preamplifier	009	Mar. 16, 2018 (1Y)
<input checked="" type="checkbox"/>	SCU-03	Rohde & Schwarz	Signal Conditioning Unit	100333	Mar. 15, 2018 (1Y)
<input type="checkbox"/>	SCU-18	Rohde & Schwarz	Pre-Amplifier	102266	Aug. 24, 2018 (1Y)
<input checked="" type="checkbox"/>	MA-4000XPET	Innco Systems GmbH	Antenna Master	MA4000/509	N/A
<input type="checkbox"/>	HD100	HD GmbH	Position Controller	N/A	N/A
<input checked="" type="checkbox"/>	DT3000-3t	Innco Systems GmbH	Turn Table	N/A	N/A
<input type="checkbox"/>	FMZB 1513	Schwarzbeck	LOOP ANTENNA	1513-235	May. 13, 2018 (2Y)
<input checked="" type="checkbox"/>	VULB9163	Schwarzbeck	TRILOG Broadband Antenna	9163-255	Jun 05, 2018 (2Y)
<input checked="" type="checkbox"/>	VULB9163	Schwarzbeck	Hybrid Antenna	777	Apr, 13, 2018 (2Y)
<input checked="" type="checkbox"/>	BBHA9120D	Schwarzbeck	Horn Antenna	BBHA9120D295	Aug. 16, 2017 (2Y)
<input checked="" type="checkbox"/>	BBHA9120D	Schwarzbeck	Horn Antenna	9120D-1349	Dec. 04, 2017 (2Y)
<input type="checkbox"/>	SCU40A	Rohde & Schwarz	Pre-Amplifier	100436	Mar. 15, 2018 (1Y)
<input checked="" type="checkbox"/>	MT8821C	ANRITSU	Radio Communication Analyzer	6261849029	Aug. 22, 2018 (1Y)

All test equipment used is calibrated on a regular basis.

9.6 Test data for LTE Band 12 QPSK

-. Test Date : February 13, 2019 ~ February 26, 2019

-. Test Result : Pass

Frequency (MHz)	Substituted Level (dBm)	Ant. Pol. (H/V)	Cable Loss (dB)	Ant Gain (dBd)	ERP (dBm)	Limits (dBm)	Margin (dB)
Test Data for QPSK							
704.0	16.72	H	0.83	5.45	21.34	34.77	13.43
704.0	13.59	V	0.83	5.45	18.21	34.77	16.56
707.5	16.64	H	0.83	5.45	21.26	34.77	13.51
707.5	13.41	V	0.83	5.45	18.03	34.77	16.74
711.0	16.78	H	0.84	5.25	21.19	34.77	13.58
711.0	13.88	V	0.84	5.25	18.29	34.77	16.48

Remark: "H": Horizontal, "V": Vertical

9.7 Test data for LTE Band 12 16QAM

-. Test Date : February 13, 2019 ~ February 26, 2019

-. Test Result : Pass

Frequency (MHz)	Substituted Level (dBm)	Ant. Pol. (H/V)	Cable Loss (dB)	Ant Gain (dBd)	ERP (dBm)	Limits (dBm)	Margin (dB)
Test Data for 16QAM							
704.0	16.35	H	0.83	5.45	20.97	34.77	13.80
704.0	12.92	V	0.83	5.45	17.54	34.77	17.23
707.5	16.19	H	0.83	5.45	20.81	34.77	13.96
707.5	12.81	V	0.83	5.45	17.43	34.77	17.34
711.0	16.45	H	0.84	5.25	20.86	34.77	13.91
711.0	13.11	V	0.84	5.25	17.52	34.77	17.25

Remark: "H": Horizontal, "V": Vertical

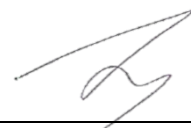

Tested by: Ju Yun Park / Assistant Manager

9.8 Test data for LTE Band 13 QPSK

-. Test Date : February 13, 2019 ~ February 26, 2019

-. Test Result : Pass

Frequency (MHz)	Substituted Level (dBm)	Ant. Pol. (H/V)	Cable Loss (dB)	Ant Gain (dBd)	ERP (dBm)	Limits (dBm)	Margin (dB)
Test Data for QPSK							
782.0	17.31	H	0.85	4.95	21.41	34.77	13.36
782.0	14.98	V	0.85	4.95	19.08	34.77	15.69

Remark: "H": Horizontal, "V": Vertical

9.9 Test data for LTE Band 13 16QAM

-. Test Date : February 13, 2019 ~ February 26, 2019

-. Test Result : Pass

Frequency (MHz)	Substituted Level (dBm)	Ant. Pol. (H/V)	Cable Loss (dB)	Ant Gain (dBd)	ERP (dBm)	Limits (dBm)	Margin (dB)
Test Data for 16QAM							
782.0	16.94	H	0.85	4.95	21.04	34.77	13.73
782.0	14.74	V	0.85	4.95	18.84	34.77	15.93

Remark: "H": Horizontal, "V": Vertical

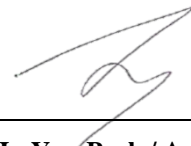

Tested by: Ju Yun Park / Assistant Manager

10. RADIATED SPURIOUS EMISSIONS

10.1 Operating environment

Temperature : 22 °C
 Relative humidity : 48 % R.H.

10.2 Test set-up

Radiated emission measurements are performed in the Semi-Anechoic chamber. The equipment under test is placed on a non-conductive table 3-meters away from the receive antenna in accordance with ANSI C63.26 (2015) Section 5.5.3. The turntable is rotated through 360°, and the receiving antenna scans in order to determine the level of the maximized emission. The level and position of the maximized emission is recorded with the spectrum analyzer using RMS detector.

A vertically polarized half-wave dipole is then substituted in place of the EUT. For emissions above 1GHz, a horn antenna is substituted in place of the EUT. The substitute antenna is driven by a signal generator and the previously recorded signal was duplicated.

The power is calculated by the following formula;

$$Pd(\text{dBm}) = Pg(\text{dBm}) - \text{cable loss (dB)} + \text{antenna gain (dB)}$$

Where: Pd is the dipole equivalent power and Pg is the generator output power into the substitution antenna.

The maximum EIRP is calculated by adding the forward power to the calibrated source plus its appropriate gain value.

These steps are repeated with the receiving antenna in both vertical and horizontal polarization. the difference between the gain of the horn and an isotropic antenna are taken into consideration

Limits

LTE -4 Rule Part 27.53(h) specifies that “for operations in the 1695-1710 MHz, 1710-1755 MHz, 1755-1780 MHz, 1915-1920 MHz, 1995-2000 MHz, 2000-2020 MHz, 2110-2155 MHz, 2155-2180 MHz, and 2180-2200 bands, the power of any emission outside a licensee's frequency block shall be attenuated below the transmitter power (P) in watts by at least 43 + 10 log10 (P) dB.”

LTE -12 Rule Part 27.53 (g) For operations in the 600 MHz band and the 698-746 MHz band, the power of any emission outside a licensee's frequency band(s) of operation shall be attenuated below the transmitter power (P) within the licensed band(s) of operation, measured in watts, by at least 43 +10 log (P) dB. Compliance with this provision is based on the use of measurement instrumentation employing a resolution bandwidth of 100 kilohertz or greater. However, in the 100 kilohertz bands immediately outside and adjacent to a licensee's frequency block, a resolution bandwidth of at least 30 kHz may be employed.

LTE -13 Rule Part 27.53(f)For operations in the 746-758 MHz, 775-788 MHz, and 805-806 MHz bands, emissions in the band 1559-1610 MHz shall be limited to -70 dBW/MHz equivalent isotropically radiated power (EIRP) for wideband

signals, and -80 dBW EIRP for discrete emissions of less than 700 Hz bandwidth. For the purpose of equipment authorization, a transmitter shall be tested with an antenna that is representative of the type that will be used with the equipment in normal operation.

LTE Band 4 / 12 Limit

Limit	-13 dBm
-------	---------

LTE Band 13 Limit

Limit out of the band 1559-1610 MHz	-13 dBm
Limit in the band 1559-1610 MHz	-40 dBm

Radiated spurious emissions

1. Frequency Range : 9 kHz ~ 10th Harmonics of highest channel fundamental frequency.
 2. The EUT was setup to maximum output power. The 100 kHz RBW was used to scan from 30 MHz to 1 GHz.
- Also, the 1 MHz RBW was used to scan from 1 GHz to 20 GHz. The high, low and a middle channel were tested for out of band measurements.

10.3 Test equipment used

	Model Number	Manufacturer	Description	Serial Number	Last Cal. (Interval)
<input type="checkbox"/>	ESCI	Rohde & Schwarz	EMI Test Receiver	101012	Oct. 22, 2018 (1Y)
<input checked="" type="checkbox"/>	ESR	Rohde & Schwarz	EMI Test Receiver	101470	Oct. 22, 2018 (1Y)
<input checked="" type="checkbox"/>	310N	Sonoma Instrument	AMPLIFIER	312544	Mar. 28, 2018 (1Y)
<input checked="" type="checkbox"/>	FSV30	Rohde & Schwarz	Signal Analyzer	101372	Aug. 23, 2018 (1Y)
<input checked="" type="checkbox"/>	BBV9718B	Schwarzbeck	Broadband Preamplifier	009	Mar. 16, 2018 (1Y)
<input checked="" type="checkbox"/>	SCU-03	Rohde & Schwarz	Signal Conditioning Unit	100333	Mar. 15, 2018 (1Y)
<input type="checkbox"/>	SCU-18	Rohde & Schwarz	Pre-Amplifier	102266	Aug. 24, 2018 (1Y)
<input checked="" type="checkbox"/>	MA-4000XPET	Innco Systems GmbH	Antenna Master	MA4000/509	N/A
<input type="checkbox"/>	HD100	HD GmbH	Position Controller	N/A	N/A
<input checked="" type="checkbox"/>	DT3000-3t	Innco Systems GmbH	Turn Table	N/A	N/A
<input type="checkbox"/>	FMZB 1513	Schwarzbeck	LOOP ANTENNA	1513-235	May. 13, 2018 (2Y)
<input checked="" type="checkbox"/>	VULB9163	Schwarzbeck	TRILOG Broadband Antenna	9163-255	Jun 05, 2018 (2Y)
<input checked="" type="checkbox"/>	VULB9163	Schwarzbeck	Hybrid Antenna	777	Apr, 13, 2018 (2Y)
<input checked="" type="checkbox"/>	BBHA9120D	Schwarzbeck	Horn Antenna	BBHA9120D295	Aug. 16, 2017 (2Y)
<input checked="" type="checkbox"/>	BBHA9120D	Schwarzbeck	Horn Antenna	9120D-1349	Dec. 04, 2017 (2Y)
<input type="checkbox"/>	SCU40A	Rohde & Schwarz	Pre-Amplifier	100436	Mar. 15, 2018 (1Y)
<input checked="" type="checkbox"/>	MT8821C	ANRITSU	Radio Communication Analyzer	6261849029	Aug. 22, 2018 (1Y)

All test equipment used is calibrated on a regular basis.

10.4 Test data

10.4.1 Test data for LTE Band 4 QPSK

- Test Date : February 13, 2019 ~ February 26, 2019
- Detector : RMS
- Measurement distance : 3 m
- Result : PASSED

Frequency (MHz)	Substituted Level (dBm)	Ant. Pol. (H/V)	Cable Loss (dB)	Ant Gain (dBi)	Corrected Reading (dBm)	Limits (dBm)	Margin (dB)
Test Data for Low Channel							
3430.00	-70.25	V	2.11	12.51	-59.85	-13.00	46.85
5145.00	-78.18	V	2.46	12.73	-67.91	-13.00	54.91
6860.00	-73.38	V	3.25	12.36	-64.27	-13.00	51.27
8575.00	-69.76	H	3.93	11.55	-62.14	-13.00	49.14
10290.00	-67.71	V	4.06	11.64	-60.13	-13.00	47.13
Test Data for Middle Channel							
3465.00	-69.85	V	2.11	12.51	-59.45	-13.00	46.45
5197.50	-77.99	V	2.46	12.73	-67.72	-13.00	54.72
6930.00	-73.64	V	3.25	12.36	-64.53	-13.00	51.53
8662.50	-69.94	H	3.93	11.55	-62.32	-13.00	49.32
10395.00	-67.46	H	4.06	11.64	-59.88	-13.00	46.88
Test Data for High Channel							
3500.00	-70.34	H	2.11	12.51	-59.94	-13.00	46.94
5250.00	-77.95	V	2.46	12.73	-67.68	-13.00	54.68
7000.00	-73.45	V	3.25	12.36	-64.34	-13.00	51.34
8750.00	-70.20	V	3.93	11.55	-62.58	-13.00	49.58
10500.00	-67.51	H	4.06	11.64	-59.93	-13.00	46.93

Remark: 1. The other Spurious RF Radiated emissions level is no more than noise floor.

2. The worst case was found in QPSK modulation

3. Rule Part 27.53(h) specifies that “ the power of any emission outside a licensee's frequency block shall be attenuated below the transmitter power (P) in watts by at least $43 + 10 \log_{10} (P)$ dB.”

Limit : $30.00 - 43 + 10 \log_{10}(1.00) = -13$ dBm

“C.L” : Cable Loss, “H”: Horizontal, “V”: Vertical



Tested by: Ju Yun Park / Assistant Manager

10.4.2 Test data for LTE Band 12 QPSK

- Test Date : July 16, 2018 ~ August 14, 2018
- Detector : RMS
- Measurement distance : 3 m
- Result : PASSED

Frequency (MHz)	Substituted Level (dBm)	Ant. Pol. (H/V)	Cable Loss (dB)	Ant Gain (dBi)	Corrected Reading (dBm)	Limits (dBm)	Margin (dB)
Test Data for Low Channel							
1408.00	-63.54	H	1.14	7.50	-57.18	-13.00	44.18
2112.00	-60.46	H	1.36	6.70	-55.12	-13.00	42.12
2816.00	-54.37	V	1.82	5.00	-51.19	-13.00	38.19
3520.00	-80.28	V	2.11	12.51	-69.88	-13.00	56.88
4224.00	-78.39	V	2.32	12.18	-68.53	-13.00	55.53
Test Data for Middle Channel							
1415.00	-64.13	H	1.14	7.50	-57.77	-13.00	44.77
2122.50	-60.42	H	1.36	6.70	-55.08	-13.00	42.08
2830.00	-53.79	V	1.82	5.00	-50.61	-13.00	37.61
3537.50	-80.53	H	2.11	12.51	-70.13	-13.00	57.13
4245.00	-78.15	V	2.32	12.18	-68.29	-13.00	55.29
Test Data for High Channel							
1422.00	-63.69	H	1.14	7.50	-57.33	-13.00	44.33
2133.00	-60.59	H	1.36	6.70	-55.25	-13.00	42.25
2844.00	-54.05	V	1.82	5.00	-50.87	-13.00	37.87
3555.00	-80.31	V	2.11	12.51	-69.91	-13.00	56.91
4266.00	-78.99	H	2.32	12.18	-69.13	-13.00	56.13

Remark: 1. The other Spurious RF Radiated emissions level is no more than noise floor.
 2. The worst case was found in QPSK modulation
 3. Rule Part 27.53 (g) For operations in the 600 MHz band and the 698-746 MHz band, the power of any emission outside a licensee's frequency band(s) of operation shall be attenuated below the transmitter power (P) within the licensed band(s) of operation, measured in watts, by at least $43 + 10 \log (P)$ dB.
 Limit : $34.77 - 43 + 10 \log(3.00) = -13$ dBm
 "C.L" : Cable Loss, "H": Horizontal, "V": Vertical



Tested by: Ju Yun Park / Assistant Manager

10.4.2 Test data for LTE Band 13 QPSK

- . Test Date : July 16, 2018 ~ August 14, 2018
- . Detector : RMS
- . Measurement distance : 3 m
- . Result : PASSED

Frequency (MHz)	Substituted Level (dBm)	Ant. Pol. (H/V)	Cable Loss (dB)	Ant Gain (dBi)	Corrected Reading (dBm)	Limits (dBm)	Margin (dB)
Test Data for Middle Channel							
1564.00	-64.91	V	1.14	6.70	-59.35	-13.00	46.35
2346.00	-58.66	H	1.46	5.90	-54.22	-13.00	41.22
3128.00	-78.88	V	1.83	10.90	-69.81	-13.00	56.81
3910.00	-79.50	V	2.32	12.14	-69.68	-13.00	56.68
4692.00	-78.75	H	2.41	12.18	-68.98	-13.00	55.98

Remark: 1. The other Spurious RF Radiated emissions level is no more than noise floor.

2. The worst case was found in QPSK modulation

3. Rule Part 27.53(f) For operations in the 746-758 MHz, 775-788 MHz, and 805-806 MHz bands, emissions in the band 1559-1610 MHz shall be limited to -70 dBW/MHz equivalent isotropically radiated power (EIRP) for wideband signals, and -80 dBW EIRP for discrete emissions of less than 700 Hz bandwidth. For the purpose of equipment authorization, a transmitter shall be tested with an antenna that is representative of the type that will be used with the equipment in normal operation.

Limit out of the band 1559-1610 MHz : $34.77 - 43 + 10\log(3.00) = -13$ dBm

Limit in the band 1559-1610 MHz : -40 dBm

“C.L” : Cable Loss, “H”: Horizontal, “V”: Vertical



Tested by: Ju Yun Park / Assistant Manager

11. PEAK-TO-AVERAGE RATIO

11.1 Operating environment

Temperature : 23 °C
 Relative humidity : 47 % R.H.

11.2 Test set-up

Peak to Average Power Ratio is tested in accordance with KDB971168 D01 Power Meas License Digital Systems v04, April 9, 2018, Section 5.7.

- Section 5.7.2 Measurement of peak power in a broadband noise-like signal using CCDF

- a) Set resolution/measurement bandwidth \geq OBW or specified reference bandwidth.
- b) Set the number of counts to a value that stabilizes the measured CCDF curve.
- c) Set the measurement interval as follows:
 - 1) For continuous transmissions, set to the greater of $[10 \times (\text{number of points in sweep}) \times (\text{transmission symbol period})]$ or 1 ms.
 - 2) For burst transmissions, employ an external trigger that is synchronized with the EUT burst timing sequence, or use the internal burst trigger with a trigger level that allows the burst to stabilize. Set the measurement interval to a time that is less than or equal to the burst duration.
 - 3) If there are several carriers in a single antenna port, the peak power shall be determined for each individual carrier (by disabling the other carriers while measuring the required carrier) and the total peak power calculated from the sum of the individual carrier peak powers.
- d) Record the maximum PAPR level associated with a probability of 0.1%.
- e) The peak power level is calculated from the sum of the PAPR value from step d) to the measured average power.

- Section 5.7.3 Alternate Procedure for PAPR

Some regulatory requirements specify a PAPR limit when the output power limits are specified in terms of average power. If it becomes necessary to provide measurement data to demonstrate compliance to a PAPR limit, then the appropriate procedure from those provided in 5.2.3 shall be utilized to determine the peak power (or peak PSD) and the appropriate procedure from those provided in 5.2.4 shall be used to determine the average power (or average PSD). The data from these measurements is then used in Equation (2) to determine the PAPR of a narrowband CW-like signal. See 5.2.3.4 for guidance on determining the PAPR of a broadband noise-like signal.

$$\text{PAPR (dB)} = P_{\text{Pk}} \text{ (dBm or dBW)} - P_{\text{Avg}} \text{ (dBm or dBW)}$$

where

PAPR peak-to-average power ratio, in dB

P_{Pk} measured peak power or peak PSD level, in dBm or dBW

P_{Avg} measured average power or average PSD level, in dBm or dBW

11.3 Test equipment used

Model Number	Manufacturer	Description	Serial Number	Last Cal.
■ - FSV30	Rohde & Schwarz	Signal Analyzer	101372	Aug. 23, 2018 (1Y)
■ - AAMCS-UDC	AA-MCS	Directional Coupler	400	Aug. 23, 2018 (1Y)
■ - MT8821C	ANRITSU	Radio Communication Analyzer	6261849029	Aug. 22, 2018 (1Y)
■ - PWS-3003D	Protek	DC Power Supply	4020409	Aug. 24, 2018 (1Y)

All test equipment used is calibrated on a regular basis.

11.4 Test data

11.4.1 Test data LTE Band 4

- Test Date : February 13, 2019 ~ February 26, 2019

- Test Result : Pass

LTE Band 4 QPSK

Test Mode	Channel	Peak-Average Ratio(PAR) CCDF 0.1 %	Limit (dB)	Result
1 RB	20000	4.58	13.00	PASS
	20175	4.38	13.00	PASS
	20350	4.20	13.00	PASS
6 RB	20000	4.52	13.00	PASS
	20175	4.43	13.00	PASS
	20350	4.81	13.00	PASS

Remark: Measured the using CCDFof spectrum analyzer.

LTE Band 4 16QAM

Test Mode	Channel	Peak-Average Ratio(PAR) CCDF 0.1 %	Limit (dB)	Result
1 RB	20000	5.28	13.00	PASS
	20175	5.83	13.00	PASS
	20350	5.04	13.00	PASS
6 RB	20000	5.86	13.00	PASS
	20175	5.04	13.00	PASS
	20350	4.84	13.00	PASS

Remark: Measured the using CCDFof spectrum analyzer.



Tested by: Ju Yun Park / Assistant Manager

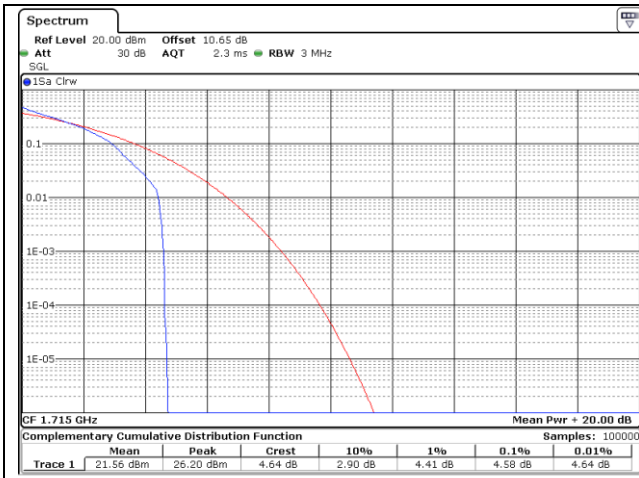

QPSK Low Channel (1 RB)

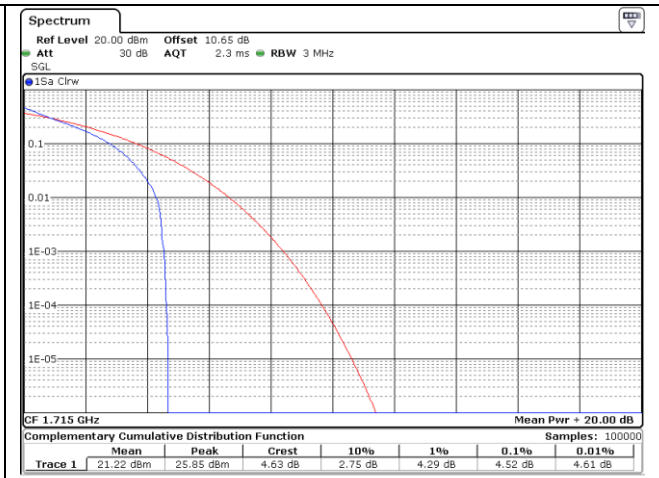

QPSK Low Channel (6 RB)

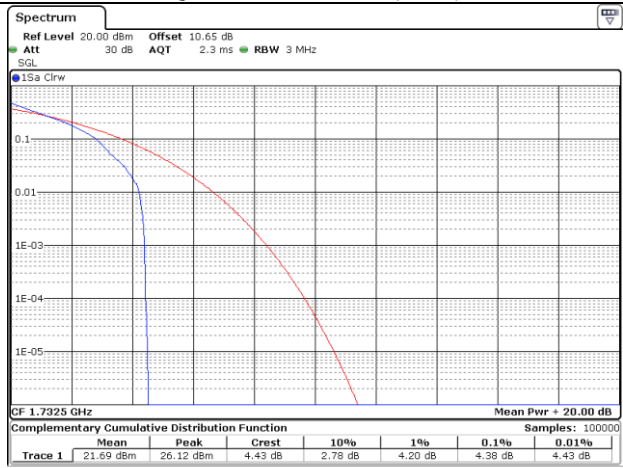

QPSK Middle Channel (1 RB)

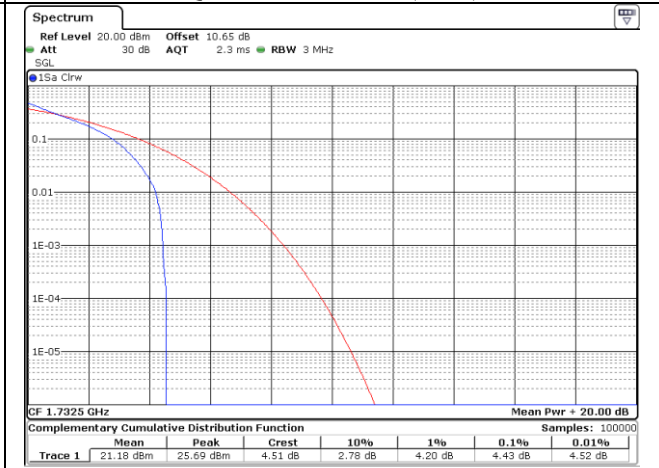

QPSK Middle Channel (6 RB)

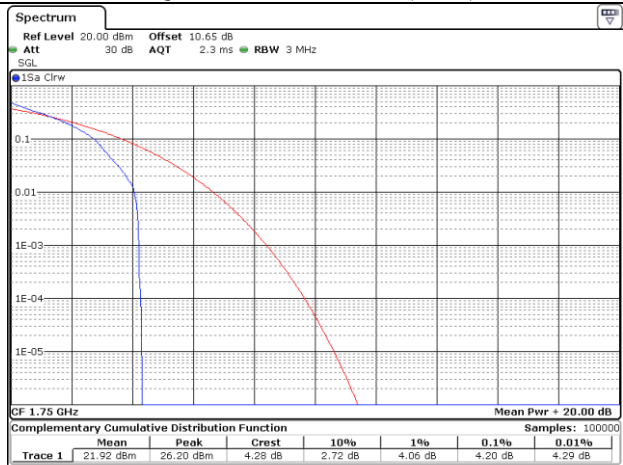

QPSK High Channel (1 RB)

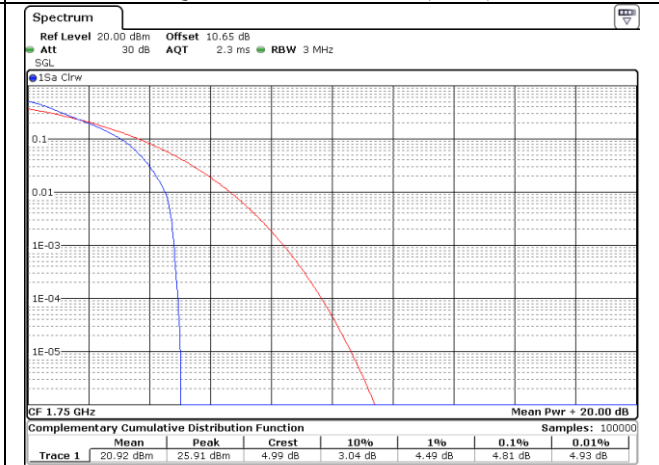

QPSK High Channel (6 RB)

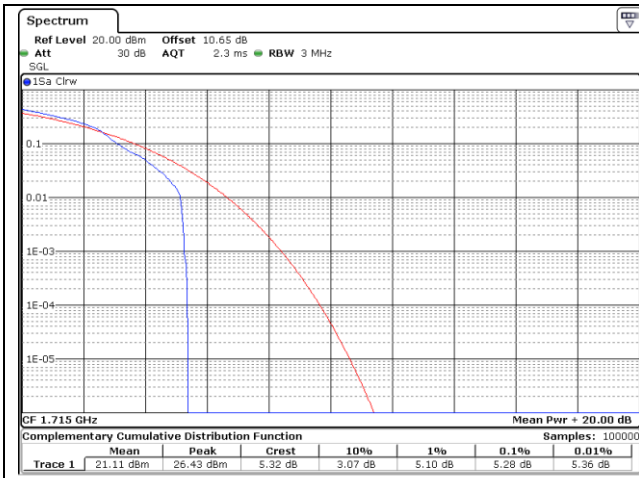

16QAM Low Channel (1 RB)

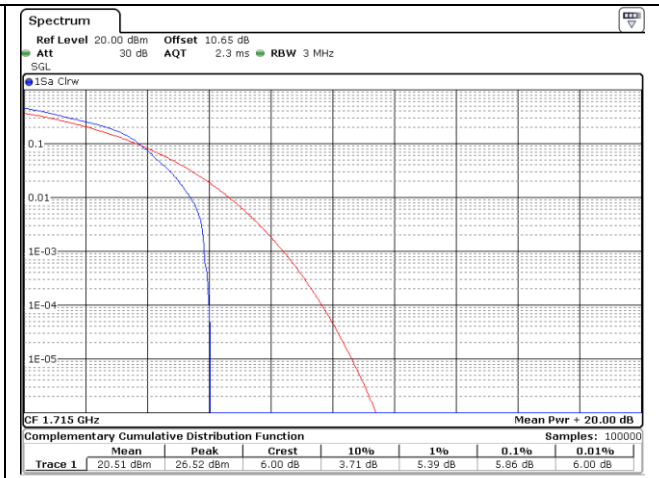

16QAM Low Channel (6 RB)

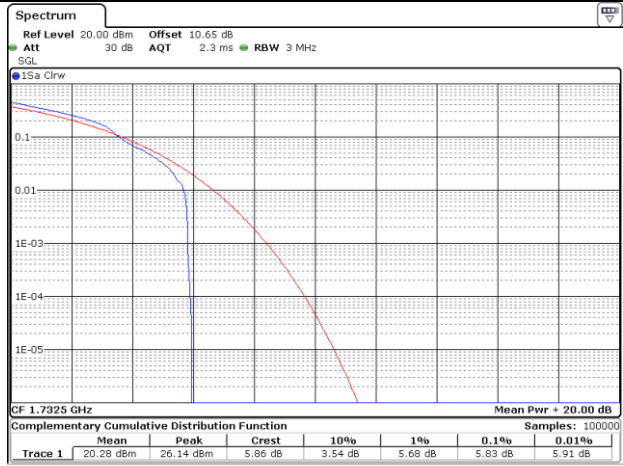

16QAM Middle Channel (1 RB)

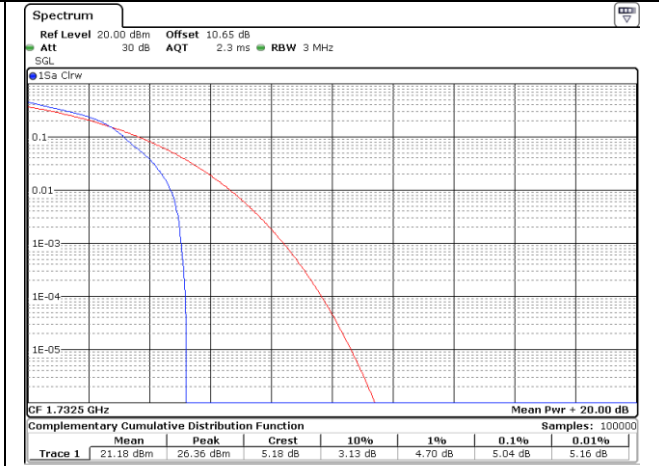

16QAM Middle Channel (6 RB)

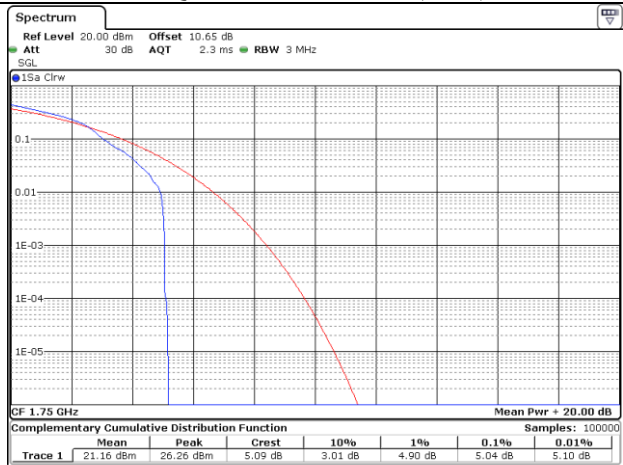

16QAM High Channel (1 RB)

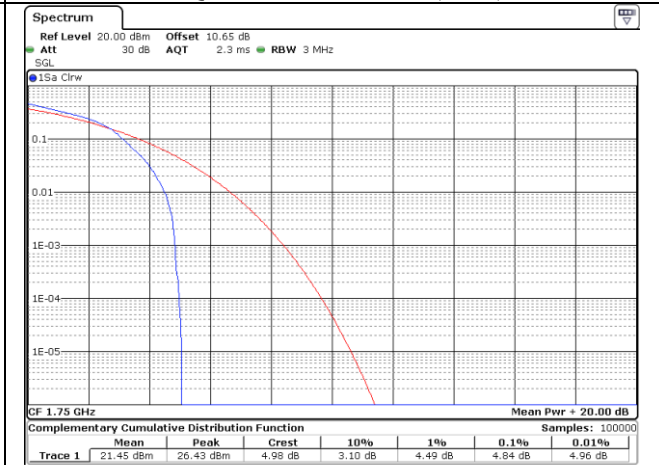

16QAM High Channel (6 RB)

11.4.2 Test data LTE Band 12

- Test Date : February 13, 2019 ~ February 26, 2019

- Test Result : Pass

LTE Band 12 QPSK

Test Mode	Channel	Peak-Average Ratio(PAR) CCDF 0.1 %	Limit (dB)	Result
1 RB	23060	4.81	13.00	PASS
	23095	4.52	13.00	PASS
	23130	4.84	13.00	PASS
6 RB	23060	5.59	13.00	PASS
	23095	4.78	13.00	PASS
	23130	4.70	13.00	PASS

Remark: Measured the using CCDFof spectrum analyzer.

LTE Band 12 16QAM

Test Mode	Channel	Peak-Average Ratio(PAR) CCDF 0.1 %	Limit (dB)	Result
1 RB	23060	5.94	13.00	PASS
	23095	6.35	13.00	PASS
	23130	5.33	13.00	PASS
6 RB	23060	6.17	13.00	PASS
	23095	5.25	13.00	PASS
	23130	5.94	13.00	PASS

Remark: Measured the using CCDFof spectrum analyzer.



Tested by: **Ju Yun Park / Assistant Manager**

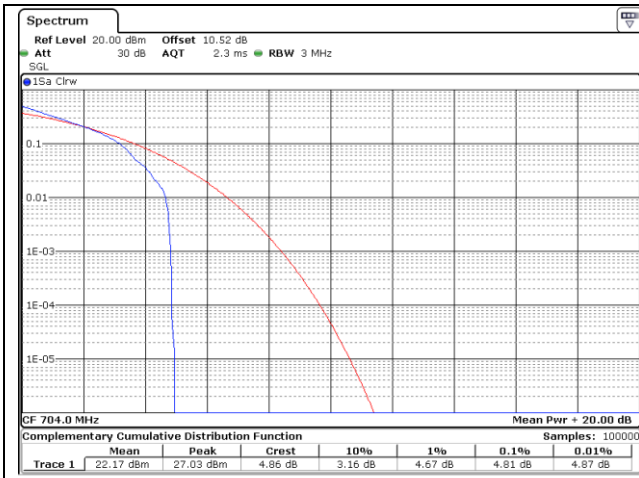

QPSK Low Channel (1 RB)

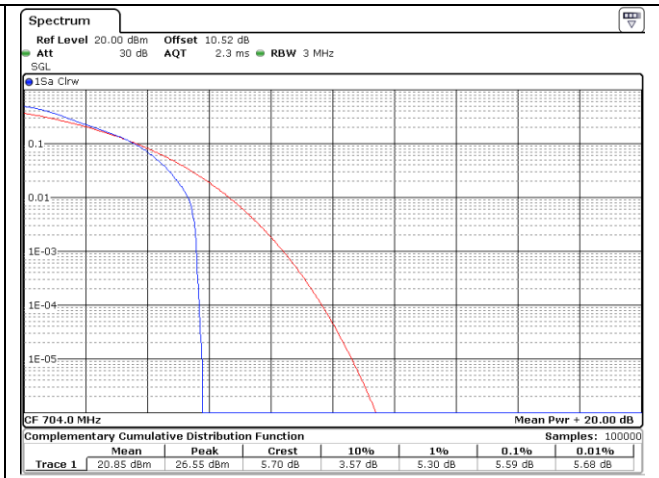

QPSK Low Channel (6 RB)

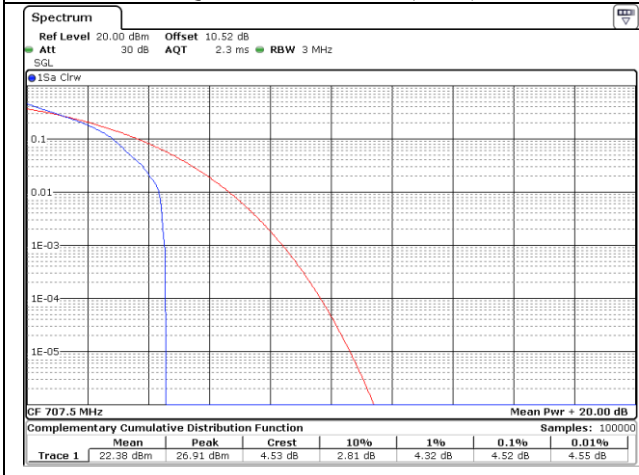

QPSK Middle Channel (1 RB)

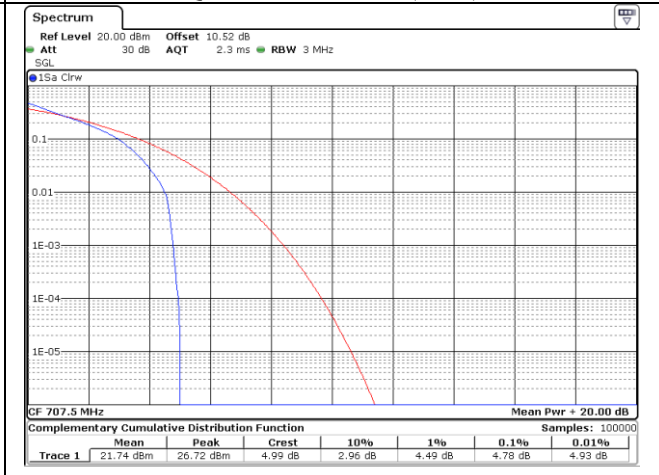

QPSK Middle Channel (6 RB)

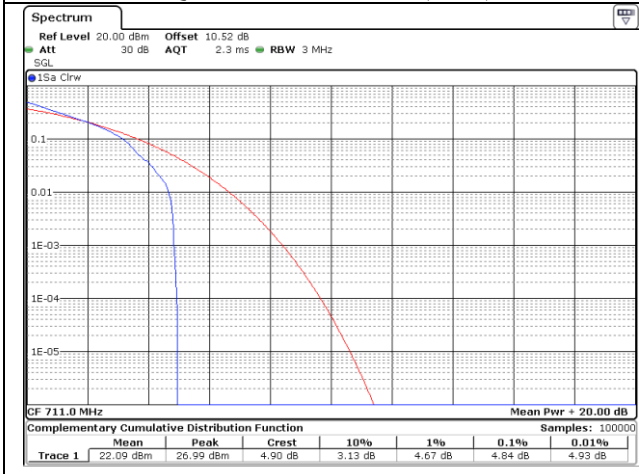

QPSK High Channel (1 RB)

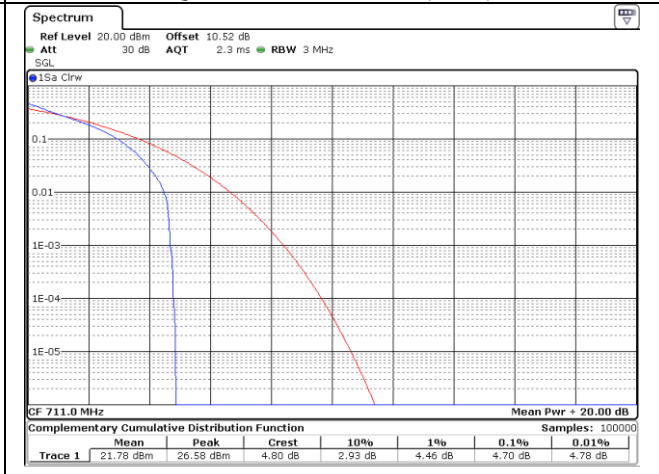

QPSK High Channel (6 RB)

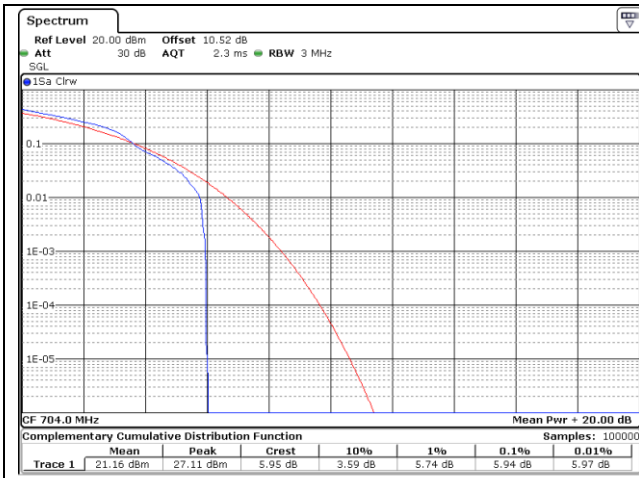

16QAM Low Channel (1 RB)

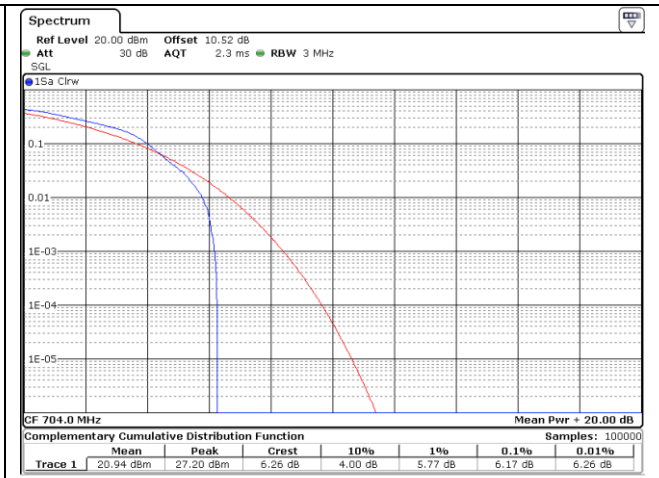

16QAM Low Channel (6 RB)

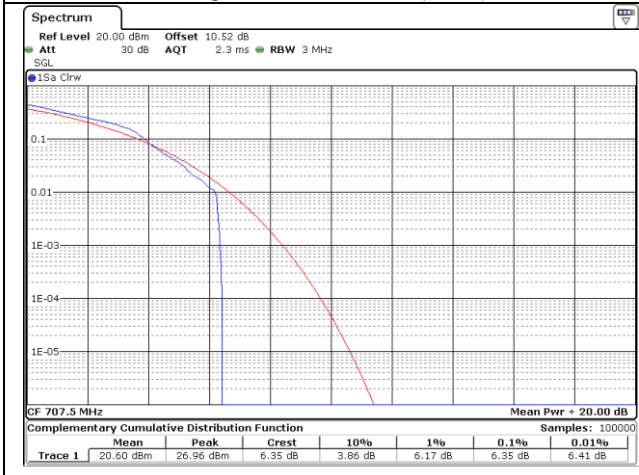

16QAM Middle Channel (1 RB)

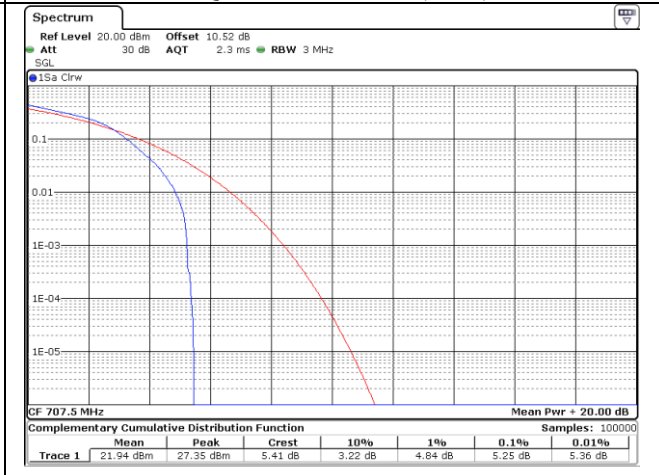

16QAM Middle Channel (6 RB)

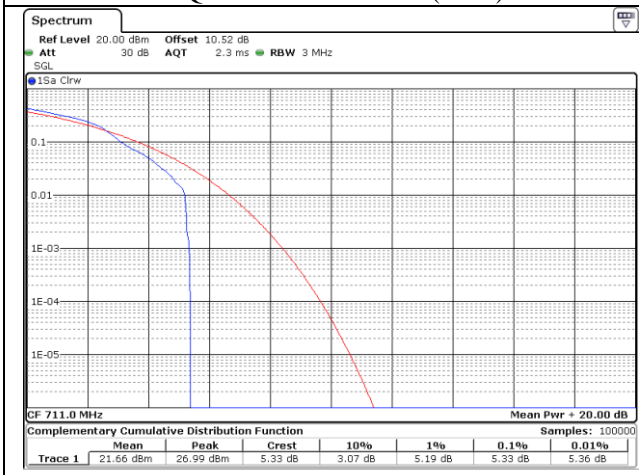

16QAM High Channel (1 RB)

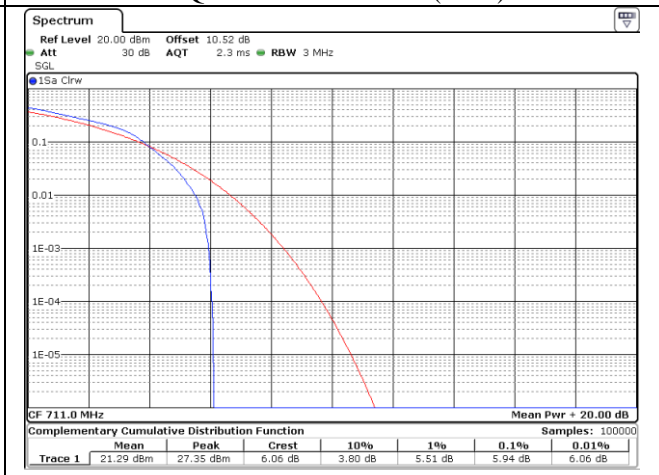

16QAM High Channel (6 RB)

11.4.3 Test data LTE Band 13

- Test Date : February 13, 2019 ~ February 26, 2019

- Test Result : Pass

LTE Band 13 QPSK

Test Mode	Channel	Peak-Average Ratio(PAR) CCDF 0.1 %	Limit (dB)	Result
1 RB	23230	4.55	13.00	PASS
6 RB	23230	5.57	13.00	PASS

Remark: Measured the using CCDFof spectrum analyzer.

LTE Band 13 16QAM

Test Mode	Channel	Peak-Average Ratio(PAR) CCDF 0.1 %	Limit (dB)	Result
1 RB	23230	5.45	13.00	PASS
6 RB	23230	6.35	13.00	PASS

Remark: Measured the using CCDFof spectrum analyzer.

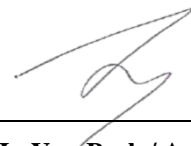

Tested by: Ju Yun Park / Assistant Manager

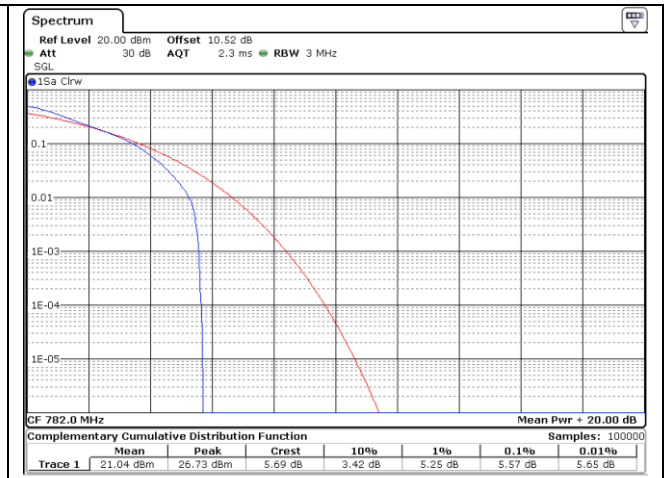
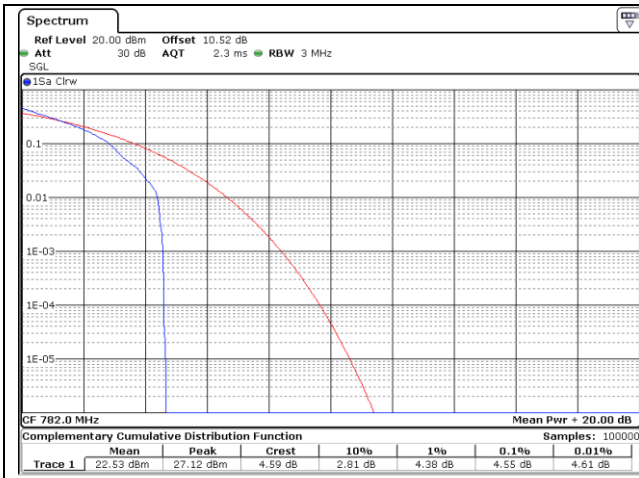

QPSK Middle Channel (1 RB)

QPSK Middle Channel (6 RB)

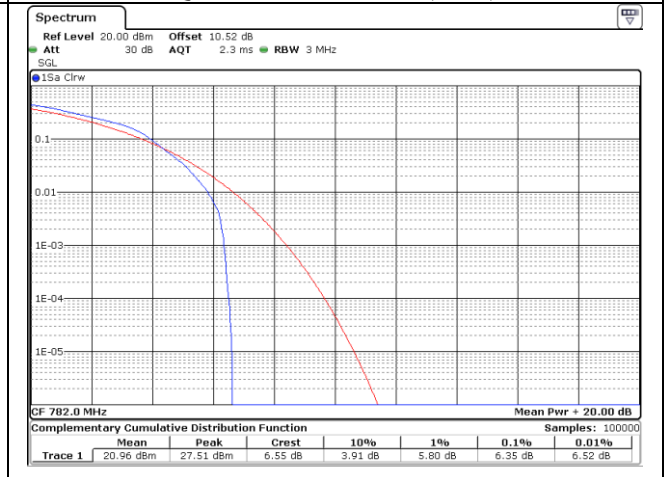
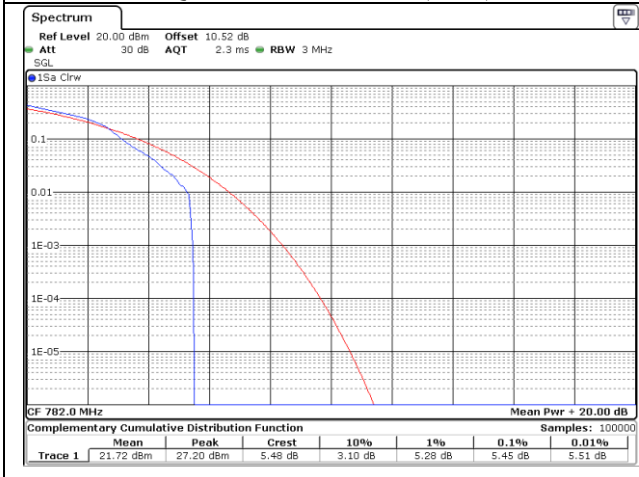

16QAM Middle Channel (1 RB)

16QAM Middle Channel (6 RB)

12. OCCUPIED BANDWIDTH

12.1 Operating environment

Temperature : 23 °C
 Relative humidity : 47 % R.H.

12.2 Test set-up

The emission bandwidth (×dB) is defined as the frequency range between two points, one above and one below the carrier frequency, at which the spectral density of the emission is attenuated × dB below the maximum in-band spectral density of the modulated signal. Spectral density (power per unit bandwidth) is to be measured with a detector of resolution bandwidth in the range of 1% to 5% of the anticipated emission bandwidth, and a video bandwidth at least 3× the resolution bandwidth. When the occupied bandwidth limit is not stated in the applicable RSS or reference measurement method, the transmitted signal bandwidth shall be reported as the 99% emission bandwidth, as calculated or measured.

- The transmitter shall be operated at its maximum carrier power measured under normal test conditions.
- The span of the analyzer shall be set to capture all products of the modulation process, including the emission skirts.
- The resolution bandwidth (RBW) shall be in the range of 1% to 5% of the occupied bandwidth (OBW) and video bandwidth (VBW) shall be approximately 3×RBW.

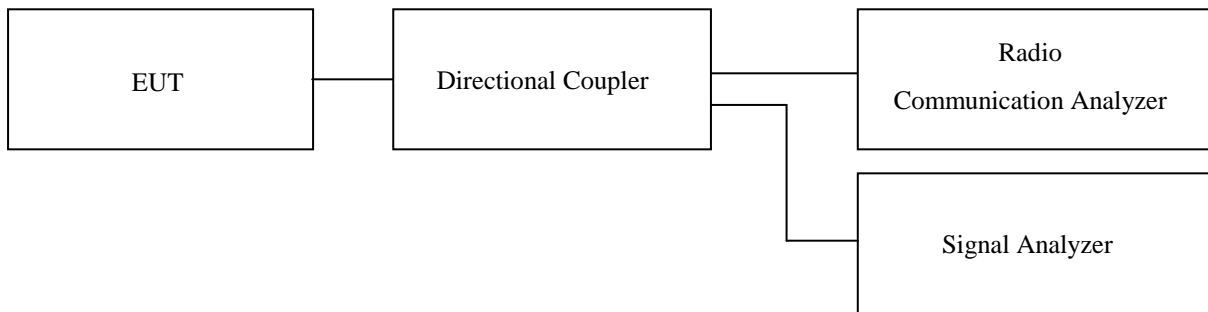

12.3 Test equipment used

Model Number	Manufacturer	Description	Serial Number	Last Cal.
■ - FSV30	Rohde & Schwarz	Signal Analyzer	101372	Aug. 23, 2018 (1Y)
■ - AAMCS-UDC	AA-MCS	Directional Coupler	400	Aug. 23, 2018 (1Y)
■ - MT8821C	ANRITSU	Radio Communication Analyzer	6261849029	Aug. 22, 2018 (1Y)
■ - PWS-3003D	Protek	DC Power Supply	4020409	Aug. 24, 2018 (1Y)

All test equipment used is calibrated on a regular basis.

12.4 Test data

12.4.1 Test data for LTE Band 4

-. Test Date : February 13, 2019 ~ February 26, 2019

-. Test Result : Pass

Test Mode	Channel	26 dB Bandwidth (MHz)	99 % Occupied Bandwidth (MHz)	Result
QPSK	Low	1.558	1.139	PASS
	Middle	1.578	1.139	PASS
	High	1.558	1.139	PASS

Test Mode	Channel	26 dB Bandwidth (MHz)	99 % Occupied Bandwidth (MHz)	Result
16QAM	Low	1.618	1.159	PASS
	Middle	1.618	1.179	PASS
	High	1.618	1.179	PASS

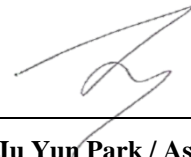

Tested by: Ju Yun Park / Assistant Manager

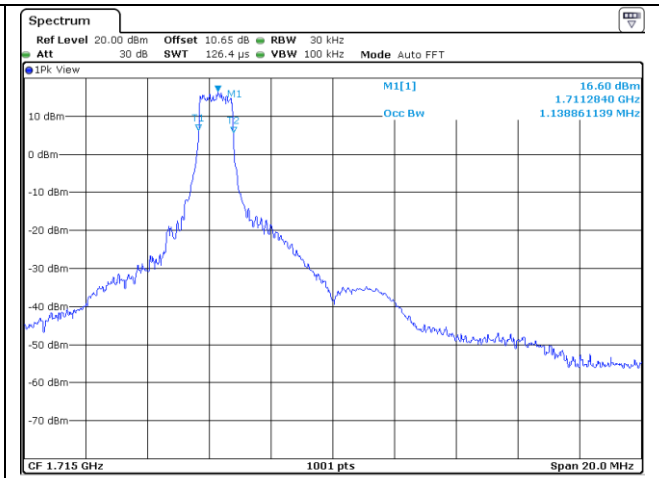
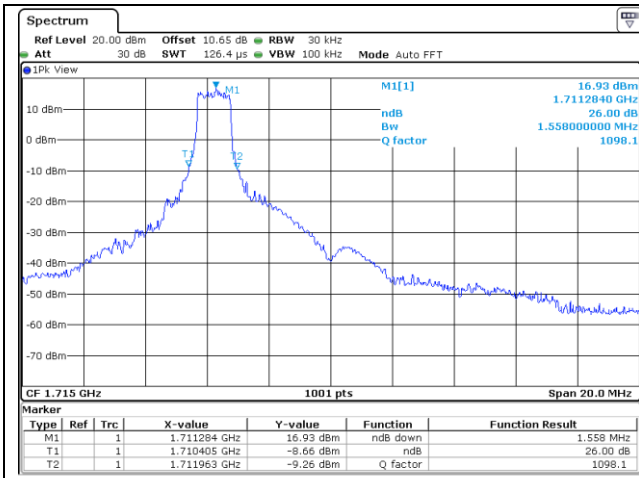

QPSK Low Channel (26 dB Bandwidth)

QPSK Low Channel (99 % Occupied Bandwidth)

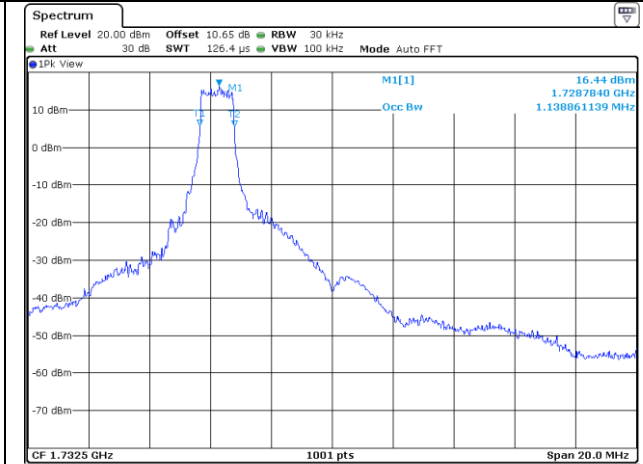
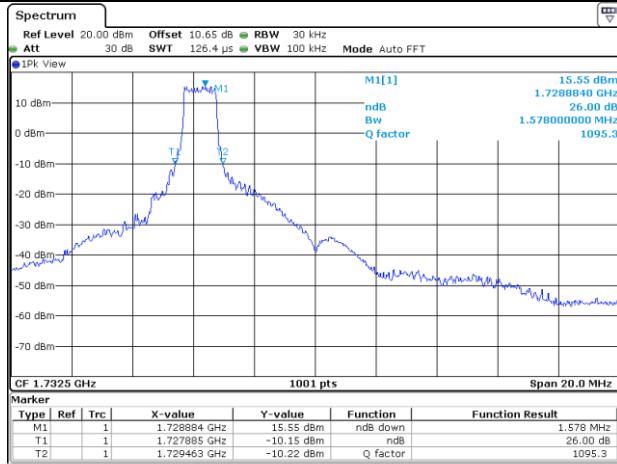

QPSK Middle Channel (26 dB Bandwidth)

QPSK Middle Channel (99 % Occupied Bandwidth)

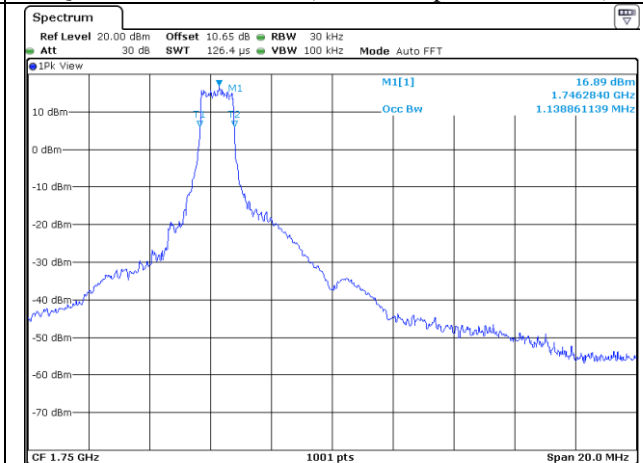
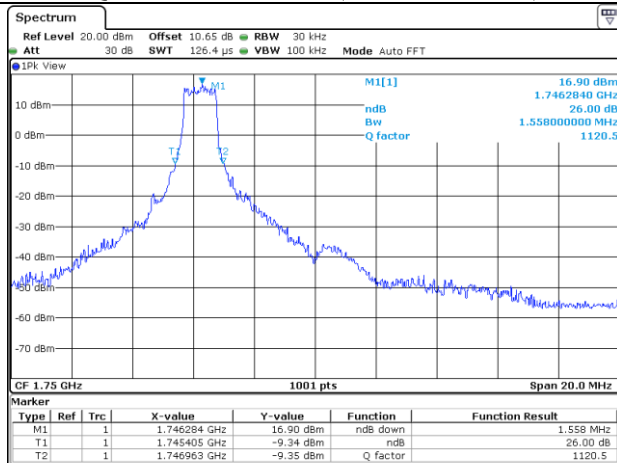

QPSK High Channel (26 dB Bandwidth)

QPSK High Channel (99 % Occupied Bandwidth)

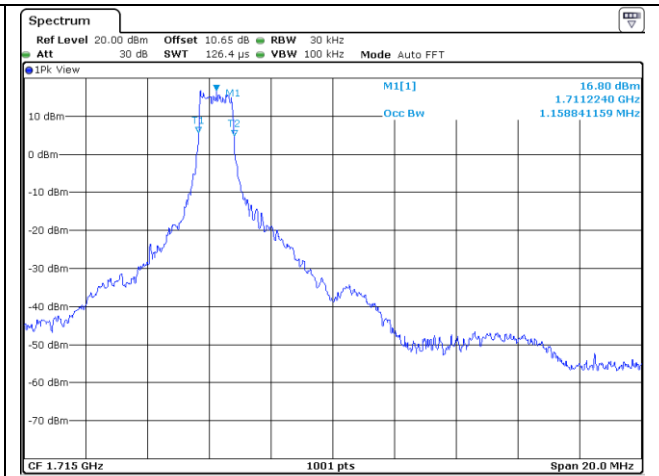
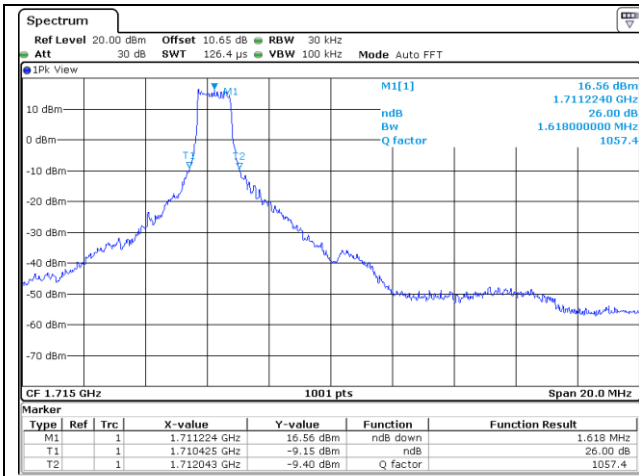

16QAM Low Channel (26 dB Bandwidth)

16QAM Low Channel (99 % Occupied Bandwidth)

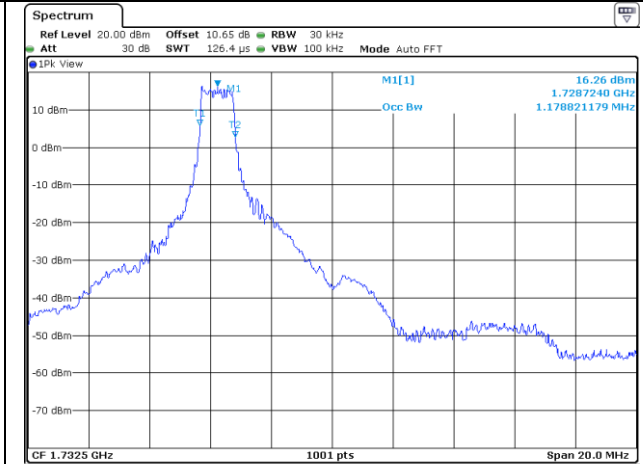
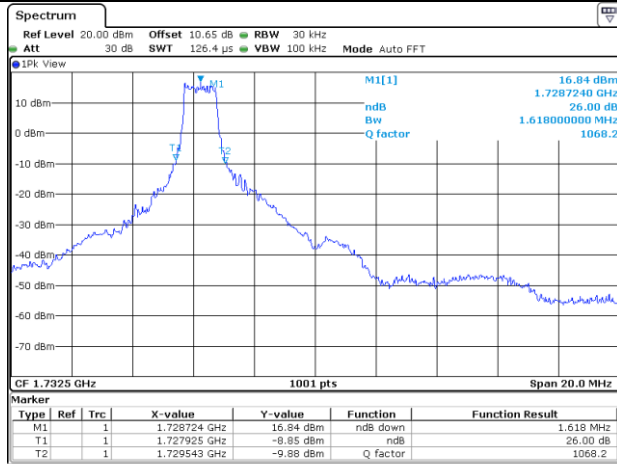

16QAM Middle Channel (26 dB Bandwidth)

16QAM Middle Channel (99 % Occupied Bandwidth)

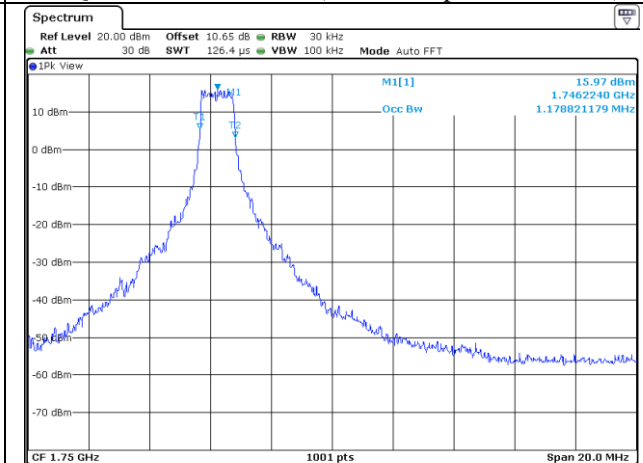
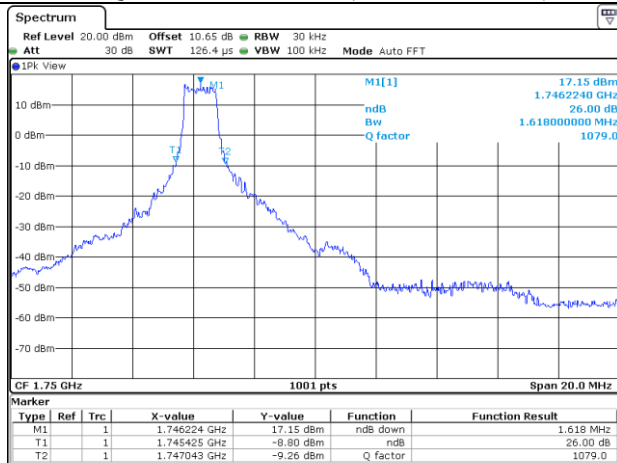

16QAM High Channel (26 dB Bandwidth)

16QAM High Channel (99 % Occupied Bandwidth)

12.4.2 Test data for LTE Band 12

- Test Date : February 13, 2019 ~ February 26, 2019

- Test Result : Pass

Test Mode	Channel	26 dB Bandwidth (MHz)	99 % Occupied Bandwidth (MHz)	Result
QPSK	Low	1.598	1.139	PASS
	Middle	1.578	1.139	PASS
	High	1.618	1.159	PASS

Test Mode	Channel	26 dB Bandwidth (MHz)	99 % Occupied Bandwidth (MHz)	Result
16QAM	Low	1.678	1.179	PASS
	Middle	1.658	1.159	PASS
	High	1.658	1.159	PASS

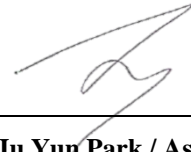

Tested by: Ju Yun Park / Assistant Manager

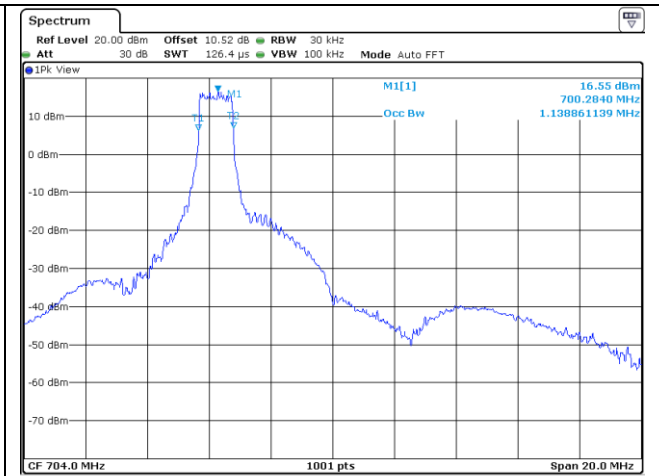
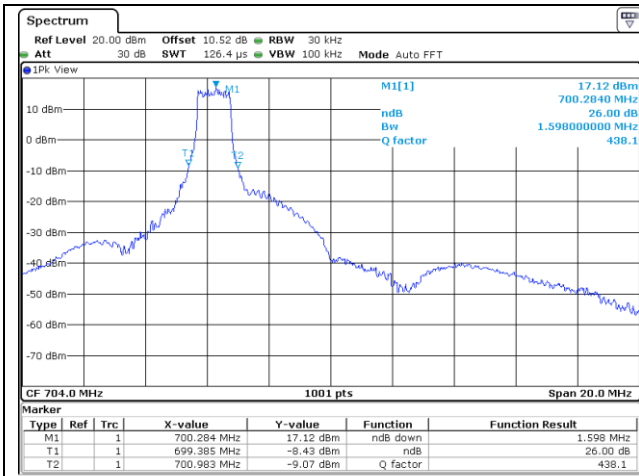

QPSK Low Channel (26 dB Bandwidth)

QPSK Low Channel (99 % Occupied Bandwidth)

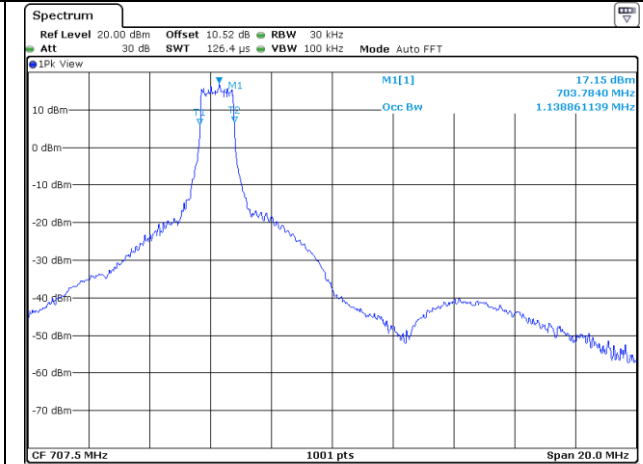
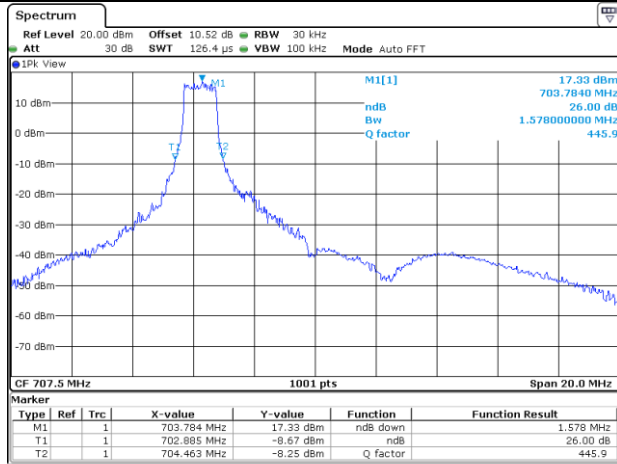

QPSK Middle Channel (26 dB Bandwidth)

QPSK Middle Channel (99 % Occupied Bandwidth)

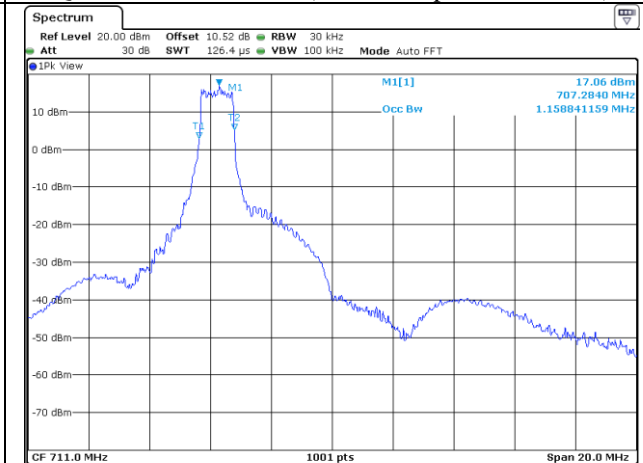
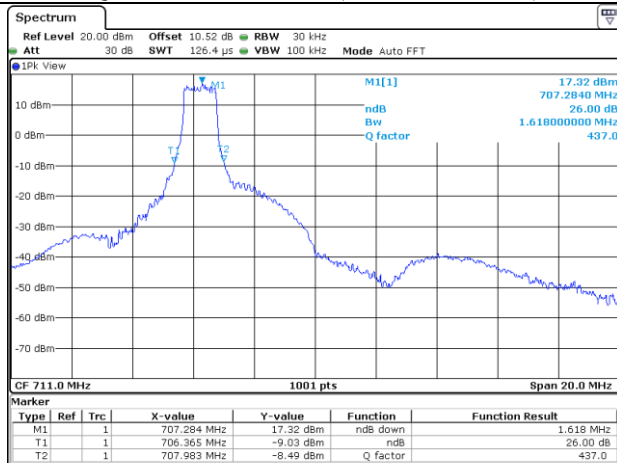

QPSK High Channel (26 dB Bandwidth)

QPSK High Channel (99 % Occupied Bandwidth)

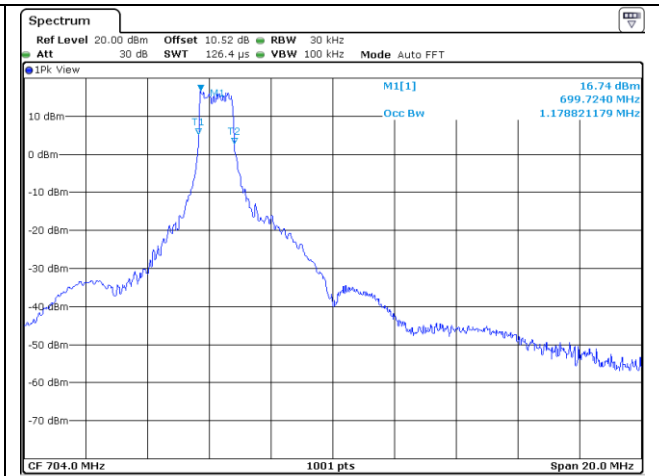
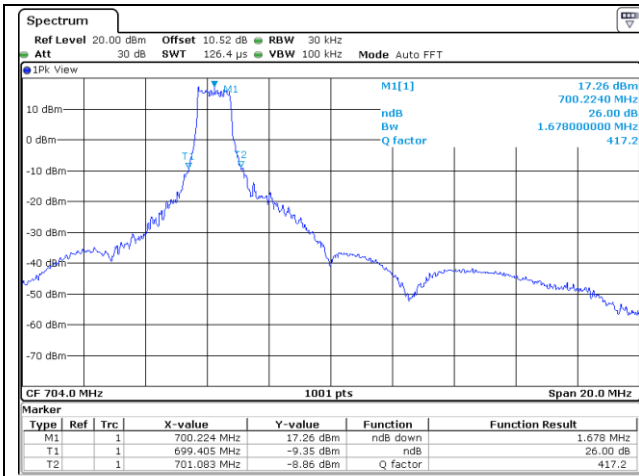

16QAM Low Channel (26 dB Bandwidth)

16QAM Low Channel (99 % Occupied Bandwidth)

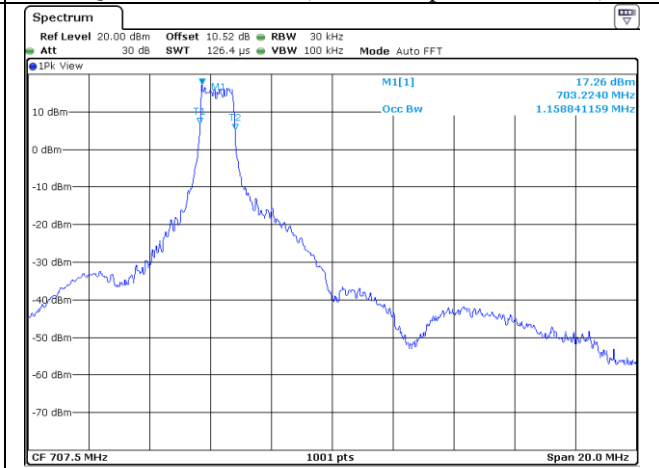
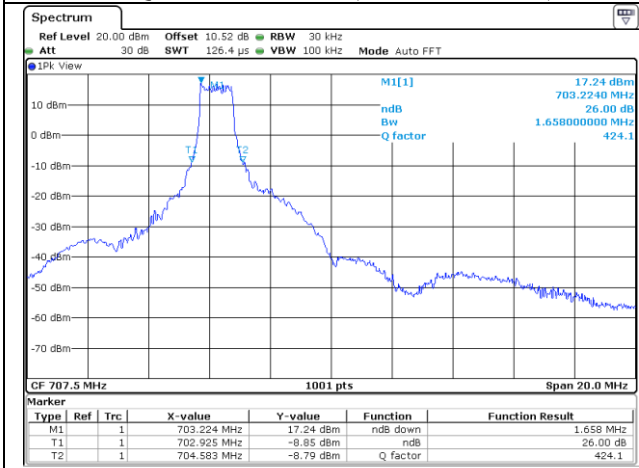

16QAM Middle Channel (26 dB Bandwidth)

16QAM Middle Channel (99 % Occupied Bandwidth)

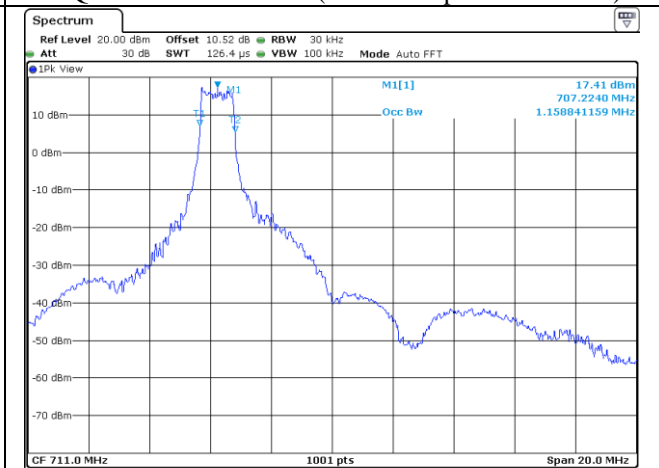
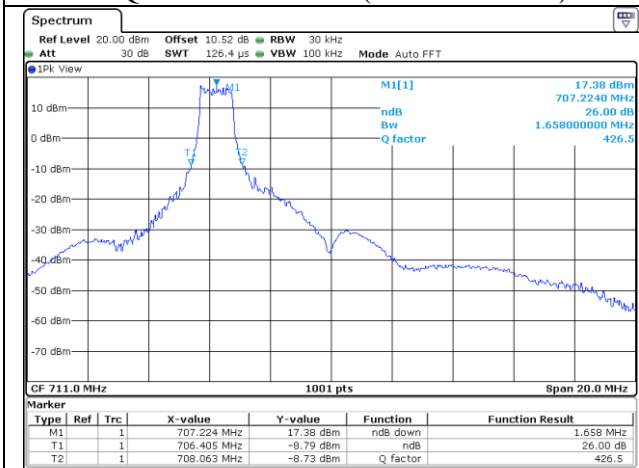

16QAM High Channel (26 dB Bandwidth)

16QAM High Channel (99 % Occupied Bandwidth)

12.4.3 Test data for LTE Band 13

-. Test Date : February 13, 2019 ~ February 26, 2019

-. Test Result : Pass

Test Mode	Channel	26 dB Bandwidth (MHz)	99 % Occupied Bandwidth (MHz)	Result
QPSK	Low	1.618	1.139	PASS

Test Mode	Channel	26 dB Bandwidth (MHz)	99 % Occupied Bandwidth (MHz)	Result
16QAM	Low	1.678	1.159	PASS

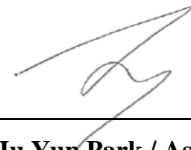

Tested by: Ju Yun Park / Assistant Manager

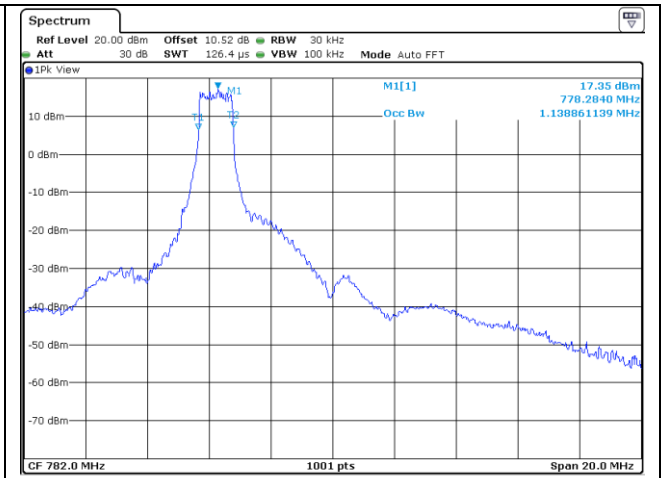
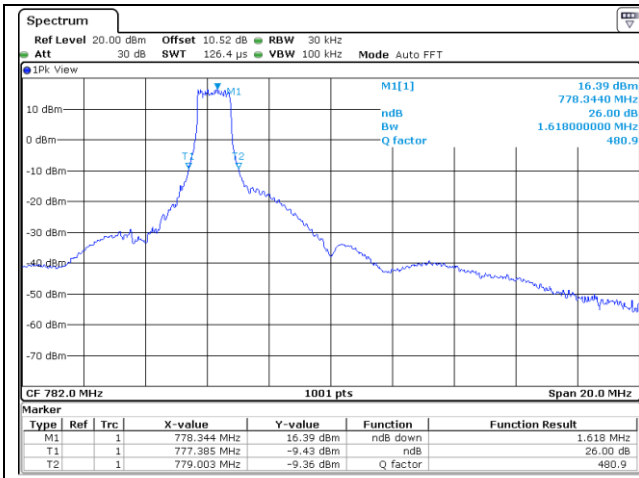

QPSK Middle Channel (26 dB Bandwidth)

QPSK Middle Channel (99 % Occupied Bandwidth)

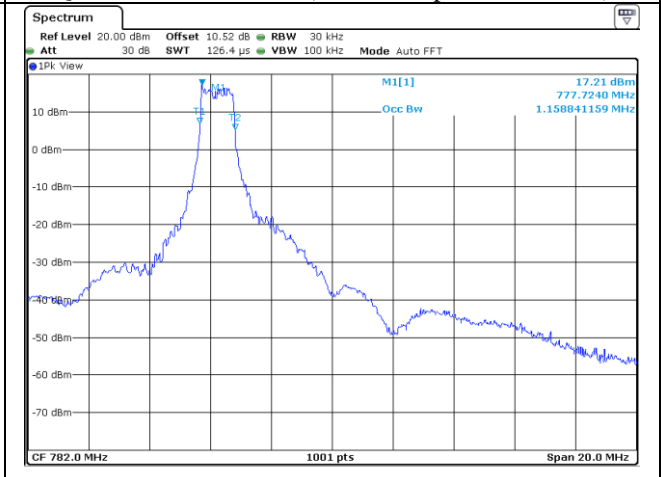
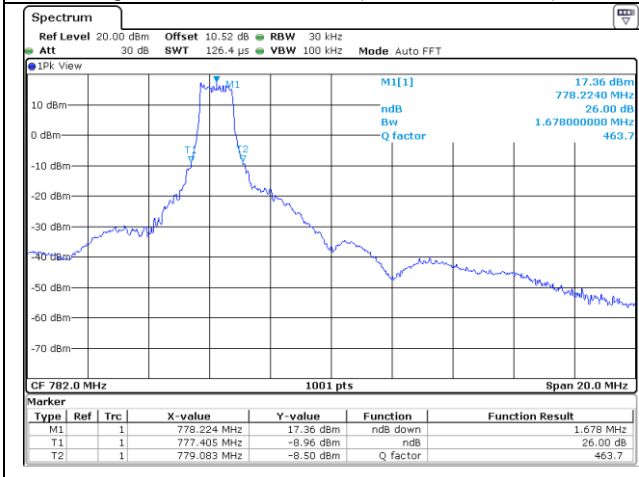

16QAM Middle Channel (26 dB Bandwidth)

16QAM Middle Channel (99 % Occupied Bandwidth)

13. Conducted Band Edge

13.1 Operating environment

Temperature : 23 °C
 Relative humidity : 47 % R.H.

13.2 Test set-up

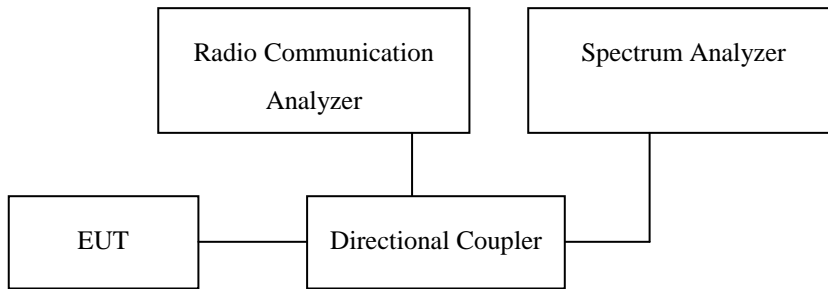

(Configuration of conducted Emission measurement)

Conducted Spurious Emissions is tested in accordance with KDB971168 D01 Power Meas License Digital Systems v04, April 9, 2018, Section 6.

The EUT makes a call to the communication simulator. The power was measured with R&S Spectrum Analyzer. All measurements were done at 3 channels(low, middle and high operational range.)

The Conducted Spurious Emissions used the power splitter via EUT RF power connector between simulation base station and spectrum analyzer.

The communication simulator station system controlled a EUT to export maximum output power under transmission mode and specific channel frequency.

13.3 Methods of Measurement

1. All measurements were done at low and high operational frequency range.
2. Set spectrum analyzer with RMS detector.
3. The center frequency of spectrum is the band edge frequency and set RBW of the spectrum is 20 kHz and VBW of the spectrum is 50 kHz

13.4 Limits

LTE -4 Rule Part 27.53(h) specifies that “for operations in the 1695-1710 MHz, 1710-1755 MHz, 1755-1780 MHz, 1915-1920 MHz, 1995-2000 MHz, 2000-2020 MHz, 2110-2155 MHz, 2155-2180 MHz, and 2180-2200 bands, the power of any emission outside a licensee's frequency block shall be attenuated below the transmitter power (P) in watts by at least 43 + 10 log10 (P) dB.”

LTE -12 Rule Part 27.53 (g) For operations in the 600 MHz band and the 698-746 MHz band, the power of any emission outside a licensee's frequency band(s) of operation shall be attenuated below the transmitter power (P) within the licensed

band(s) of operation, measured in watts, by at least $43 + 10 \log (P)$ dB. Compliance with this provision is based on the use of measurement instrumentation employing a resolution bandwidth of 100 kilohertz or greater. However, in the 100 kilohertz bands immediately outside and adjacent to a licensee's frequency block, a resolution bandwidth of at least 30 kHz may be employed.

LTE -13 Rule Part 27.53(f) For operations in the 746-758 MHz, 775-788 MHz, and 805-806 MHz bands, emissions in the band 1559-1610 MHz shall be limited to -70 dBW/MHz equivalent isotropically radiated power (EIRP) for wideband signals, and -80 dBW EIRP for discrete emissions of less than 700 Hz bandwidth. For the purpose of equipment authorization, a transmitter shall be tested with an antenna that is representative of the type that will be used with the equipment in normal operation.

LTE Band 4 / 12 Limit

Limit	-13 dBm
-------	---------

LTE Band 13 Limit

Limit out of the band 1559-1610 MHz	-13 dBm
Limit in the band 1559-1610 MHz	-40 dBm

13.5 Test equipment used

	Model Number	Manufacturer	Description	Serial Number	Last Cal.
■ -	FSV30	Rohde & Schwarz	Signal Analyzer	101372	Aug. 23, 2018 (1Y)
■ -	AAMCS-UDC	AA-MCS	Directional Coupler	400	Aug. 23, 2018 (1Y)
■ -	MT8821C	ANRITSU	Radio Communication Analyzer	6261849029	Aug. 22, 2018 (1Y)
■ -	PWS-3003D	Protek	DC Power Supply	4020409	Aug. 24, 2018 (1Y)

All test equipment used is calibrated on a regular basis.

13.6 Test data

13.6.1 Test data for LTE Band 4

-. Test Date : February 13, 2019 ~ February 26, 2019

-. Test Result : Pass

LTE Band 4 QPSK

Test Mode	Channel	Edge Frequency (MHz)	MEASURED VLAUE (dBm)	Limit (dBm)	Result
1 RB	Low	1710.0000	-38.70	-13.00	PASS
	High	1755.0000	-39.40	-13.00	PASS
6 RB	Low	1710.0000	-37.17	-13.00	PASS
	High	1755.0000	-37.20	-13.00	PASS

LTE Band 4 16QAM

Test Mode	Channel	Edge Frequency (MHz)	MEASURED VLAUE (dBm)	Limit (dBm)	Result
1 RB	Low	1710.0000	-38.02	-13.00	PASS
	High	1755.0000	-38.45	-13.00	PASS
6 RB	Low	1710.0000	-35.97	-13.00	PASS
	High	1755.0000	-36.25	-13.00	PASS

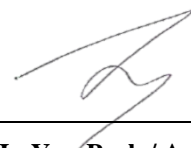

Tested by: Ju Yun Park / Assistant Manager

13.6.2 Test data for LTE Band 4 QPSK

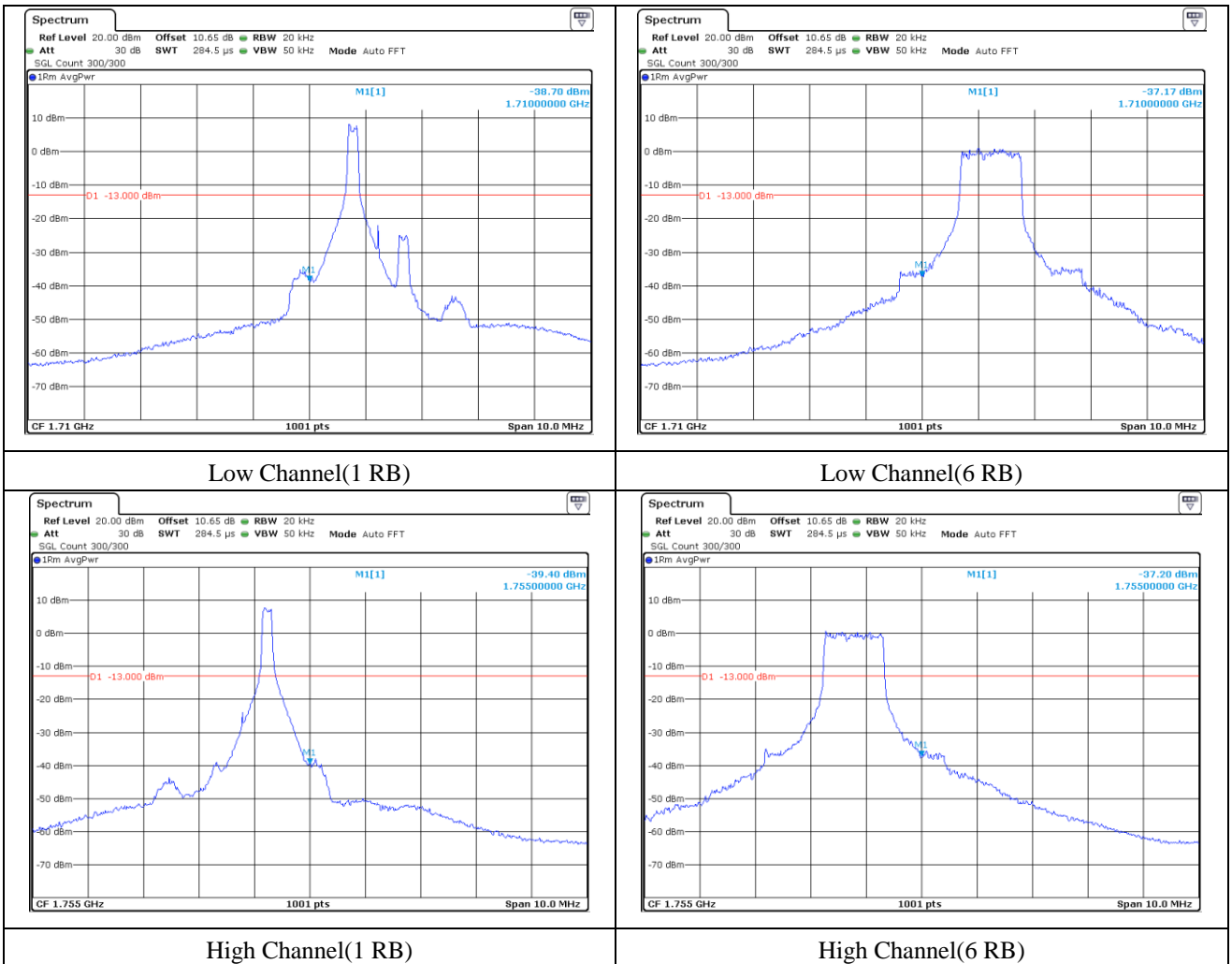

13.6.3 Test data for LTE Band 4 16QAM

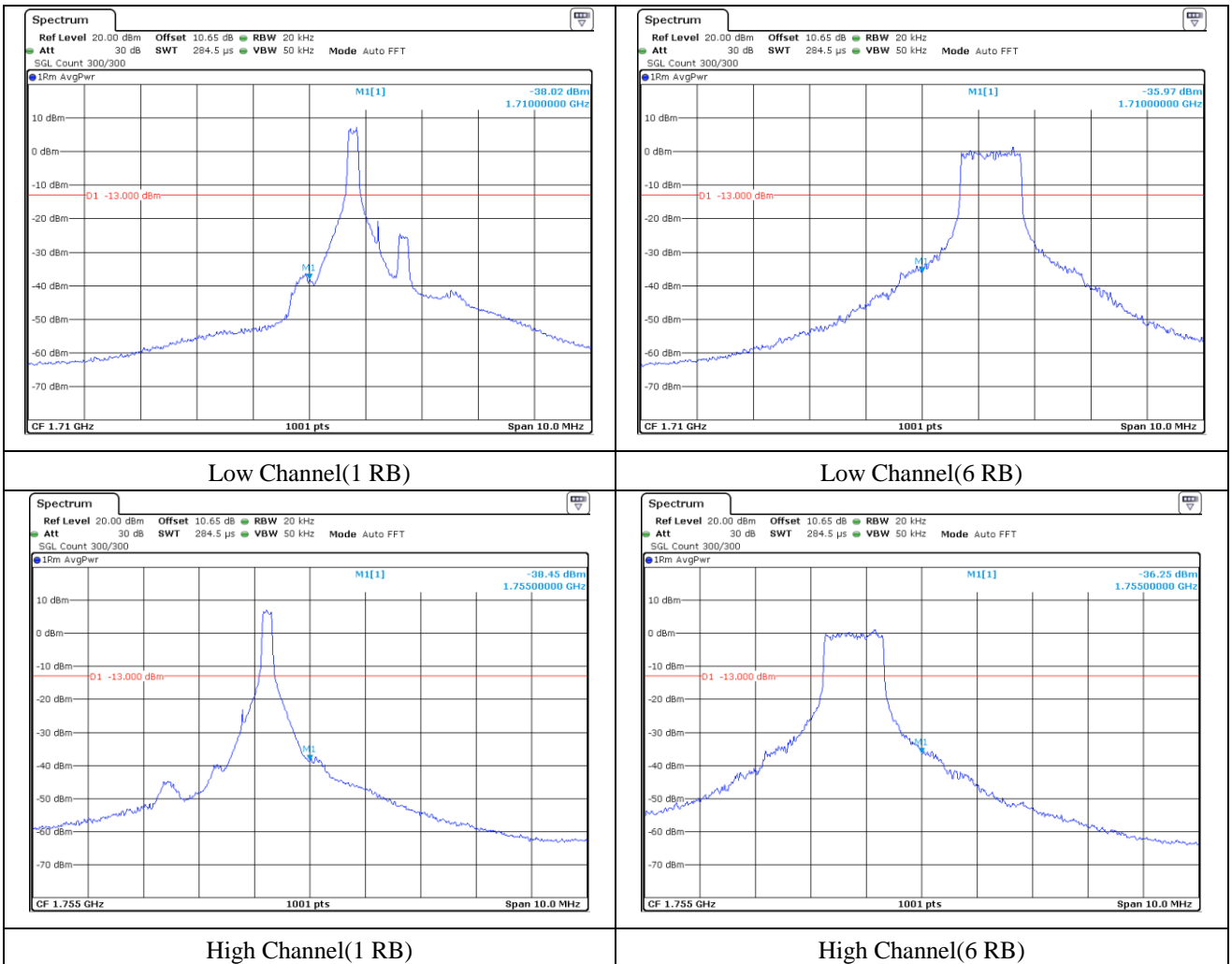

13.6.4 Test data for LTE Band 12

-. Test Date : February 13, 2019 ~ February 26, 2019

-. Test Result : Pass

LTE Band 12 QPSK

Test Mode	Channel	Edge Frequency (MHz)	MEASURED VLAUE (dBm)	Limit (dBm)	Result
1 RB	Low	699.0000	-43.93	-13.00	PASS
	High	716.0000	-42.09	-13.00	PASS
6 RB	Low	699.0000	-38.50	-13.00	PASS
	High	716.0000	-35.97	-13.00	PASS

LTE Band 12 16QAM

Test Mode	Channel	Edge Frequency (MHz)	MEASURED VLAUE (dBm)	Limit (dBm)	Result
1 RB	Low	699.0000	-45.02	-13.00	PASS
	High	716.0000	-46.72	-13.00	PASS
6 RB	Low	699.0000	-36.08	-13.00	PASS
	High	716.0000	-36.17	-13.00	PASS

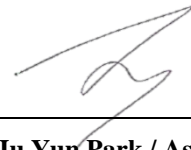

Tested by: Ju Yun Park / Assistant Manager

13.6.5 Test data for LTE Band 12 QPSK

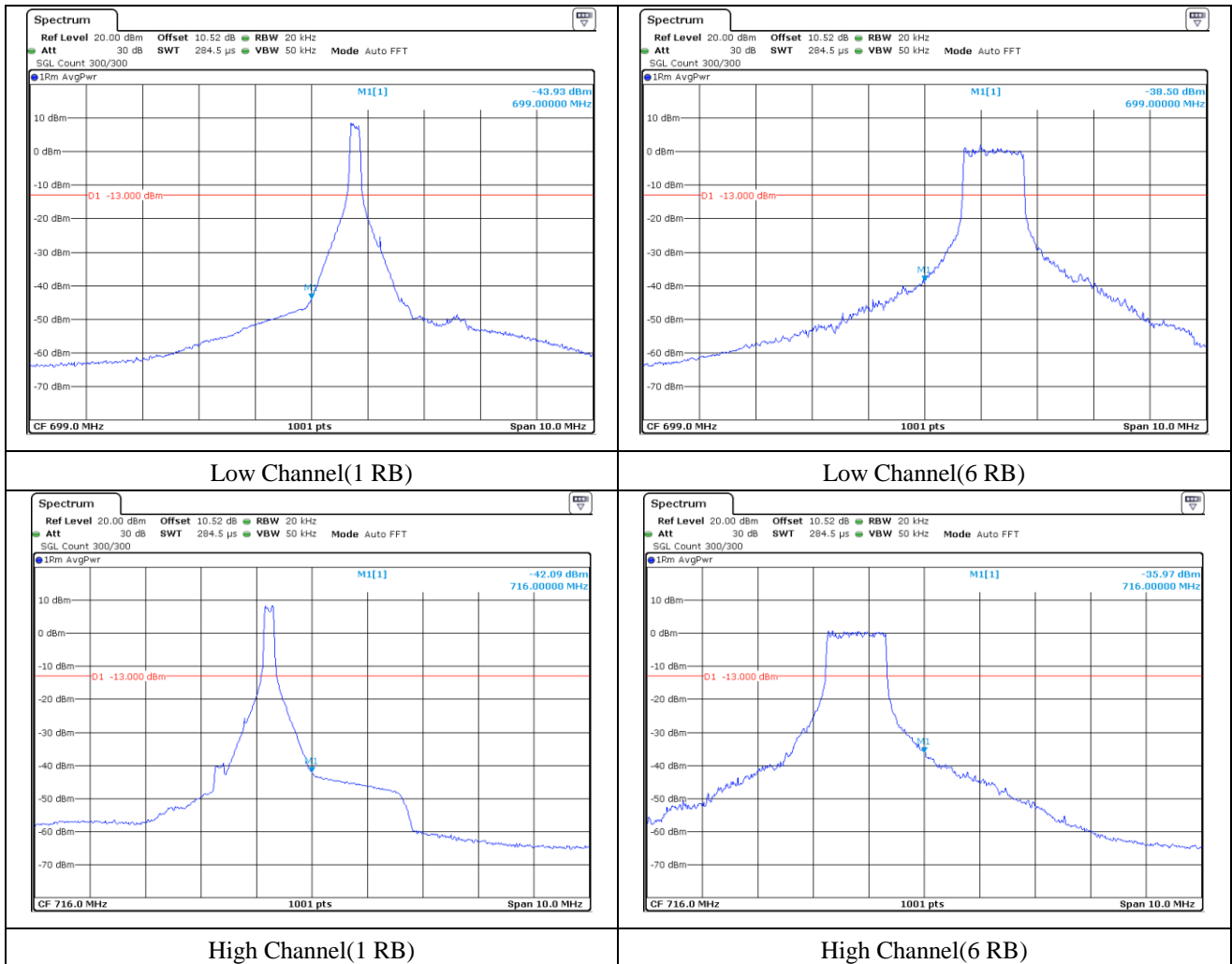

13.6.6 Test data for LTE Band 12 16QAM

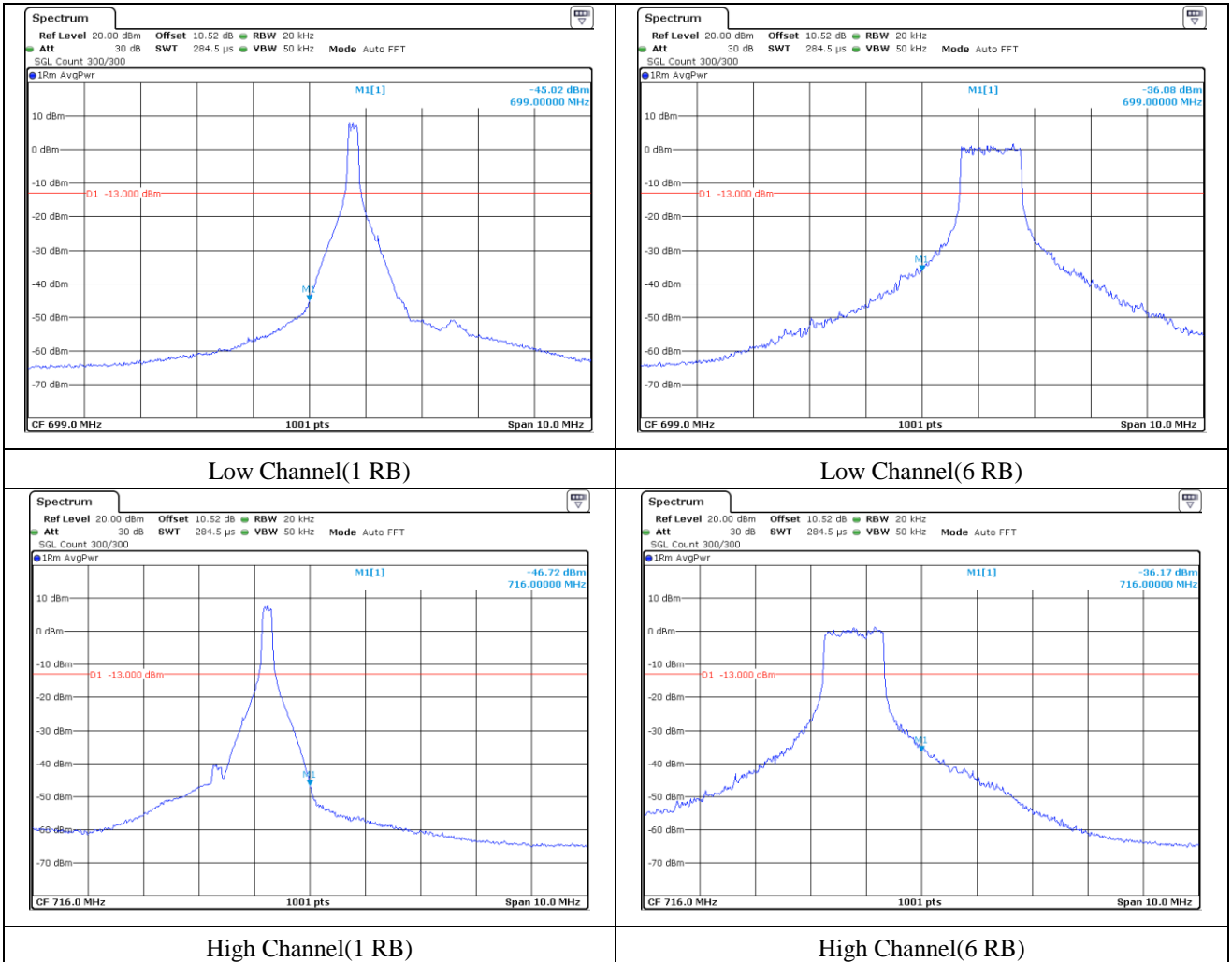

13.6.7 Test data for LTE Band 13

- Test Date : February 13, 2019 ~ February 26, 2019
 - Test Result : Pass

LTE Band 13 QPSK

Test Mode	Channel	Edge Frequency (MHz)	MEASURED VLAUE (dBm)	Limit (dBm)	Result
1 RB	Low	777.0000	-44.73	-13.00	PASS
	High	787.0000	-44.35	-13.00	PASS
6 RB	Low	777.0000	-38.89	-13.00	PASS
	High	787.0000	-36.93	-13.00	PASS

LTE Band 13 16QAM

Test Mode	Channel	Edge Frequency (MHz)	MEASURED VLAUE (dBm)	Limit (dBm)	Result
1 RB	Low	777.0000	-43.57	-13.00	PASS
	High	787.0000	-37.96	-13.00	PASS
6 RB	Low	777.0000	-38.28	-13.00	PASS
	High	787.0000	-37.25	-13.00	PASS

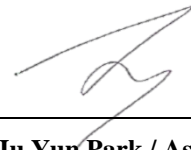

Tested by: Ju Yun Park / Assistant Manager

13.6.8 Test data for LTE Band 13 QPSK

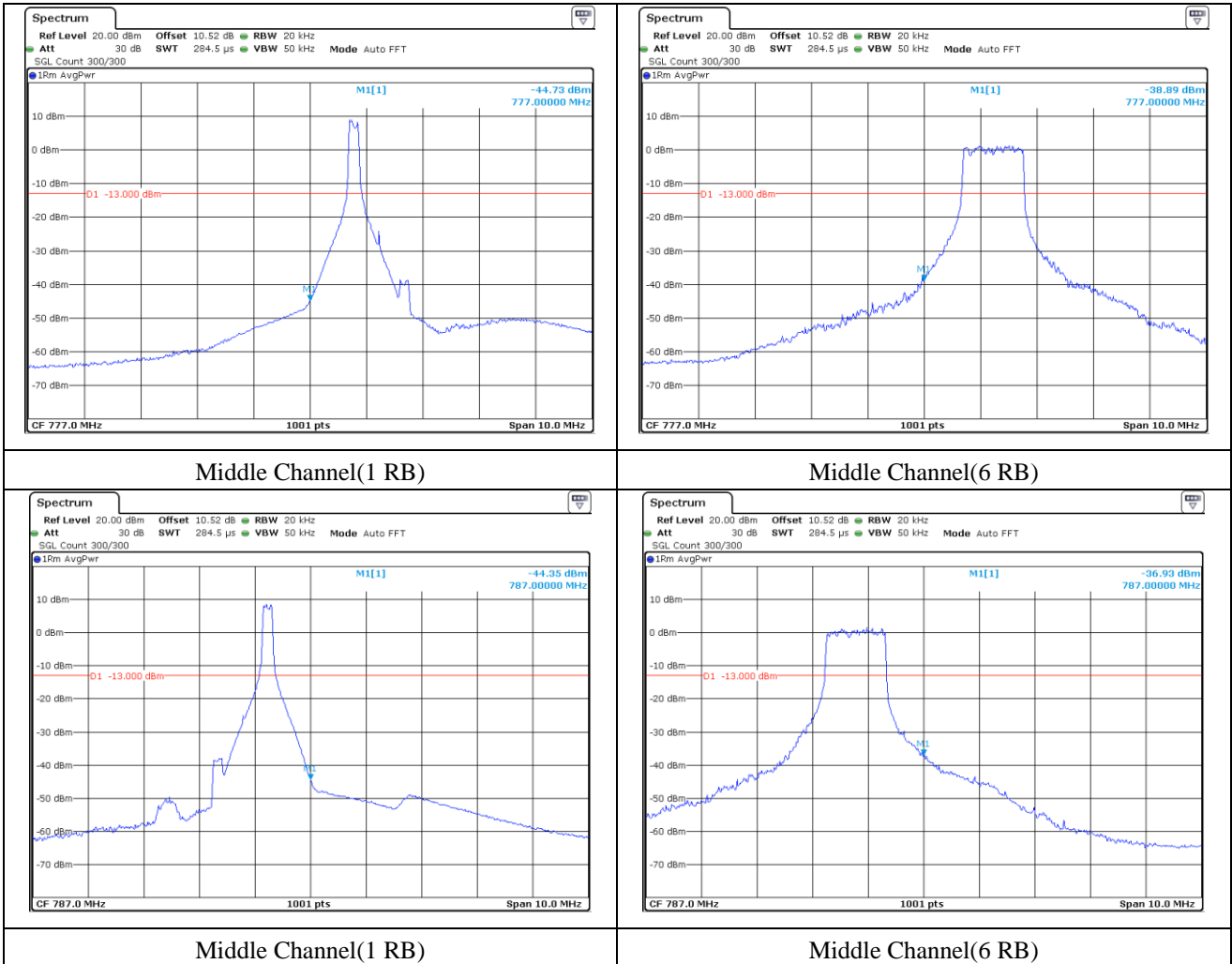

13.6.9 Test data for LTE Band 13 16QAM

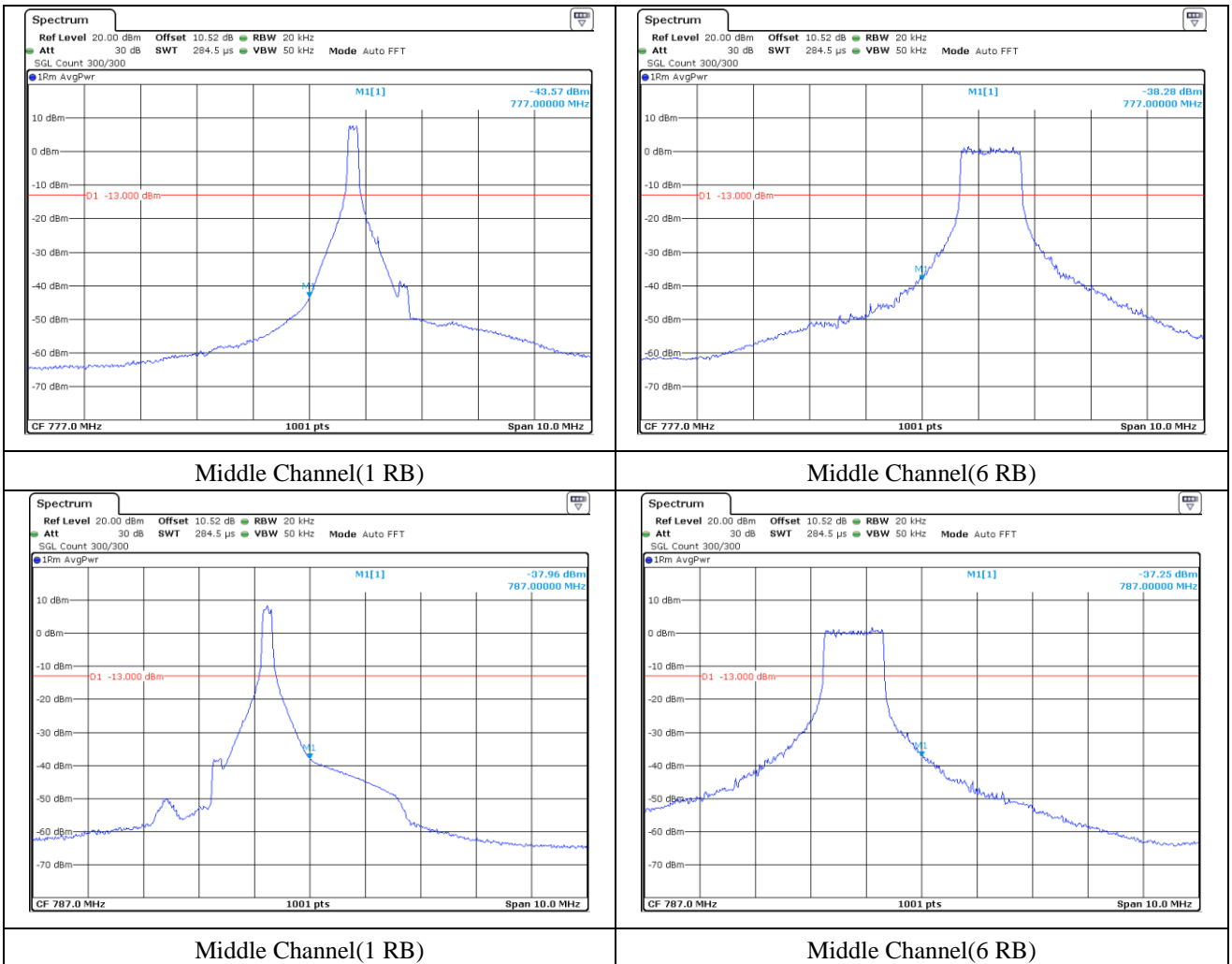

14. Conducted Spurious and Harmonic Emissions at Antenna Termianl

14.1 Operating environment

Temperature : 23 °C
 Relative humidity : 47 % R.H.

14.2 Test set-up

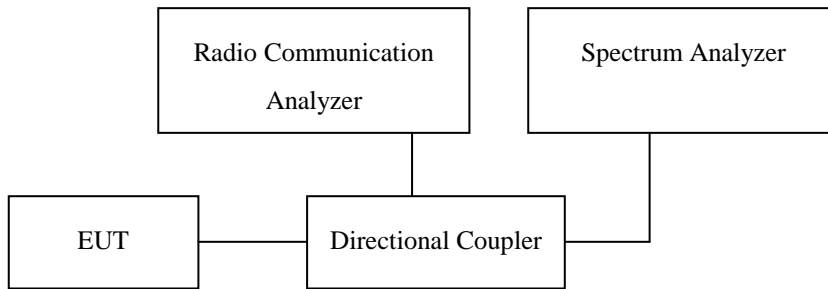

(Configuration of conducted Emission measurement)

Conducted Spurious Emissions is tested in accordance with KDB971168 D01 Power Meas License Digital Systems v04, April 9, 2018, Section 6.

The EUT makes a call to the communication simulator. The power was measured with R&S Spectrum Analyzer. All measurements were done at 3 channels(low, middle and high operational range.)

The Conducted Spurious Emissions used the power splitter via EUT RF power connector between simulation base station and spectrum analyzer.

The communication simulator station system controlled a EUT to export maximum output power under transmission mode and specific channel frequency.

Conducted spurious emissions

The EUT was setup to maximum output power. The 100 kHz RBW and 300 kHz VBW was used to scan from 30 MHz to 1 GHz. Also, the 1 MHz RBW and 3 MHz VBW was used to scan from 1 GHz to 20 GHz. The high, low and a middle channel were tested for out of band measurements.

14.3 Limits

LTE -4 Rule Part 27.53(h) specifies that “for operations in the 1695-1710 MHz, 1710-1755 MHz, 1755-1780 MHz, 1915-1920 MHz, 1995-2000 MHz, 2000-2020 MHz, 2110-2155 MHz, 2155-2180 MHz, and 2180-2200 bands, the power of any emission outside a licensee's frequency block shall be attenuated below the transmitter power (P) in watts by at least 43 + 10 log10 (P) dB.”

LTE -12 Rule Part 27.53 (g) For operations in the 600 MHz band and the 698-746 MHz band, the power of any emission outside a licensee's frequency band(s) of operation shall be attenuated below the transmitter power (P) within the licensed

band(s) of operation, measured in watts, by at least $43 + 10 \log (P)$ dB. Compliance with this provision is based on the use of measurement instrumentation employing a resolution bandwidth of 100 kilohertz or greater. However, in the 100 kilohertz bands immediately outside and adjacent to a licensee's frequency block, a resolution bandwidth of at least 30 kHz may be employed.

LTE -13 Rule Part 27.53(f) For operations in the 746-758 MHz, 775-788 MHz, and 805-806 MHz bands, emissions in the band 1559-1610 MHz shall be limited to -70 dBW/MHz equivalent isotropically radiated power (EIRP) for wideband signals, and -80 dBW EIRP for discrete emissions of less than 700 Hz bandwidth. For the purpose of equipment authorization, a transmitter shall be tested with an antenna that is representative of the type that will be used with the equipment in normal operation.

LTE Band 4 / 12 Limit

Limit	-13 dBm
-------	---------

LTE Band 13 Limit

Limit out of the band 1559-1610 MHz	-13 dBm
Limit in the band 1559-1610 MHz	-40 dBm

14.4 Test equipment used

	Model Number	Manufacturer	Description	Serial Number	Last Cal.
■ -	FSV30	Rohde & Schwarz	Signal Analyzer	101372	Aug. 23, 2018 (1Y)
■ -	AAMCS-UDC	AA-MCS	Directional Coupler	400	Aug. 23, 2018 (1Y)
■ -	MT8821C	ANRITSU	Radio Communication Analyzer	6261849029	Aug. 22, 2018 (1Y)
■ -	PWS-3003D	Protek	DC Power Supply	4020409	Aug. 24, 2018 (1Y)

All test equipment used is calibrated on a regular basis.

14.5 Test data

14.5.1 Test data for LTE Band 4 QPSK

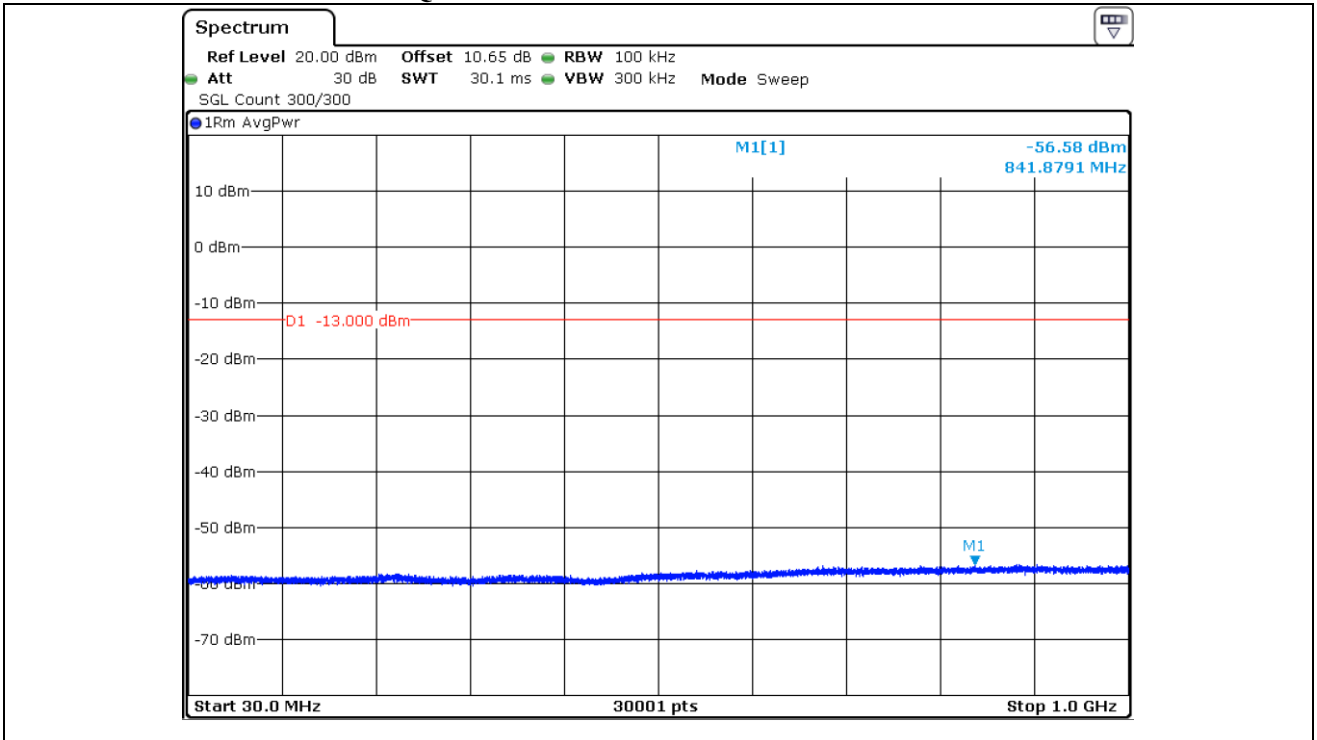

Low Channel

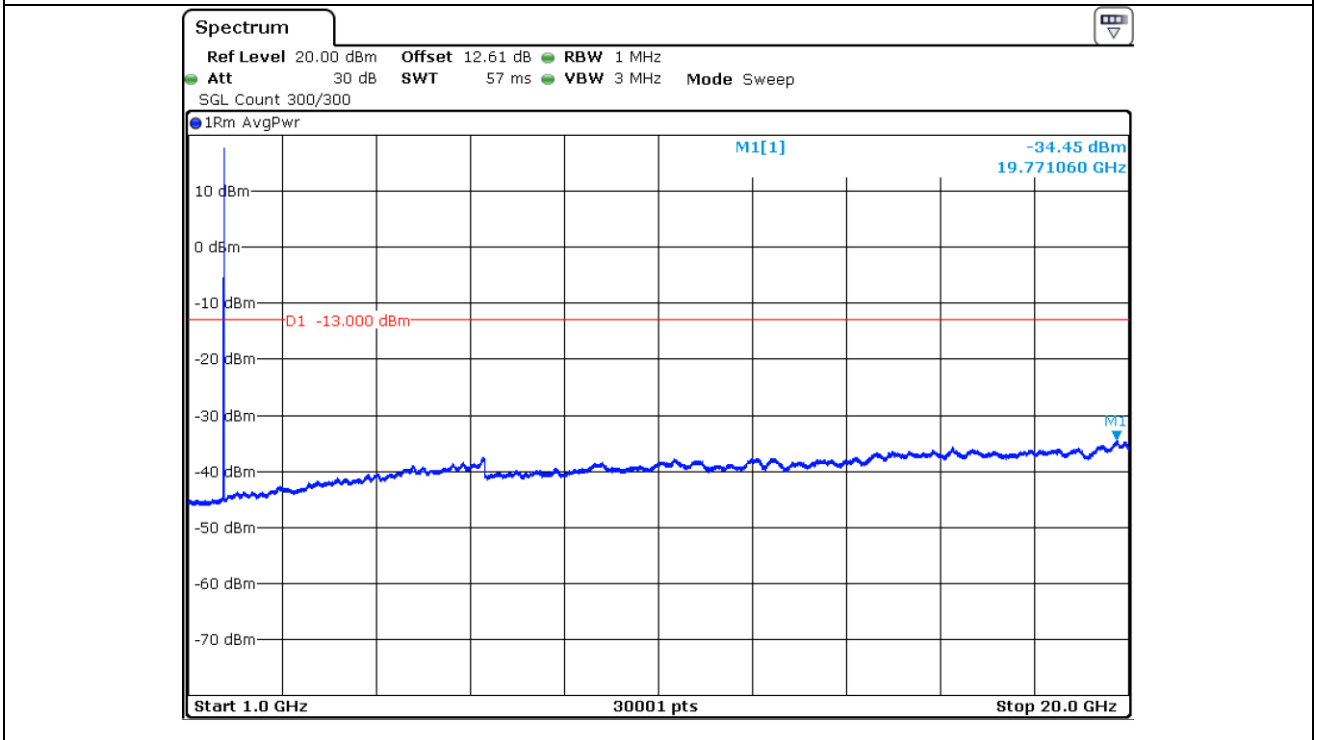

Low Channel

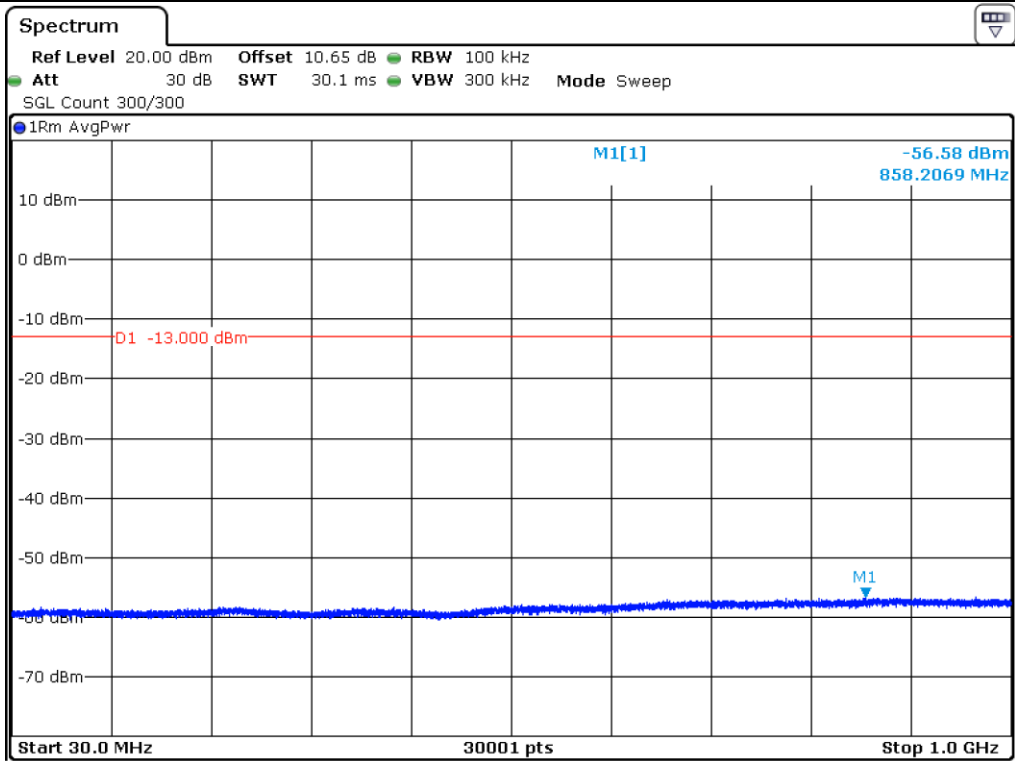

Midle Channel

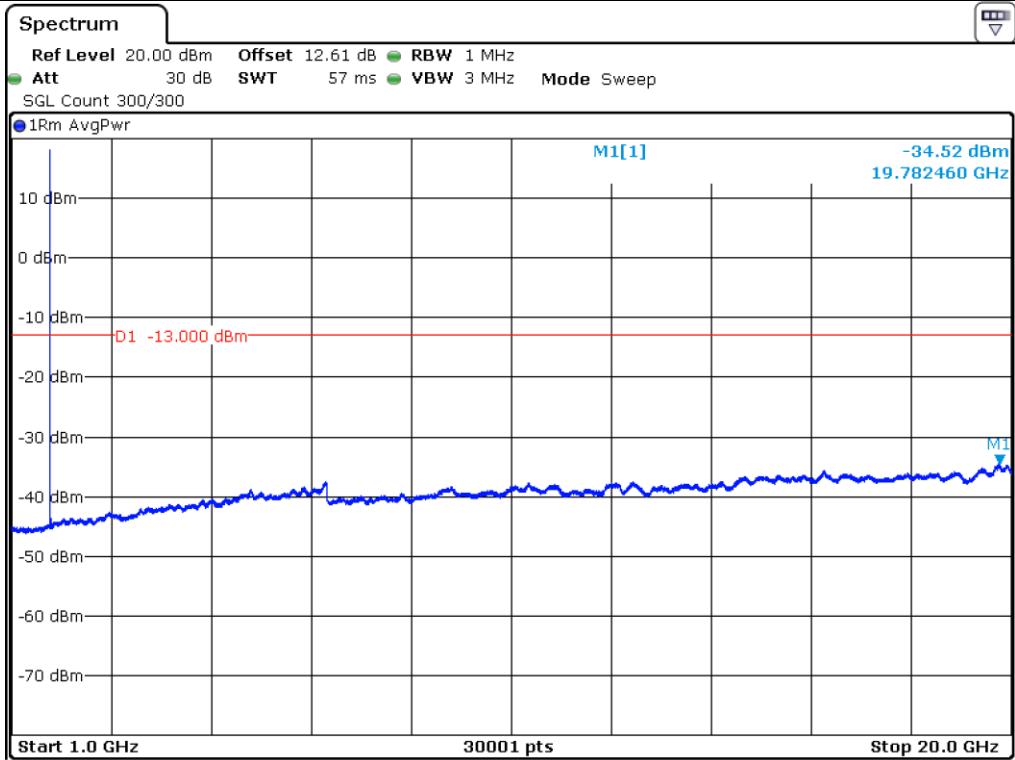

Midle Channel

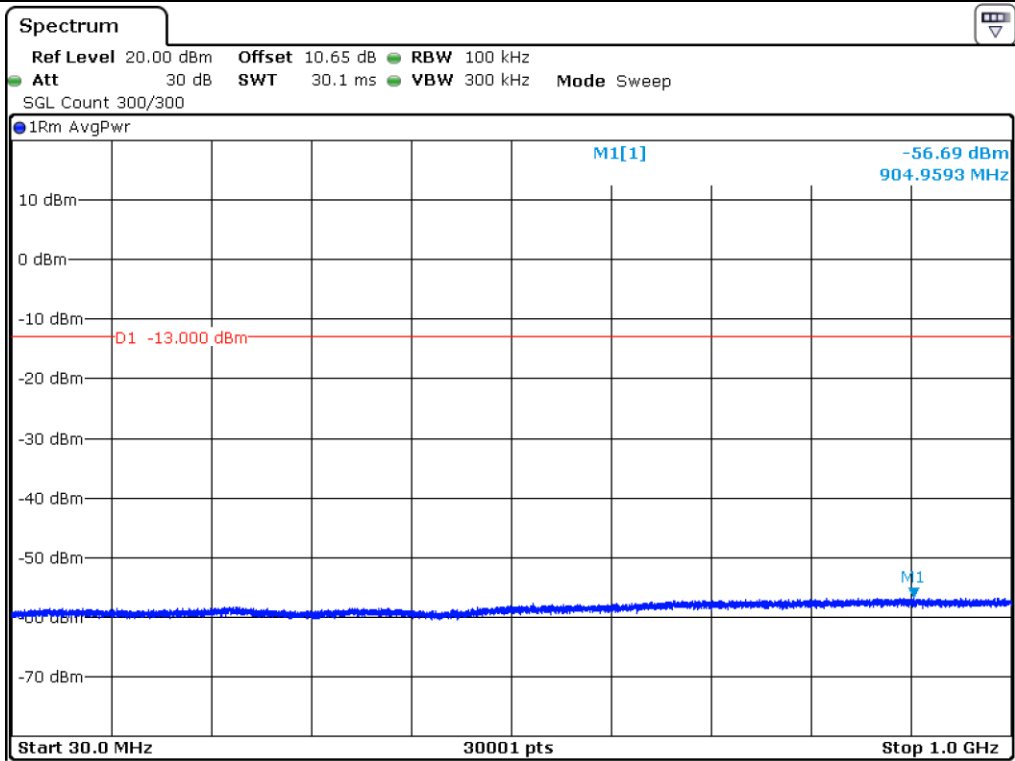

High Channel

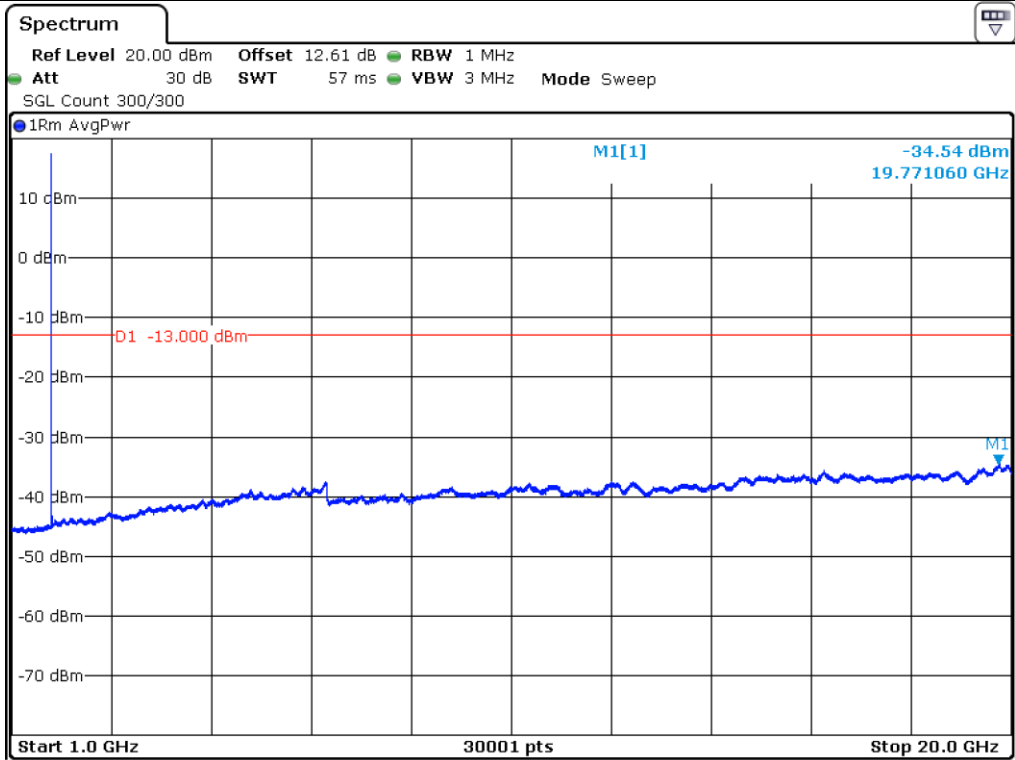

High Channel

14.5.2 Test data for LTE Band 4 16QAM

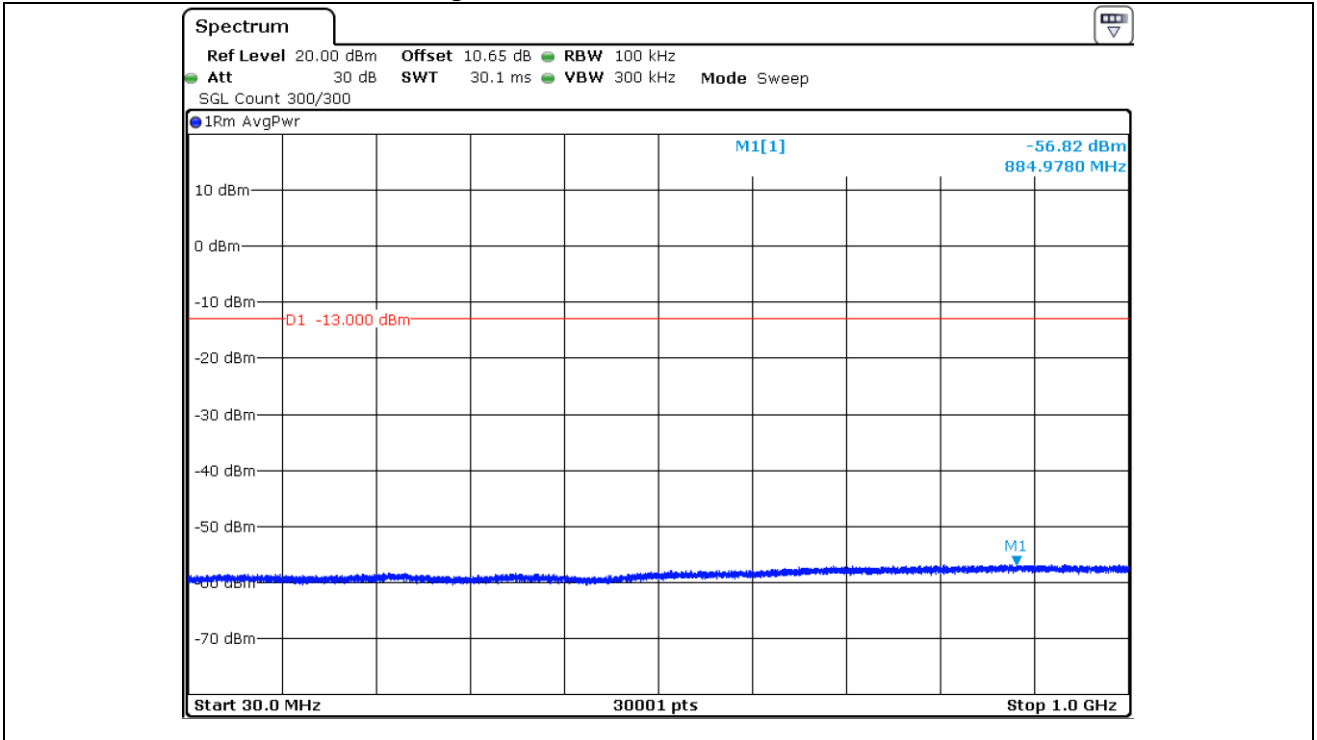

Low Channel

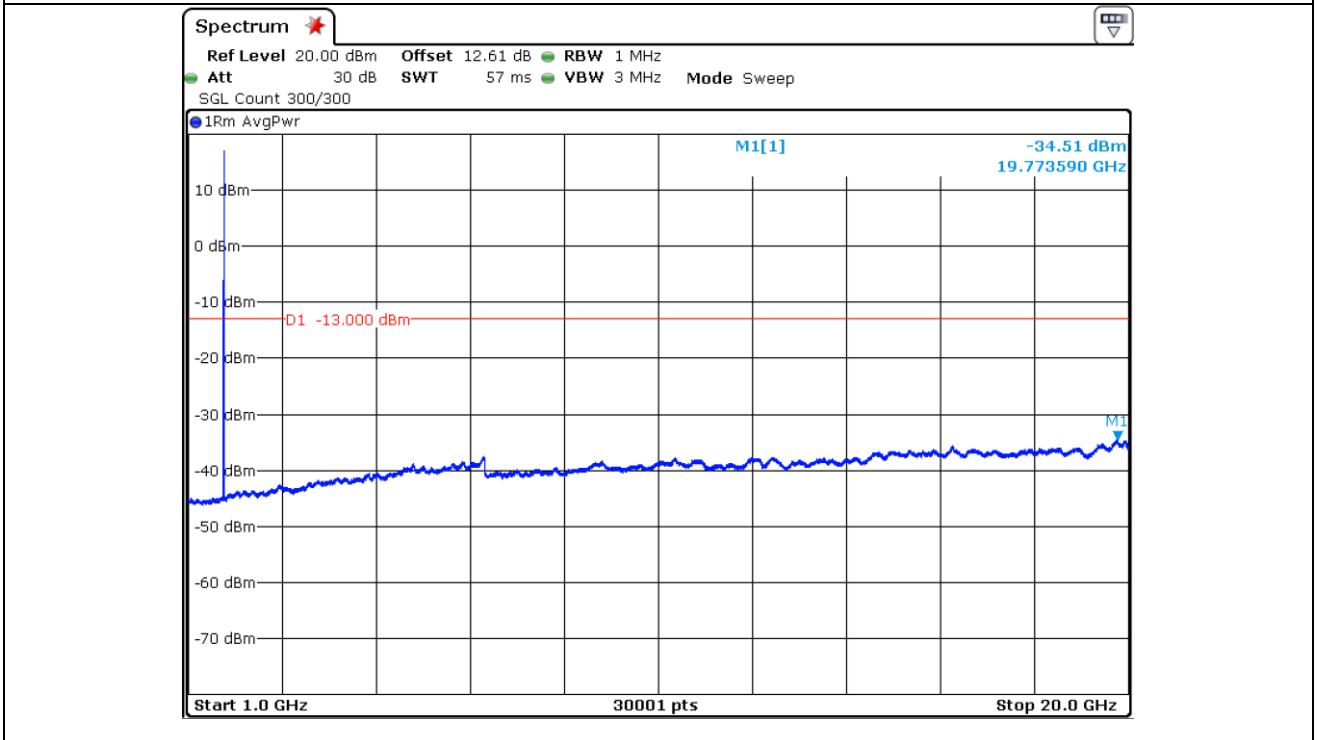

Low Channel

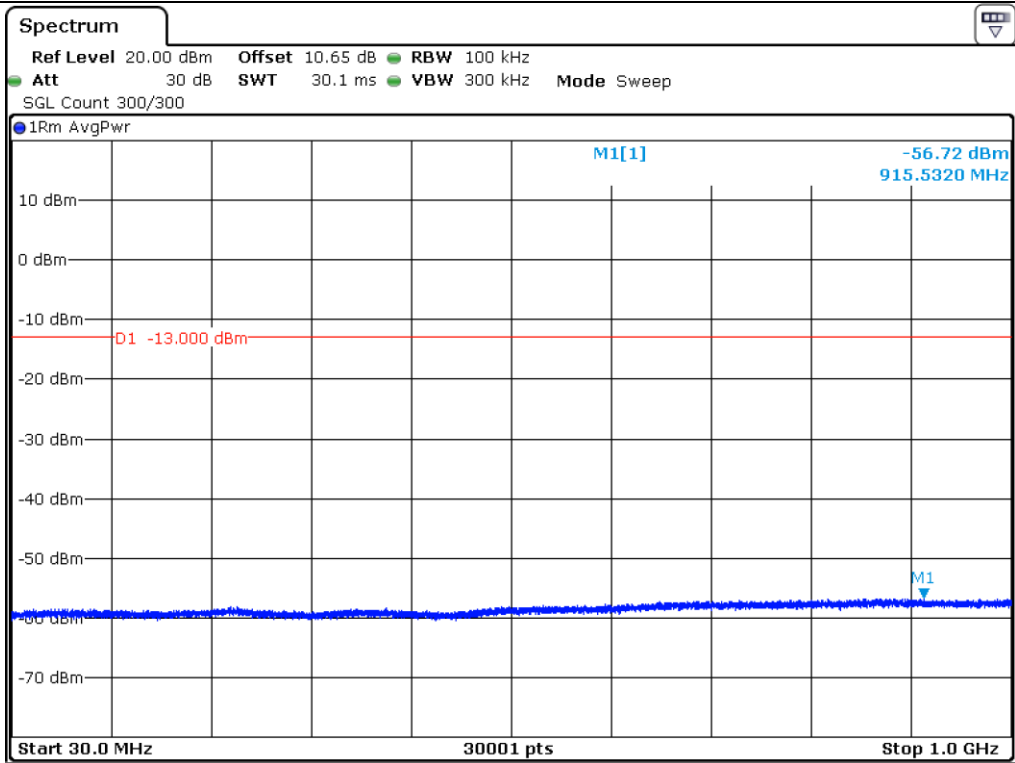

Midle Channel

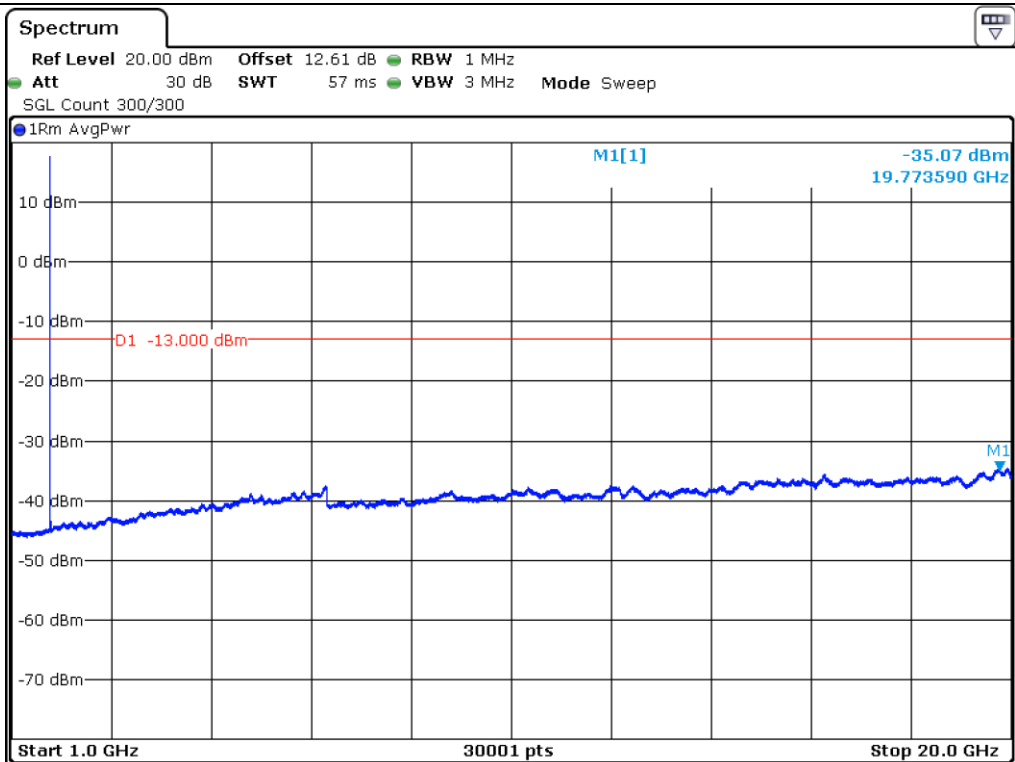

Midle Channel

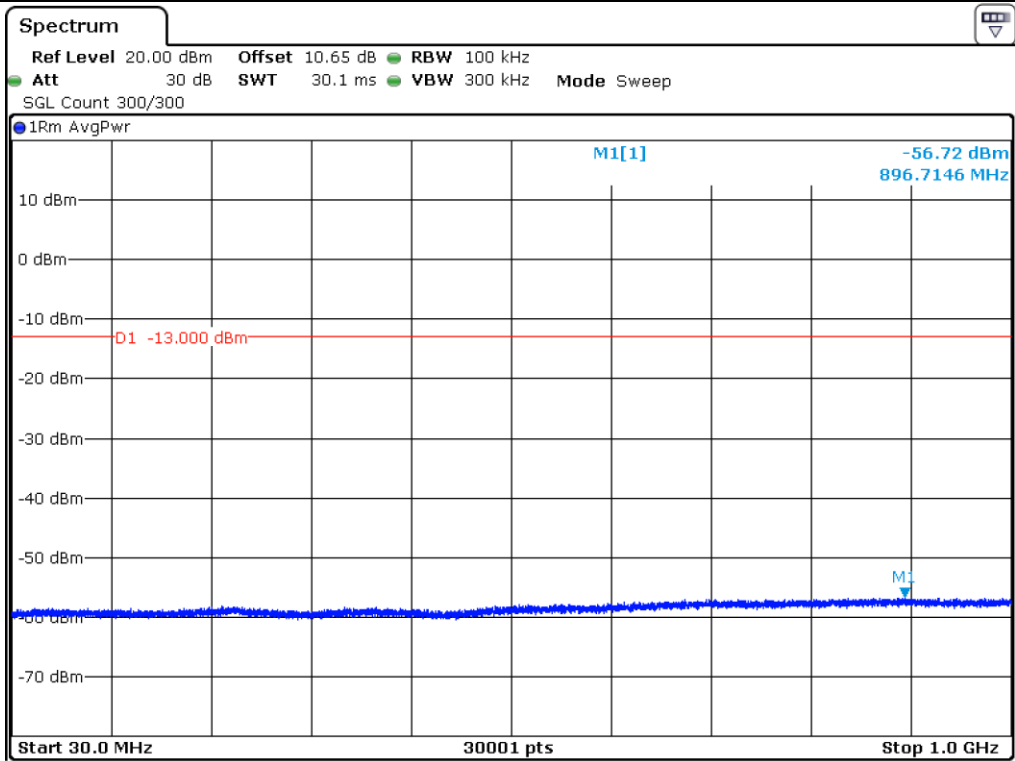

High Channel

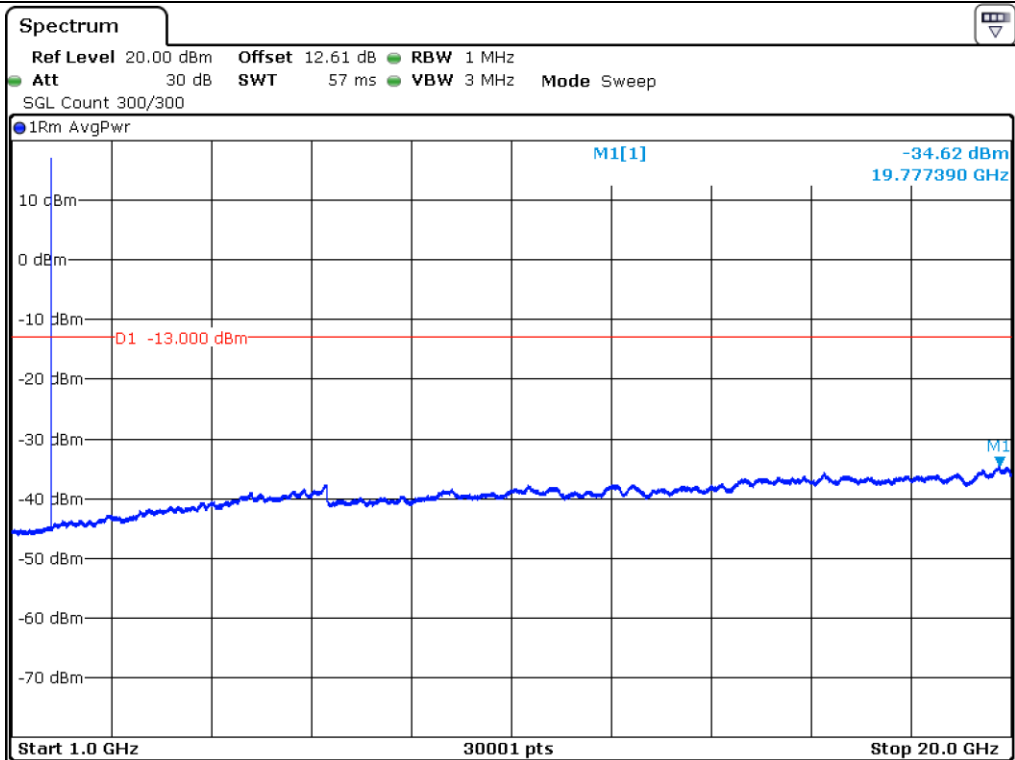

High Channel

14.5.3 Test data for LTE Band 12 QPSK

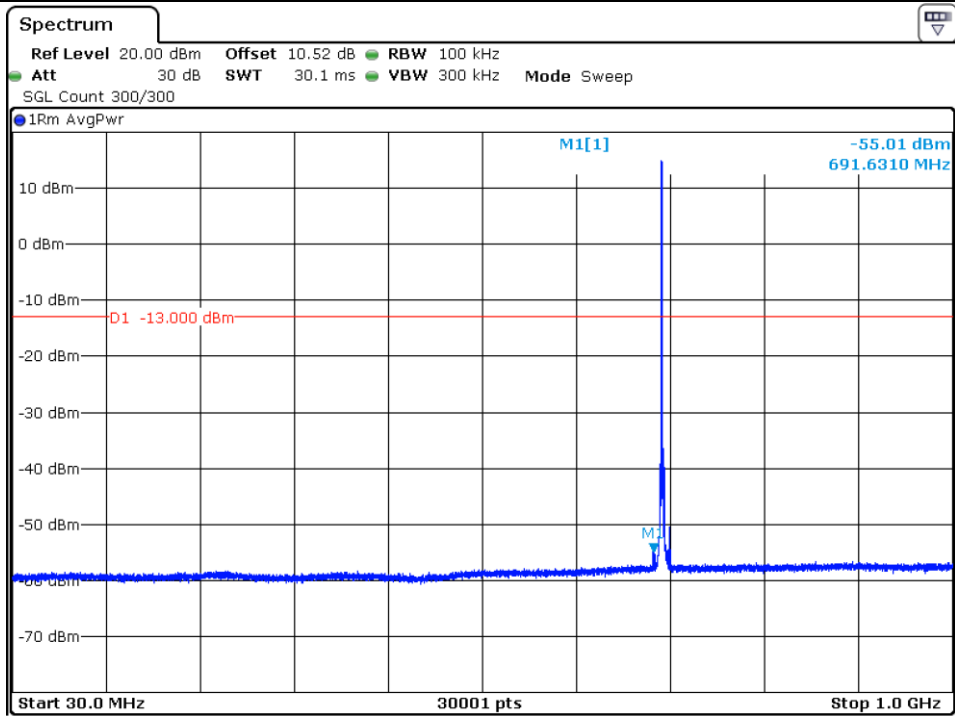

Low Channel

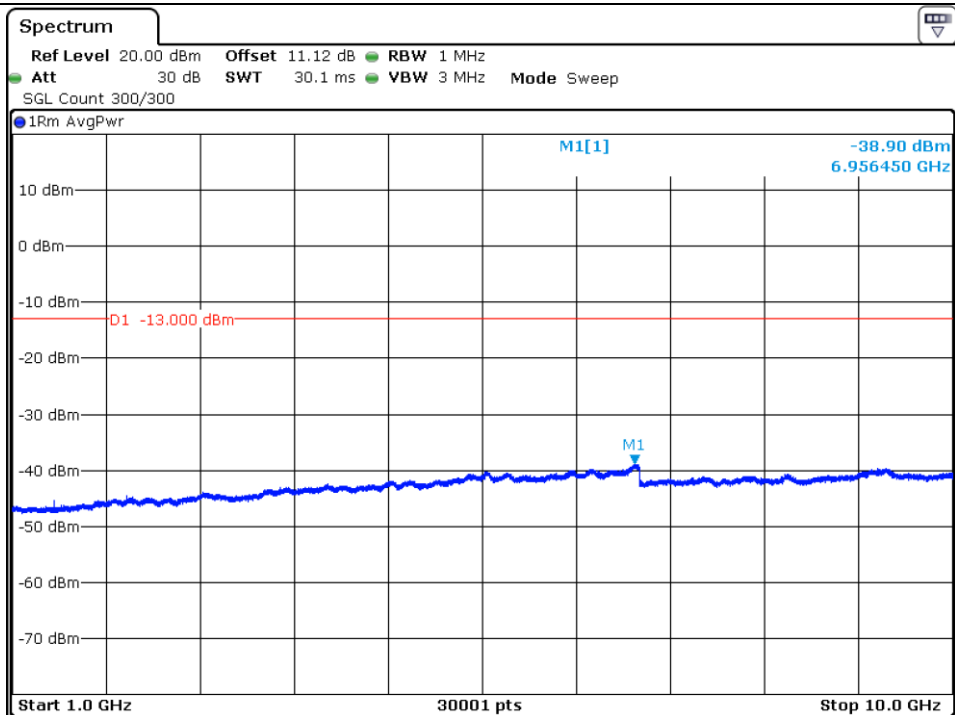

Low Channel

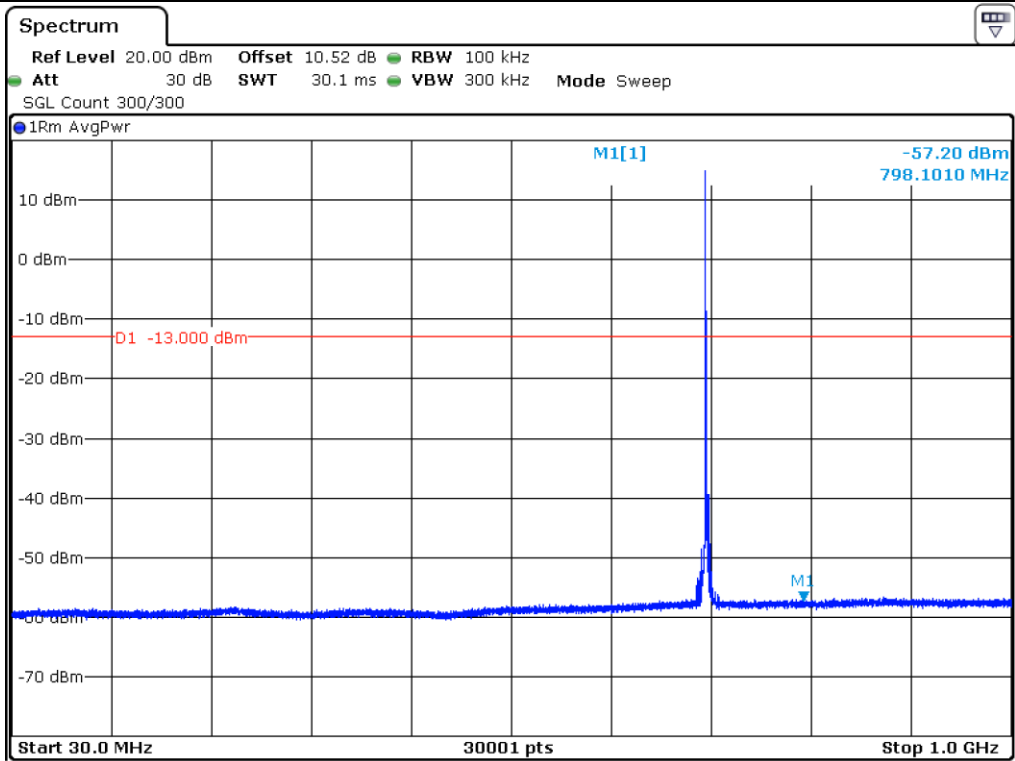

Midle Channel

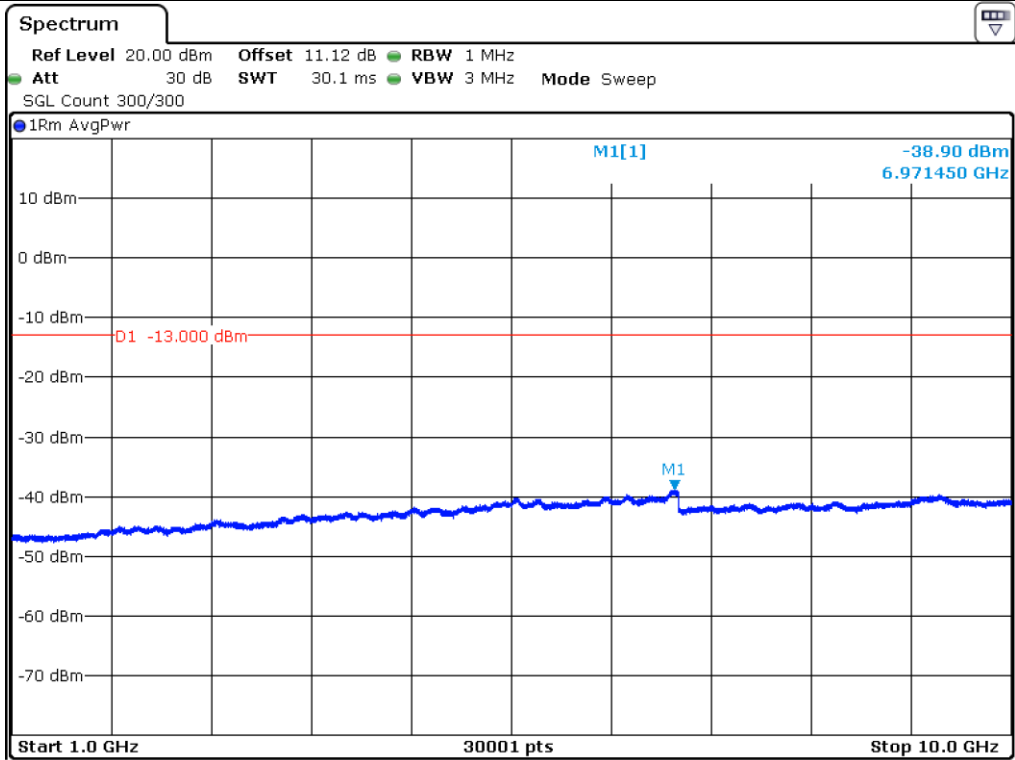

Midle Channel