

# ELECTROMAGNETIC EMISSION COMPLIANCE REPORT FOR LICENSED TRANSMITTER

**Test Report No.** : OT-190-RWD-034  
**AGR No.** : A198A-018  
**Applicant** : Suntech International Ltd.  
**Address** : A-1705, A-1706, Greatvally, 32, Digital-ro 9-gil, Geumcheon-Gu, Seoul, Korea  
**Manufacturer** : Suntech International Ltd.  
**Address** : A-1705, A-1706, Greatvally, 32, Digital-ro 9-gil, Geumcheon-Gu, Seoul, Korea  
**Type of Equipment** : Tracking Device  
**FCC ID.** : WA2ST4330  
**Model Name** : ST4330  
**Serial number** : N/A  
**Total page of Report** : 81 pages (including this page)  
**Date of Incoming** : September 23, 2019  
**Date of issue** : October 14, 2019

## SUMMARY

The equipment complies with the regulation; **Part 2, Part 27 Subpart C**

This test report only contains the result of a single test of the sample supplied for the examination.

It is not a generally valid assessment of the features of the respective products of the mass-production.

Reviewed by:   
 \_\_\_\_\_  
 Tae-Ho, Kim / Senior Manager  
 ONETECH Corp.

Approved by:   
 \_\_\_\_\_  
 Ki-Hong, Nam / Chief Engineer  
 ONETECH Corp.

## CONTENTS

	<b>PAGE</b>
<b>1. VERIFICATION OF COMPLIANCE .....</b>	<b>7</b>
<b>2. TEST SUMMARY .....</b>	<b>8</b>
<b>2.1 TEST ITEMS AND RESULTS .....</b>	<b>8</b>
<b>2.2 ADDITIONS, DEVIATIONS, EXCLUSIONS FROM STANDARDS .....</b>	<b>8</b>
<b>2.3 RELATED SUBMITTAL(S) / GRANT(S) .....</b>	<b>8</b>
<b>2.4 PURPOSE OF THE TEST .....</b>	<b>8</b>
<b>2.5 TEST METHODOLOGY .....</b>	<b>8</b>
<b>2.6 TEST FACILITY .....</b>	<b>8</b>
<b>3. GENERAL INFORMATION .....</b>	<b>9</b>
<b>3.1 PRODUCT DESCRIPTION .....</b>	<b>9</b>
<b>3.2 ALTERNATIVE TYPE(S)/MODEL(S); ALSO COVERED BY THIS TEST REPORT .....</b>	<b>9</b>
<b>4. EUT MODIFICATIONS .....</b>	<b>9</b>
<b>5. SYSTEM TEST CONFIGURATION .....</b>	<b>10</b>
<b>5.1 JUSTIFICATION .....</b>	<b>10</b>
<b>5.2 PERIPHERAL EQUIPMENT .....</b>	<b>10</b>
<b>5.3 MODE OF OPERATION DURING THE TEST .....</b>	<b>11</b>
<b>5.5 CONFIGURATION OF TEST SYSTEM .....</b>	<b>16</b>
<b>6. PRELIMINARY TEST .....</b>	<b>16</b>
<b>6.1 GENERAL RADIATED EMISSIONS TESTS .....</b>	<b>16</b>
<b>7. CONDUCTED OUTPUT POWER .....</b>	<b>17</b>
<b>7.1 OPERATING ENVIRONMENT .....</b>	<b>17</b>
<b>7.2 TEST SET-UP .....</b>	<b>17</b>
<b>7.3 TEST EQUIPMENT USED .....</b>	<b>17</b>
<b>7.4 TEST DATA .....</b>	<b>18</b>
<b>8. EQUIVALENT ISOTROPIC RADIATED POWER .....</b>	<b>20</b>
<b>8.1 OPERATING ENVIRONMENT .....</b>	<b>20</b>
<b>8.2 METHODS OF MEASUREMENT .....</b>	<b>20</b>
<b>8.3 LIMITS .....</b>	<b>20</b>
<b>8.4 TEST SET-UP .....</b>	<b>20</b>
<b>8.5 TEST EQUIPMENT USED .....</b>	<b>21</b>
<b>8.6 TEST DATA FOR LTE BAND 4 QPSK .....</b>	<b>22</b>

8.7 TEST DATA FOR LTE BAND 4 16QAM .....22

**9. EFFECTIVE RADIATED POWER .....23**

9.1 OPERATING ENVIRONMENT .....23

9.2 METHODS OF MEASUREMENT .....23

9.3 LIMITS .....23

9.4 TEST SET-UP .....23

9.5 TEST EQUIPMENT USED .....24

9.6 TEST DATA FOR LTE BAND 12 QPSK .....25

9.7 TEST DATA FOR LTE BAND 12 16QAM .....25

9.8 TEST DATA FOR LTE BAND 13 QPSK .....26

9.9 TEST DATA FOR LTE BAND 13 16QAM .....26

**10. RADIATED SPURIOUS EMISSIONS .....27**

10.1 OPERATING ENVIRONMENT .....27

10.2 TEST SET-UP .....27

10.3 TEST EQUIPMENT USED .....29

10.4 TEST DATA .....30

    10.4.1 Test data for LTE Band 4 QPSK .....30

    10.4.2 Test data for LTE Band 12 QPSK .....31

    10.4.2 Test data for LTE Band 13 QPSK .....32

**11. PEAK-TO-AVERAGE RATIO .....33**

11.1 OPERATING ENVIRONMENT .....33

11.2 TEST SET-UP .....33

11.3 TEST EQUIPMENT USED .....34

11.4 TEST DATA .....34

    11.4.1 Test data LTE Band 4 .....34

    11.4.2 Test data LTE Band 12 .....37

    11.4.3 Test data LTE Band 13 .....40

**12. OCCUPIED BANDWIDTH.....42**

12.1 OPERATING ENVIRONMENT .....42

12.2 TEST SET-UP .....42

12.3 TEST EQUIPMENT USED .....42

12.4 TEST DATA .....43

    12.4.1 Test data for LTE Band 4 .....43

    12.4.2 Test data for LTE Band 12 .....46

    12.4.3 Test data for LTE Band 13 .....49

**13. CONDUCTED BAND EDGE .....51**

**13.1 OPERATING ENVIRONMENT .....51**

**13.2 TEST SET-UP .....51**

**13.3 METHODS OF MEASUREMENT .....51**

**13.4 LIMITS .....52**

**13.5 TEST EQUIPMENT USED .....52**

**13.6 TEST DATA .....53**

*13.6.1 Test data for LTE Band 4 .....53*

*13.6.2 Test data for LTE Band 4 QPSK .....54*

*13.6.3 Test data for LTE Band 4 16QAM .....55*

*13.6.4 Test data for LTE Band 12 .....56*

*13.6.5 Test data for LTE Band 12 QPSK .....57*

*13.6.6 Test data for LTE Band 12 16QAM .....58*

*13.6.7 Test data for LTE Band 13 .....59*

*13.6.8 Test data for LTE Band 13 QPSK .....60*

*13.6.9 Test data for LTE Band 13 16QAM .....61*

**14. CONDUCTED SPURIOUS AND HARMONIC EMISSIONS AT ANTENNA TERMINAL .....62**

**14.1 OPERATING ENVIRONMENT .....62**

**14.2 TEST SET-UP .....62**

**14.3 LIMITS .....63**

**14.4 TEST EQUIPMENT USED .....63**

**14.5 TEST DATA .....64**

*14.5.1 Test data for LTE Band 4 QPSK .....64*

*14.5.2 Test data for LTE Band 4 16QAM .....67*

*14.5.3 Test data for LTE Band 12 QPSK .....70*

*14.5.4 Test data for LTE Band 12 16QAM .....73*

*14.5.5 Test data for LTE Band 13 QPSK .....76*

*14.5.6 Test data for LTE Band 13 16QAM .....77*

**15. FREQUENCY STABILITY / VARIATION OF AMBIENT TEMPERATURE .....78**

**15.1 OPERATING ENVIRONMENT .....78**

**15.2 TEST SET-UP .....78**

**15.3 TEST EQUIPMENT USED .....78**

**15.4 TEST DATA .....79**

*15.4.1 Test data for Voltage(V) \_LTE Band 4 .....79*

*15.4.2 Test data for Temperature(°C) \_LTE Band 4 .....79*

*15.4.3 Test data for Voltage(V) \_LTE Band 12 .....80*

*15.4.4 Test data for Temperature(°C) \_LTE Band 12 .....80*

*15.4.5 Test data for Voltage(V) \_LTE Band 13 .....81*

*15.4.6 Test data for Temperature(°C) \_LTE Band 13 .....81*

**Revision History**

Rev. No.	Issue Report No.	Issued Date	Revisions	Section Affected
0	OT-19O-RWD-034	October 14, 2019	Initial Release	All

## 1. VERIFICATION OF COMPLIANCE

Applicant : Suntech International Ltd.  
 Address : A-1705, A-1706, Greatvally, 32, Digital-ro 9-gil, Geumcheon-Gu, Seoul, Korea  
 Contact Person : Yohan, Kim / Manager  
 Telephone No. : 82-2-6327-5661  
 FCC ID : WA2ST4330  
 Model Name : ST4330  
 Serial Number : N/A  
 Date : October 14, 2019

EQUIPMENT CLASS	PCB-PCS Licensed Transmitter
EQUIPMENT DESCRIPTION	Tracking Device
THIS REPORT CONCERNS	Original Grant
MEASUREMENT PROCEDURES	ANSI C63.26:2015, KDB Publication 971168 D01
TYPE OF EQUIPMENT TESTED	Pre-Production
KIND OF EQUIPMENT AUTHORIZATION REQUESTED	Certification
EQUIPMENT WILL BE OPERATED UNDER FCC RULES PART(S)	FCC Part 2, Part 27 Subpart C
Modifications on the Equipment to Achieve Compliance	None
Final Test was Conducted On	3 m Semi Anechoic Chamber

-. The above equipment was tested by ONETECH Corp. for compliance with the requirement set forth in the FCC Rules and Regulations. This said equipment in the configuration described in this report, shows the maximum emission levels emanating from equipment are within the compliance requirements.

## 2. TEST SUMMARY

### 2.1 Test items and results

SECTION	TEST ITEMS	RESULTS
2.1049	Occupied Bandwidth	Met the Limit / PASS
2.1051, 27.53(g), 27.53(f), 27.53(h)	Band Edge / Spurious and Harmonic Emissions at Antenna Terminal	Met the Limit / PASS
2.1046	Conducted Output Power	Met the Limit / PASS
27.50(d)(5), KDB Publication 971168 D01	Peak-to-Average Ratio	Met the Limit / PASS
2.1055, 27.54	Frequency stability	Met the Limit / PASS
27.50(d)(4)	Equivalent Isotropic Radiated Power	Met the Limit / PASS
27.50(b)(10), 27.50(c)(10)	EFFECTIVE RADIATED POWER	Met the Limit / PASS
2.1053, 27.53(g), 27.53(f), 27.53(h)	Radiated Spurious and Harmonic Emissions	Met the Limit / PASS

### 2.2 Additions, deviations, exclusions from standards

No additions, deviations or exclusions have been made from standard.

### 2.3 Related Submittal(s) / Grant(s)

Original submittal only

### 2.4 Purpose of the test

To determine whether the equipment under test fulfills the requirements of the regulation stated in Part 27 Subpart C.

### 2.5 Test Methodology

Both conducted and radiated testing was performed according to the procedures in ANSI C63.26:2015. Radiated testing was performed at a distance of 3 m from EUT to the antenna.

### 2.6 Test Facility

The Onetech Corp. has been designated to perform equipment testing in compliance with ISO/IEC 17025.

The Electromagnetic compatibility measurement facilities are located at 43-14, Jinsaegol-gil, Chowol-eup, Gwangju-si, Gyeonggi-do, 12735, Korea

-. Site Filing:

VCCI (Voluntary Control Council for Interference) – Registration No. R-4112/ C-14617/ G-10666 / T-1842

IC (Industry Canada) – Registration No. Site# 3736A-3

-. Site Accreditation:

KOLAS (Korea Laboratory Accreditation Scheme) - Accreditation NO. KT085

FCC (Federal Communications Commission) - Accreditation No. KR0013

RRA (Radio Research Agency) – Designation No. KR0013

It should not be reproduced except in full, without the written approval of ONETECH Corp.

EMC-003 (Rev.2)

ONETECH Corp.: 43-14, Jinsaegol-gil, Chowol-eup, Gwangju-si, Gyeonggi-do, 12735, Korea (TEL: 82-31-799-9500, FAX: 82-31-799-9599)



### 3. GENERAL INFORMATION

#### 3.1 Product Description

The Suntech International Ltd., Model ST4330 (referred to as the EUT in this report) is a Tracking Device. Product specification information described herein was obtained from product data sheet or user’s manual.

DEVICE TYPE	Tracking Device			
OPERATING FREQUENCY	LTE Band 2	TX	1 855 MHz ~ 1 905 MHz	
		RX	1 935 MHz ~ 1 985 MHz	
	LTE Band 4	TX	1 715 MHz ~ 1 750 MHz	
		RX	2 115 MHz ~ 2 150 MHz	
	LTE Band 5	TX	829 MHz ~ 844 MHz	
		RX	874 MHz ~ 889 MHz	
	LTE Band 12	TX	704 MHz ~ 711 MHz	
		RX	734 MHz ~ 741 MHz	
	LTE Band 13	TX	782 MHz	
		RX	751 MHz	
	LTE Channel Bandwidth	10 MHz		
	Modulation Type	QPSK, 16QAM		
Maximum EIRP Power	LTE Band 4	21.46 dBm		
Maximum ERP Power	LTE Band 12	21.23 dBm		
	LTE Band 13	21.29 dBm		
ANTENNA TYPE	PIFA Antenna			
ANTENNA GAIN	LTE Band 2	1.50 dBi		
	LTE Band 4	1.47 dBi		
	LTE Band 5	1.01 dBi		
	LTE Band 12	-0.84 dBi		
	LTE Band 13	0.52 dBi		
List of each Osc. or crystal Freq.(Freq. >= 1 MHz)	26 MHz			

#### 3.2 Alternative type(s)/model(s); also covered by this test report.

-. None

### 4. EUT MODIFICATIONS

-. None

## 5. SYSTEM TEST CONFIGURATION

### 5.1 Justification

This device was configured for testing in a typical way as a normal customer is supposed to be used. During the test, the following components were installed inside of the EUT.

DEVICE TYPE	MANUFACTURER	MODEL/PART NUMBER	FCC ID
Main Board	N/A	N/A	N/A
Battery	N/A	N/A	N/A
Antenna	N/A	N/A	N/A

### 5.2 Peripheral equipment

Defined as equipment needed for correct operation of the EUT, but not considered as tested:

Model	Manufacturer	Description	Connected to
ST4330	Suntech International Ltd.	Tracking Device	-
GP-4303D	LG Precision Co.,Ltd	DC Power Supply	EUT

### 5.3 Mode of operation during the test

Pre-Scan has been conducted to determine the worst-case mode from all possible combinations between available modulations, data rates, XYZ axis, and antenna ports. The worst case was found when positioned as the table below.

Following channel(s) was (were) selected for the final test as listed below:

Band	EIRP	Radiated Emission
LTE Band 4	X-plane	X-axis
LTE Band 12	X-plane	X-axis
LTE Band 13	X-plane	X-axis

#### Test Mode : LTE Band 4

Test Item	Channel Bandwidth	Modulation	Mode	Test Channel
Conducted Output Power	10 MHz	QPSK, 16QAM	1 RB / 0 RB Offset / 0 RB Index	1 715 MHz 1 732.5 MHz 1 750 MHz
			1 RB / 5 RB Offset / 0 RB Index	
			1 RB / 0 RB Offset / 3 RB Index	
			1 RB / 5 RB Offset / 3 RB Index	
			1 RB / 0 RB Offset / 7 RB Index	
			1 RB / 5 RB Offset / 7 RB Index	
			3 RB / 0 RB Offset / 0 RB Index	
			3 RB / 3 RB Offset / 7 RB Index	
			6 RB / 0 RB Offset / 0 RB Index	
			6 RB / 0 RB Offset / 7 RB Index	
Equivalent Isotropic Radiated Power	10 MHz	QPSK, 16QAM	1 RB / 0 RB Offset / 0 RB Index	1 715 MHz
				1 732.5 MHz
				1 750 MHz
Frequency stability	10 MHz	QPSK	1 RB / 0 RB Offset / 0 RB Index	1 732.5 MHz

Test Item	Channel Bandwidth	Modulation	Mode	Test Channel			
Occupied Bandwidth	10 MHz	QPSK, 16QAM	6 RB / 0 RB Offset / 0 RB Index	1 715 MHz			
				1 732.5 MHz			
				1 750 MHz			
Peak-to-Average Ratio	10 MHz	QPSK, 16QAM	1 RB / 0 RB Offset / 0 RB Index 6 RB / 0 RB Offset / 0 RB Index	1 715 MHz			
				1 732.5 MHz			
				1 750 MHz			
Band Edge	10 MHz	QPSK, 16QAM	1 RB / 0 RB Offset / 0 RB Index 6 RB / 0 RB Offset / 0 RB Index	1 715 MHz			
				1 RB / 5 RB Offset / 0 RB Index 6 RB / 5 RB Offset / 0 RB Index	1 750 MHz		
			Spurious and Harmonic Emissions at Antenna Terminal		10 MHz	QPSK, 16QAM	1 RB / 0 RB Offset / 0 RB Index
				1 732.5 MHz			
1 750 MHz							
Radiated Spurious and Harmonic Emissions	10 MHz	QPSK, 16QAM	1 RB / 0 RB Offset / 0 RB Index	1 715 MHz			
				1 732.5 MHz			
				1 750 MHz			

**Test Mode : LTE Band 12**

Test Item	Channel Bandwidth	Modulation	Mode	Test Channel
Conducted Output Power	10 MHz	QPSK, 16QAM	1 RB / 0 RB Offset / 0 RB Index	704 MHz 707.5 MHz 711 MHz
			1 RB / 5 RB Offset / 0 RB Index	
			1 RB / 0 RB Offset / 3 RB Index	
			1 RB / 5 RB Offset / 3 RB Index	
			1 RB / 0 RB Offset / 7 RB Index	
			1 RB / 5 RB Offset / 7 RB Index	
			3 RB / 0 RB Offset / 0 RB Index	
			3 RB / 3 RB Offset / 7 RB Index	
			6 RB / 0 RB Offset / 0 RB Index	
			6 RB / 0 RB Offset / 7 RB Index	
Equivalent Isotropic Radiated Power	10 MHz	QPSK, 16QAM	1 RB / 0 RB Offset / 0 RB Index	704 MHz
				707.5 MHz
				711 MHz
Frequency stability	10 MHz	QPSK	1 RB / 0 RB Offset / 0 RB Index	707.5 MHz
Peak-to-Average Ratio	10 MHz	QPSK, 16QAM	1 RB / 0 RB Offset / 0 RB Index 6 RB / 0 RB Offset / 0 RB Index	704 MHz
				707.5 MHz
				711 MHz
Band Edge	10 MHz	QPSK, 16QAM	1 RB / 0 RB Offset / 0 RB Index	704 MHz
			6 RB / 0 RB Offset / 0 RB Index	
			1 RB / 5 RB Offset / 0 RB Index	711 MHz
			6 RB / 5 RB Offset / 0 RB Index	

Test Item	Channel Bandwidth	Modulation	Mode	Test Channel
Occupied Bandwidth	10 MHz	QPSK, 16QAM	6 RB / 0 RB Offset / 0 RB Index	704 MHz
				707.5 MHz
				711 MHz
Spurious and Harmonic Emissions at Antenna Terminal	10 MHz	QPSK, 16QAM	1 RB / 0 RB Offset / 0 RB Index	704 MHz
				707.5 MHz
				711 MHz
Radiated Spurious and Harmonic Emissions	10 MHz	QPSK, 16QAM	1 RB / 0 RB Offset / 0 RB Index	704 MHz
				707.5 MHz
				711 MHz

**Test Mode : LTE Band 13**

Test Item	Channel Bandwidth	Modulation	Mode	Test Channel
Conducted Output Power	10 MHz	QPSK, 16QAM	1 RB / 0 RB Offset / 0 RB Index	782 MHz
			1 RB / 5 RB Offset / 0 RB Index	
			1 RB / 0 RB Offset / 3 RB Index	
			1 RB / 5 RB Offset / 3 RB Index	
			1 RB / 0 RB Offset / 7 RB Index	
			1 RB / 5 RB Offset / 7 RB Index	
			3 RB / 0 RB Offset / 0 RB Index	
			3 RB / 3 RB Offset / 7 RB Index	
			6 RB / 0 RB Offset / 0 RB Index	
			6 RB / 0 RB Offset / 7 RB Index	
Equivalent Isotropic Radiated Power	10 MHz	QPSK, 16QAM	1 RB / 0 RB Offset / 0 RB Index	782 MHz
Frequency stability	10 MHz	QPSK	1 RB / 0 RB Offset / 0 RB Index	782 MHz
Occupied Bandwidth	10 MHz	QPSK, 16QAM	6 RB / 0 RB Offset / 0 RB Index	782 MHz
Peak-to-Average Ratio	10 MHz	QPSK, 16QAM	1 RB / 0 RB Offset / 0 RB Index	782 MHz
			6 RB / 0 RB Offset / 0 RB Index	
Band Edge	10 MHz	QPSK, 16QAM	1 RB / 0 RB Offset / 0 RB Index	782 MHz
			6 RB / 0 RB Offset / 0 RB Index	
			1 RB / 5 RB Offset / 0 RB Index	782 MHz
			6 RB / 5 RB Offset / 0 RB Index	
Spurious and Harmonic Emissions at Antenna Terminal	10 MHz	QPSK, 16QAM	1 RB / 0 RB Offset / 0 RB Index	782 MHz
Radiated Spurious and Harmonic Emissions	10 MHz	QPSK, 16QAM	1 RB / 0 RB Offset / 0 RB Index	782 MHz

### 5.4 Frequency List of Low/Middle/High Channels

LTE Band 4 Channel and Frequency List				
Bandwidth	Channel / Frequency	Low	Middle	High
10 MHz	Channel	20000	20175	20350
	Frequency	1 715 MHz	1 732.5 MHz	1 750 MHz

LTE Band 12 Channel and Frequency List				
Bandwidth	Channel / Frequency	Low	Middle	High
10 MHz	Channel	23060	23095	23130
	Frequency	704 MHz	707.5 MHz	711 MHz

LTE Band 13 Channel and Frequency List				
Bandwidth	Channel / Frequency	Low	Middle	High
10 MHz	Channel	-	23230	-
	Frequency	-	782 MHz	-

### 5.5 Configuration of Test System

**Radiated Emission Test:** Preliminary radiated emissions test were conducted using the procedure in ANSI C63.10: 2013 to determine the worse operating conditions. Final radiated emission tests were conducted at 3 m Semi Anechoic Chamber.

The turntable was rotated through 360 degrees and the EUT was tested by positioned three orthogonal planes to obtain the highest reading on the field strength meter. Once maximum reading was determined, the search antenna was raised and lowered in both vertical and horizontal polarization.

## 6. PRELIMINARY TEST

### 6.1 General Radiated Emissions Tests

During Preliminary Test, the following operating mode was investigated.

Operation Mode	The Worse operating condition (Please check one only)
Transmitting Mode	X



## 7. CONDUCTED OUTPUT POWER

### 7.1 Operating environment

Temperature : 23 °C  
 Relative humidity : 47 % R.H.

### 7.2 Test set-up

Conducted Output Power is tested in accordance with KDB971168 D01 Power Meas License Digital Systems v04, April 9, 2018, Section 5.2.

A base station simulator was used to establish communication with the EUT, and Spectrum analyzer was used for test results. This device was tested under all configurations and the highest power is reported. Conducted Output Powers of EUT are reported below.

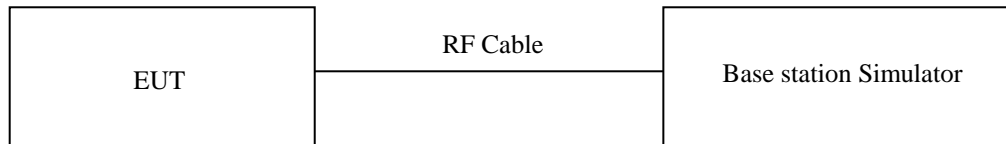

### 7.3 Test equipment used

	Model Number	Manufacturer	Description	Serial Number	Last Cal.
■ -	MT8821C	ANRITSU	Radio Communication Analyzer	6261849029	Jul. 26, 2019 (1Y)
□ -	GP-4303D	LG Precision Co.,Ltd	DC Power Supply	5071069	Jan. 10, 2019 (1Y)

All test equipment used is calibrated on a regular basis.

**7.4 Test data**

- Test Date : September 23, 2019 ~ October 04, 2019
- Test Result : Pass

Conducted Average Output Power (dBm)

Band / Bandwidth	RB Size	RB Offset	RB Index	QPSK			16QAM		
				LOW	MIDDLE	HIGH	LOW	MIDDLE	HIGH
				1715 MHz	1732.5 MHz	1750 MHz	1715 MHz	1732.5 MHz	1750 MHz
Band 4 / 10 MHz	1	0	0	22.69	22.92	22.93	23.35	23.37	23.34
	1	5	0	22.55	22.79	22.92	22.25	23.31	23.27
	1	0	3	22.54	22.90	22.89	23.32	23.33	23.29
	1	5	3	22.61	22.85	22.92	23.32	23.31	23.26
	1	0	7	22.58	22.83	22.51	22.70	23.34	22.81
	1	5	7	22.54	22.84	22.59	22.69	23.32	22.86
	3	0	0	22.64	22.64	22.69	22.49	22.54	22.45
	3	3	7	22.61	22.71	22.62	22.18	22.26	22.14
	6	0	0	22.63	22.69	22.66	23.14	22.77	23.13
	6	0	7	22.64	22.65	22.67	22.77	22.92	23.16

Conducted Average Output Power (dBm)

Band / Bandwidth	RB Size	RB Offset	RB Index	QPSK			16QAM		
				LOW	MIDDLE	HIGH	LOW	MIDDLE	HIGH
				704 MHz	707.5 MHz	711 MHz	704 MHz	707.5 MHz	711 MHz
Band 12 / 10 MHz	1	0	0	22.62	22.64	22.66	23.16	23.22	23.18
	1	5	0	22.59	22.62	22.59	23.12	23.19	23.16
	1	0	3	22.56	22.55	22.52	23.10	23.20	23.09
	1	5	3	22.61	22.54	22.49	23.13	23.08	23.09
	1	0	7	22.52	22.49	22.51	23.09	23.11	23.14
	1	5	7	22.49	22.61	22.49	23.08	23.09	23.10
	3	0	0	22.34	22.41	22.35	22.27	22.32	22.28
	3	3	7	22.28	22.26	22.33	22.17	22.17	22.25
	6	0	0	22.39	22.49	22.57	22.63	22.84	22.79
	6	0	7	22.33	22.43	22.46	22.61	22.79	22.66

Conducted Average Output Power (dBm)

Band / Bandwidth	RB Size	RB Offset	RB Index	QPSK			16QAM		
				LOW	MIDDLE	HIGH	LOW	MIDDLE	HIGH
				-	782 MHz	-	-	782 MHz	-
Band 13 / 10 MHz	1	0	0	-	22.74	-	-	23.35	-
	1	5	0	-	22.68	-	-	23.29	-
	1	0	3	-	22.67	-	-	23.31	-
	1	5	3	-	22.68	-	-	23.21	-
	1	0	7	-	22.68	-	-	23.17	-
	1	5	7	-	22.71	-	-	23.11	-
	3	0	0	-	22.59	-	-	22.48	-
	3	3	7	-	22.48	-	-	22.3	-
	6	0	0	-	22.64	-	-	22.83	-
	6	0	7	-	22.63	-	-	22.81	-

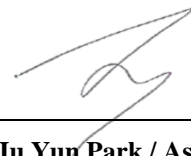

**Tested by: Ju Yun Park / Assistant Manager**

## 8. EQUIVALENT ISOTROPIC RADIATED POWER

### 8.1 Operating environment

Temperature : 24 °C  
 Relative humidity : 48 % R.H.

### 8.2 Methods of Measurement

1. The testing follows ANSI C63.26 (2015) Section 5.5.3.
2. Substitution method is used for E.I.R.P measurement. In the semi-anechoic chamber, EUT placed on the 0.8 m (below or equal 1 GHz) and/or 1.5 m (above 1 GHz) height of Turn Table, rotated the table around 360 degrees to search the maximum radiation power and receiver antenna shall be rotated vertical and horizontal polarization and moved height from 1 m to 4 m to find the maximum polar radiated power. The “Read Value” is the spectrum reading the maximum power value.
3. The substitution antenna is substituted for EUT at the same position and signals generator export the CW signal to the substitution antenna via a tx cable. Rotated the Turn Table and moved receiving antenna to find the maximum radiation power. Adjust output power level of S.G to get a Value of spectrum reading equal to “Read Value” of step 2. Record the power level of S.G.
4.  $EIRP = \text{Output power level of S.G} - \text{TX cable loss} + \text{Antenna gain of substitution antenna power}$  can be Calculated.  $E.R.P \text{ power} = E.I.P.R \text{ power} - 2.15 \text{ dBi}$ .

### 8.3 Limits

Rule Part 27.50(d) (4) specifies that “Fixed, mobile and portable (hand-held) stations operating in the 1710–1755 MHz band are limited to 1 watt EIRP”

Limit	1 W (30 dBm)
-------	--------------

### 8.4 Test set-up

The EUT and measurement equipment were set up as shown in the diagram below.

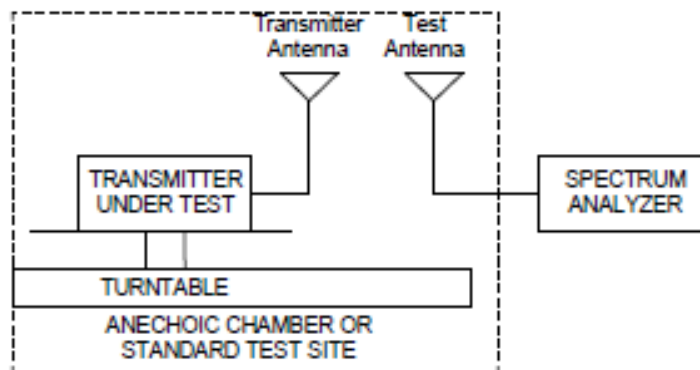

**8.5 Test equipment used**

	<b>Model Number</b>	<b>Manufacturer</b>	<b>Description</b>	<b>Serial Number</b>	<b>Last Cal. (Interval)</b>
■ -	ESR	Rohde & Schwarz	EMI Test Receiver	101470	Oct. 22, 2018 (1Y)
■ -	310N	Sonoma Instrument	AMPLIFIER	312544	Mar. 18, 2019 (1Y)
■ -	FSV30	Rohde & Schwarz	Signal Analyzer	101372	Jul. 24, 2019 (1Y)
□ -	BBV9718B	Schwarzbeck	Broadband Preamplifier	009	Mar. 20, 2019 (1Y)
■ -	SCU-03	Rohde & Schwarz	Signal Conditioning Unit	100333	Mar. 11, 2019 (1Y)
■ -	SCU-18	Rohde & Schwarz	Pre-Amplifier	102266	Jul. 24, 2019 (1Y)
■ -	MA-4000XPET	Innco Systems GmbH	Antenna Master	MA4000/509	N/A
□ -	HD100	HD GmbH	Position Controller	N/A	N/A
■ -	DT3000-3t	Innco Systems GmbH	Turn Table	N/A	N/A
□ -	FMZB 1513	Schwarzbeck	LOOP ANTENNA	1513-235	May. 13, 2018 (2Y)
■ -	VULB9163	Schwarzbeck	TRILOG Broadband Antenna	9163-255	Jun 05, 2018 (2Y)
■ -	VULB9163	Schwarzbeck	Hybrid Antenna	777	Apr, 13, 2018 (2Y)
■ -	BBHA9120D	Schwarzbeck	Horn Antenna	9120D-1366	Jul. 16, 2019 (1Y)
■ -	BBHA9120D	Schwarzbeck	Horn Antenna	9120D-295	Jul. 16, 2019 (1Y)
□ -	SCU40A	Rohde & Schwarz	Pre-Amplifier	100436	Mar. 11, 2019 (1Y)
■ -	MT8821C	ANRITSU	Radio Communication Analyzer	6261849029	Jul. 26, 2019 (1Y)
□ -	GP-4303D	LG Precision Co.,Ltd	DC Power Supply	5071069	Jan. 10, 2019 (1Y)

All test equipment used is calibrated on a regular basis.

### 8.6 Test data for LTE Band 4 QPSK

-. Test Date : September 23, 2019 ~ October 04, 2019

-. Test Result : Pass

Frequency (MHz)	Substituted Level (dBm)	Ant. Pol. (H/V)	Cable Loss (dB)	Ant Gain (dBi)	EIRP (dBm)	Limits (dBm)	Margin (dB)
<b>Test Data for QPSK</b>							
1 715.0	14.63	H	1.21	7.40	20.82	30.00	9.18
1 715.0	9.37	V	1.21	7.40	15.56	30.00	14.44
1 732.5	14.89	H	1.23	7.30	20.96	30.00	9.04
1 732.5	9.34	V	1.23	7.30	15.41	30.00	14.59
1 750.0	15.16	H	1.23	7.10	21.03	30.00	8.97
1 750.0	9.65	V	1.23	7.10	15.52	30.00	14.48

Remark: "H": Horizontal, "V": Vertical

### 8.7 Test data for LTE Band 4 16QAM

-. Test Date : September 23, 2019 ~ October 04, 2019

-. Test Result : Pass

Frequency (MHz)	Substituted Level (dBm)	Ant. Pol. (H/V)	Cable Loss (dB)	Ant Gain (dBi)	EIRP (dBm)	Limits (dBm)	Margin (dB)
<b>Test Data for 16QAM</b>							
1 715.0	15.23	H	1.21	7.40	21.42	30.00	8.58
1 715.0	10.03	V	1.21	7.40	16.22	30.00	13.78
1 732.5	15.31	H	1.23	7.30	21.38	30.00	8.62
1 732.5	10.08	V	1.23	7.30	16.15	30.00	13.85
1 750.0	15.59	H	1.23	7.10	21.46	30.00	8.54
1 750.0	10.11	V	1.23	7.10	15.98	30.00	14.02

Remark: "H": Horizontal, "V": Vertical

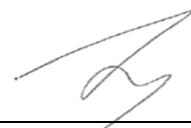

**Tested by: Ju Yun Park / Assistant Manager**

**9. EFFECTIVE RADIATED POWER**

**9.1 Operating environment**

Temperature : 24 °C  
 Relative humidity : 48 % R.H.

**9.2 Methods of Measurement**

1. The testing follows ANSI C63.26 (2015) Section 5.5.3.
2. Substitution method is used for E.I.R.P measurement. In the semi-anechoic chamber, EUT placed on the 0.8 m (below or equal 1 GHz) and/or 1.5 m (above 1 GHz) height of Turn Table, rotated the table around 360 degrees to search the maximum radiation power and receiver antenna shall be rotated vertical and horizontal polarization and moved height from 1 m to 4 m to find the maximum polar radiated power. The “Read Value” is the spectrum reading the maximum power value.
3. The substitution antenna is substituted for EUT at the same position and signals generator export the CW signal to the substitution antenna via a tx cable. Rotated the Turn Table and moved receiving antenna to find the maximum radiation power. Adjust output power level of S.G to get a Value of spectrum reading equal to “Read Value” of step 2. Record the power level of S.G.
4. EIRP = Output power level of S.G – TX cable loss + Antenna gain of substitution antenna power can be Calculated. E.R.P power = E.I.P.R power - 2.15 dBi.

**9.3 Limits**

Rule Part 27.50(b) (10) specifies that “Portable stations (hand-held devices) transmitting in the 746-757 MHz, 776-788 MHz, and 805-806 MHz bands are limited to 3 watts ERP”

Rule Part 27.50(c) (10) specifies that “Portable stations (hand-held devices) in the 600 MHz uplink band and the 698-746 MHz band, and fixed and mobile stations in the 600 MHz uplink band are limited to 3 watts ERP”

Limit	3 W (34.77 dBm)
-------	-----------------

**9.4 Test set-up**

The EUT and measurement equipment were set up as shown in the diagram below.

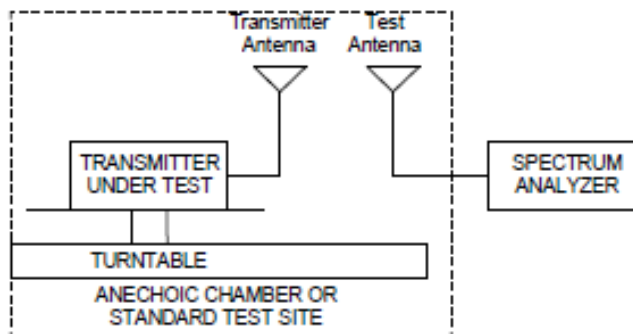

**9.5 Test equipment used**

	<b>Model Number</b>	<b>Manufacturer</b>	<b>Description</b>	<b>Serial Number</b>	<b>Last Cal. (Interval)</b>
■ -	ESR	Rohde & Schwarz	EMI Test Receiver	101470	Oct. 22, 2018 (1Y)
■ -	310N	Sonoma Instrument	AMPLIFIER	312544	Mar. 18, 2019 (1Y)
■ -	FSV30	Rohde & Schwarz	Signal Analyzer	101372	Jul. 24, 2019 (1Y)
□ -	BBV9718B	Schwarzbeck	Broadband Preamplifier	009	Mar. 20, 2019 (1Y)
■ -	SCU-03	Rohde & Schwarz	Signal Conditioning Unit	100333	Mar. 11, 2019 (1Y)
■ -	SCU-18	Rohde & Schwarz	Pre-Amplifier	102266	Jul. 24, 2019 (1Y)
■ -	MA-4000XPET	Innco Systems GmbH	Antenna Master	MA4000/509	N/A
□ -	HD100	HD GmbH	Position Controller	N/A	N/A
■ -	DT3000-3t	Innco Systems GmbH	Turn Table	N/A	N/A
□ -	FMZB 1513	Schwarzbeck	LOOP ANTENNA	1513-235	May. 13, 2018 (2Y)
■ -	VULB9163	Schwarzbeck	TRILOG Broadband Antenna	9163-255	Jun 05, 2018 (2Y)
■ -	VULB9163	Schwarzbeck	Hybrid Antenna	777	Apr, 13, 2018 (2Y)
■ -	BBHA9120D	Schwarzbeck	Horn Antenna	9120D-1366	Jul. 16, 2019 (1Y)
■ -	BBHA9120D	Schwarzbeck	Horn Antenna	9120D-295	Jul. 16, 2019 (1Y)
□ -	SCU40A	Rohde & Schwarz	Pre-Amplifier	100436	Mar. 11, 2019 (1Y)
■ -	MT8821C	ANRITSU	Radio Communication Analyzer	6261849029	Jul. 26, 2019 (1Y)
□ -	GP-4303D	LG Precision Co.,Ltd	DC Power Supply	5071069	Jan. 10, 2019 (1Y)

All test equipment used is calibrated on a regular basis.



**9.6 Test data for LTE Band 12 QPSK**

-. Test Date : September 23, 2019 ~ October 04, 2019

-. Test Result : Pass

Frequency (MHz)	Substituted Level (dBm)	Ant. Pol. (H/V)	Cable Loss (dB)	Ant Gain (dBd)	ERP (dBm)	Limits (dBm)	Margin (dB)
<b>Test Data for QPSK</b>							
704.0	16.38	H	0.85	5.45	20.98	34.77	13.79
704.0	10.83	V	0.85	5.45	15.43	34.77	19.34
707.5	16.33	H	0.87	5.45	20.91	34.77	13.86
707.5	10.77	V	0.87	5.45	15.35	34.77	19.42
711.0	16.49	H	0.86	5.25	20.88	34.77	13.89
711.0	10.82	V	0.86	5.25	15.21	34.77	19.56

Remark: "H": Horizontal, "V": Vertical

**9.7 Test data for LTE Band 12 16QAM**

-. Test Date : September 23, 2019 ~ October 04, 2019

-. Test Result : Pass

Frequency (MHz)	Substituted Level (dBm)	Ant. Pol. (H/V)	Cable Loss (dB)	Ant Gain (dBd)	ERP (dBm)	Limits (dBm)	Margin (dB)
<b>Test Data for 16QAM</b>							
704.0	16.55	H	0.85	5.45	21.15	34.77	13.62
704.0	11.34	V	0.85	5.45	15.94	34.77	18.83
707.5	16.65	H	0.87	5.45	21.23	34.77	13.54
707.5	11.31	V	0.87	5.45	15.89	34.77	18.88
711.0	16.78	H	0.86	5.25	21.17	34.77	13.60
711.0	11.52	V	0.86	5.25	15.91	34.77	18.86

Remark: "H": Horizontal, "V": Vertical



**Tested by: Ju Yun Park / Assistant Manager**

**9.8 Test data for LTE Band 13 QPSK**

-. Test Date : September 23, 2019 ~ October 04, 2019

-. Test Result : Pass

Frequency (MHz)	Substituted Level (dBm)	Ant. Pol. (H/V)	Cable Loss (dB)	Ant Gain (dBd)	ERP (dBm)	Limits (dBm)	Margin (dB)
<b>Test Data for QPSK</b>							
782.0	16.80	H	0.88	4.95	20.87	34.77	13.90
782.0	11.31	V	0.88	4.95	15.38	34.77	19.39

Remark: "H": Horizontal, "V": Vertical

**9.9 Test data for LTE Band 13 16QAM**

-. Test Date : September 23, 2019 ~ October 04, 2019

-. Test Result : Pass

Frequency (MHz)	Substituted Level (dBm)	Ant. Pol. (H/V)	Cable Loss (dB)	Ant Gain (dBd)	ERP (dBm)	Limits (dBm)	Margin (dB)
<b>Test Data for 16QAM</b>							
782.0	17.22	H	0.88	4.95	21.29	34.77	13.48
782.0	11.44	V	0.88	4.95	15.51	34.77	19.26

Remark: "H": Horizontal, "V": Vertical

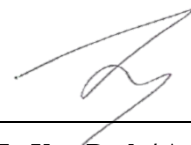

**Tested by: Ju Yun Park / Assistant Manager**

## 10. RADIATED SPURIOUS EMISSIONS

### 10.1 Operating environment

Temperature : 24 °C  
 Relative humidity : 48 % R.H.

### 10.2 Test set-up

Radiated emission measurements are performed in the Semi-Anechoic chamber. The equipment under test is placed on a non-conductive table 3-meters away from the receive antenna in accordance with ANSI C63.26 (2015) Section 5.5.3. The turntable is rotated through 360°, and the receiving antenna scans in order to determine the level of the maximized emission. The level and position of the maximized emission is recorded with the spectrum analyzer using RMS detector.

A vertically polarized half-wave dipole is then substituted in place of the EUT. For emissions above 1GHz, a horn antenna is substituted in place of the EUT. The substitute antenna is driven by a signal generator and the previously recorded signal was duplicated.

The power is calculated by the following formula;

$$Pd(\text{dBm}) = Pg(\text{dBm}) - \text{cable loss (dB)} + \text{antenna gain (dB)}$$

Where: Pd is the dipole equivalent power and Pg is the generator output power into the substitution antenna.

The maximum EIRP is calculated by adding the forward power to the calibrated source plus its appropriate gain value.

These steps are repeated with the receiving antenna in both vertical and horizontal polarization. the difference between the gain of the horn and an isotropic antenna are taken into consideration

### Limits

LTE -4 Rule Part 27.53(h) specifies that “for operations in the 1695-1710 MHz, 1710-1755 MHz, 1755-1780 MHz, 1915-1920 MHz, 1995-2000 MHz, 2000-2020 MHz, 2110-2155 MHz, 2155-2180 MHz, and 2180-2200 bands, the power of any emission outside a licensee's frequency block shall be attenuated below the transmitter power (P) in watts by at least 43 + 10 log<sub>10</sub> (P) dB.”

LTE -12 Rule Part 27.53 (g) For operations in the 600 MHz band and the 698-746 MHz band, the power of any emission outside a licensee's frequency band(s) of operation shall be attenuated below the transmitter power (P) within the licensed band(s) of operation, measured in watts, by at least 43 +10 log (P) dB. Compliance with this provision is based on the use of measurement instrumentation employing a resolution bandwidth of 100 kilohertz or greater. However, in the 100 kilohertz bands immediately outside and adjacent to a licensee's frequency block, a resolution bandwidth of at least 30 kHz may be employed.

LTE -13 Rule Part 27.53(f) For operations in the 746-758 MHz, 775-788 MHz, and 805-806 MHz bands, emissions in the band 1559-1610 MHz shall be limited to -70 dBW/MHz equivalent isotropically radiated power (EIRP) for wideband signals, and -80 dBW EIRP for discrete emissions of less than 700 Hz bandwidth. For the purpose of equipment

authorization, a transmitter shall be tested with an antenna that is representative of the type that will be used with the equipment in normal operation.

LTE Band 4 / 12 Limit

Limit	-13 dBm
-------	---------

LTE Band 13 Limit

Limit out of the band 1559-1610 MHz	-13 dBm
Limit in the band 1559-1610 MHz	-40 dBm

**Radiated spurious emissions**

1. Frequency Range : 9 kHz ~ 10th Harmonics of highest channel fundamental frequency.
  2. The EUT was setup to maximum output power. The 100 kHz RBW was used to scan from 30 MHz to 1 GHz.
- Also, the 1 MHz RBW was used to scan from 1 GHz to 20 GHz. The high, low and a middle channel were tested for out of band measurements.

### 10.3 Test equipment used

	Model Number	Manufacturer	Description	Serial Number	Last Cal. (Interval)
■ -	ESR	Rohde & Schwarz	EMI Test Receiver	101470	Oct. 22, 2018 (1Y)
■ -	310N	Sonoma Instrument	AMPLIFIER	312544	Mar. 18, 2019 (1Y)
■ -	FSV30	Rohde & Schwarz	Signal Analyzer	101372	Jul. 24, 2019 (1Y)
□ -	BBV9718B	Schwarzbeck	Broadband Preamplifier	009	Mar. 20, 2019 (1Y)
■ -	SCU-03	Rohde & Schwarz	Signal Conditioning Unit	100333	Mar. 11, 2019 (1Y)
■ -	SCU-18	Rohde & Schwarz	Pre-Amplifier	102266	Jul. 24, 2019 (1Y)
■ -	MA-4000XPET	Innco Systems GmbH	Antenna Master	MA4000/509	N/A
□ -	HD100	HD GmbH	Position Controller	N/A	N/A
■ -	DT3000-3t	Innco Systems GmbH	Turn Table	N/A	N/A
□ -	FMZB 1513	Schwarzbeck	LOOP ANTENNA	1513-235	May. 13, 2018 (2Y)
■ -	VULB9163	Schwarzbeck	TRILOG Broadband Antenna	9163-255	Jun 05, 2018 (2Y)
■ -	VULB9163	Schwarzbeck	Hybrid Antenna	777	Apr, 13, 2018 (2Y)
■ -	BBHA9120D	Schwarzbeck	Horn Antenna	9120D-1366	Jul. 16, 2019 (1Y)
■ -	BBHA9120D	Schwarzbeck	Horn Antenna	9120D-295	Jul. 16, 2019 (1Y)
□ -	SCU40A	Rohde & Schwarz	Pre-Amplifier	100436	Mar. 11, 2019 (1Y)
■ -	MT8821C	ANRITSU	Radio Communication Analyzer	6261849029	Jul. 26, 2019 (1Y)
□ -	GP-4303D	LG Precision Co.,Ltd	DC Power Supply	5071069	Jan. 10, 2019 (1Y)

All test equipment used is calibrated on a regular basis.

**10.4 Test data**

**10.4.1 Test data for LTE Band 4 QPSK**

- . Test Date : September 23, 2019 ~ October 04, 2019
- . Detector : RMS
- . Measurement distance : 3 m
- . Result : PASSED

Frequency (MHz)	Substituted Level (dBm)	Ant. Pol. (H/V)	Cable Loss (dB)	Ant Gain (dBi)	Corrected Reading (dBm)	Limits (dBm)	Margin (dB)
<b>Test Data for Low Channel</b>							
3 430.00	-83.04	V	2.16	12.51	-72.69	-13.00	59.69
5 145.00	-79.44	V	2.80	12.50	-69.74	-13.00	56.74
6 860.00	-77.47	V	3.31	12.31	-68.47	-13.00	55.47
8 575.00	-72.65	H	4.05	12.05	-64.65	-13.00	51.65
10 290.00	-70.98	V	4.11	11.08	-64.01	-13.00	51.01
<b>Test Data for Middle Channel</b>							
3 465.00	-82.28	V	2.16	12.51	-71.93	-13.00	58.93
5 197.50	-79.76	V	2.80	12.50	-70.06	-13.00	57.06
6 930.00	-75.80	V	3.31	12.31	-66.80	-13.00	53.80
8 662.50	-73.32	H	4.05	12.05	-65.32	-13.00	52.32
10 395.00	-69.27	V	4.11	11.08	-62.30	-13.00	49.30
<b>Test Data for High Channel</b>							
3 500.00	-81.81	V	2.16	12.51	-71.46	-13.00	58.46
5 250.00	-81.04	H	2.80	12.50	-71.34	-13.00	58.34
7 000.00	-75.64	V	3.31	12.31	-66.64	-13.00	53.64
8 750.00	-73.54	V	4.05	12.05	-65.54	-13.00	52.54
10 500.00	-71.69	V	4.11	11.08	-64.72	-13.00	51.72

Remark: 1. The other Spurious RF Radiated emissions level is no more than noise floor.

2. The worst case was found in 16QAM modulation

3. Rule Part 27.53(h) specifies that “ the power of any emission outside a licensee's frequency block shall be attenuated below the transmitter power (P) in watts by at least 43 + 10 log10 (P) dB.”

Limit :  $30.00 - 43 + 10 \log(1.00) = -13 \text{ dBm}$

“C.L” : Cable Loss, “H”: Horizontal, “V”: Vertical



**Tested by: Ju Yun Park / Assistant Manager**

**10.4.2 Test data for LTE Band 12 QPSK**

- Test Date : August 05, 2019 ~ August 23, 2019
- Detector : RMS
- Measurement distance : 3 m
- Result : PASSED

Frequency (MHz)	Substituted Level (dBm)	Ant. Pol. (H/V)	Cable Loss (dB)	Ant Gain (dBi)	Corrected Reading (dBm)	Limits (dBm)	Margin (dB)
<b>Test Data for Low Channel</b>							
1 408.00	-66.84	H	1.28	7.50	-60.62	-13.00	47.62
2 112.00	-59.31	H	1.52	6.70	-54.13	-13.00	41.13
2 816.00	-56.39	V	1.67	5.00	-53.06	-13.00	40.06
3 520.00	-82.26	H	1.98	12.33	-71.91	-13.00	58.91
4 224.00	-81.48	V	2.26	12.74	-71.00	-13.00	58.00
<b>Test Data for Middle Channel</b>							
1 415.00	-67.51	H	1.28	7.50	-61.29	-13.00	48.29
2 122.50	-59.61	H	1.52	6.70	-54.43	-13.00	41.43
2 830.00	-56.13	V	1.67	5.00	-52.80	-13.00	39.80
3 537.50	-82.19	V	1.98	12.33	-71.84	-13.00	58.84
4 245.00	-81.04	V	2.26	12.74	-70.56	-13.00	57.56
<b>Test Data for High Channel</b>							
1 422.00	-68.28	H	1.28	7.50	-62.06	-13.00	49.06
2 133.00	-54.98	V	1.52	6.70	-49.80	-13.00	36.80
2 844.00	-55.70	V	1.67	5.00	-52.37	-13.00	39.37
3 555.00	-81.82	H	1.98	12.33	-71.47	-13.00	58.47
4 266.00	-81.08	V	2.26	12.74	-70.60	-13.00	57.60

Remark: 1. The other Spurious RF Radiated emissions level is no more than noise floor.

2. The worst case was found in 16QAM modulation

3. Rule Part 27.53 (g) For operations in the 600 MHz band and the 698-746 MHz band, the power of any emission outside a licensee's frequency band(s) of operation shall be attenuated below the transmitter power (P) within the licensed band(s) of operation, measured in watts, by at least  $43 + 10 \log (P)$  dB.

Limit :  $34.77 - 43 + 10 \log(3.00) = -13$  dBm

“C.L” : Cable Loss, “H”: Horizontal, “V”: Vertical

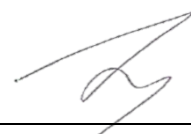

**Tested by: Ju Yun Park / Assistant Manager**

**10.4.2 Test data for LTE Band 13 QPSK**

- Test Date : August 05, 2019 ~ August 23, 2019
- Detector : RMS
- Measurement distance : 3 m
- Result : PASSED

Frequency (MHz)	Substituted Level (dBm)	Ant. Pol. (H/V)	Cable Loss (dB)	Ant Gain (dBi)	Corrected Reading (dBm)	Limits (dBm)	Margin (dB)
<b>Test Data for Middle Channel</b>							
1 564.00	-69.11	H	1.28	7.50	-62.89	-40.00	22.89
2 346.00	-57.31	H	1.52	6.70	-52.13	-13.00	39.13
3 128.00	-75.08	V	1.67	5.00	-71.75	-13.00	58.75
3 910.00	-81.91	H	1.98	12.33	-71.56	-13.00	58.56
4 692.00	-80.41	V	2.26	12.74	-69.93	-13.00	56.93

Remark: 1. The other Spurious RF Radiated emissions level is no more than noise floor.

2. The worst case was found in 16QAM modulation

3. Rule Part 27.53(f) For operations in the 746-758 MHz, 775-788 MHz, and 805-806 MHz bands, emissions in the band 1559-1610 MHz shall be limited to -70 dBW/MHz equivalent isotropically radiated power (EIRP) for wideband signals, and -80 dBW EIRP for discrete emissions of less than 700 Hz bandwidth. For the purpose of equipment authorization, a transmitter shall be tested with an antenna that is representative of the type that will be used with the equipment in normal operation.

Limit out of the band 1559-1610 MHz :  $34.77 - 43 + 10\log(3.00) = -13$  dBm

Limit in the band 1559-1610 MHz : -40 dBm

“C.L” : Cable Loss, “H”: Horizontal, “V”: Vertical



**Tested by: Ju Yun Park / Assistant Manager**



## 11. PEAK-TO-AVERAGE RATIO

### 11.1 Operating environment

Temperature : 23 °C  
 Relative humidity : 47 % R.H.

### 11.2 Test set-up

Peak to Average Power Ratio is tested in accordance with KDB971168 D01 Power Meas License Digital Systems v04, April 9, 2018, Section 5.7.

#### - Section 5.7.2 Measurement of peak power in a broadband noise-like signal using CCDF

- a) Set resolution/measurement bandwidth  $\geq$  OBW or specified reference bandwidth.
- b) Set the number of counts to a value that stabilizes the measured CCDF curve.
- c) Set the measurement interval as follows:
  - 1) For continuous transmissions, set to the greater of  $[10 \times (\text{number of points in sweep}) \times (\text{transmission symbol period})]$  or 1 ms.
  - 2) For burst transmissions, employ an external trigger that is synchronized with the EUT burst timing sequence, or use the internal burst trigger with a trigger level that allows the burst to stabilize. Set the measurement interval to a time that is less than or equal to the burst duration.
  - 3) If there are several carriers in a single antenna port, the peak power shall be determined for each individual carrier (by disabling the other carriers while measuring the required carrier) and the total peak power calculated from the sum of the individual carrier peak powers.
- d) Record the maximum PAPR level associated with a probability of 0.1%.
- e) The peak power level is calculated from the sum of the PAPR value from step d) to the measured average power.

#### - Section 5.7.3 Alternate Procedure for PAPR

Some regulatory requirements specify a PAPR limit when the output power limits are specified in terms of average power. If it becomes necessary to provide measurement data to demonstrate compliance to a PAPR limit, then the appropriate procedure from those provided in 5.2.3 shall be utilized to determine the peak power (or peak PSD) and the appropriate procedure from those provided in 5.2.4 shall be used to determine the average power (or average PSD). The data from these measurements is then used in Equation (2) to determine the PAPR of a narrowband CW-like signal. See 5.2.3.4 for guidance on determining the PAPR of a broadband noise-like signal.

$$\text{PAPR (dB)} = P_{\text{Pk}} \text{ (dBm or dBW)} - P_{\text{Avg}} \text{ (dBm or dBW)}$$

where

PAPR peak-to-average power ratio, in dB

$P_{\text{Pk}}$  measured peak power or peak PSD level, in dBm or dBW

$P_{\text{Avg}}$  measured average power or average PSD level, in dBm or dBW

**11.3 Test equipment used**

Model Number	Manufacturer	Description	Serial Number	Last Cal.
■ - FSV30	Rohde & Schwarz	Signal Analyzer	101372	Jul. 24, 2019 (1Y)
■ - AAMCS-UDC	AA-MCS	Directional Coupler	400	Jul. 25, 2019 (1Y)
■ - MT8821C	ANRITSU	Radio Communication Analyzer	6261849029	Jul. 26, 2019 (1Y)
□ - GP-4303D	LG Precision Co.,Ltd	DC Power Supply	5071069	Jan. 10, 2019 (1Y)

All test equipment used is calibrated on a regular basis.

**11.4 Test data**

**11.4.1 Test data LTE Band 4**

- Test Date : September 23, 2019 ~ October 04, 2019

- Test Result : Pass

**LTE Band 4 QPSK**

Test Mode	Channel	Peak-Average Ratio(PAR) CCDF 0.1 %	Limit (dB)	Result
1 RB	20000	4.35	13.00	PASS
	20175	4.17	13.00	PASS
	20350	4.49	13.00	PASS
6 RB	20000	4.38	13.00	PASS
	20175	4.17	13.00	PASS
	20350	4.81	13.00	PASS

Remark: Measured the using CCDFof spectrum analyzer.

**LTE Band 4 16QAM**

Test Mode	Channel	Peak-Average Ratio(PAR) CCDF 0.1 %	Limit (dB)	Result
1 RB	20000	4.55	13.00	PASS
	20175	4.12	13.00	PASS
	20350	4.00	13.00	PASS
6 RB	20000	4.70	13.00	PASS
	20175	4.72	13.00	PASS
	20350	4.46	13.00	PASS

Remark: Measured the using CCDFof spectrum analyzer.

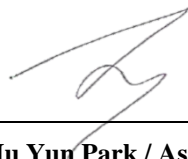

**Tested by: Ju Yun Park / Assistant Manager**

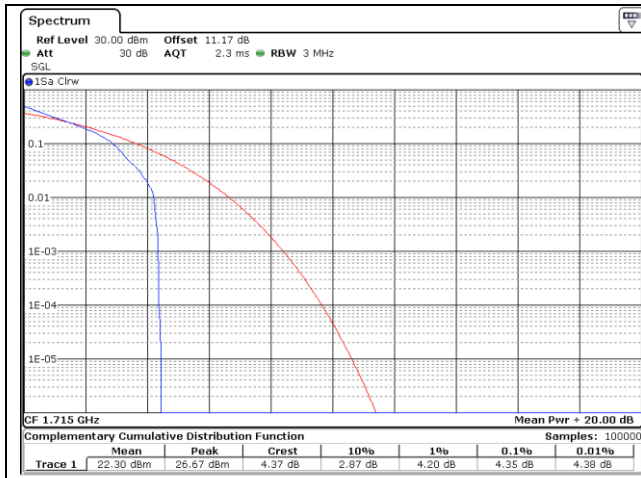

QPSK Low Channel (1 RB)

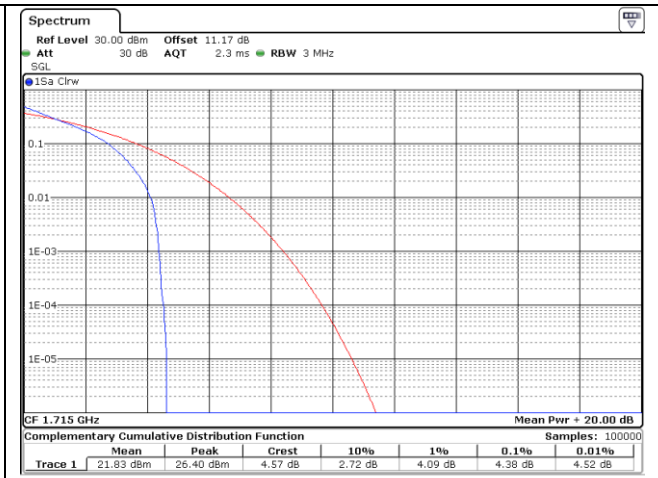

QPSK Low Channel (6 RB)

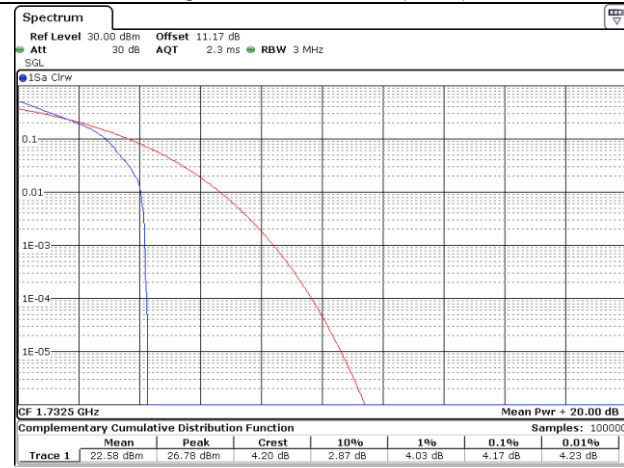

QPSK Middle Channel (1 RB)

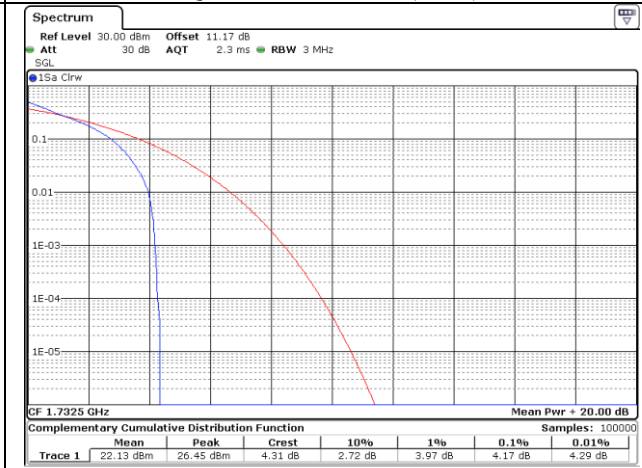

QPSK Middle Channel (6 RB)

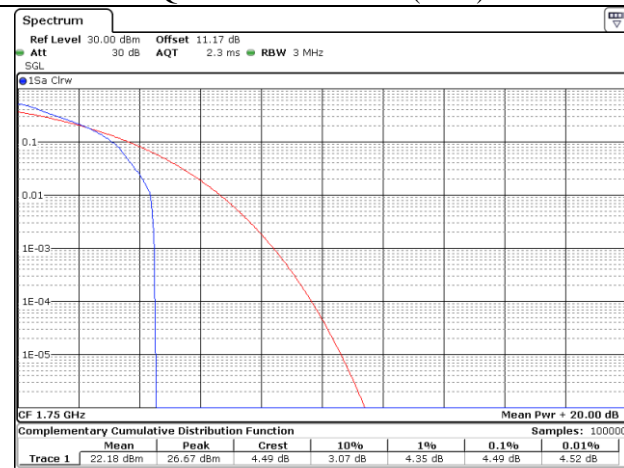

QPSK High Channel (1 RB)

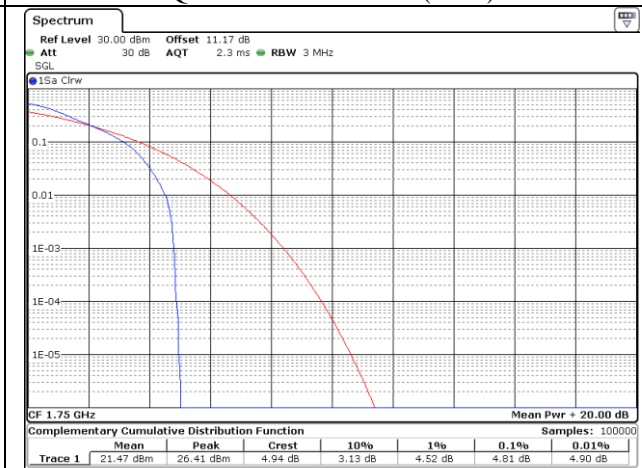

QPSK High Channel (6 RB)

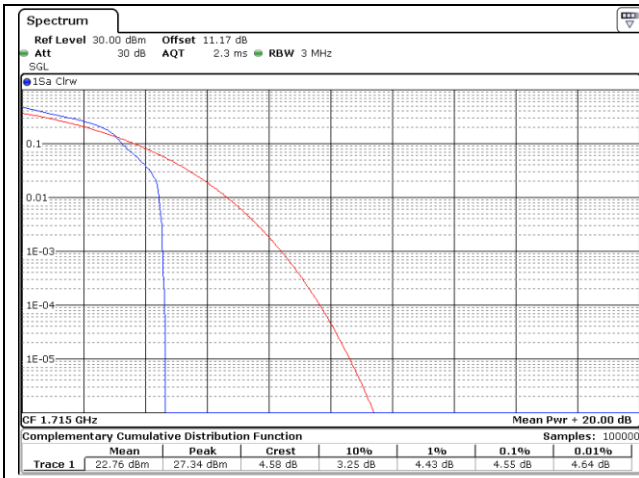

16QAM Low Channel (1 RB)

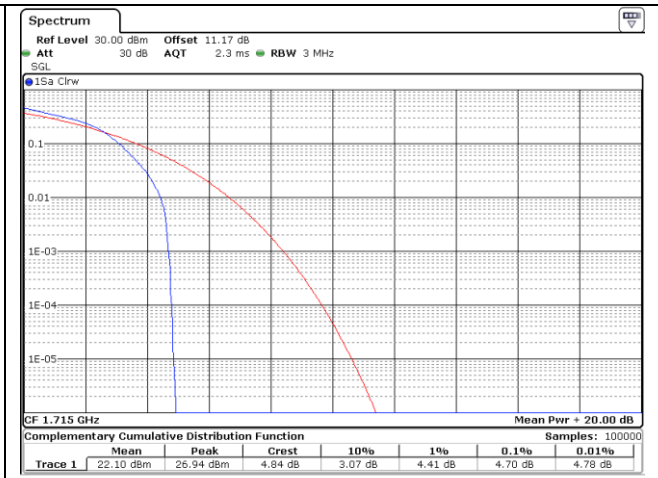

16QAM Low Channel (6 RB)



16QAM Middle Channel (1 RB)

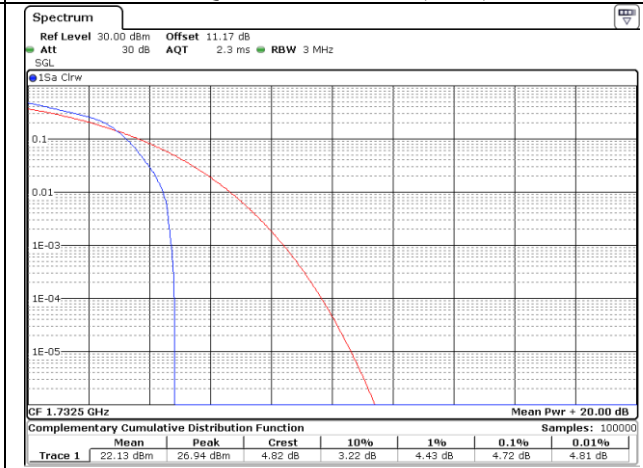

16QAM Middle Channel (6 RB)

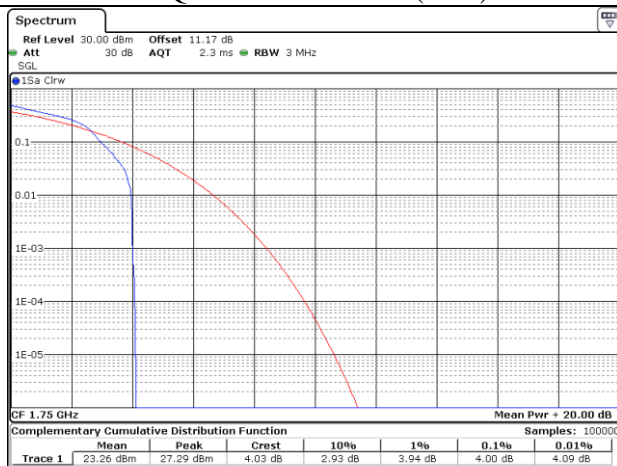

16QAM High Channel (1 RB)

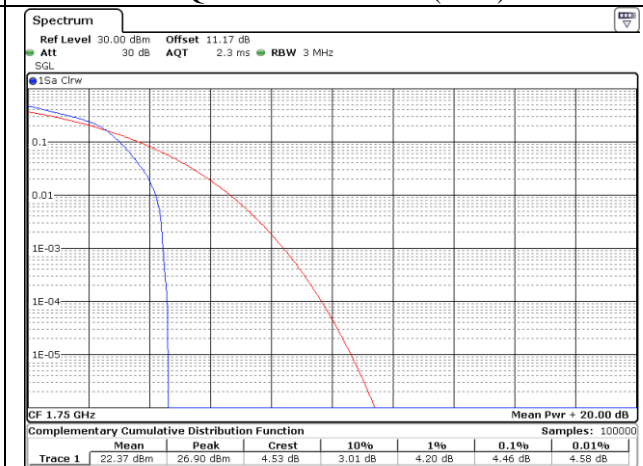

16QAM High Channel (6 RB)

**11.4.2 Test data LTE Band 12**

-. Test Date : September 23, 2019 ~ October 04, 2019

-. Test Result : Pass

**LTE Band 12 QPSK**

Test Mode	Channel	Peak-Average Ratio(PAR) CCDF 0.1 %	Limit (dB)	Result
1 RB	23060	4.32	13.00	PASS
	23095	4.35	13.00	PASS
	23130	4.32	13.00	PASS
6 RB	23060	4.38	13.00	PASS
	23095	4.41	13.00	PASS
	23130	4.67	13.00	PASS

Remark: Measured the using CCDFof spectrum analyzer.

**LTE Band 12 16QAM**

Test Mode	Channel	Peak-Average Ratio(PAR) CCDF 0.1 %	Limit (dB)	Result
1 RB	23060	4.58	13.00	PASS
	23095	4.49	13.00	PASS
	23130	4.70	13.00	PASS
6 RB	23060	4.75	13.00	PASS
	23095	4.84	13.00	PASS
	23130	4.96	13.00	PASS

Remark: Measured the using CCDFof spectrum analyzer.

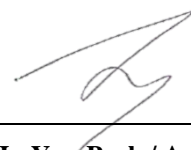

**Tested by: Ju Yun Park / Assistant Manager**

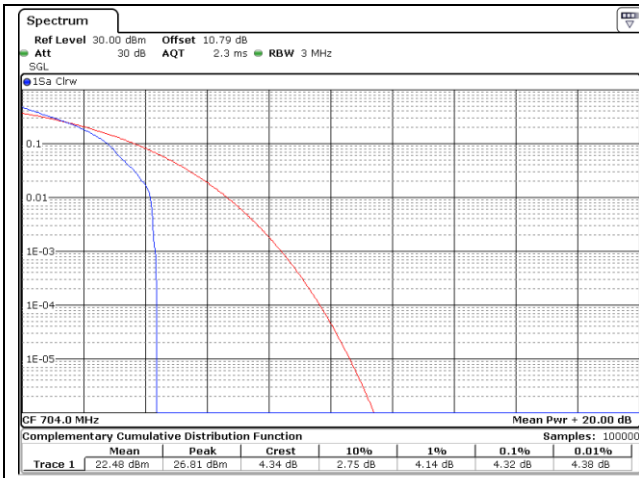

QPSK Low Channel (1 RB)

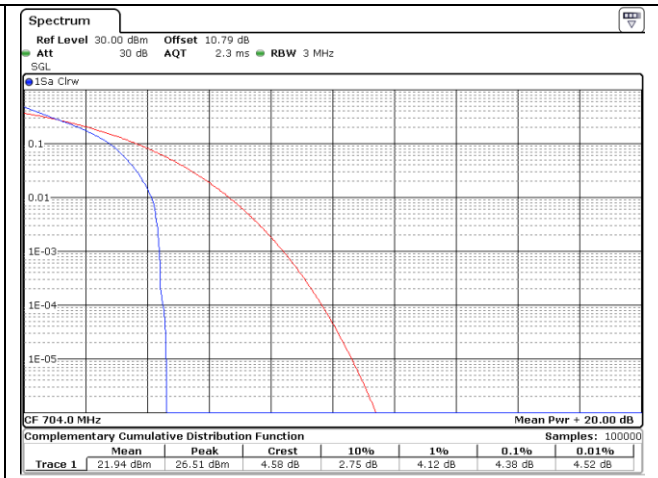

QPSK Low Channel (6 RB)

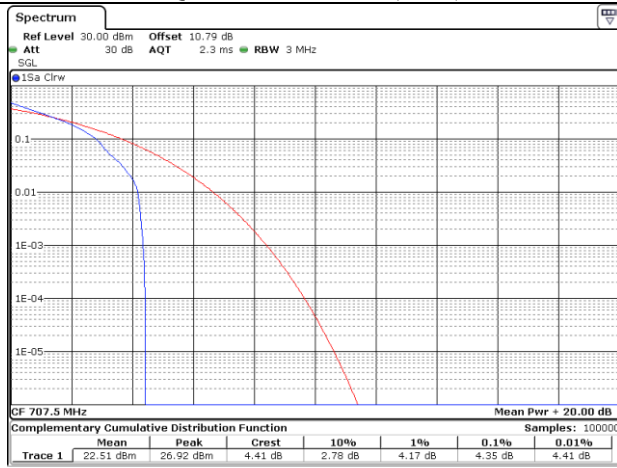

QPSK Middle Channel (1 RB)

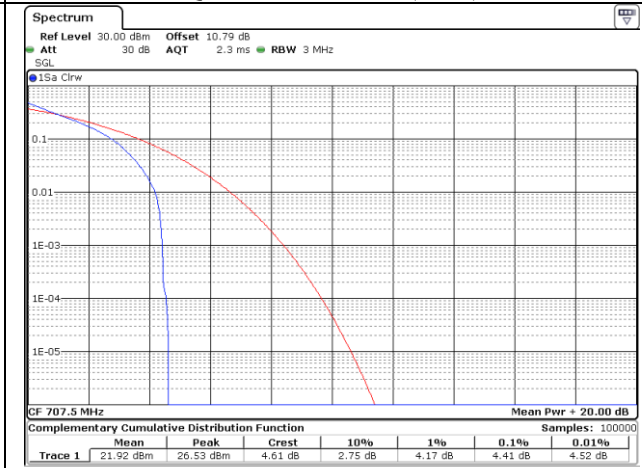

QPSK Middle Channel (6 RB)

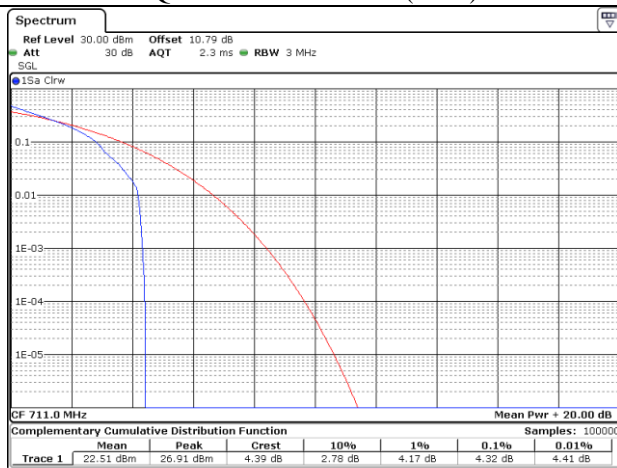

QPSK High Channel (1 RB)

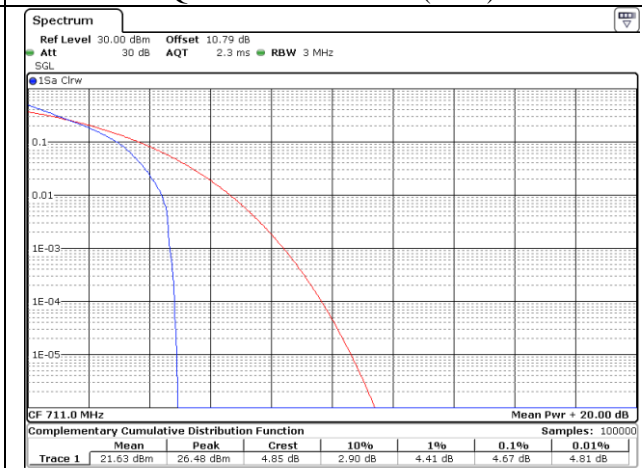

QPSK High Channel (6 RB)

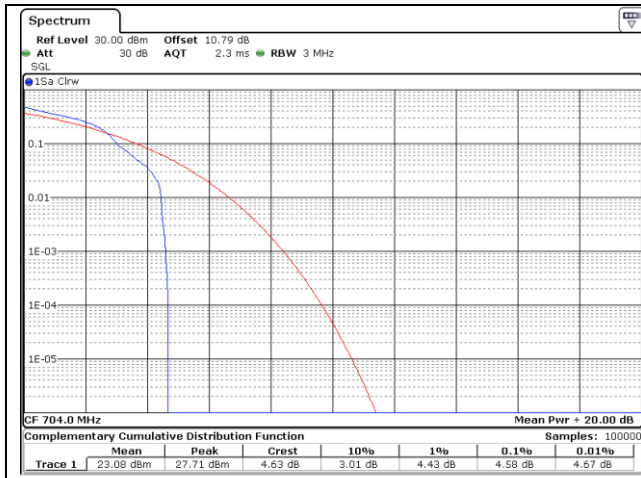

16QAM Low Channel (1 RB)

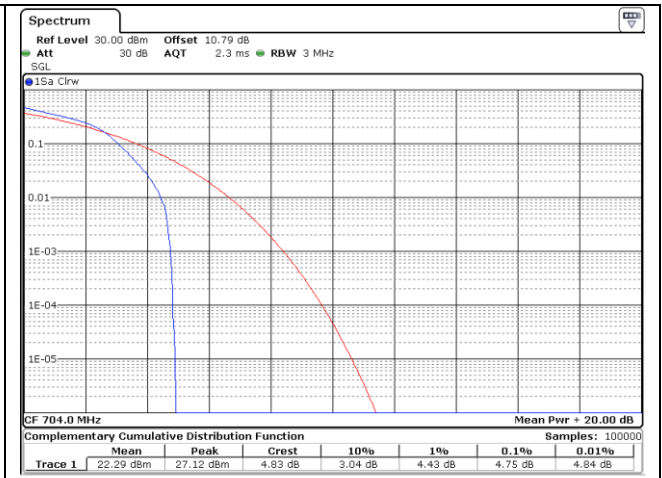

16QAM Low Channel (6 RB)

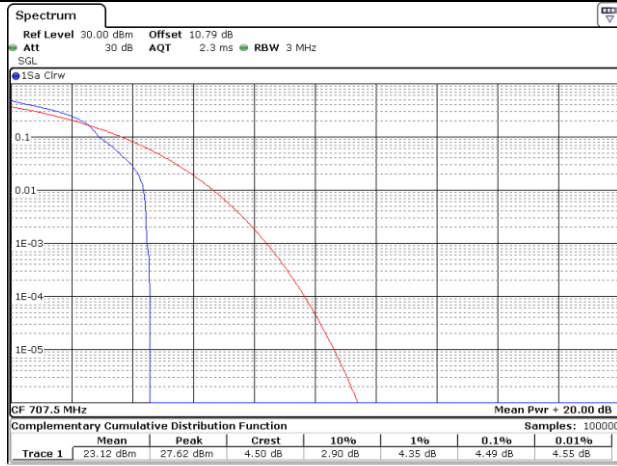

16QAM Middle Channel (1 RB)

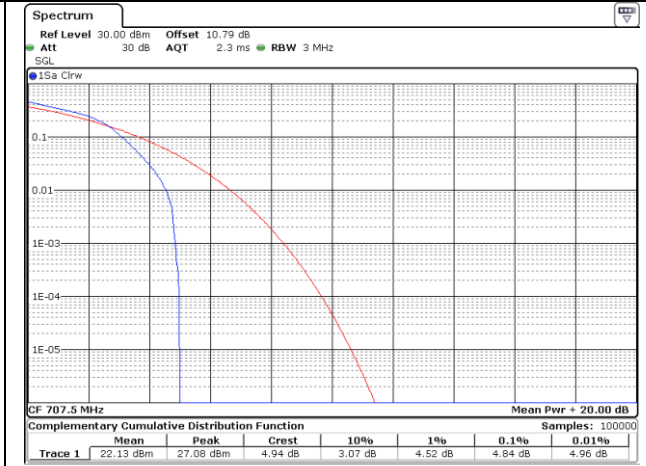

16QAM Middle Channel (6 RB)

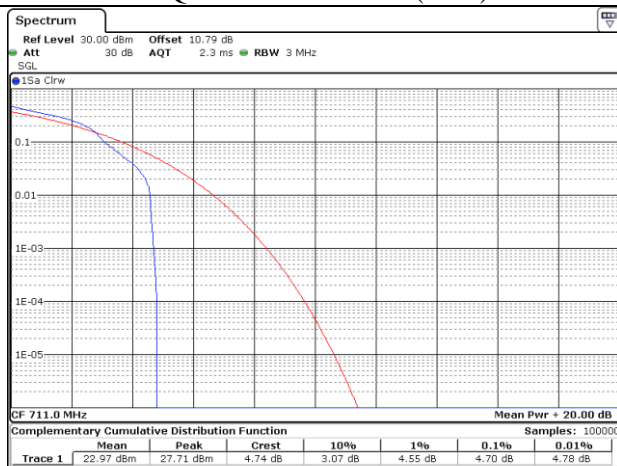

16QAM High Channel (1 RB)

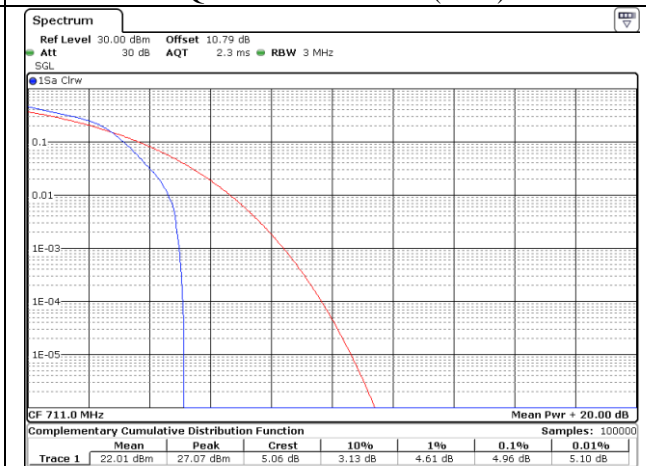

16QAM High Channel (6 RB)

**11.4.3 Test data LTE Band 13**

-. Test Date : September 23, 2019 ~ October 04, 2019

-. Test Result : Pass

**LTE Band 13 QPSK**

Test Mode	Channel	Peak-Average Ratio(PAR) CCDF 0.1 %	Limit (dB)	Result
1 RB	23230	4.35	13.00	PASS
6 RB	23230	5.16	13.00	PASS

Remark: Measured the using CCDFof spectrum analyzer.

**LTE Band 13 16QAM**

Test Mode	Channel	Peak-Average Ratio(PAR) CCDF 0.1 %	Limit (dB)	Result
1 RB	23230	4.75	13.00	PASS
6 RB	23230	5.10	13.00	PASS

Remark: Measured the using CCDFof spectrum analyzer.

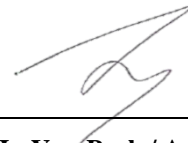

**Tested by: Ju Yun Park / Assistant Manager**



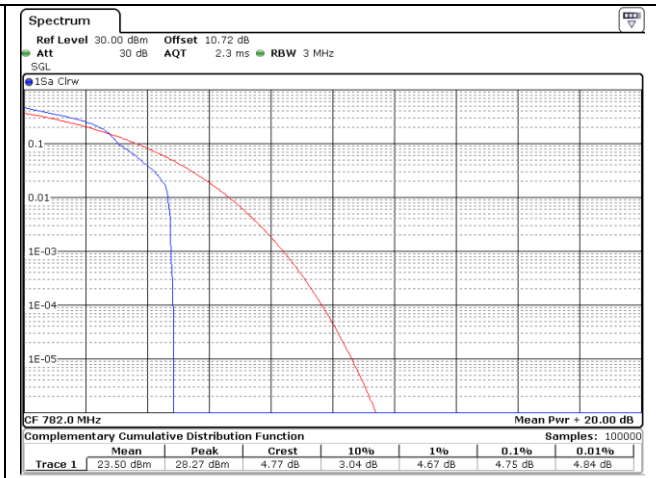
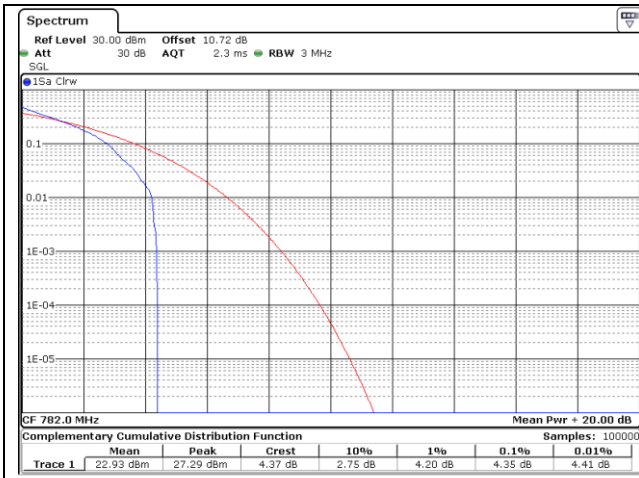

QPSK Middle Channel (1 RB)

QPSK Middle Channel (6 RB)

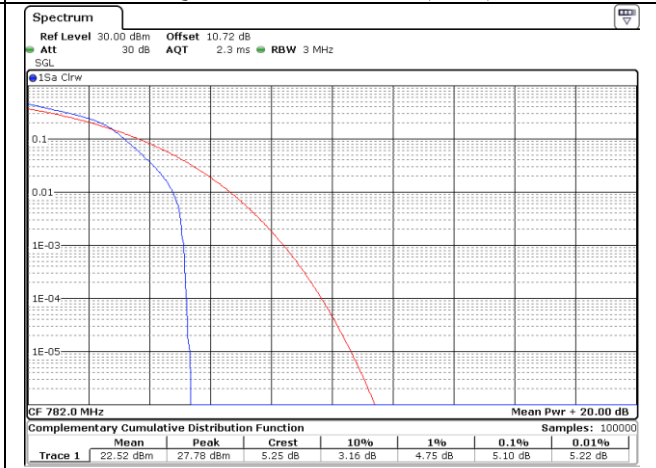
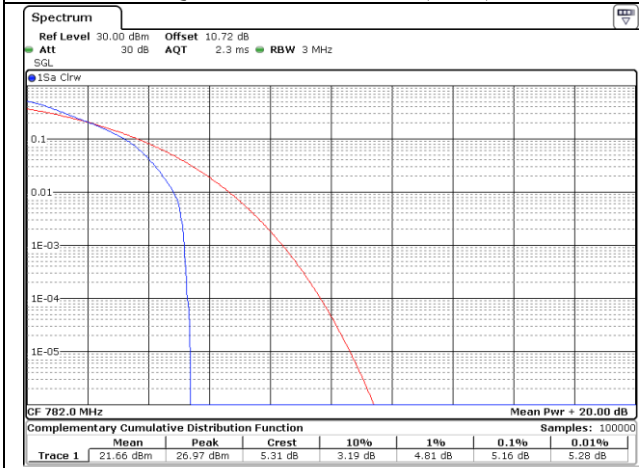

16QAM Middle Channel (1 RB)

16QAM Middle Channel (6 RB)