

ELECTROMAGNETIC EMISSION COMPLIANCE REPORT FOR LICENSED TRANSMITTER

Test Report No. : OT-189-RWD-021
AGR No. : A187A-290
Applicant : Suntech International Ltd.
Address : (Gasam-dong, Greatvally), B-1506, 32, Digital-ro9-gil, Geumchon-gu, Seoul, Korea
Manufacturer : Suntech International Ltd.
Address : (Gasam-dong, Greatvally), B-1506, 32, Digital-ro9-gil, Geumchon-gu, Seoul, Korea
Type of Equipment : Tracking Device
FCC ID. : WA2ST4300
Model Name : ST4300
Serial number : N/A
Total page of Report : 43 pages (including this page)
Date of Incoming : July 20, 2018
Date of issue : September 16, 2018

SUMMARY

The equipment complies with the regulation; **Part 2, Part 22 Subpart H**

This test report only contains the result of a single test of the sample supplied for the examination.

It is not a generally valid assessment of the features of the respective products of the mass-production.

Reviewed by: 

 Jae-Ho Lee / Chief Engineer
 ONETECH Corp.

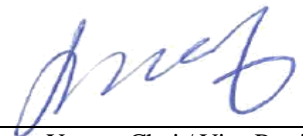
Approved by: 

 Keun-Young, Choi / Vice President
 ONETECH Corp.

CONTENTS

PAGE

1. VERIFICATION OF COMPLIANCE	6
2. TEST SUMMARY	7
2.1 TEST ITEMS AND RESULTS	7
2.2 ADDITIONS, DEVIATIONS, EXCLUSIONS FROM STANDARDS	7
2.3 RELATED SUBMITTAL(S) / GRANT(S)	7
2.4 PURPOSE OF THE TEST	7
2.5 TEST METHODOLOGY	7
2.6 TEST FACILITY	8
3. GENERAL INFORMATION	9
3.1 PRODUCT DESCRIPTION	9
3.2 ALTERNATIVE TYPE(S)/MODEL(S); ALSO COVERED BY THIS TEST REPORT	9
4. EUT MODIFICATIONS	9
5. SYSTEM TEST CONFIGURATION	10
5.1 JUSTIFICATION	10
5.2 PERIPHERAL EQUIPMENT	10
5.3 MODE OF OPERATION DURING THE TEST	11
5.4 FREQUENCY LIST OF LOW/MIDDLE/HIGH CHANNELS	12
5.5 CONFIGURATION OF TEST SYSTEM	13
6. PRELIMINARY TEST	13
6.1 AC POWER LINE CONDUCTED EMISSIONS TESTS	13
6.2 GENERAL RADIATED EMISSIONS TESTS	13
7. CONDUCTED OUTPUT POWER	14
7.1 OPERATING ENVIRONMENT	14
7.2 TEST SET-UP	14
7.3 TEST EQUIPMENT USED	14
7.4 TEST DATA	15
8. EFFECTIVE RADIATED POWER	16
8.1 OPERATING ENVIRONMENT	16
8.2 METHODS OF MEASUREMENT	16
8.3 LIMITS	16
8.4 TEST SET-UP	16

8.5 TEST EQUIPMENT USED.....	17
8.6 TEST DATA FOR QPSK.....	18
8.7 TEST DATA FOR 16QAM.....	18
9. RADIATED SPURIOUS EMISSIONS.....	19
9.1 OPERATING ENVIRONMENT.....	19
9.2 TEST SET-UP.....	19
9.3 TEST EQUIPMENT USED.....	20
9.4 TEST DATA LTE BAND 5 QPSK.....	21
10. PEAK-TO-AVERAGE RATIO.....	22
10.1 OPERATING ENVIRONMENT.....	22
10.2 TEST SET-UP.....	22
10.3 TEST EQUIPMENT USED.....	23
10.4 TEST DATA.....	23
11. OCCUPIED BANDWIDTH.....	26
11.1 OPERATING ENVIRONMENT.....	26
11.2 TEST SET-UP.....	26
11.3 TEST EQUIPMENT USED.....	26
11.4 TEST DATA FOR LTE BAND 5.....	27
12. CONDUCTED BAND EDGE.....	30
12.1 OPERATING ENVIRONMENT.....	30
12.2 TEST SET-UP.....	30
12.3 METHODS OF MEASUREMENT.....	30
12.4 LIMITS.....	30
12.5 TEST EQUIPMENT USED.....	31
12.6 TEST DATA.....	32
12.6.1 Test data for LTE Band 5 QPSK.....	32
12.6.2 Test data for LTE Band 5 16QAM.....	33
13. CONDUCTED SPURIOUS AND HARMONIC EMISSIONS AT ANTENNA TERMINAL.....	34
13.1 OPERATING ENVIRONMENT.....	34
13.2 TEST SET-UP.....	34
13.3 LIMITS.....	34
13.4 TEST EQUIPMENT USED.....	35
13.5 TEST DATA.....	36
13.5.1 Test data for LTE Band 5 QPSK.....	36
13.5.2 Test data for LTE Band 5 16QAM.....	39

14. FREQUENCY STABILITY / VARIATION OF AMBIENT TEMPERATURE	42
14.1 OPERATING ENVIRONMENT	42
14.2 TEST SET-UP	42
14.3 TEST EQUIPMENT USED	42
14.4 TEST DATA	43
<i>14.4.1 Test data for Voltage(V)</i>	<i>43</i>
<i>14.4.2 Test data for Temperature(°C)</i>	<i>43</i>

Revision History

Rev. No.	Issue Report No.	Issued Date	Revisions	Section Affected
0	OT-189-RWD-021	September 16, 2018	Initial Release	All

1. VERIFICATION OF COMPLIANCE

Applicant : Suntech International Ltd.
 Address : (Gasan-dong, Greatvally), B-1506, 32, Digital-ro9-gil, Geumchon-gu, Seoul, Korea
 Contact Person : Yohan Kim / Manager
 Telephone No. : 82-2-6327-5661
 FCC ID : WA2ST4300
 Model Name : ST4300
 Serial Number : N/A
 Date : September 16, 2018

EQUIPMENT CLASS	PCB-PCS Licensed Transmitter
EQUIPMENT DESCRIPTION	Tracking Device
THIS REPORT CONCERNS	Original Grant
MEASUREMENT PROCEDURES	ANSI C63.26:2015, KDB Publication 971168 D01
TYPE OF EQUIPMENT TESTED	Pre-Production
KIND OF EQUIPMENT AUTHORIZATION REQUESTED	Certification
EQUIPMENT WILL BE OPERATED UNDER FCC RULES PART(S)	FCC Part 2, Part 22 Subpart H
Modifications on the Equipment to Achieve Compliance	None
Final Test was Conducted On	3 m Semi Anechoic Chamber

-. The above equipment was tested by ONETECH Corp. for compliance with the requirement set forth in the FCC Rules and Regulations. This said equipment in the configuration described in this report, shows the maximum emission levels emanating from equipment are within the compliance requirements.

2. TEST SUMMARY

2.1 Test items and results

SECTION	TEST ITEMS	RESULTS
2.1049	Occupied Bandwidth	Met the Limit / PASS
2.1051, 22.917(a)	Band Edge / Spurious and Harmonic Emissions at Antenna Terminal	Met the Limit / PASS
2.1046	Conducted Output Power	Met the Limit / PASS
22.913(d), KDB Publication 971168 D01	Peak-to-Average Ratio	Met the Limit / PASS
2.1055, 22.355	Frequency stability	Met the Limit / PASS
22.913(a)(5)	EFFECTIVE RADIATED POWER	Met the Limit / PASS
2.1053, 22.917(a)	Radiated Spurious and Harmonic Emissions	Met the Limit / PASS

2.2 Additions, deviations, exclusions from standards

No additions, deviations or exclusions have been made from standard.

2.3 Related Submittal(s) / Grant(s)

Original submittal only

2.4 Purpose of the test

To determine whether the equipment under test fulfills the requirements of the regulation stated in Part 22 Subpart H.

2.5 Test Methodology

Both conducted and radiated testing was performed according to the procedures in ANSI C63.26:2015. Radiated testing was performed at a distance of 3 m from EUT to the antenna.

2.6 Test Facility

The Onetech Corp. has been designated to perform equipment testing in compliance with ISO/IEC 17025.

The Electromagnetic compatibility measurement facilities are located at 43-14, Jinsaegol-gil, Chowol-eup, Gwangju-si, Gyeonggi-do, 12735, Korea

-. Site Filing:

VCCI (Voluntary Control Council for Interference) – Registration No. R-4112/ C-14617/ G-10666 / T-1842

IC (Industry Canada) – Registration No. Site# 3736A-3

-. Site Accreditation:

KOLAS (Korea Laboratory Accreditation Scheme) - Accreditation NO. KT085

FCC (Federal Communications Commission) - Accreditation No. KR0013

RRA (Radio Research Agency) – Designation No. KR0013

3. GENERAL INFORMATION

3.1 Product Description

The Suntech International Ltd., Model ST4300 (referred to as the EUT in this report) is a Tracking Device. Product specification information described herein was obtained from product data sheet or user’s manual.

DEVICE TYPE	Tracking Device			
OPERATING FREQUENCY	LTE Band 2	TX	1 850 MHz ~ 1 910 MHz	
		RX	1 930 MHz ~ 1 990 MHz	
	LTE Band 4	TX	1 710 MHz ~ 1 755 MHz	
		RX	2 110 MHz ~ 2 155 MHz	
	LTE Band 5	TX	824 MHz ~ 849 MHz	
		RX	869 MHz ~ 894 MHz	
	LTE Band 12	TX	699 MHz ~ 716 MHz	
		RX	729 MHz ~ 746 MHz	
	LTE Band 13	TX	777 MHz ~ 787 MHz	
		RX	746 MHz ~ 756 MHz	
	LTE Channel Bandwidth	10 MHz		
	Modulation Type	QPSK, 16QAM		
Maximum ERP Power	LTE Band 5	21.16 dBm		
ANTENNA TYPE	PIFA Antenna			
ANTENNA GAIN	LTE Band 2	1.50 dBi		
	LTE Band 4	1.47 dBi		
	LTE Band 5	0.74 dBi		
	LTE Band 12	-0.84 dBi		
	LTE Band 13	0.52 dBi		
List of each Osc. or crystal Freq.(Freq. >= 1 MHz)	26 MHz			

3.2 Alternative type(s)/model(s); also covered by this test report.

-. None

4. EUT MODIFICATIONS

-. None

5. SYSTEM TEST CONFIGURATION

5.1 Justification

This device was configured for testing in a typical way as a normal customer is supposed to be used. During the test, the following components were installed inside of the EUT.

DEVICE TYPE	MANUFACTURER	MODEL/PART NUMBER	FCC ID
Main Board	N/A	N/A	N/A
Battery	N/A	N/A	N/A
Antenna	N/A	N/A	N/A

5.2 Peripheral equipment

Defined as equipment needed for correct operation of the EUT, but not considered as tested:

Model	Manufacturer	Description	Connected to
PWS-3003D	Protek	DC Power Supply	EUT

5.3 Mode of operation during the test

Pre-Scan has been conducted to determine the worst-case mode from all possible combinations between available modulations, data rates, XYZ axis, and antenna ports. The worst case was found when positioned as the table below.

Following channel(s) was (were) selected for the final test as listed below:

Band	EIRP	Radiated Emission
LTE Band 5	X-plane	X-axis

Test Mode : LTE Band 5

Test Item	Channel Bandwidth	Modulation	Mode	Test Channel
Conducted Output Power	10 MHz	QPSK, 16QAM	1 RB / 0 RB Offset / 0 RB Index	829 MHz 836.5 MHz 844 MHz
			1 RB / 5 RB Offset / 0 RB Index	
			1 RB / 0 RB Offset / 3 RB Index	
			1 RB / 5 RB Offset / 3 RB Index	
			1 RB / 0 RB Offset / 7 RB Index	
			1 RB / 5 RB Offset / 7 RB Index	
			4 RB / 0 RB Offset / 0 RB Index	
			4 RB / 2 RB Offset / 7 RB Index	
			6 RB / 0 RB Offset / 0 RB Index	
			6 RB / 0 RB Offset / 7 RB Index	
Equivalent Isotropic Radiated Power	10 MHz	QPSK, 16QAM	1 RB / 0 RB Offset / 0 RB Index	829 MHz
				836.5 MHz
				844 MHz
Frequency stability	10 MHz	QPSK	1 RB / 0 RB Offset / 0 RB Index	836.5 MHz

Test Item	Channel Bandwidth	Modulation	Mode	Test Channel
Peak-to-Average Ratio	10 MHz	QPSK, 16QAM	1 RB / 0 RB Offset / 0 RB Index	829 MHz
			6 RB / 0 RB Offset / 0 RB Index	836.5 MHz
				844 MHz
Band Edge	10 MHz	QPSK, 16QAM	1 RB / 0 RB Offset / 0 RB Index	829 MHz
			6 RB / 0 RB Offset / 0 RB Index	
			1 RB / 5 RB Offset / 0 RB Index	844 MHz
			6 RB / 5 RB Offset / 0 RB Index	
Spurious and Harmonic Emissions at Antenna Terminal	10 MHz	QPSK, 16QAM	1 RB / 0 RB Offset / 0 RB Index	829 MHz
				836.5 MHz
				844 MHz
Radiated Spurious and Harmonic Emissions	10 MHz	QPSK, 16QAM	1 RB / 0 RB Offset / 0 RB Index	829 MHz
				836.5 MHz
				844 MHz

5.4 Frequency List of Low/Middle/High Channels

LTE Band 5 Channel and Frequency List				
Bandwidth	Channel / Frequency	Low	Middle	High
10 MHz	Channel	20450	20525	20600
	Frequency	829 MHz	836.5 MHz	844 MHz

5.5 Configuration of Test System

Radiated Emission Test: Preliminary radiated emissions test were conducted using the procedure in ANSI C63.10: 2013 to determine the worse operating conditions. Final radiated emission tests were conducted at 3 m Semi Anechoic Chamber.

The turntable was rotated through 360 degrees and the EUT was tested by positioned three orthogonal planes to obtain the highest reading on the field strength meter. Once maximum reading was determined, the search antenna was raised and lowered in both vertical and horizontal polarization.

6. PRELIMINARY TEST

6.1 AC Power line Conducted Emissions Tests

As this product is only using DC power, AC conducted emission test has not been performed.

6.2 General Radiated Emissions Tests

During Preliminary Test, the following operating mode was investigated.

Operation Mode	The Worse operating condition (Please check one only)
Transmitting Mode	X

7. CONDUCTED OUTPUT POWER

7.1 Operating environment

Temperature : 24 °C
 Relative humidity : 47 % R.H.

7.2 Test set-up

Conducted Output Power is tested in accordance with KDB971168 D01 Power Meas License Digital Systems v04, April 9, 2018, Section 5.2.

A base station simulator was used to establish communication with the EUT, and Spectrum analyzer was used for test results. This device was tested under all configurations and the highest power is reported. Conducted Output Powers of EUT are reported below.

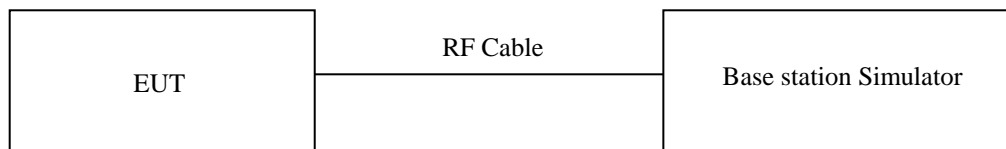

7.3 Test equipment used

Model Number	Manufacturer	Description	Serial Number	Last Cal.
■ - MT8821C	ANRITSU	Radio Communication Analyzer	6261849029	Aug. 22, 2018 (1Y)
■ - PWS-3003D	Protek	DC Power Supply	4020409	Aug. 24, 2018 (1Y)

All test equipment used is calibrated on a regular basis.

7.4 Test data

- Test Date : July 26, 2018 ~ September 07, 2018
 - Test Result : Pass

Conducted Average Output Power (dBm)

Band / Bandwidth	RB Size	RB Offset	RB Index	QPSK			16QAM		
				LOW	MIDDLE	HIGH	LOW	MIDDLE	HIGH
				829 MHz	836.5 MHz	844 MHz	829 MHz	836.5 MHz	844 MHz
Band 5 / 10 MHz	1	0	0	23.21	23.26	23.29	22.54	22.61	22.63
	1	5	0	23.15	23.09	23.22	22.47	22.52	22.55
	1	0	3	23.15	23.10	23.19	22.39	22.43	22.53
	1	5	3	23.05	23.10	23.22	22.38	22.46	22.50
	1	0	7	23.05	23.10	23.20	22.49	22.52	22.56
	1	5	7	23.06	23.09	23.19	22.48	22.50	22.58
	4	0	0	23.04	23.16	23.18	22.44	22.51	22.52
	4	2	7	23.04	23.16	23.17	22.47	22.53	22.54
	6	0	0	22.27	22.31	22.30	21.18	21.08	21.15
	6	0	7	22.25	22.29	22.90	21.16	21.06	21.13



Tested by: Ju Yun Park / Assistant Manager

8. EFFECTIVE RADIATED POWER

8.1 Operating environment

Temperature : 25 °C
 Relative humidity : 46 % R.H.

8.2 Methods of Measurement

1. The testing follows ANSI C63.26 (2015) Section 5.5.3.
2. Substitution method is used for E.I.R.P measurement. In the semi-anechoic chamber, EUT placed on the 0.8 m (below or equal 1 GHz) and/or 1.5 m (above 1 GHz) height of Turn Table, rotated the table around 360 degrees to search the maximum radiation power and receiver antenna shall be rotated vertical and horizontal polarization and moved height from 1 m to 4 m to find the maximum polar radiated power. The “Read Value” is the spectrum reading the maximum power value.
3. The substitution antenna is substituted for EUT at the same position and signals generator export the CW signal to the substitution antenna via a tx cable. Rotated the Turn Table and moved receiving antenna to find the maximum radiation power. Adjust output power level of S.G to get a Value of spectrum reading equal to “Read Value” of step 2. Record the power level of S.G.
4. $EIRP = \text{Output power level of S.G} - \text{TX cable loss} + \text{Antenna gain of substitution antenna power}$ can be Calculated. $E.R.P \text{ power} = E.I.P.R \text{ power} - 2.15 \text{ dBi}$.

8.3 Limits

Rule Part 22.913(a).5 specifies that “mobile transmitters and auxiliary test transmitters must not exceed 7 watts.”

Limit	7 W (38.45 dBm)
-------	-----------------

8.4 Test set-up

The EUT and measurement equipment were set up as shown in the diagram below.

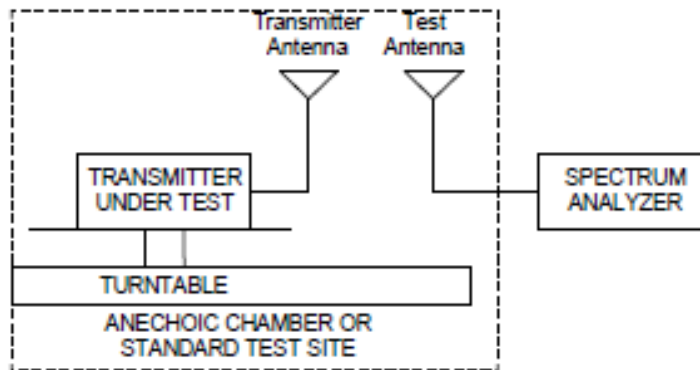

8.5 Test equipment used

	Model Number	Manufacturer	Description	Serial Number	Last Cal. (Interval)
□ -	ESCI	Rohde & Schwarz	EMI Test Receiver	101012	Oct. 27, 2017 (1Y)
■ -	ESR	Rohde & Schwarz	EMI Test Receiver	101470	Oct. 27, 2017 (1Y)
■ -	310N	Sonoma Instrument	AMPLIFIER	312544	Mar. 28, 2018 (1Y)
■ -	FSV30	Rohde & Schwarz	Signal Analyzer	101200	Aug. 23, 2018 (1Y)
■ -	BBV9718B	Schwarzbeck	Broadband Preamplifier	009	Mar. 16, 2018 (1Y)
■ -	SCU-03	Rohde & Schwarz	Signal Conditioning Unit	100333	Mar. 15, 2018 (1Y)
□ -	SCU-18	Rohde & Schwarz	Pre-Amplifier	102346	Oct. 24, 2017 (1Y)
■ -	MA-4000XPET	Innco Systems GmbH	Antenna Master	MA4000/509	N/A
□ -	HD100	HD GmbH	Position Controller	N/A	N/A
■ -	DT3000-3t	Innco Systems GmbH	Turn Table	N/A	N/A
□ -	FMZB 1513	Schwarzbeck	LOOP ANTENNA	1513-235	May. 13, 2018 (2Y)
■ -	VULB9163	Schwarzbeck	TRILOG Broadband Antenna	9163-255	Jun 05, 2018 (2Y)
■ -	VULB9163	Schwarzbeck	Hybrid Antenna	777	Apr. 13, 2018 (2Y)
■ -	BBHA9120D	Schwarzbeck	Horn Antenna	BBHA9120D295	Aug. 16, 2017 (2Y)
■ -	BBHA9170	Schwarzbeck	Horn Antenna	BBHA91700179	Jul. 28, 2017 (2Y)
□ -	SCU40A	Rohde & Schwarz	Pre-Amplifier	100436	Mar. 15, 2018 (1Y)
■ -	MT8821C	ANRITSU	Radio Communication Analyzer	6261849029	Aug. 22, 2018 (1Y)
□ -	ESCI	Rohde & Schwarz	EMI Test Receiver	101012	Oct. 27, 2017 (1Y)

All test equipment used is calibrated on a regular basis.

8.6 Test data for QPSK

-. Test Date : July 26, 2018 ~ September 07, 2018

-. Test Result : Pass

Frequency (MHz)	Substituted Level (dBm)	Ant. Pol. (H/V)	Cable Loss (dB)	Ant Gain (dBd)	ERP (dBm)	Limits (dBm)	Margin (dB)
Test Data for QPSK							
829.0	16.56	H	0.75	5.35	21.16	38.45	17.29
829.0	14.89	V	0.75	5.35	19.49	38.45	18.96
836.5	15.80	H	0.75	5.25	20.30	38.45	18.15
836.5	13.82	V	0.75	5.25	18.32	38.45	20.13
844.0	16.24	H	0.77	5.05	20.52	38.45	17.93
844.0	13.63	V	0.77	5.05	17.91	38.45	20.54

Remark: "H": Horizontal, "V": Vertical

8.7 Test data for 16QAM

-. Test Date : July 26, 2018 ~ September 07, 2018

-. Test Result : Pass

Frequency (MHz)	Substituted Level (dBm)	Ant. Pol. (H/V)	Cable Loss (dB)	Ant Gain (dBd)	ERP (dBm)	Limits (dBm)	Margin (dB)
Test Data for 16QAM							
829.0	16.06	H	0.75	5.35	20.66	38.45	17.79
829.0	13.99	V	0.75	5.35	18.59	38.45	19.86
836.5	15.19	H	0.75	5.25	19.69	38.45	18.76
836.5	13.05	V	0.75	5.25	17.55	38.45	20.90
844.0	15.79	H	0.77	5.05	20.07	38.45	18.38
844.0	13.11	V	0.77	5.05	17.39	38.45	21.06

Remark: "H": Horizontal, "V": Vertical

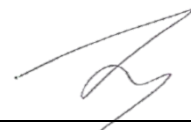

Tested by: Ju Yun Park / Assistant Manager

9. RADIATED SPURIOUS EMISSIONS

9.1 Operating environment

Temperature : 25 °C
 Relative humidity : 46 % R.H.

9.2 Test set-up

Radiated emission measurements are performed in the Semi-Anechoic chamber. The equipment under test is placed on a non-conductive table 3-meters away from the receive antenna in accordance with ANSI C63.26 (2015) Section 5.5.3. The turntable is rotated through 360°, and the receiving antenna scans in order to determine the level of the maximized emission. The level and position of the maximized emission is recorded with the spectrum analyzer using RMS detector. A vertically polarized half-wave dipole is then substituted in place of the EUT. For emissions above 1GHz, a horn antenna is substituted in place of the EUT. The substitute antenna is driven by a signal generator and the previously recorded signal was duplicated.

The power is calculated by the following formula;

$$Pd(\text{dBm}) = Pg(\text{dBm}) - \text{cable loss (dB)} + \text{antenna gain (dB)}$$

Where: Pd is the dipole equivalent power and Pg is the generator output power into the substitution antenna.

The maximum EIRP is calculated by adding the forward power to the calibrated source plus its appropriate gain value. These steps are repeated with the receiving antenna in both vertical and horizontal polarization. the difference between the gain of the horn and an isotropic antenna are taken into consideration

Limits

Rule Part 22.917(a) specifies that “The power of any emission outside of the authorized operating frequency ranges must be attenuated below the transmitting power (P) by a factor of at least 43 + 10 log(P) dB.”

$$\begin{aligned} &= P(W) - [43 + 10\log(P)](\text{dB}) \\ &= [30+10\text{Log}(P)] (\text{dBm}) - [43 + 10\log(P)](\text{dB}) \\ &= -13 \text{ dBm} \end{aligned}$$

Limit	-13 dBm
-------	---------

Radiated spurious emissions

1. Frequency Range : 9 kHz ~ 10th Harmonics of highest channel fundamental frequency.
 2. The EUT was setup to maximum output power. The 100 kHz RBW was used to scan from 30 MHz to 1 GHz.
- Also, the 1 MHz RBW was used to scan from 1 GHz to 10 GHz. The high, low and a middle channel were tested for out of band measurements.

9.3 Test equipment used

	Model Number	Manufacturer	Description	Serial Number	Last Cal. (Interval)
<input type="checkbox"/>	ESCI	Rohde & Schwarz	EMI Test Receiver	101012	Oct. 27, 2017 (1Y)
<input checked="" type="checkbox"/>	ESR	Rohde & Schwarz	EMI Test Receiver	101470	Oct. 27, 2017 (1Y)
<input checked="" type="checkbox"/>	310N	Sonoma Instrument	AMPLIFIER	312544	Mar. 28, 2018 (1Y)
<input checked="" type="checkbox"/>	SCU-03	Rohde & Schwarz	Signal Conditioning Unit	100333	Mar. 15, 2018 (1Y)
<input checked="" type="checkbox"/>	FSV30	Rohde & Schwarz	Signal Analyzer	101200	Aug. 23, 2018 (1Y)
<input checked="" type="checkbox"/>	BBV9718B	Schwarzbeck	Broadband Preamplifier	009	Mar. 16, 2018 (1Y)
<input checked="" type="checkbox"/>	SCU-18	Rohde & Schwarz	Pre-Amplifier	102346	Oct. 24, 2017 (1Y)
<input checked="" type="checkbox"/>	MA-4000XPET	Innco Systems GmbH	Antenna Master	MA4000/509	N/A
<input type="checkbox"/>	HD100	HD GmbH	Position Controller	N/A	N/A
<input checked="" type="checkbox"/>	DT3000-3t	Innco Systems GmbH	Turn Table	N/A	N/A
<input type="checkbox"/>	FMZB 1513	Schwarzbeck	LOOP ANTENNA	1513-235	May. 13, 2018 (2Y)
<input checked="" type="checkbox"/>	VULB9163	Schwarzbeck	TRILOG Broadband Antenna	9163-255	Jun 05, 2018 (2Y)
<input checked="" type="checkbox"/>	VULB9163	Schwarzbeck	Hybrid Antenna	777	Apr, 13, 2018 (2Y)
<input checked="" type="checkbox"/>	BBHA9120D	Schwarzbeck	Horn Antenna	BBHA9120D295	Aug. 16, 2017 (2Y)
<input checked="" type="checkbox"/>	BBHA9170	Schwarzbeck	Horn Antenna	BBHA91700179	Jul. 28, 2017 (2Y)
<input type="checkbox"/>	SCU40A	Rohde & Schwarz	Pre-Amplifier	100436	Mar. 15, 2018 (1Y)
<input checked="" type="checkbox"/>	MT8821C	ANRITSU	Radio Communication Analyzer	6261849029	Aug. 22, 2018 (1Y)
<input type="checkbox"/>	ESCI	Rohde & Schwarz	EMI Test Receiver	101012	Oct. 27, 2017 (1Y)

All test equipment used is calibrated on a regular basis.

9.4 Test data LTE Band 5 QPSK

- Test Date : July 16, 2018 ~ August 14, 2018
- Detector : RMS
- Measurement distance : 3 m
- Result : PASSED

Frequency (MHz)	Substituted Level (dBm)	Ant. Pol. (H/V)	Cable Loss (dB)	Ant Gain (dBi)	Corrected Reading (dBm)	Limits (dBm)	Margin (dB)
Test Data for Low Channel							
1 658.00	-68.45	H	1.08	7.20	-62.33	-13.00	49.33
2 487.00	-57.34	H	1.62	5.70	-53.26	-13.00	40.26
3 316.00	-80.25	V	2.44	12.51	-70.18	-13.00	57.18
4 145.00	-79.92	V	2.19	12.14	-69.97	-13.00	56.97
4 974.00	-78.20	H	2.37	12.73	-67.84	-13.00	54.84
Test Data for Middle Channel							
1 673.00	-68.68	H	1.08	7.20	-62.56	-13.00	49.56
2 509.50	-57.98	H	1.62	5.70	-53.90	-13.00	40.90
3 346.00	-80.44	V	2.44	12.51	-70.37	-13.00	57.37
4 182.50	-79.99	V	2.19	12.14	-70.04	-13.00	57.04
5 019.00	-78.30	H	2.37	12.73	-67.94	-13.00	54.94
Test Data for High Channel							
1 688.00	-68.48	H	1.08	7.20	-62.36	-13.00	49.36
2 532.00	-57.03	H	1.62	5.70	-52.95	-13.00	39.95
3 376.00	-80.01	V	2.44	12.51	-69.94	-13.00	56.94
4 220.00	-79.82	V	2.19	12.14	-69.87	-13.00	56.87
5 064.00	-78.15	H	2.37	12.73	-67.79	-13.00	54.79

Remark: 1. The other Spurious RF Radiated emissions level is no more than noise floor.
 2. The worst case was found in QPSK modulation
 3. Rule Part 22.917(a) specifies that “The power of any emission outside of the authorized operating frequency ranges must be attenuated below the transmitting power (P) by a factor of at least $43 + 10 \log(P)$ dB.”
 Limit : $38.45 - 43 + 10 \log(7.00) = -13$ dBm
 “C.L” : Cable Loss, “H”: Horizontal, “V”: Vertical



Tested by: Ju Yun Park / Assistant Manager

10. PEAK-TO-AVERAGE RATIO

10.1 Operating environment

Temperature : 24 °C
 Relative humidity : 47 % R.H.

10.2 Test set-up

Peak to Average Power Ratio is tested in accordance with KDB971168 D01 Power Meas License Digital Systems v04, April 9, 2018, Section 5.7.

- Section 5.7.2 Measurement of peak power in a broadband noise-like signal using CCDF

- a) Set resolution/measurement bandwidth \geq OBW or specified reference bandwidth.
- b) Set the number of counts to a value that stabilizes the measured CCDF curve.
- c) Set the measurement interval as follows:
 - 1) For continuous transmissions, set to the greater of $[10 \times (\text{number of points in sweep}) \times (\text{transmission symbol period})]$ or 1 ms.
 - 2) For burst transmissions, employ an external trigger that is synchronized with the EUT burst timing sequence, or use the internal burst trigger with a trigger level that allows the burst to stabilize. Set the measurement interval to a time that is less than or equal to the burst duration.
 - 3) If there are several carriers in a single antenna port, the peak power shall be determined for each individual carrier (by disabling the other carriers while measuring the required carrier) and the total peak power calculated from the sum of the individual carrier peak powers.
- d) Record the maximum PAPR level associated with a probability of 0.1%.
- e) The peak power level is calculated from the sum of the PAPR value from step d) to the measured average power.

- Section 5.7.3 Alternate Procedure for PAPR

Some regulatory requirements specify a PAPR limit when the output power limits are specified in terms of average power. If it becomes necessary to provide measurement data to demonstrate compliance to a PAPR limit, then the appropriate procedure from those provided in 5.2.3 shall be utilized to determine the peak power (or peak PSD) and the appropriate procedure from those provided in 5.2.4 shall be used to determine the average power (or average PSD). The data from these measurements is then used in Equation (2) to determine the PAPR of a narrowband CW-like signal. See 5.2.3.4 for guidance on determining the PAPR of a broadband noise-like signal.

$$\text{PAPR (dB)} = P_{\text{Pk}} \text{ (dBm or dBW)} - P_{\text{Avg}} \text{ (dBm or dBW)}$$

where

PAPR peak-to-average power ratio, in dB

P_{Pk} measured peak power or peak PSD level, in dBm or dBW

P_{Avg} measured average power or average PSD level, in dBm or dBW

10.3 Test equipment used

Model Number	Manufacturer	Description	Serial Number	Last Cal.
■ - FSV30	Rohde & Schwarz	Signal Analyzer	101200	Aug. 23, 2018 (1Y)
■ - AAMCS-UDC	AA-MCS	Directional Coupler	400	Aug. 23, 2018 (1Y)
■ - MT8821C	ANRITSU	Radio Communication Analyzer	6261849029	Aug. 22, 2018 (1Y)
■ - PWS-3003D	Protek	DC Power Supply	4020409	Aug. 24, 2018 (1Y)

All test equipment used is calibrated on a regular basis.

10.4 Test data

- Test Date : July 26, 2018 ~ September 07, 2018

- Test Result : Pass

LTE Band 5 QPSK

Test Mode	Channel	Peak-Average Ratio(PAR) CCDF 0.1 %	Limit (dB)	Result
1 RB	20450	4.43	13.00	PASS
	20525	4.87	13.00	PASS
	20600	4.55	13.00	PASS
6 RB	20450	5.22	13.00	PASS
	20525	4.78	13.00	PASS
	20600	4.93	13.00	PASS

Remark: Measured the using CCDFof spectrum analyzer.

LTE Band 5 16QAM

Test Mode	Channel	Peak-Average Ratio(PAR) CCDF 0.1 %	Limit (dB)	Result
1 RB	20450	5.28	13.00	PASS
	20525	5.22	13.00	PASS
	20600	5.77	13.00	PASS
6 RB	20450	5.77	13.00	PASS
	20525	5.74	13.00	PASS
	20600	5.65	13.00	PASS

Remark: Measured the using CCDFof spectrum analyzer.



Tested by: Ju Yun Park / Assistant Manager

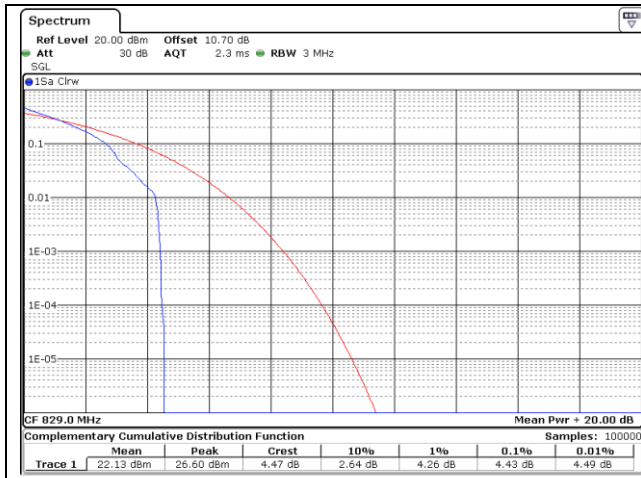

QPSK Low Channel (1 RB)

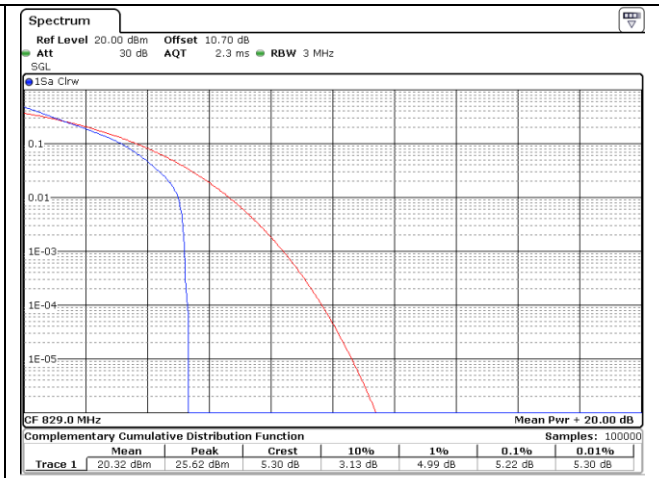

QPSK Low Channel (6 RB)

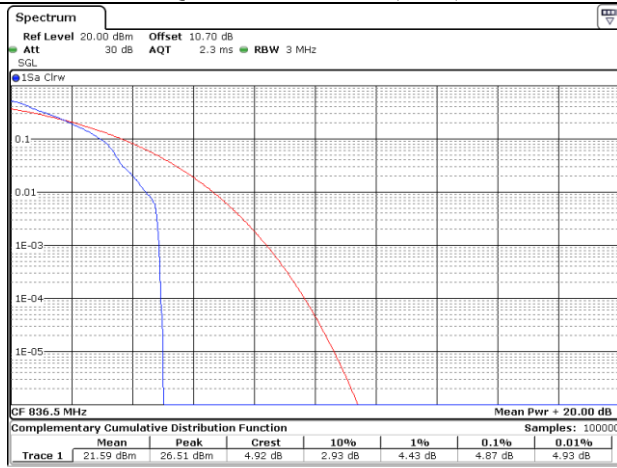

QPSK Middle Channel (1 RB)

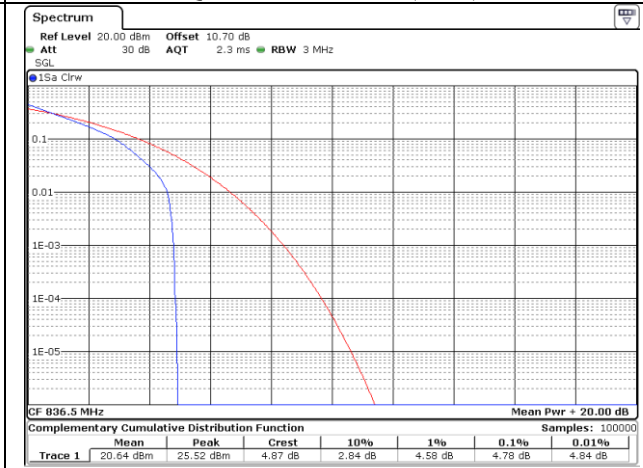

QPSK Middle Channel (6 RB)

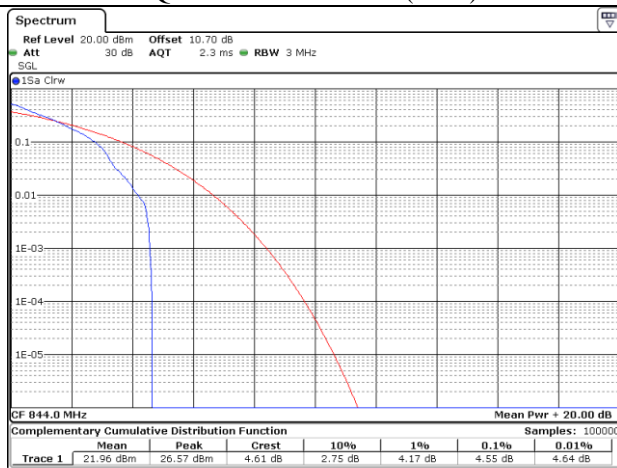

QPSK High Channel (1 RB)

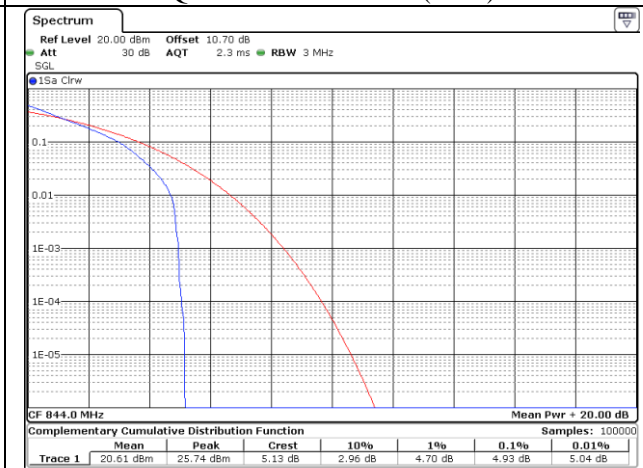

QPSK High Channel (6 RB)

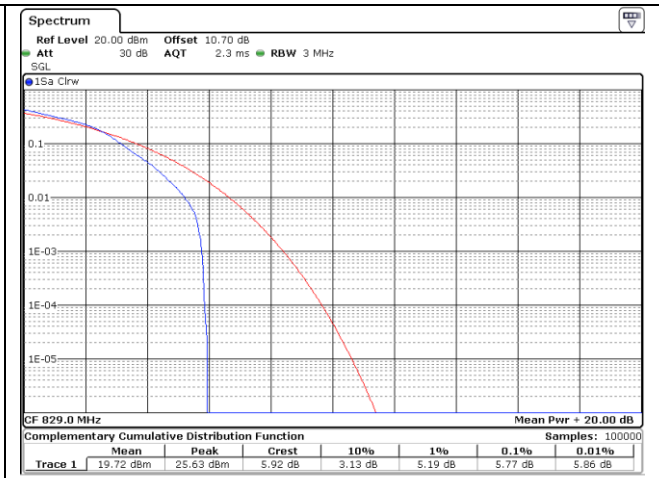
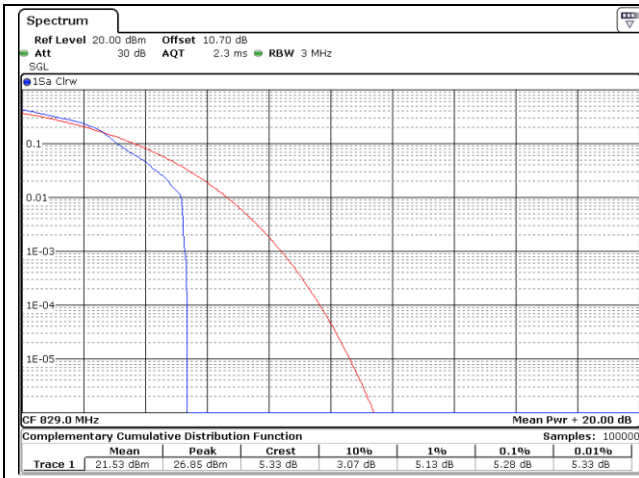

16QAM Low Channel (1 RB)

16QAM Low Channel (6 RB)

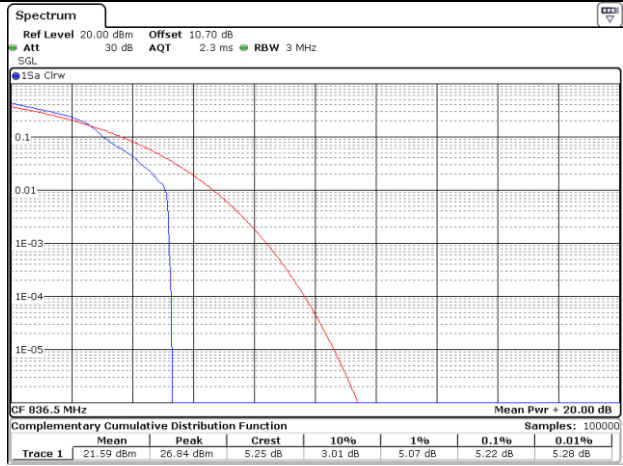

16QAM Middle Channel (1 RB)

16QAM Middle Channel (6 RB)

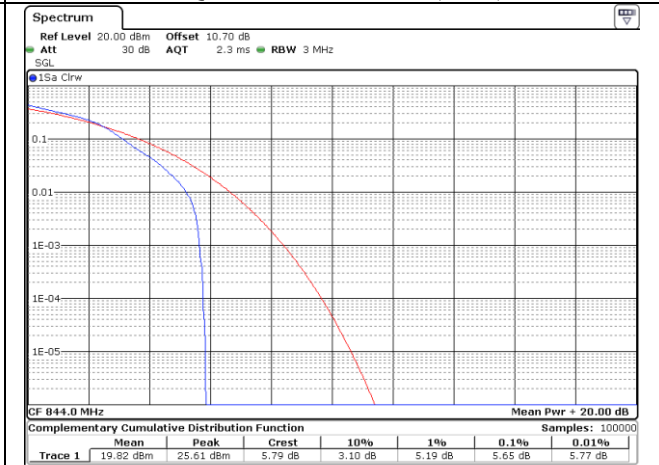
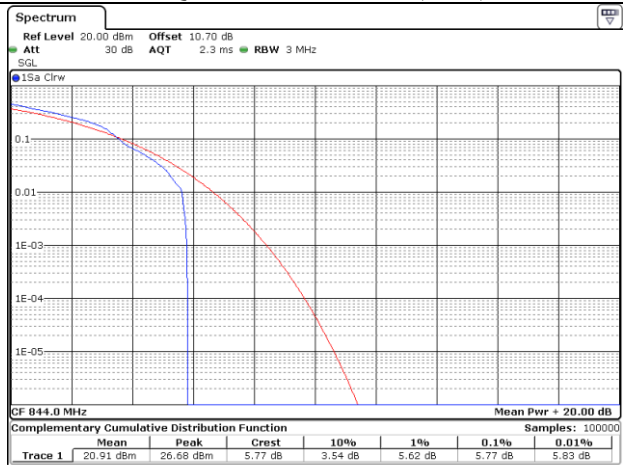

16QAM High Channel (1 RB)

16QAM High Channel (6 RB)

11. OCCUPIED BANDWIDTH

11.1 Operating environment

Temperature : 24 °C
 Relative humidity : 47 % R.H.

11.2 Test set-up

The emission bandwidth (×dB) is defined as the frequency range between two points, one above and one below the carrier frequency, at which the spectral density of the emission is attenuated × dB below the maximum in-band spectral density of the modulated signal. Spectral density (power per unit bandwidth) is to be measured with a detector of resolution bandwidth in the range of 1% to 5% of the anticipated emission bandwidth, and a video bandwidth at least 3× the resolution bandwidth. When the occupied bandwidth limit is not stated in the applicable RSS or reference measurement method, the transmitted signal bandwidth shall be reported as the 99% emission bandwidth, as calculated or measured.

- The transmitter shall be operated at its maximum carrier power measured under normal test conditions.
- The span of the analyzer shall be set to capture all products of the modulation process, including the emission skirts.
- The resolution bandwidth (RBW) shall be in the range of 1% to 5% of the occupied bandwidth (OBW) and video bandwidth (VBW) shall be approximately 3×RBW.

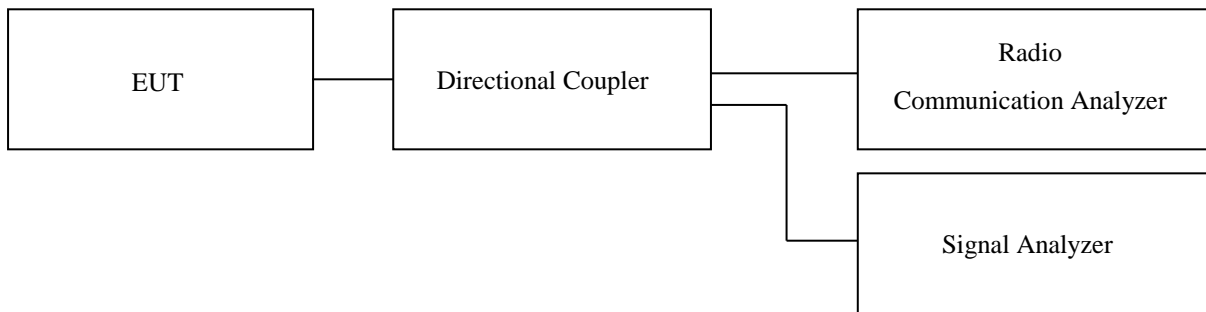

11.3 Test equipment used

Model Number	Manufacturer	Description	Serial Number	Last Cal.
■ - FSV30	Rohde & Schwarz	Signal Analyzer	101200	Aug. 23, 2018 (1Y)
■ - AAMCS-UDC	AA-MCS	Directional Coupler	400	Aug. 23, 2018 (1Y)
■ - MT8821C	ANRITSU	Radio Communication Analyzer	6261849029	Aug. 22, 2018 (1Y)
■ - PWS-3003D	Protek	DC Power Supply	4020409	Aug. 24, 2018 (1Y)

All test equipment used is calibrated on a regular basis.

11.4 Test data for LTE Band 5

- Test Date : July 26, 2018 ~ September 07, 2018

- Test Result : Pass

Test Mode	Channel	26 dB Bandwidth (MHz)	99 % Occupied Bandwidth (MHz)	Result
QPSK	Low	1.558	1.138	PASS
	Middle	1.558	1.138	PASS
	High	1.558	1.138	PASS

Test Mode	Channel	26 dB Bandwidth (MHz)	99 % Occupied Bandwidth (MHz)	Result
16QAM	Low	1.678	1.178	PASS
	Middle	1.658	1.158	PASS
	High	1.678	1.178	PASS



Tested by: Ju Yun Park / Assistant Manager

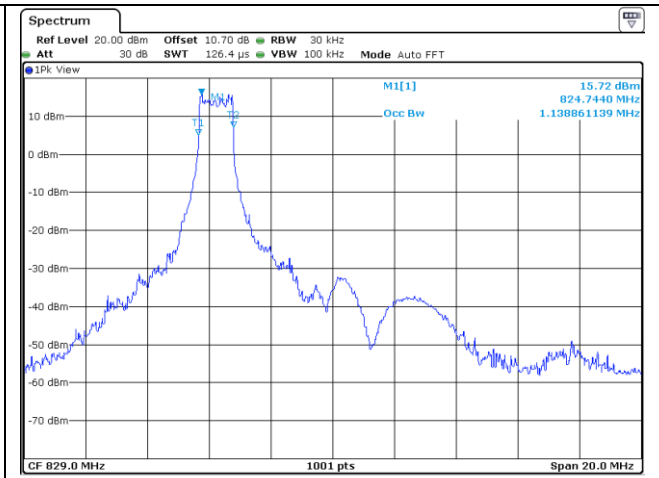
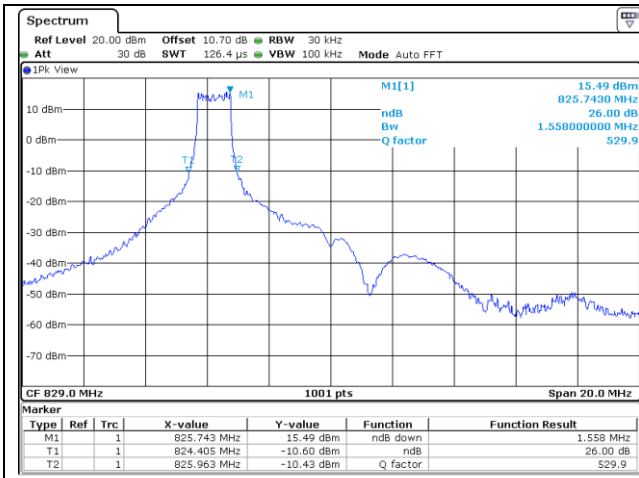

QPSK Low Channel (26 dB Bandwidth)

QPSK Low Channel (99 % Occupied Bandwidth)

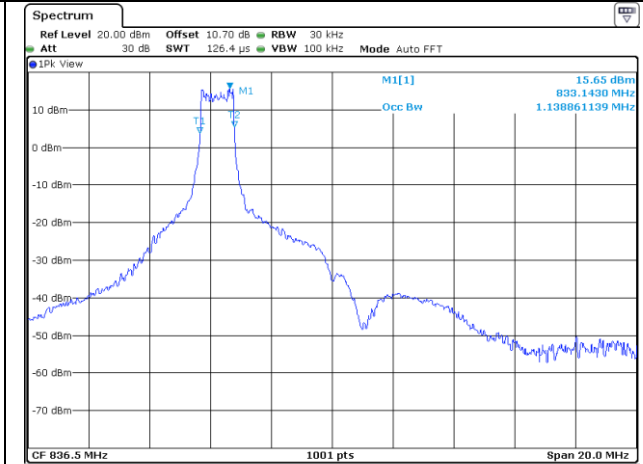
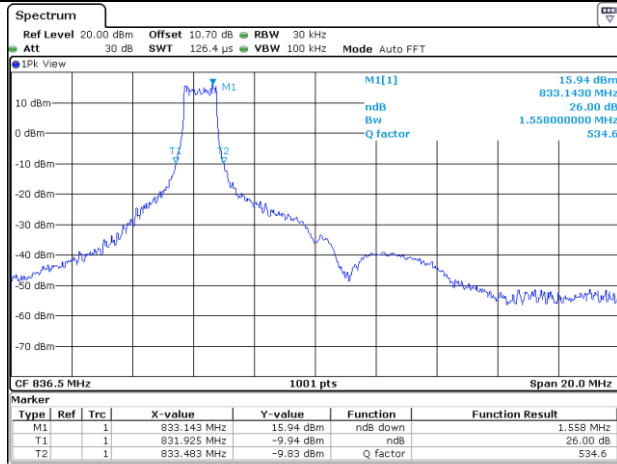

QPSK Middle Channel (26 dB Bandwidth)

QPSK Middle Channel (99 % Occupied Bandwidth)

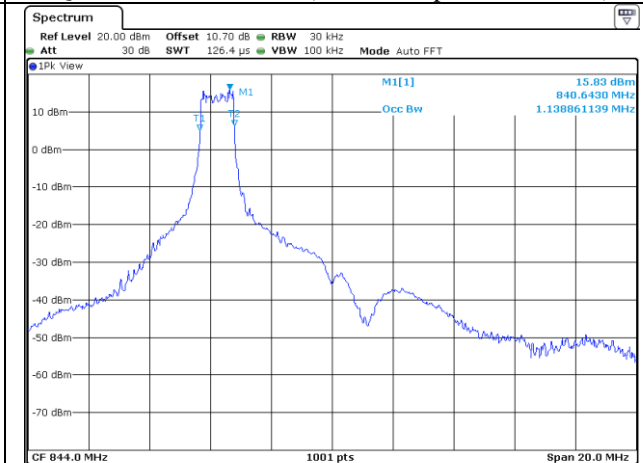
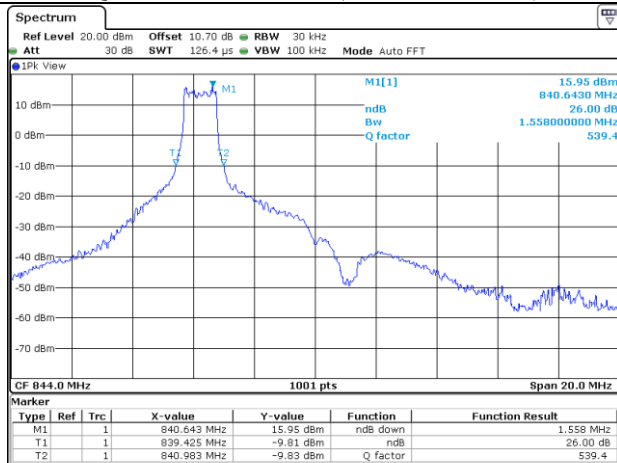

QPSK High Channel (26 dB Bandwidth)

QPSK High Channel (99 % Occupied Bandwidth)

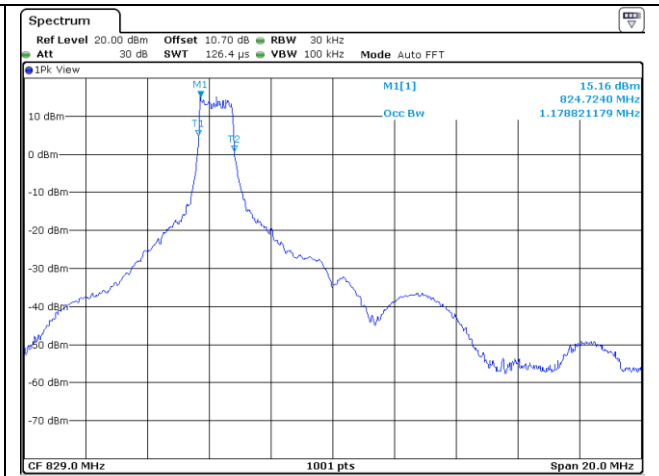
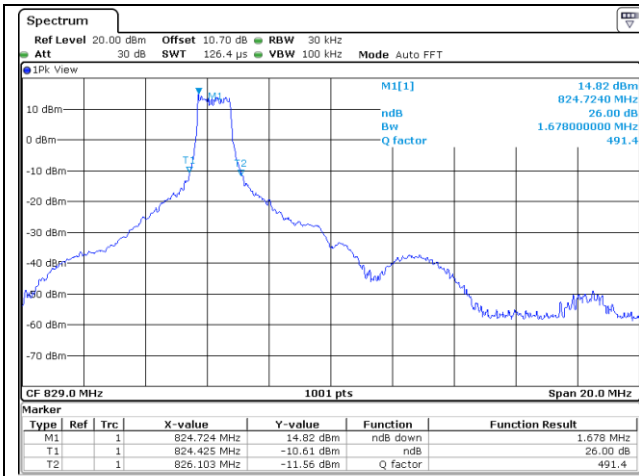

16QAM Low Channel (26 dB Bandwidth)

16QAM Low Channel (99 % Occupied Bandwidth)

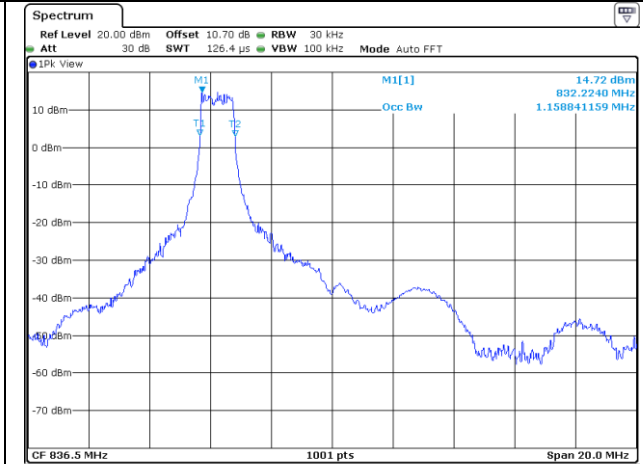
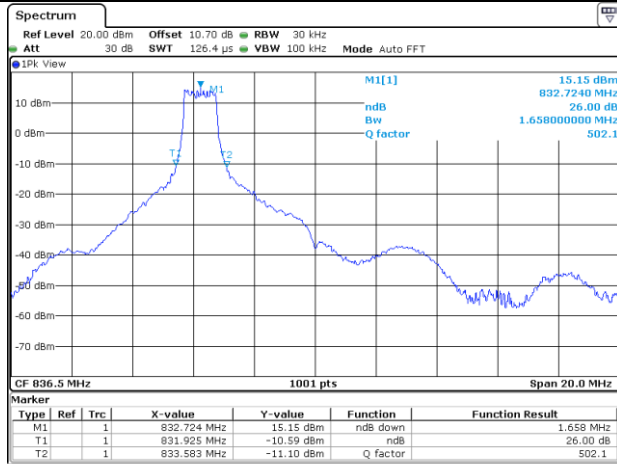

16QAM Middle Channel (26 dB Bandwidth)

16QAM Middle Channel (99 % Occupied Bandwidth)

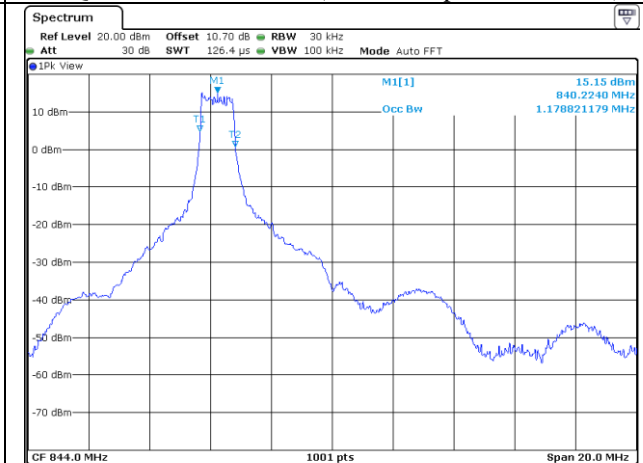
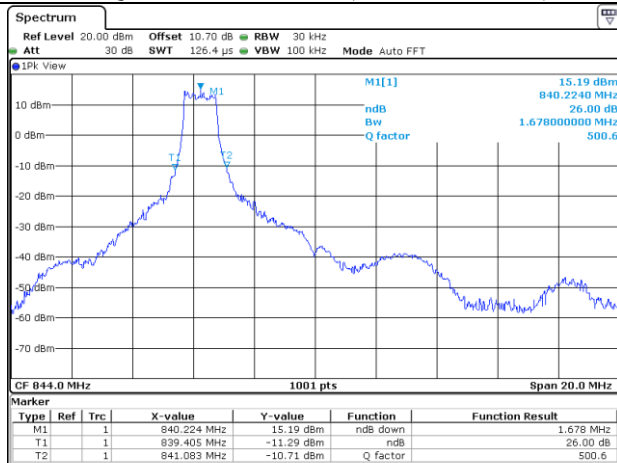

16QAM High Channel (26 dB Bandwidth)

16QAM High Channel (99 % Occupied Bandwidth)

12. Conducted Band Edge

12.1 Operating environment

Temperature : 24 °C
 Relative humidity : 47 % R.H.

12.2 Test set-up

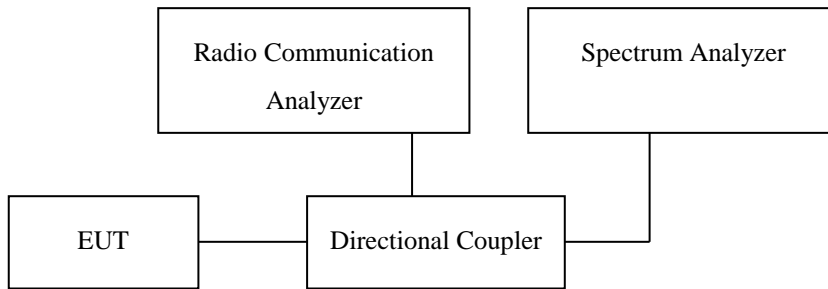

(Configuration of conducted Emission measurement)

Conducted Spurious Emissions is tested in accordance with KDB971168 D01 Power Meas License Digital Systems v04, April 9, 2018, Section 6.

The EUT makes a call to the communication simulator. The power was measured with R&S Spectrum Analyzer. All measurements were done at 3 channels(low, middle and high operational range.)

The Conducted Spurious Emissions used the power splitter via EUT RF power connector between simulation base station and spectrum analyzer.

The communication simulator station system controlled a EUT to export maximum output power under transmission mode and specific channel frequency.

12.3 Methods of Measurement

1. All measurements were done at low and high operational frequency range.
2. Set spectrum analyzer with RMS detector.
3. The center frequency of spectrum is the band edge frequency and set RBW of the spectrum is 20 kHz and VBW of the spectrum is 50 kHz

12.4 Limits

Rule Part 22.917(a) specifies that “The power of any emission outside of the authorized operating frequency ranges must be attenuated below the transmitting power (P) by a factor of at least 43 + 10 log(P) dB.”

$$\begin{aligned}
 &= P(W) - [43 + 10\log(P)](\text{dB}) \\
 &= [30+10\text{Log}(P)] (\text{dBm}) - [43 + 10\log(P)](\text{dB}) \\
 &= -13 \text{ dBm}
 \end{aligned}$$

Limit	-13 dBm
-------	---------

12.5 Test equipment used

	Model Number	Manufacturer	Description	Serial Number	Last Cal.
■ -	FSV30	Rohde & Schwarz	Signal Analyzer	101200	Aug. 23, 2018 (1Y)
■ -	AAMCS-UDC	AA-MCS	Directional Coupler	400	Aug. 23, 2018 (1Y)
■ -	MT8821C	ANRITSU	Radio Communication Analyzer	6261849029	Aug. 22, 2018 (1Y)
■ -	PWS-3003D	Protek	DC Power Supply	4020409	Aug. 24, 2018 (1Y)

All test equipment used is calibrated on a regular basis.

12.6 Test data

12.6.1 Test data for LTE Band 5 QPSK

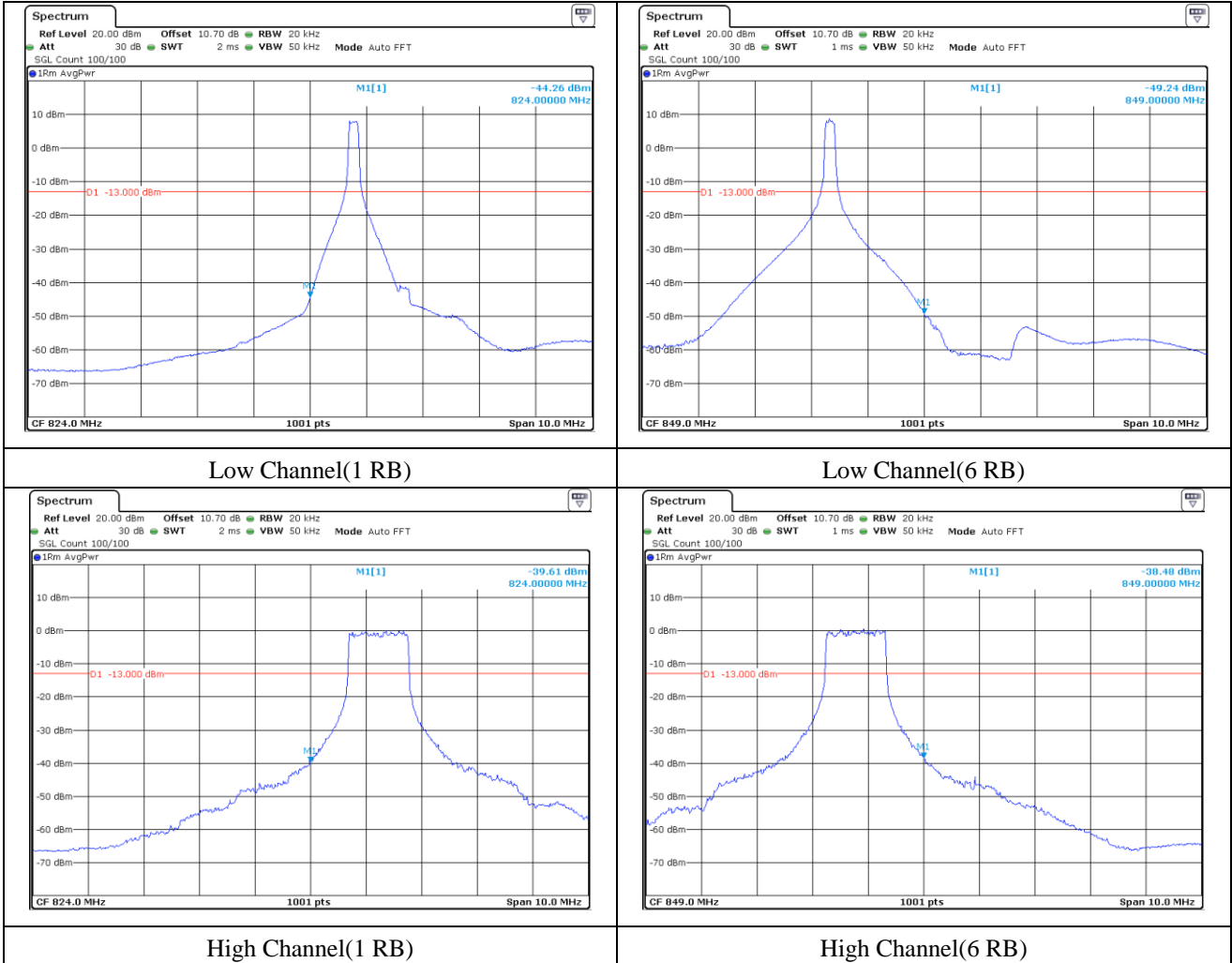

12.6.2 Test data for LTE Band 5 16QAM

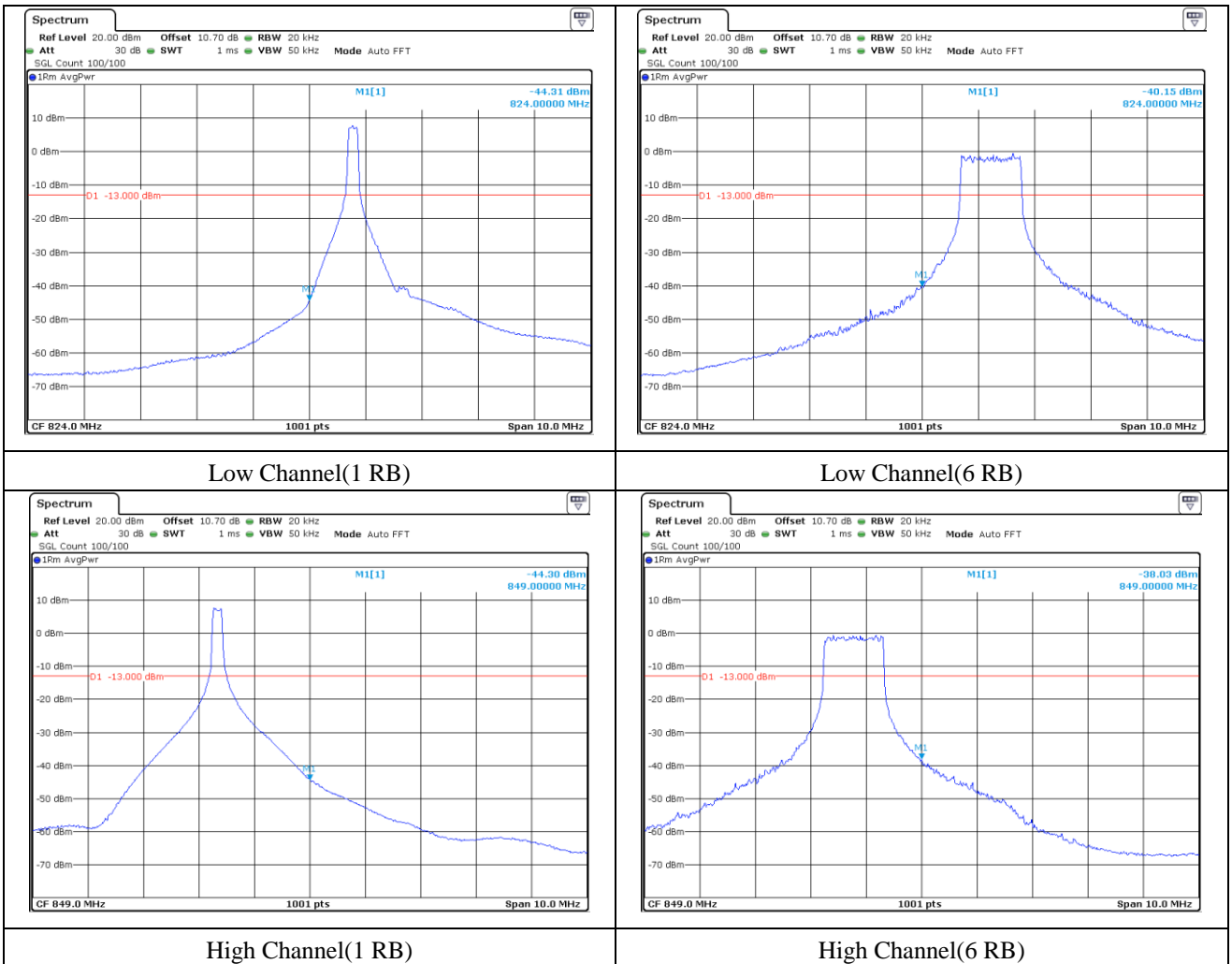

13. Conducted Spurious and Harmonic Emissions at Antenna Termianl

13.1 Operating environment

Temperature : 24 °C
 Relative humidity : 47 % R.H.

13.2 Test set-up

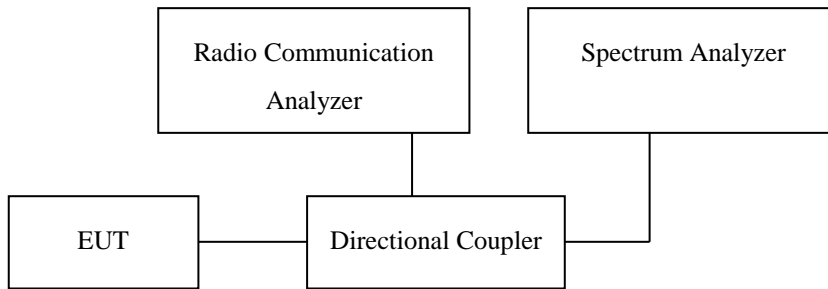

(Configuration of conducted Emission measurement)

Conducted Spurious Emissions is tested in accordance with KDB971168 D01 Power Meas License Digital Systems v04, April 9, 2018, Section 6.

The EUT makes a call to the communication simulator. The power was measured with R&S Spectrum Analyzer. All measurements were done at 3 channels(low, middle and high operational range.)

The Conducted Spurious Emissions used the power splitter via EUT RF power connector between simulation base station and spectrum analyzer.

The communication simulator station system controlled a EUT to export maximum output power under transmission mode and specific channel frequency.

Conduced spurious emissions

The EUT was setup to maximum output power. The 100 kHz RBW and 300 kHz VBW was used to scan from 30 MHz to 1 GHz. Also, the 1 MHz RBW and 3 MHz VBW was used to scan from 1 GHz to 10 GHz. The high, low and a middle channel were tested for out of band measurements.

13.3 Limits

Rule Part 22.917(a) specifies that “The power of any emission outside of the authorized operating frequency ranges must be attenuated below the transmitting power (P) by a factor of at least 43 + 10 log(P) dB.”

$$\begin{aligned}
 &= P(W) - [43 + 10\log(P)](\text{dB}) \\
 &= [30+10\text{Log}(P)] (\text{dBm}) - [43 + 10\log(P)](\text{dB}) \\
 &= -13 \text{ dBm}
 \end{aligned}$$

Limit	-13 dBm
-------	---------

13.4 Test equipment used

	Model Number	Manufacturer	Description	Serial Number	Last Cal.
■ -	FSV30	Rohde & Schwarz	Signal Analyzer	101200	Aug. 23, 2018 (1Y)
■ -	AAMCS-UDC	AA-MCS	Directional Coupler	400	Aug. 23, 2018 (1Y)
■ -	MT8821C	ANRITSU	Radio Communication Analyzer	6261849029	Aug. 22, 2018 (1Y)
■ -	PWS-3003D	Protek	DC Power Supply	4020409	Aug. 24, 2018 (1Y)

All test equipment used is calibrated on a regular basis.

13.5 Test data

13.5.1 Test data for LTE Band 5 QPSK

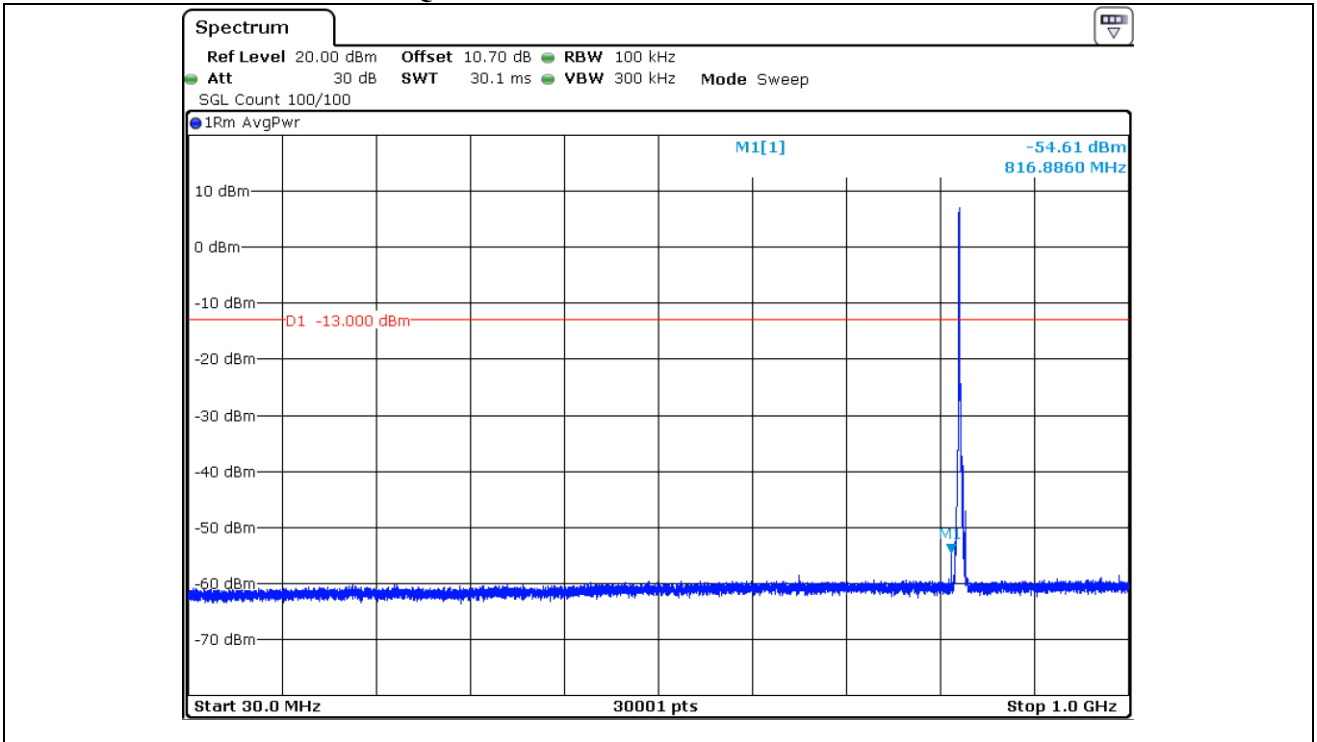

Low Channel

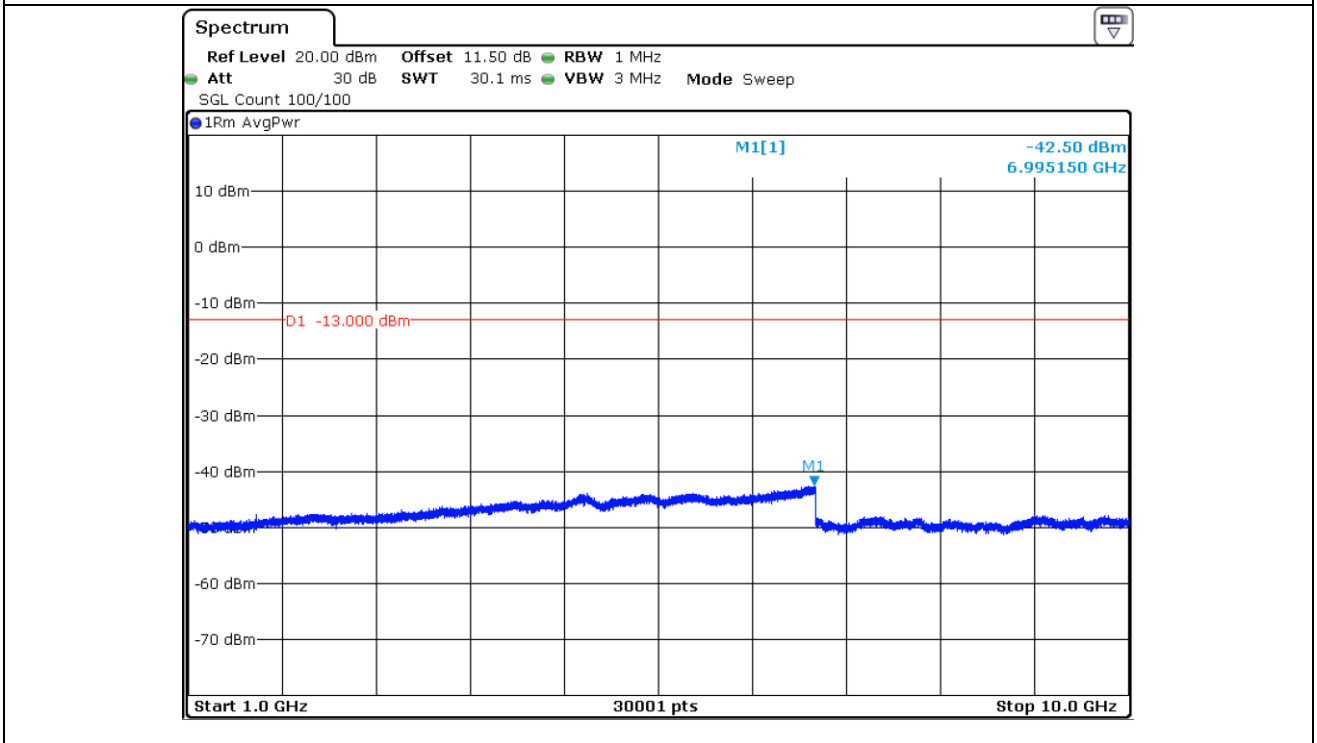

Low Channel

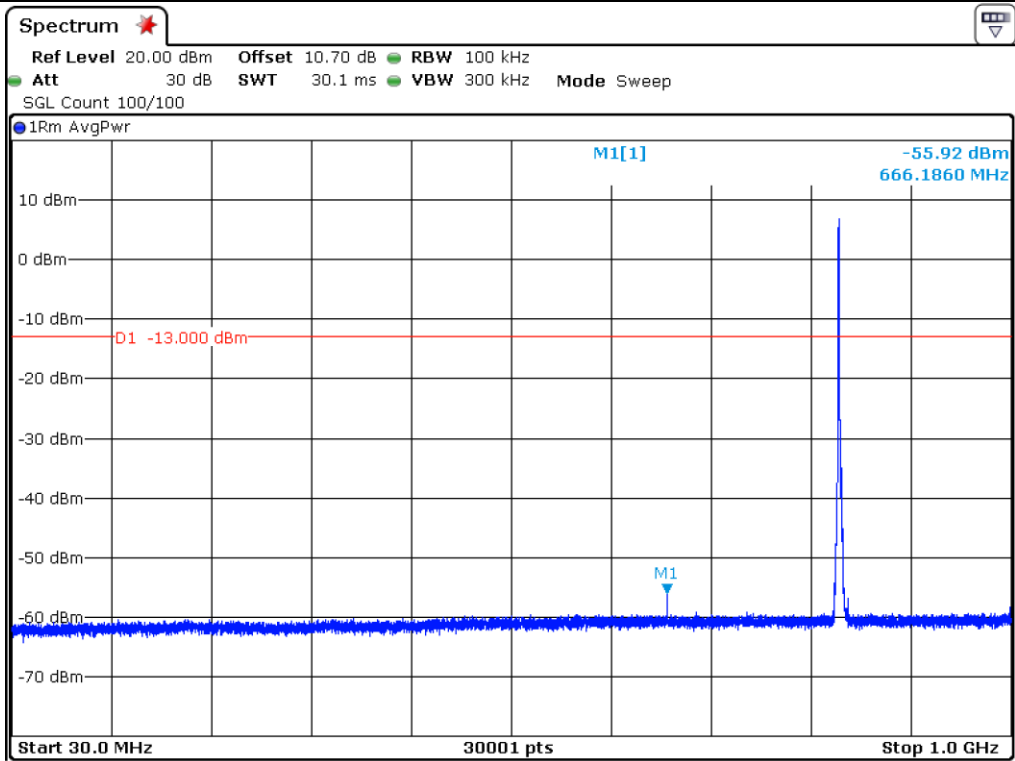

Midle Channel

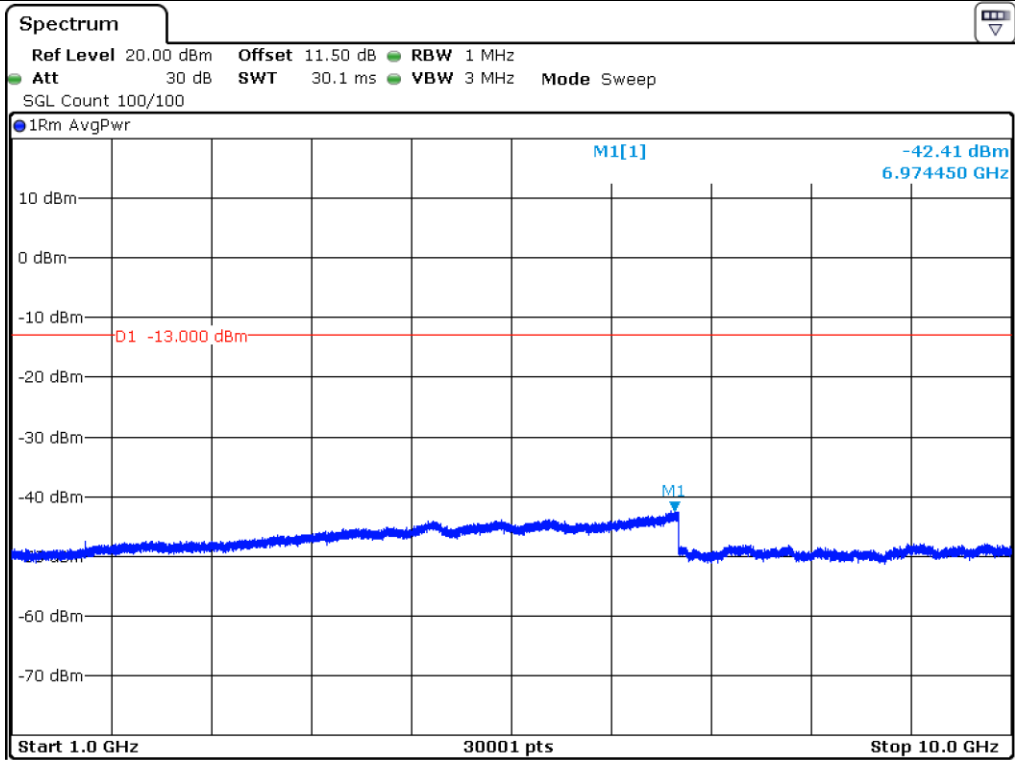

Midle Channel

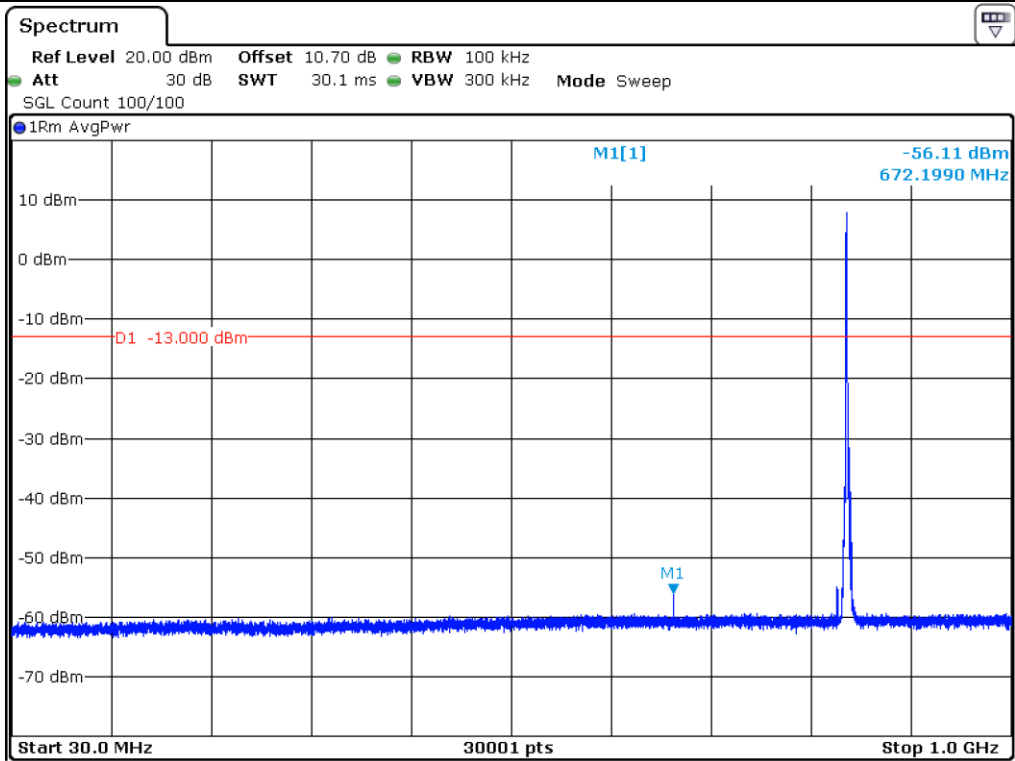

High Channel

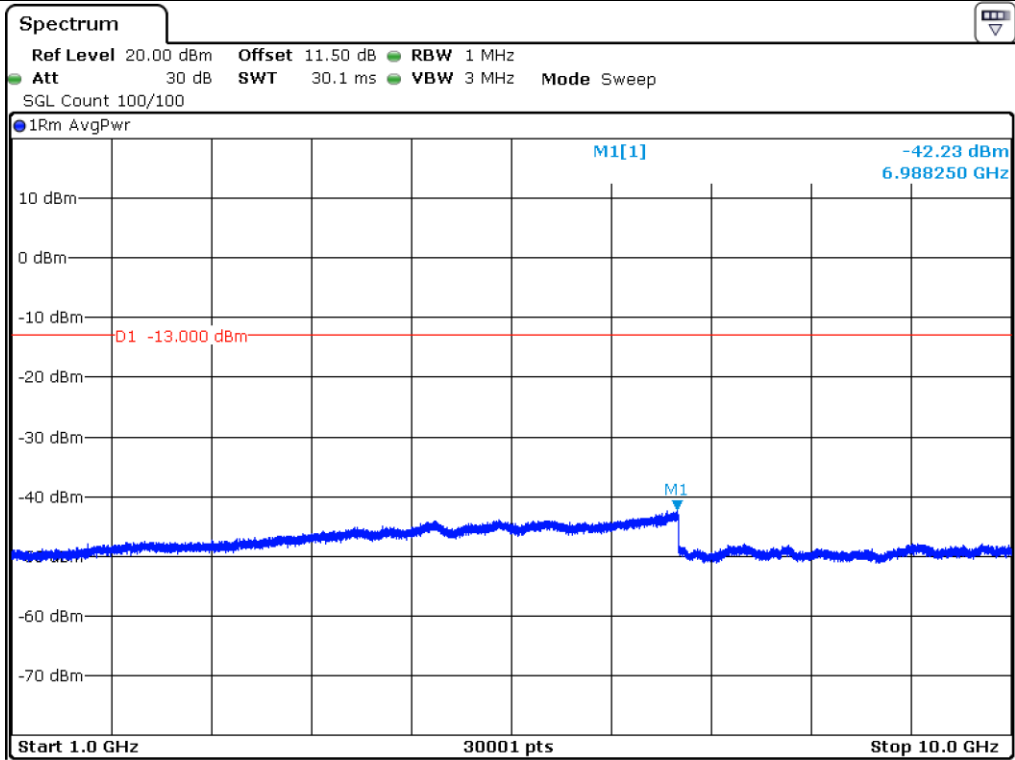

High Channel

13.5.2 Test data for LTE Band 5 16QAM

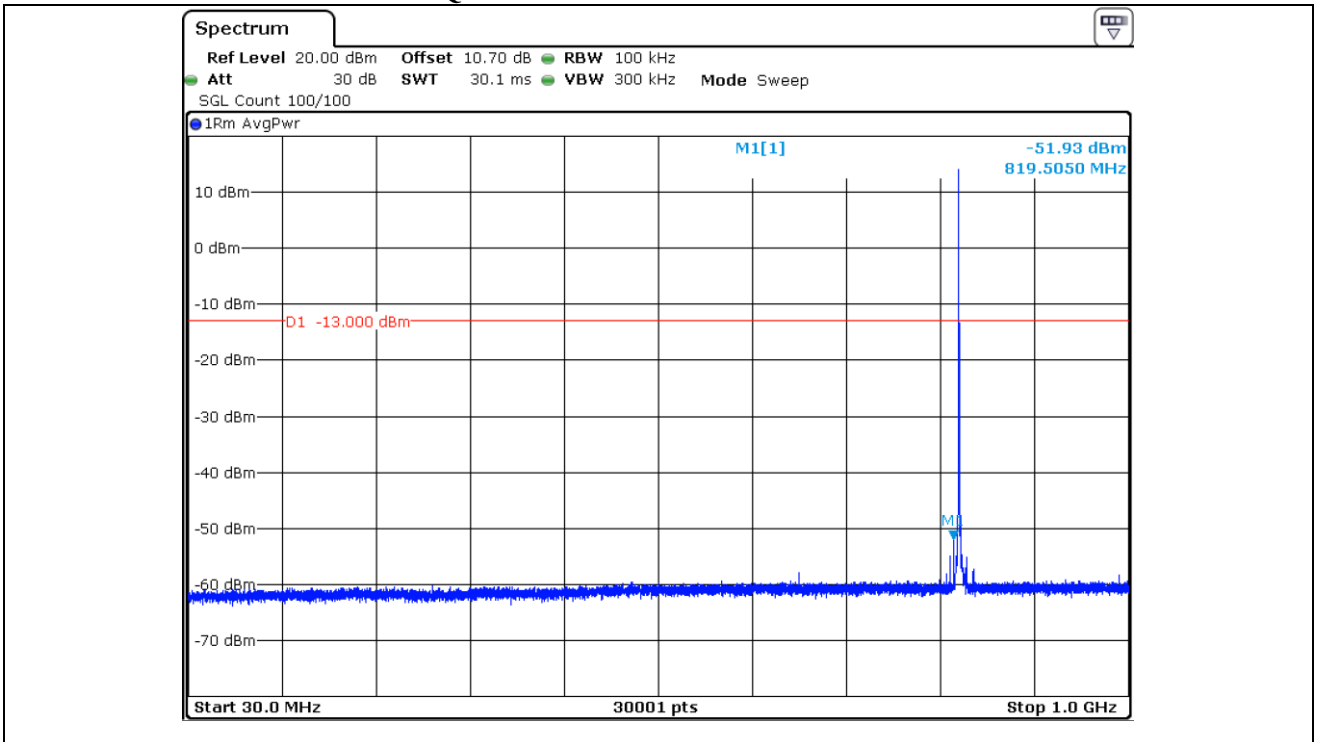

Low Channel

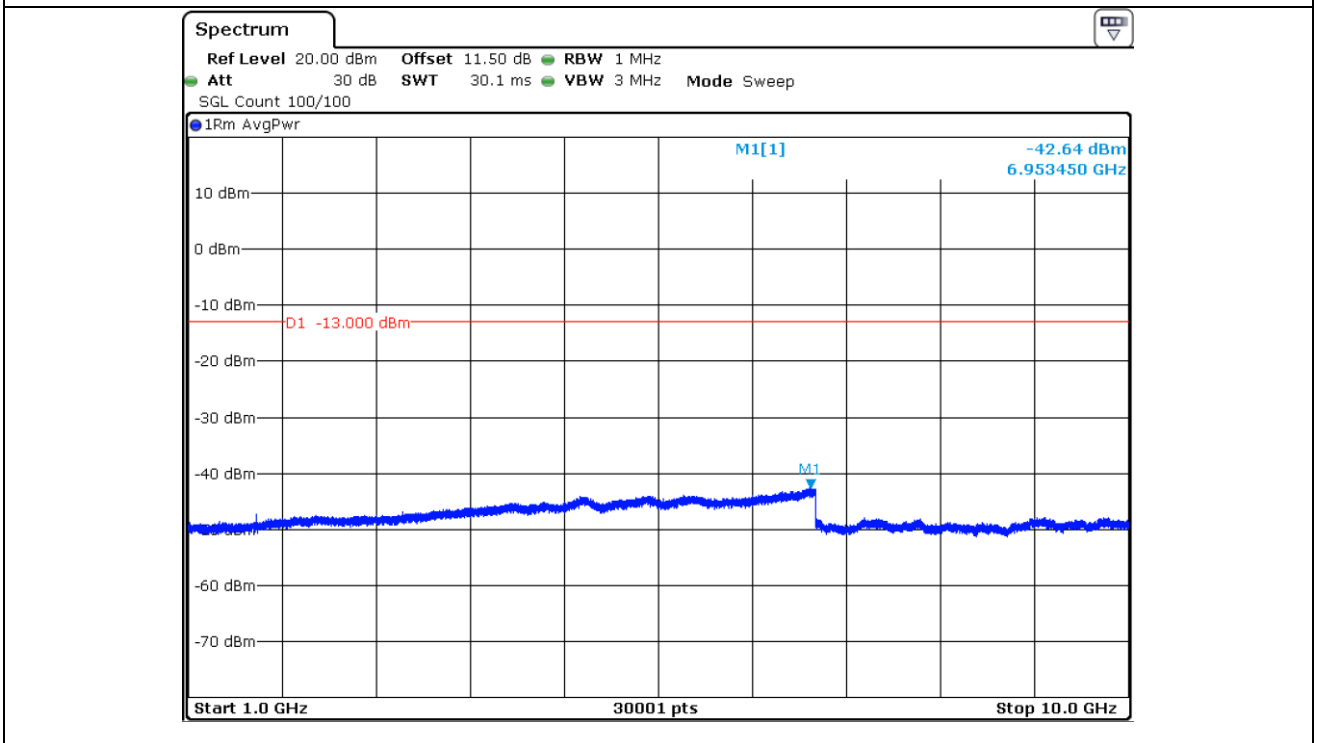

Low Channel

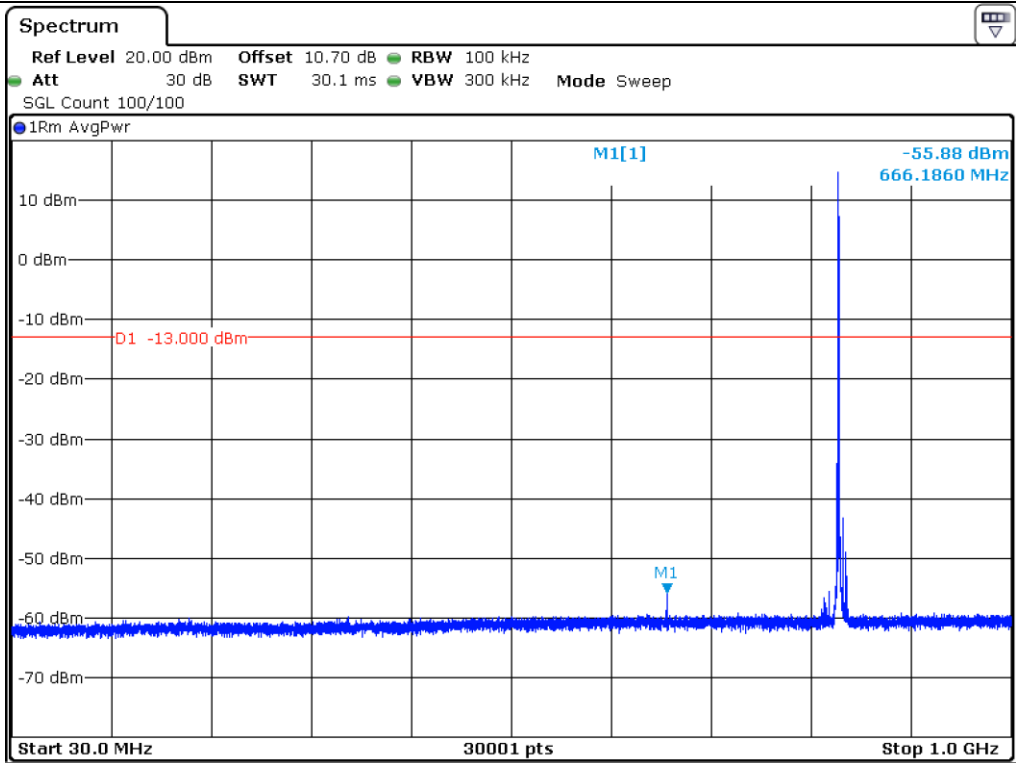

Midle Channel

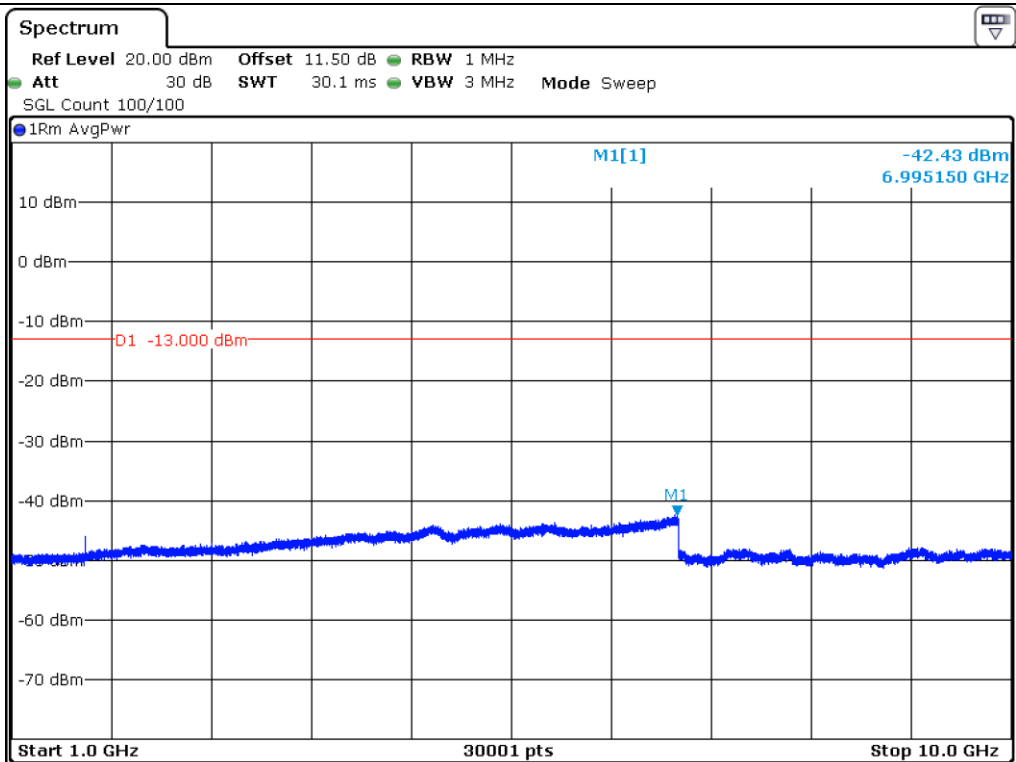

Midle Channel

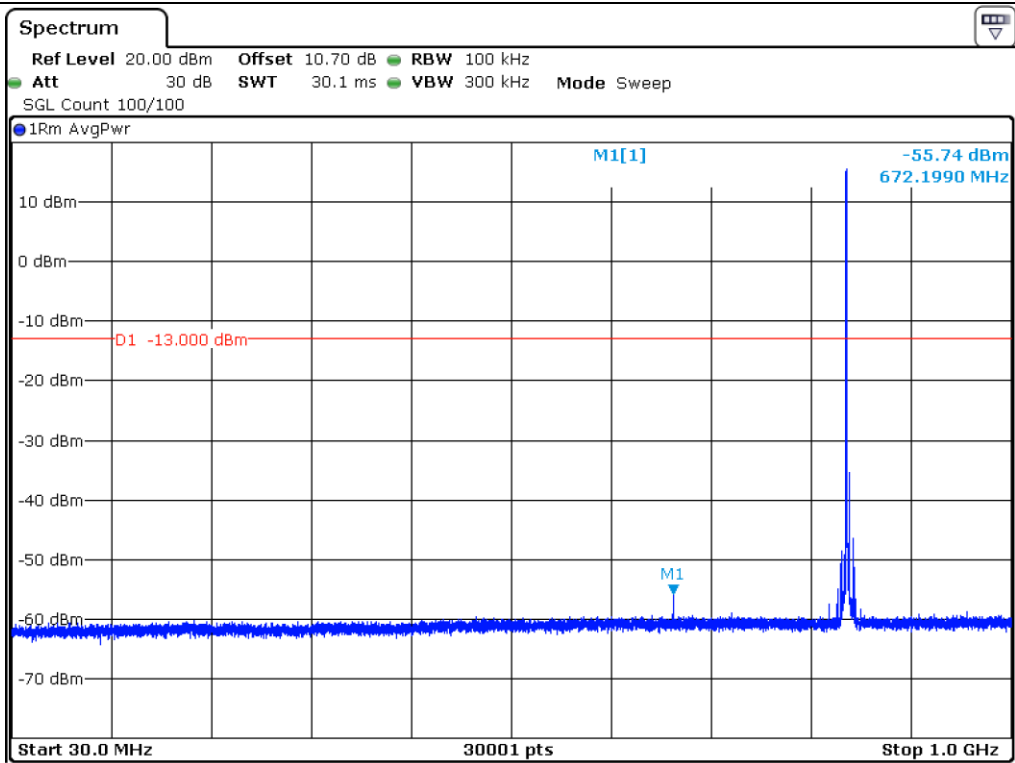

High Channel

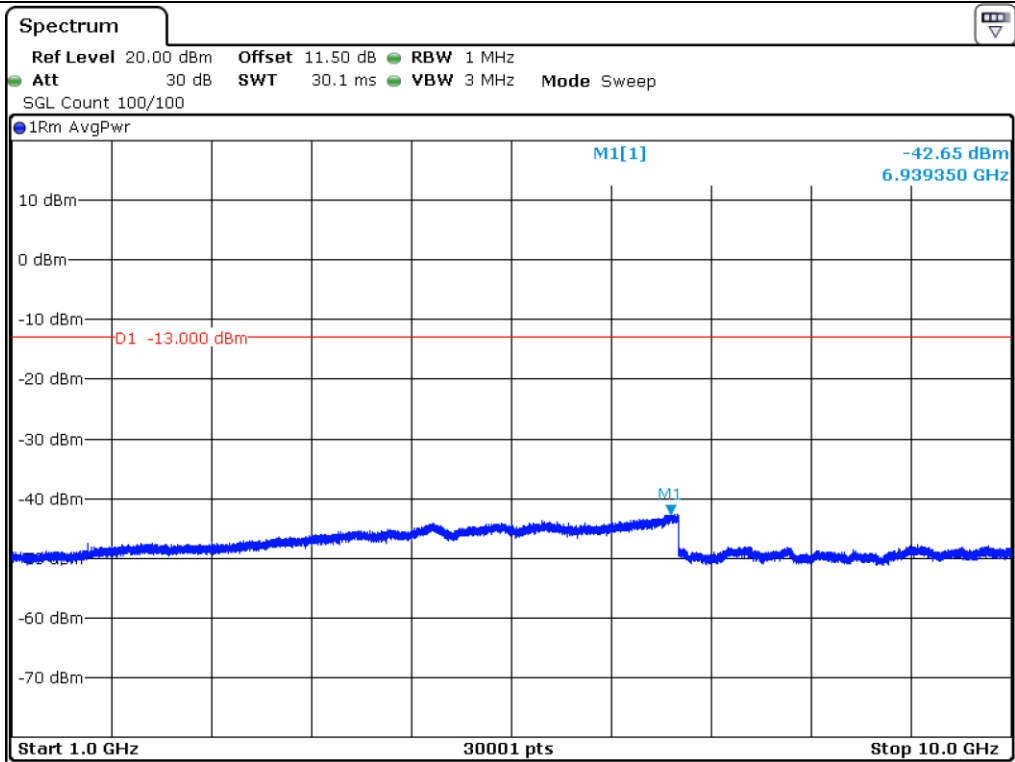

High Channel

14. FREQUENCY STABILITY / VARIATION OF AMBIENT TEMPERATURE

14.1 Operating environment

Temperature : 24 °C
 Relative humidity : 47 % R.H.

14.2 Test set-up

1. Frequency Stability (Voltage Variation)

+20 °C temperature and ±15% supply voltage variations. If a product is specified to operate over a range of input voltage then the -15% variation is applied to the lowermost voltage and the +15% is applied to the uppermost voltage.

- (1) Vary primary supply voltage from ±15% of the nominal value for other than hand carried battery equipment.
- (2) For hand carried, battery powered equipment, reduce primary supply voltage to the battery-operating end point which shall be specified by the manufacturer.

2. Frequency Stability (Temperature Variation)

Turn EUT off and set chamber temperature to -30 °C and then allow sufficient time (approximately 20 to 30 minutes after chamber reach the assigned temperature) for EUT to stabilize. Turn ON EUT and measure the EUT operating frequency and then turn off the EUT after the measurement. The temperature in the chamber was raised 10 °C step from -30 °C to +50 °C. Repeat above method for frequency measurements every 10 °C step and then record all measured frequencies on each temperature step.

14.3 Test equipment used

	Model Number	Manufacturer	Description	Serial Number	Last Cal.
■ -	FSV30	Rohde & Schwarz	Signal Analyzer	101200	Aug. 23, 2018 (1Y)
■ -	AAMCS-UDC	AA-MCS	Directional Coupler	400	Aug. 23, 2018 (1Y)
■ -	MT8821C	ANRITSU	Radio Communication Analyzer	6261849029	Aug. 22, 2018 (1Y)
■ -	PSL-2KP	ESPEC	Environmental Test Chamber	14009407	Feb. 23, 2018 (1Y)
■ -	PWS-3003D	Protek	DC Power Supply	4020409	Aug. 24, 2018 (1Y)

All test equipment used is calibrated on a regular basis.

14.4 Test data

14.4.1 Test data for Voltage(V)

Temperature(° C)	Power(VDC)	Center Freq.	Measured Freq.	PPM
20	12.0	836 500 000	836 499 989	-0.013 2
	10.2		836 499 984	-0.019 1
	13.8		836 499 986	-0.016 7

14.4.2 Test data for Temperature(° C)

Temperature(° C)	Power(VDC)	Center Freq.	Measured Freq.	PPM
-30	12.0 V	836 500 000	836 499 987	-0.015 5
-20			836 499 983	-0.020 3
-10			836 499 981	-0.022 7
0			836 499 986	-0.016 7
10			836 499 983	-0.020 3
20			836 499 989	-0.013 2
30			836 499 985	-0.017 9
40			836 500 007	0.008 4
50			836 499 992	-0.009 6



Tested by: Ju Yun Park / Assistant Manager