

ELECTROMAGNETIC EMISSION COMPLIANCE REPORT FOR LICENSED TRANSMITTER

Test Report No. : OT-199-RWD-002
AGR No. : A197A-409
Applicant : Suntech International Ltd.
Address : A-1705, A-1706, Greatvally, 32, Digital-ro 9-gil, Geumcheon-Gu, Seoul, Korea
Manufacturer : Suntech International Ltd.
Address : A-1705, A-1706, Greatvally, 32, Digital-ro 9-gil, Geumcheon-Gu, Seoul, Korea
Type of Equipment : Tracking Device
FCC ID. : WA2ST3310
Model Name : ST3310
Serial number : N/A
Total page of Report : 39 pages (including this page)
Date of Incoming : August 02, 2019
Date of issue : September 02, 2019

SUMMARY

The equipment complies with the regulation; **Part 2, Part 24 Subpart E**
 This test report only contains the result of a single test of the sample supplied for the examination.
 It is not a generally valid assessment of the features of the respective products of the mass-production.

Reviewed by: 

 Tae-Ho, Kim / Senior Manager
 ONETECH Corp.

Approved by: 

 Ki-Hong, Nam / Chief Engineer
 ONETECH Corp.

CONTENTS

PAGE

1. VERIFICATION OF COMPLIANCE	6
2. TEST SUMMARY.....	7
2.1 TEST ITEMS AND RESULTS	7
2.2 ADDITIONS, DEVIATIONS, EXCLUSIONS FROM STANDARDS.....	7
2.3 RELATED SUBMITTAL(S) / GRANT(S)	7
2.4 PURPOSE OF THE TEST	7
2.5 TEST METHODOLOGY.....	7
2.6 TEST FACILITY.....	8
3. GENERAL INFORMATION.....	9
3.1 PRODUCT DESCRIPTION.....	9
3.2 ALTERNATIVE TYPE(S)/MODEL(S); ALSO COVERED BY THIS TEST REPORT.....	9
4. EUT MODIFICATIONS.....	9
5. SYSTEM TEST CONFIGURATION	10
5.1 JUSTIFICATION.....	10
5.2 PERIPHERAL EQUIPMENT	10
5.3 MODE OF OPERATION DURING THE TEST	11
5.4 FREQUENCY LIST OF LOW/MIDDLE/HIGH CHANNELS	11
5.5 CONFIGURATION OF TEST SYSTEM.....	12
6. PRELIMINARY TEST	12
6.1 AC POWER LINE CONDUCTED EMISSIONS TESTS.....	12
6.2 GENERAL RADIATED EMISSIONS TESTS	12
7. CONDUCTED OUTPUT POWER	13
7.1 OPERATING ENVIRONMENT	13
7.2 TEST SET-UP	13
7.3 TEST EQUIPMENT USED.....	13
7.4 TEST DATA.....	14
8. EQUIVALENT ISOTROPIC RADIATED POWER	15
8.1 OPERATING ENVIRONMENT	15
8.2 METHODS OF MEASUREMENT	15
8.3 LIMITS	15
8.4 TEST SET-UP	15

8.5 TEST EQUIPMENT USED.....	16
8.6 TEST DATA FOR WCDMA BAND 2.....	17
9. RADIATED SPURIOUS EMISSIONS.....	18
9.1 OPERATING ENVIRONMENT.....	18
9.2 TEST SET-UP.....	18
9.3 TEST EQUIPMENT USED.....	19
9.4 TEST DATA FOR WCDMA BAND 2.....	20
10. PEAK-TO-AVERAGE RATIO.....	21
10.1 OPERATING ENVIRONMENT.....	21
10.2 TEST SET-UP.....	21
10.3 TEST EQUIPMENT USED.....	22
10.4 TEST DATA.....	22
11. OCCUPIED BANDWIDTH.....	25
11.1 OPERATING ENVIRONMENT.....	25
11.2 TEST SET-UP.....	25
11.3 TEST EQUIPMENT USED.....	25
11.4 TEST DATA FOR WCDMA BAND 2.....	26
12. CONDUCTED BAND EDGE.....	30
12.1 OPERATING ENVIRONMENT.....	30
12.2 TEST SET-UP.....	30
12.3 METHODS OF MEASUREMENT.....	30
12.4 LIMITS.....	30
12.5 TEST EQUIPMENT USED.....	31
12.6 TEST DATA.....	31
12.6.1 Test data for WCDMA Band 2.....	31
12.6.2 Test data for WCDMA Band 2.....	32
13. CONDUCTED SPURIOUS AND HARMONIC EMISSIONS AT ANTENNA TERMIANL.....	33
13.1 OPERATING ENVIRONMENT.....	33
13.2 TEST SET-UP.....	33
13.3 LIMITS.....	33
13.4 TEST EQUIPMENT USED.....	34
13.5 TEST DATA.....	35
13.5.1 Test data for WCDMA Band 2.....	35
14. FREQUENCY STABILITY / VARIATION OF AMBIENT TEMPERATURE.....	38
14.1 OPERATING ENVIRONMENT.....	38

14.2 TEST SET-UP38

14.3 TEST EQUIPMENT USED38

14.4 TEST DATA39

14.4.1 Test data for Voltage(V)39

14.4.2 Test data for Temperature(°C)39

Revision History

Rev. No.	Issue Report No.	Issued Date	Revisions	Section Affected
0	OT-199-RWD-002	September 02, 2019	Initial Release	All

1. VERIFICATION OF COMPLIANCE

Applicant : Suntech International Ltd.
 Address : A-1705, A-1706, Greatvally, 32, Digital-ro 9-gil, Geumcheon-Gu, Seoul, Korea
 Contact Person : Yohan Kim / Manager
 Telephone No. : 82-2-6327-5661
 FCC ID : WA2ST3310
 Model Name : ST3310
 Serial Number : N/A
 Date : September 02, 2019

EQUIPMENT CLASS	PCB-PCS Licensed Transmitter
EQUIPMENT DESCRIPTION	Tracking Device
THIS REPORT CONCERNS	Original Grant
MEASUREMENT PROCEDURES	ANSI C63.26:2015, KDB Publication 971168 D01
TYPE OF EQUIPMENT TESTED	Pre-Production
KIND OF EQUIPMENT AUTHORIZATION REQUESTED	Certification
EQUIPMENT WILL BE OPERATED UNDER FCC RULES PART(S)	FCC Part 2, Part 24 Subpart E
Modifications on the Equipment to Achieve Compliance	None
Final Test was Conducted On	3 m Semi Anechoic Chamber

-. The above equipment was tested by ONETECH Corp. for compliance with the requirement set forth in the FCC Rules and Regulations. This said equipment in the configuration described in this report, shows the maximum emission levels emanating from equipment are within the compliance requirements.

2. TEST SUMMARY

2.1 Test items and results

SECTION	TEST ITEMS	RESULTS
2.1049	Occupied Bandwidth	Met the Limit / PASS
2.1051, 24.238(a)	Band Edge / Spurious and Harmonic Emissions at Antenna Terminal	Met the Limit / PASS
2.1046	Conducted Output Power	Met the Limit / PASS
24.232(d), KDB Publication 971168 D01	Peak-to-Average Ratio	Met the Limit / PASS
2.1055, 24.235	Frequency stability	Met the Limit / PASS
24.232(c)	Equivalent Isotropic Radiated Power	Met the Limit / PASS
2.1053, 24.238(a)	Radiated Spurious and Harmonic Emissions	Met the Limit / PASS

2.2 Additions, deviations, exclusions from standards

No additions, deviations or exclusions have been made from standard.

2.3 Related Submittal(s) / Grant(s)

Original submittal only

2.4 Purpose of the test

To determine whether the equipment under test fulfills the requirements of the regulation stated in Part 24 Subpart E.

2.5 Test Methodology

Both conducted and radiated testing was performed according to the procedures in ANSI C63.26:2015. Radiated testing was performed at a distance of 3 m from EUT to the antenna.

2.6 Test Facility

The Onetech Corp. has been designated to perform equipment testing in compliance with ISO/IEC 17025.

The Electromagnetic compatibility measurement facilities are located at 43-14, Jinsaegol-gil, Chowol-eup, Gwangju-si, Gyeonggi-do, 12735, Korea

-. Site Filing:

VCCI (Voluntary Control Council for Interference) – Registration No. R-4112/ C-14617/ G-10666 / T-1842

IC (Industry Canada) – Registration No. Site# 3736A-3

-. Site Accreditation:

KOLAS (Korea Laboratory Accreditation Scheme) - Accreditation NO. KT085

FCC (Federal Communications Commission) - Accreditation No. KR0013

RRA (Radio Research Agency) – Designation No. KR0013

3. GENERAL INFORMATION

3.1 Product Description

The Suntech International Ltd., Model ST3310 (referred to as the EUT in this report) is a Tracking Device. Product specification information described herein was obtained from product data sheet or user’s manual.

DEVICE TYPE	Tracking Device		
OPERATING FREQUENCY	WCDMA Band 2	TX	1 852.4 MHz ~ 1 907.6 MHz
		RX	1 932.4 MHz ~ 1 987.6 MHz
	WCDMA Band 5	TX	826.4 MHz ~ 846.6 MHz
		RX	871.4 MHz ~ 891.6 MHz
Modulation Type	QPSK, 16QAM		
Maximum EIRP Power	WCDMA Band 2	20.48 dBm	
ANTENNA TYPE	PIFA Antenna		
ANTENNA GAIN	WCDMA Band 2	1.16 dBi	
	WCDMA Band 5	2.14 dBi	
List of each Osc. or crystal Freq.(Freq. >= 1 MHz)	26 MHz		

3.2 Alternative type(s)/model(s); also covered by this test report.

-. None

4. EUT MODIFICATIONS

-. None

5. SYSTEM TEST CONFIGURATION

5.1 Justification

This device was configured for testing in a typical way as a normal customer is supposed to be used. During the test, the following components were installed inside of the EUT.

DEVICE TYPE	MANUFACTURER	MODEL/PART NUMBER	FCC ID
Main Board	N/A	N/A	N/A
Battery	N/A	N/A	N/A
Antenna	N/A	N/A	N/A

5.2 Peripheral equipment

Defined as equipment needed for correct operation of the EUT, but not considered as tested:

Model	Manufacturer	Description	Connected to
ST3310	Suntech International Ltd.	Tracking Device	-
GP-4303D	LG Precision Co.,Ltd	DC Power Supply	EUT

5.3 Mode of operation during the test

Pre-Scan has been conducted to determine the worst-case mode from all possible combinations between available modulations, data rates, XYZ axis, and antenna ports. The worst case was found when positioned as the table below.

Following channel(s) was (were) selected for the final test as listed below:

Band	EIRP	Radiated Emission
WCDMA Band 2	Y-plane	Y-axis

Test Mode : WCDMA Band 2

Test Item	Modulation	Mode	Test Channel
Conducted Output Power	QPSK	RMC	1 852.4 MHz
			1 880 MHz
			1 907.6 MHz
Equivalent Isotropic Radiated Power	QPSK	RMC	1 852.4 MHz
			1 880 MHz
			1 907.6 MHz
Frequency stability	QPSK	RMC	1 880 MHz
Occupied Bandwidth	QPSK	RMC	1 852.4 MHz
			1 880 MHz
			1 907.6 MHz
Peak-to-Average Ratio	QPSK	RMC	1 852.4 MHz
			1 880 MHz
			1 907.6 MHz
Band Edge	QPSK	RMC	1 852.4 MHz
			1 907.6 MHz
Spurious and Harmonic Emissions at Antenna Terminal	QPSK	RMC	1 852.4 MHz
			1 880 MHz
			1 907.6 MHz
Radiated Spurious and Harmonic Emissions	QPSK	RMC	1 852.4 MHz
			1 880 MHz
			1 907.6 MHz

5.4 Frequency List of Low/Middle/High Channels

WCDMA Band 2 Channel and Frequency List			
Channel / Frequency	Low	Middle	High
Channel	9262	9400	9538
Frequency	1 852.4 MHz	1 880 MHz	1 907.6 MHz

5.5 Configuration of Test System

Radiated Emission Test: Preliminary radiated emissions test were conducted using the procedure in ANSI C63.10: 2013 to determine the worse operating conditions. Final radiated emission tests were conducted at 3 m Semi Anechoic Chamber.

The turntable was rotated through 360 degrees and the EUT was tested by positioned three orthogonal planes to obtain the highest reading on the field strength meter. Once maximum reading was determined, the search antenna was raised and lowered in both vertical and horizontal polarization.

6. PRELIMINARY TEST

6.1 AC Power line Conducted Emissions Tests

As this product is only using DC power, AC conducted emission test has not been performed.

6.2 General Radiated Emissions Tests

During Preliminary Test, the following operating mode was investigated.

Operation Mode	The Worse operating condition (Please check one only)
Transmitting Mode	X

7. CONDUCTED OUTPUT POWER

7.1 Operating environment

Temperature : 24 °C
 Relative humidity : 47 % R.H.

7.2 Test set-up

Conducted Output Power is tested in accordance with KDB971168 D01 Power Meas License Digital Systems v04, April 9, 2018, Section 5.2.

A base station simulator was used to establish communication with the EUT, and Spectrum analyzer was used for test results. This device was tested under all configurations and the highest power is reported. Conducted Output Powers of EUT are reported below.

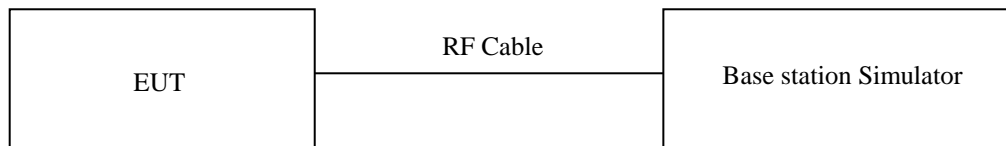

7.3 Test equipment used

	Model Number	Manufacturer	Description	Serial Number	Last Cal.
■ -	E5515C	Agilent	WIRELESS COMMUNICATIONS TEST SET	MY48360785	Mar. 11, 2019 (1Y)
■ -	GP-4303D	LG Precision Co.,Ltd	DC Power Supply	5071069	Jan. 10, 2019 (1Y)

All test equipment used is calibrated on a regular basis.

7.4 Test data

- Test Date : August 09, 2019 ~ August 23, 2019
- Test Result : Pass

Conducted Average Output Power (dBm)

Test Mode	Mode	Low Channel	Middle Channel	High Channel
		9262	9400	9538
		1 852.4 MHz	1 880 MHz	1 907.6 MHz
WCDMA	RMC	22.77	21.76	22.02
HSDPA	Subtest1	22.18	21.16	21.38
	Subtest2	22.15	21.15	21.34
	Subtest3	22.16	21.11	21.35
	Subtest4	22.18	21.15	21.37
HSUPA	Subtest1	21.86	20.84	21.11
	Subtest2	21.94	20.91	21.14
	Subtest3	21.64	20.76	20.91
	Subtest4	22.13	21.11	21.16
	Subtest5	21.79	20.85	21.09



Tested by: Ju Yun Park / Assistant Manager

8. EQUIVALENT ISOTROPIC RADIATED POWER

8.1 Operating environment

Temperature : 23 °C
 Relative humidity : 48 % R.H.

8.2 Methods of Measurement

1. The testing follows ANSI C63.26 (2015) Section 5.5.3.
2. Substitution method is used for E.I.R.P measurement. In the semi-anechoic chamber, EUT placed on the 0.8 m (below or equal 1 GHz) and/or 1.5 m (above 1 GHz) height of Turn Table, rotated the table around 360 degrees to search the maximum radiation power and receiver antenna shall be rotated vertical and horizontal polarization and moved height from 1 m to 4 m to find the maximum polar radiated power. The “Read Value” is the spectrum reading the maximum power value.
3. The substitution antenna is substituted for EUT at the same position and signals generator export the CW signal to the substitution antenna via a tx cable. Rotated the Turn Table and moved receiving antenna to find the maximum radiation power. Adjust output power level of S.G to get a Value of spectrum reading equal to “Read Value” of step 2. Record the power level of S.G.
4. EIRP = Output power level of S.G – TX cable loss + Antenna gain of substitution antenna power can be Calculated. E.R.P power = E.I.P.R power - 2.15 dBi.

8.3 Limits

Rule Part 24.232(c) Mobile and portable stations are limited to 2 watts EIRP.

Limit	2 W (33 dBm)
-------	--------------

8.4 Test set-up

The EUT and measurement equipment were set up as shown in the diagram below.

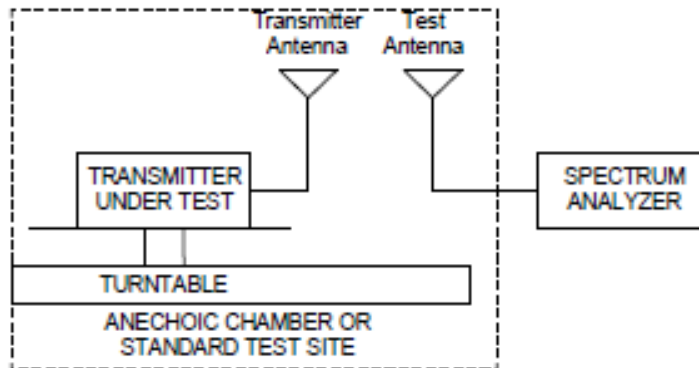

8.5 Test equipment used

	Model Number	Manufacturer	Description	Serial Number	Last Cal. (Interval)
■ -	ESR	Rohde & Schwarz	EMI Test Receiver	101470	Oct. 22, 2018 (1Y)
■ -	310N	Sonoma Instrument	AMPLIFIER	312544	Mar. 18, 2019 (1Y)
■ -	FSV30	Rohde & Schwarz	Signal Analyzer	101372	Jul. 24, 2019 (1Y)
□ -	BBV9718B	Schwarzbeck	Broadband Preamplifier	009	Mar. 20, 2019 (1Y)
■ -	SCU-03	Rohde & Schwarz	Signal Conditioning Unit	100333	Mar. 11, 2019 (1Y)
■ -	SCU-18	Rohde & Schwarz	Pre-Amplifier	102266	Jul. 24, 2019 (1Y)
■ -	MA-4000XPET	Innco Systems GmbH	Antenna Master	MA4000/509	N/A
□ -	HD100	HD GmbH	Position Controller	N/A	N/A
■ -	DT3000-3t	Innco Systems GmbH	Turn Table	N/A	N/A
□ -	FMZB 1513	Schwarzbeck	LOOP ANTENNA	1513-235	May. 13, 2018 (2Y)
■ -	VULB9163	Schwarzbeck	TRILOG Broadband Antenna	9163-255	Jun 05, 2018 (2Y)
■ -	VULB9163	Schwarzbeck	Hybrid Antenna	777	Apr, 13, 2018 (2Y)
■ -	BBHA9120D	Schwarzbeck	Horn Antenna	9120D-1366	Jul. 16, 2019 (1Y)
■ -	BBHA9120D	Schwarzbeck	Horn Antenna	9120D-295	Jul. 16, 2019 (1Y)
□ -	SCU40A	Rohde & Schwarz	Pre-Amplifier	100436	Mar. 11, 2019 (1Y)
■ -	E5515C	Agilent	WIRELESS COMMUNICATIONS TEST SET	MY48360785	Mar. 11, 2019 (1Y)
■ -	GP-4303D	LG Precision Co.,Ltd	DC Power Supply	5071069	Jan. 10, 2019 (1Y)

All test equipment used is calibrated on a regular basis.

8.6 Test data for WCDMA Band 2

- Test Date : August 09, 2019 ~ August 23, 2019

- Test Result : Pass

Frequency (MHz)	Substituted Level (dBm)	Ant. Pol. (H/V)	Cable Loss (dB)	Ant Gain (dBi)	EIRP (dBm)	Limits (dBm)	Margin (dB)
Test Data for WCDMA Band 2							
1852.4	15.10	H	1.21	6.50	20.39	33.00	12.61
1852.4	8.82	V	1.21	6.50	14.11	33.00	18.89
1880.0	15.31	H	1.23	6.40	20.48	33.00	12.52
1880.0	9.06	V	1.23	6.40	14.23	33.00	18.77
1907.6	14.98	H	1.26	6.70	20.42	33.00	12.58
1907.6	8.74	V	1.26	6.70	14.18	33.00	18.82

Remark: WCDMA Band 2 is measured the highest power mode.

“H”: Horizontal, “V”: Vertical

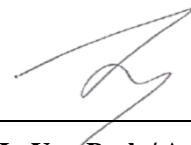

Tested by: Ju Yun Park / Assistant Manager

9. RADIATED SPURIOUS EMISSIONS

9.1 Operating environment

Temperature : 23 °C
 Relative humidity : 48 % R.H.

9.2 Test set-up

Radiated emission measurements are performed in the Semi-Anechoic chamber. The equipment under test is placed on a non-conductive table 3-meters away from the receive antenna in accordance with ANSI C63.26 (2015) Section 5.5.3. The turntable is rotated through 360°, and the receiving antenna scans in order to determine the level of the maximized emission. The level and position of the maximized emission is recorded with the spectrum analyzer using RMS detector.

A vertically polarized half-wave dipole is then substituted in place of the EUT. For emissions above 1GHz, a horn antenna is substituted in place of the EUT. The substitute antenna is driven by a signal generator and the previously recorded signal was duplicated.

The power is calculated by the following formula;

$$Pd(dBm) = Pg(dBm) - \text{cable loss (dB)} + \text{antenna gain (dB)}$$

Where: Pd is the dipole equivalent power and Pg is the generator output power into the substitution antenna.

The maximum EIRP is calculated by adding the forward power to the calibrated source plus its appropriate gain value. These steps are repeated with the receiving antenna in both vertical and horizontal polarization. the difference between the gain of the horn and an isotropic antenna are taken into consideration

Limits

Rule Part 24.238(a) specifies that “on any frequency outside a licensee’s frequency block, the power of any emission shall be attenuated below the transmitter power (P) by at least 43 + 10 log10 (P) dB.”

$$\begin{aligned} &= P(W) - [43 + 10\log(P)](dB) \\ &= [30+10\text{Log}(P)] (dBm) - [43 + 10\log(P)](dB) \\ &= -13 dBm \end{aligned}$$

Limit	-13 dBm
-------	---------

Radiated spurious emissions

1. Frequency Range : 9 kHz ~ 10th Harmonics of highest channel fundamental frequency.
 2. The EUT was setup to maximum output power. The 100 kHz RBW was used to scan from 30 MHz to 1 GHz.
- Also, the 1 MHz RBW was used to scan from 1 GHz to 20 GHz. The high, low and a middle channel were tested for out of band measurements.

9.3 Test equipment used

	Model Number	Manufacturer	Description	Serial Number	Last Cal. (Interval)
■ -	ESR	Rohde & Schwarz	EMI Test Receiver	101470	Oct. 22, 2018 (1Y)
■ -	310N	Sonoma Instrument	AMPLIFIER	312544	Mar. 18, 2019 (1Y)
■ -	FSV30	Rohde & Schwarz	Signal Analyzer	101372	Jul. 24, 2019 (1Y)
□ -	BBV9718B	Schwarzbeck	Broadband Preamplifier	009	Mar. 20, 2019 (1Y)
■ -	SCU-03	Rohde & Schwarz	Signal Conditioning Unit	100333	Mar. 11, 2019 (1Y)
■ -	SCU-18	Rohde & Schwarz	Pre-Amplifier	102266	Jul. 24, 2019 (1Y)
■ -	MA-4000XPET	Innco Systems GmbH	Antenna Master	MA4000/509	N/A
□ -	HD100	HD GmbH	Position Controller	N/A	N/A
■ -	DT3000-3t	Innco Systems GmbH	Turn Table	N/A	N/A
□ -	FMZB 1513	Schwarzbeck	LOOP ANTENNA	1513-235	May. 13, 2018 (2Y)
■ -	VULB9163	Schwarzbeck	TRILOG Broadband Antenna	9163-255	Jun 05, 2018 (2Y)
■ -	VULB9163	Schwarzbeck	Hybrid Antenna	777	Apr, 13, 2018 (2Y)
■ -	BBHA9120D	Schwarzbeck	Horn Antenna	9120D-1366	Jul. 16, 2019 (1Y)
■ -	BBHA9120D	Schwarzbeck	Horn Antenna	9120D-295	Jul. 16, 2019 (1Y)
□ -	SCU40A	Rohde & Schwarz	Pre-Amplifier	100436	Mar. 11, 2019 (1Y)
■ -	E5515C	Agilent	WIRELESS COMMUNICATIONS TEST SET	MY48360785	Mar. 11, 2019 (1Y)
■ -	GP-4303D	LG Precision Co.,Ltd	DC Power Supply	5071069	Jan. 10, 2019 (1Y)

All test equipment used is calibrated on a regular basis.

9.4 Test data for WCDMA Band 2

- Test Date : August 09, 2019 ~ August 23, 2019
- Detector : RMS
- Measurement distance : 3 m
- Result : PASSED

Frequency (MHz)	Substituted Level (dBm)	Ant. Pol. (H/V)	Cable Loss (dB)	Ant Gain (dBi)	Corrected Reading (dBm)	Limits (dBm)	Margin (dB)
Test Data for Low Channel							
3 704.80	-76.72	V	2.16	12.40	-66.48	-13.00	53.48
5 557.20	-74.22	H	2.81	13.21	-63.82	-13.00	50.82
7 409.60	-67.97	V	3.36	11.20	-60.13	-13.00	47.13
9 262.00	-64.76	V	4.13	11.05	-57.84	-13.00	44.84
11 114.40	-62.69	V	4.25	11.00	-55.94	-13.00	42.94
Test Data for Middle Channel							
3 760.00	-76.89	V	2.16	12.40	-66.65	-13.00	53.65
5 640.00	-74.13	V	2.81	13.21	-63.73	-13.00	50.73
7 520.00	-68.55	H	3.36	11.20	-60.71	-13.00	47.71
9 400.00	-64.57	H	4.13	11.05	-57.65	-13.00	44.65
11 280.00	-64.56	V	4.25	11.00	-57.81	-13.00	44.81
Test Data for High Channel							
3 815.20	-76.43	V	2.16	12.40	-66.19	-13.00	53.19
5 722.80	-74.07	V	2.81	13.21	-63.67	-13.00	50.67
7 630.40	-67.03	H	3.36	11.20	-59.19	-13.00	46.19
9 538.00	-63.89	V	4.13	11.05	-56.97	-13.00	43.97
11 445.60	-64.87	H	4.25	11.00	-58.12	-13.00	45.12

Remark: 1. The other Spurious RF Radiated emissions level is no more than noise floor.

2. The worst case was measured the highest power mode.

3. Rule Part 24.238(a) specifies that “on any frequency outside a licensee's frequency block, the power of any emission shall be attenuated below the transmitter power (P) by at least $43 + 10 \log_{10}(P)$ dB.”

Limit : $33.00 - 43 + 10 \log_{10}(2.00) = -13$ dBm

“C.L” : Cable Loss, “H”: Horizontal, “V”: Vertical

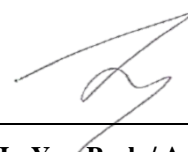

Tested by: Ju Yun Park / Assistant Manager

10. PEAK-TO-AVERAGE RATIO

10.1 Operating environment

Temperature : 24 °C
 Relative humidity : 47 % R.H.

10.2 Test set-up

Peak to Average Power Ratio is tested in accordance with KDB971168 D01 Power Meas License Digital Systems v04, April 9, 2018, Section 5.7.

- Section 5.7.2 Measurement of peak power in a broadband noise-like signal using CCDF

- a) Set resolution/measurement bandwidth \geq OBW or specified reference bandwidth.
- b) Set the number of counts to a value that stabilizes the measured CCDF curve.
- c) Set the measurement interval as follows:
 - 1) For continuous transmissions, set to the greater of $[10 \times (\text{number of points in sweep}) \times (\text{transmission symbol period})]$ or 1 ms.
 - 2) For burst transmissions, employ an external trigger that is synchronized with the EUT burst timing sequence, or use the internal burst trigger with a trigger level that allows the burst to stabilize. Set the measurement interval to a time that is less than or equal to the burst duration.
 - 3) If there are several carriers in a single antenna port, the peak power shall be determined for each individual carrier (by disabling the other carriers while measuring the required carrier) and the total peak power calculated from the sum of the individual carrier peak powers.
- d) Record the maximum PAPR level associated with a probability of 0.1%.
- e) The peak power level is calculated from the sum of the PAPR value from step d) to the measured average power.

- Section 5.7.3 Alternate Procedure for PAPR

Some regulatory requirements specify a PAPR limit when the output power limits are specified in terms of average power. If it becomes necessary to provide measurement data to demonstrate compliance to a PAPR limit, then the appropriate procedure from those provided in 5.2.3 shall be utilized to determine the peak power (or peak PSD) and the appropriate procedure from those provided in 5.2.4 shall be used to determine the average power (or average PSD). The data from these measurements is then used in Equation (2) to determine the PAPR of a narrowband CW-like signal. See 5.2.3.4 for guidance on determining the PAPR of a broadband noise-like signal.

$$\text{PAPR (dB)} = P_{\text{Pk}} \text{ (dBm or dBW)} - P_{\text{Avg}} \text{ (dBm or dBW)}$$

where

PAPR peak-to-average power ratio, in dB

P_{Pk} measured peak power or peak PSD level, in dBm or dBW

P_{Avg} measured average power or average PSD level, in dBm or dBW

10.3 Test equipment used

Model Number	Manufacturer	Description	Serial Number	Last Cal.
■ - FSV30	Rohde & Schwarz	Signal Analyzer	101372	Jul. 24, 2019 (1Y)
■ - AAMCS-UDC	AA-MCS	Directional Coupler	400	Jul. 25, 2019 (1Y)
■ - E5515C	Agilent	WIRELESS COMMUNICATIONS TEST SET	MY48360785	Mar. 11, 2019 (1Y)
■ - GP-4303D	LG Precision Co.,Ltd	DC Power Supply	5071069	Jan. 10, 2019 (1Y)

All test equipment used is calibrated on a regular basis.

10.4 Test data

- Test Date : August 09, 2019 ~ August 23, 2019
- Test Result : Pass

WCDMA Band 2

Band	Channel	Peak-Average Ratio(PAR) CCDF 0.1 %	Limit (dB)	Result
WCDMA Band 2	Low	2.93	13.00	PASS
	Middle	2.90	13.00	PASS
	High	2.81	13.00	PASS

Remark: Measured the using CCDFof spectrum analyzer.

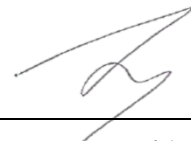

Tested by: Ju Yun Park / Assistant Manager

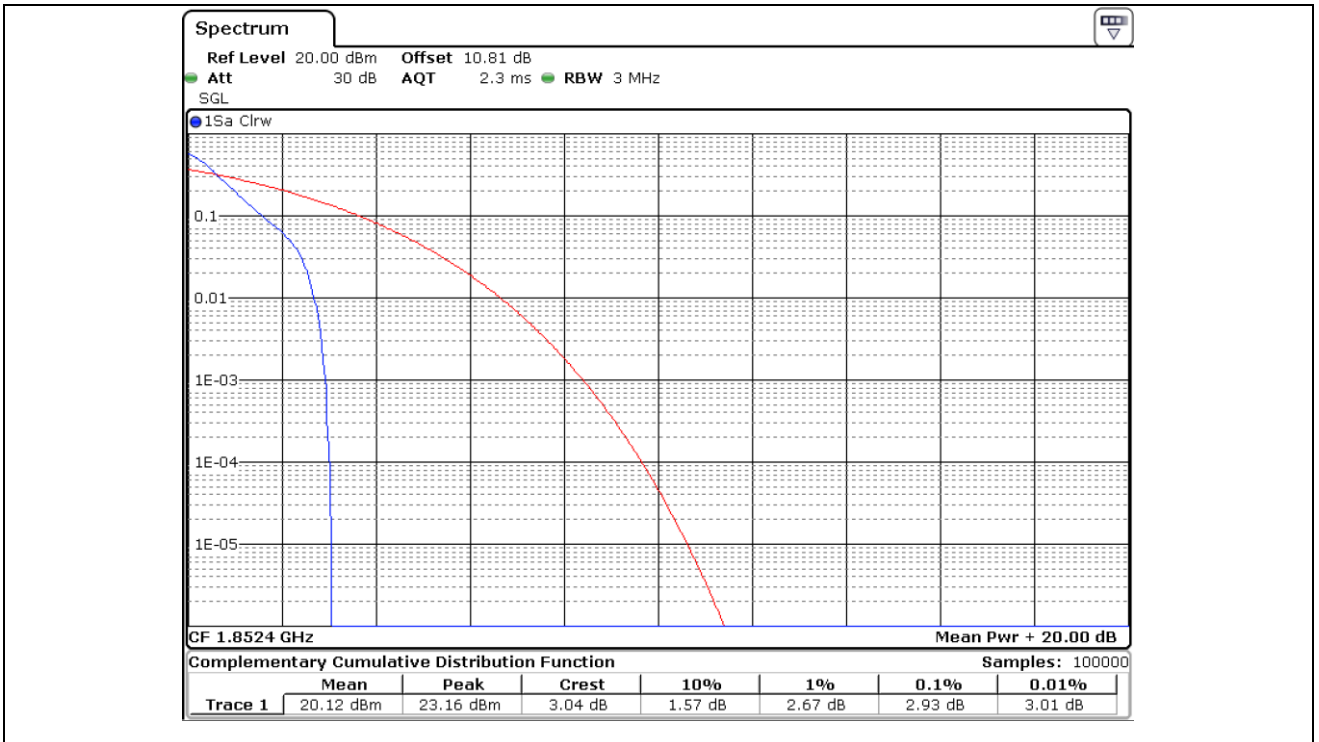

Low Channel

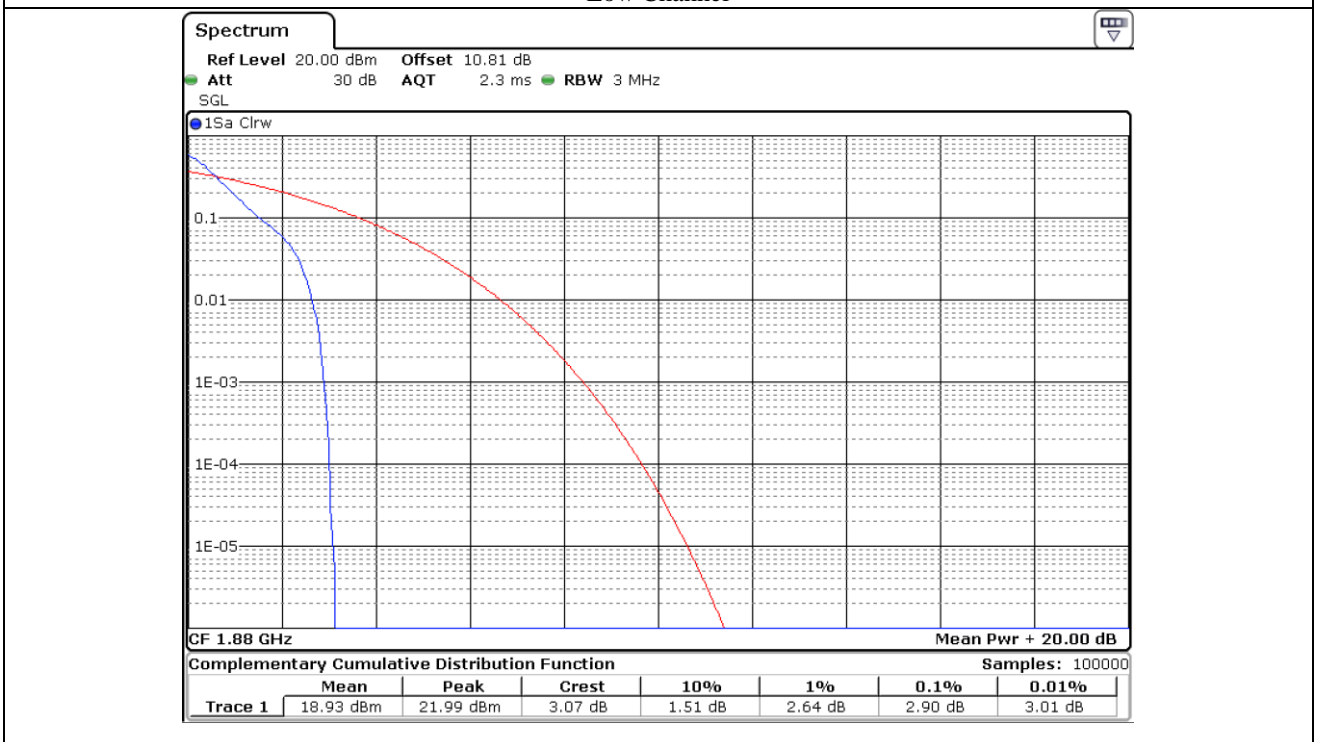

Middle Channel

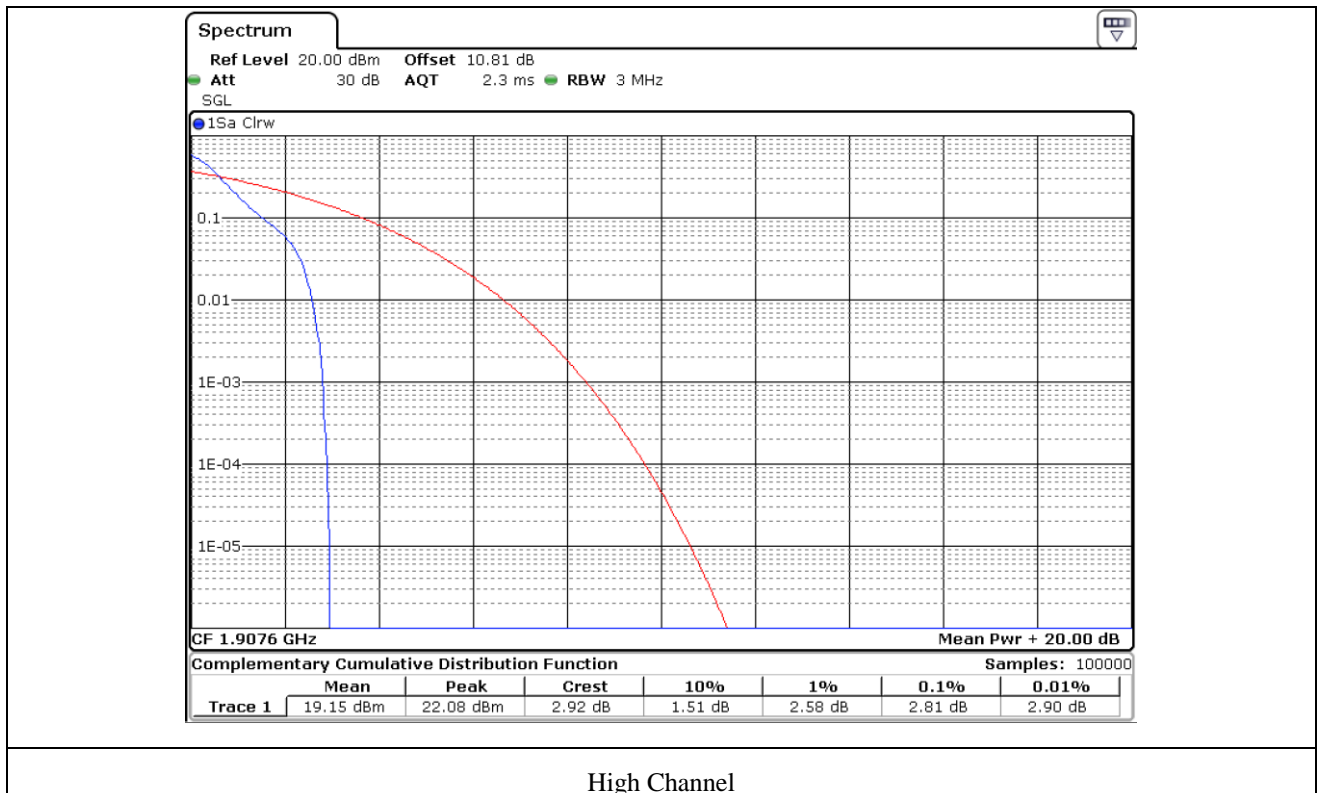

High Channel

11. OCCUPIED BANDWIDTH

11.1 Operating environment

Temperature : 24 °C
 Relative humidity : 47 % R.H.

11.2 Test set-up

The emission bandwidth (×dB) is defined as the frequency range between two points, one above and one below the carrier frequency, at which the spectral density of the emission is attenuated × dB below the maximum in-band spectral density of the modulated signal. Spectral density (power per unit bandwidth) is to be measured with a detector of resolution bandwidth in the range of 1% to 5% of the anticipated emission bandwidth, and a video bandwidth at least 3× the resolution bandwidth. When the occupied bandwidth limit is not stated in the applicable RSS or reference measurement method, the transmitted signal bandwidth shall be reported as the 99% emission bandwidth, as calculated or measured.

- The transmitter shall be operated at its maximum carrier power measured under normal test conditions.
- The span of the analyzer shall be set to capture all products of the modulation process, including the emission skirts.
- The resolution bandwidth (RBW) shall be in the range of 1% to 5% of the occupied bandwidth (OBW) and video bandwidth (VBW) shall be approximately 3×RBW.

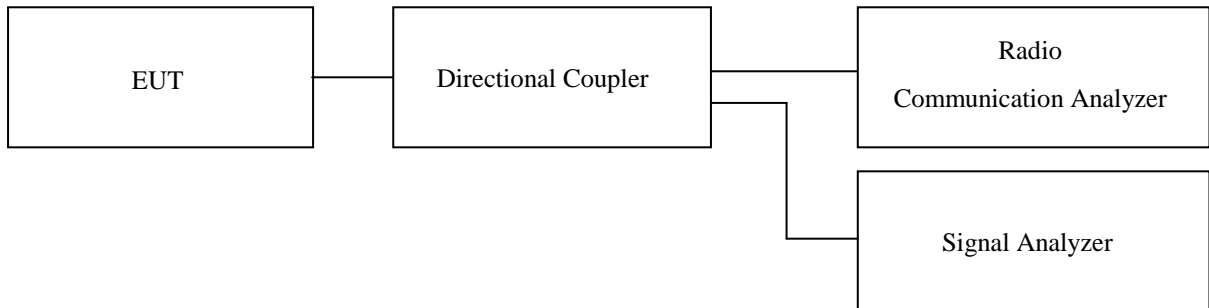

11.3 Test equipment used

Model Number	Manufacturer	Description	Serial Number	Last Cal.
■ - FSV30	Rohde & Schwarz	Signal Analyzer	101372	Jul. 24, 2019 (1Y)
■ - AAMCS-UDC	AA-MCS	Directional Coupler	400	Jul. 25, 2019 (1Y)
■ - E5515C	Agilent	WIRELESS COMMUNICATIONS TEST SET	MY48360785	Mar. 11, 2019 (1Y)
■ - GP-4303D	LG Precision Co.,Ltd	DC Power Supply	5071069	Jan. 10, 2019 (1Y)

All test equipment used is calibrated on a regular basis.

11.4 Test data for WCDMA Band 2

-. Test Date : August 09, 2019 ~ August 23, 2019

-. Test Result : Pass

Band	Channel	26 dB Bandwidth (MHz)	99 % Occupied Bandwidth (MHz)	Result
WCDMA Band 2	Low	4.625	4.066	PASS
	Middle	4.635	4.066	PASS
	High	4.645	4.066	PASS

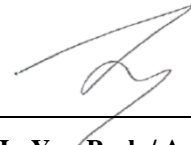

Tested by: Ju Yun Park / Assistant Manager

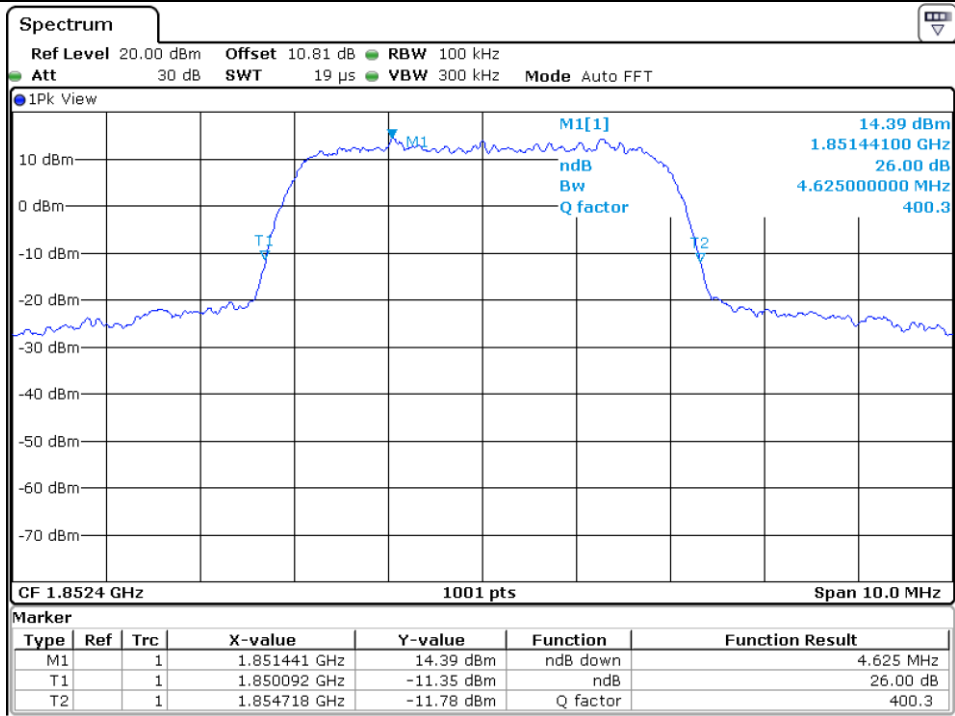

Low Channel (26 dB Bandwidth)

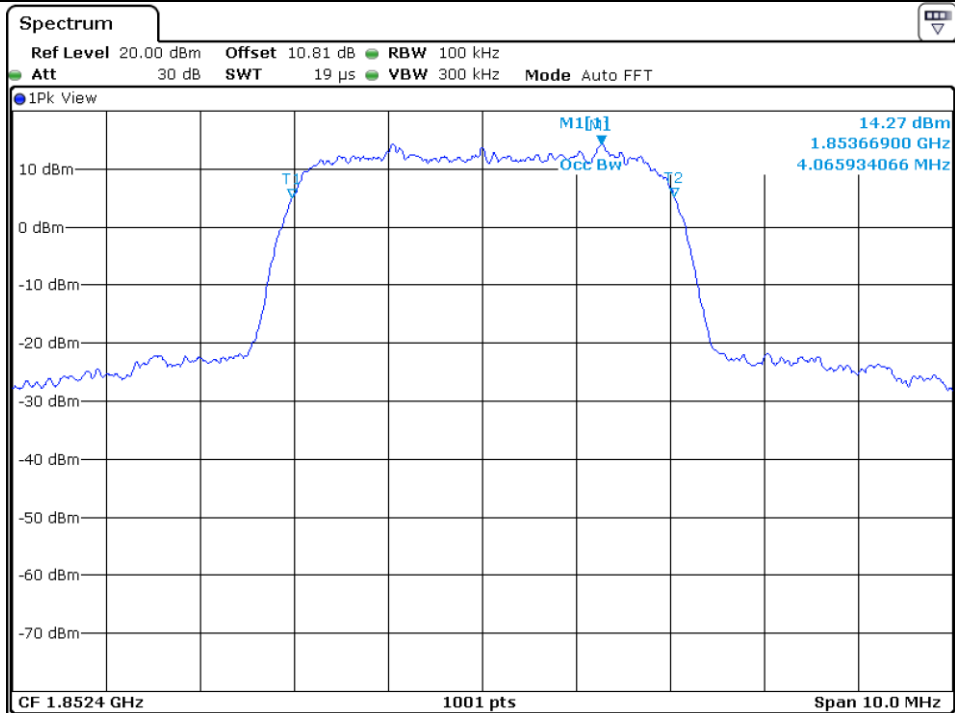

Low Channel (99 % Occupied Bandwidth)

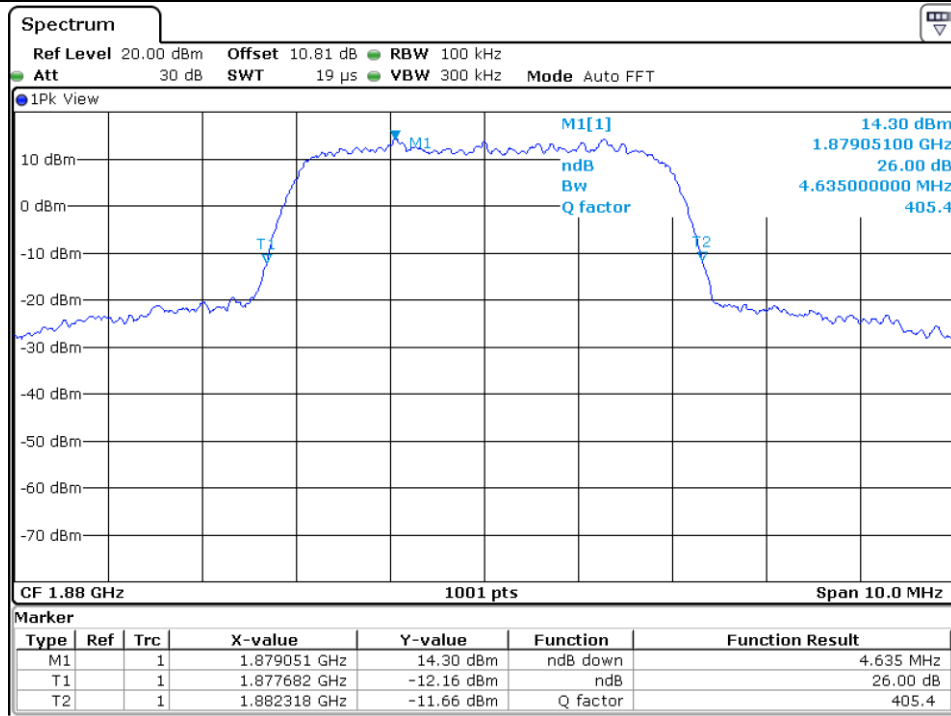

Middle Channel (26 dB Bandwidth)

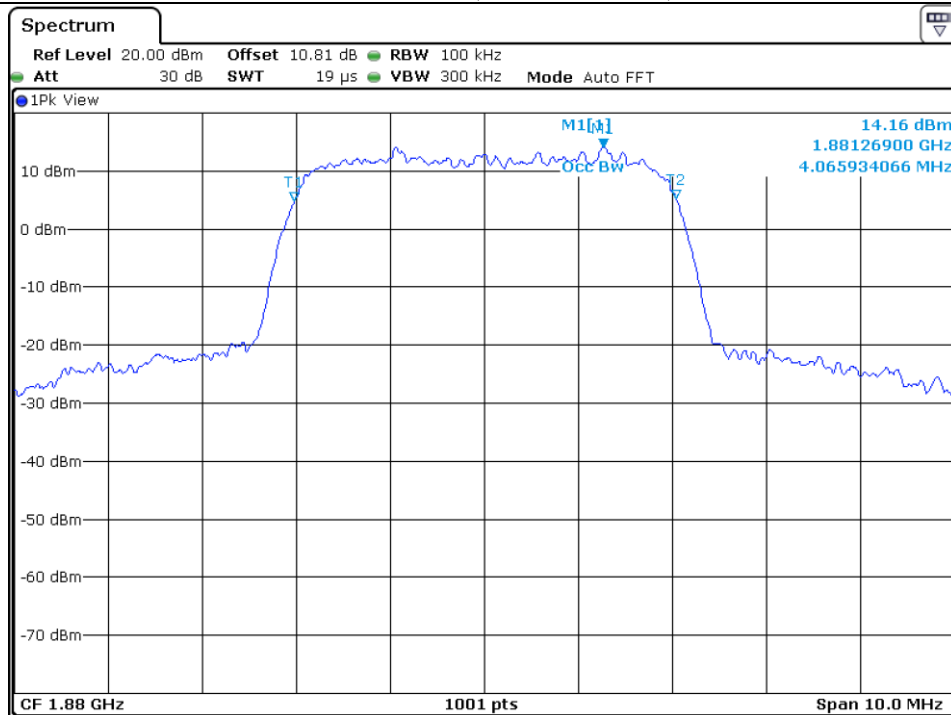

Middle Channel (99 % Occupied Bandwidth)

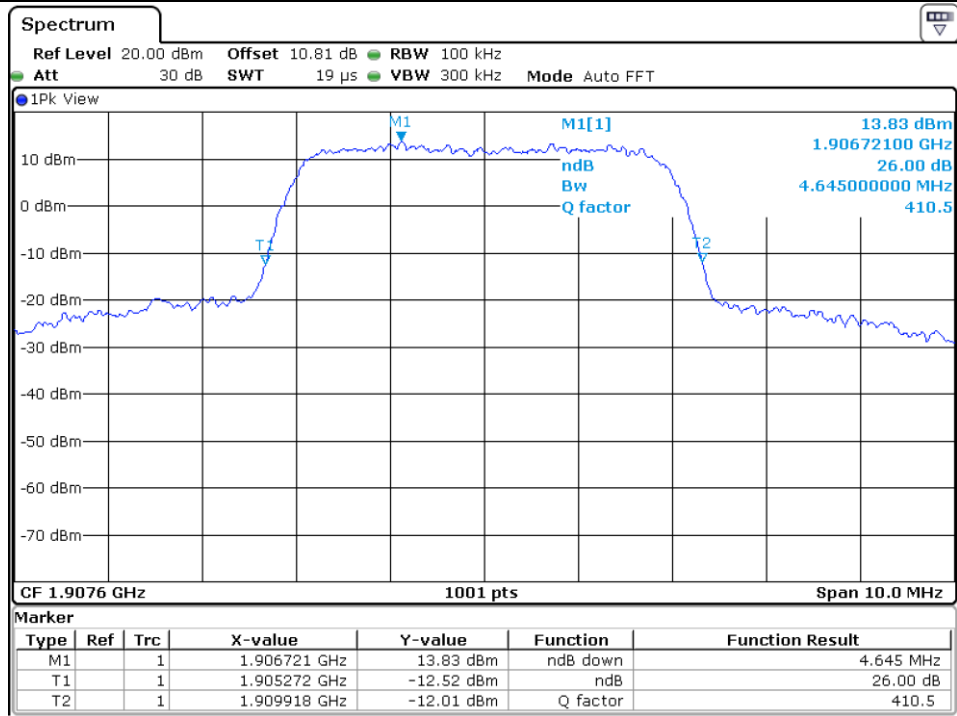

High Channel (26 dB Bandwidth)

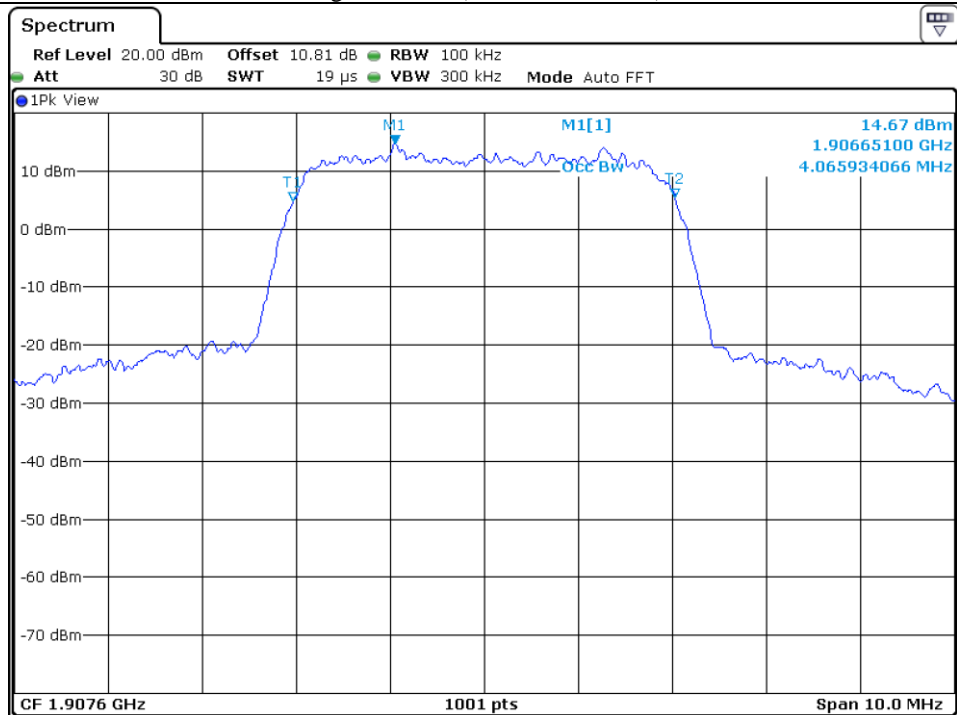

High Channel (99 % Occupied Bandwidth)

12. Conducted Band Edge

12.1 Operating environment

Temperature : 24 °C
 Relative humidity : 47 % R.H.

12.2 Test set-up

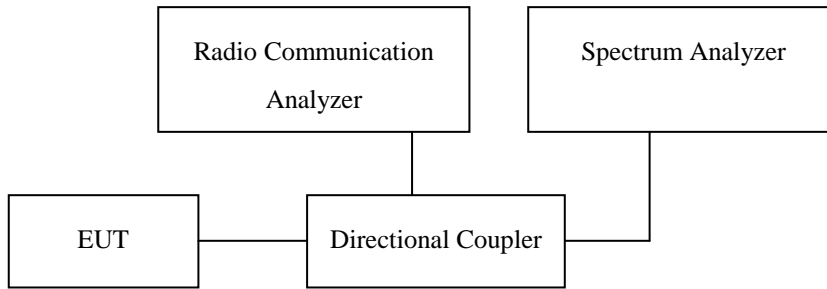

(Configuration of conducted Emission measurement)

Conducted Spurious Emissions is tested in accordance with KDB971168 D01 Power Meas License Digital Systems v04, April 9, 2018, Section 6.

The EUT makes a call to the communication simulator. The power was measured with R&S Spectrum Analyzer. All measurements were done at 3 channels(low, middle and high operational range.)

The Conducted Spurious Emissions used the power splitter via EUT RF power connector between simulation base station and spectrum analyzer.

The communication simulator station system controlled a EUT to export maximum output power under transmission mode and specific channel frequency.

12.3 Methods of Measurement

1. All measurements were done at low and high operational frequency range.
2. Set spectrum analyzer with RMS detector.
3. The center frequency of spectrum is the band edge frequency and set RBW of the spectrum is 20 kHz and VBW of the spectrum is 50 kHz

12.4 Limits

Rule Part 24.238(a) specifies that “on any frequency outside a licensee’s frequency block, the power of any emission shall be attenuated below the transmitter power (P) by at least 43 + 10 log10 (P) dB.”

$$\begin{aligned}
 &= P(W) - [43 + 10\log(P)](\text{dB}) \\
 &= [30+10\text{Log}(P)] (\text{dBm}) - [43 + 10\log(P)](\text{dB}) \\
 &= -13 \text{ dBm}
 \end{aligned}$$

Limit	-13 dBm
-------	---------

12.5 Test equipment used

Model Number	Manufacturer	Description	Serial Number	Last Cal.
■ - FSV30	Rohde & Schwarz	Signal Analyzer	101372	Jul. 24, 2019 (1Y)
■ - AAMCS-UDC	AA-MCS	Directional Coupler	400	Jul. 25, 2019 (1Y)
■ - E5515C	Agilent	WIRELESS COMMUNICATIONS TEST SET	MY48360785	Mar. 11, 2019 (1Y)
■ - GP-4303D	LG Precision Co.,Ltd	DC Power Supply	5071069	Jan. 10, 2019 (1Y)

All test equipment used is calibrated on a regular basis.

12.6 Test data

12.6.1 Test data for WCDMA Band 2

- Test Date : August 09, 2019 ~ August 23, 2019

- Test Result : Pass

Band	Channel	Edge Frequency (MHz)	MEASURED VLAUE (dBm)	Limit (dBm)	Result
WCDMA Band 2	Low	1 850.000 0	-31.22	-13.00	1850.0000
	High	1 910.000 0	-30.51	-13.00	1910.0000

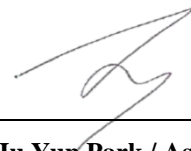

Tested by: Ju Yun Park / Assistant Manager

12.6.2 Test data for WCDMA Band 2

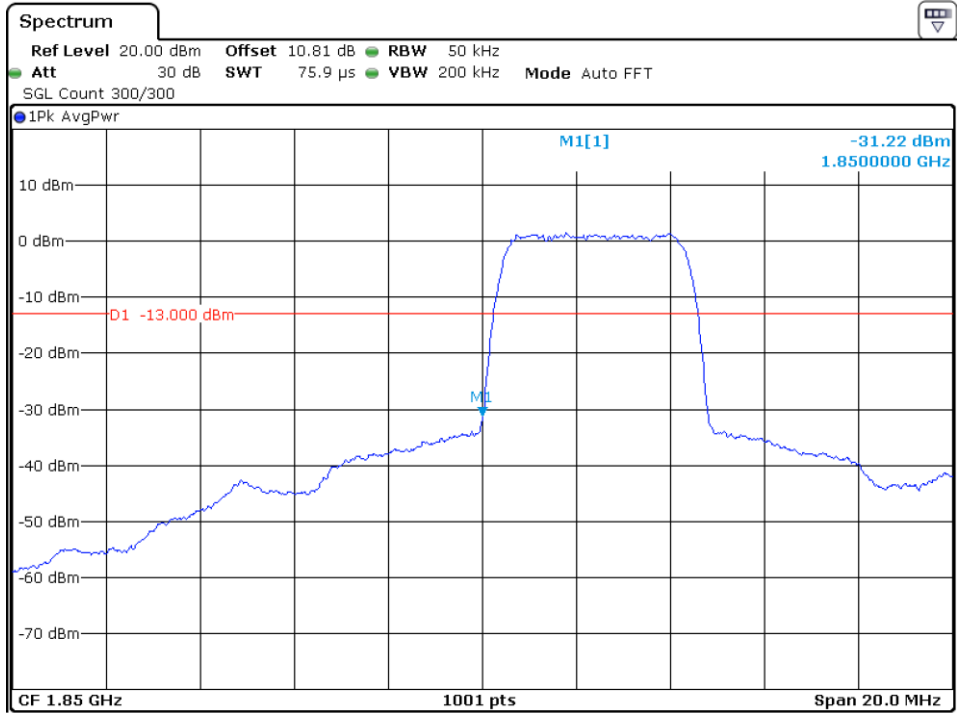

LOW Channel

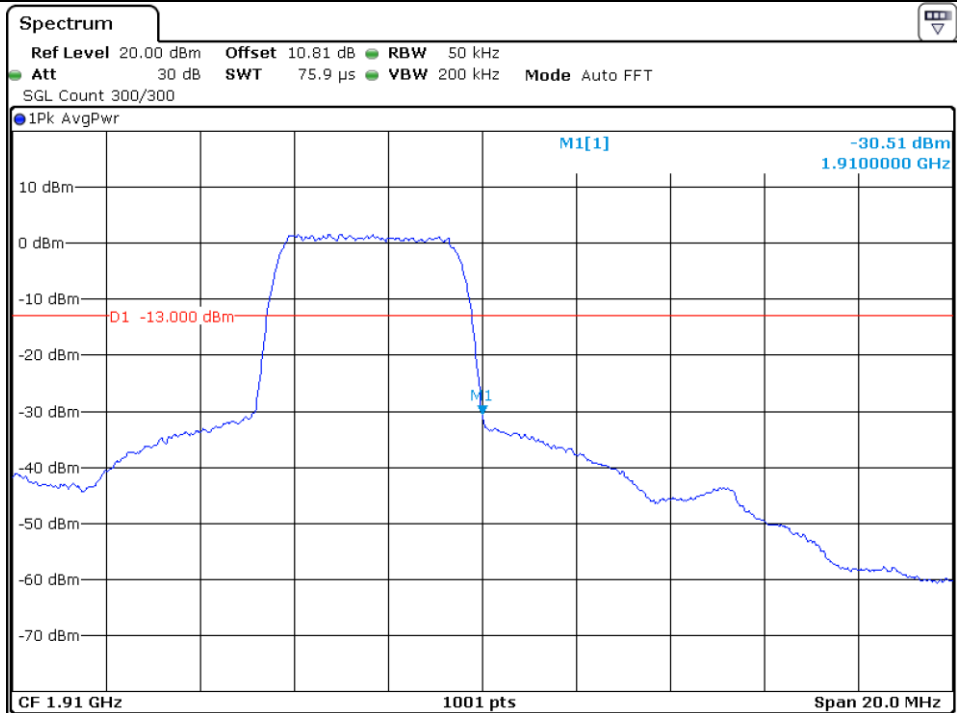

High Channel

13. Conducted Spurious and Harmonic Emissions at Antenna Termianl

13.1 Operating environment

Temperature : 24 °C
 Relative humidity : 47 % R.H.

13.2 Test set-up

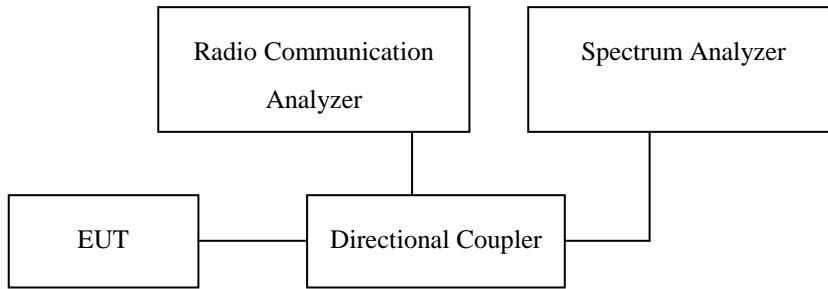

(Configuration of conducted Emission measurement)

Conducted Spurious Emissions is tested in accordance with KDB971168 D01 Power Meas License Digital Systems v04, April 9, 2018, Section 6.

The EUT makes a call to the communication simulator. The power was measured with R&S Spectrum Analyzer. All measurements were done at 3 channels(low, middle and high operational range.)

The Conducted Spurious Emissions used the power splitter via EUT RF power connector between simulation base station and spectrum analyzer.

The communication simulator station system controlled a EUT to export maximum output power under transmission mode and specific channel frequency.

Conduced spurious emissions

The EUT was setup to maximum output power. The 100 kHz RBW and 300 kHz VBW was used to scan from 30 MHz to 1 GHz. Also, the 1 MHz RBW and 3 MHz VBW was used to scan from 1 GHz to 20 GHz. The high, low and a middle channel were tested for out of band measurements.

13.3 Limits

Rule Part 24.238(a) specifies that “on any frequency outside a licensee’s frequency block, the power of any emission shall be attenuated below the transmitter power (P) by at least 43 + 10 log10 (P) dB.”

$$= P(W) - [43 + 10\log(P)](dB)$$

$$= [30+10\text{Log}(P)] (dBm) - [43 + 10\log(P)](dB)$$

$$= -13 dBm$$

Limit	-13 dBm
-------	---------

13.4 Test equipment used

	Model Number	Manufacturer	Description	Serial Number	Last Cal.
■ -	FSV30	Rohde & Schwarz	Signal Analyzer	101372	Jul. 24, 2019 (1Y)
■ -	AAMCS-UDC	AA-MCS	Directional Coupler	400	Jul. 25, 2019 (1Y)
■ -	E5515C	Agilent	WIRELESS COMMUNICATIONS TEST SET	MY48360785	Mar. 11, 2019 (1Y)
■ -	GP-4303D	LG Precision Co.,Ltd	DC Power Supply	5071069	Jan. 10, 2019 (1Y)

All test equipment used is calibrated on a regular basis.

13.5 Test data

13.5.1 Test data for WCDMA Band 2

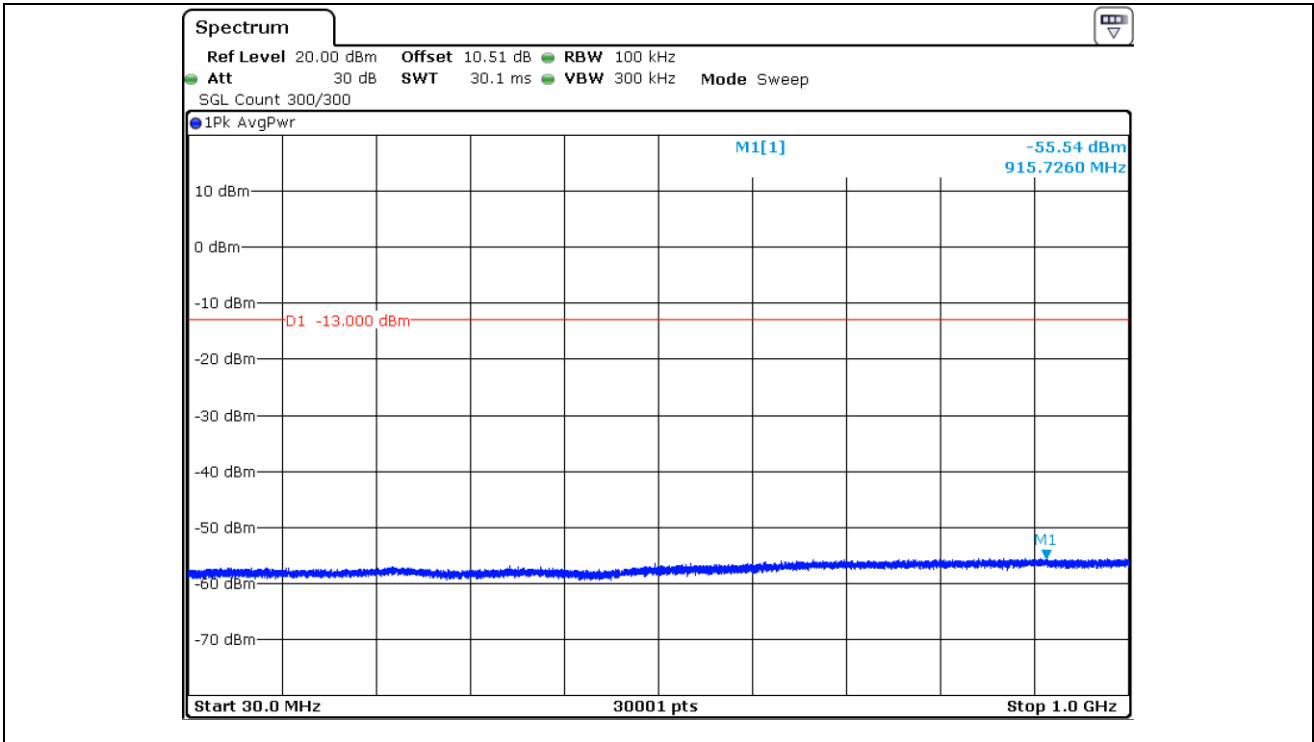

Low Channel

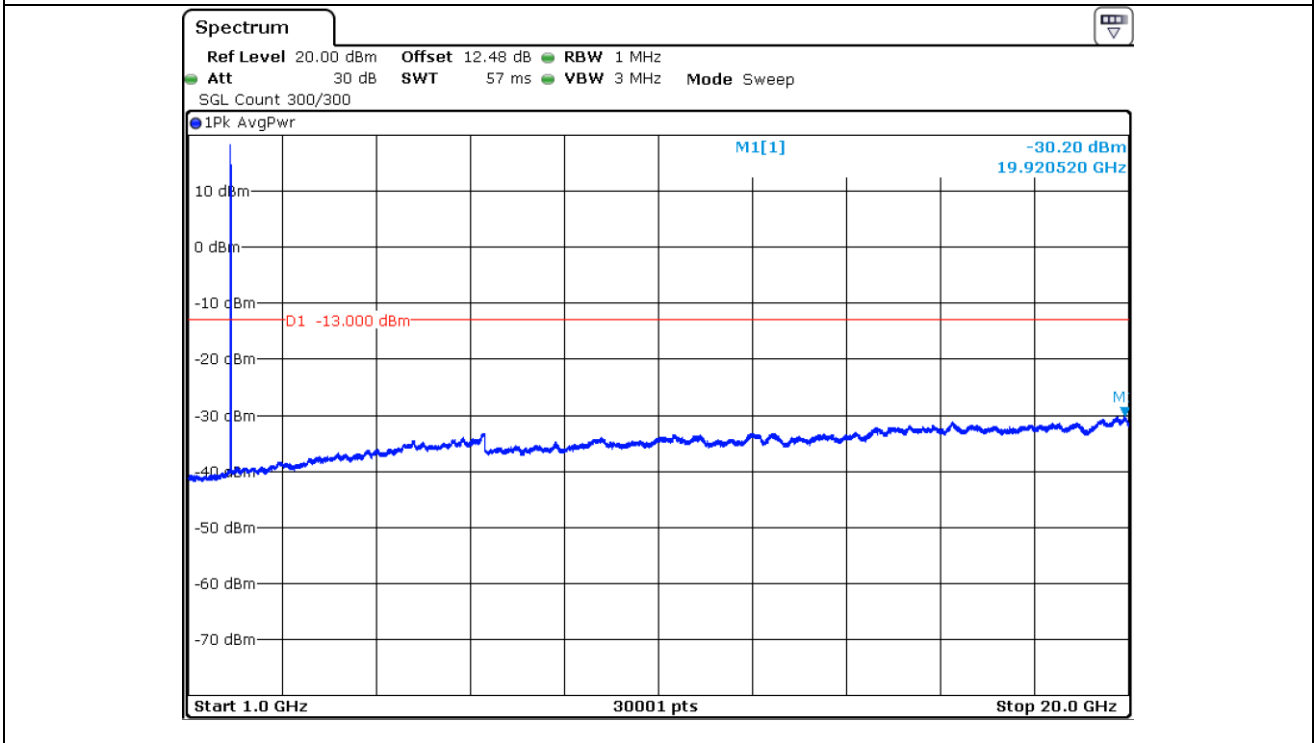

Low Channel

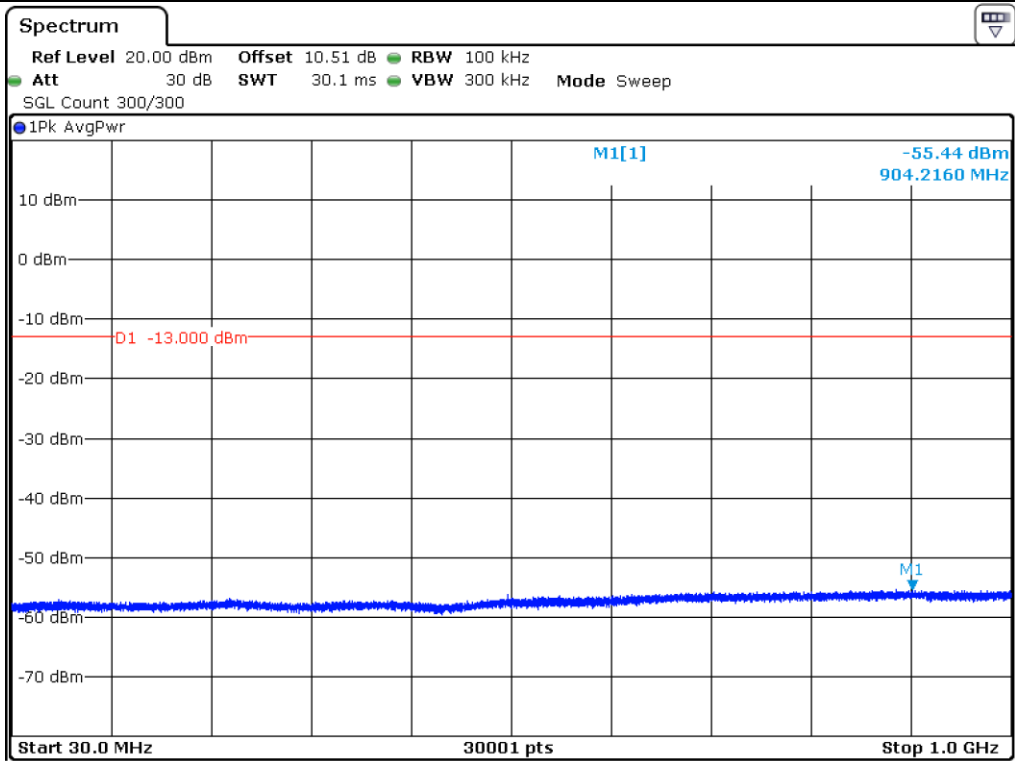

Midle Channel

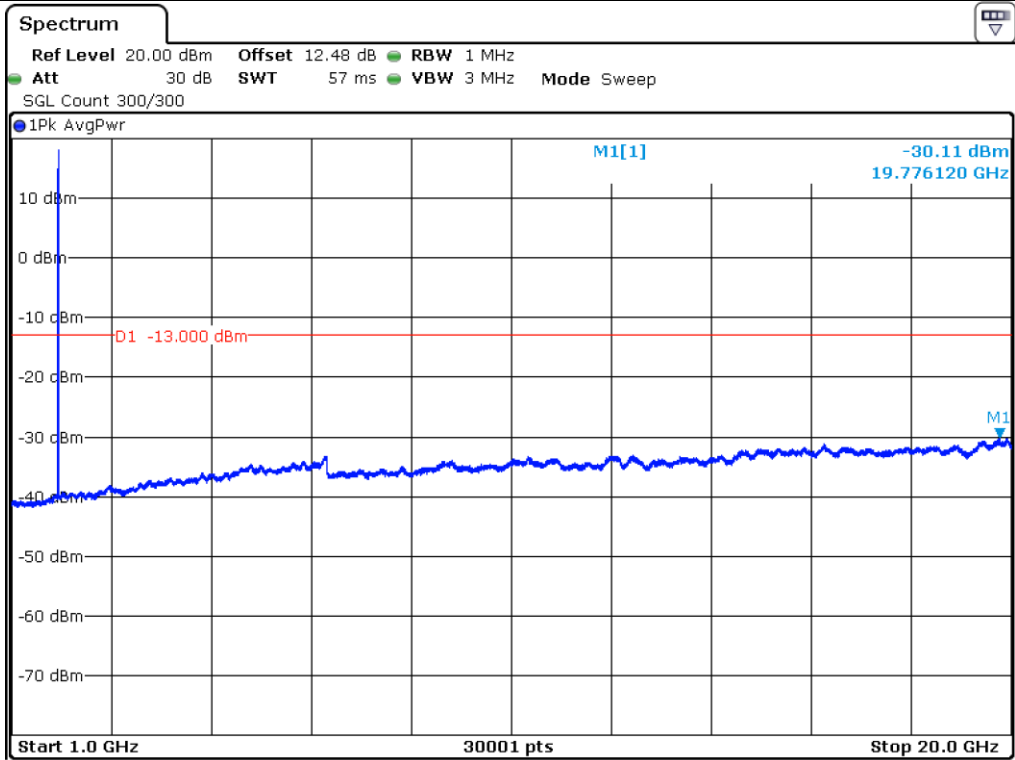

Midle Channel

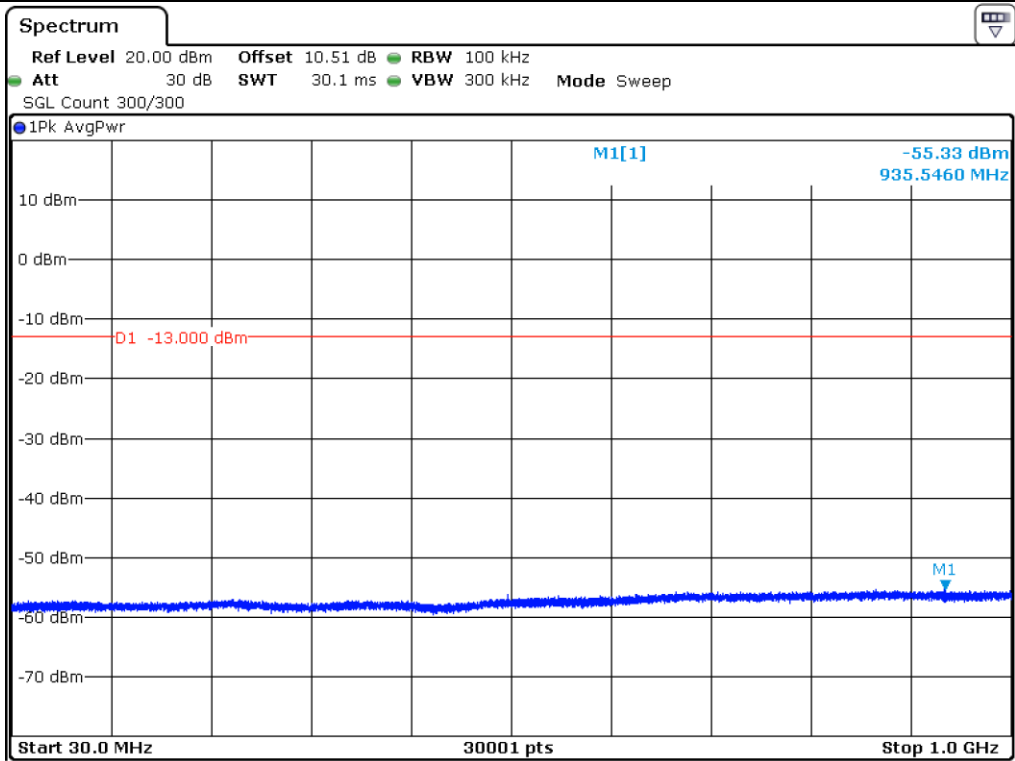

High Channel

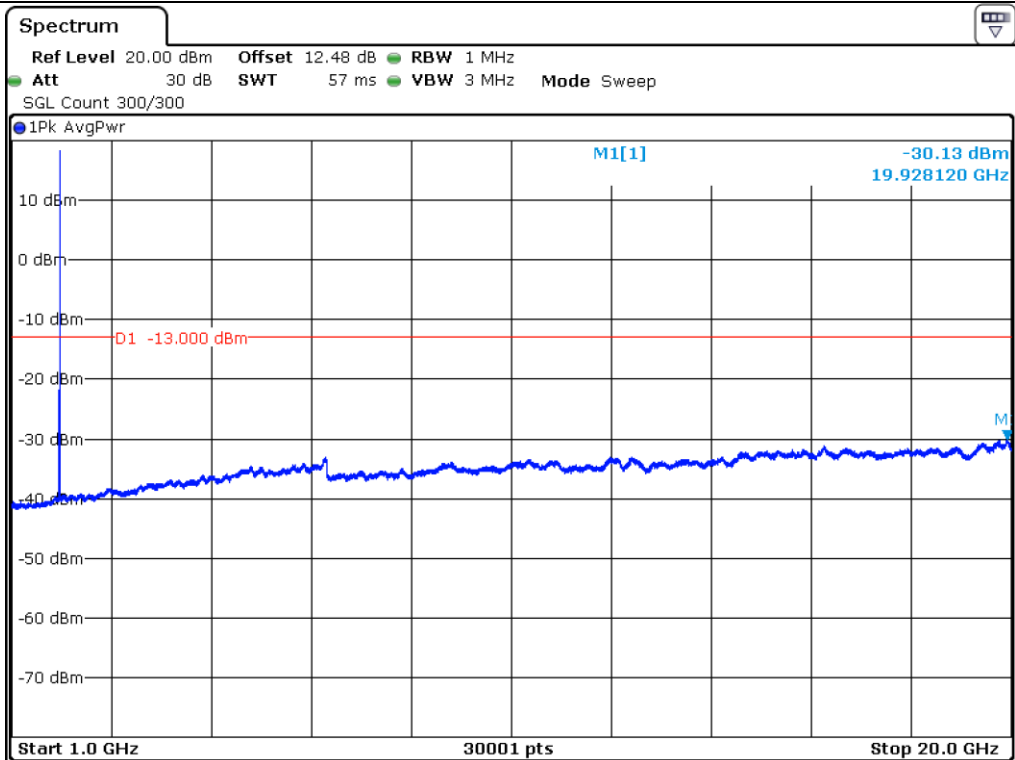

High Channel

14. FREQUENCY STABILITY / VARIATION OF AMBIENT TEMPERATURE

14.1 Operating environment

Temperature : 24 °C
 Relative humidity : 47 % R.H.

14.2 Test set-up

1. Frequency Stability (Voltage Variation)

+20 °C temperature and ±15% supply voltage variations. If a product is specified to operate over a range of input voltage then the -15% variation is applied to the lowermost voltage and the +15% is applied to the uppermost voltage.

- (1) Vary primary supply voltage from ±15% of the nominal value for other than hand carried battery equipment.
- (2) For hand carried, battery powered equipment, reduce primary supply voltage to the battery-operating end point which shall be specified by the manufacturer.

2. Frequency Stability (Temperature Variation)

Turn EUT off and set chamber temperature to -30 °C and then allow sufficient time (approximately 20 to 30 minutes after chamber reach the assigned temperature) for EUT to stabilize. Turn ON EUT and measure the EUT operating frequency and then turn off the EUT after the measurement. The temperature in the chamber was raised 10 °C step from -30 °C to +50 °C. Repeat above method for frequency measurements every 10 °C step and then record all measured frequencies on each temperature step.

14.3 Test equipment used

Model Number	Manufacturer	Description	Serial Number	Last Cal.
■ - FSV30	Rohde & Schwarz	Signal Analyzer	101372	Jul. 24, 2019 (1Y)
■ - AAMCS-UDC	AA-MCS	Directional Coupler	400	Jul. 25, 2019 (1Y)
■ - E5515C	Agilent	WIRELESS COMMUNICATIONS TEST SET	MY48360785	Mar. 11, 2019 (1Y)
■ - PSL-2KP	ESPEC	Environmental Test Chamber	14009407	Feb. 22, 2019 (1Y)
■ - GP-4303D	LG Precision Co.,Ltd	DC Power Supply	5071069	Jan. 10, 2019 (1Y)

All test equipment used is calibrated on a regular basis.

14.4 Test data

14.4.1 Test data for Voltage(V)

Temperature(° C)	Power(VDC)	Center Freq.	Measured Freq.	PPM
20	12.0	1 880 000 000	1 880 000 004	0.0021
	10.2		1 879 999 998	-0.0011
	13.8		1 880 000 003	0.0016

14.4.2 Test data for Temperature(° C)

Temperature(° C)	Power(VDC)	Center Freq.	Measured Freq.	PPM
-30	12	1 880 000 000	1 879 999 989	-0.005 9
-20			1 879 999 986	-0.007 4
-10			1 879 999 992	-0.004 3
0			1 879 999 996	-0.002 1
10			1 879 999 997	-0.001 6
20			1 880 000 004	0.002 1
30			1 879 999 998	-0.001 1
40			1 880 000 002	0.001 1
50			1 880 000 007	0.003 7



Tested by: Ju Yun Park / Assistant Manager