

FCC GSM REPORT

FCC Certification

Applicant Name:
 Suntech International Ltd.

Address:
 B-1506, Greatvally, 32, 9-Gil, Digital-Ro, Geumcheon-Gu,
 Seoul, Korea

Date of Issue:

June 11, 2015

Test Site/Location:

HCT CO., LTD., 74, Seoicheon-ro 578beon-gil,
 Majang-myeon, Icheon-si, Gyeonggi-do, Korea

Report No.: HCT-R-1506-F021

HCT FRN: 0005866421

FCC ID: WA2ST300

APPLICANT: Suntech International Ltd.

FCC Model(s): ST300
EUT Type: Vehicle Tracker
FCC Classification: PCS Licensed Transmitter (PCB)
FCC Rule Part(s): §22, §24, §2

Mode	Tx Frequency (MHz)	Rx Frequency (MHz)	Emission Designator	ERP	
				Max. Power (W)	Max. Power (dBm)
GSM850	824.2 – 848.8	869.2 – 893.8	243 KGXW	0.663	28.22

Mode	Tx Frequency (MHz)	Rx Frequency (MHz)	Emission Designator	EIRP	
				Max. Power (W)	Max. Power (dBm)
GSM1900	1850.2 – 1909.8	1930.2 – 1989.8	245 KGXW	1.234	30.91

The measurements shown in this report were made in accordance with the procedures specified in CFR47 section §2.947. I assume full responsibility for the accuracy and completeness of these measurements, and for the qualifications of all persons taking them.

HCT CO., LTD. Certifies that no party to this application has subject to a denial of Federal benefits that includes FCC benefits pursuant to section 5301 of the Anti-Drug Abuse Act of 1998,21 U.S. C.853(a)



Report prepared by
: Kyoung Houn Seo
Test engineer of RF Team



Approved by
: Sang Jun Lee
Manager of RF Team

This report only responds to the tested sample and may not be reproduced, except in full, without written approval of the HCT Co., Ltd.

Version

TEST REPORT NO.	DATE	DESCRIPTION
HCT-R-1506-F021	June 11, 2015	- First Approval Report

Table of Contents

1. GENERAL INFORMATION	4
2. INTRODUCTION	5
2.1. EUT DESCRIPTION.....	5
2.2. MEASURING INSTRUMENT CALIBRATION.....	5
2.3. TEST FACILITY	5
3. DESCRIPTION OF TESTS	6
3.1 CONDUCTED OUTPUT POWER	6
3.1 ERP/EIRP RADIATED POWER AND RADIATED SPURIOUS EMISSIONS.....	8
3.2 PEAK- TO- AVERAGE RATIO	9
3.3 OCCUPIED BANDWIDTH.	11
3.4 SPURIOUS AND HARMONIC EMISSIONS AT ANTENNA TERMINAL.....	12
3.5 FREQUENCY STABILITY / VARIATION OF AMBIENT TEMPERATURE	13
4. LIST OF TEST EQUIPMENT	14
5. SUMMARY OF TEST RESULTS	15
6. SAMPLE CALCULATION	16
7. TEST DATA	17
7.1 CONDUCTED OUTPUT POWER	17
7.1 EFFECTIVE RADIATED POWER	18
7.2 EQUIVALENT ISOTROPIC RADIATED POWER	19
7.3 RADIATED SPURIOUS EMISSIONS	20
7.3.1 RADIATED SPURIOUS EMISSIONS (GSM850)	20
7.3.2 RADIATED SPURIOUS EMISSIONS (GSM1900)	21
7.4 PEAK-TO-AVERAGE RATIO	22
7.5 OCCUPIED BANDWIDTH	22
7.6 CONDUCTED SPURIOUS EMISSIONS	23
7.6.1 BAND EDGE.....	23
7.7 FREQUENCY STABILITY / VARIATION OF AMBIENT TEMPERATURE	24
7.7.1 FREQUENCY STABILITY (GSM850).....	24
7.7.2 FREQUENCY STABILITY (GSM1900).....	25
8. TEST PLOTS.....	26

MEASUREMENT REPORT

1. GENERAL INFORMATION

Applicant Name: Suntech International Ltd.

Address: B-1506, Greatvally, 32, 9gil, Digital-ro, Geumcheon-gu, Seoul, Korea

FCC ID: WA2ST300

Application Type: Certification

FCC Classification: PCS Licensed Transmitter (PCB)

FCC Rule Part(s): §22, §24, §2

EUT Type: Vehicle Tracker

FCC Model(s): ST300

Tx Frequency: 824.20 - 848.80 MHz (GSM850)
1 850.20 - 1 909.80 MHz (GSM1900)

Rx Frequency: 869.20 - 893.80 MHz (GSM850)
1 930.20 - 1 989.80 MHz (GSM1900)

Max. RF Output Power: 0.663 W GSM850 (28.22 dBm) / 1.234 W GSM1900 (30.91 dBm)

Emission Designator(s): 243 KGXW (GSM850) 245 KGXW (GSM1900)

Date(s) of Tests: May 20, 2015 ~ June 10, 2015

Antenna Specification Manufacturer: DONGNAM Co., Ltd.
Antenna type: Internal Antenna
Peak Gain: GSM850 : -1.5 dBi
GSM1900 : -1.2 dBi

2. INTRODUCTION

2.1. EUT DESCRIPTION

The Suntech International Ltd. ST300 Vehicle Tracker consists of GPRS Class10, GSM850 and GSM1900.

2.2. MEASURING INSTRUMENT CALIBRATION

The measuring equipment, which was utilized in performing the tests documented herein, has been calibrated in accordance with the manufacturer's recommendations for utilizing calibration equipment, which is traceable to recognized national standards.

2.3. TEST FACILITY

The Fully-anechoic chamber and conducted measurement facility used to collect the radiated data are located at the **74, Seoicheon-ro 578beon-gil, Majang-myeon, Icheon-si, Gyeonggi-do, Korea.**

3. DESCRIPTION OF TESTS

3.1 CONDUCTED OUTPUT POWER

Test Procedure

Conducted Output Power is tested in accordance with KDB971168 D01 Power Meas License Digital Systems v02r02, October 17, 2014, Section 5.2.

5.2.1 Procedure for use with a spectrum/signal analyzer when EUT can be configured to transmit continuously or when sweep triggering/signal gating can be properly implemented

The EUT is considered to transmit continuously if it can be configured to transmit at a burst duty cycle of greater than or equal to 98% throughout the duration of the measurement. If this condition can be achieved, then the following procedure can be used to measure the average output power of the EUT.

This procedure can also be used when the EUT cannot be configured to transmit continuously, provided that the measurement instrument can be configured to trigger a sweep at the beginning of each full-power transmission burst, and the sweep time is less than or equal to the minimum transmission time during each burst (*i.e.*, no burst off-time is to be included in the measurement).

- a) Set span to at least 1.5 times the OBW.
- b) Set RBW = 1-5% of the OBW, not to exceed 1 MHz.
- c) Set VBW $\geq 3 \times$ RBW.
- d) Set number of points in sweep $\geq 2 \times$ span / RBW.
- e) Sweep time = auto-couple.
- f) Detector = RMS (power averaging).
- g) If the EUT can be configured to transmit continuously (*i.e.*, burst duty cycle $\geq 98\%$), then set the trigger to free run.
- h) If the EUT cannot be configured to transmit continuously (*i.e.*, burst duty cycle $< 98\%$), then use a sweep trigger with the level set to enable triggering only on full power bursts and configure the EUT to transmit at full power for the entire duration of each sweep. Ensure that the sweep time is less than or equal to the transmission burst duration.
- i) Trace average at least 100 traces in power averaging (*i.e.*, RMS) mode.
- j) Compute the power by integrating the spectrum across the OBW of the signal using the instrument's band power measurement function, with the band limits set equal to the OBW band edges. If the instrument does not have a band power function, then sum the spectrum levels (in linear power units) at intervals equal to the RBW extending across the entire OBW of the spectrum.

5.2.2 Procedures for use with a spectrum/signal analyzer when EUT cannot be configured to transmit continuously and sweep triggering/signal gating cannot be properly implemented

If the EUT cannot be configured to transmit continuously (burst duty cycle $< 98\%$), then one of the following procedures can be used. The selection of the applicable procedure will depend on the characteristics of the

measured burst duty cycle.

Measure the burst duty cycle with a spectrum/signal analyzer or EMC receiver can be used in zero-span mode if the response time and spacing between bins on the sweep are sufficient to permit accurate measurement of the burst on/off time of the transmitted signal.

5.2.2.2 Constant burst duty cycle

If the measured burst duty cycle is constant (i.e., duty cycle variations are less than ± 2 percent), then:

- a) Set span to at least 1.5 times the OBW.
- b) Set RBW = 1-5% of the OBW, not to exceed 1 MHz.
- c) Set VBW $\geq 3 \times$ RBW.
- d) Number of points in sweep $\geq 2 \times$ span / RBW. (This gives bin-to-bin spacing \leq RBW/2, so that narrowband signals are not lost between frequency bins.)
- e) Sweep time = auto.
- f) Detector = RMS (power averaging).
- g) Set sweep trigger to "free run".
- h) Trace average at least 100 traces in power averaging (i.e., RMS) mode.
- i) Compute power by integrating the spectrum across the OBW of the signal using the instrument's band power measurement function with band limits set equal to the OBW band edges. If the instrument does not have a band power function, sum the spectrum levels (in power units) at intervals equal to the RBW extending across the entire OBW of the spectrum.
- j) Add $10 \log (1/x)$, where x is the duty cycle, to the measured power in order to compute the average power during the actual transmission times (because the measurement represents an average over both the on and off times of the transmission).

For example, add $10 \log (1/0.25) = 6$ dB if the duty cycle is a constant 25%.

3.1 ERP/EIRP RADIATED POWER AND RADIATED SPURIOUS EMISSIONS

Note: ERP(Effective Radiated Power), EIRP(Effective Isotropic Radiated Power)

Test Procedure

Radiated emission measurements are performed in the Fully-anechoic chamber. The equipment under test is placed on a non-conductive table 3-meters away from the receive antenna in accordance with ANSI/TIA-603-D-2010 Clause 2.2.17. The turntable is rotated through 360 degrees, and the receiving antenna scans in order to determine the level of the maximized emission. The level and position of the maximized emission is recorded with the spectrum analyzer using RMS detector.

A half wave dipole is then substituted in place of the EUT. For emissions above 1GHz, a horn antenna is substituted in place of the EUT. The substitute antenna is driven by a signal generator and the previously recorded signal was duplicated.

The power is calculated by the following formula;

$$P_{d(dBm)} = P_{g(dBm)} - \text{cable loss}_{(dB)} + \text{antenna gain}_{(dB)}$$

Where: P_d is the dipole equivalent power and P_g is the generator output power into the substitution antenna.

The maximum EIRP is calculated by adding the forward power to the calibrated source plus its appropriate gain value. These steps are repeated with the receiving antenna in both vertical and horizontal polarization. the difference between the gain of the horn and an isotropic antenna are taken into consideration

Radiated spurious emissions

1. Frequency Range : 30 MHz ~ 10th Harmonics of highest channel fundamental frequency.
2. The EUT was setup to maximum output power. The 100 kHz RBW was used to scan from 30 MHz to 1 GHz. Also, the 1 MHz RBW was used to scan from 1 GHz to 10 GHz(GSM850) or 20 GHz(GSM1900). The high, low and a middle channel were tested for out of band measurements.

3.2 PEAK- TO- AVERAGE RATIO

Test Procedure

Peak to Average Power Ratio is tested in accordance with KDB971168 D01 Power Meas License Digital Systems v02r02, October 17, 2014, Section 5.7.

- Section 5.7.1 CCDF Procedure for PAPR

- a) Set resolution/measurement bandwidth \geq signal's occupied bandwidth;
- b) Set the number of counts to a value that stabilizes the measured CCDF curve;
- c) Set the measurement interval as follows:
 - 1) for continuous transmissions, set to 1 ms,
 - 2) for burst transmissions, employ an external trigger that is synchronized with the EUT burst timing sequence, or use the internal burst trigger with a trigger level that allows the burst to stabilize and set the measurement interval to a time that is less than or equal to the burst duration.
- d) Record the maximum PAPR level associated with a probability of 0.1%.

- Section 5.7.2 Alternate Procedure for PAPR

Use one of the procedures presented in 5.1 to measure the total peak power and record as P_{Pk} . Use one of the applicable procedures presented 5.2 to measure the total average power and record as P_{Avg} . Determine the P.A.R. from: $P.A.R_{(dB)} = P_{Pk (dBm)} - P_{Avg (dBm)}$ (P_{Avg} = Average Power + Duty cycle Factor)

5.1.1 Peak power measurements with a spectrum/signal analyzer or EMI receiver

The following procedure can be used to determine the total peak output power.

- a) Set the RBW \geq OBW.
- b) Set VBW $\geq 3 \times$ RBW.
- c) Set span $\geq 2 \times$ RBW
- d) Sweep time = auto couple.
- e) Detector = peak.
- f) Ensure that the number of measurement points \geq span/RBW.
- g) Trace mode = max hold.
- h) Allow trace to fully stabilize.
- i) Use the peak marker function to determine the peak amplitude level.

5.2.2 Procedures for use with a spectrum/signal analyzer when EUT cannot be configured to transmit continuously and sweep triggering/signal gating cannot be properly implemented

If the EUT cannot be configured to transmit continuously (burst duty cycle < 98%), then one of the following procedures can be used. The selection of the applicable procedure will depend on the characteristics of the measured burst duty cycle.

Measure the burst duty cycle with a spectrum/signal analyzer or EMC receiver can be used in zero-span mode if the response time and spacing between bins on the sweep are sufficient to permit accurate measurement of the burst on/off time of the transmitted signal.

5.2.2.2 Constant burst duty cycle

If the measured burst duty cycle is constant (i.e., duty cycle variations are less than ± 2 percent), then:

- a) Set span to at least 1.5 times the OBW.
- b) Set RBW = 1-5% of the OBW, not to exceed 1 MHz.
- c) Set VBW $\geq 3 \times$ RBW.
- d) Number of points in sweep $\geq 2 \times$ span / RBW. (This gives bin-to-bin spacing \leq RBW/2, so that narrowband signals are not lost between frequency bins.)
- e) Sweep time = auto.
- f) Detector = RMS (power averaging).
- g) Set sweep trigger to "free run".
- h) Trace average at least 100 traces in power averaging (i.e., RMS) mode.
- i) Compute power by integrating the spectrum across the OBW of the signal using the instrument's band power measurement function with band limits set equal to the OBW band edges. If the instrument does not have a band power function, sum the spectrum levels (in power units) at intervals equal to the RBW extending across the entire OBW of the spectrum.
- j) Add $10 \log (1/x)$, where x is the duty cycle, to the measured power in order to compute the average power during the actual transmission times (because the measurement represents an average over both the on and off times of the transmission).

For example, add $10 \log (1/0.25) = 6$ dB if the duty cycle is a constant 25%.

3.3 OCCUPIED BANDWIDTH.

Test set-up

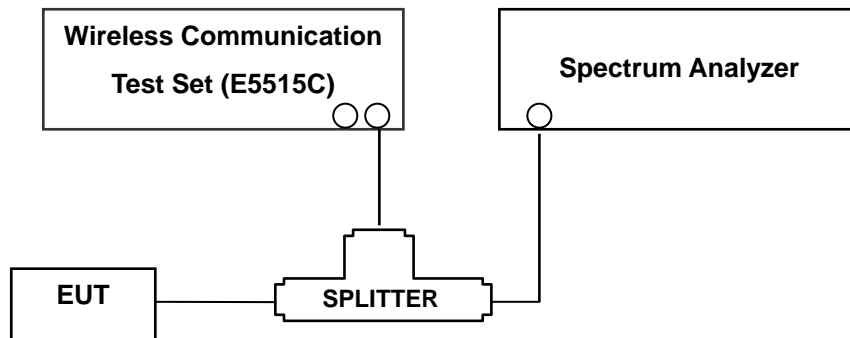

(Configuration of conducted Emission measurement)

The width of a frequency band such that, below the lower and above the upper frequency limits, the mean powers emitted are each equal to a specified percentage 0.5 % of the total mean power of a given emission.

Test Procedure

OBW is tested in accordance with KDB971168 D01 Power Meas License Digital Systems v02r02, October 17, 2014, Section 4.2.

The EUT makes a call to the communication simulator. The power was measured with R&S Spectrum Analyzer. All measurements were done at 3 channels(low, middle and high operational range.)

The conducted occupied bandwidth used the power splitter via EUT RF power connector between simulation base station and spectrum analyzer.

The communication simulator station system controlled a EUT to export maximum output power under transmission mode and specific channel frequency. Use OBW measurement function of Spectrum analyzer to measure 99 % occupied bandwidth

3.4 SPURIOUS AND HARMONIC EMISSIONS AT ANTENNA TERMINAL.

Test Procedure

Spurious and harmonic emissions at antenna terminal is tested in accordance with KDB971168 D01 Power Meas License Digital Systems v02r02, October 17, 2014, Section 6.0.

The level of the carrier and the various conducted spurious and harmonic frequencies is measured by means of a calibrated spectrum analyzer.

On any frequency outside a licensee's frequency block, the power of any emission shall be attenuated below the transmitter power (P) by at least $43 + 10 \log(P)$ dB. The RBW settings used in the testing are greater than 1 % of the occupied bw. The 1 MHz RBW was used to scan from 10 MHz to 10 GHz. (GSM1900 Mode: 10 MHz to 20 GHz). A display line was placed at - 13 dBm to show compliance. The high, lowest and a middle channel were tested for out of band measurements.

Measurements of all out of band are made on RBW = 1MHz and VBW \geq 3 MHz in the worst case despite RBW = 100 kHz and VBW \geq 300 kHz upon 1 GHz.

- RBW = 1 MHz
- VBW \geq 3 MHz
- Detector = Peak
- Trace Mode = max hold
- Sweep time = auto
- Number of points in sweep $\geq 2 * \text{Span} / \text{RBW}$

- Band Edge Requirement : According to FCC 22.917, 24.238 specified that power of any emission outside of The authorized operating frequency ranges must be attenuated below the transmitting power (P) by a factor of at least $43 + 10 \log(P)$ dB. In the 1 MHz bands immediately outside and adjacent to the frequency block a resolution bandwidth of at least one percent of the emission bandwidth of the fundamental emission of the transmitter may be employed.

All measurements were done at 2 channels(low and high operational frequency range.)

The band edge measurement used the power splitter via EUT RF power connector between simulation base station and spectrum analyzer.

In GSM mode, the center frequency of spectrum set to the band edge frequency. The span is 1MHz (RBW = at least 1 % of the EBW, VBW $\geq 3*RBW$, Detector = Average).

In WCDMA mode, the center frequency of spectrum set to the band edge frequency. The span is 7MHz (RBW = at least 1% of the EBW, $\geq 3*RBW$, Detector = Average).

NOTES: The analyzer plot offsets were determined by below conditions.

- For GSM850, total offset 27.2 dB = 20 dB attenuator + 6 dB Splitter + 1.2 dB RF cables.
- For GSM1900, total offset 27.8 dB = 20 dB attenuator + 6 dB Splitter + 1.8 dB RF cables.

3.5 FREQUENCY STABILITY / VARIATION OF AMBIENT TEMPERATURE

Test Set-up

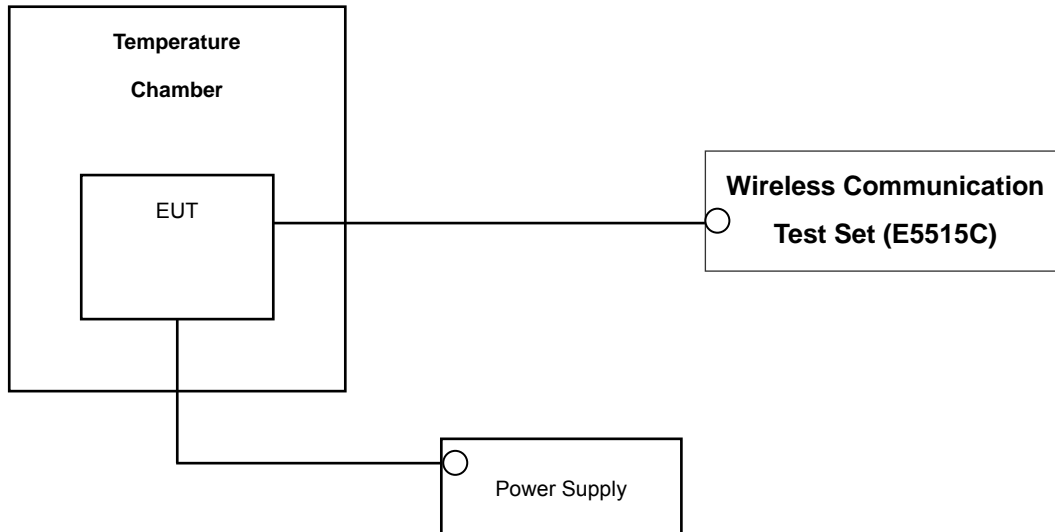

* Nominal Operating Voltage

Test Procedure

Frequency stability is tested in accordance with ANSI/TIA-603-D-2010 section 2.2.2.

The frequency stability of the transmitter is measured by:

- a.) **Temperature:** The temperature is varied from - 30 °C to + 50 °C using an environmental chamber.
- b.) **Primary Supply Voltage:** The primary supply voltage is varied from battery end point to 100 % of the voltage normally at the input to the device or at the power supply terminals if cables are not normally supplied.

Specification — the frequency stability shall be sufficient to ensure that the fundamental emission stays within the authorized frequency block(GSM1900). The frequency stability of the transmitter shall be maintained within $\pm 0.00025\%$ (± 2.5 ppm) of the center frequency(GSM850).

Time Period and Procedure:

The carrier frequency of the transmitter is measured at room temperature (20°C to provide a reference).

1. The equipment is turned on in a “standby” condition for one minute before applying power to the transmitter. Measurement of the carrier frequency of the transmitter is made within one minute after applying power to the transmitter.
2. Frequency measurements are made at 10°C intervals ranging from -30°C to +50°C. A period of at least one half-hour is provided to allow stabilization of the equipment at each temperature level.

NOTE: The EUT is tested down to the battery endpoint.

4. LIST OF TEST EQUIPMENT

Manufacture	Model/ Equipment	Serial Number	Calibration Interval	Calibration Due
Agilent	N1921A/ Power Sensor	MY45241059	Annual	07/09/2015
Agilent	N1911A/ Power Meter	MY45100523	Annual	01/15/2016
MITEQ	AMF-6D-001180-35-20P/AMP	1081666	Annual	09/04/2015
Wainwright	WHK1.2/15G-10EF/H.P.F	4	Annual	04/27/2016
Wainwright	WRCJV2400/2483.5-2370/2520-60/12SS / B.R.F.	1	Annual	06/17/2015
Wainwright	WHK3.3/18G-10EF/H.P.F	2	Annual	04/27/2016
Hewlett Packard	11667B / Power Splitter	10545	Annual	02/22/2016
Hewlett Packard	11667B / Power Splitter	11275	Annual	04/29/2016
Digital	EP-3010/ Power Supply	3110117	Annual	10/29/2015
Schwarzbeck	UHAP/ Dipole Antenna	557	Biennial	03/23/2017
Schwarzbeck	UHAP/ Dipole Antenna	558	Biennial	03/23/2017
Korea Engineering	KR-1005L / Chamber	KRAC05063-3CH	Annual	10/29/2015
Schwarzbeck	BBHA 9120D/ Horn Antenna	147	Biennial	09/01/2016
Schwarzbeck	BBHA 9120D/ Horn Antenna	1151	Biennial	07/05/2015
Schwarzbeck	BBHA 9170/ Horn Antenna(15~40GHz)	BBHA9170541	Biennial	07/05/2015
Agilent	E4440A/Spectrum Analyzer	US45303008	Annual	03/18/2016
WEINSCHL	ATTENUATOR	BR0592	Annual	10/22/2015
REOHDE&SCHWARZ	FSV40/Spectrum Analyzer	1307.9002K40-100931-NK	Annual	06/04/2016
Agilent	8960 (E5515C)/ Base Station	MY48360222	Annual	08/26/2015
Anritsu Corp.	MT8820C/Wideband Radio Communication Tester	6200863156	Annual	03/24/2016

5. SUMMARY OF TEST RESULTS

FCC Part Section(s)	Test Description	Test Limit	Test Condition	Test Result
2.1049	Occupied Bandwidth	N/A	CONDUCTED	PASS
2.1051, 22.917(a), 24.238(a)	Band Edge / Spurious and Harmonic Emissions at Antenna Terminal.	< 43 + 10log10 (P[Watts]) at Band Edge and for all out-of-band emissions		PASS
2.1046	Conducted Output Power	-		PASS
24.232(d)	Peak- to- Average Ratio	< 13 dB		PASS
2.1055, 22.355	Frequency stability / variation of ambient temperature	< 2.5 ppm (Part22)		PASS
24.235		Emission must remain in band (Part24)		PASS
22.913(a)(2)	Effective Radiated Power	< 7 Watts max. ERP	RADIATED	PASS
24.232(c)	Equivalent Isotropic Radiated Power	< 2 Watts max. EIRP		PASS
2.1053, 22.917(a), 24.238(a)	Radiated Spurious and Harmonic Emissions	< 43 + 10log10 (P[Watts]) for all out-of band emissions		PASS

6. SAMPLE CALCULATION

A. ERP Sample Calculation

Mode	Ch./ Freq.		Measured Level(dBm)	Substitute LEVEL(dBm)	Ant. Gain (dBd)	C.L	Pol.	ERP	
	channel	Freq.(MHz)						W	dBm
GSM850	128	824.20	-21.37	38.40	-10.61	0.95	H	0.483	26.84

ERP = SubstituteLEVEL(dBm) + Ant. Gain – CL(Cable Loss)

- 1) The EUT mounted on a non-conductive turntable is 2.5 meter above test site ground level.
- 2) During the test , the turn table is rotated until the maximum signal is found.
- 3) Record the field strength meter's level.
- 4) Replace the EUT with dipole/Horn antenna that is connected to a calibrated signal generator.
- 5) Increase the signal generator output till the field strength meter's level is equal to the item (3).
- 6) The signal generator output level with Ant. Gain and cable loss are the rating of effective radiated power (ERP).

B. Emission Designator

GSM Emission Designator

Emission Designator = 249KGXW

GSM BW = 249 kHz

G = Phase Modulation

X = Cases not otherwise covered

W = Combination (Audio/Data)

7. TEST DATA

7.1 CONDUCTED OUTPUT POWER

Conducted Output Power is tested in accordance with KDB971168 D01 Power Meas License Digital Systems v02r02, October 17, 2014, Section 5.2.

A base station simulator was used to establish communication with the EUT, and Spectrum analyzer was used for test results. This device was tested under all configurations and the highest power is reported. Conducted Output Powers of EUT are reported below.

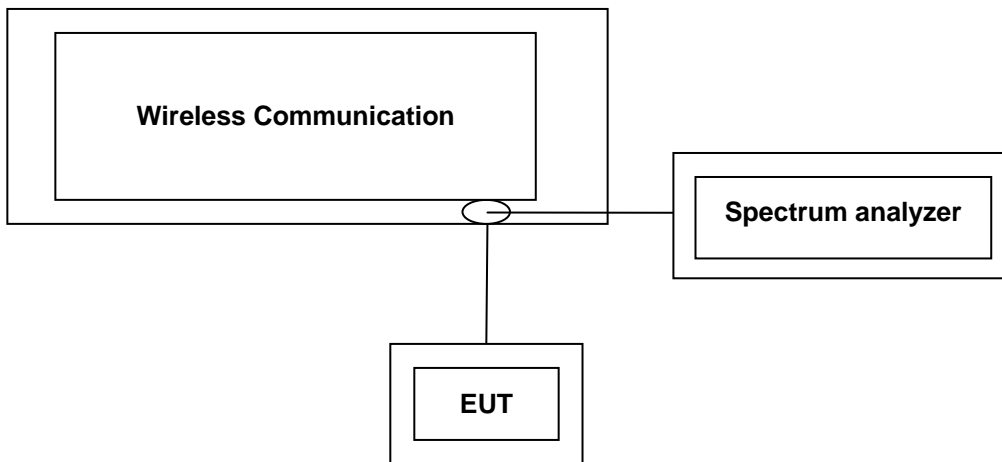

Test Result

Band	Channel	GSM	GPRS Data	
		Voice (dBm)	GPRS	GPRS
			1 TX Slot (dBm)	2 TX Slot (dBm)
GSM850	128	32.36	32.36	31.70
	190	32.35	32.36	31.70
	251	32.33	32.33	31.67
GSM1900	512	29.97	29.97	29.02
	661	30.04	30.04	29.12
	810	30.13	30.13	29.22

(GSM Conducted Maximum Output Powers)

Note : Detecting mode is average.

7.1 EFFECTIVE RADIATED POWER

(GSM850 Mode)

Ch./ Freq.		Measured Level(dBm)	Substitute LEVEL (dBm)	Ant. Gain (dBd)	C.L	Pol.	ERP	
channel	Freq.(MHz)						W	dBm
128	824.20	-22.25	39.69	-10.59	0.88	H	0.663	28.22
190	836.60	-32.36	29.30	-10.53	0.89	H	0.061	17.88
251	848.80	-25.59	35.36	-10.48	0.89	H	0.251	23.99

Note: Standard batteries are the only options for this phone.

NOTES:

Effective Radiated Power Output Measurements by Substitution Method
 according to ANSI/TIA/EIA-603-D-2010 June 24, 2010:

The EUT was placed on a non-conductive styrofoam resin table 3-meters from the receive antenna. Turntable rotation was adjusted for the highest reading on the receive spectrum analyzer. For GSM signals, a peak detector is used, with $RBW \geq OBW$, $VBW \geq 3 \times RBW$. A half-wave dipole was substituted in place of the EUT. This dipole antenna was driven by a signal generator and the level of the signal generator was adjusted to obtain the same receive spectrum analyzer reading. The conducted power at the terminals of the dipole is measured. The ERP is recorded.

This device was tested under all configurations and the highest power is reported in GSM mode using a Power Control Level of "0" in the PCS Band and "5" in the Cellular Band. This unit was tested with its standard battery. Also, we have done x, y, z planes in EUT and horizontal and vertical polarization in detecting antenna. The worst case of the EUT is z plane in GSM850 mode. Also worst case of detecting Antenna is in horizontal polarization in GSM850 mode.

7.2 EQUIVALENT ISOTROPIC RADIATED POWER

(GSM1900 Mode)

Ch./ Freq.		Measured	Substitute	Ant. Gain	C.L	Pol.	EIRP	
channel	Freq.(MHz)	Level(dBm)	LEVEL (dBm)	(dBi)			W	dBm
512	1,850.20	-10.65	22.04	10.04	1.36	H	1.179	30.72
661	1,880.00	-10.73	22.23	10.05	1.37	H	1.234	30.91
810	1,909.80	-12.09	21.13	10.06	1.38	H	0.957	29.81

Note: Standard batteries are the only options for this phone.

NOTES:

Equivalent Isotropic Radiated Power Measurements by Substitution Method
according to ANSI/TIA/EIA-603-D-2010 June 24, 2010:

The EUT was placed on a non-conductive styrofoam resin table 3-meters from the receive antenna. Turntable rotation was adjusted for the highest reading on the receive spectrum analyzer. For GSM signals, a peak detector is used, with $RBW \geq OBW$, $VBW \geq 3 \times RBW$. A Horn antenna was substituted in place of the EUT. This Horn antenna was driven by a signal generator and the level of the signal generator was adjusted to obtain the same receive spectrum analyzer reading. The conducted power at the terminals of the Horn antenna is measured. The difference between the gain of the horn and an isotropic antenna is taken into consideration and the EIRP is recorded.

This device was tested under all configurations and the highest power is reported in GSM mode using a Power Control Level of "0" in the PCS Band and "5" in the Cellular Band. This unit was tested with its standard battery. Also, we have done x, y, z planes in EUT and horizontal and vertical polarization in detecting antenna. The worst case of the EUT is z plane in GSM1900 mode. Also worst case of detecting Antenna is in horizontal polarization in GSM1900 mode.

7.3 RADIATED SPURIOUS EMISSIONS

7.3.1 RADIATED SPURIOUS EMISSIONS (GSM850)

MEASURED OUTPUT POWER: 28.22 dBm = 0.663 W
 MODULATION SIGNAL: GSM850
 DISTANCE: 3 meters
 LIMIT: $43 + 10 \log_{10}(W) =$ 41.22 dBc

Ch.	Freq.(MHz)	Measured Level [dBm]	Ant. Gain (dBd)	Substitute Level [dBm]	C.L	Pol.	ERP (dBm)	dBc
128 (824.2)	1,648.40	-37.17	9.71	-45.51	1.29	H	-37.09	65.31
	2,472.60	-47.45	10.54	-52.93	1.60	H	-43.99	72.21
	3,296.80	-39.47	12.21	-44.74	1.85	V	-34.38	62.60
190 (836.6)	1,673.20	-40.86	9.77	-49.34	1.28	H	-40.85	69.07
	2,509.80	-47.47	10.65	-52.76	1.61	H	-43.72	71.94
	3,346.40	-42.35	12.41	-48.04	1.86	V	-37.49	65.71
251 (848.8)	1,697.60	-44.38	9.85	-52.87	1.30	H	-44.32	72.54
	2,546.40	-45.88	10.72	-51.06	1.64	H	-41.98	70.20
	3,395.20	-47.02	12.39	-52.54	1.88	H	-42.03	70.25

- NOTES:**
1. Radiated Spurious Emission Measurements at 3 meters by Substitution Method according to ANSI/TIA/EIA-603-D-2010 June 24, 2010:
 2. We are performed all frequency to 10th harmonics from 30 MHz. Measurements above show only up to 3 maximum emissions noted, or would be lesser if no specific emissions from the EUT are recorded (ie: margin > 20 dB from the applicable limit) and considered that's already beyond the background noise floor.
 3. we have done x, y, z planes in EUT and horizontal and vertical polarization in detecting antenna.

7.3.2 RADIATED SPURIOUS EMISSIONS (GSM1900)

MEASURED OUTPUT POWER: 30.91 dBm = 1.234 W
 MODULATION SIGNAL: GSM1900
 DISTANCE: 3 meters
 LIMIT: $43 + 10 \log_{10}(W) =$ 43.91 dBc

Ch.	Freq.(MHz)	Measured Level [dBm]	Ant. Gain (dBi)	Substitute Level [dBm]	C.L	Pol.	EIRP (dBm)	dBc
512 (1850.2)	3,700.40	-53.16	12.32	-57.72	2.03	V	-47.43	78.34
	5,550.60	-47.63	13.02	-46.95	2.52	H	-36.45	67.36
	7,400.80	-48.13	11.06	-39.24	2.91	V	-31.09	62.00
661 (1880.0)	3,760.00	-54.41	12.29	-58.87	1.93	V	-48.51	79.42
	5,640.00	-47.19	13.12	-46.71	2.57	H	-36.16	67.07
	7,520.00	-48.24	11.09	-39.74	3.03	V	-31.68	62.59
810 (1909.8)	3,819.60	-53.04	12.28	-56.80	2.04	V	-46.56	77.47
	5,729.40	-47.28	13.06	-46.61	2.55	H	-36.10	67.01
	7,639.20	-49.06	11.38	-40.04	3.11	H	-31.77	62.68

- NOTES:**
1. Radiated Spurious Emission Measurements at 3 meters by Substitution Method according to ANSI/TIA/EIA-603-D-2010 June 24, 2010:
 2. We are performed all frequency to 10th harmonics from 30 MHz. Measurements above show only up to 3 maximum emissions noted, or would be lesser if no specific emissions from the EUT are recorded (ie: margin > 20 dB from the applicable limit) and considered that's already beyond the background noise floor.
 3. we have done x, y, z planes in EUT and horizontal and vertical polarization in detecting antenna.

7.4 PEAK-TO-AVERAGE RATIO

Band	Ch.	Measured P _{PK} (dBm)	Measured P _{Avg} (dBm)	P _{Avg} (Duty Cycle)			P.A.R. = P _{PK} - P _{Avg} (dB)	Limit (dB)	Pass / Fail
				TX _{Total} (ms)	TX _{On} (ms)	Factor (dB)			
GSM1900	661	29.97	20.41	4.6232	0.5507	9.24	0.32	13	Pass

- Plots of the EUT's Peak- to- Average Ratio are shown Page 30 ~ 31.

NOTES:

Peak to Average Power Ratio was tested in accordance with KDB971168 D01 Power Meas License Digital Systems v02r02, October 17, 2014, Section 5.7.

GSM Mode was tested by Section 5.7.2 Alternate Procedure

$P.A.R_{(dB)} = P_{PK} (dBm) - P_{Avg} (dBm)$ (P_{Avg} = Average Power + Duty cycle Factor)

Duty cycle Factor = $10 \log (1/x)$, $x = TX_{On} / TX_{Total}$

7.5 OCCUPIED BANDWIDTH

Band	Channel	Frequency(MHz)	Data (GSM: kHz)
GSM850	128	824.20	242.4654
	190	836.60	240.1257
	251	848.80	243.0825
GSM1900	512	1,850.20	245.4573
	661	1,880.00	244.1067
	810	1,909.80	243.1150

- Plots of the EUT's Occupied Bandwidth are shown Page 27 ~ 29.

7.6 CONDUCTED SPURIOUS EMISSIONS

Band	Channel	Frequency of Maximum Harmonic (GHz)	Maximum Data (dBm)
GSM850	128	4.735840	-29.35
	190	4.955520	-30.24
	251	4.789520	-29.90
GSM1900	512	6.984820	-28.27
	661	6.998280	-28.28
	810	6.990310	-28.91

- Plots of the EUT's Conducted Spurious Emissions are shown Page 37 ~ 43.

7.6.1 BAND EDGE

- Plots of the EUT's Band Edge are shown Page 31 ~ 37.

7.7 FREQUENCY STABILITY / VARIATION OF AMBIENT TEMPERATURE

7.7.1 FREQUENCY STABILITY (GSM850)

OPERATING FREQUENCY: 836,600,000 Hz
 CHANNEL: 190
 REFERENCE VOLTAGE: 12.0 VDC
 DEVIATION LIMIT: ± 0.000 25 % or 2.5 ppm

Voltage (%)	Power (VDC)	Temp. ()	Frequency (Hz)	Frequency Error (Hz)	Deviation (%)	ppm
100%	12.0	+20(Ref)	836 600 023	0	0.000 000	0.000
100%		-30	836 599 977	-46.15	-0.000 006	-0.055
100%		-20	836 599 980	-42.97	-0.000 005	-0.051
100%		-10	836 599 997	-25.92	-0.000 003	-0.031
100%		0	836 599 994	-29.01	-0.000 003	-0.035
100%		+10	836 599 995	-27.99	-0.000 003	-0.033
100%		+30	836 599 997	-25.57	-0.000 003	-0.031
100%		+40	836 599 999	-24.23	-0.000 003	-0.029
100%		+50	836 599 993	-29.74	-0.000 004	-0.036
Batt. Endpoint	10.2	+20	836 599 998	-25.38	-0.000 003	-0.030

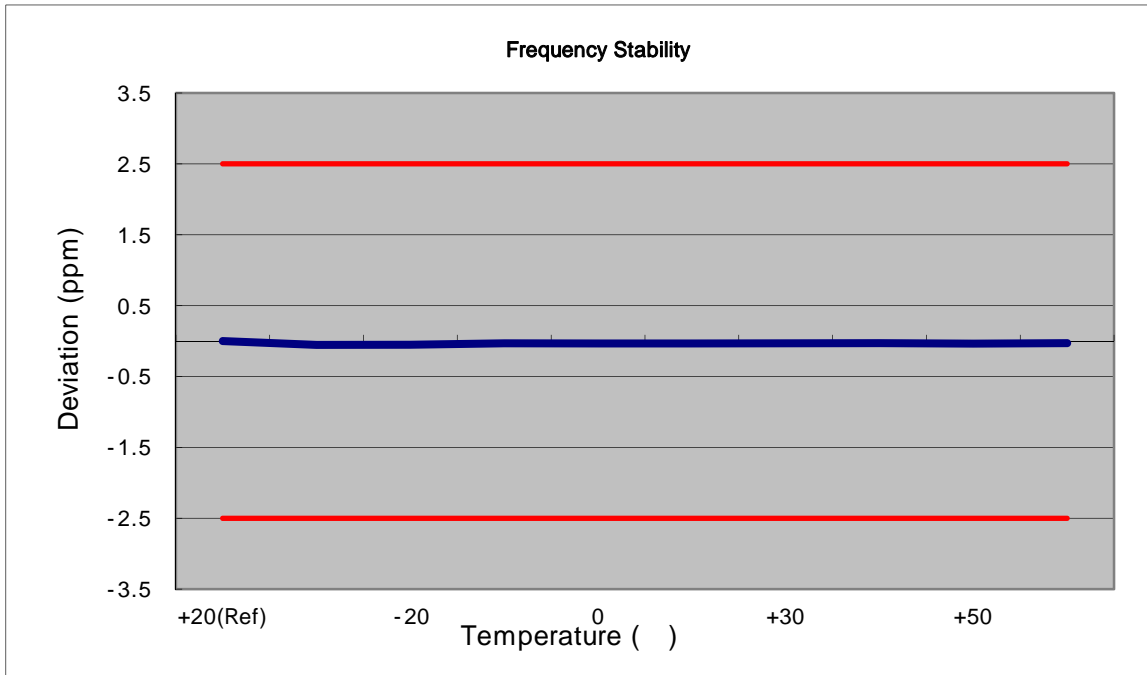

7.7.2 FREQUENCY STABILITY (GSM1900)

OPERATING FREQUENCY: 1880,000,000 Hz
 CHANNEL: 661
 REFERENCE VOLTAGE: 12.0 VDC
 DEVIATION LIMIT: -

Voltage (%)	Power (VDC)	Temp. ()	Frequency (Hz)	Frequency Error (Hz)	Deviation (%)	ppm
100%	12.0	+20(Ref)	1879 999 959	0	0.000 000	0.000
100%		-30	1879 999 994	35.07	0.000 002	0.019
100%		-20	1879 999 996	37.15	0.000 002	0.020
100%		-10	1880 000 002	43.25	0.000 002	0.023
100%		0	1879 999 913	-46.20	-0.000 002	-0.025
100%		+10	1879 999 911	-48.14	-0.000 003	-0.026
100%		+30	1879 999 924	-34.75	-0.000 002	-0.018
100%		+40	1879 999 925	-33.42	-0.000 002	-0.018
100%		+50	1879 999 916	-43.20	-0.000 002	-0.023
Batt. Endpoint		10.2	+20	1879 999 926	-33.26	-0.000 002

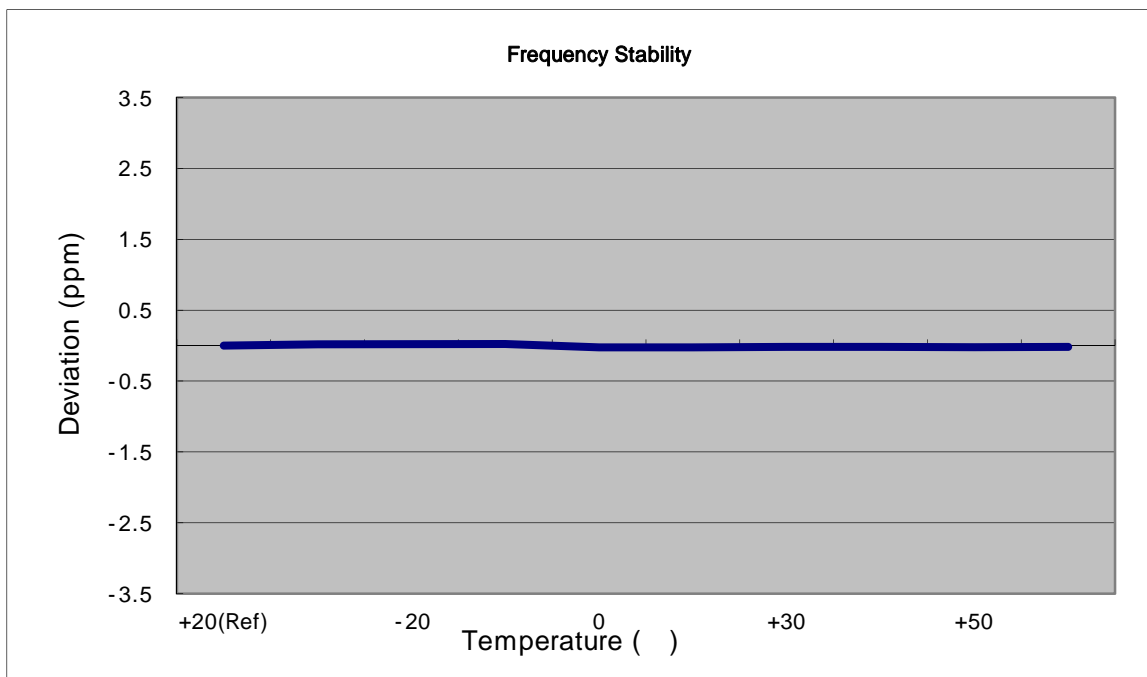

8. TEST PLOTS

■ GSM850 MODE (128 CH.) Occupied Bandwidth

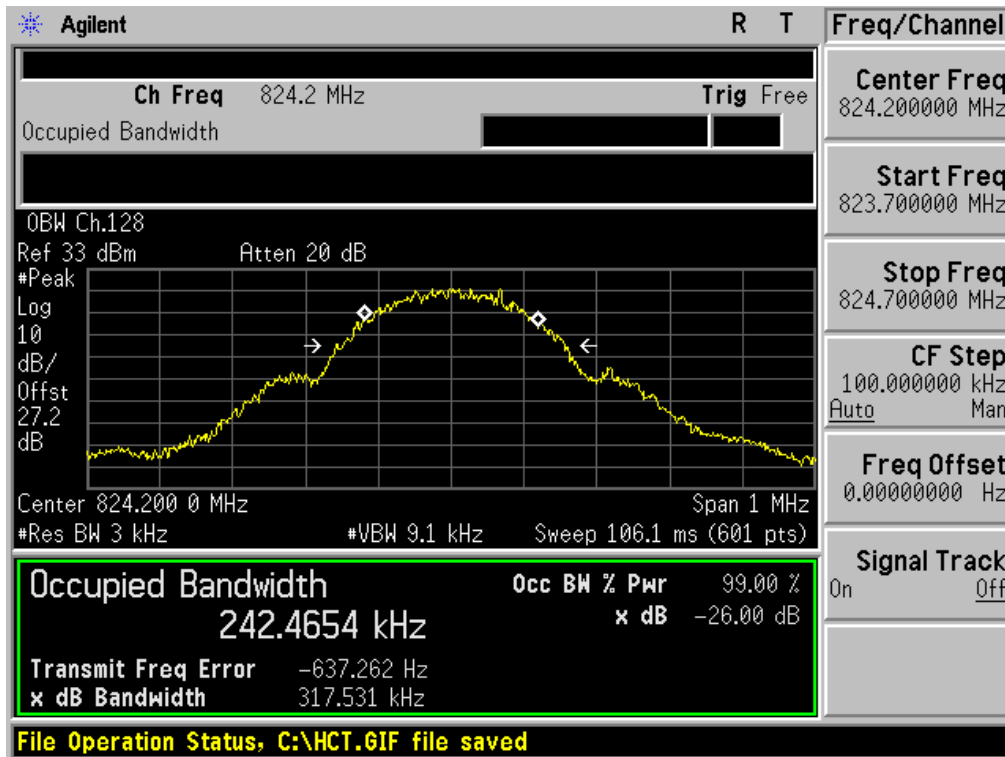

■ GSM850 MODE (190 CH.) Occupied Bandwidth

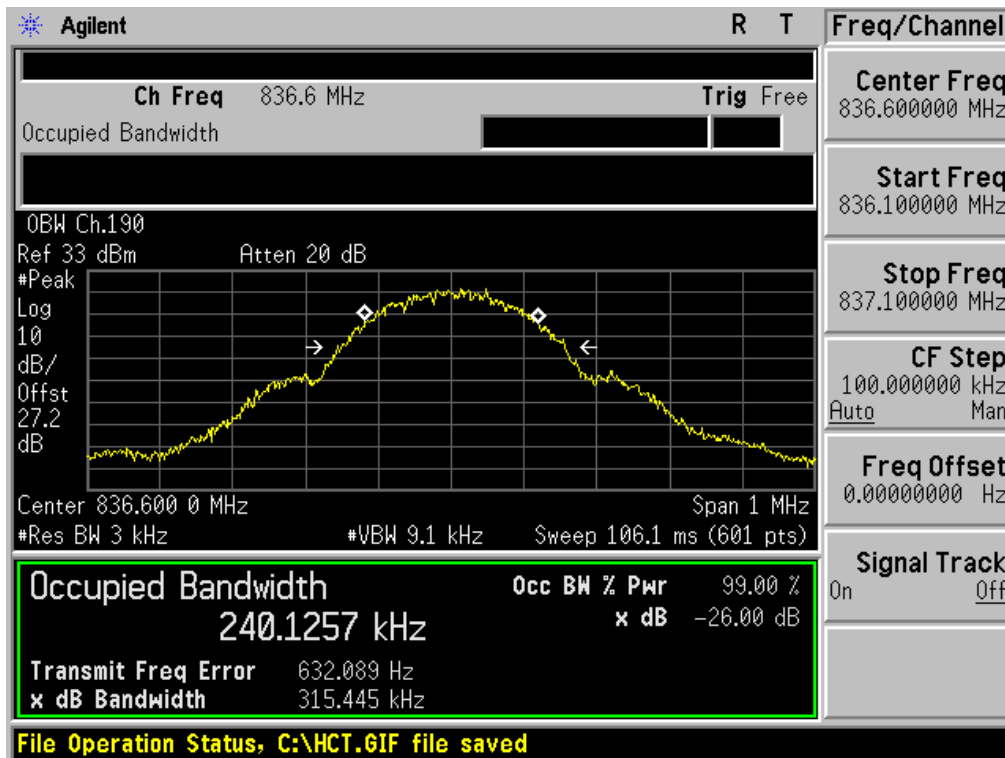

■ GSM850 MODE (251 CH.) Occupied Bandwidth

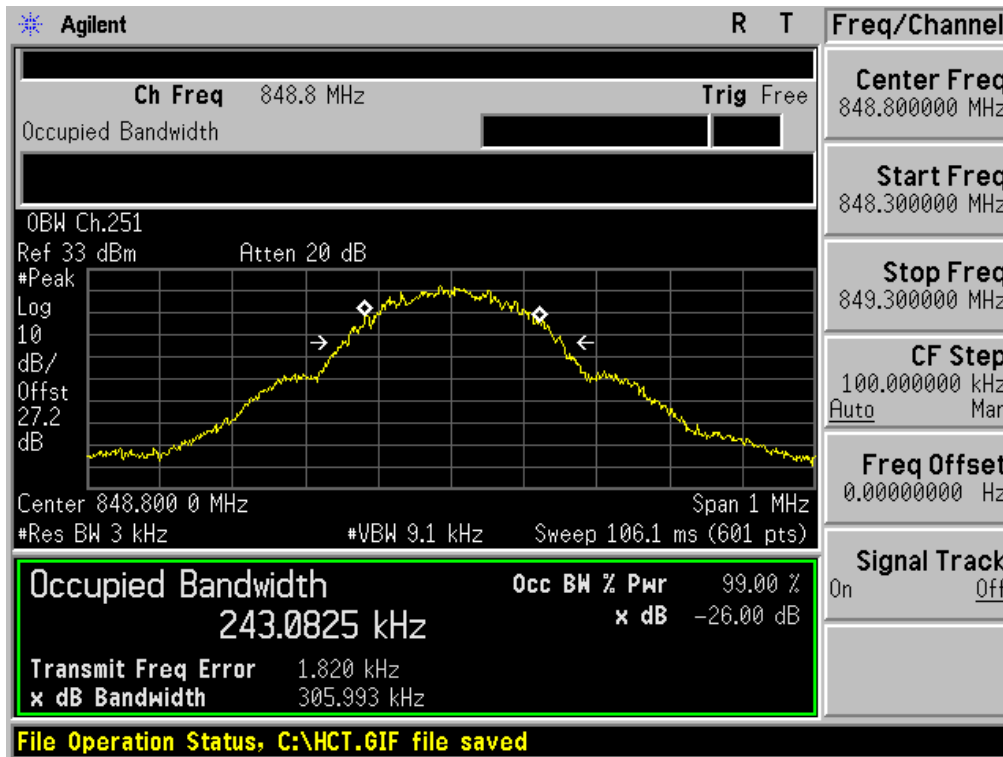

■ GSM1900 MODE (512 CH.) Occupied Bandwidth

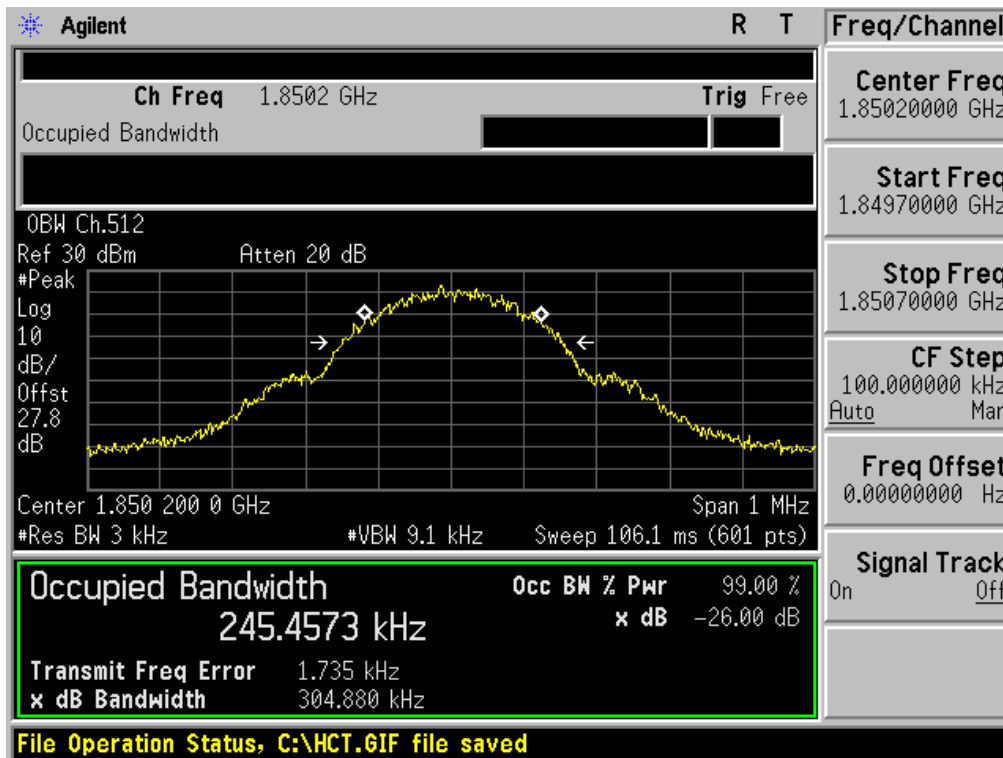

■ GSM1900 MODE (661 CH.) Occupied Bandwidth

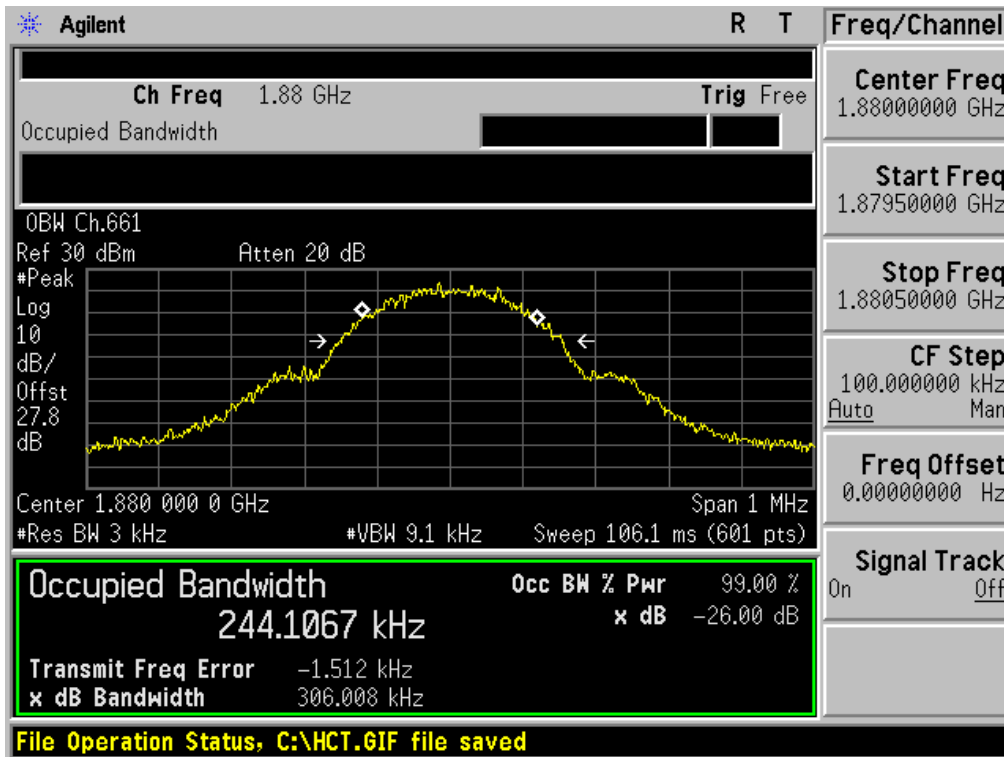

■ GSM1900 MODE (810 CH.) Occupied Bandwidth

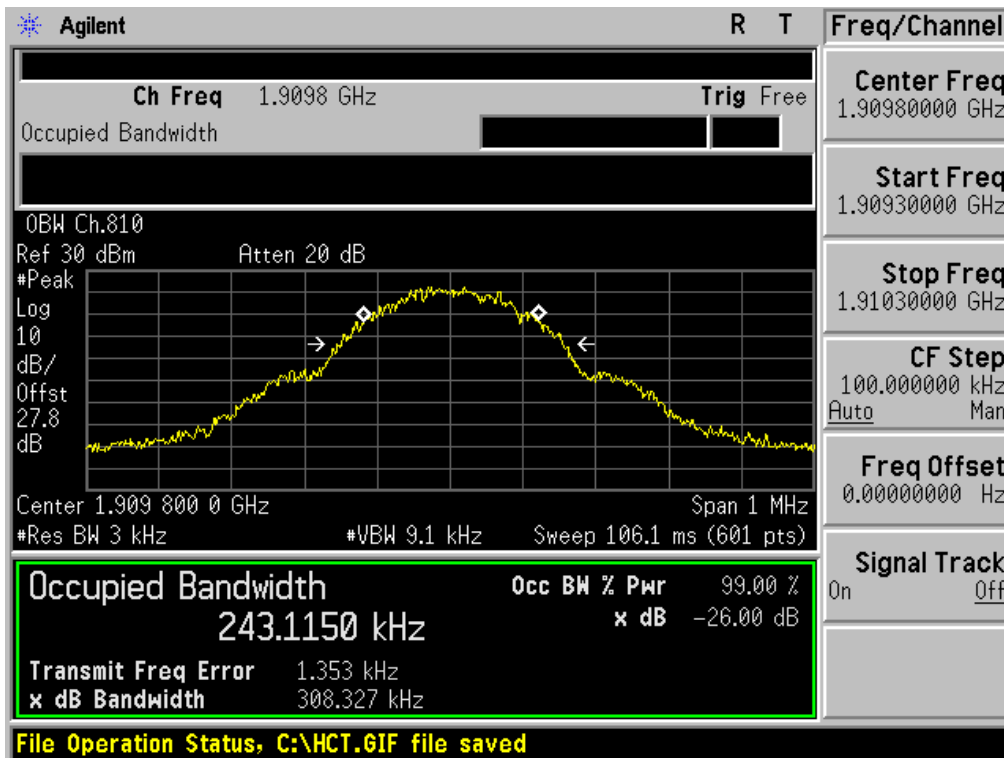

■ GSM1900 MODE (661 CH.) Peak-to-Average Ratio P_{Pk}



■ GSM1900 MODE (661 CH.) Peak-to-Average Ratio P_{Avg}

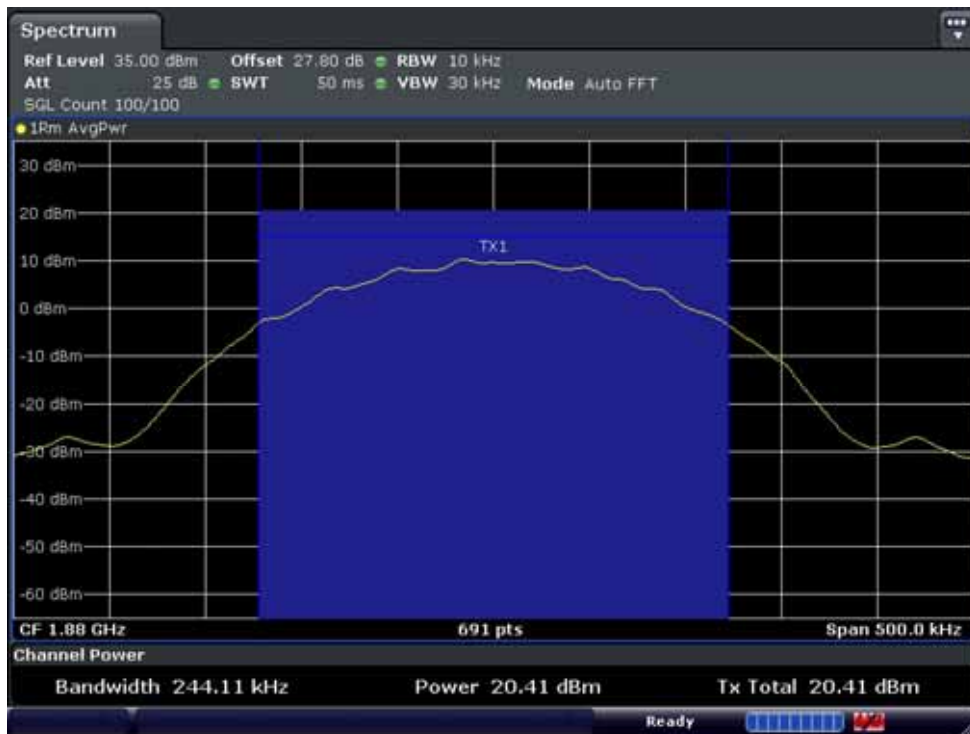

■ GSM1900 MODE (661 CH.) Peak-to-Average Ratio P_{Avg}

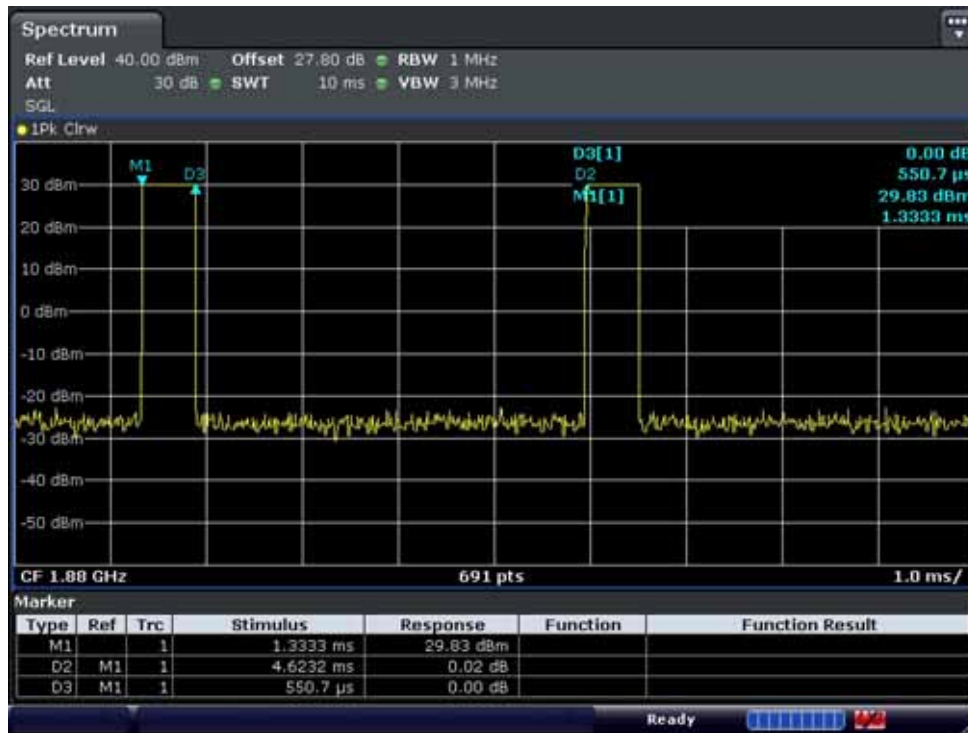

■ GSM850 MODE (128 CH.) Block Edge 1

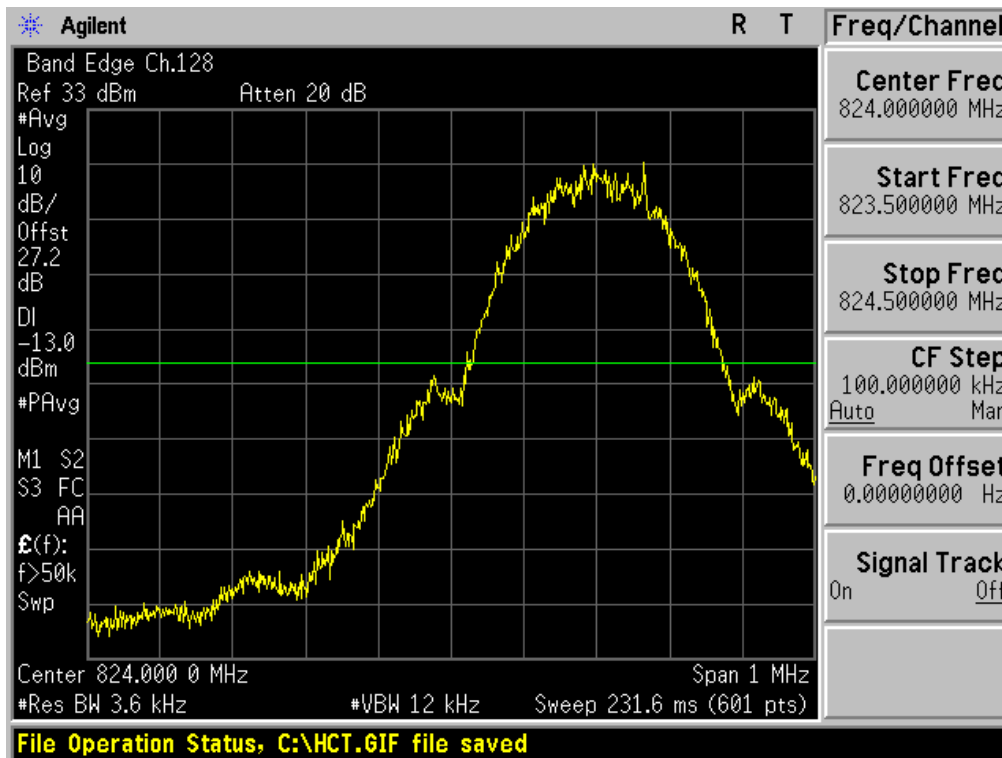

■ GSM850 MODE (128 CH.) Block Edge 2

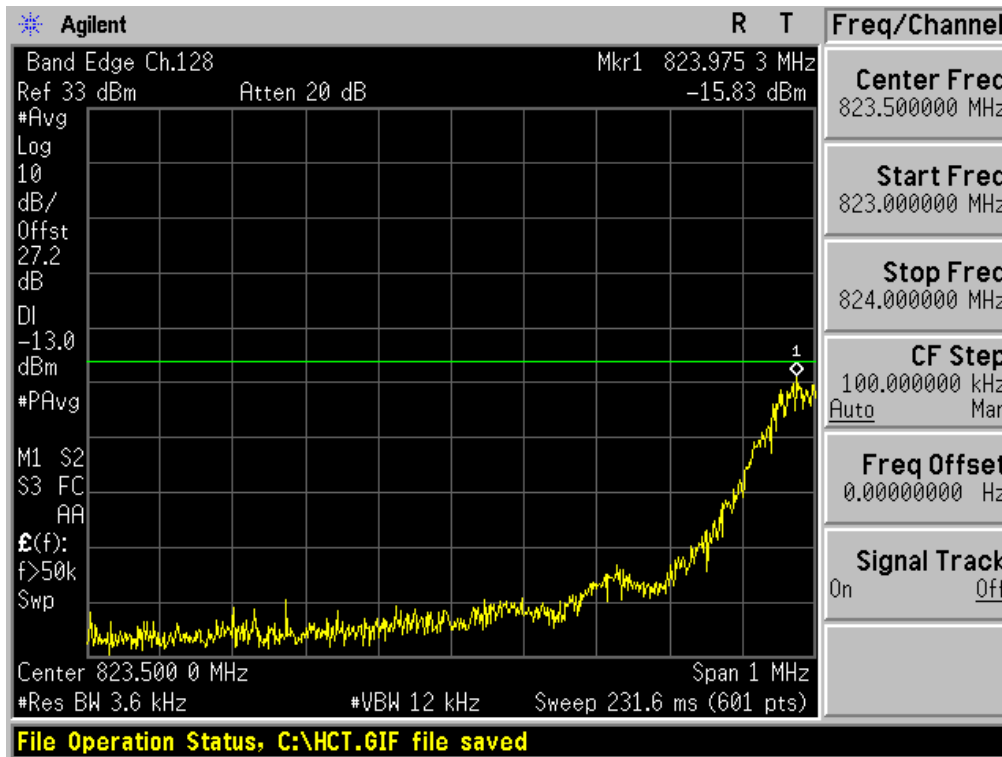

■ GSM850 MODE (128 CH.) Block Edge 3

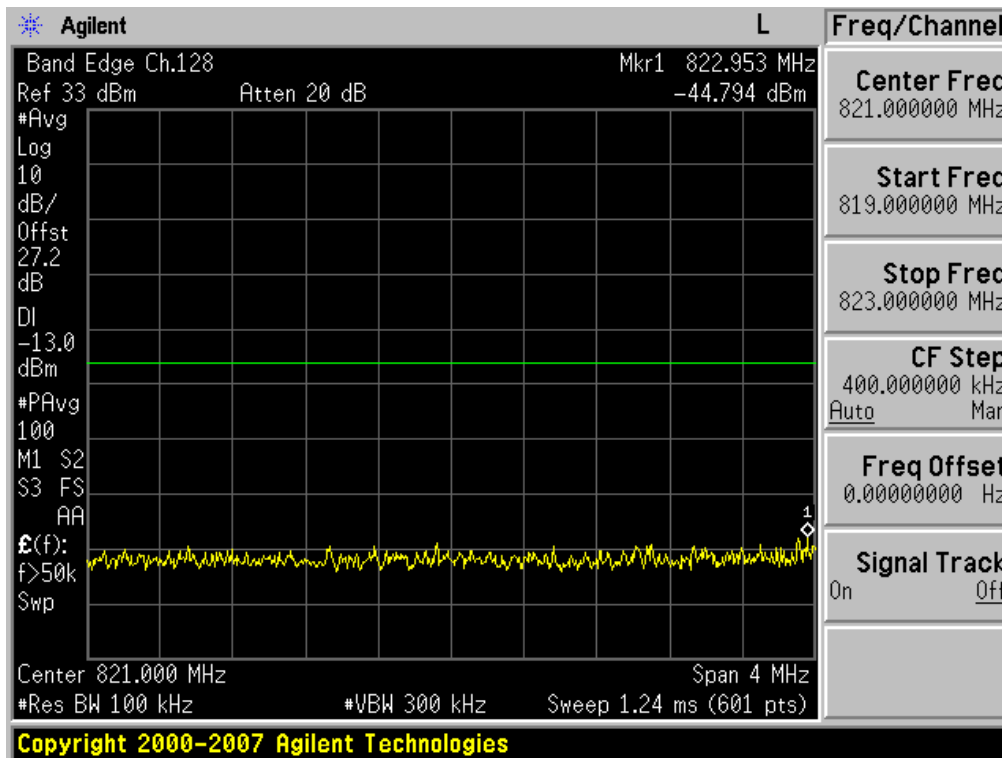

■ GSM850 MODE (251 CH.) Block Edge 1

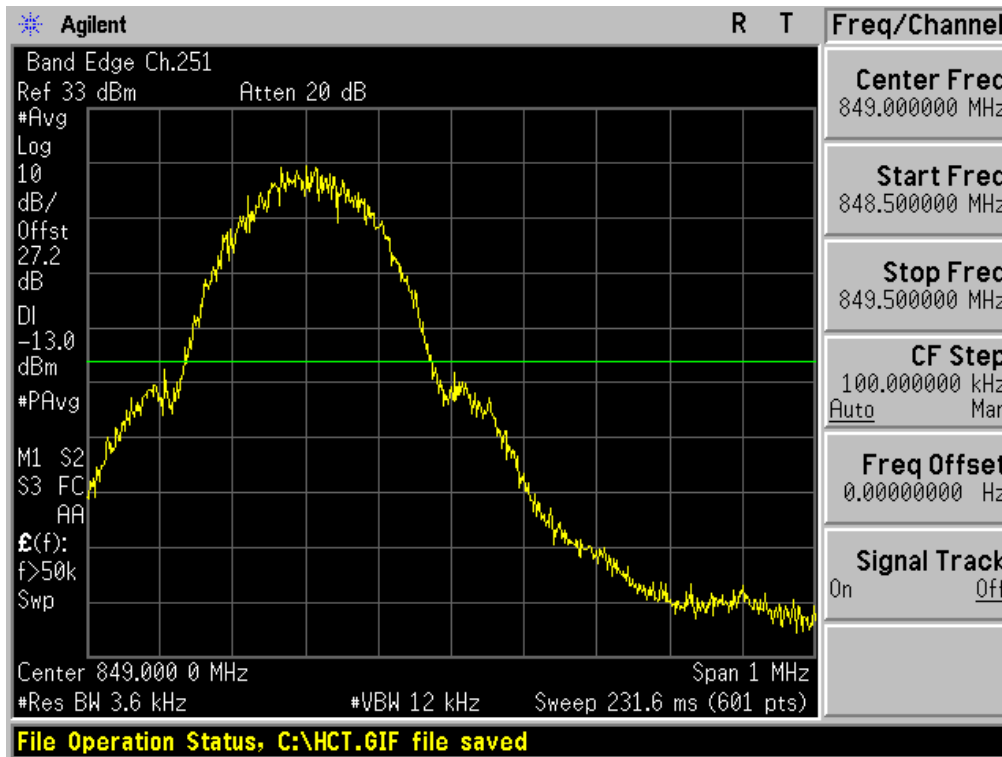

■ GSM850 MODE (251 CH.) Block Edge 2

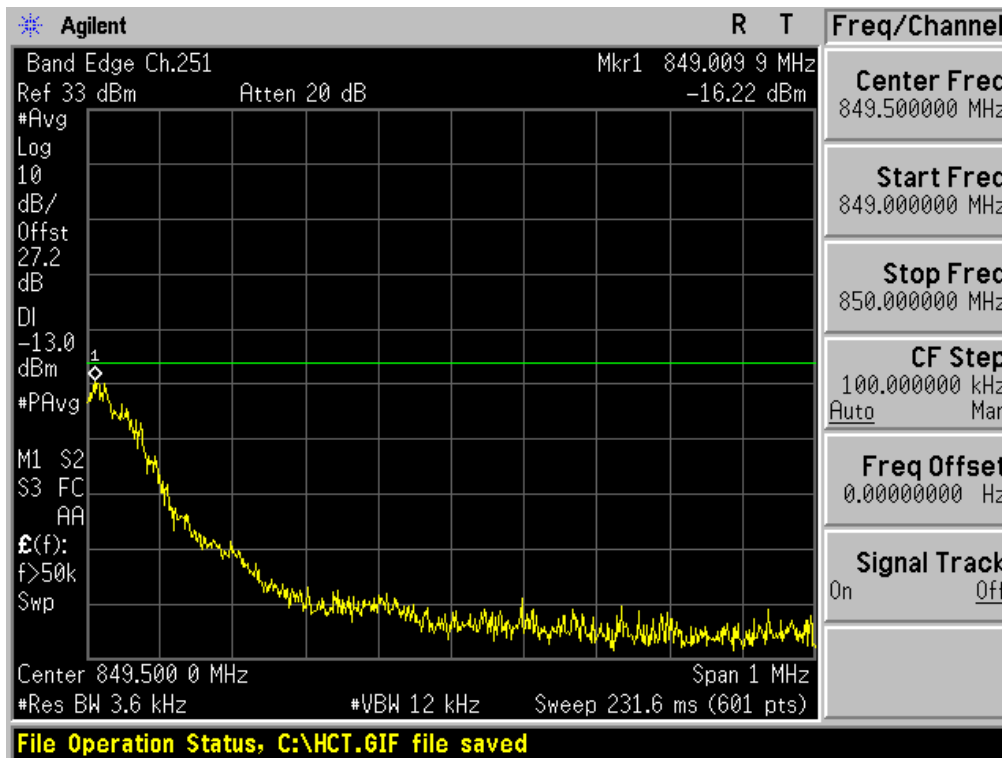

■ GSM850 MODE (251 CH.) Block Edge 3

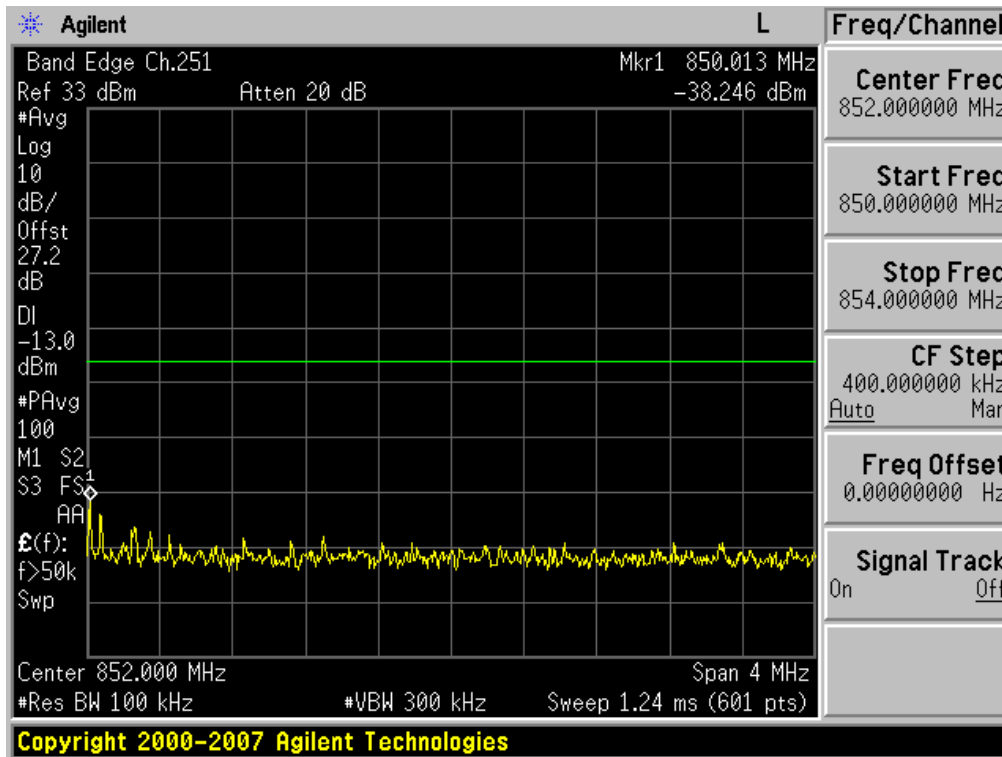

■ GSM1900 MODE (512 CH.) Block Edge 1

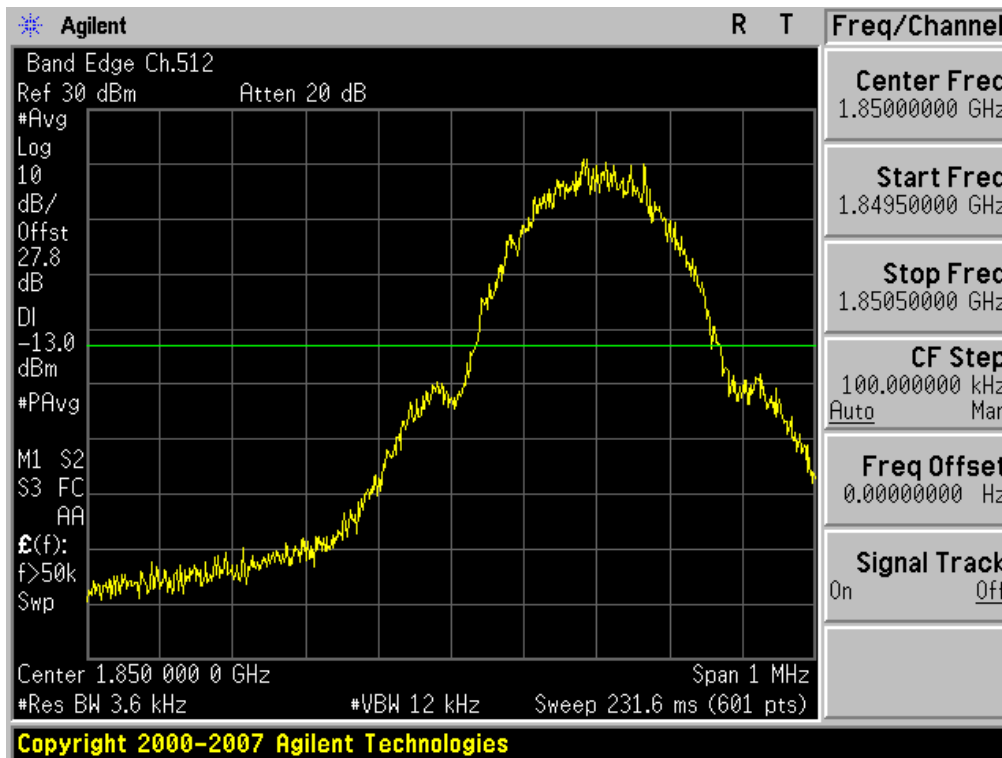

■ GSM1900 MODE (512 CH.) Block Edge 2

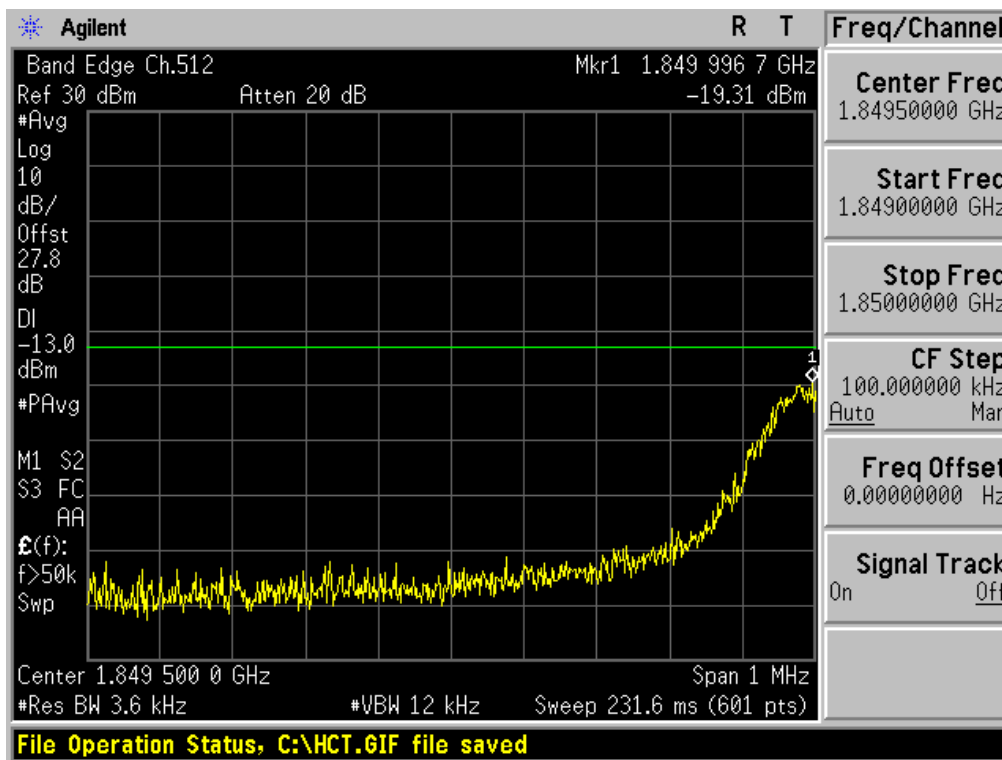

■ GSM1900 MODE (512 CH.) Block Edge 3

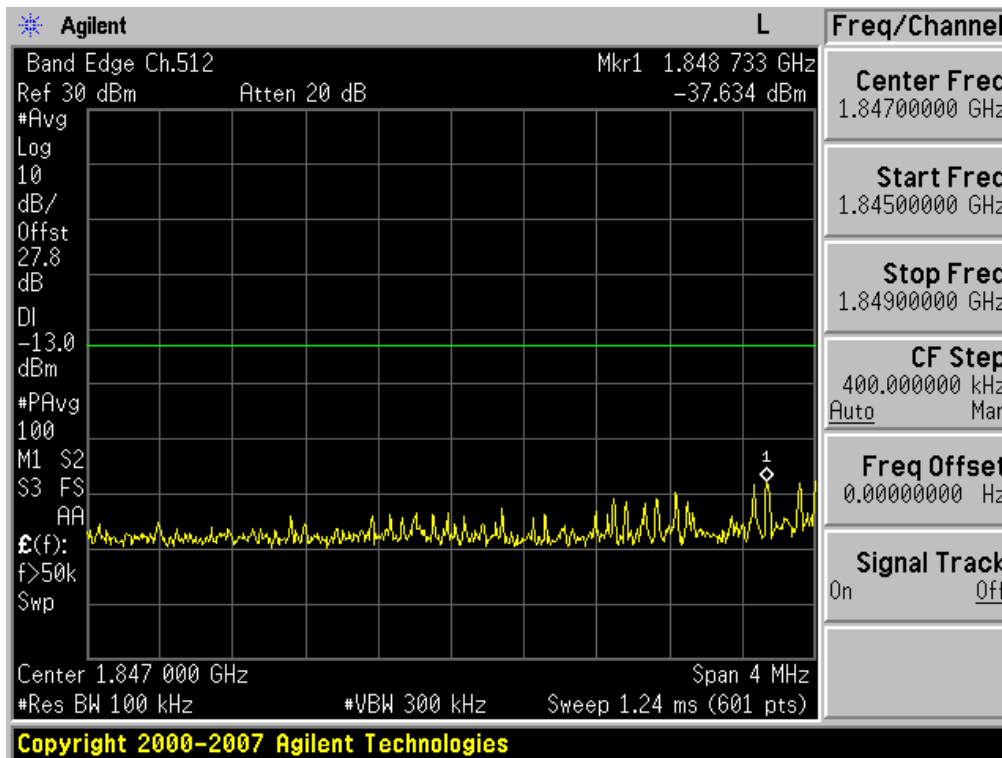

Note : We used a narrower RBW in order to increase accuracy.

Calculation = Reading Value + 10*log(1 MHz/100 kHz) dB = -37.634 dBm + 10 dB = **-27.634 dBm**

■ GSM1900 MODE (810 CH.) Block Edge 1

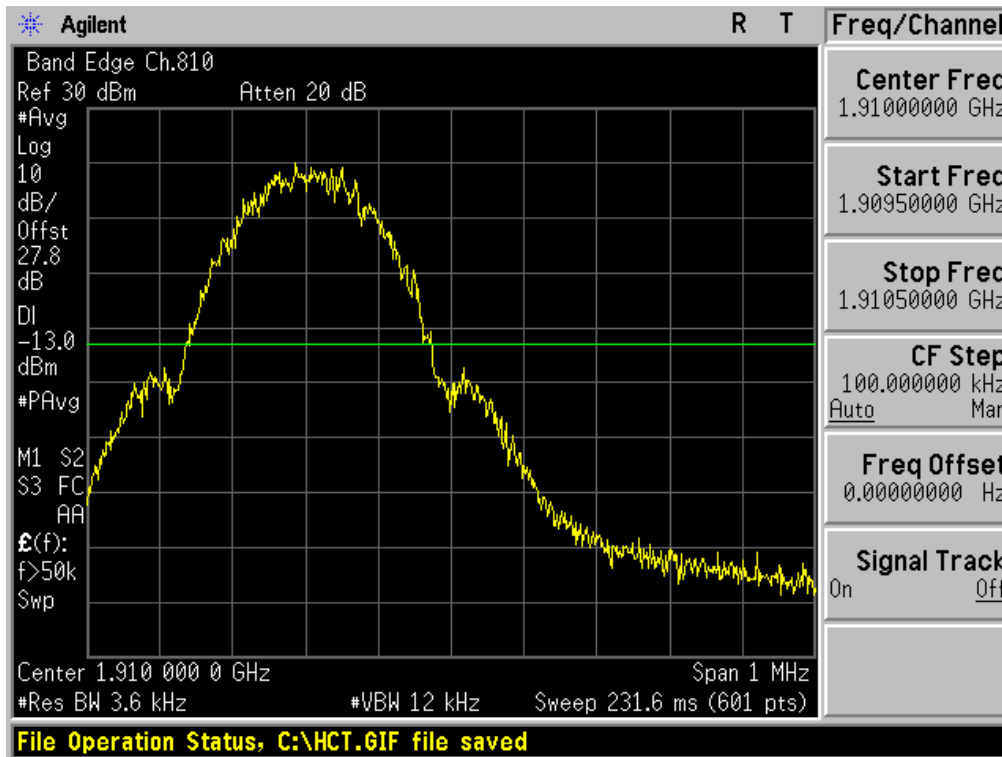

■ GSM1900 MODE (810 CH.) Block Edge 2

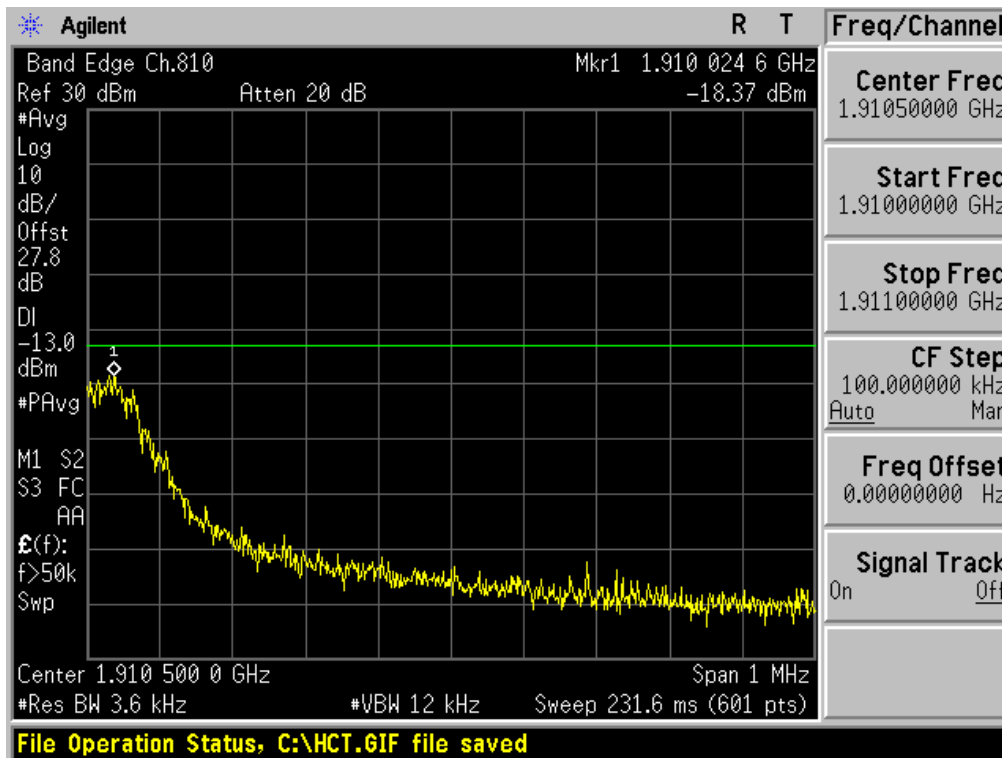

■ GSM1900 MODE (810 CH.) Block Edge 3

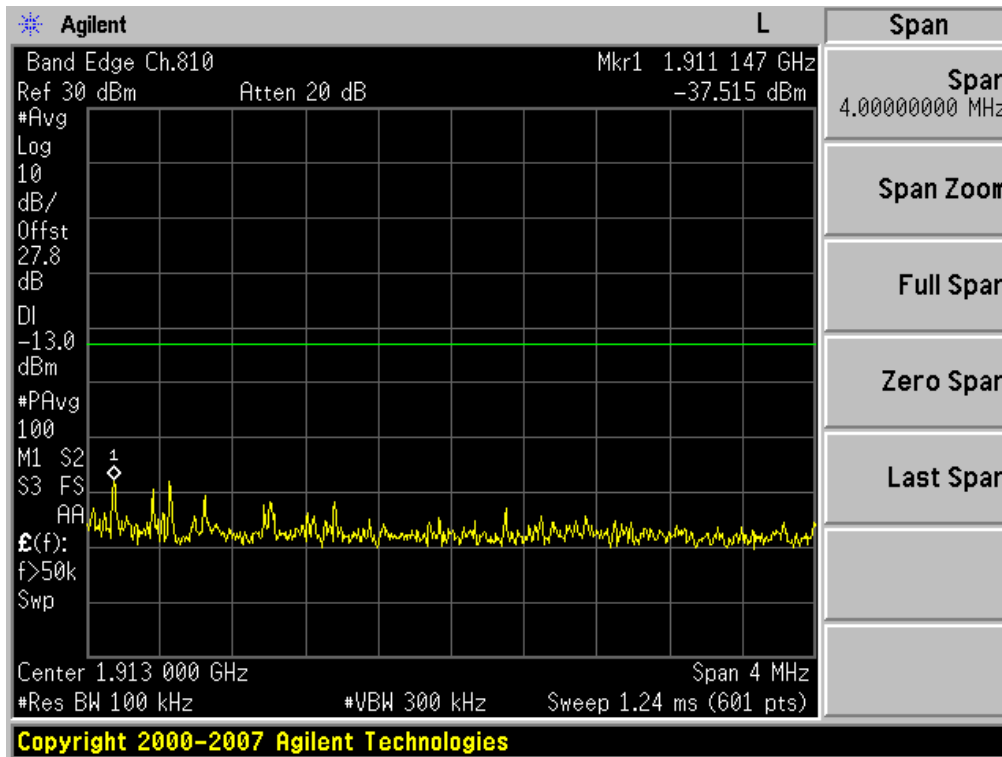

Note : We used a narrower RBW in order to increase accuracy.

Calculation = Reading Value + 10*log(1 MHz/100 kHz) dB = -37.515 dBm + 10 dB = **-27.515 dBm**

■ GSM850 MODE (128 CH.) Conducted Spurious Emissions1

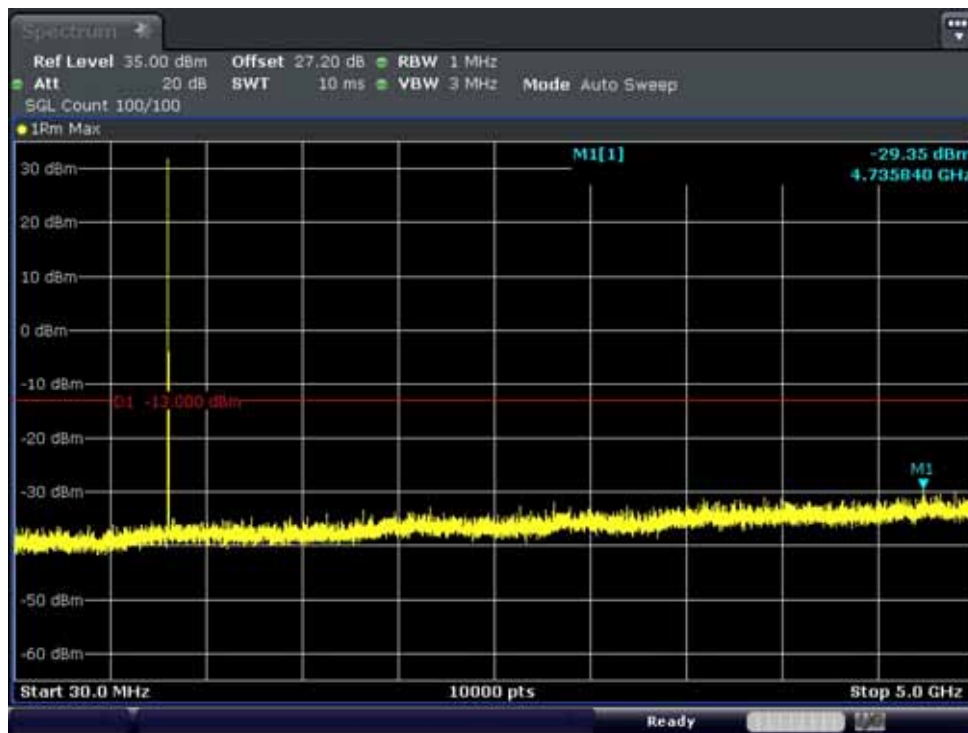

■ GSM850 MODE (128 CH.) Conducted Spurious Emissions2

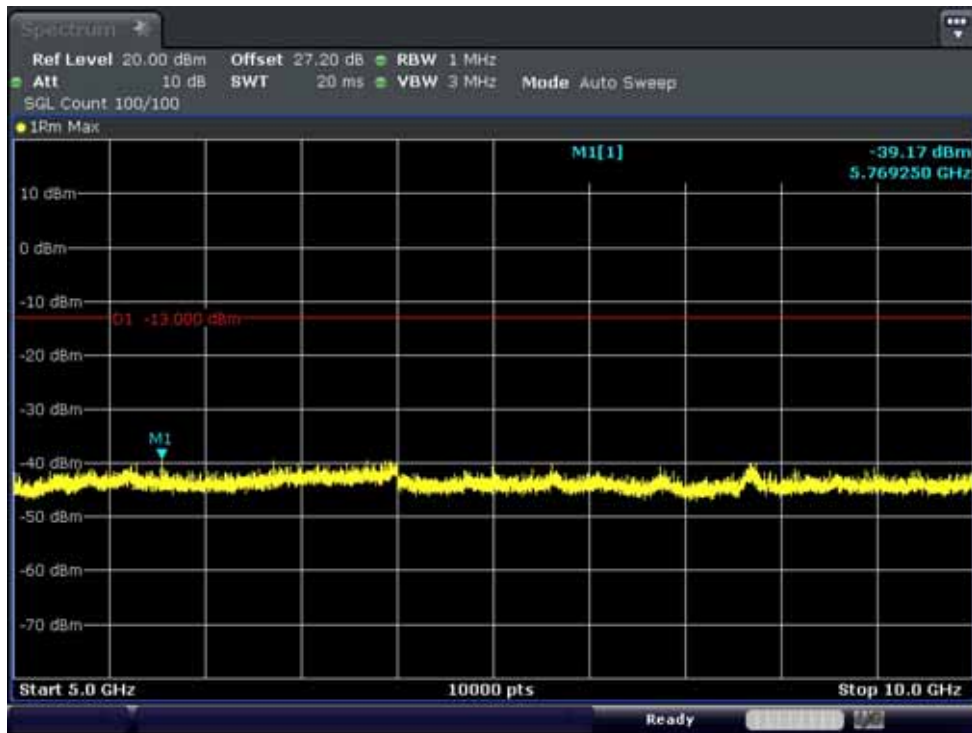

■ GSM850 MODE (190 CH.) Conducted Spurious Emissions1

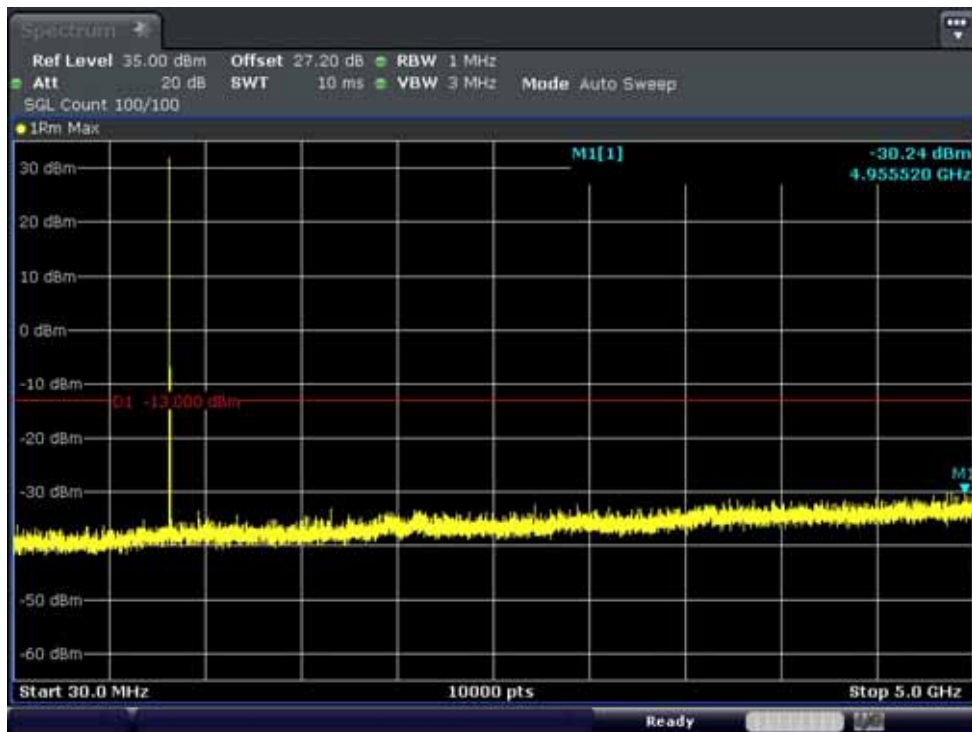

■ GSM850 MODE (190 CH.) Conducted Spurious Emissions2



■ GSM850 MODE (251 CH.) Conducted Spurious Emissions1

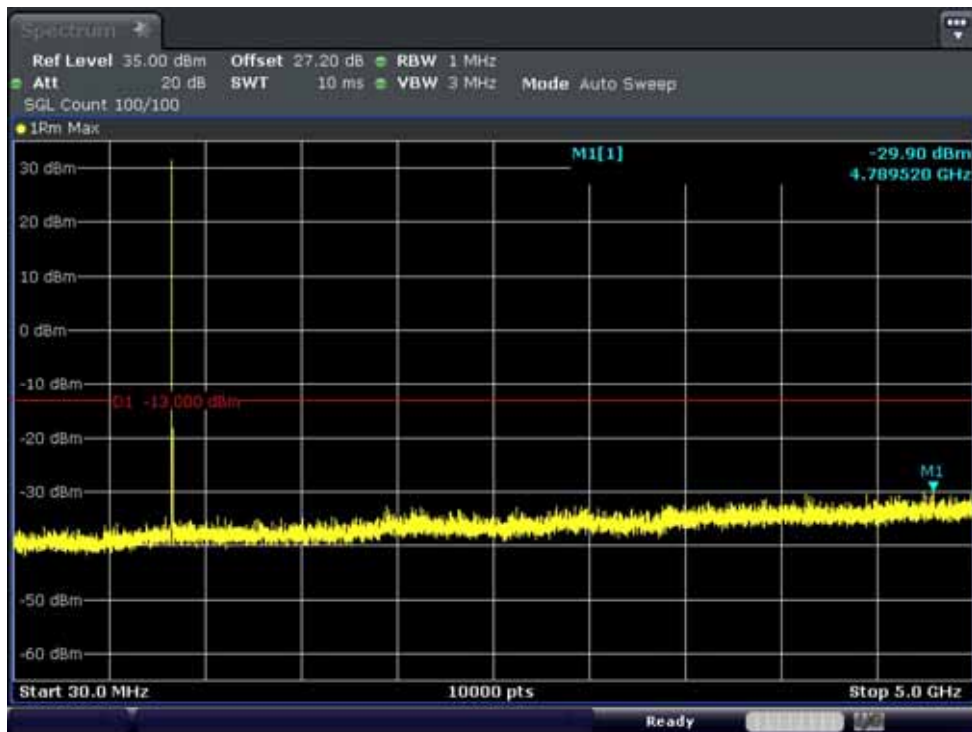

■ GSM850 MODE (251 CH.) Conducted Spurious Emissions2

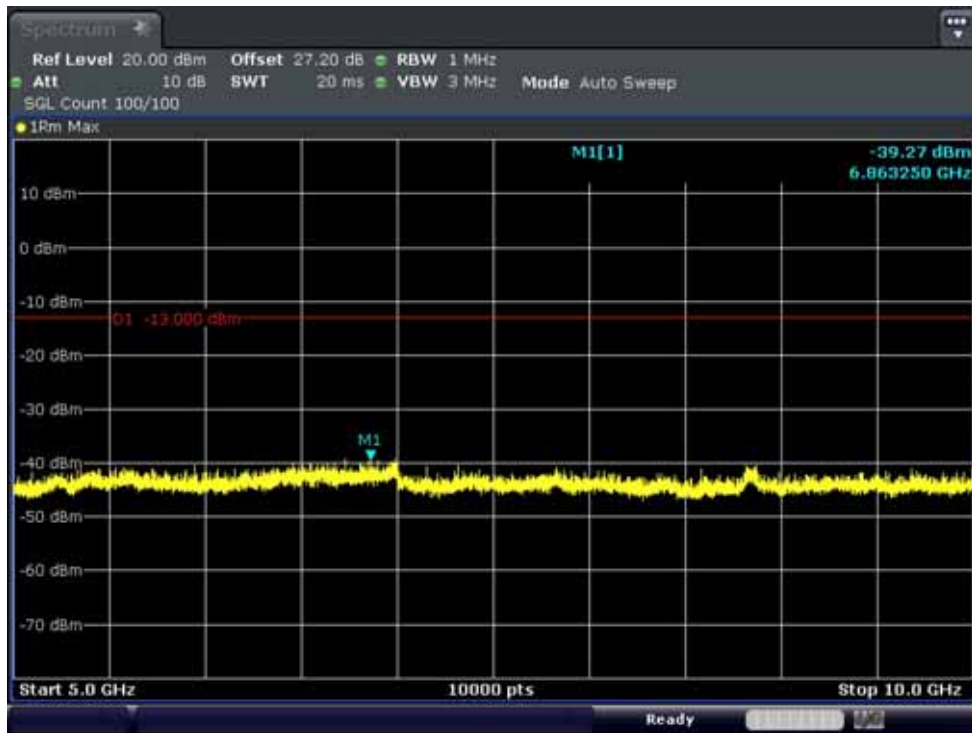

■ GSM1900 MODE (512 CH.) Conducted Spurious Emissions1

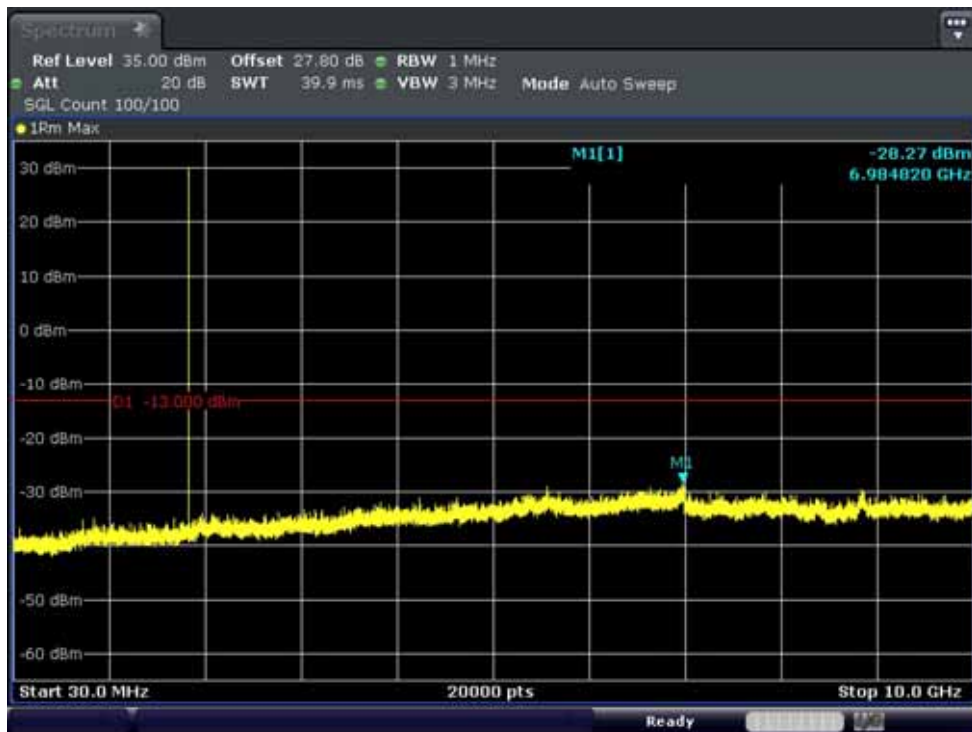

■ GSM1900 MODE (512 CH.) Conducted Spurious Emissions2



■ GSM1900 MODE (661 CH) Conducted Spurious Emissions1

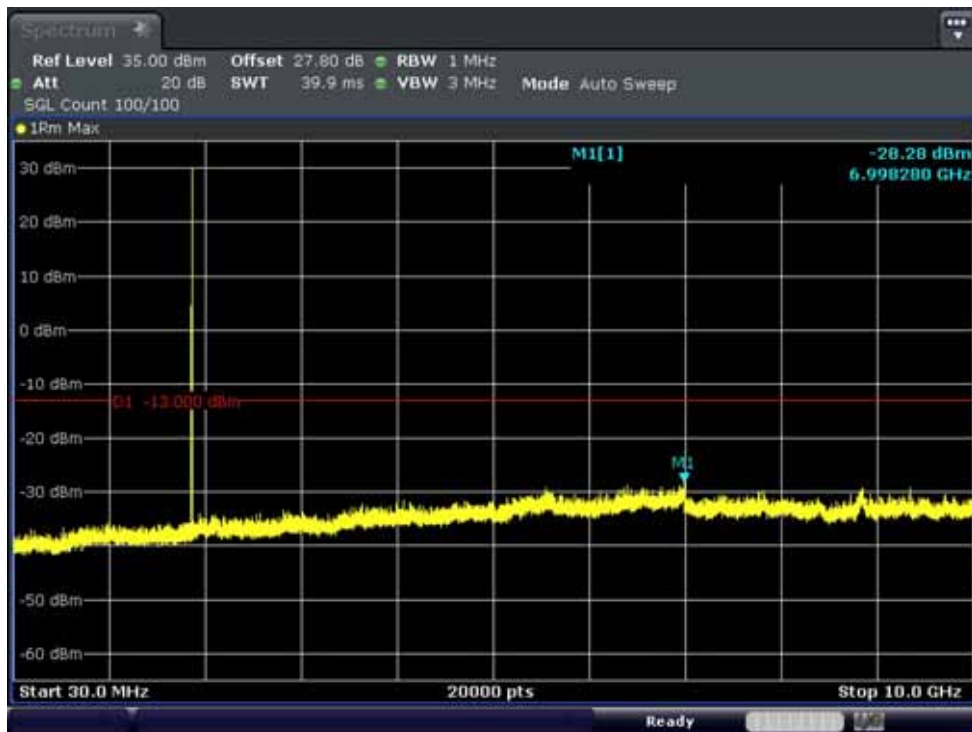

■ GSM1900 MODE (661 CH.) Conducted Spurious Emissions2

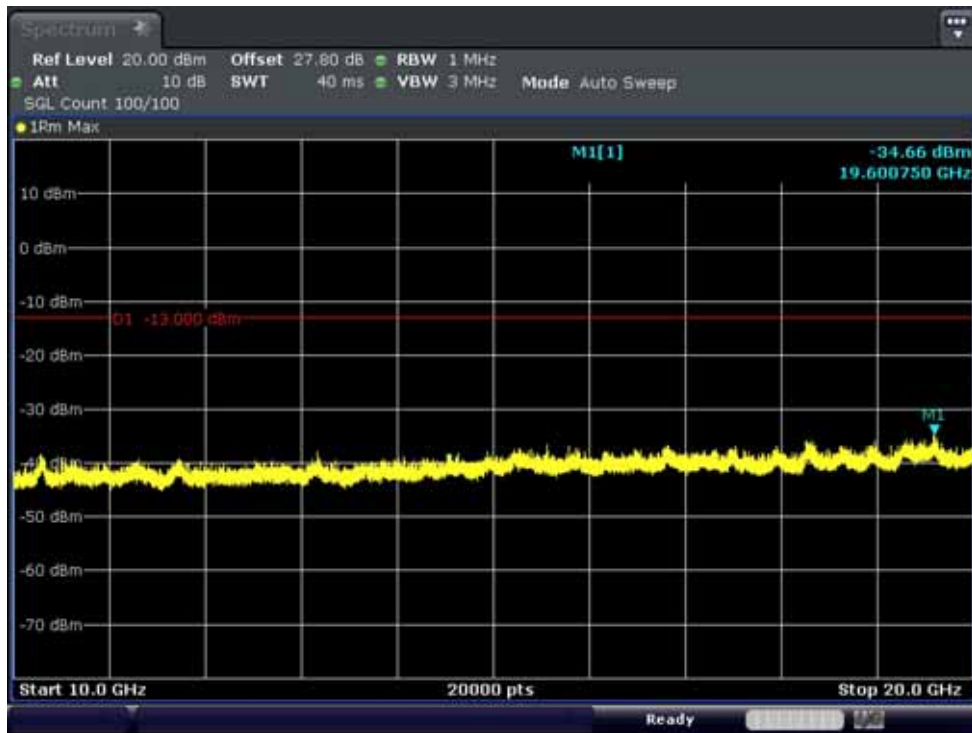

■ GSM1900 MODE (810 CH.) Conducted Spurious Emissions1

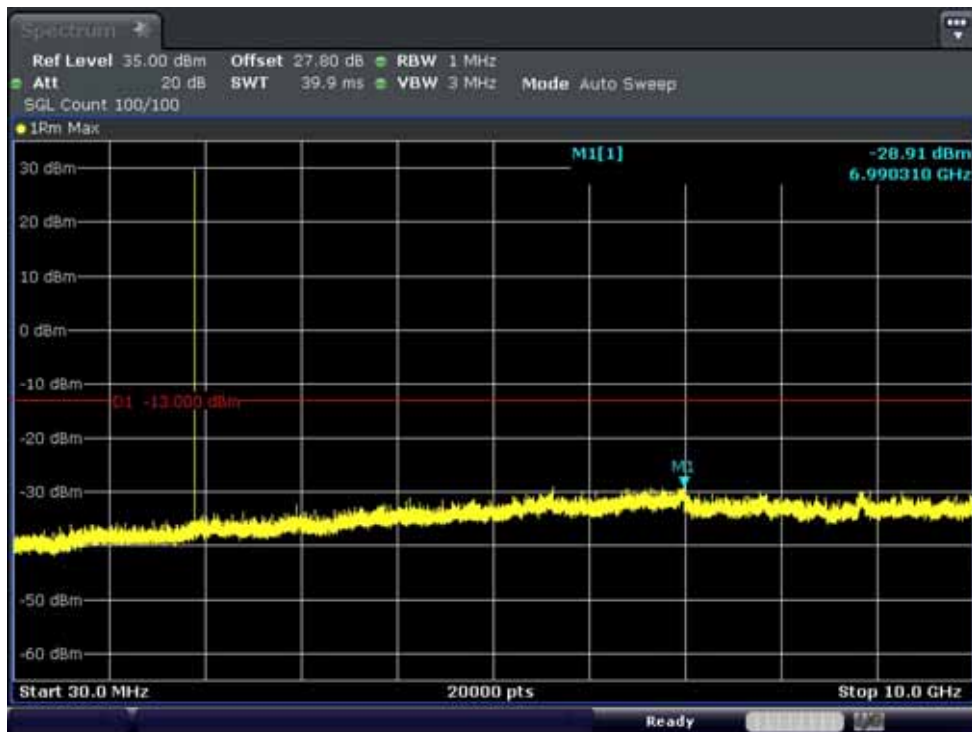

■ GSM1900 MODE (810 CH.) Conducted Spurious Emissions2

