

# TEST REPORT

<p><b>DT&amp;C Co., Ltd.</b> 42, Yurim-ro, 154Beon-gil, Cheoin-gu, Yongin-si, Gyeonggi-do, Korea Tel : 031-321-2664, Fax : 031-321-1664</p>	<p>Report No : DRTFCC1606-0087 Pages:(1) / (55) page</p>	
---	--	---

1. Customer

- Name : Suntech International Ltd.
- Address : B-1506, Greatvally, 32, 9-Gil, Digital-Ro, Geumcheon-Gu, Seoul 153-709

2. Use of Report : FCC & IC Original Grant

3. Product Name (FCC ID / IC): Tracker (WA2-STU650 / 21484-STU650)

4. Date of Test : 2016-05-31 ~ 2016-06-24

5. Test Method Used: §22(H), §24(E)  
RSS-132, 133

6. Testing Environment : See appended test report

7. Test Result :  Pass  Fail

The results shown in this test report refer only to the sample(s) tested unless otherwise stated. This Test Report cannot be reproduced, except in full.

Affirmation	Tested by Name : Jaejin Lee (Signature)	Technical Manager Name : GeunKi Son (Signature)
-------------	--	--

2016 . 06 . 28 .

DT&C Co., Ltd.

\* If this test report is required to confirmation of authenticity, please contact to [report@dtnc.net](mailto:report@dtnc.net)

## Test Report Version

Test Report No.	Date	Description
DRTFCC1606-0087	Jun. 28, 2016	Initial issue

# Table of Contents

- 1. GENERAL INFORMATION ..... 4**
- 2. INTRODUCTION ..... 5**
  - 2.1. EUT DESCRIPTION ..... 5
  - 2.2. Support equipment..... 5
  - 2.3. MEASURING INSTRUMENT CALIBRATION..... 5
  - 2.4. TEST FACILITY ..... 5
- 3. DESCRIPTION OF TESTS ..... 6**
  - 3.1 ERP & EIRP ..... 6
  - 3.2 PEAK TO AVERAGE RATIO ..... 8
  - 3.3 OCCUPIED BANDWIDTH..... 10
  - 3.4 BAND EDGE EMISSIONS AT ANTENNA TERMINAL. .... 11
  - 3.5 SPURIOUS AND HARMONIC EMISSIONS AT ANTENNA TERMINAL..... 12
  - 3.6 RADIATED SPURIOUS EMISSIONS ..... 13
  - 3.7 FREQUENCY STABILITY / VARIATION OF AMBIENT TEMPERATURE ..... 14
- 4. LIST OF TEST EQUIPMENT ..... 15**
- 5. SUMMARY OF TEST RESULTS ..... 16**
- 6. SAMPLE CALCULATION ..... 17**
- 7. TEST DATA ..... 18**
  - 7.1 Conducted OUTPUT POWER..... 18
  - 7.2 PEAK TO AVERAGE RATIO ..... 19
  - 7.3 OCCUPIED BANDWIDTH..... 19
  - 7.4 SPURIOUS AND HARMONIC EMISSIONS AT ANTENNA TERMINAL ..... 19
  - 7.5 BAND EDGE ..... 19
  - 7.6 EFFECTIVE RADIATED POWER..... 20
  - 7.7 EQUIVALENT ISOTROPIC RADIATED POWER ..... 21
  - 7.8 RADIATED SPURIOUS EMISSIONS ..... 22
    - 7.8.1 RADIATED SPURIOUS EMISSIONS (WCDMA850)..... 22
    - 7.8.2 RADIATED SPURIOUS EMISSIONS (HSUPA850) ..... 23
    - 7.8.3 RADIATED SPURIOUS EMISSIONS (WCDMA1900)..... 24
    - 7.8.4 RADIATED SPURIOUS EMISSIONS (HSUPA1900) ..... 25
  - 7.9 FREQUENCY STABILITY / VARIATION OF AMBIENT TEMPERATURE ..... 26
    - 7.9.1 FREQUENCY STABILITY (WCDMA850)..... 26
    - 7.9.2 FREQUENCY STABILITY (WCDMA1900)..... 27
- 8. TEST PLOTS ..... 28**
  - 8.1 Peak to Average Ratio..... 28
  - 8.2 Occupied Bandwidth (99 % Bandwidth) ..... 30
  - 8.3 Spurious Emissions at Antenna Terminal ..... 38
  - 8.4 Band Edge ..... 48

## 1. GENERAL INFORMATION

**Applicant Name:** Suntech International Ltd.

**Address:** B-1506, Greatvally, 32, 9-Gil, Digital-Ro, Geumcheon-Gu, Seoul 153-709

**FCC ID** : WA2-STU650  
**IC** : 21484-STU650  
**FCC Classification** : PCS Licensed Transmitter (PCB)  
**EUT** : Tracker  
**Model Name** : STU650  
**Add Model Name** : ST650  
**Supplying power** : DC 12 V  
**Antenna Information** : Internal Antenna

Mode	Tx Frequency (MHz)	Emission Designator	ERP(Max.power)		EIRP(Max.power)	
			dBm	W	dBm	W
WCDMA850	826.4 ~ 846.6 MHz	<b>4M08F9W</b>	<b>18.59</b>	<b>0.072</b>	<b>20.74</b>	<b>0.119</b>
HSUPA850	826.4 ~ 846.6 MHz	4M08F9W	17.95	0.062	20.10	0.102
WCDMA1900	1852.4 ~ 1907.6 MHz	4M07F9W	-	-	<b>19.87</b>	<b>0.097</b>
HSUPA1900	1852.4 ~ 1907.6 MHz	<b>4M10F9W</b>	-	-	18.93	0.078

Note: FCC is 850 band based on ERP.

## 2. INTRODUCTION

### 2.1. EUT DESCRIPTION

The Equipment Under Test(EUT) supports WCDMA.

### 2.2. Support equipment

Equipment	Model No.	Serial No.	Manufacturer	Note
-	-	-	-	-
-	-	-	-	-

Note: The above equipment were supported by manufacturer.

### 2.3. MEASURING INSTRUMENT CALIBRATION

The measuring equipment, which was utilized in performing the tests documented herein, has been calibrated in accordance with the manufacturer's recommendations for utilizing calibration equipment, which is traceable to recognized national standards.

### 2.4. TEST FACILITY

The 3m test site and conducted measurement facility used to collect the radiated data are located at the 42, Yurim-ro, 154beon-gil, Cheoin-gu, Yongin-si, Gyeonggi-do, Korea 449-935. The site is constructed in conformance with the requirements.

**- Semi anechoic chamber registration Number: 165783 (FCC) & 5740A-3 (IC)**

### 3. DESCRIPTION OF TESTS

#### 3.1 ERP & EIRP

(Effective Radiated Power & Equivalent Isotropic Radiated Power)

##### *Test Set-up*

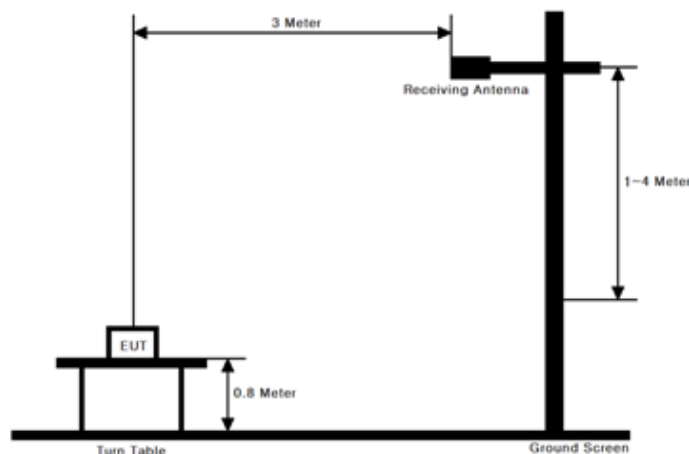

##### *Test Procedure*

- ANSI/TIA-603-C-2004 - Section 2.2.17
- KDB971168 v02r02 - Section 5.2.1

These measurements were performed at 3 & 10 m test site. The equipment under test is placed on a non-conductive table 0.8-meters above a turntable which is flush with the ground plane and 3 meters from the receive antenna.

##### Test setting

1. Set span to at least 1.5 times the OBW.
2. Set RBW = 1-5 % of the OBW, not to exceed 1 MHz.
3. Set VBW  $\geq 3 \times$  RBW.
4. Set number of points in sweep  $\geq 2 \times$  span / RBW.
5. Sweep time = auto couple.
6. Detector = RMS (power averaging).
7. If the EUT can be configured to transmit continuously (i.e., burst duty cycle  $\geq 98$  %), then set the trigger to free run.
8. If the EUT cannot be configured to transmit continuously (i.e., burst duty cycle  $< 98$  %), then use a sweep trigger with the level set to enable triggering only on full power bursts and configure the EUT to transmit at full power for the entire duration of each sweep.  
Ensure that the sweep time is less than or equal to the transmission burst duration.
9. Trace average at least 100 traces in power averaging (i.e., RMS) mode.
10. Compute the power by integrating the spectrum across the OBW of the signal using the instrument's band power measurement function, with the band limits set equal to the OBW band edges. If the instrument does not have a band power function, then sum the spectrum levels (in linear power units) at intervals equal to the RBW extending across the entire OBW of the spectrum.

The receive antenna height and turntable rotations were adjusted for the highest reading on the receive spectrum analyzer.

A half-wave dipole was substituted in place of the EUT. This dipole antenna was driven by a signal generator and the level of the signal generator was adjusted to obtain the same receive spectrum analyzer reading. The conducted power at the terminal of the substitute antenna is measured.

The ERP/EIRP is calculated using the following formula:

**ERP/EIRP = The conducted power at the substitute antenna's terminal [dBm] + Substitute Antenna gain [dBd for ERP , dBi for EIRP]**

For readings above 1 GHz, the above procedure is repeated using horn antennas and the difference between the gain of the horn antenna and an isotropic antenna are taken into consideration.

## 3.2 PEAK TO AVERAGE RATIO

### Test set-up

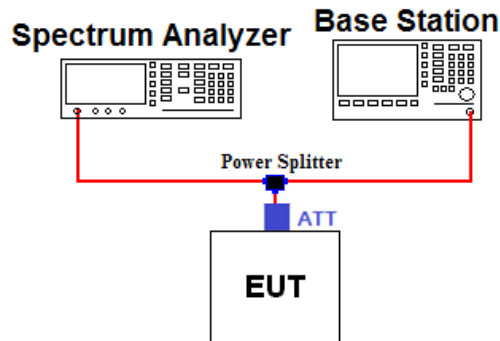

### Test Procedure

A peak to average ratio measurement is performed using the following procedure.

#### ■ CCDF Procedure

##### - KDB971168 v02r02-Section 5.7.1

1. Set resolution/measurement bandwidth  $\geq$  signal's occupied bandwidth
2. Set the number of counts to a value that stabilizes the measured CCDF curve
3. Set the measurement interval as follows:
  - 1) For continuous transmissions, set to 1 ms
  - 2) For burst transmissions, employ an external trigger that is synchronized with the EUT burst timing sequence, or use the internal burst trigger with a trigger level that allows the burst to stabilize and set the measurement interval to a time that is less than or equal to the burst duration.
4. Record the maximum PAPR level associated with a probability of 0.1%



## ■ Alternate Procedure

### - KDB971168 v02r02-Section 5.7.2

Use one of the measurement procedures of the peak power and record as  $P_{Pk}$ .

Use one of the measurement procedures of the average power and record as  $P_{Avg}$ .

Both the peak and average power levels must be expressed in the same logarithmic units (e.g., dBm). Determine the PAPR from:

$$\text{PAPR (dB)} = P_{Pk} \text{ (dBm)} - P_{Avg} \text{ (dBm)}.$$

### - Peak Power Measurement

1. Set the RBW  $\geq$  OBW
2. Set VBW  $\geq 3 \times$  RBW
3. Set span  $\geq 2 \times$  RBW
4. Sweep time = auto couple
5. Detector = peak
6. Ensure that the number of measurement points  $\geq$  span/RBW.
7. Trace mode = max hold
8. Allow trace to fully stabilize.
9. Use the peak marker function to determine the peak amplitude level.

### - Average Power Measurement

1. Set span to at least 1.5 times the OBW.
2. Set RBW = 1-5% of the OBW, not to exceed 1 MHz.
3. Set VBW  $\geq 3 \times$  RBW.
4. Set number of points in sweep  $\geq 2 \times$  span / RBW.
5. Sweep time = auto-couple.
6. Detector = RMS (power averaging).
7. If the EUT can be configured to transmit continuously (i.e., burst duty cycle  $\geq 98\%$ ), then set the trigger to free run.
8. If the EUT cannot be configured to transmit continuously (i.e., burst duty cycle  $< 98\%$ ), then use a sweep trigger with the level set to enable triggering only on full power bursts and configure the EUT to transmit at full power for the entire duration of each sweep.  
Ensure that the sweep time is less than or equal to the transmission burst duration.
9. Trace average at least 100 traces in power averaging (i.e., RMS) mode.
10. Compute the power by integrating the spectrum across the OBW of the signal using the instrument's band power measurement function, with the band limits set equal to the OBW band edges. If the instrument does not have a band power function, then sum the spectrum levels (in linear power units) at intervals equal to the RBW extending across the entire OBW of the spectrum.

### 3.3 OCCUPIED BANDWIDTH.

#### Test set-up

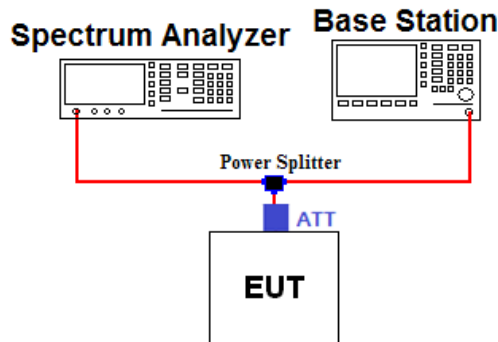

#### Offset value information

Frequency (MHz)	Offset Value (dB)	Frequency (MHz)	Offset Value (dB)
826.4	18.68	1852.4	19.19
836.6	18.69	1880.0	19.25
846.6	18.76	1907.6	19.27
-	-	-	-

Note. 1: The offset values from EUT to Spectrum analyzer were measured and used for test.  
 Offset value = Cable A + Splitter + ATT + Cable B

#### Test Procedure

##### - KDB971168 v02r02-Section 4.2

The occupied bandwidth, that is the frequency bandwidth such that, below its lower and above its upper frequency limits, the mean powers radiated are each equal to 0.5 percent of the total mean power of a given emission.

#### Test setting

1. The signal analyzer's automatic bandwidth measurement capability was used to perform the 99 % occupied bandwidth and the 26 dB bandwidth. The bandwidth measurement was not influenced by any intermediate power nulls in the fundamental emission.
2. RBW = 1 ~ 5 % of the expected OBW & VBW ≥ 3 X RBW
3. Detector = Peak
4. Trace mode = Max hold
5. Sweep = Auto couple
6. The trace was allowed to stabilize
7. If necessary, step 2 ~ 6 were repeated after changing the RBW such that it would be within 1 ~ 5 % of the 99 % occupied bandwidth observed in step 6.

### 3.4 BAND EDGE EMISSIONS AT ANTENNA TERMINAL.

#### Test set-up

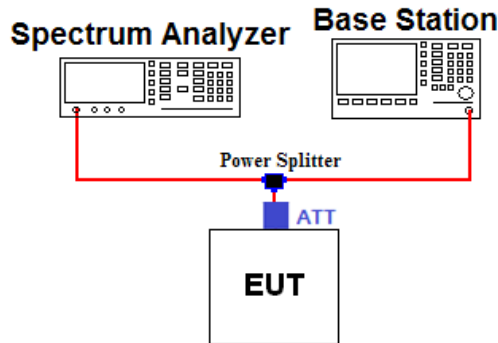

#### Offset value information

Frequency (MHz)	Offset Value (dB)	Frequency (MHz)	Offset Value (dB)
823.0	18.66	1849.0	19.19
824.0	18.68	1850.0	19.20
849.0	18.77	1910.0	19.27
850.0	18.77	1911.0	19.27
-	-	-	-

Note. 1: The offset value from EUT to Spectrum analyzer was measured and used for test.  
 Offset value = Cable A + Splitter + ATT + Cable B

#### Test Procedure

##### - KDB971168 v02r02 - Section 6.0

All out of band emissions are measured by means of a calibrated spectrum analyzer. The EUT was setup to maximum output power at its lowest and highest channel with all modulations.

The power of any spurious emission shall be attenuated below the transmitter power (P) by at least  $43 + 10 \log(P)$  dB

#### Test setting

1. Start and stop frequency were set such that the band edge would be placed in the center of the plot
2. Span was set large enough so as to capture all out of band emissions near the band edge
3. RBW  $\geq 1\%$  of the emission
4. VBW  $\geq 3 \times$  RBW
5. Detector = RMS & Trace mode = Max hold
6. Sweep time = Auto couple or 1 s for band edge
7. Number of sweep point  $\geq 2 \times$  span / RBW
8. The trace was allowed to stabilize

Note 1: In the 1 MHz bands immediately outside and adjacent to the frequency block a resolution bandwidth of **at least one percent** of the emission bandwidth of the fundamental emission of the transmitter may be employed to demonstrate compliance with the out-of-band emissions limit. The emission bandwidth is defined as the width of the signal between two points, one below the carrier center frequency and one above the carrier center frequency, outside of which all emission are attenuated at least 26 dB below the transmitter power.

### 3.5 SPURIOUS AND HARMONIC EMISSIONS AT ANTENNA TERMINAL.

#### Test set-up

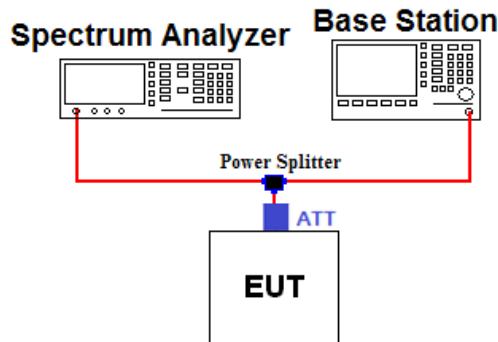

#### Offset value information

Frequency (MHz)	Offset Value (dB)	Frequency (MHz)	Offset Value (dB)
10000.0	20.45	20000.0	22.57
-	-	-	-
-	-	-	-

Note. 1: The offset value from EUT to Spectrum analyzer was measured and used for test.  
 Offset value = Cable A + Splitter + ATT + Cable B

#### Test Procedure

##### - KDB971168 v02r02 - Section 6.0

The level of the carrier and the various conducted spurious and harmonic frequencies is measured by means of a calibrated spectrum analyzer. The EUT was setup to maximum output power at its low, middle, high channel with all bandwidths. The spectrum is scanned from 30 MHz up to a frequency including its 10<sup>th</sup> harmonic.

The power of any spurious emission shall be attenuated below the transmitter power (P) by at least  $43 + 10 \log(P)$  dB

#### Test setting

1. RBW = 100 KHz or 1 MHz & VBW  $\geq 3 \times$  RBW ( Refer to Note 1)
2. Detector = RMS & Trace mode = Max hold
3. Sweep time = Auto couple
4. Number of sweep point  $\geq 2 \times$  span / RBW
5. The trace was allowed to stabilize

Note 1: Compliance with these provisions is based on the use of measurement instrumentation employing a resolution bandwidth of 100 kHz or greater for Part 22 and 1 MHz or greater for Part 24.

### 3.6 RADIATED SPURIOUS EMISSIONS

#### Test Set-up

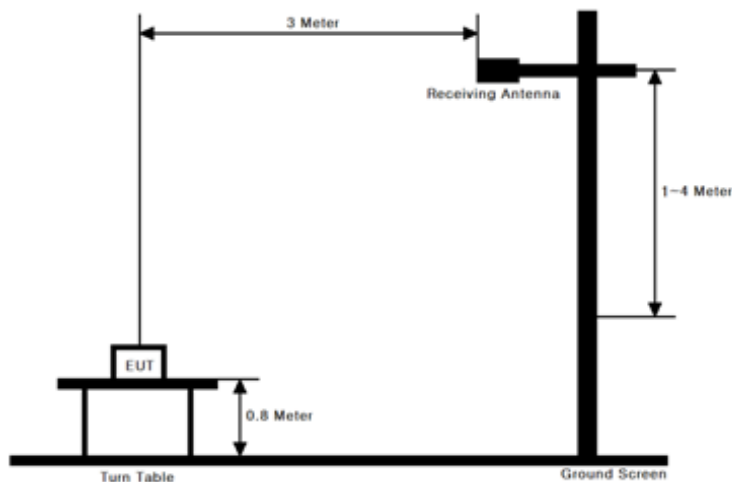

#### Test Procedure

- ANSI/TIA-603-C-2004 - Section 2.2.12
- KDB971168 v02r02 - Section 5.8

These measurements were performed at 3 & 10m test site. The equipment under test is placed on a non-conductive table 0.8-meters above a turntable which is flush with the ground plane and 3 meters from the receive antenna.

#### Test setting

1. RBW = 100 kHz for below 1 GHz and 1 MHz for above 1 GHz / VBW  $\geq$  3 X RBW
2. Detector = Peak & Trace mode = Max hold
3. Sweep time = Auto couple
4. Number of sweep point  $\geq$  2 X span / RBW
5. The trace was allowed to stabilize

The receive antenna height and turntable rotations were adjusted for the highest reading on the receive spectrum analyzer.

For radiated power measurements below 1 GHz, a half-wave dipole was substituted in place of the EUT. This dipole antenna was driven by a signal generator and the level of the signal generator was adjusted to obtain the same spectrum analyzer reading.

For radiated power measurements above 1 GHz, a Horn antenna was substituted in place of the EUT. This Horn antenna was driven by a signal generator and the level of the signal generator was adjusted to obtain the same spectrum analyzer reading. The difference between the gain of the horn and an isotropic antenna are taken into consideration.

This measurement was performed with the EUT oriented in 3 orthogonal axis.

### 3.7 FREQUENCY STABILITY / VARIATION OF AMBIENT TEMPERATURE

#### Test Set-up

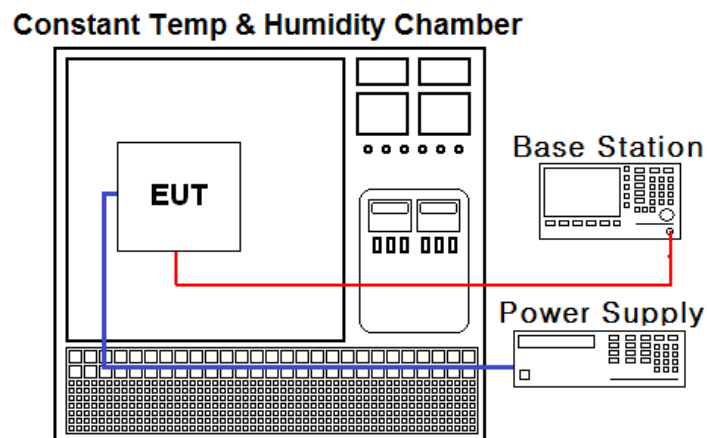

#### Test Procedure

- ANSI/TIA-603-C-2004
- KDB971168 v02r02 - Section 9.0

The frequency stability of the transmitter is measured by:

a.) **Temperature:**

The temperature is varied from - 30 °C to + 50 °C using an environmental chamber.

b.) **Primary Supply Voltage:**

The primary supply voltage is varied from 85 % to 115 % of the nominal value for non hand-carried battery and AC powered equipment. For hand-carried, battery-powered equipment, primary supply voltage is reduced to the battery operating end point which shall be specified by the manufacturer.

#### Specification:

The frequency stability shall be sufficient to ensure that the fundamental emission stays within the authorized frequency block for Part 24. The frequency stability of the transmitter shall be maintained within  $\pm 0.00025\%$  ( $\pm 2.5$  ppm) of the center frequency for Part 22.

#### Time Period and Procedure:

1. The carrier frequency of the transmitter is measured at room temperature.  
(25 °C to provide a reference)
2. The equipment is turned on in a “standby” condition for one minute before applying power to the transmitter. Measurement of the carrier frequency of the transmitter is made within one minute after applying power to the transmitter.
3. Frequency measurements are made at 10 °C intervals ranging from -30 °C to +50 °C.  
A period of at least one half-hour is provided to allow stabilization of the equipment at each temperature level.

## 4. LIST OF TEST EQUIPMENT

Type	Manufacturer	Model	Cal.Date (yy/mm/dd)	Next.Cal. Date (yy/mm/dd)	S/N
MXA Signal Analyzer	Agilent Technologies	N9020A	16/01/06	17/01/06	MY46471096
MXA Signal Analyzer	Agilent Technologies	N9020A	15/09/09	16/09/09	MY46471248
Power Splitter	Anritsu	K241B	15/10/20	16/10/20	1701061
2W 3dB Attenuator	SMAJK	SMAJK-2-3	15/10/19	16/10/19	3
50W 10dB Attenuator	SMAJK	SMAJK-50-10	15/10/19	16/10/19	2-50-10
DC Power Supply	SM techno	SDP30-5D	15/09/23	16/09/23	305DMG305
Multimeter	FLUKE	17B	16/04/21	17/04/21	26030065WS
Temp & Humi Test Chamber	SJ Science	SJ-TH-S50	15/10/19	16/10/19	SJ-TH-S50-131011
Vector Signal Generator	R&S	SMBV100A	16/01/05	17/01/05	255571
Signal Generator	R&S	SMF100A	15/06/29	16/06/29	102341
8960 Series 10 Wireless Comms Test Set	Agilent Technologies	E5515C	15/09/10	16/09/10	GB41321164
Thermohygrometer	BODYCOM	BJ5478	16/02/25	17/02/25	1209
Loop Antenna	Schwarzbeck	FMZB1513	16/04/22	18/04/22	1513-128
TRILOG Broadband Test-Antenna	Schwarzbeck	VULB 9161	14/07/10	16/07/10	4070
Dipole Antenna	Schwarzbeck	VHA9103	15/05/29	17/05/29	2116
Dipole Antenna	Schwarzbeck	VHA9103	16/04/15	18/04/15	2117
Dipole Antenna	Schwarzbeck	UHA9105	15/05/29	17/05/29	2261
Dipole Antenna	Schwarzbeck	UHA9105	16/04/15	18/04/15	2262
HORN ANT	ETS	3115	15/02/09	17/02/09	00021097
HORN ANT	ETS	3117	16/05/03	18/05/03	140394
HORN ANT	A.H.Systems	SAS-574	15/04/30	17/04/30	154
HORN ANT	A.H.Systems	SAS-574	15/09/03	17/09/03	155
Amplifier	EMPOWER	BBS3Q7ELU	15/09/09	16/09/09	1020
Low Noise Pre Amplifier	tsj	MLA-010K01-B01-27	16/03/10	17/03/10	1844539
Amplifier (30dB)	Agilent	8449B	15/11/06	16/11/06	3008A02108
High-pass filter	Wainwright	WHKX12-935-1000-15000-40SS	15/09/23	16/09/23	7
High-pass filter	Wainwright	WHKX12-2580-3000-18000-80SS	15/09/23	16/09/23	3

## 5. SUMMARY OF TEST RESULTS

FCC Part Section(s)	RSS Section(s)	Parameter	Status Note 1
2.1046	RSS-132 [5.4] RSS-133 [6.4]	Conducted Output Power	<b>C</b>
22.913(a) 24.232(c)	RSS-132 [5.4] [SRSP-503(5.1.3)] RSS-133 [6.4] [SRSP-510(5.1.2)]	Effective Radiated Power Equivalent Isotropic Radiated Power	<b>C</b>
22.917(a) 24.238(a) 2.1049	RSS-Gen [6.6]	Occupied Bandwidth	<b>C</b>
22.917(a) 24.238(a) 2.1051	RSS-132 [5.5] RSS-133 [6.5]	Band Edge Spurious and Harmonic Emissions at Antenna Terminal	<b>C</b>
24.232(d)	RSS-132 [5.4] RSS-133 [6.4]	Peak to Average Ratio	<b>C</b>
22.917(a) 24.238(a) 2.1053	RSS-132 [5.5] RSS-133 [6.5]	Radiated Spurious and Harmonic Emissions	<b>C</b>
22.355 24.235 2.1055	RSS-132 [5.3] RSS-133 [6.3]	Frequency Stability	<b>C</b>
Note 1: <b>C</b> =Comply <b>NC</b> =Not Comply <b>NT</b> =Not Tested <b>NA</b> =Not Applicable			

The sample was tested according to the following specification:  
**ANSI/TIA/EIA-603-C-2004 and KDB 971168 D01 v02r02**



## 6. SAMPLE CALCULATION

### A. Emission Designator

#### WCDMA850 Emission Designator

Emission Designator = **4M08F9W**  
 WCDMA OBW = 4.0820 MHz  
 (Measured at the 99.75 % power bandwidth)  
 F = Frequency Modulation  
 9 = Composite Digital Information  
 W = Combination (Audio/Data)

#### WCDMA1900 Emission Designator

Emission Designator = **4M07F9W**  
 WCDMA OBW = 4.0705 MHz  
 (Measured at the 99.75 % power bandwidth)  
 F = Frequency Modulation  
 9 = Composite Digital Information  
 W = Combination (Audio/Data)

#### HSUPA850 Emission Designator

Emission Designator = **4M08F9W**  
 HSUPA OBW = 4.0813 MHz  
 (Measured at the 99.75 % power bandwidth)  
 F = Frequency Modulation  
 9 = Composite Digital Information  
 W = Combination (Audio/Data)

#### HSUPA1900 Emission Designator

Emission Designator = **4M10F9W**  
 HSUPA OBW = 4.1015 MHz  
 (Measured at the 99.75 % power bandwidth)  
 F = Frequency Modulation  
 9 = Composite Digital Information  
 W = Combination (Audio/Data)

### B. ERP Sample Calculation

MODE	Ch./ Freq		Spectrum Reading Value(dBm)	EUT Axis	Ant Pol (H/V)	Level(dBm) @ Ant Terminal	TX Ant Gain(dBd)	Result	
	channel	Freq.(MHz)						(dBm)	(W)
WCDMA850	4233	846.6	-16.56	Z	H	17.24	1.35	18.59	0.072

#### ERP = @ Ant Terminal LEVEL(dBm) + Ant. Gain

- 1) The EUT mounted on a non-conductive turntable is 0.8 meter above test site ground level.
- 2) During the test, the turn table is rotated until the maximum signal is found.
- 3) Record the field strength meter's level.
- 4) Replace the EUT with dipole/Horn antenna that is connected to a calibrated signal generator.
- 5) Increase the signal generator output till the field strength meter's level is equal to the item (3).
- 6) The signal generator output level with Ant. Gain is the rating of effective radiated power (ERP).

## 7. TEST DATA

### 7.1 Conducted OUTPUT POWER

A base station simulator was used to establish communication with the EUT. The base station simulator parameters were set to produce the maximum power from the EUT. This device was tested under all configurations and the highest power is reported. Conducted Output Powers of EUT are reported below.

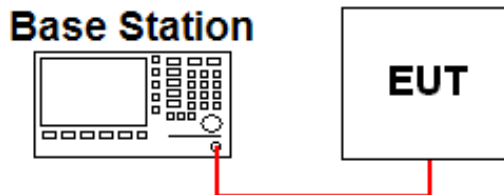

The output power was measured using the Agilent E5515C

• WCDMA / HSDPA / HSUPA

3GPP Release Version	Mode	3GPP 34.121 Subtest	Cellular Band (dBm)			PCS Band (dBm)			3GPP MPR (dB)
			4132	4183	4233	9262	9400	9538	
99	WCDMA	12.2 kbps RMC	21.66	21.25	21.44	21.78	21.77	21.59	-
99		12.2 kbps AMR	-	-	-	-	-	-	-
5	HSDPA	Subtest 1	21.63	21.21	21.42	21.72	21.69	21.55	0
5		Subtest 2	21.42	20.99	21.17	21.47	21.43	21.26	0
5		Subtest 3	21.19	20.74	20.88	21.25	21.12	20.99	0.5
5		Subtest 4	20.90	20.45	20.67	21.00	20.87	20.73	0.5
6	HSUPA	Subtest 1	20.16	20.26	20.43	20.49	20.32	20.20	0
6		Subtest 2	19.43	18.96	19.25	19.42	19.26	18.89	2
6		Subtest 3	20.04	19.76	19.88	19.51	19.79	19.34	1
6		Subtest 4	19.51	19.36	19.54	18.88	18.97	18.53	2
6		Subtest 5	21.28	21.08	21.14	20.02	20.13	19.77	0

## 7.2 PEAK TO AVERAGE RATIO

- Plots of the EUT's Peak- to- Average Ratio are shown in Clause 8.1

## 7.3 OCCUPIED BANDWIDTH

Band	Channel	Frequency	Test Result (kHz)
WCDMA850	4132	826.4	4077.70
	<b>4183</b>	<b>836.6</b>	<b>4082.00</b>
	4233	846.6	4074.60
HSUPA850	<b>4132</b>	<b>826.4</b>	<b>4081.30</b>
	4183	836.6	4068.30
	4233	846.6	4060.20
WCDMA1900	<b>9262</b>	<b>1852.4</b>	<b>4070.50</b>
	9400	1880.0	4065.30
	9538	1907.6	4068.40
HSUPA1900	<b>9262</b>	<b>1852.4</b>	<b>4101.50</b>
	9400	1880.0	4065.40
	9538	1907.6	4051.50

- Plots of the EUT's Occupied Bandwidth are shown in Clause 8.2

## 7.4 SPURIOUS AND HARMONIC EMISSIONS AT ANTENNA TERMINAL

- Plots of the EUT's Conducted Spurious Emissions are shown in Clause 8.3

## 7.5 BAND EDGE

- Plots of the EUT's Band Edge are shown in Clause 8.4

## 7.6 EFFECTIVE RADIATED POWER

### - WCDMA850 data

Freq(MHz) CH	EUT Position (Axis)	Test mode 12.2 kbps RMC						
		Pol. (H/V)	LEVEL@ TX ANTENNA TERMINAL (dBm)	Antenna Gain (dBd)	ERP (dBm)	ERP (W)	Rated Voltage	Note.
826.4 4132	Z	H	15.89	1.24	17.13	0.052	DC 12V	-
836.6 4183	Z	H	16.12	1.30	17.42	0.055	DC 12V	-
<b>846.6 4233</b>	<b>Z</b>	<b>H</b>	<b>17.24</b>	<b>1.35</b>	<b>18.59</b>	<b>0.072</b>	<b>DC 12V</b>	-

### - HSUPA850 data

Freq(MHz) CH	EUT Position (Axis)	Test mode subtest 5						
		Pol. (H/V)	LEVEL@ TX ANTENNA TERMINAL (dBm)	Antenna Gain (dBd)	ERP (dBm)	ERP (W)	Rated Voltage	Note.
826.4 4132	Z	H	15.12	1.24	16.36	0.043	DC 12V	-
836.6 4183	Z	H	15.22	1.30	16.52	0.045	DC 12V	-
<b>846.6 4233</b>	<b>Z</b>	<b>H</b>	<b>16.60</b>	<b>1.35</b>	<b>17.95</b>	<b>0.062</b>	<b>DC 12V</b>	-

#### NOTES:

This EUT was tested under all configurations and the highest power is reported in WCDMA mode with HSDPA inactive at 12.2 kbps RMC and TPC bits set to "1" and HSUPA mode with 12.2 kbps + HSPA and subtest 5. Also, we have done x, y, z planes in EUT and horizontal and vertical polarization of detecting antenna. The worst case data is reported.

## 7.7 EQUIVALENT ISOTROPIC RADIATED POWER

### - WCDMA1900 data

Freq(MHz) CH	EUT Position (Axis)	Test mode 12.2 kbps RMC						Note.
		Pol. (H/V)	LEVEL@ TX ANTENNA TERMINAL (dBm)	Antenna Gain (dBi)	EIRP (dBm)	EIRP (W)	Rated Voltage	
1852.4 9262	Y	V	9.86	9.01	18.87	0.077	DC 12V	-
<b>1880.0 9400</b>	<b>Y</b>	<b>V</b>	<b>10.82</b>	<b>9.05</b>	<b>19.87</b>	<b>0.097</b>	<b>DC 12V</b>	-
1907.6 9538	Y	V	10.24	9.08	19.32	0.086	DC 12V	-

### - HSUPA1900 data

Freq(MHz) CH	EUT Position (Axis)	Test mode subtest 1						Note.
		Pol. (H/V)	LEVEL@ TX ANTENNA TERMINAL (dBm)	Antenna Gain (dBi)	EIRP (dBm)	EIRP (W)	Rated Voltage	
1852.4 9262	Y	V	8.49	9.01	17.50	0.056	DC 12V	-
<b>1880.0 9400</b>	<b>Y</b>	<b>V</b>	<b>9.88</b>	<b>9.05</b>	<b>18.93</b>	<b>0.078</b>	<b>DC 12V</b>	-
1907.6 9538	Y	V	9.51	9.08	18.59	0.072	DC 12V	-

#### NOTES:

This EUT was tested under all configurations and the highest power is reported in WCDMA mode with HSDPA inactive at 12.2 kbps RMC and TPC bits set to "1" and HSUPA mode with 12.2 kbps + HSPA and subtest 1. Also, we have done x, y, z planes in EUT and horizontal and vertical polarization of detecting antenna. The worst case data is reported.

## 7.8 RADIATED SPURIOUS EMISSIONS

### 7.8.1 RADIATED SPURIOUS EMISSIONS (WCDMA850)

Channel (ERP)	Freq. (MHz)	EUT Position (Axis)	POL (H/V)	LEVEL@ ANTENNA TERMINAL (dBm)	Substitute Antenna Gain (dBd)	Correct Generator Level (dBm)	Result (dBc)	Limit (dBc)
4132 (0.052 W)	1650.36	Y	H	-44.28	6.64	-37.64	54.77	30.13
	-	-	-	-	-	-	-	
	-	-	-	-	-	-	-	
4183 (0.055 W)	1670.76	Y	H	-45.13	6.66	-38.47	55.89	30.42
	-	-	-	-	-	-	-	
	-	-	-	-	-	-	-	
4233 (0.072 W)	1695.58	Y	H	-46.31	6.69	-39.62	58.21	31.59
	-	-	-	-	-	-	-	
	-	-	-	-	-	-	-	

- Limit Calculation=  $43 + 10 \log_{10}(ERP [W])$  [dBc]

- No other spurious and harmonic emissions were reported greater than listed emissions above table.

#### NOTES:

This EUT was tested under all configurations and the highest power is reported in WCDMA mode with HSDPA inactive at 12.2 kbps RMC and TPC bits set to "1" and HSUPA mode with 12.2 kbps + HSPA and subtest 5. Also, we have done x, y, z planes in EUT and horizontal and vertical polarization of detecting antenna.

The worst case data is reported

## 7.8.2 RADIATED SPURIOUS EMISSIONS (HSUPA850)

Channel (ERP)	Freq. (MHz)	EUT Position (Axis)	POL (H/V)	LEVEL@ ANTENNA TERMINAL (dBm)	Substitute Antenna Gain (dBd)	Correct Generator Level (dBm)	Result (dBc)	Limit (dBc)
4132 (0.043 W)	1653.20	Y	H	-45.59	6.64	-38.95	55.31	29.36
	-	-	-	-	-	-	-	
	-	-	-	-	-	-	-	
4183 (0.045 W)	1673.84	Y	H	-46.84	6.66	-40.18	56.70	29.52
	-	-	-	-	-	-	-	
	-	-	-	-	-	-	-	
4233 (0.062 W)	1692.68	Y	H	-46.94	6.69	-40.25	58.20	30.95
	-	-	-	-	-	-	-	
	-	-	-	-	-	-	-	

- Limit Calculation=  $43 + 10 \log_{10}(ERP [W])$  [dBc]

- No other spurious and harmonic emissions were reported greater than listed emissions above table.

### NOTES:

This EUT was tested under all configurations and the highest power is reported in WCDMA mode with HSDPA inactive at 12.2 kbps RMC and TPC bits set to "1" and HSUPA mode with 12.2 kbps + HSPA and subtest 5. Also, we have done x, y, z planes in EUT and horizontal and vertical polarization of detecting antenna.

The worst case data is reported

### 7.8.3 RADIATED SPURIOUS EMISSIONS (WCDMA1900)

Channel (EIRP)	Freq. (MHz)	EUT Position (Axis)	POL (H/V)	LEVEL@ ANTENNA TERMINAL (dBm)	Substitute Antenna Gain (dBi)	Correct Generator Level (dBm)	Result (dBc)	Limit (dBc)
9262 (0.077 W)	3707.34	Y	H	-33.11	9.91	-23.20	42.07	31.87
	5560.80	Y	V	-40.60	10.99	-29.61	48.48	
	7413.40	Y	H	-50.82	11.55	-39.27	58.14	
	-	-	-	-	-	-	-	
9400 (0.097 W)	3762.62	Y	H	-30.54	9.85	-20.69	40.56	32.87
	5643.60	Y	V	-42.30	11.12	-31.18	51.05	
	7525.20	Y	H	-42.62	11.51	-31.11	50.98	
	-	-	-	-	-	-	-	
9538 (0.086 W)	3813.32	Y	H	-29.75	9.80	-19.95	39.27	32.32
	5725.23	Y	V	-49.53	11.24	-38.29	57.61	
	7636.16	Y	H	-49.23	11.46	-37.77	57.09	
	-	-	-	-	-	-	-	

- Limit Calculation =  $43 + 10 \log_{10}(\text{EIRP [W]})$  [dBc]

- No other spurious and harmonic emissions were reported greater than listed emissions above table.

#### NOTES:

This EUT was tested under all configurations and the highest power is reported in WCDMA mode with HSDPA inactive at 12.2 kbps RMC and TPC bits set to "1" and HSUPA mode with 12.2 kbps + HSPA and subtest 1. Also, we have done x, y, z planes in EUT and horizontal and vertical polarization of detecting antenna.

The worst case data is reported



#### 7.8.4 RADIATED SPURIOUS EMISSIONS (HSUPA1900)

Channel (EIRP)	Freq. (MHz)	EUT Position (Axis)	POL (H/V)	LEVEL@ ANTENNA TERMINAL (dBm)	Substitute Antenna Gain (dBi)	Correct Generator Level (dBm)	Result (dBc)	Limit (dBc)
9262 (0.056 W)	3705.45	Y	H	-34.46	9.91	-24.55	42.05	30.50
	5557.45	Y	V	-42.25	10.99	-31.26	48.76	
	7410.16	Y	H	-50.96	11.55	-39.41	56.91	
	-	-	-	-	-	-	-	
9400 (0.078 W)	3760.10	Y	H	-33.32	9.86	-23.46	42.39	31.93
	5641.24	Y	V	-42.73	11.11	-31.62	50.55	
	7521.36	Y	H	-45.18	11.51	-33.67	52.60	
	-	-	-	-	-	-	-	
9538 (0.072 W)	3814.45	Y	H	-31.06	9.80	-21.26	39.85	31.59
	5722.58	Y	V	-51.74	11.23	-40.51	59.10	
	7630.70	Y	H	-50.71	11.47	-39.24	57.83	
	-	-	-	-	-	-	-	

- Limit Calculation =  $43 + 10 \log_{10}( \text{EIRP [W]} )$  [dBc]

- No other spurious and harmonic emissions were reported greater than listed emissions above table.

#### NOTES:

This EUT was tested under all configurations and the highest power is reported in WCDMA mode with HSDPA inactive at 12.2 kbps RMC and TPC bits set to "1" and HSUPA mode with 12.2 kbps + HSPA and subtest 1. Also, we have done x, y, z planes in EUT and horizontal and vertical polarization of detecting antenna. The worst case data is reported

## 7.9 FREQUENCY STABILITY / VARIATION OF AMBIENT TEMPERATURE

### 7.9.1 FREQUENCY STABILITY (WCDMA850)

OPERATING FREQUENCY : 836,600,000\_Hz  
 CHANNEL : 4183(Mid)  
 REFERENCE VOLTAGE : 12 V DC  
 DEVIATION LIMIT(FCC & IC) :  $\pm 0.00025\%$  or 2.5 ppm

VOLTAGE (%)	POWER (V DC)	TEMP (°C)	FREQ (Hz)	Deviation	
				(ppm)	(%)
100%	12.0	+20(Ref)	836,600,019	0.023	0.00000227
100%		-30	836,600,017	0.020	0.00000203
100%		-20	836,600,015	0.018	0.00000179
100%		-10	836,600,027	0.032	0.00000323
100%		0	836,600,026	0.031	0.00000311
100%		+10	836,600,011	0.013	0.00000131
100%		+20	836,600,019	0.023	0.00000227
100%		+30	836,600,025	0.030	0.00000299
100%		+40	836,600,013	0.016	0.00000155
100%		+50	836,600,016	0.019	0.00000191
115%	13.8	+20	836,600,022	0.026	0.00000263
85%	10.2	+20	836,600,007	0.008	0.00000084

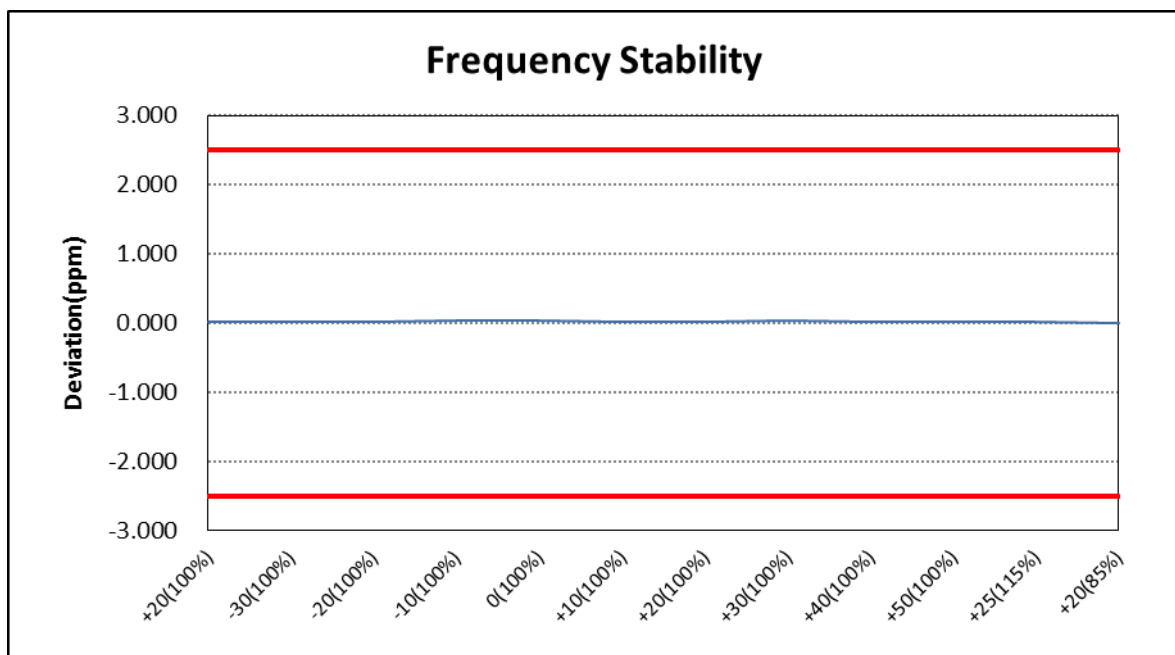

### 7.9.2 FREQUENCY STABILITY (WCDMA1900)

OPERATING FREQUENCY : 1,880,000,000 Hz  
 CHANNEL : 9400(Mid)  
 REFERENCE VOLTAGE : 12 V DC  
 LIMIT(FCC) : The frequency stability shall be sufficient to ensure that the fundamental emission stays within the authorized frequency block.  
 DEVIATION LIMIT(IC) : ± 0.00025 % or 2.5 ppm

VOLTAGE (%)	POWER (V DC)	TEMP (°C)	FREQ (Hz)	Deviation	
				(ppm)	(%)
100%	12.0	+20(Ref)	1,880,000,030	0.016	0.00000160
100%		-30	1,880,000,017	0.009	0.00000090
100%		-20	1,880,000,042	0.022	0.00000223
100%		-10	1,880,000,033	0.018	0.00000176
100%		0	1,880,000,026	0.014	0.00000138
100%		+10	1,880,000,053	0.028	0.00000282
100%		+20	1,880,000,046	0.024	0.00000245
100%		+30	1,880,000,042	0.022	0.00000223
100%		+40	1,880,000,033	0.018	0.00000176
100%		+50	1,880,000,026	0.014	0.00000138
115%	13.8	+20	1,880,000,048	0.026	0.00000255
85%	10.2	+20	1,880,000,042	0.022	0.00000223

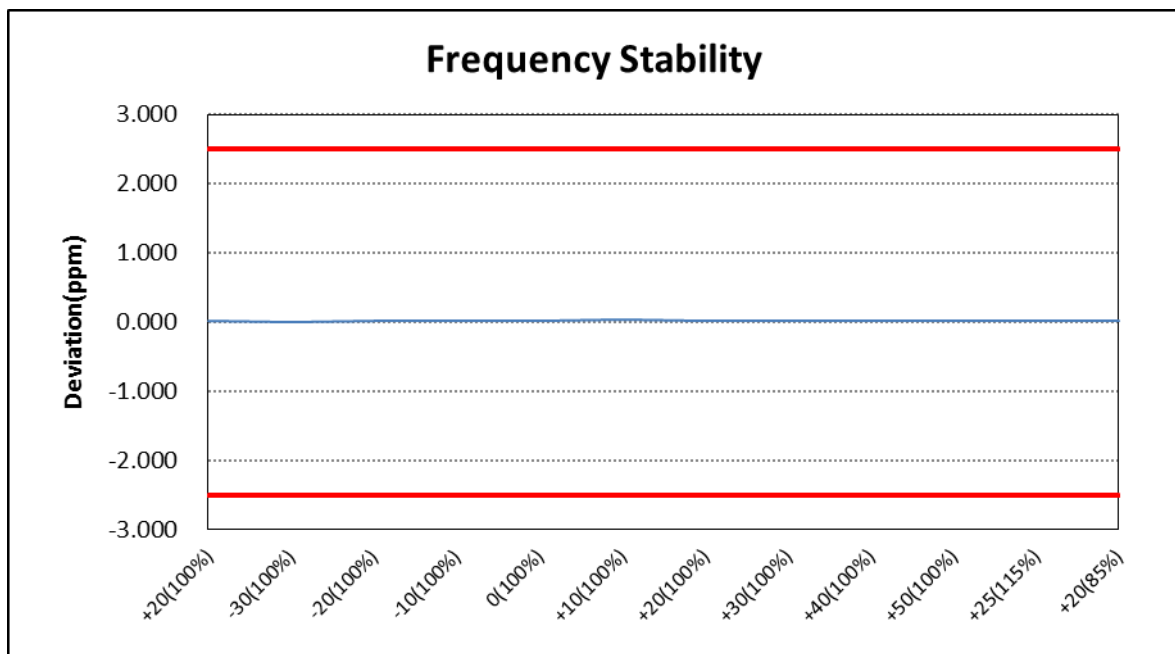

**Note.** Based on the results of the frequency stability test at the center channel the frequency deviation results measured are very small. as such it is determined that the channels at the band edge would remain inband when the maximum measured frequency deviation noted during the frequency stability tests is applied. therefore the device is determined to remain operating in band over the temperature and voltage range as tested.

## 8. TEST PLOTS

### 8.1 Peak to Average Ratio

WCDMA850 & Channel: 4183

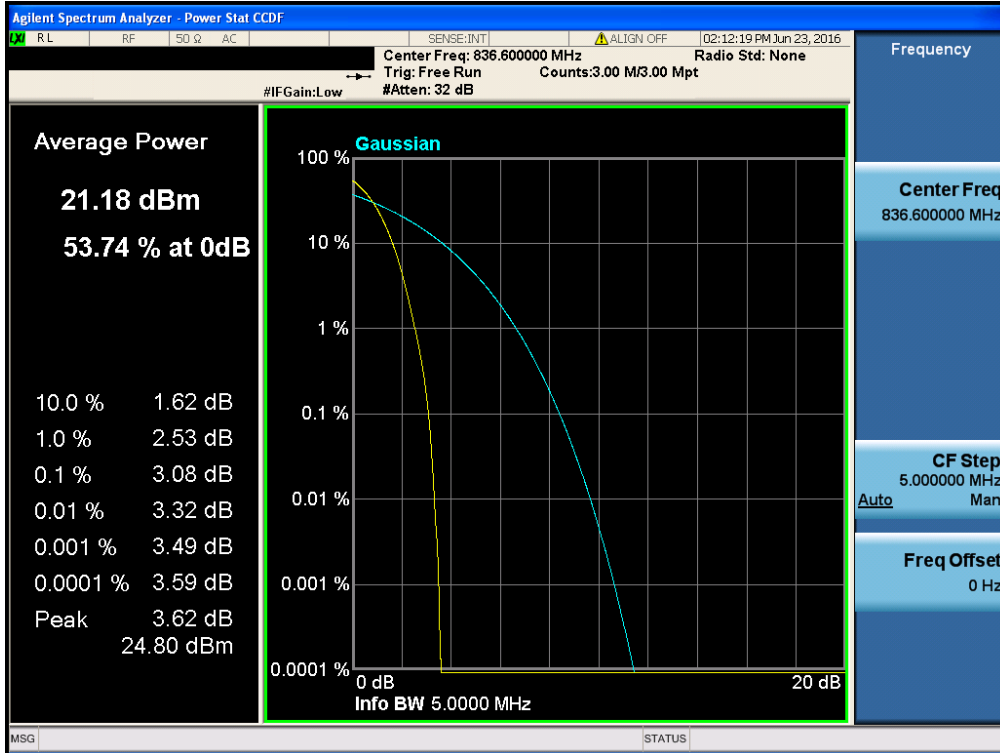

HSUPA850 & Channel: 4183

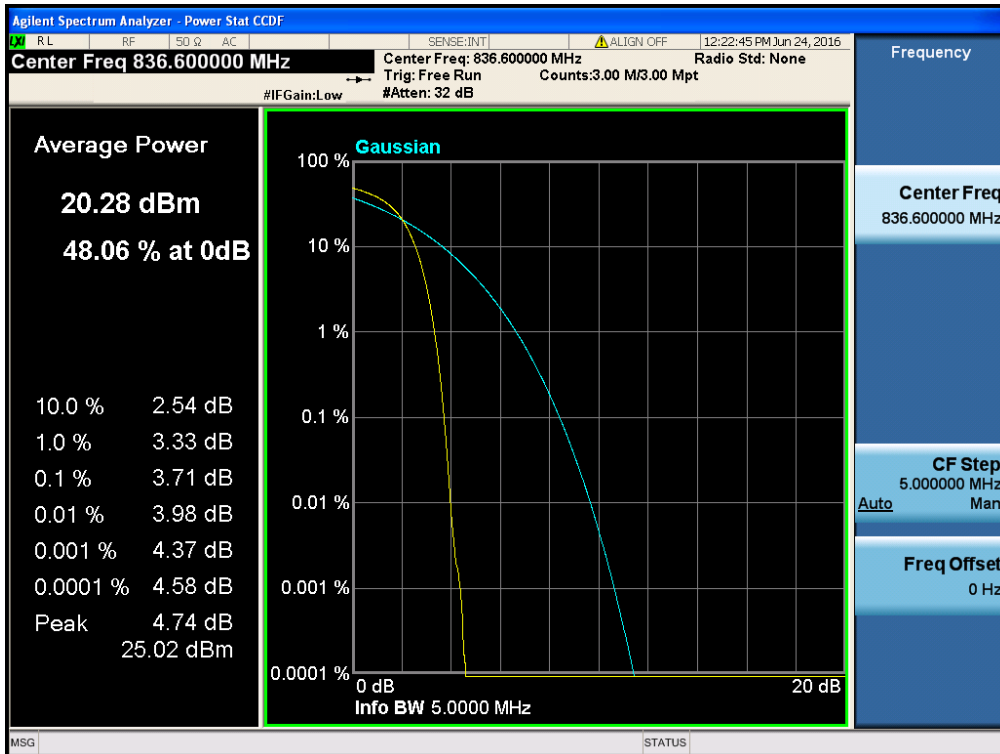

WCDMA1900 & Channel: 9400

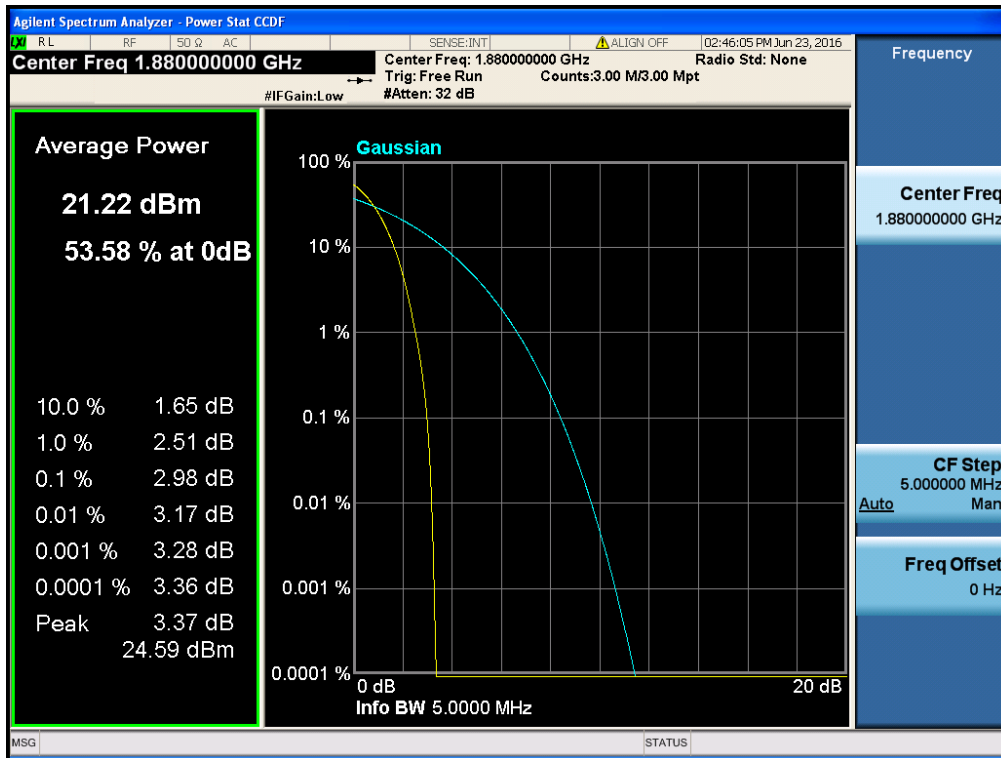

HSUPA1900 & Channel: 9400



## 8.2 Occupied Bandwidth (99 % Bandwidth)

WCDMA850 & Channel: 4132

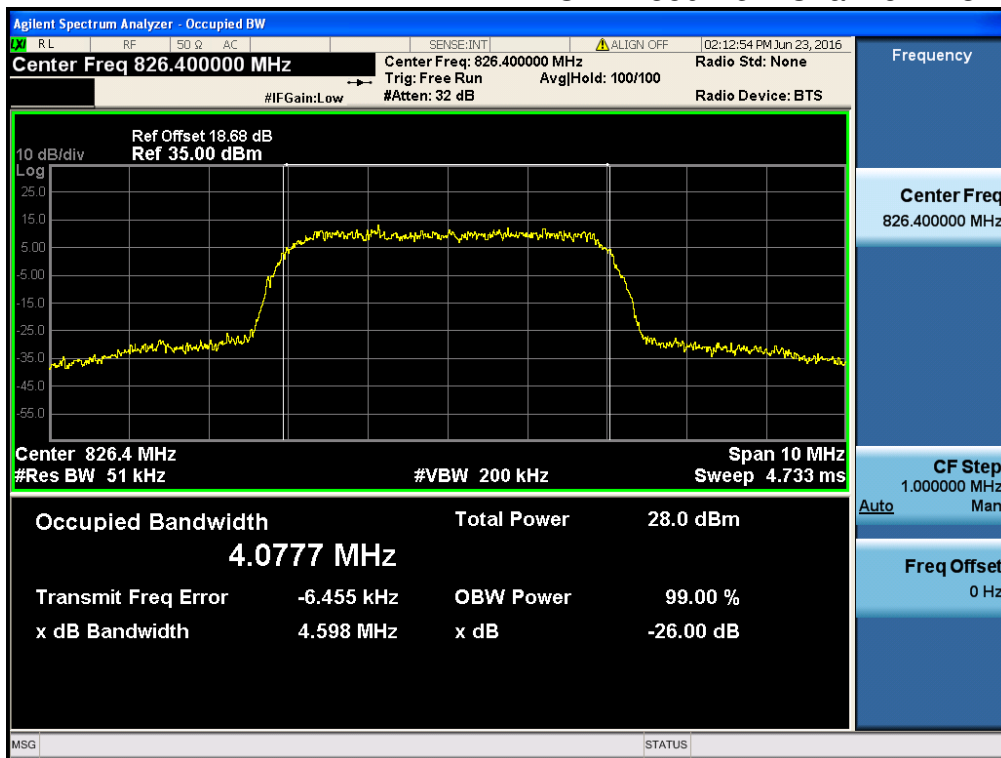

WCDMA850 & Channel: 4183

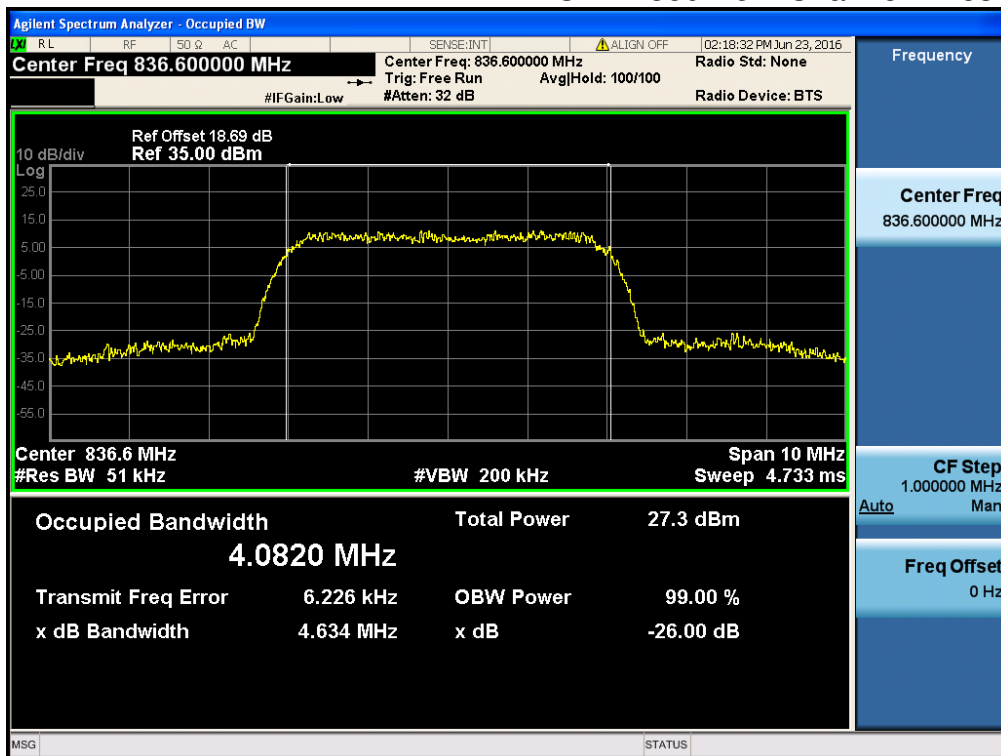

WCDMA850 & Channel: 4233

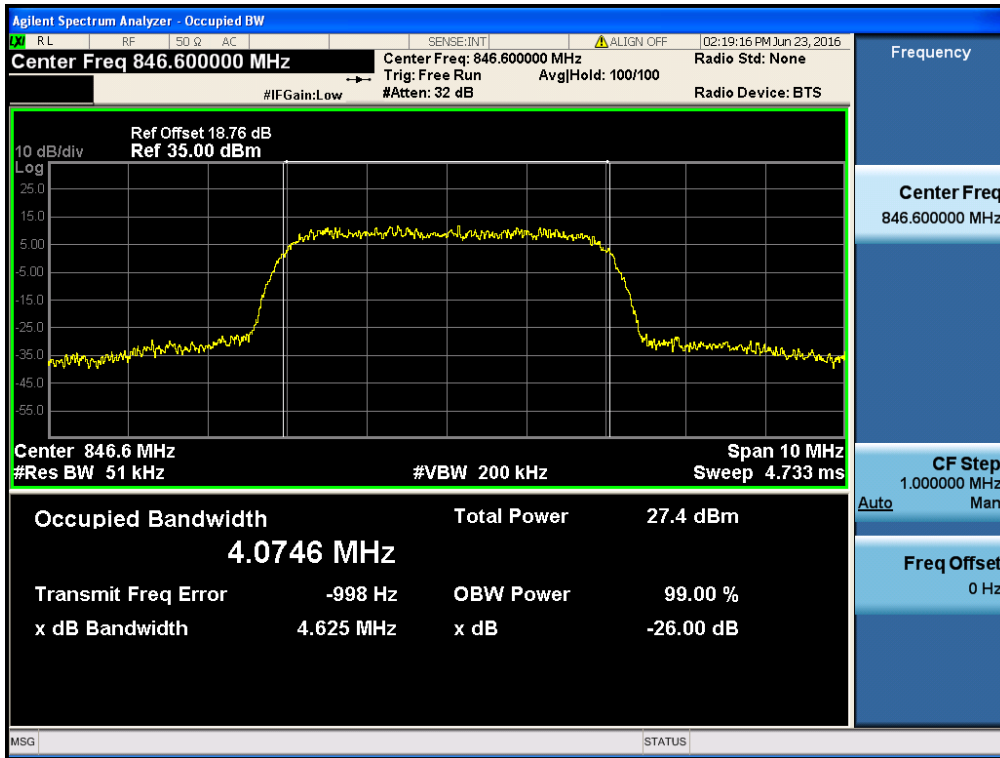

HSUPA850 & Channel: 4132

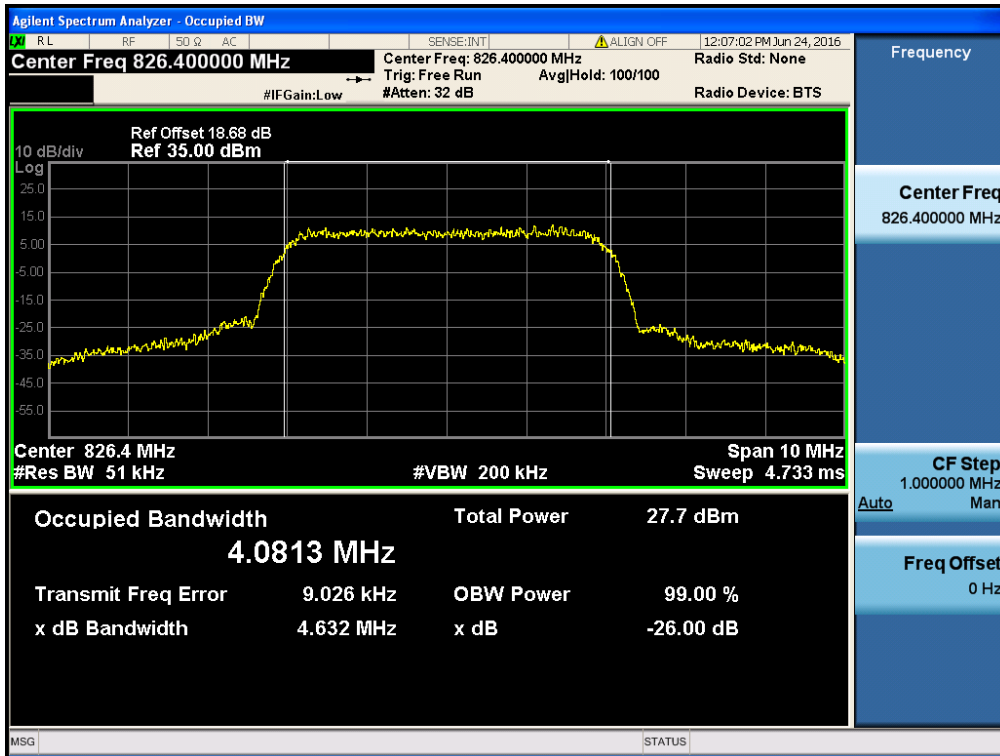

HSUPA850 & Channel: 4183

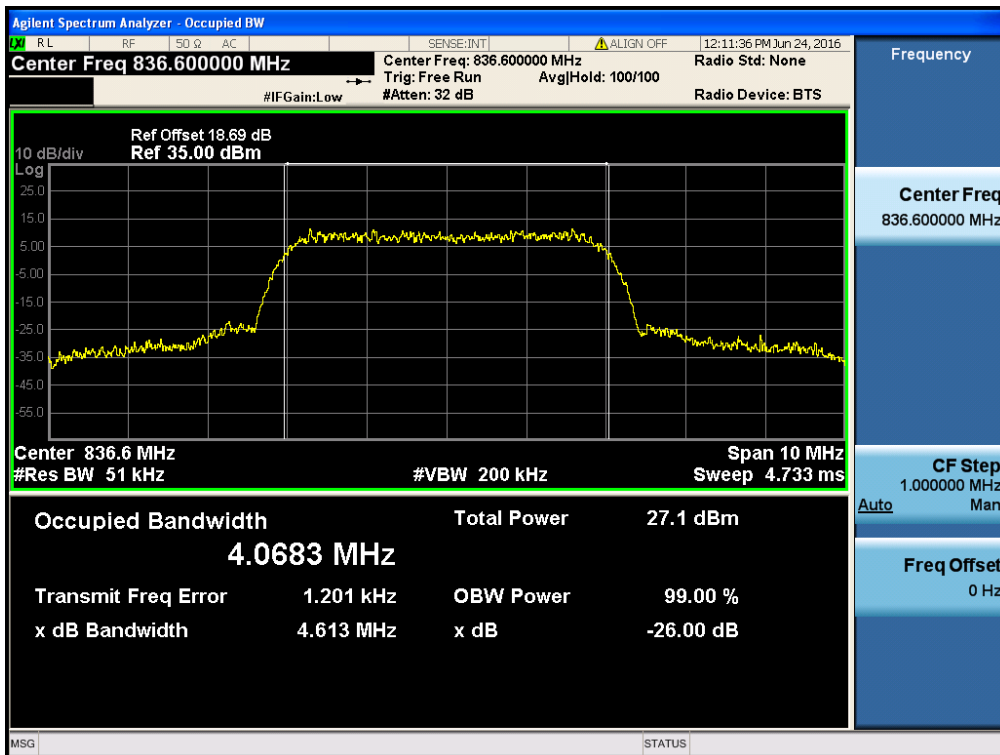



HSUPA850 & Channel: 4233

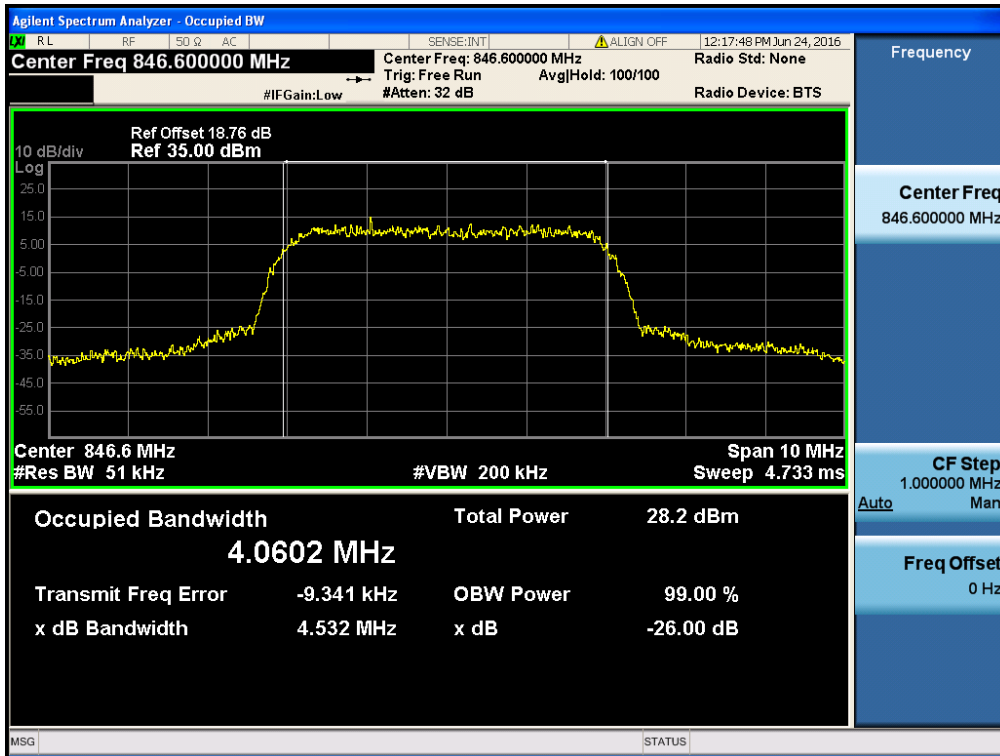

WCDMA1900 & Channel: 9262

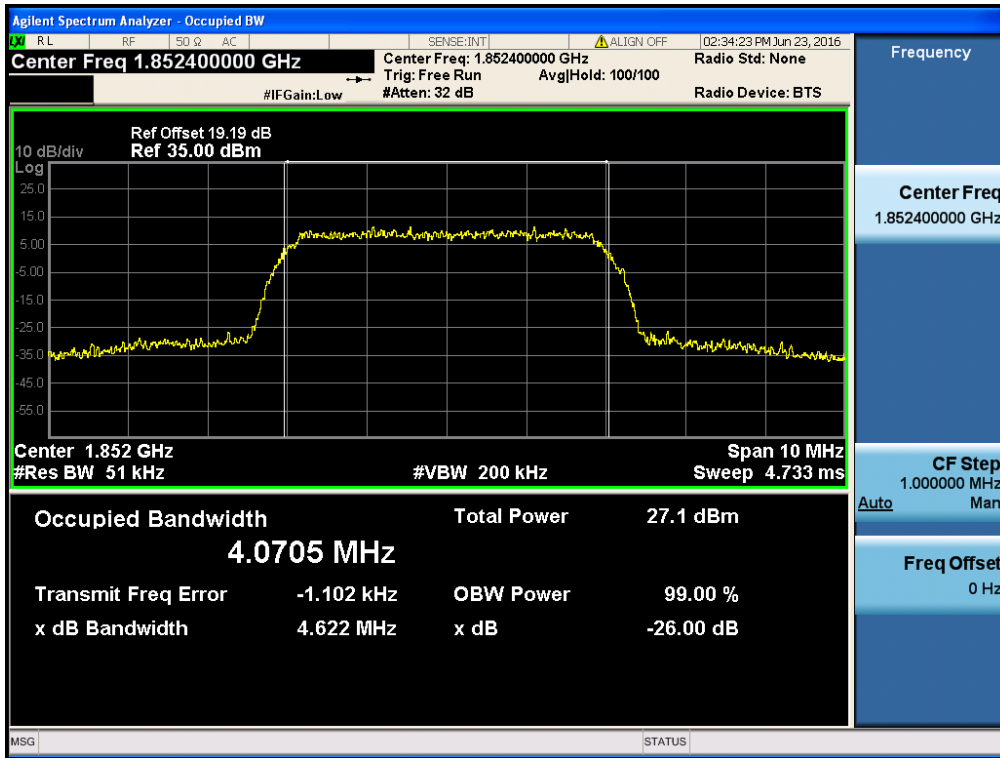

WCDMA1900 & Channel: 9400

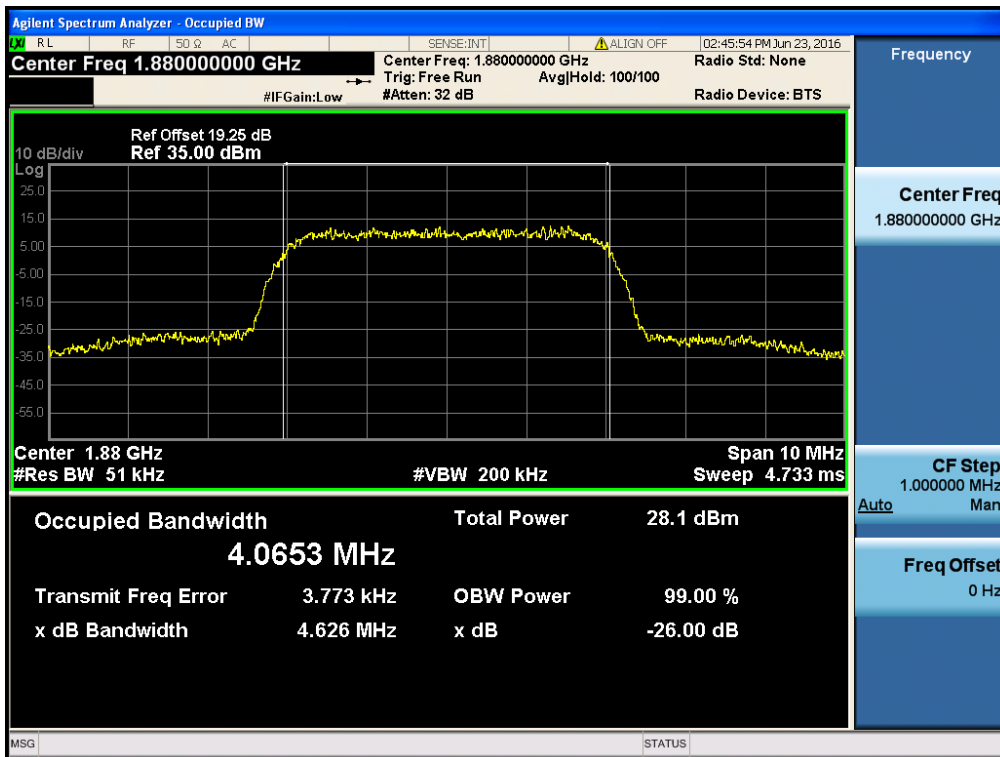

WCDMA1900 & Channel: 9538

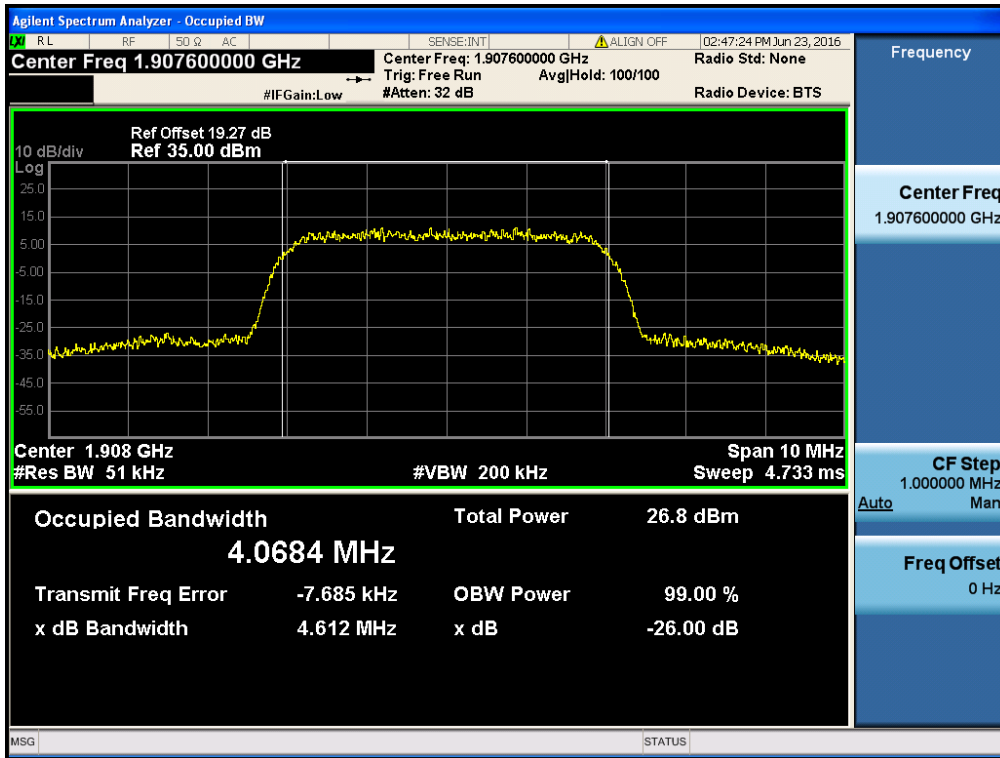

HSUPA1900 & Channel: 9262

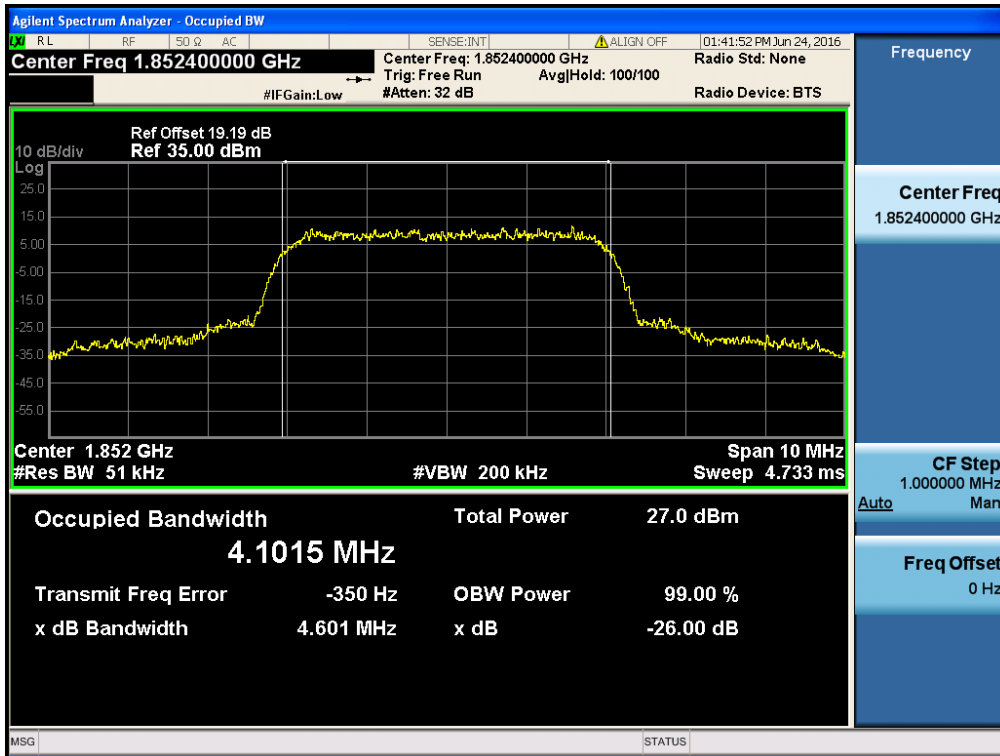

HSUPA1900 & Channel: 9400

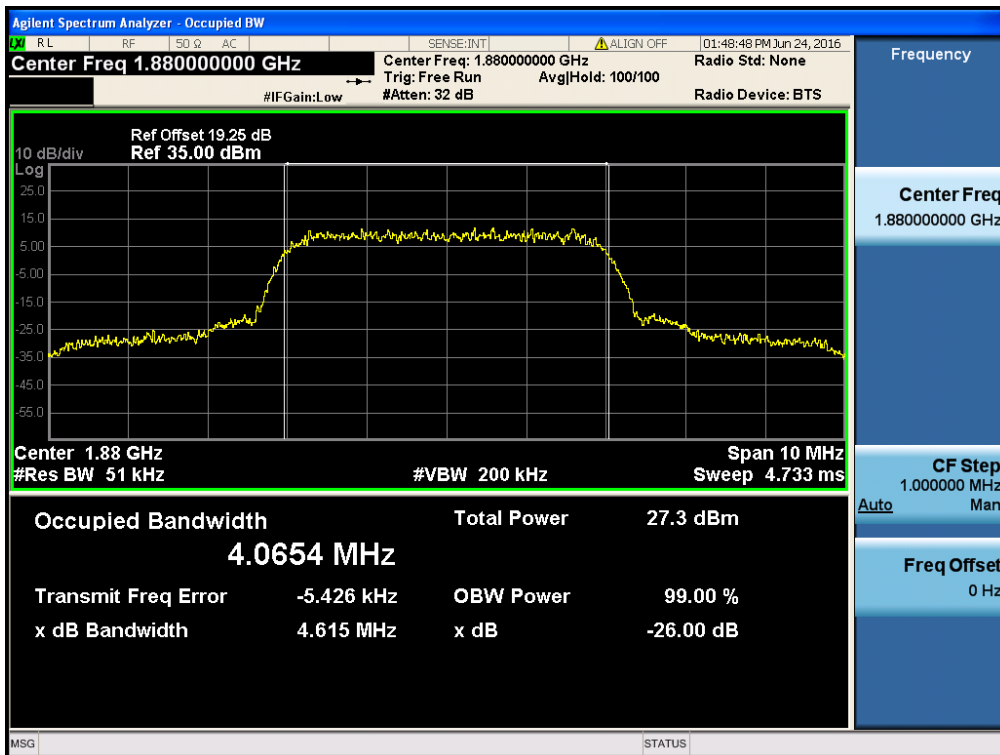

HSUPA1900 & Channel: 9538

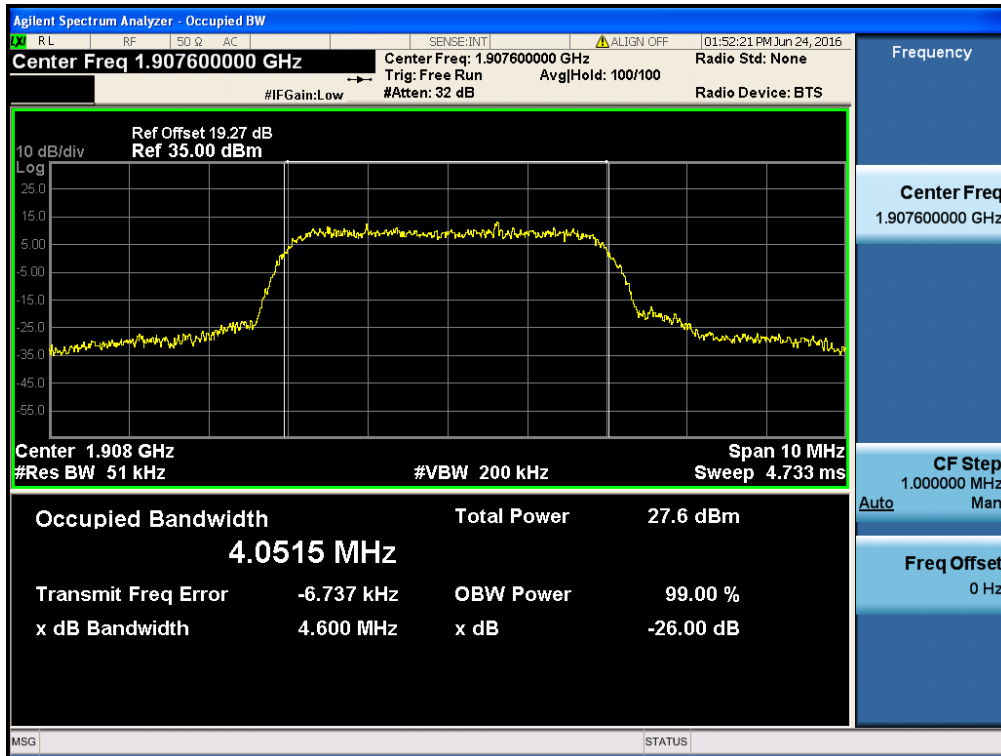

### 8.3 Spurious Emissions at Antenna Terminal

WCDMA850 & Channel: 4132

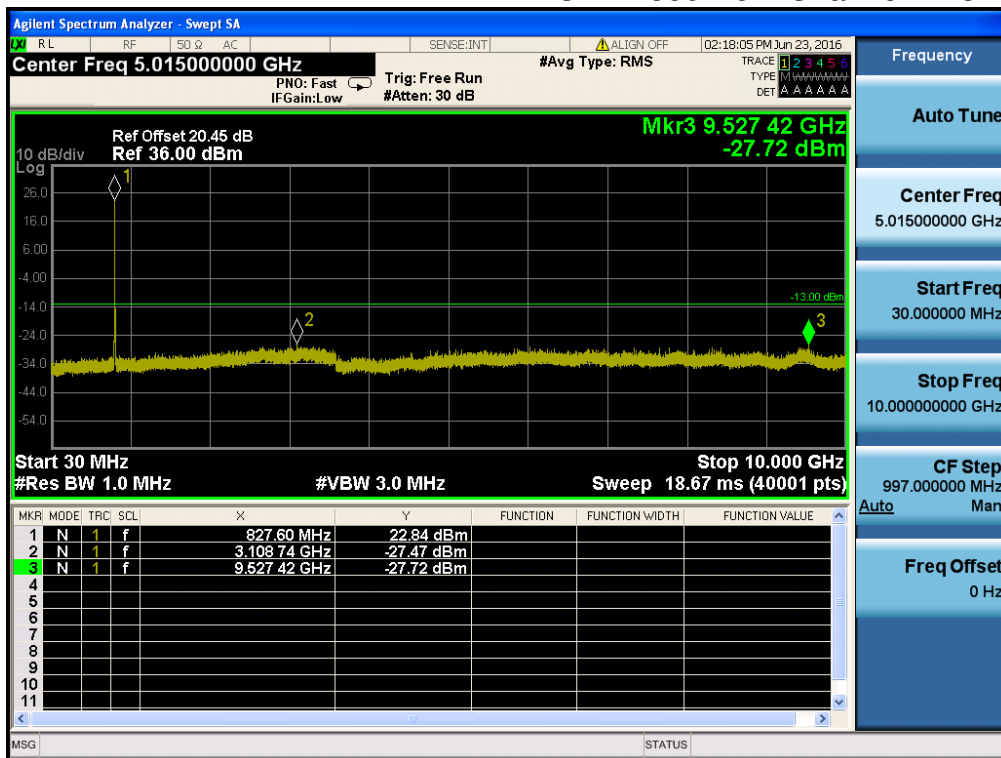

WCDMA850 & Channel: 4183

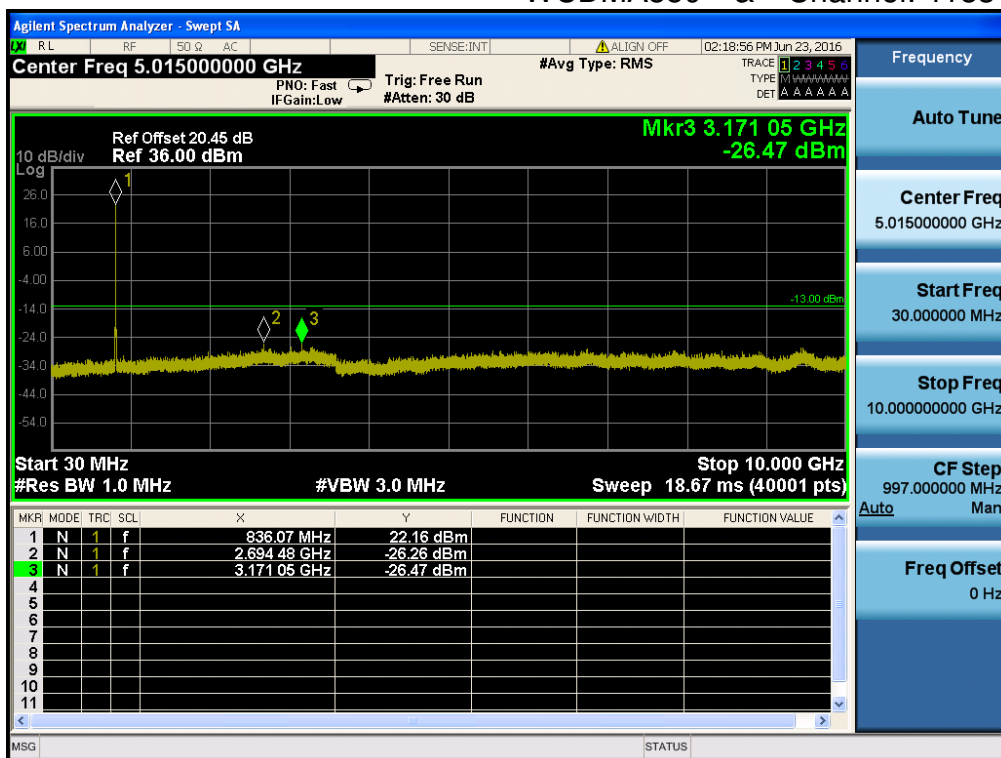

WCDMA850 & Channel: 4233

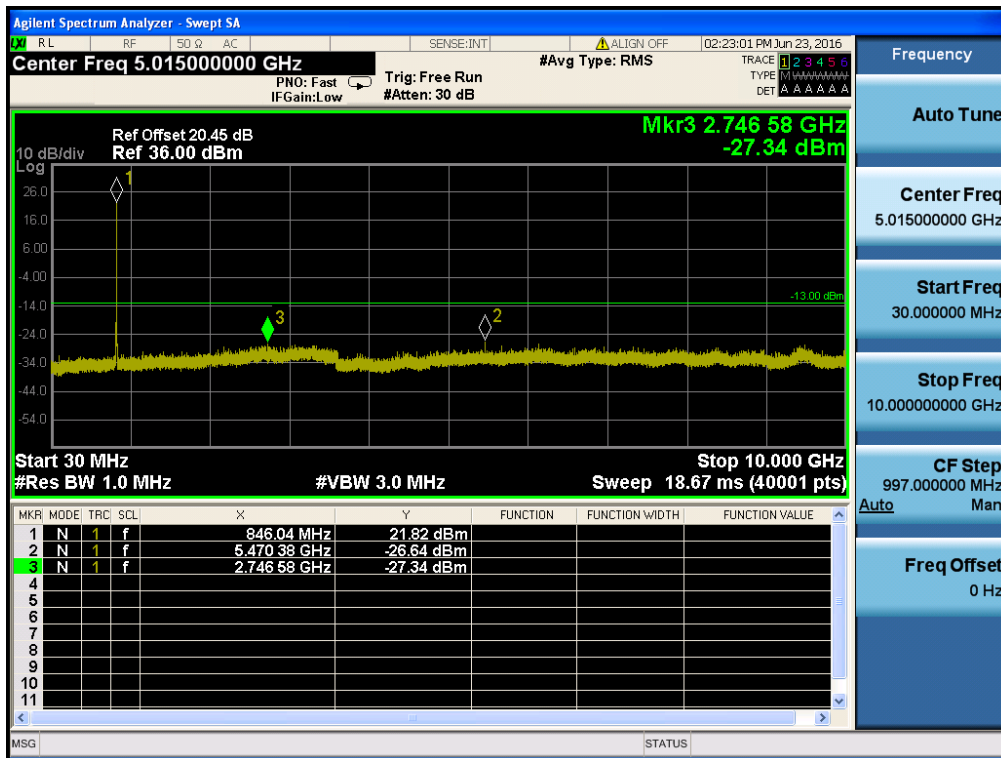

HSUPA850 & Channel: 4132

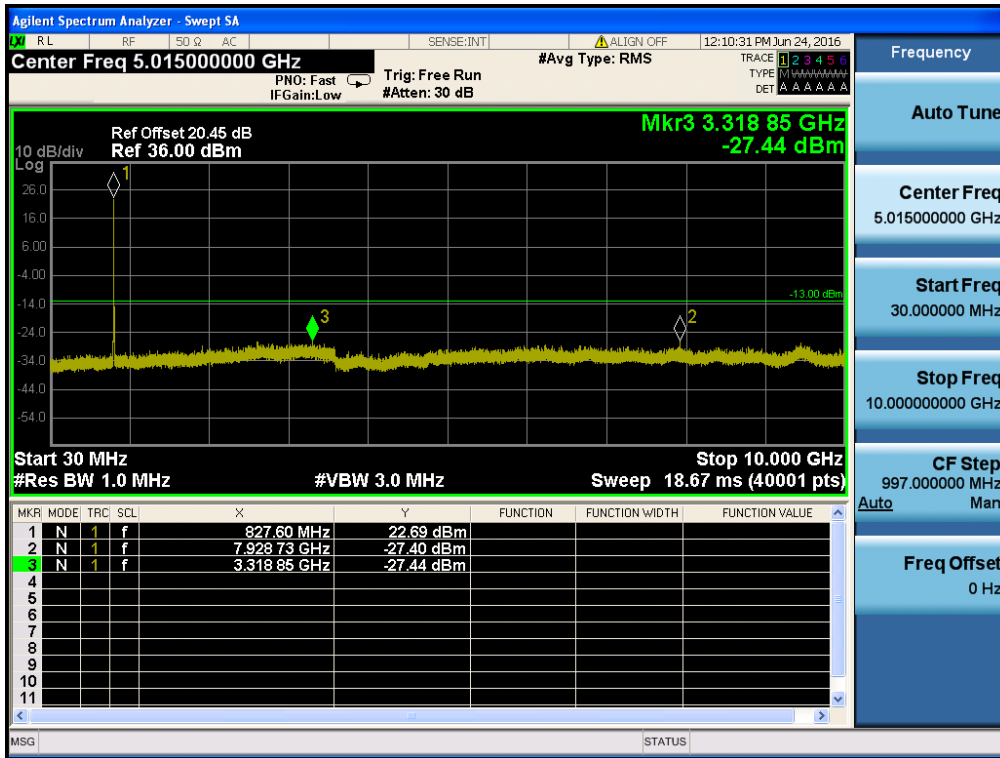

HSUPA850 & Channel: 4183

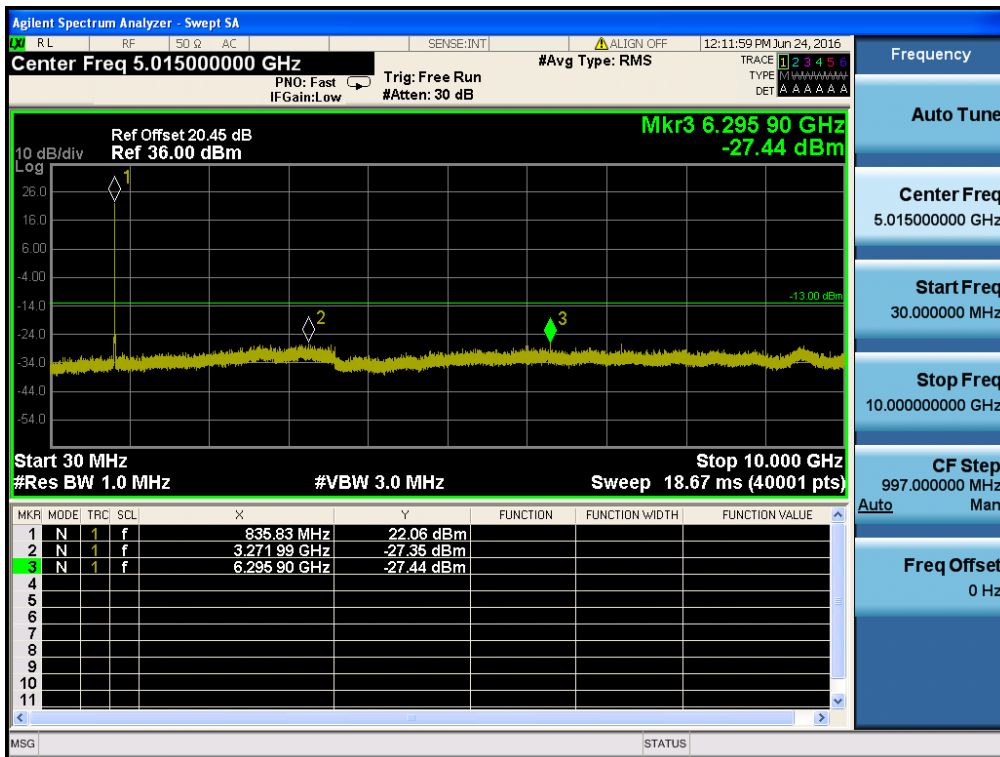



HSUPA850 & Channel: 4233

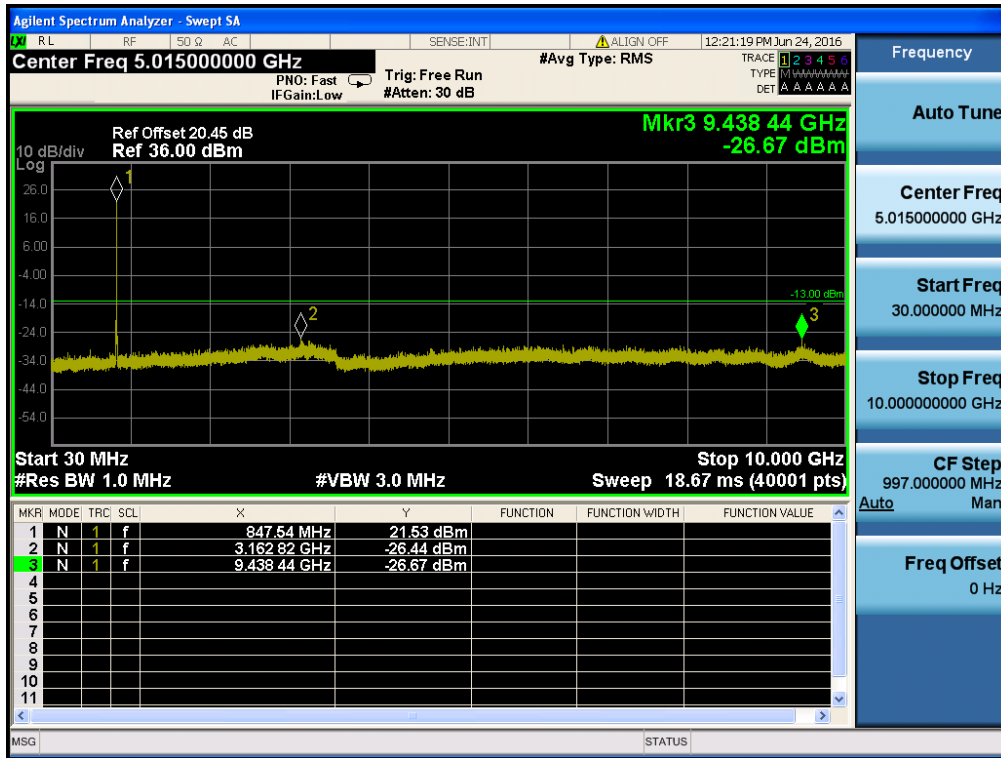

WCDMA1900 & Channel: 9262

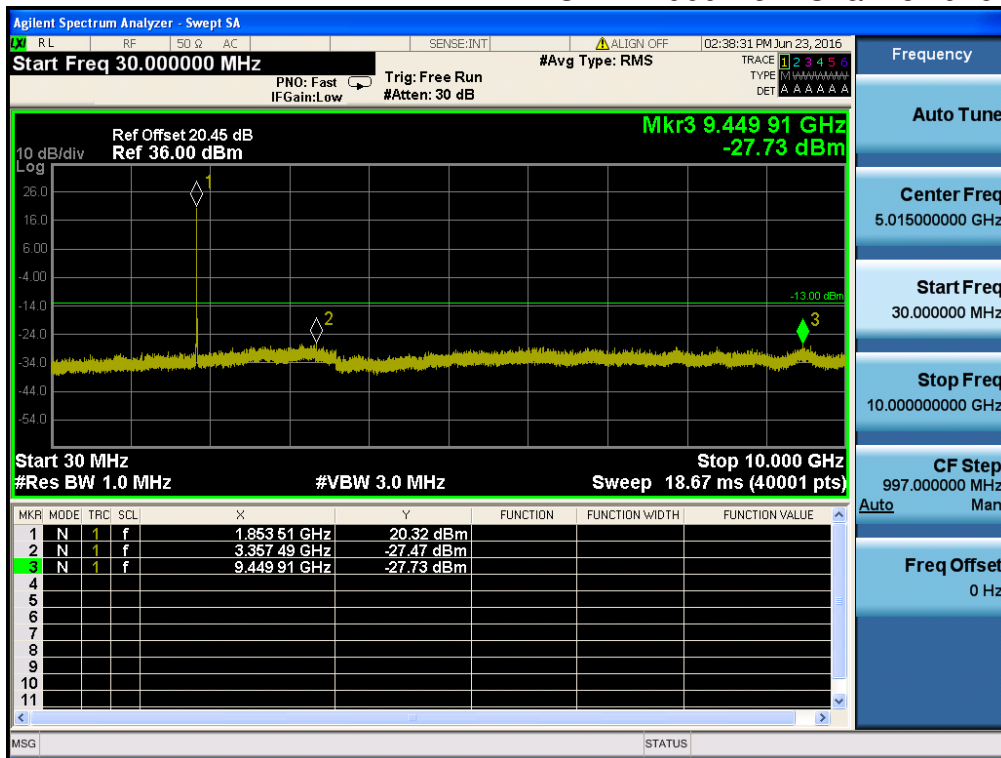

WCDMA1900 & Channel: 9262

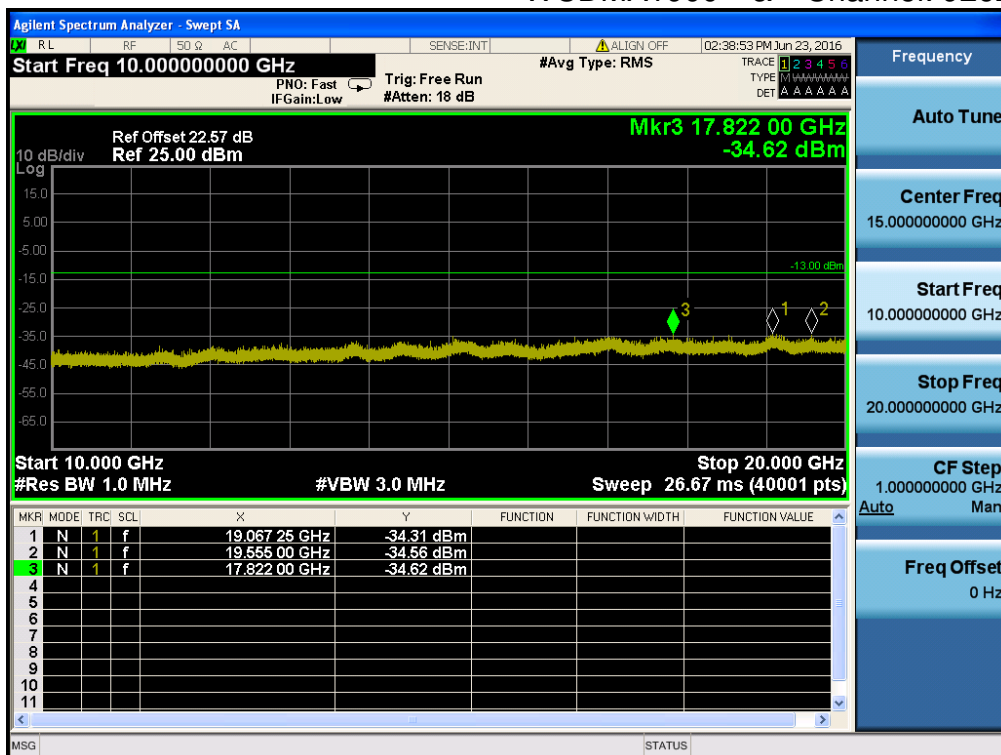

WCDMA1900 & Channel: 9400

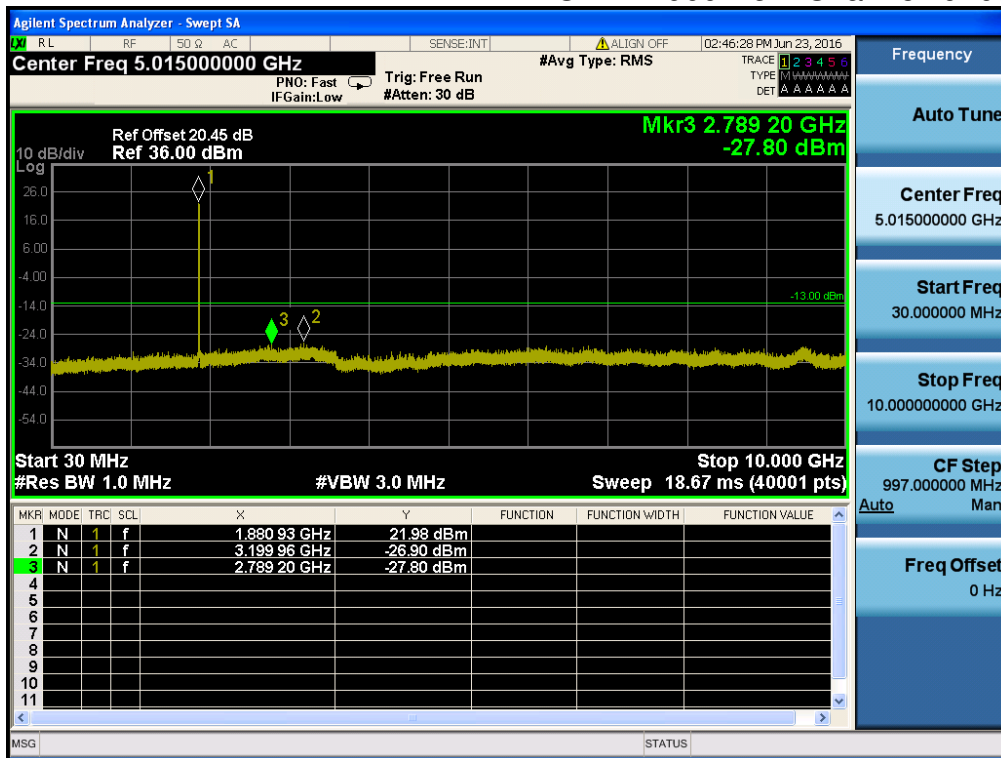

WCDMA1900 & Channel: 9400

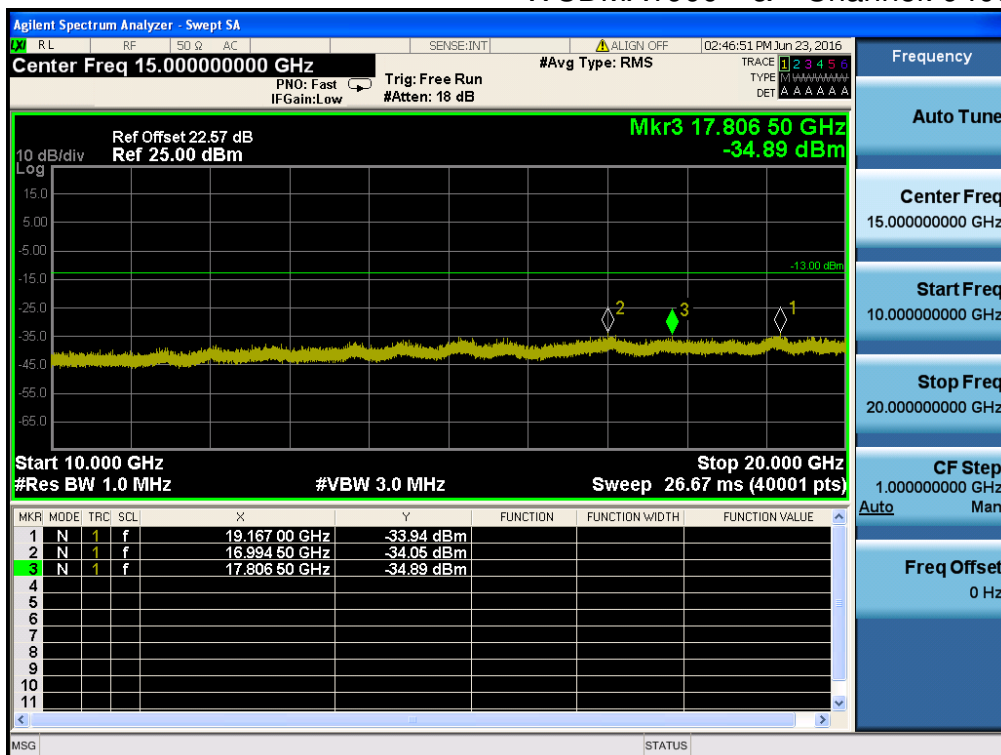

WCDMA1900 & Channel: 9538

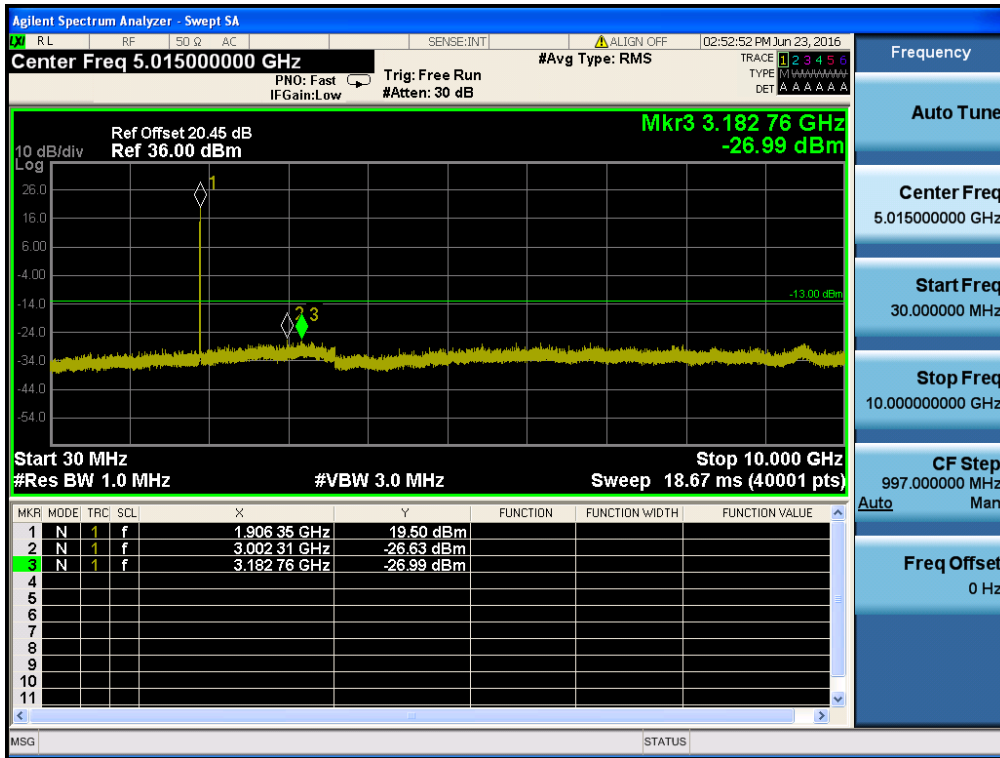

WCDMA1900 & Channel: 9538

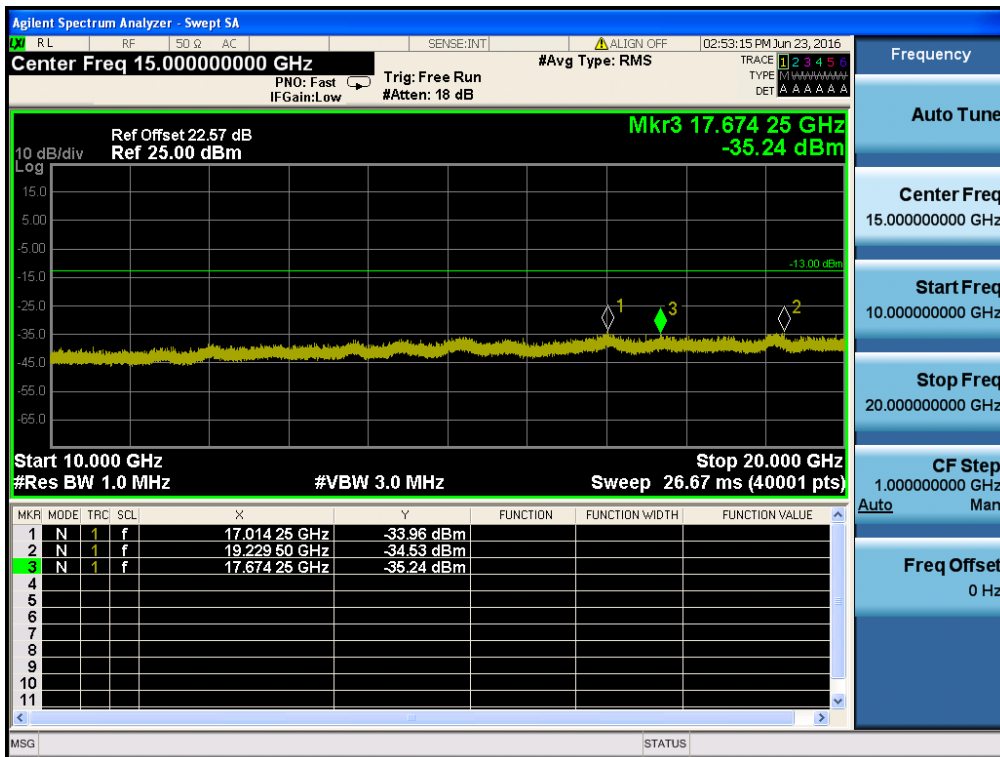

HSUPA1900 & Channel: 9262

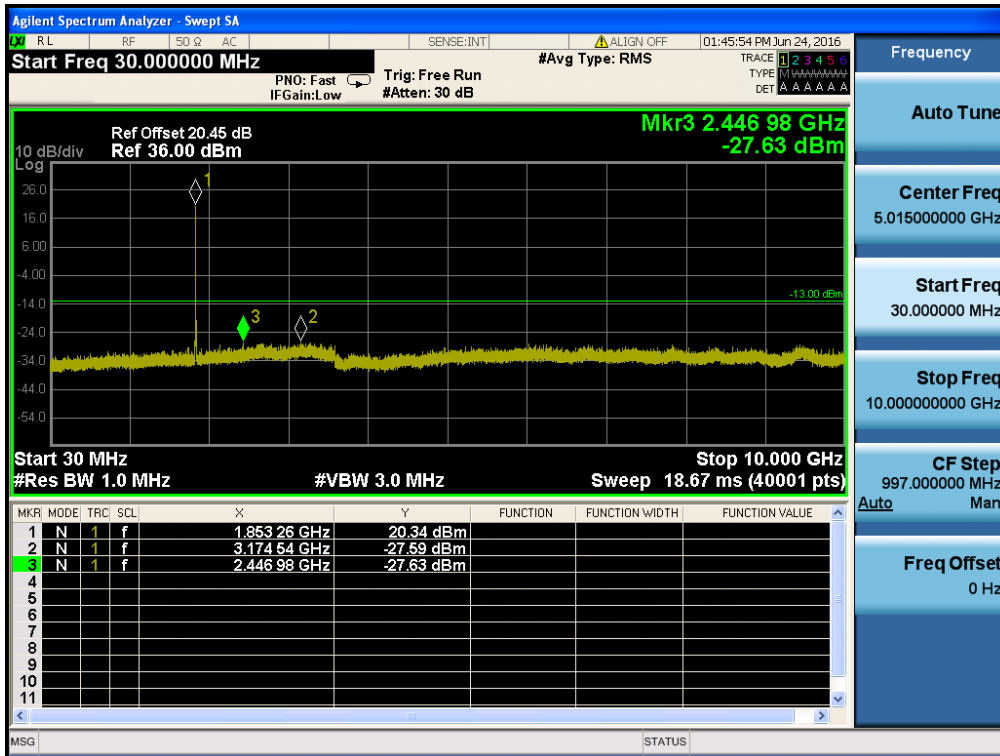

HSUPA 1900 & Channel: 9262

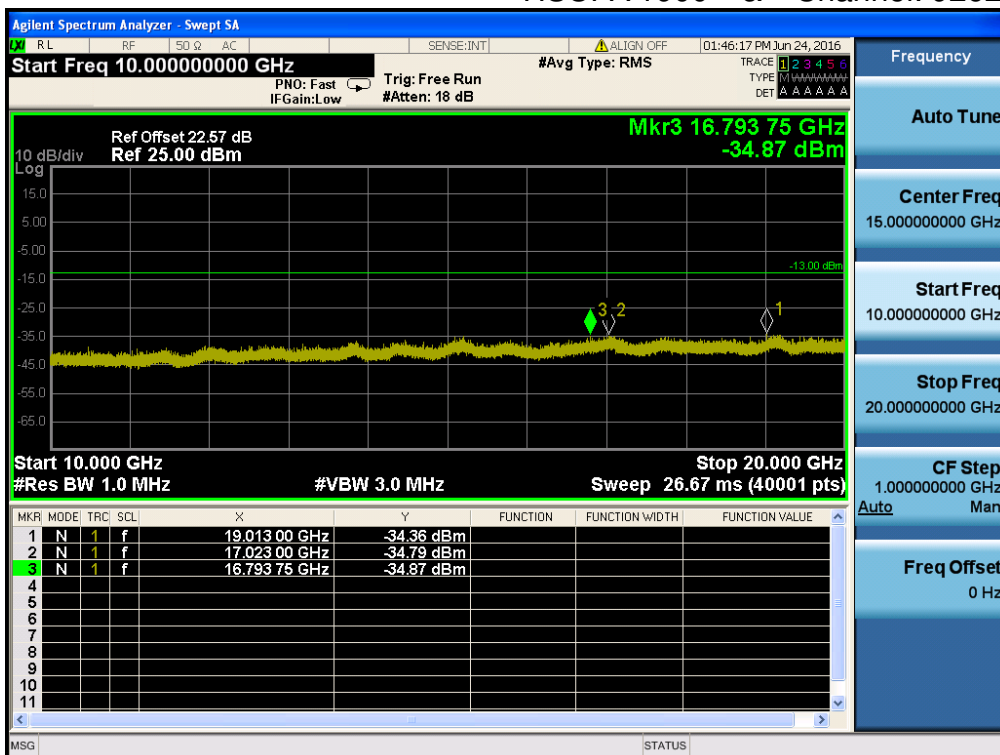

### HSUPA1900 & Channel: 9400

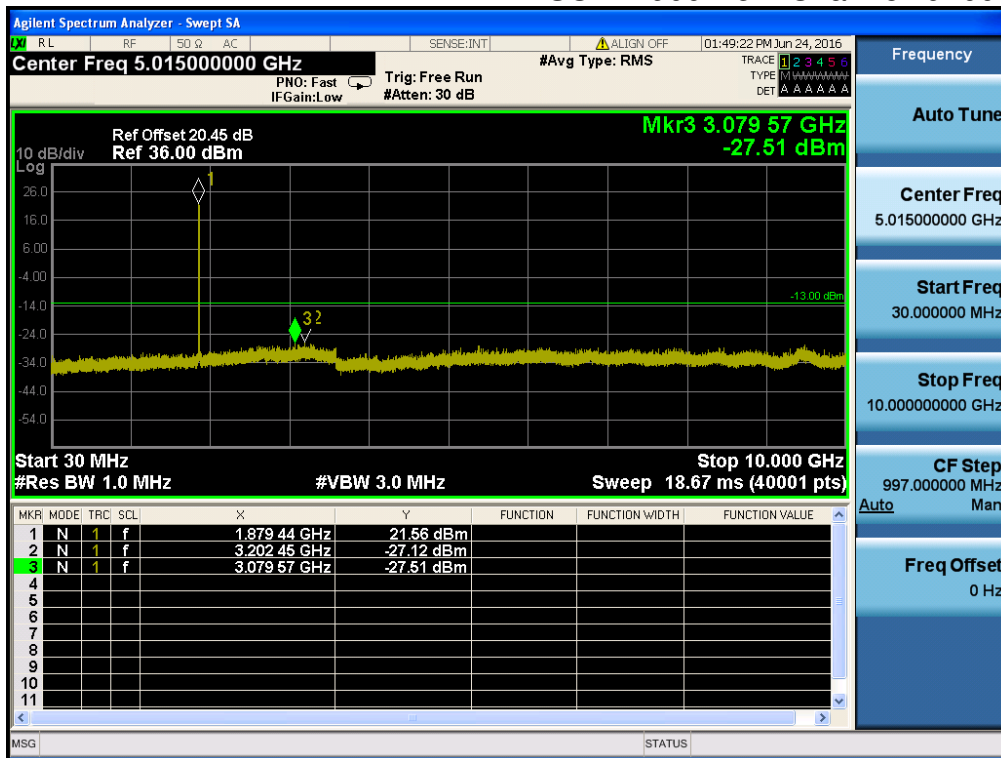

### HSUPA1900 & Channel: 9400

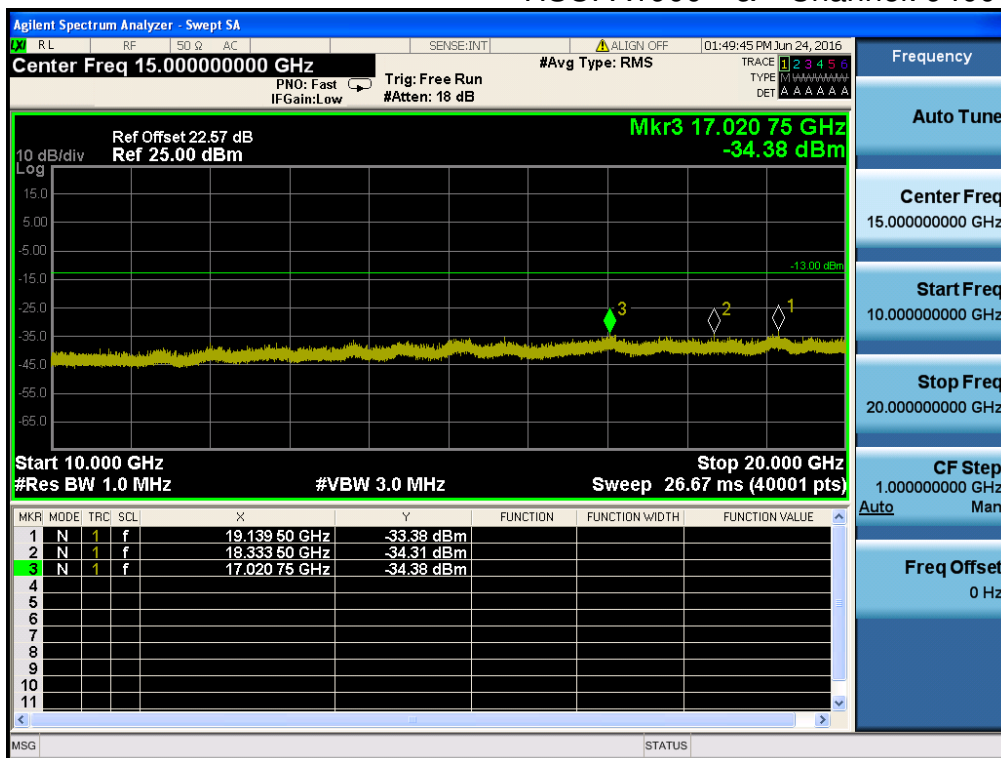

HSUPA1900 & Channel: 9538

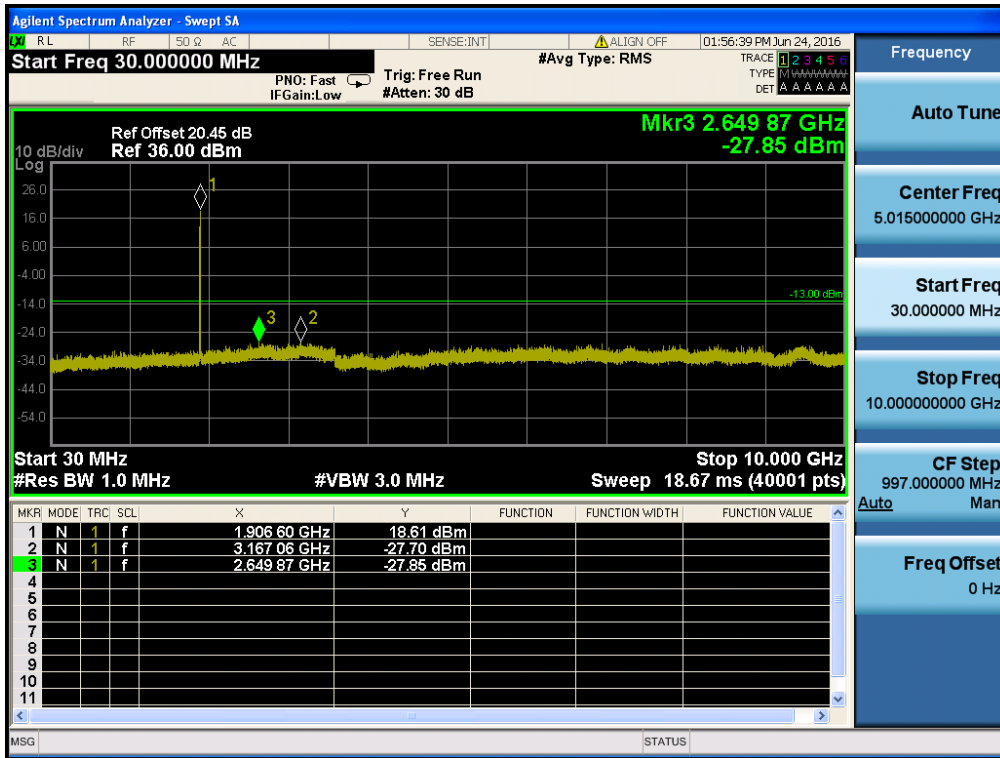

HSUPA1900 & Channel: 9538

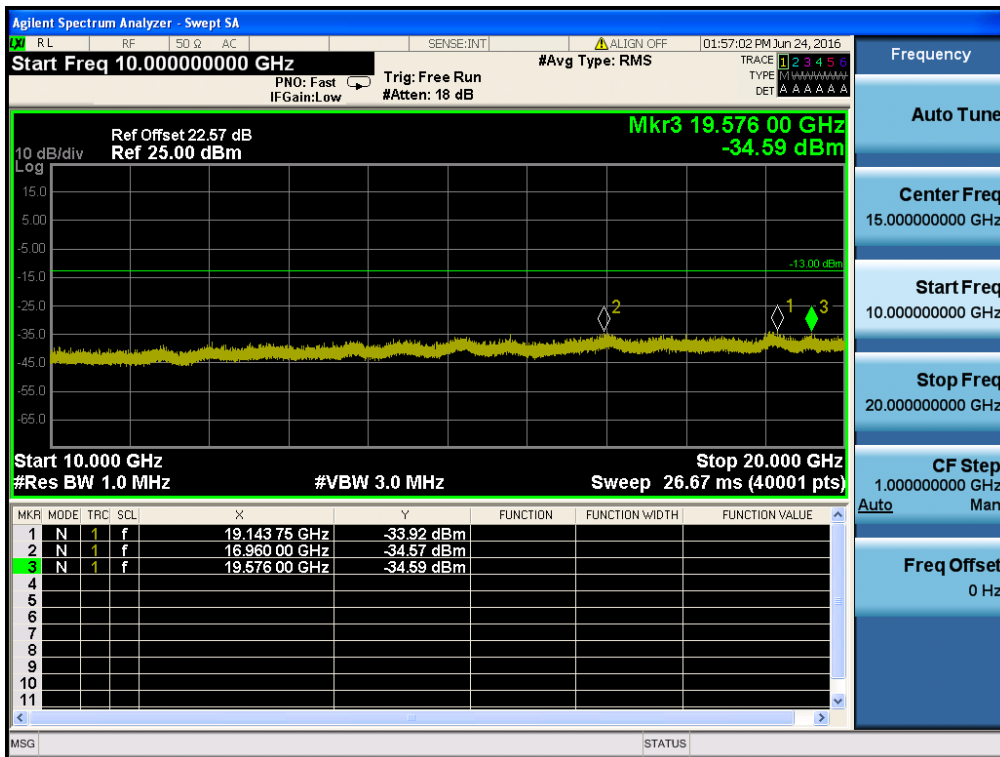

### 8.4 Band Edge

#### WCDMA 850 & Channel: 4132

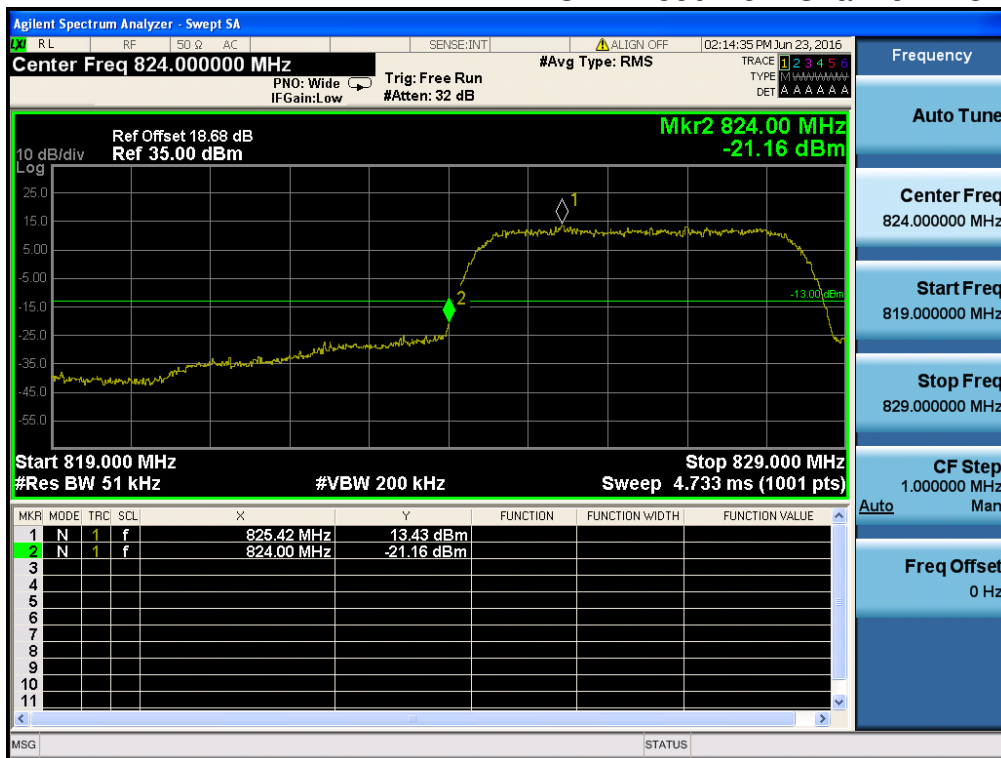

#### WCDMA 850 & Channel: 4132

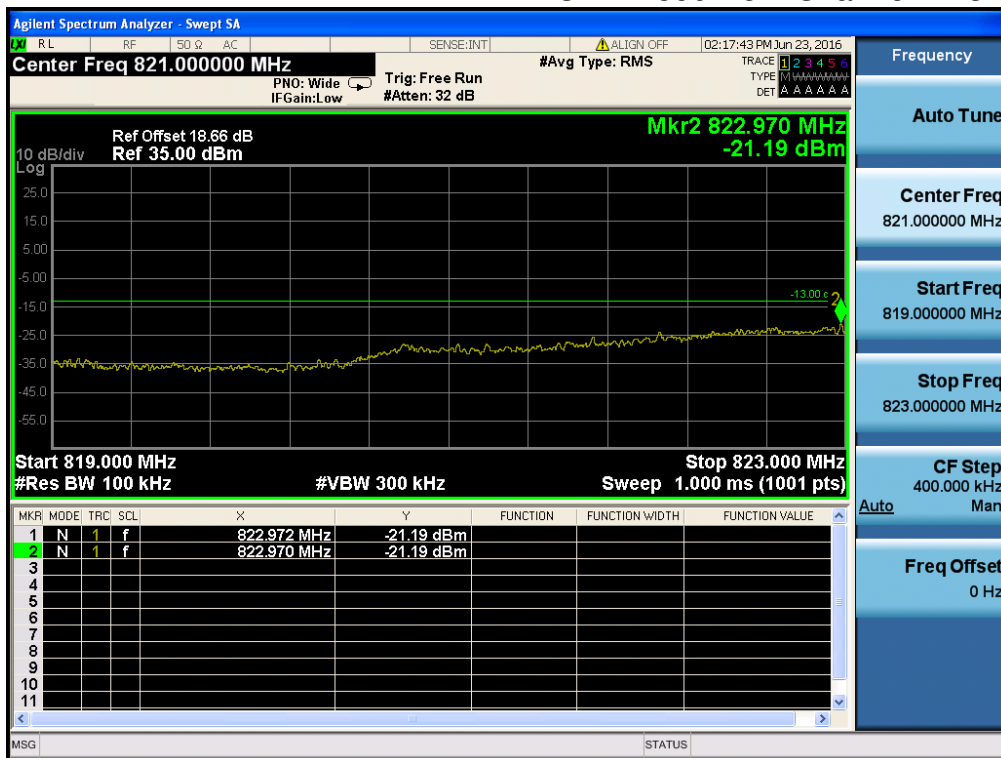



WCDMA 850 & Channel: 4233

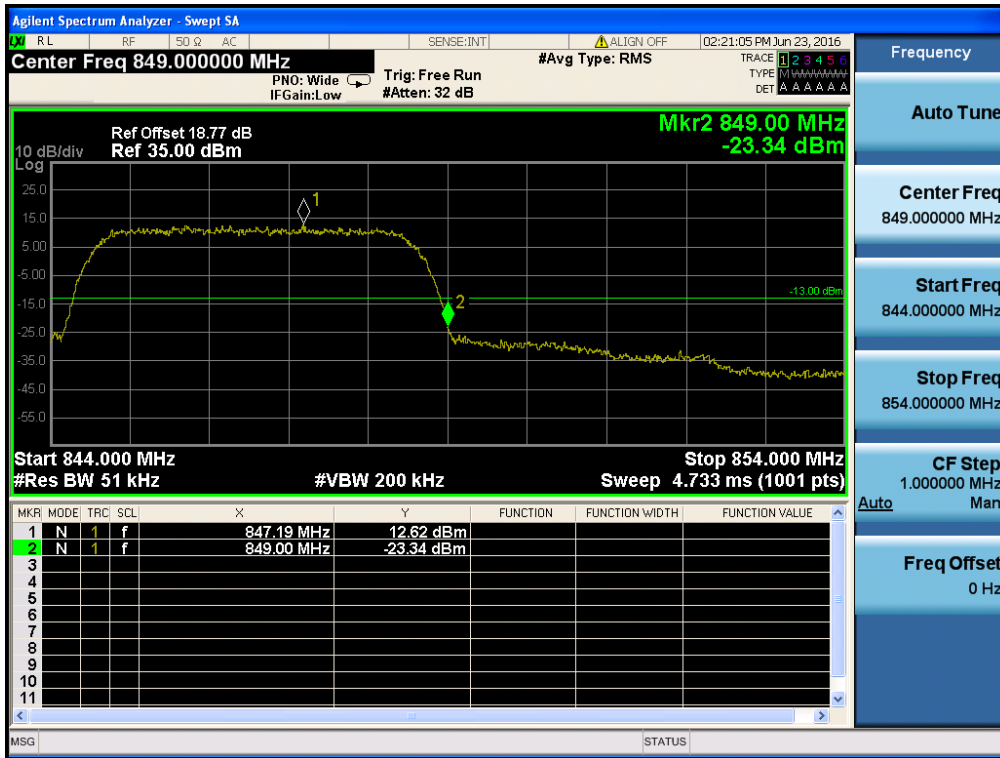

WCDMA 850 & Channel: 4233

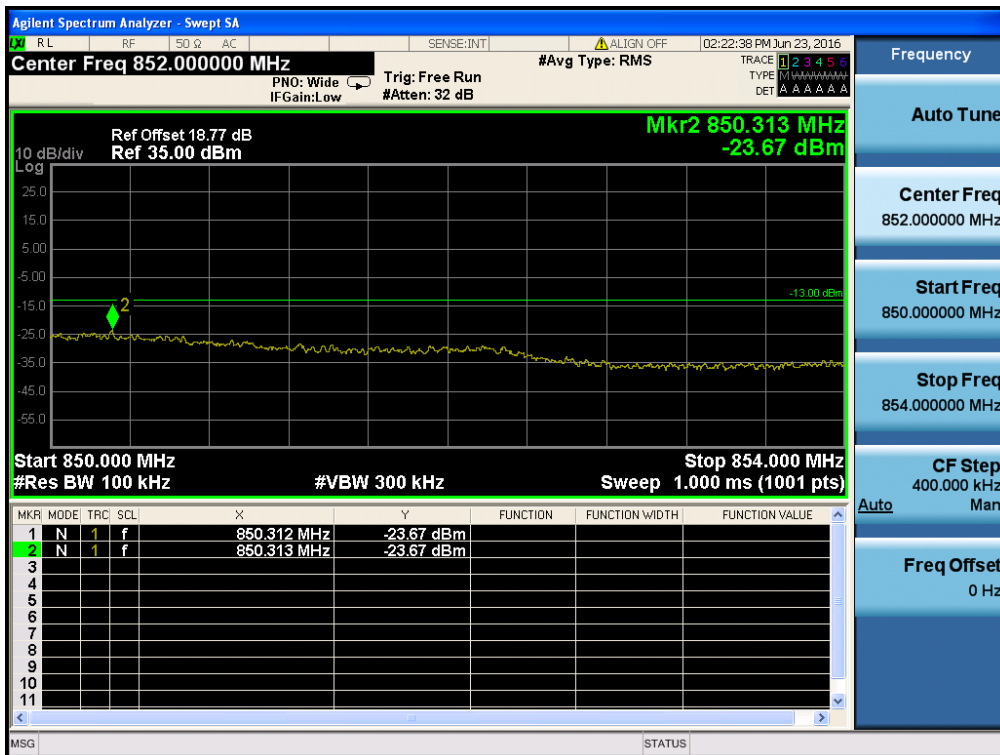

HSUPA 850 & Channel: 4132

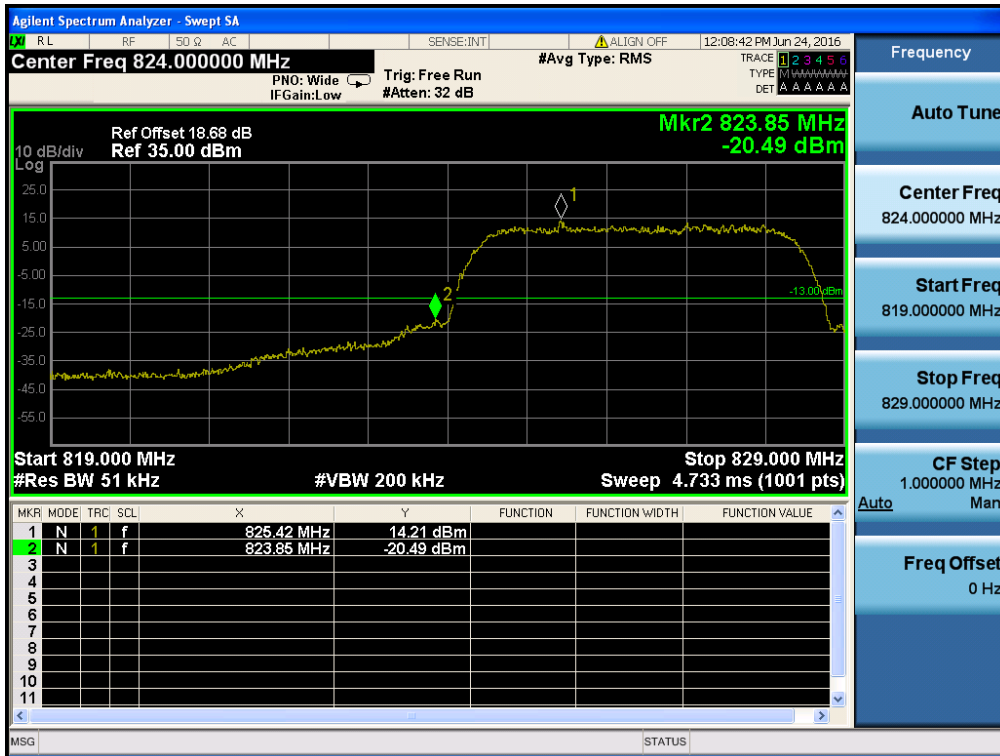

HSUPA 850 & Channel: 4132

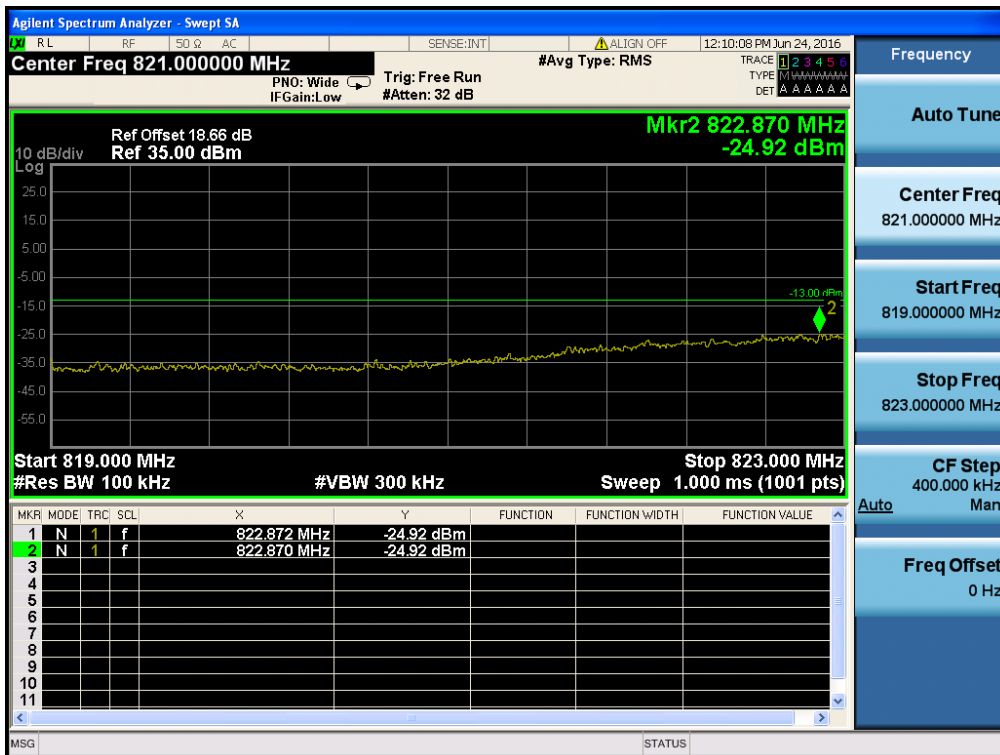

HSUPA850 & Channel: 4233



HSUPA850 & Channel: 4233

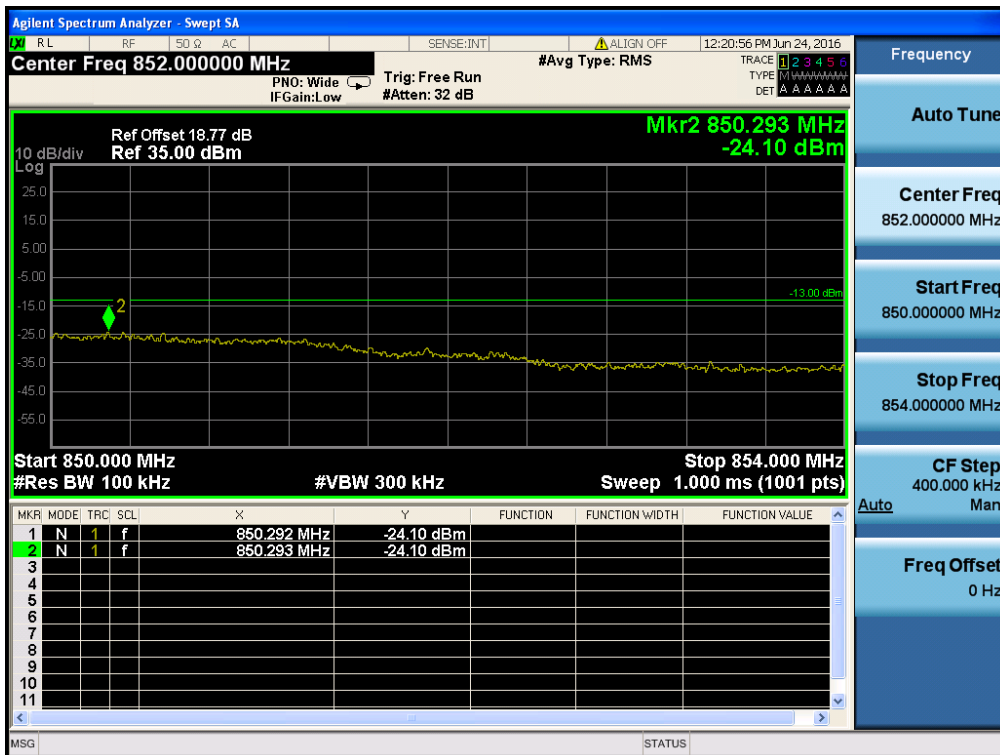

WCDMA1900 & Channel: 9262

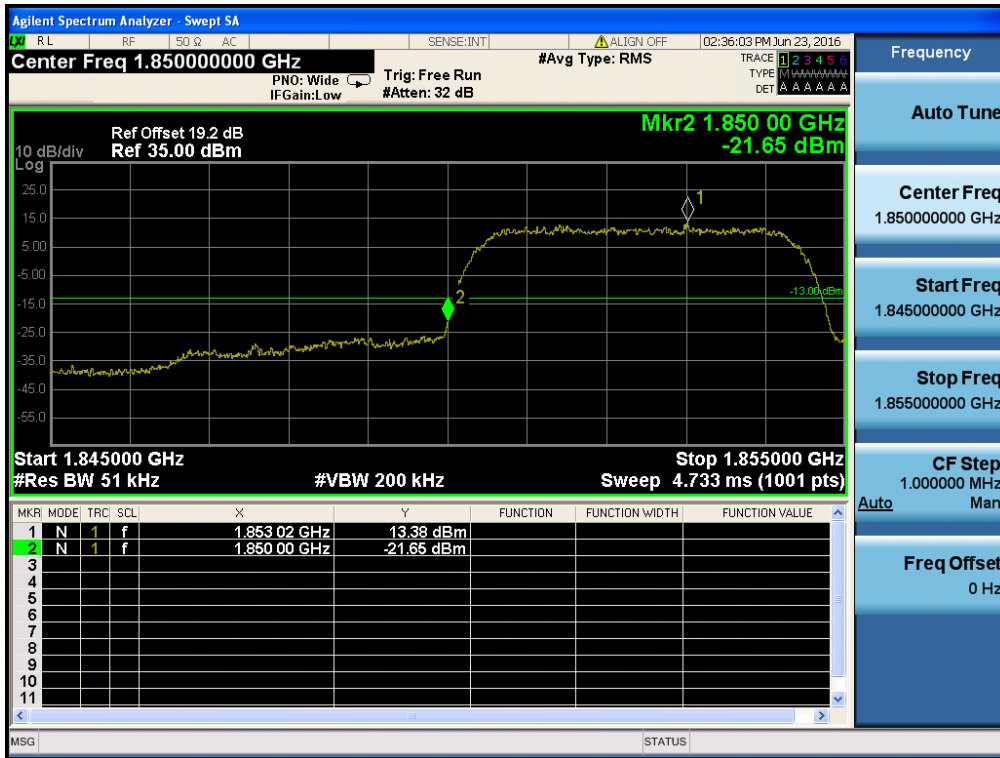

WCDMA1900 & Channel: 9262

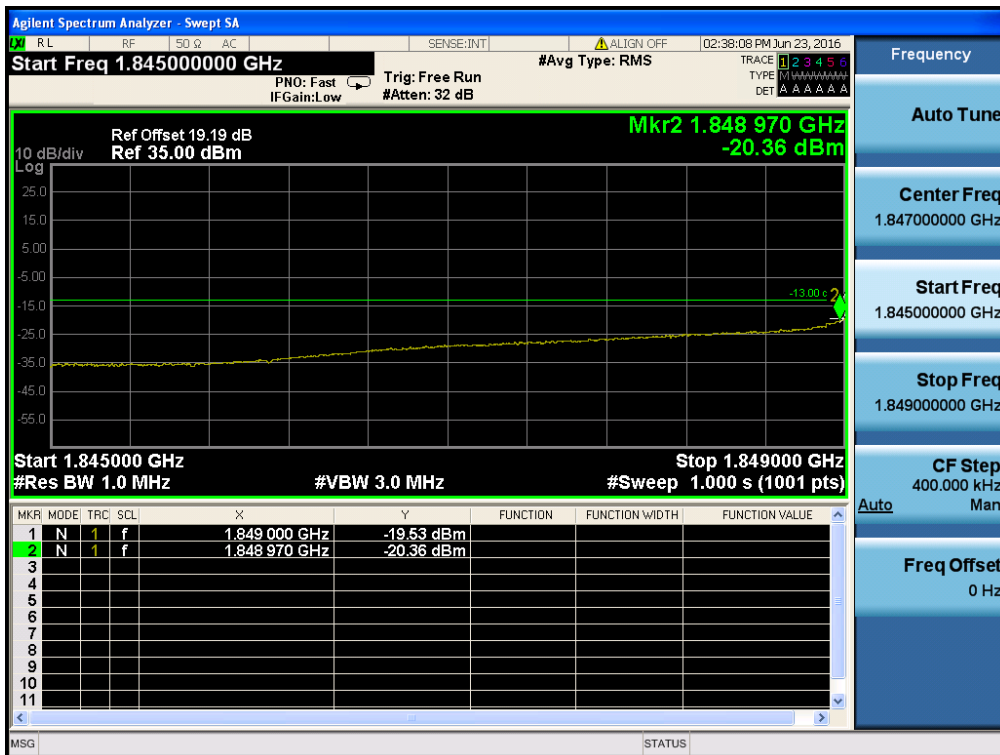

WCDMA1900 & Channel: 9538



WCDMA1900 & Channel: 9538

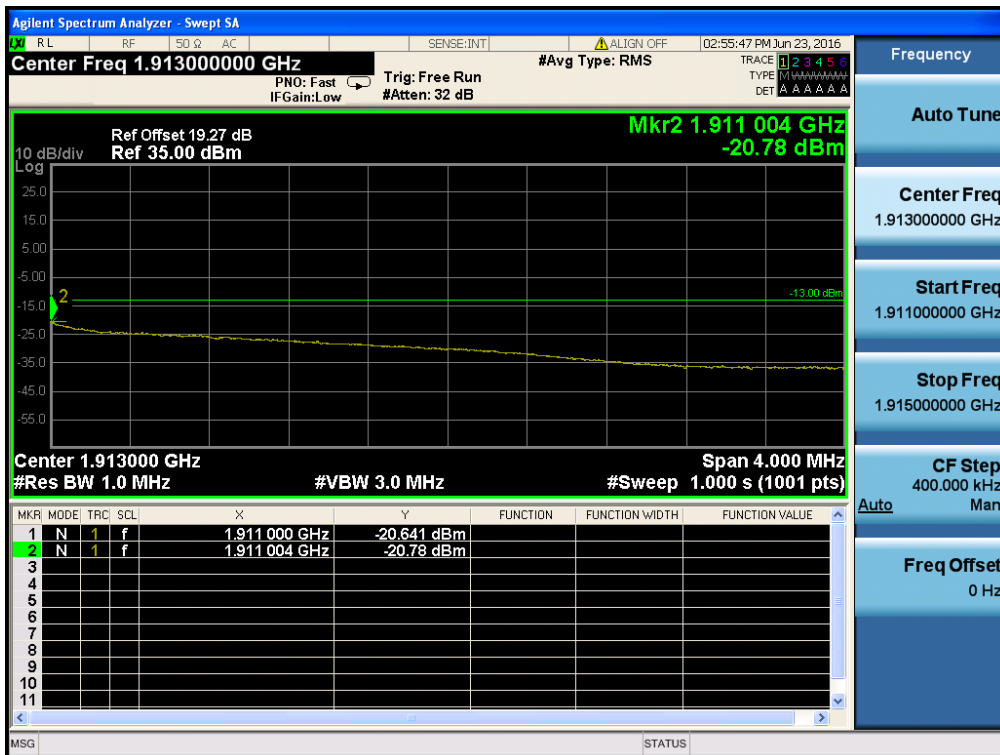

HSUPA1900 & Channel: 9262

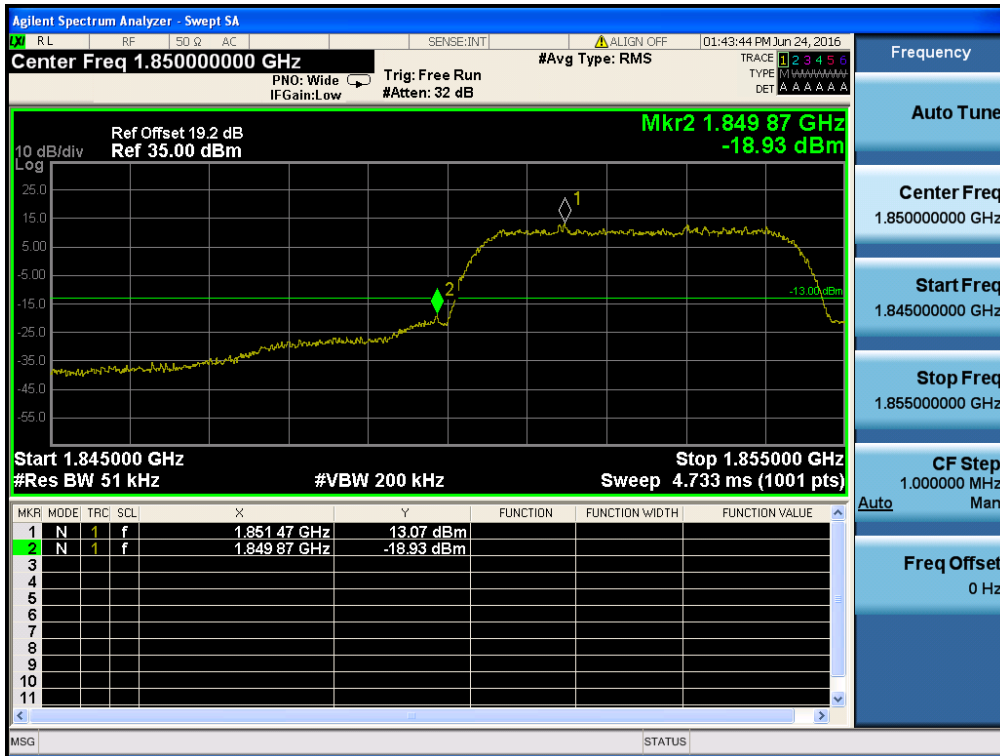

HSUPA1900 & Channel: 9262

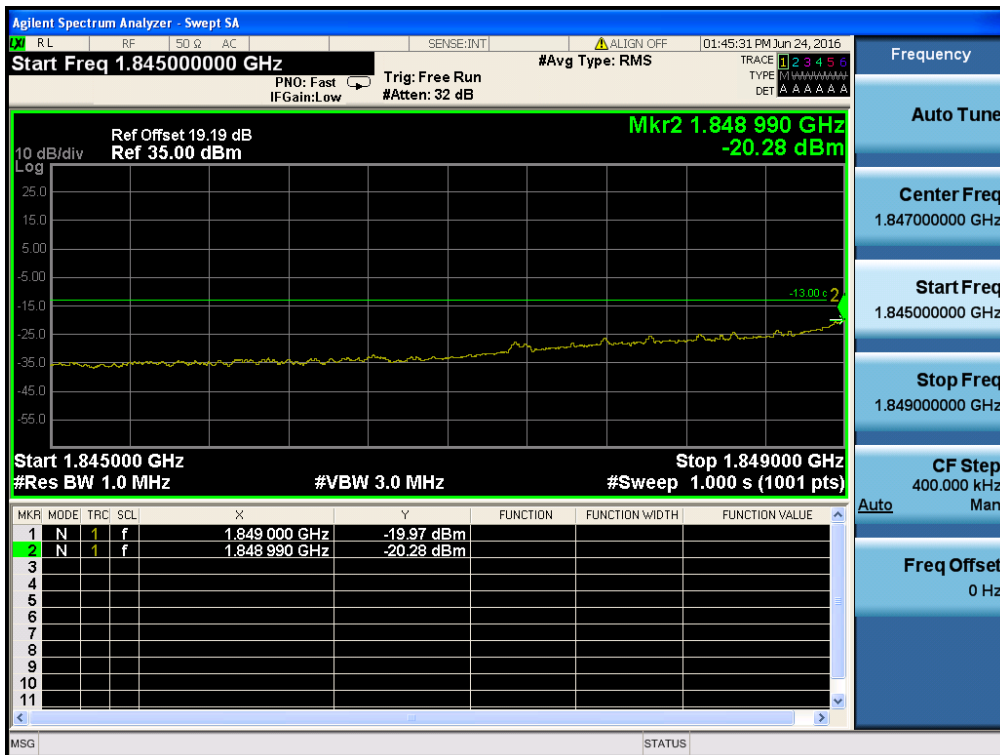

HSUPA1900 & Channel: 9538



HSUPA1900 & Channel: 9538

