

TEST REPORT

<p>DT&C Co., Ltd. 42, Yurim-ro, 154Beon-gil, Cheoin-gu, Yongin-si, Gyeonggi-do, Korea Tel : 031-321-2664, Fax : 031-321-1664</p>	<p>Report No : DRTFCC1606-0086 Pages:(1) / (37) page</p>	
<p>1. Customer</p> <ul style="list-style-type: none">Name : Suntech International Ltd.Address : B-1506, Greatvally, 32, 9-Gil, Digital-Ro, Geumcheon-Gu, Seoul 153-709 <p>2. Use of Report : FCC Original Grant</p> <p>3. Product Name (FCCID) : Tracker (WA2-ST500)</p> <p>4. Date of Test : 2016-05-31 ~ 2016-06-17</p> <p>5. Test Method Used: FCC Part 22, 24</p> <p>6. Testing Environment : See appended test report</p> <p>7. Test Result : <input checked="" type="checkbox"/> Pass <input type="checkbox"/> Fail</p> <p>The results shown in this test report refer only to the sample(s) tested unless otherwise stated. This Test Report cannot be reproduced, except in full.</p>		
Affirmation	Tested by Name : Jaejin Lee (Signature)	Technical Manager Name : GeunKi Son (Signature)
<p style="text-align: center;">2016 . 06 . 24 .</p> <p style="text-align: center;">DT&C Co., Ltd.</p>		

* If this test report is required to confirmation of authenticity, please contact to report@dtnc.net

Test Report Version

Test Report No.	Date	Description
DRTFCC1606-0086	Jun. 24, 2016	Initial issue

Table of Contents

1. GENERAL INFORMATION	4
2. INTRODUCTION	5
2.1. EUT DESCRIPTION	5
2.2. Support equipment.....	5
2.3. MEASURING INSTRUMENT CALIBRATION.....	5
2.4. TEST FACILITY	5
3. DESCRIPTION OF TESTS	6
3.1 ERP & EIRP	6
3.2 PEAK TO AVERAGE RATIO	8
3.3 OCCUPIED BANDWIDTH.....	10
3.4 BAND EDGE EMISSIONS AT ANTENNA TERMINAL.....	11
3.5 SPURIOUS AND HARMONIC EMISSIONS AT ANTENNA TERMINAL.....	12
3.6 RADIATED SPURIOUS EMISSIONS	13
3.7 FREQUENCY STABILITY / VARIATION OF AMBIENT TEMPERATURE	14
4. LIST OF TEST EQUIPMENT	15
5. SUMMARY OF TEST RESULTS	16
6. SAMPLE CALCULATION	17
7. TEST DATA	18
7.1 Conducted OUTPUT POWER.....	18
7.2 PEAK TO AVERAGE RATIO.....	19
7.3 OCCUPIED BANDWIDTH.....	19
7.4 SPURIOUS AND HARMONIC EMISSIONS AT ANTENNA TERMINAL.....	19
7.5 BAND EDGE	19
7.6 EFFECTIVE RADIATED POWER.....	20
7.7 EQUIVALENT ISOTROPIC RADIATED POWER	20
7.8 RADIATED SPURIOUS EMISSIONS	21
7.8.1 RADIATED SPURIOUS EMISSIONS (GPRS850)	21
7.8.2 RADIATED SPURIOUS EMISSIONS (GPRS1900)	22
7.9 FREQUENCY STABILITY / VARIATION OF AMBIENT TEMPERATURE	23
7.9.1 FREQUENCY STABILITY (GPRS850)	23
7.9.2 FREQUENCY STABILITY (GPRS1900)	24
8. TEST PLOTS	25
8.1 Peak to Average Ratio.....	25
8.2 Occupied Bandwidth (99 % Bandwidth)	27
8.3 Spurious Emissions at Antenna Terminal	31
8.4 Band Edge	36

1. GENERAL INFORMATION

Applicant Name: Suntech International Ltd.

Address: B-1506, Greatvally, 32, 9-Gil, Digital-Ro, Geumcheon-Gu, Seoul 153-709

FCC ID : WA2-ST500

FCC Classification : PCS Licensed Transmitter (PCB)

EUT : Tracker

Model Name : ST500

Add Model Name : N/A

Supplying power : Standard Battery
- Rating: DC 12V

Antenna Information : Internal Antenna

Mode	Tx Frequency (MHz)	Emission Designator	ERP(Max.power)		EIRP(Max.power)	
			dBm	W	dBm	W
GPRS850	824.2 ~ 848.8 MHz	245KGXW	29.05	0.804	31.20	1.318
GPRS1900	1850.2 ~ 1909.8 MHz	245KGXW	-	-	27.33	0.541
-	-	-	-	-	-	-
-	-	-	-	-	-	-

Note: FCC is 850 band based on ERP.

2. INTRODUCTION

2.1. EUT DESCRIPTION

The Equipment Under Test(EUT) supports GPRS.

2.2. Support equipment

Equipment	Model No.	Serial No.	Manufacturer	Note
-	-	-	-	-
-	-	-	-	-

Note: The above equipment were supported by manufacturer.

2.3. MEASURING INSTRUMENT CALIBRATION

The measuring equipment, which was utilized in performing the tests documented herein, has been calibrated in accordance with the manufacturer's recommendations for utilizing calibration equipment, which is traceable to recognized national standards.

2.4. TEST FACILITY

The 3m test site and conducted measurement facility used to collect the radiated data are located at the 42, Yurim-ro, 154beon-gil, Cheoin-gu, Yongin-si, Gyeonggi-do, Korea 449-935. The site is constructed in conformance with the requirements.

- 3m test site registration Number: 165783(FCC)

3. DESCRIPTION OF TESTS

3.1 ERP & EIRP

(Effective Radiated Power & Equivalent Isotropic Radiated Power)

Test Set-up

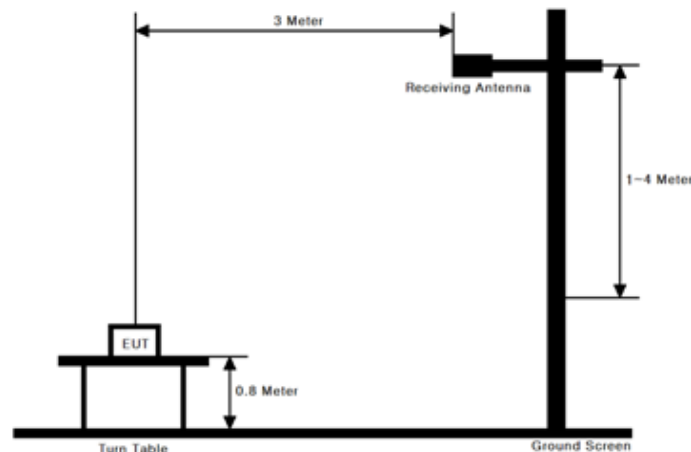

Test Procedure

- ANSI/TIA-603-C-2004 - Section 2.2.17
- KDB971168 v02r02 - Section 5.2.1

These measurements were performed at 3 m test site. The equipment under test is placed on a non-conductive table 0.8-meters above a turntable which is flush with the ground plane and 3 meters from the receive antenna.

Test setting

1. Set span to at least 1.5 times the OBW.
2. Set RBW = 1-5 % of the OBW, not to exceed 1 MHz.
3. Set VBW $\geq 3 \times$ RBW.
4. Set number of points in sweep $\geq 2 \times$ span / RBW.
5. Sweep time = auto couple.
6. Detector = RMS (power averaging).
7. If the EUT can be configured to transmit continuously (i.e., burst duty cycle ≥ 98 %), then set the trigger to free run.
8. If the EUT cannot be configured to transmit continuously (i.e., burst duty cycle < 98 %), then use a sweep trigger with the level set to enable triggering only on full power bursts and configure the EUT to transmit at full power for the entire duration of each sweep.
Ensure that the sweep time is less than or equal to the transmission burst duration.
9. Trace average at least 100 traces in power averaging (i.e., RMS) mode.
10. Compute the power by integrating the spectrum across the OBW of the signal using the instrument's band power measurement function, with the band limits set equal to the OBW band edges. If the instrument does not have a band power function, then sum the spectrum levels (in linear power units) at intervals equal to the RBW extending across the entire OBW of the spectrum.

The receive antenna height and turntable rotations were adjusted for the highest reading on the receive spectrum analyzer.

A half-wave dipole was substituted in place of the EUT. This dipole antenna was driven by a signal generator and the level of the signal generator was adjusted to obtain the same receive spectrum analyzer reading. The conducted power at the terminal of the substitute antenna is measured.

The ERP/EIRP is calculated using the following formula:

ERP/EIRP = The conducted power at the substitute antenna's terminal [dBm] + Substitute Antenna gain [dBd for ERP , dBi for EIRP]

For readings above 1 GHz, the above procedure is repeated using horn antennas and the difference between the gain of the horn antenna and an isotropic antenna are taken into consideration.

3.2 PEAK TO AVERAGE RATIO

Test set-up

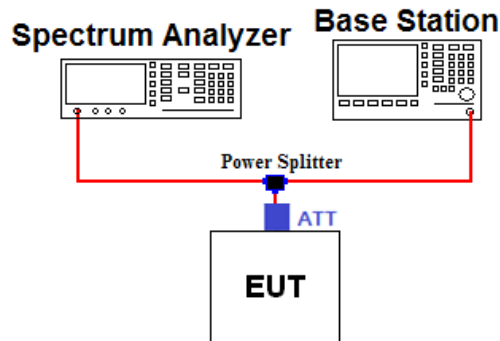

Test Procedure

A peak to average ratio measurement is performed using the following procedure.

■ CCDF Procedure

- KDB971168 v02r02-Section 5.7.1

1. Set resolution/measurement bandwidth \geq signal's occupied bandwidth
2. Set the number of counts to a value that stabilizes the measured CCDF curve
3. Set the measurement interval as follows:
 - 1) For continuous transmissions, set to 1 ms
 - 2) For burst transmissions, employ an external trigger that is synchronized with the EUT burst timing sequence, or use the internal burst trigger with a trigger level that allows the burst to stabilize and set the measurement interval to a time that is less than or equal to the burst duration.
4. Record the maximum PAPR level associated with a probability of 0.1%

■ Alternate Procedure

- KDB971168 v02r02-Section 5.7.2

Use one of the measurement procedures of the peak power and record as P_{Pk} .

Use one of the measurement procedures of the average power and record as P_{Avg} .

Both the peak and average power levels must be expressed in the same logarithmic units (e.g., dBm). Determine the PAPR from:

$$\text{PAPR (dB)} = P_{Pk} \text{ (dBm)} - P_{Avg} \text{ (dBm)}.$$

- Peak Power Measurement

1. Set the RBW \geq OBW
2. Set VBW $\geq 3 \times$ RBW
3. Set span $\geq 2 \times$ RBW
4. Sweep time = auto couple
5. Detector = peak
6. Ensure that the number of measurement points \geq span/RBW.
7. Trace mode = max hold
8. Allow trace to fully stabilize.
9. Use the peak marker function to determine the peak amplitude level.

- Average Power Measurement

1. Set span to at least 1.5 times the OBW.
2. Set RBW = 1-5% of the OBW, not to exceed 1 MHz.
3. Set VBW $\geq 3 \times$ RBW.
4. Set number of points in sweep $\geq 2 \times$ span / RBW.
5. Sweep time = auto-couple.
6. Detector = RMS (power averaging).
7. If the EUT can be configured to transmit continuously (i.e., burst duty cycle $\geq 98\%$), then set the trigger to free run.
8. If the EUT cannot be configured to transmit continuously (i.e., burst duty cycle $< 98\%$), then use a sweep trigger with the level set to enable triggering only on full power bursts and configure the EUT to transmit at full power for the entire duration of each sweep.
Ensure that the sweep time is less than or equal to the transmission burst duration.
9. Trace average at least 100 traces in power averaging (i.e., RMS) mode.
10. Compute the power by integrating the spectrum across the OBW of the signal using the instrument's band power measurement function, with the band limits set equal to the OBW band edges. If the instrument does not have a band power function, then sum the spectrum levels (in linear power units) at intervals equal to the RBW extending across the entire OBW of the spectrum.

3.3 OCCUPIED BANDWIDTH.

Test set-up

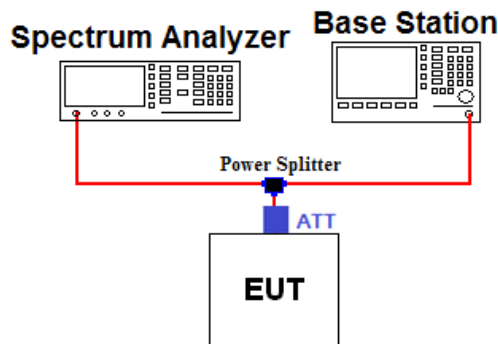

Offset value information

Frequency (MHz)	Offset Value (dB)	Frequency (MHz)	Offset Value (dB)
824.2	18.68	1850.2	19.20
836.6	18.69	1880.0	19.25
848.8	18.75	1909.8	19.27
-	-	-	-

Note. 1: The offset values from EUT to Spectrum analyzer were measured and used for test.
 Offset value = Cable A + Splitter +ATT+ Cable B

Test Procedure

- KDB971168 v02r02-Section 4.2

The occupied bandwidth, that is the frequency bandwidth such that, below its lower and above its upper frequency limits, the mean powers radiated are each equal to 0.5 percent of the total mean power of a given emission.

Test setting

1. The signal analyzer`s automatic bandwidth measurement capability was used to perform the 99 % occupied bandwidth and the 26 dB bandwidth. The bandwidth measurement was not influenced by any intermediate power nulls in the fundamental emission.
2. RBW = 1 ~ 5 % of the expected OBW & VBW ≥ 3 X RBW
3. Detector = Peak
4. Trance mode = Max hold
5. Sweep = Auto couple
6. The trace was allowed to stabilize
7. If necessary, step 2 ~ 6 were repeated after changing the RBW such that it would be within 1 ~ 5 % of the 99 % occupied bandwidth observed in step 6.

3.4 BAND EDGE EMISSIONS AT ANTENNA TERMINAL.

Test set-up

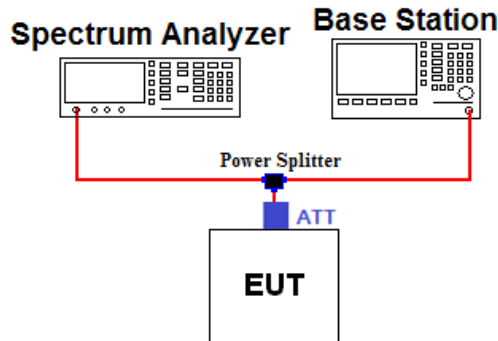

Offset value information

Frequency (MHz)	Offset Value (dB)	Frequency (MHz)	Offset Value (dB)
824.0	18.68	1850.0	19.20
849.0	18.77	1910.0	19.27
-	-	-	-

Note. 1: The offset value from EUT to Spectrum analyzer was measured and used for test.
 Offset value = Cable A + Splitter + ATT + Cable B

Test Procedure

- KDB971168 v02r02 - Section 6.0

All out of band emissions are measured by means of a calibrated spectrum analyzer. The EUT was setup to maximum output power at its lowest and highest channel with all modulations.

The power of any spurious emission shall be attenuated below the transmitter power (P) by at least $43 + 10 \log(P)$ dB

Test setting

1. Start and stop frequency were set such that the band edge would be placed in the center of the plot
2. Span was set large enough so as to capture all out of band emissions near the band edge
3. RBW $\geq 1\%$ of the emission
4. VBW $\geq 3 \times$ RBW
5. Detector = RMS & Trace mode = Max hold
6. Sweep time = Auto couple or 1 s for band edge
7. Number of sweep point $\geq 2 \times$ span / RBW
8. The trace was allowed to stabilize

Note 1: In the 1 MHz bands immediately outside and adjacent to the frequency block a resolution bandwidth of **at least one percent** of the emission bandwidth of the fundamental emission of the transmitter may be employed to demonstrate compliance with the out-of-band emissions limit. The emission bandwidth is defined as the width of the signal between two points, one below the carrier center frequency and one above the carrier center frequency, outside of which all emission are attenuated at least 26 dB below the transmitter power.

3.5 SPURIOUS AND HARMONIC EMISSIONS AT ANTENNA TERMINAL.

Test set-up

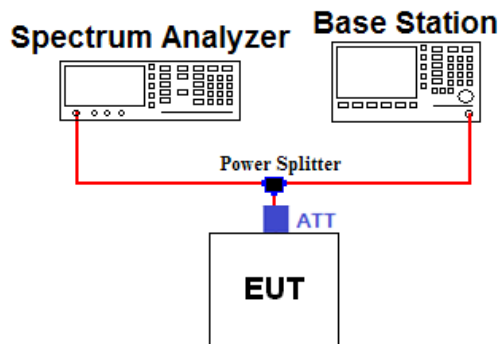

Offset value information

Frequency (MHz)	Offset Value (dB)	Frequency (MHz)	Offset Value (dB)
10000.0	20.45	20000.0	22.57
-	-	-	-

Note. 1: The offset value from EUT to Spectrum analyzer was measured and used for test.
 Offset value = Cable A + Splitter +ATT+ Cable B

Test Procedure

- KDB971168 v02r02 - Section 6.0

The level of the carrier and the various conducted spurious and harmonic frequencies is measured by means of a calibrated spectrum analyzer. The EUT was setup to maximum output power at its low, middle, high channel with all bandwidths. The spectrum is scanned from 30 MHz up to a frequency including its 10th harmonic.

The power of any spurious emission shall be attenuated below the transmitter power (P) by at least $43 + 10 \log(P)$ dB

Test setting

1. RBW = 100 KHz or 1 MHz & VBW $\geq 3 \times$ RBW (Refer to Note 1)
2. Detector = RMS & Trace mode = Max hold
3. Sweep time = Auto couple
4. Number of sweep point $\geq 2 \times$ span / RBW
5. The trace was allowed to stabilize

Note 1: Compliance with these provisions is based on the use of measurement instrumentation employing a resolution bandwidth of 100 kHz or greater for Part 22 and 1 MHz or greater for Part 24.

3.6 RADIATED SPURIOUS EMISSIONS

Test Set-up

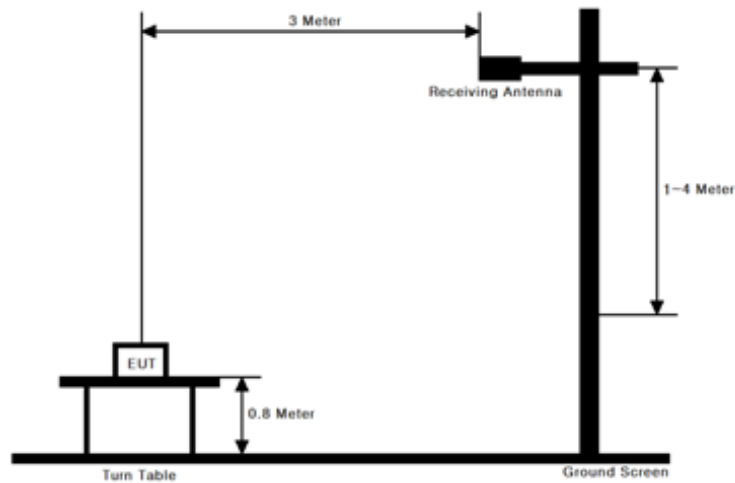

Test Procedure

- ANSI/TIA-603-C-2004 - Section 2.2.12
- KDB971168 v02r02 - Section 5.8

These measurements were performed at 3 m test site. The equipment under test is placed on a non-conductive table 0.8-meters above a turntable which is flush with the ground plane and 3 meters from the receive antenna.

Test setting

1. RBW = 100 kHz for below 1 GHz and 1 MHz for above 1 GHz / VBW $\geq 3 \times$ RBW
2. Detector = Peak & Trace mode = Max hold
3. Sweep time = Auto couple
4. Number of sweep point $\geq 2 \times$ span / RBW
5. The trace was allowed to stabilize

The receive antenna height and turntable rotations were adjusted for the highest reading on the receive spectrum analyzer.

For radiated power measurements below 1 GHz, a half-wave dipole was substituted in place of the EUT. This dipole antenna was driven by a signal generator and the level of the signal generator was adjusted to obtain the same spectrum analyzer reading.

For radiated power measurements above 1 GHz, a Horn antenna was substituted in place of the EUT. This Horn antenna was driven by a signal generator and the level of the signal generator was adjusted to obtain the same spectrum analyzer reading. The difference between the gain of the horn and an isotropic antenna are taken into consideration.

This measurement was performed with the EUT oriented in 3 orthogonal axis.

3.7 FREQUENCY STABILITY / VARIATION OF AMBIENT TEMPERATURE

Test Set-up

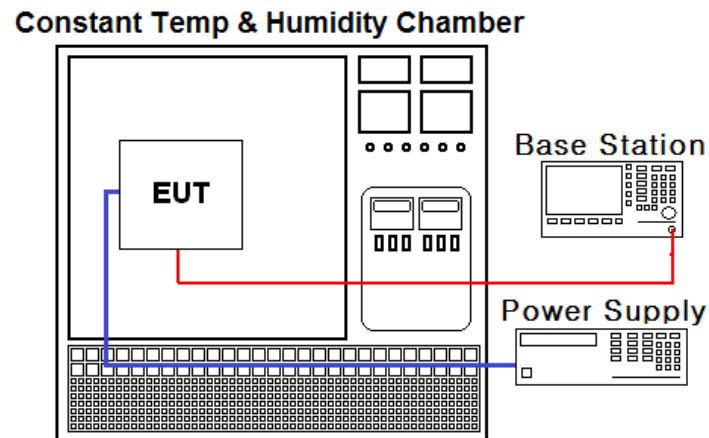

Test Procedure

- ANSI/TIA-603-C-2004
- KDB971168 v02r02 - Section 9.0

The frequency stability of the transmitter is measured by:

a.) **Temperature:**

The temperature is varied from - 30 °C to + 50 °C using an environmental chamber.

b.) **Primary Supply Voltage:**

The primary supply voltage is varied from 85 % to 115 % of the nominal value for non hand-carried battery and AC powered equipment. For hand-carried, battery-powered equipment, primary supply voltage is reduced to the battery operating end point which shall be specified by the manufacturer.

Specification:

The frequency stability shall be sufficient to ensure that the fundamental emission stays within the authorized frequency block for Part 24. The frequency stability of the transmitter shall be maintained within $\pm 0.00025\%$ (± 2.5 ppm) of the center frequency for Part 22.

Time Period and Procedure:

1. The carrier frequency of the transmitter is measured at room temperature.
(20 °C to provide a reference)
2. The equipment is turned on in a “standby” condition for one minute before applying power to the transmitter. Measurement of the carrier frequency of the transmitter is made within one minute after applying power to the transmitter.
3. Frequency measurements are made at 10 °C intervals ranging from -30 °C to +50 °C.
A period of at least one half-hour is provided to allow stabilization of the equipment at each temperature level.

4. LIST OF TEST EQUIPMENT

Type	Manufacturer	Model	Cal.Date (yy/mm/dd)	Next.Cal. Date (yy/mm/dd)	S/N
MXA Signal Analyzer	Agilent Technologies	N9020A	16/01/06	17/01/06	MY46471096
MXA Signal Analyzer	Agilent Technologies	N9020A	15/09/09	16/09/09	MY46471248
DC Power Supply	HP	66332A	16/01/05	17/01/05	US37471368
DC Power Supply	SM techno	SDP30-5D	15/09/23	16/09/23	305DMG305
Multimeter	FLUKE	17B	16/04/21	17/04/21	26030065WS
Vector Signal Generator	R&S	SMBV100A	16/01/05	17/01/05	255571
Signal Generator	R&S	SMF100A	15/06/29	16/06/29	102341
Power Splitter	Anritsu	K241B	15/10/20	16/10/20	1701061
2W 3dB Attenuator	SMAJK	SMAJK-2-3	15/10/19	16/10/19	3
50W 10dB Attenuator	SMAJK	SMAJK-50-10	15/10/19	16/10/19	2-50-10
Temp & Humi Test Chamber	SJ Science	SJ-TH-S50	15/10/19	16/10/19	SJ-TH-S50-131011
8960 Series 10 Wireless Comms Test Set	Agilent Technologies	E5515C	15/09/10	16/09/10	GB41321164
Thermohygrometer	BODYCOM	BJ5478	16/02/25	17/02/25	1209
Loop Antenna	Schwarzbeck	FMZB1513	16/04/22	18/04/22	1513-128
TRILOG Broadband Test-Antenna	Schwarzbeck	VULB 9161	14/07/10	16/07/10	4070
Dipole Antenna	Schwarzbeck	VHA9103	15/05/29	17/05/29	2116
Dipole Antenna	Schwarzbeck	VHA9103	16/04/15	18/04/15	2117
Dipole Antenna	Schwarzbeck	UHA9105	15/05/29	17/05/29	2261
Dipole Antenna	Schwarzbeck	UHA9105	16/04/15	18/04/15	2262
HORN ANT	ETS	3115	15/02/09	17/02/09	00021097
HORN ANT	ETS	3117	16/05/03	18/05/03	140394
HORN ANT	A.H.Systems	SAS-574	15/04/30	17/04/30	154
HORN ANT	A.H.Systems	SAS-574	15/09/03	17/09/03	155
Amplifier	EMPOWER	BBS3Q7ELU	15/09/09	16/09/09	1020
Low Noise Pre Amplifier	tsj	MLA-010K01-B01-27	16/03/10	17/03/10	1844539
Amplifier (30dB)	Agilent	8449B	15/11/06	16/11/06	3008A02108
High-pass filter	Wainwright	WHKX12-935-1000-15000-40SS	15/09/23	16/09/23	7
High-pass filter	Wainwright	WHKX12-2580-3000-18000-80SS	15/09/23	16/09/23	3

5. SUMMARY OF TEST RESULTS

FCC Part Section(s)	RSS Section(s)	Parameter	Status Note 1
2.1046	RSS-132 [5.4] RSS-133 [6.4]	Conducted Output Power	C
22.913(a) 24.232(c)	RSS-132 [5.4] [SRSP-503(5.1.3)] RSS-133 [6.4] [SRSP-510(5.1.2)]	Effective Radiated Power Equivalent Isotropic Radiated Power	C
22.917(a) 24.238(a) 2.1049	RSS-Gen [6.6]	Occupied Bandwidth	C
22.917(a) 24.238(a) 2.1051	RSS-132 [5.5] RSS-133 [6.5]	Band Edge Spurious and Harmonic Emissions at Antenna Terminal	C
24.232(d)	RSS-132 [5.4] RSS-133 [6.4]	Peak to Average Ratio	C
22.917(a) 24.238(a) 2.1053	RSS-132 [5.5] RSS-133 [6.5]	Radiated Spurious and Harmonic Emissions	C
22.355 24.235 2.1055	RSS-132 [5.3] RSS-133 [6.3]	Frequency Stability	C
Note 1: C =Comply NC =Not Comply NT =Not Tested NA =Not Applicable			

The sample was tested according to the following specification:

ANSI/TIA/EIA-603-C-2004 and KDB 971168 D01 v02r02

6. SAMPLE CALCULATION

A. Emission Designator

GPRS850 Emission Designator

Emission Designator = **245KGXW**

GPRS OBW = 245.06 kHz

(Measured at the 99.75 % power bandwidth)

G = Phase Modulation

X = Cases not otherwise covered

W = Combination (Audio/Data)

GPRS1900 Emission Designator

Emission Designator = **245KGXW**

GPRS OBW = 245.10 kHz

(Measured at the 99.75 % power bandwidth)

G = Phase Modulation

X = Cases not otherwise covered

W = Combination (Audio/Data)

B. EIRP Sample Calculation

MODE	Channel	Freq.(MHz)	Spectrum Reading Value(dBm)	EUT Axis	Ant Pol (H/V)	Level(dBm) @ Ant Terminal	TX Ant Gain(dBi)	Result	
								(dBm)	(W)
GPRS1900	512	1850.2	-15.81	X	H	18.32	9.01	27.33	0.541

EIRP = @ Ant Terminal LEVEL(dBm) + Ant. Gain

- 1) The EUT mounted on turntable of ground plane.
- 2) During the test, the turn table is rotated until the maximum signal is found.
- 3) Record the field strength meter's level.
- 4) Replace the EUT with dipole/Horn antenna that is connected to a calibrated signal generator.
- 5) Increase the signal generator output till the field strength meter's level is equal to the item (3).
- 6) The signal generator output level with Ant. Gain is the rating of effective isotropic radiated power (EIRP).

7. TEST DATA

7.1 Conducted OUTPUT POWER

A base station simulator was used to establish communication with the EUT. The base station simulator parameters were set to produce the maximum power from the EUT. This device was tested under all configurations and the highest power is reported. Conducted Output Powers of EUT are reported below.

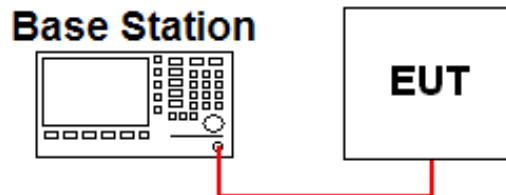

The output power was measured using the Agilent E5515C

▪ GPRS

Band	Channel	Test Result(dBm)								
		GSM Voice	GPRS 1 TX Slot	GPRS 2 TX Slot	GPRS 3 TX Slot	GPRS 4 TX Slot	EDGE 1 TX Slot	EDGE 2 TX Slot	EDGE 3 TX Slot	EDGE 4 TX Slot
Cellular	128	-	32.10	31.41	-	-	-	-	-	-
	190	-	32.12	31.40	-	-	-	-	-	-
	251	-	32.10	31.40	-	-	-	-	-	-
PCS	512	-	29.71	28.83	-	-	-	-	-	-
	661	-	29.73	28.82	-	-	-	-	-	-
	810	-	29.73	28.83	-	-	-	-	-	-

*This device was not supported the voice.

7.2 PEAK TO AVERAGE RATIO

- Plots of the EUT’s Peak- to- Average Ratio are shown in Clause 8.1

7.3 OCCUPIED BANDWIDTH

Band	Channel	Frequency	Test Result (kHz)
GPRS850	128	824.2	245.06
	190	836.6	242.46
	251	848.8	243.58
GPRS1900	512	1850.2	245.10
	661	1880.0	241.64
	810	1909.8	242.95

- Plots of the EUT’s Occupied Bandwidth are shown in Clause 8.2

7.4 SPURIOUS AND HARMONIC EMISSIONS AT ANTENNA TERMINAL

- Plots of the EUT’s Conducted Spurious Emissions are shown in Clause 8.3

7.5 BAND EDGE

- Plots of the EUT’s Band Edge are shown in Clause 8.4

7.6 EFFECTIVE RADIATED POWER

- GPRS850

Freq(MHz) CH	EUT Positio n (Axis)	Test mode						
		Pol. (H/V)	LEVEL@ TX ANTENNA TERMINAL (dBm)	Antenna Gain (dBd)	ERP (dBm)	ERP (W)	Rated Voltage	Note.
824.2 128	X	H	27.82	1.23	29.05	0.804	DC 12V	GPRS
836.6 190	X	H	26.87	1.30	28.17	0.656	DC 12V	GPRS
848.8 251	X	H	27.37	1.36	28.73	0.746	DC 12V	GPRS

NOTES:

This EUT was tested under all configurations and the highest power is reported.

The GSM mode of power control level is set to "0" in PCS band and "5" in cellular band.

Also, we have done x, y, z planes in EUT and horizontal and vertical polarization of detecting antenna.

The worst case data is reported in the table above.

7.7 EQUIVALENT ISOTROPIC RADIATED POWER

- GPRS1900 data

Freq(MHz) CH	EUT Positio n (Axis)	Test mode						
		Pol. (H/V)	LEVEL@ TX ANTENNA TERMINAL (dBm)	Antenna Gain (dBi)	EIRP (dBm)	EIRP (W)	Rated Voltage	Note.
1850.2 512	X	H	18.32	9.01	27.33	0.541	DC 12V	GPRS
1880.0 661	X	H	17.87	9.05	26.92	0.492	DC 12V	GPRS
1909.80 810	X	H	17.93	9.08	27.01	0.502	DC 12V	GPRS

NOTES:

This EUT was tested under all configurations and the highest power is reported.

The GSM mode of power control level is set to "0" in PCS band and "5" in cellular band.

Also, we have done x, y, z planes in EUT and horizontal and vertical polarization of detecting antenna.

The worst case data is reported in the table above.

7.8 RADIATED SPURIOUS EMISSIONS

7.8.1 RADIATED SPURIOUS EMISSIONS (GPRS850)

Channel (ERP)	Freq. (MHz)	EUT Position (Axis)	POL (H/V)	LEVEL@ ANTENNA TERMINAL (dBm)	Substitute Antenna Gain (dBd)	Correct Generator Level (dBm)	Result (dBc)	Limit (dBc)
128 (0.804 W)	1648.30	X	H	-35.50	6.64	-28.86	57.91	42.05
	2472.67	Z	V	-33.65	7.58	-26.07	55.12	
	3296.75	Z	V	-50.10	7.79	-42.31	71.36	
	-	-	-	-	-	-	-	
190 (0.656 W)	1671.16	X	H	-41.34	6.66	-34.68	62.85	41.17
	2509.85	Z	V	-37.11	7.61	-29.50	57.67	
	3346.30	Z	V	-51.10	7.83	-43.27	71.44	
	-	-	-	-	-	-	-	
251 (0.746 W)	1695.24	X	H	-32.77	6.69	-26.08	54.81	41.73
	2546.63	Z	V	-34.06	7.60	-26.46	55.19	
	3395.19	Z	V	-48.78	7.87	-40.91	69.64	
	-	-	-	-	-	-	-	

- Limit Calculation= $43 + 10 \log_{10}(ERP [W])$ [dBc]

- No other spurious and harmonic emissions were reported greater than listed emissions above table.

NOTES:

This EUT was tested under all configurations and the highest power is reported.

The GSM mode of power control level is set to "0" in PCS band and "5" in cellular band.

Also, we have done x, y, z planes in EUT and horizontal and vertical polarization of detecting antenna.

The worst case data is reported in the table above.

7.8.2 RADIATED SPURIOUS EMISSIONS (GPRS1900)

Channel (EIRP)	Freq. (MHz)	EUT Position (Axis)	POL (H/V)	LEVEL@ ANTENNA TERMINAL (dBm)	Substitute Antenna Gain (dBi)	Correct Generator Level (dBm)	Result (dBc)	Limit (dBc)
512 (0.541 W)	3700.15	Y	H	-48.56	9.91	-38.65	65.98	40.33
	5550.88	Y	H	-51.66	10.98	-40.68	68.01	
	7401.22	Y	V	-48.69	11.55	-37.14	64.47	
	9251.37	Y	V	-45.34	11.58	-33.76	61.09	
661 (0.492 W)	3760.24	Y	H	-47.14	9.85	-37.29	64.21	39.92
	5639.66	Y	H	-53.35	11.11	-42.24	69.16	
	7519.65	Y	V	-52.94	11.51	-41.43	68.35	
	9399.95	Y	V	-45.98	11.70	-34.28	61.20	
810 (0.502 W)	3819.33	Y	H	-49.21	9.80	-39.41	66.42	40.01
	5729.39	Y	H	-54.76	11.24	-43.52	70.53	
	7639.33	Y	V	-55.83	11.46	-44.37	71.38	
	9548.63	Y	V	-47.79	11.83	-35.96	62.97	

- Limit Calculation = $43 + 10 \log_{10}(\text{EIRP [W]})$ [dBc]

- No other spurious and harmonic emissions were reported greater than listed emissions above table.

NOTES:

This EUT was tested under all configurations and the highest power is reported.

The GSM mode of power control level is set to "0" in PCS band and "5" in cellular band.

Also, we have done x, y, z planes in EUT and horizontal and vertical polarization of detecting antenna.

The worst case data is reported in the table above.

7.9 FREQUENCY STABILITY / VARIATION OF AMBIENT TEMPERATURE

7.9.1 FREQUENCY STABILITY (GPRS850)

OPERATING FREQUENCY : 836,600,000 Hz
 CHANNEL : 190(Mid)
 REFERENCE VOLTAGE : 12.0 V DC
 DEVIATION LIMIT(FCC & IC) : $\pm 0.00025\%$ or 2.5 ppm

VOLTAGE (%)	POWER (V DC)	TEMP (°C)	FREQ (Hz)	Deviation	
				(ppm)	(%)
100%	12.0	+20(Ref)	836,599,983	-0.020	-0.00000203
100%		-30	836,599,989	-0.013	-0.00000131
100%		-20	836,599,982	-0.022	-0.00000215
100%		-10	836,599,982	-0.022	-0.00000215
100%		0	836,599,986	-0.017	-0.00000167
100%		+10	836,599,979	-0.025	-0.00000251
100%		+20	836,599,983	-0.020	-0.00000203
100%		+30	836,599,983	-0.020	-0.00000203
100%		+40	836,599,968	-0.038	-0.00000383
100%		+50	836,599,983	-0.020	-0.00000203
115%	13.8	+20	836,599,978	-0.026	-0.00000263
85%	10.2	+20	836,599,980	-0.024	-0.00000239

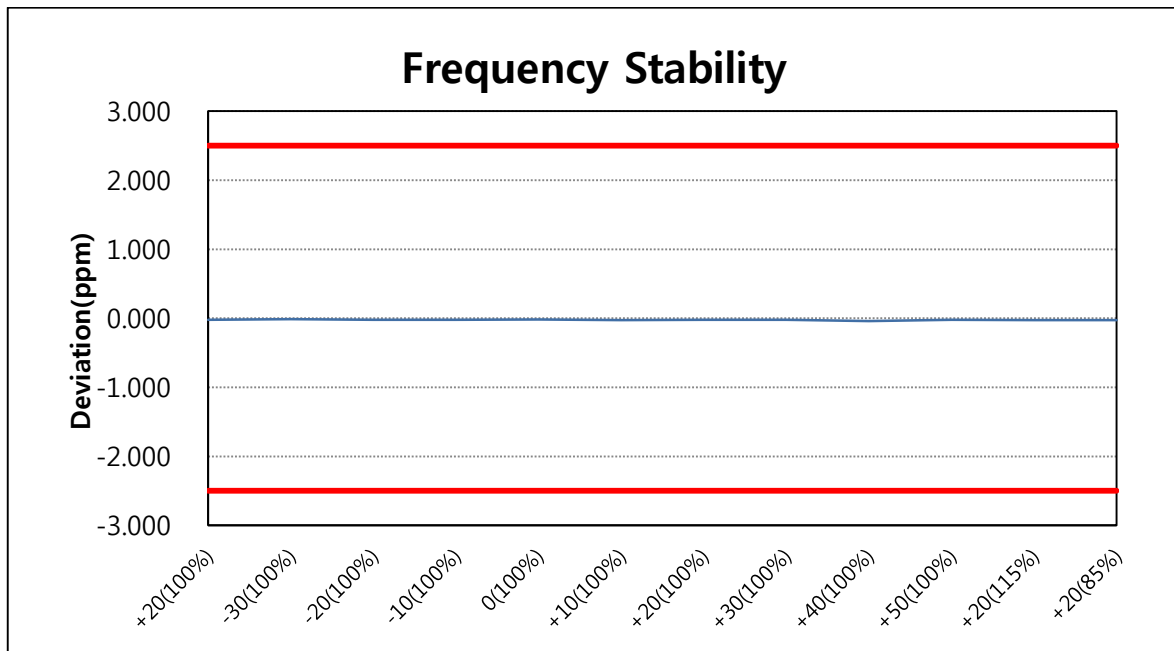

7.9.2 FREQUENCY STABILITY (GPRS1900)

OPERATING FREQUENCY : 1,880,000,000 Hz
 CHANNEL : 661(Mid)
 REFERENCE VOLTAGE : 12.0 V DC
 LIMIT(FCC) : The frequency stability shall be sufficient to ensure that the fundamental emission stays within the authorized frequency block.
 DEVIATION LIMIT(IC) : ± 0.00025 % or 2.5 ppm

VOLTAGE (%)	POWER (V DC)	TEMP (°C)	FREQ (Hz)	Deviation	
				(ppm)	(%)
100%	12.0	+20(Ref)	1,879,999,980	-0.011	-0.00000106
100%		-30	1,879,999,972	-0.015	-0.00000149
100%		-20	1,879,999,974	-0.014	-0.00000138
100%		-10	1,879,999,969	-0.016	-0.00000165
100%		0	1,879,999,976	-0.013	-0.00000128
100%		+10	1,879,999,985	-0.008	-0.00000080
100%		+20	1,879,999,982	-0.010	-0.00000096
100%		+30	1,879,999,986	-0.007	-0.00000074
100%		+40	1,879,999,970	-0.016	-0.00000160
100%		+50	1,879,999,973	-0.014	-0.00000144
115%	13.8	+20	1,879,999,981	-0.010	-0.00000101
85%	10.2	+20	1,879,999,973	-0.014	-0.00000144

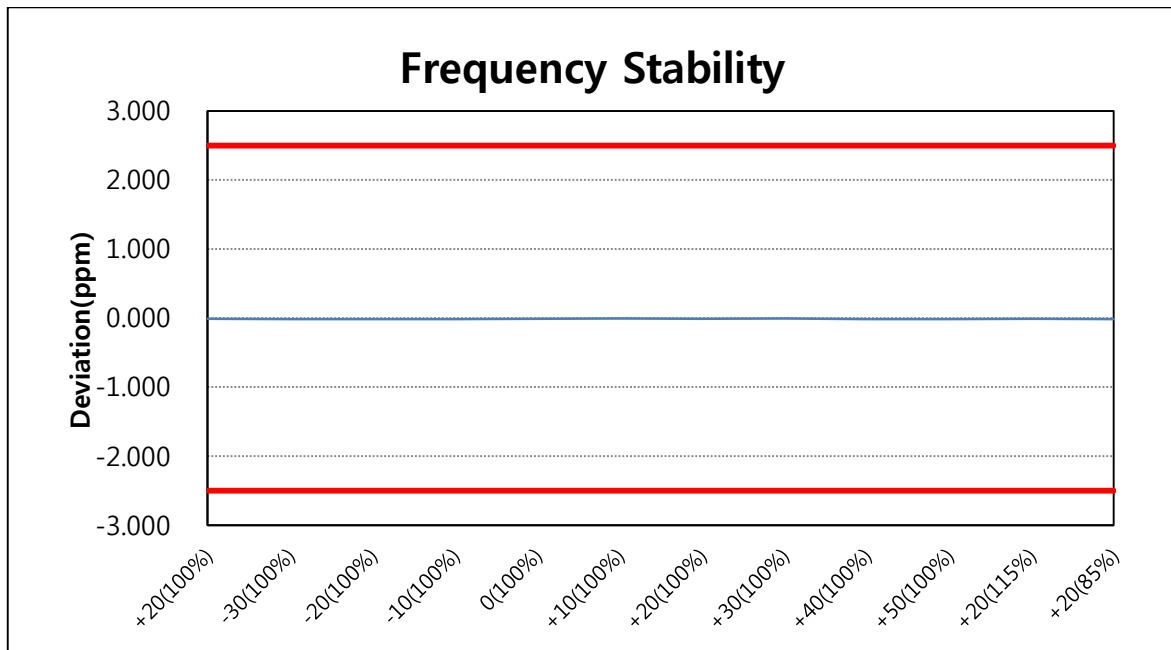

Note. Based on the results of the frequency stability test at the center channel the frequency deviation results measured are very small. as such it is determined that the channels at the band edge would remain inband when the maximum measured frequency deviation noted during the frequency stability tests is applied. therefore the device is determined to remain operating in band over the temperature and voltage range as tested.

8. TEST PLOTS

8.1 Peak to Average Ratio

-P_{PK} (dBm) **GPRS850 & Channel: 190**

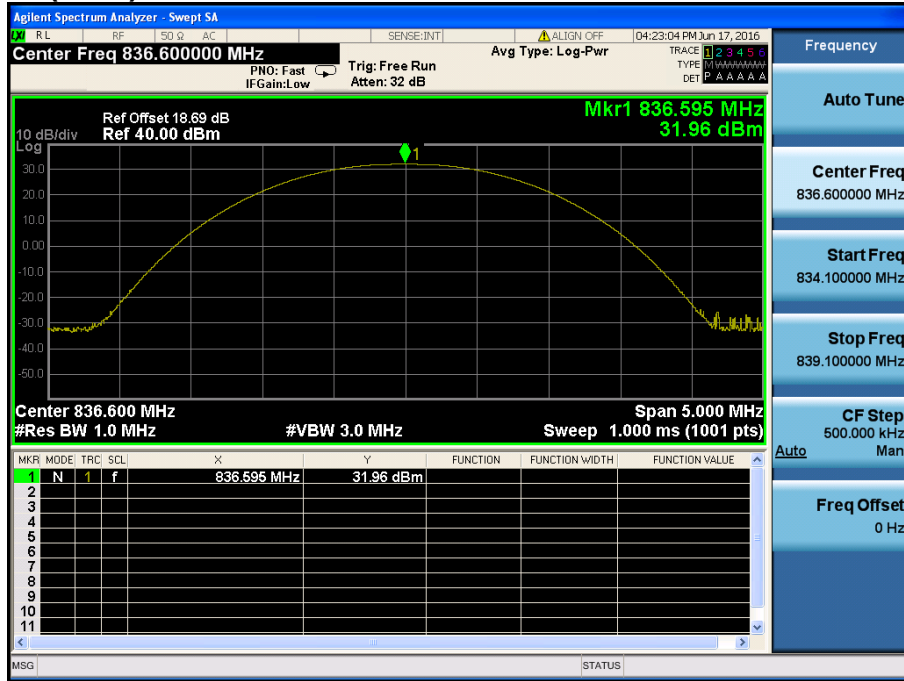

-P_{Avg} (dBm) **GPRS850 & Channel: 190**

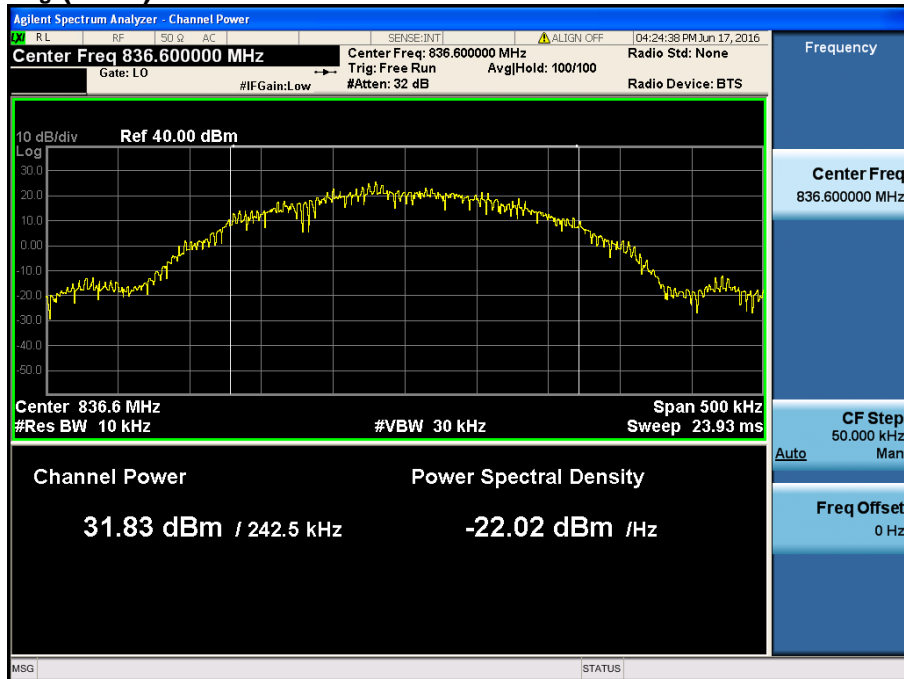

$$\text{PAPR (dB)} = P_{PK} \text{ (dBm)} - P_{Avg} \text{ (dBm)} = 31.96 \text{ dBm} - 31.83 \text{ dBm} = 0.13 \text{ dB}$$

-P_{pk} (dBm) GPRS1900 & Channel: 661

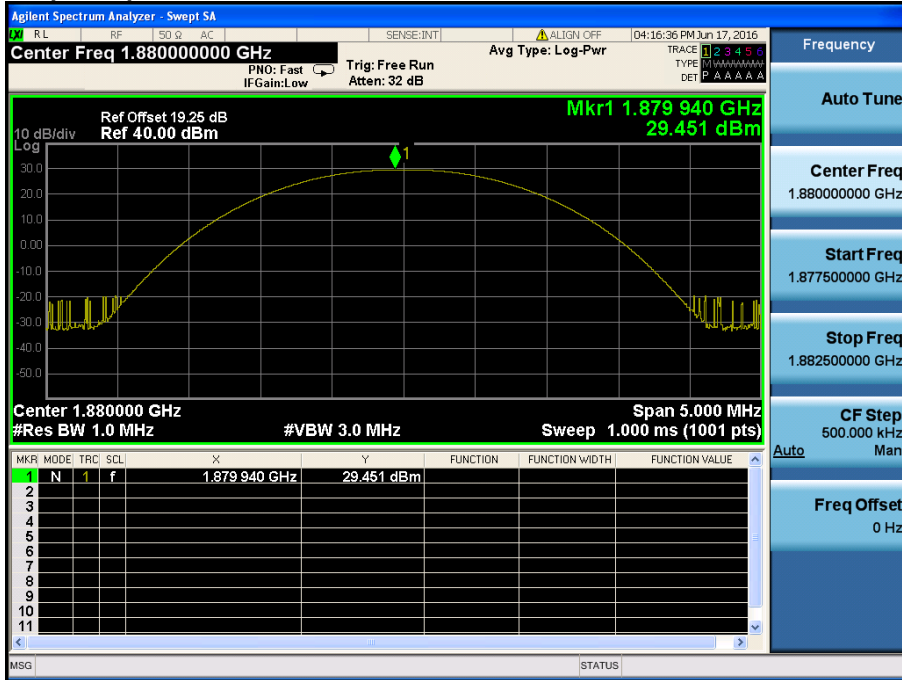

-P_{avg} (dBm) GPRS 1900 & Channel: 661

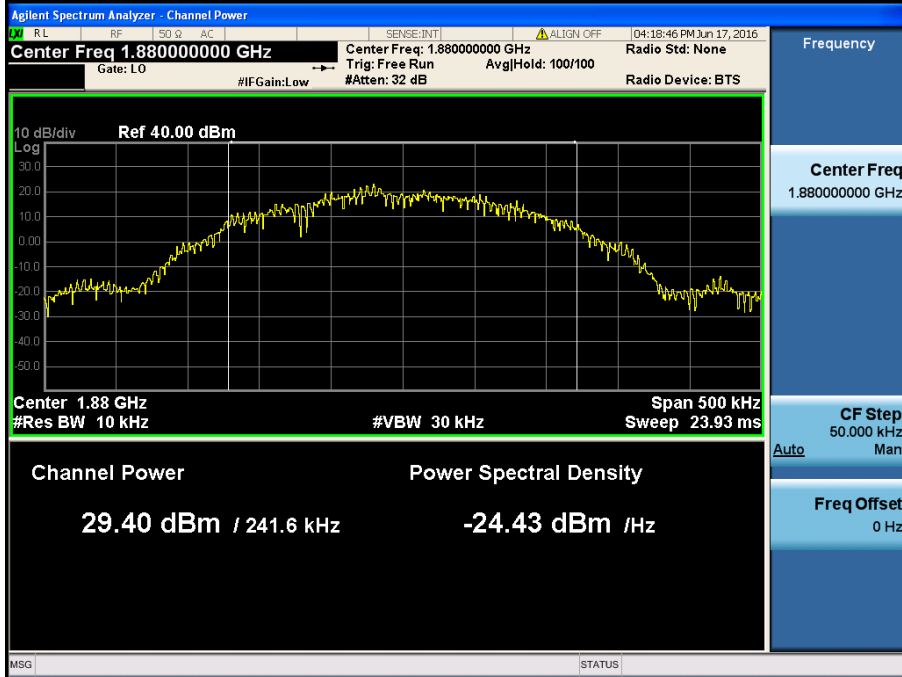

$$PAPR (dB) = P_{pk} (dBm) - P_{avg} (dBm) = 29.45 \text{ dBm} - 29.40 \text{ dBm} = 0.05 \text{ dB}$$

8.2 Occupied Bandwidth (99 % Bandwidth)

GPRS850 & Channel: 128

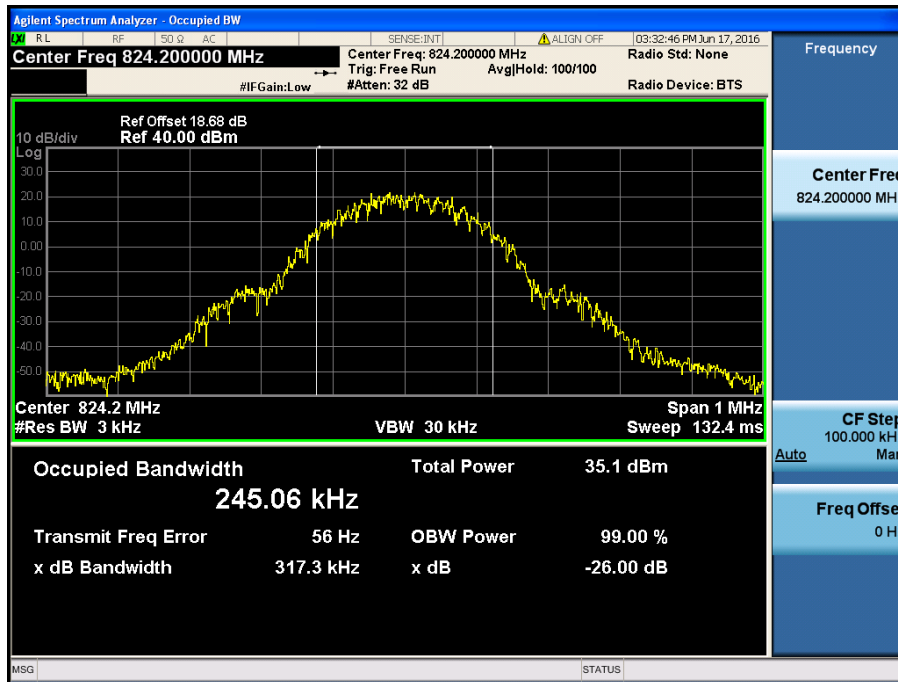

GPRS850 & Channel: 190

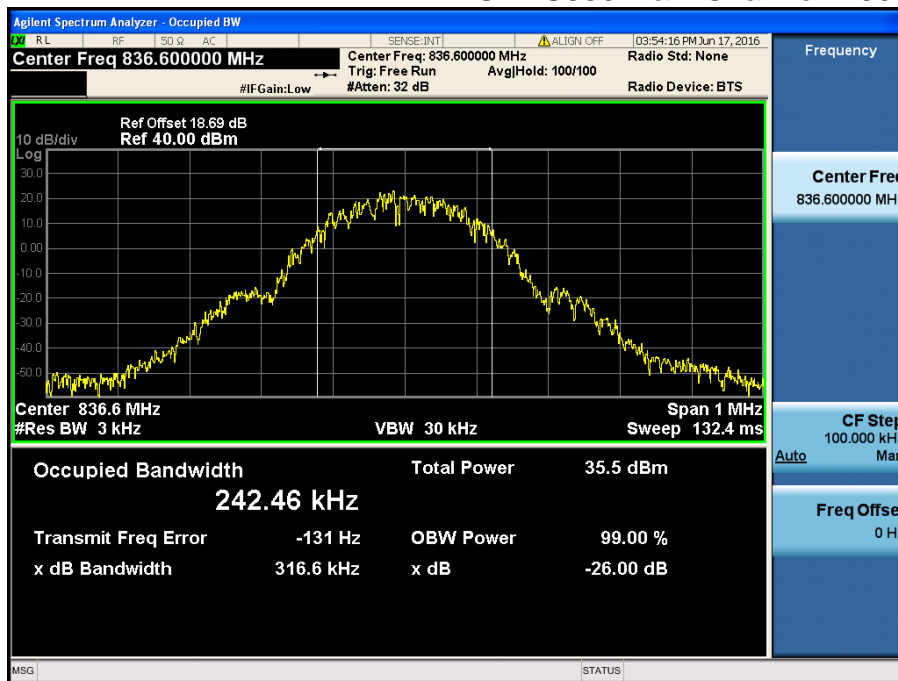

GPRS850 & Channel: 251

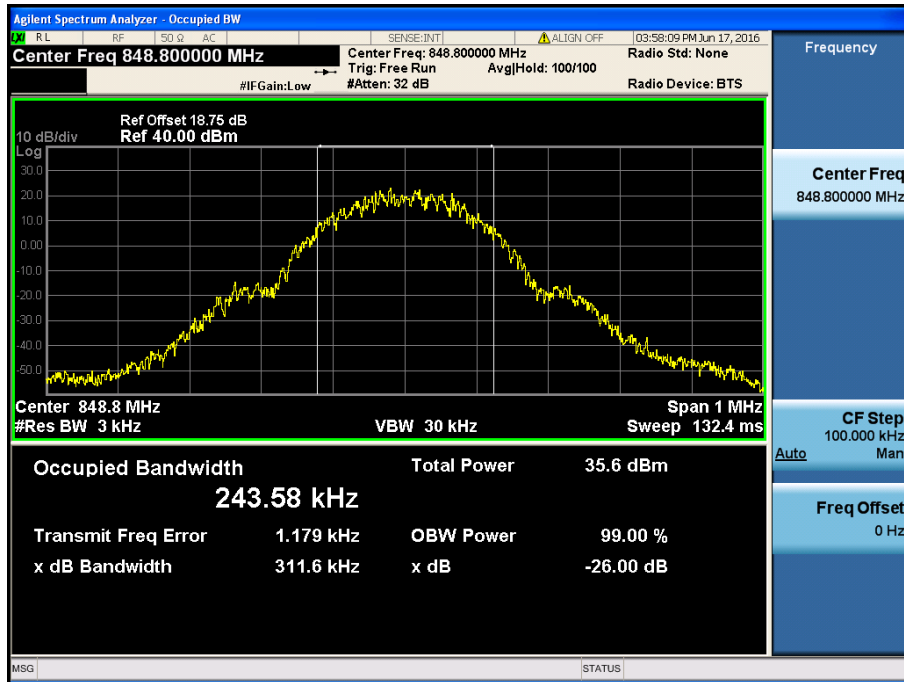

GPRS 1900 & Channel: 512

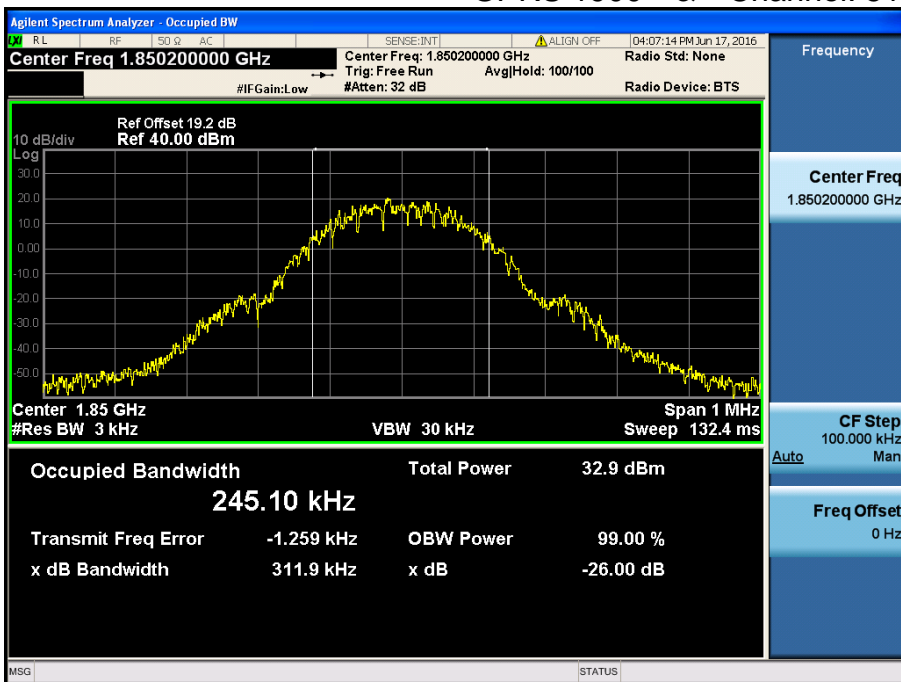

GPRS 1900 & Channel: 661

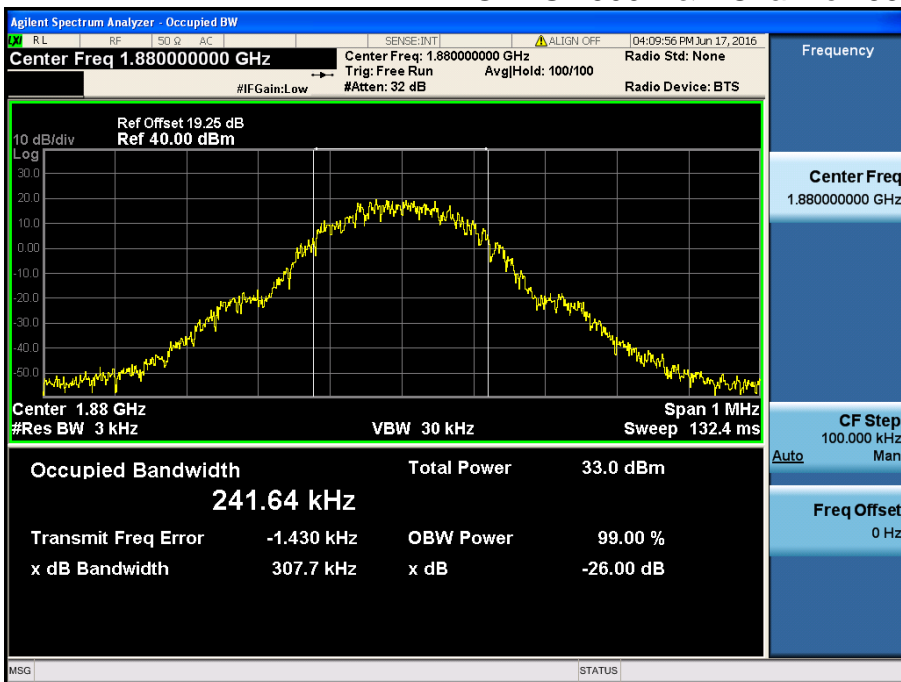

GPRS 1900 & Channel: 810

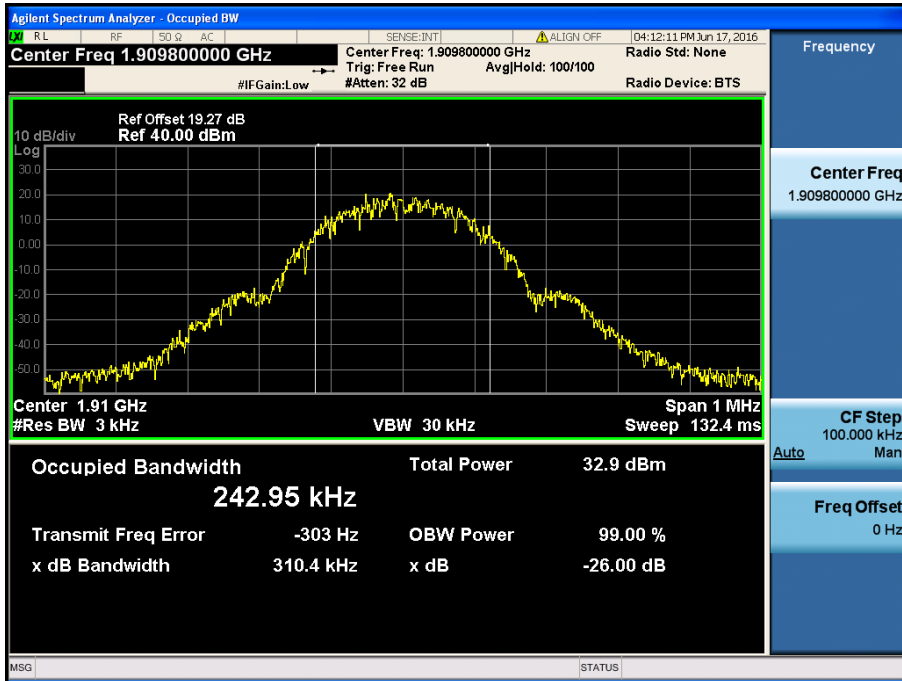

8.3 Spurious Emissions at Antenna Terminal

GPRS850 & Channel: 128

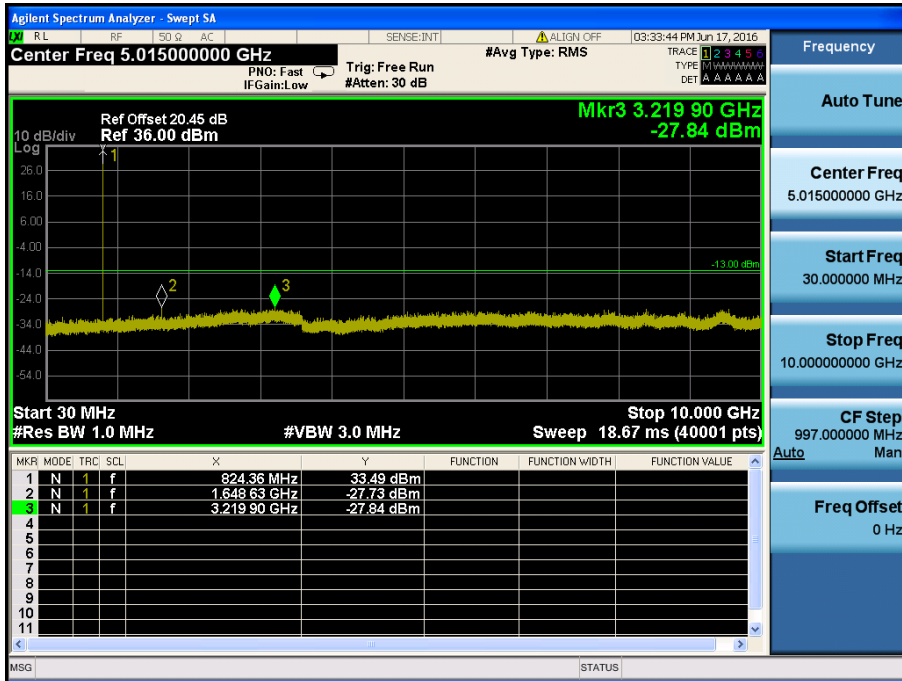

GPRS850 & Channel: 190

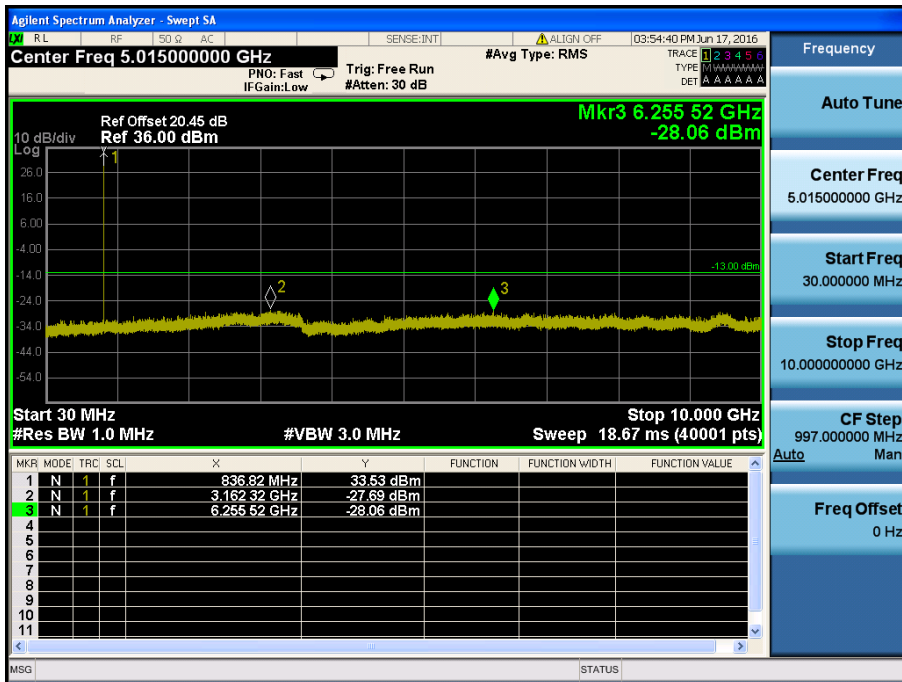

GPRS850 & Channel: 251

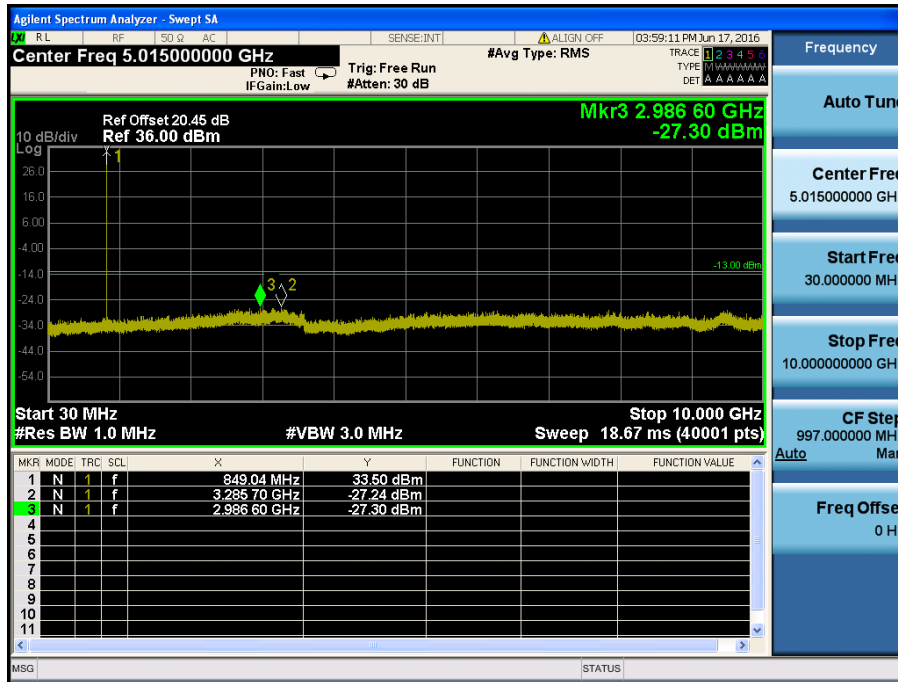

GPRS1900 & Channel: 512

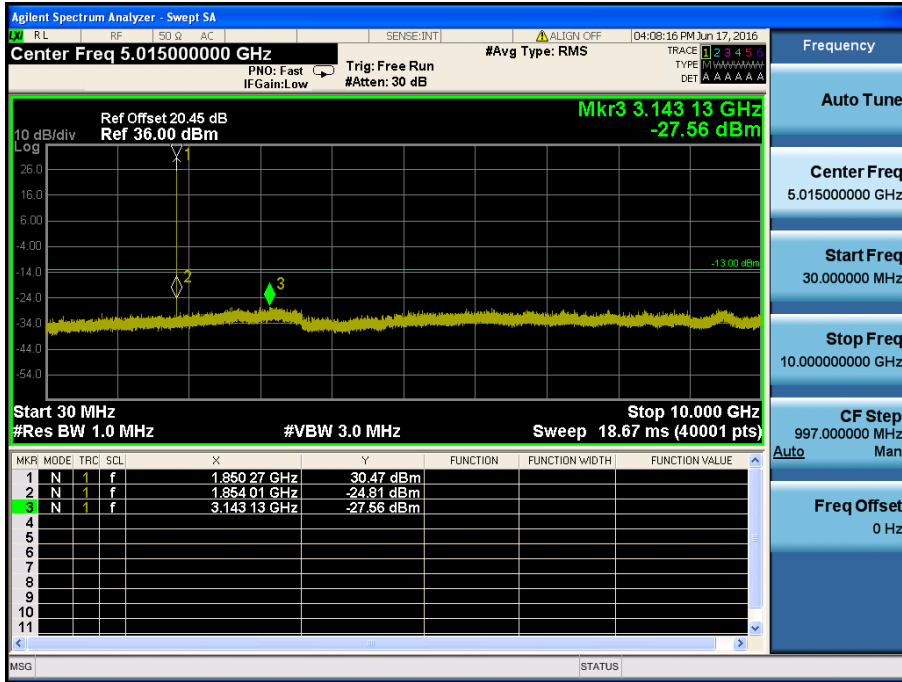

GPRS1900 & Channel: 512

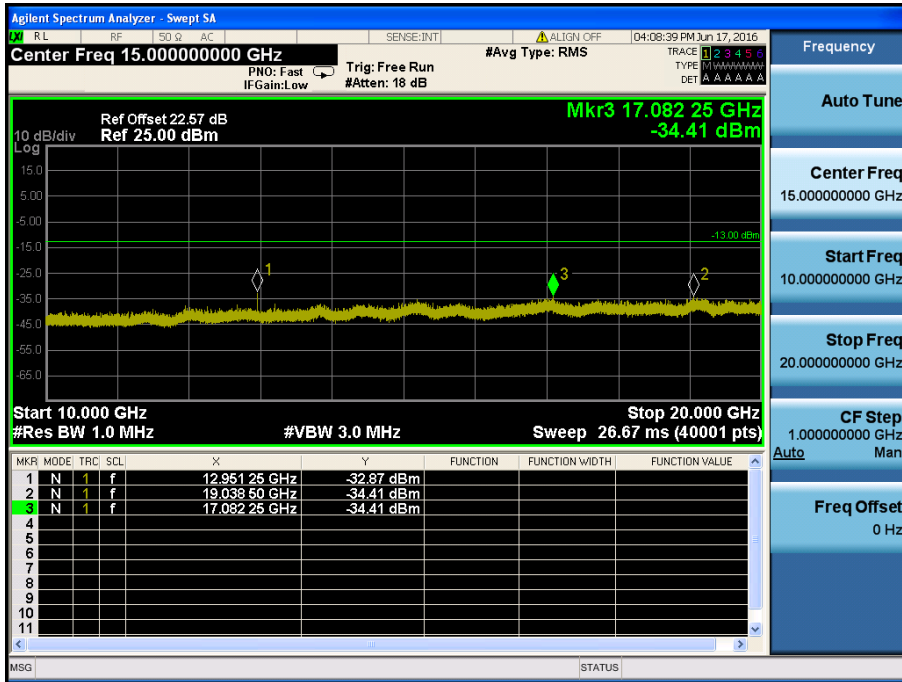

GPRS1900 & Channel: 661

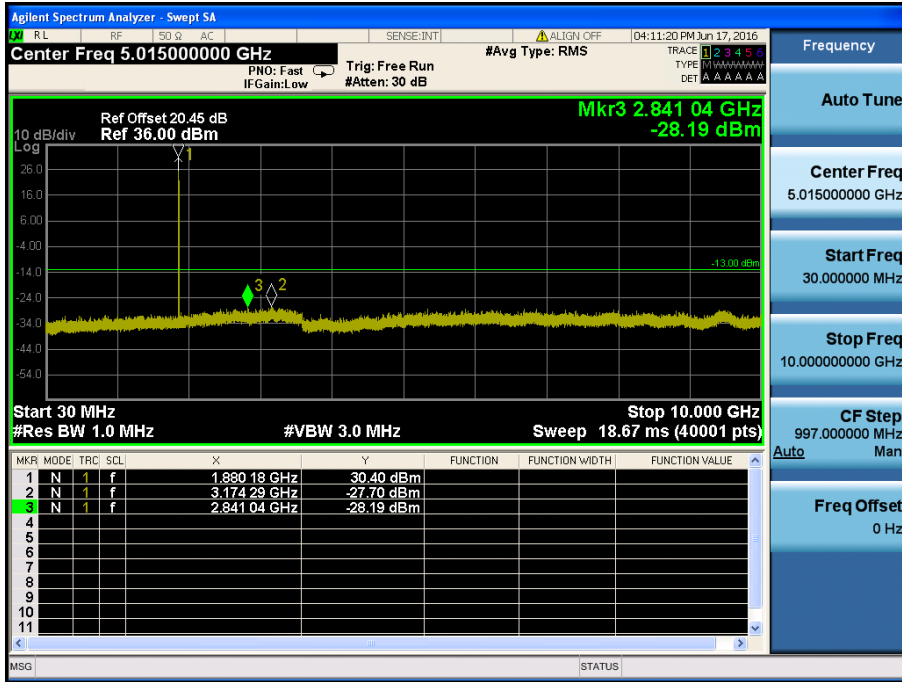

GPRS1900 & Channel: 661

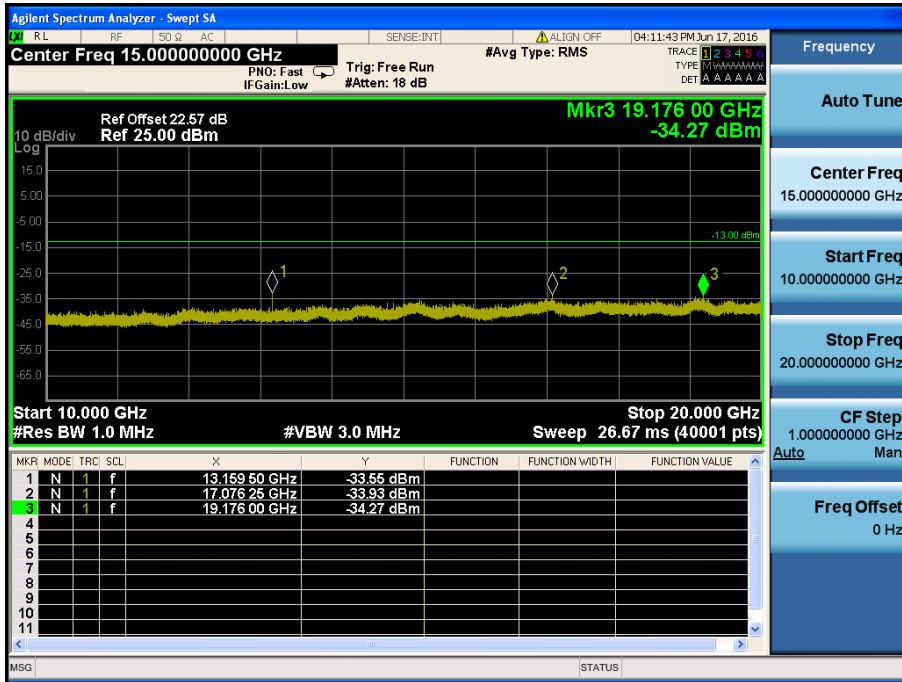

GPRS1900 & Channel: 810

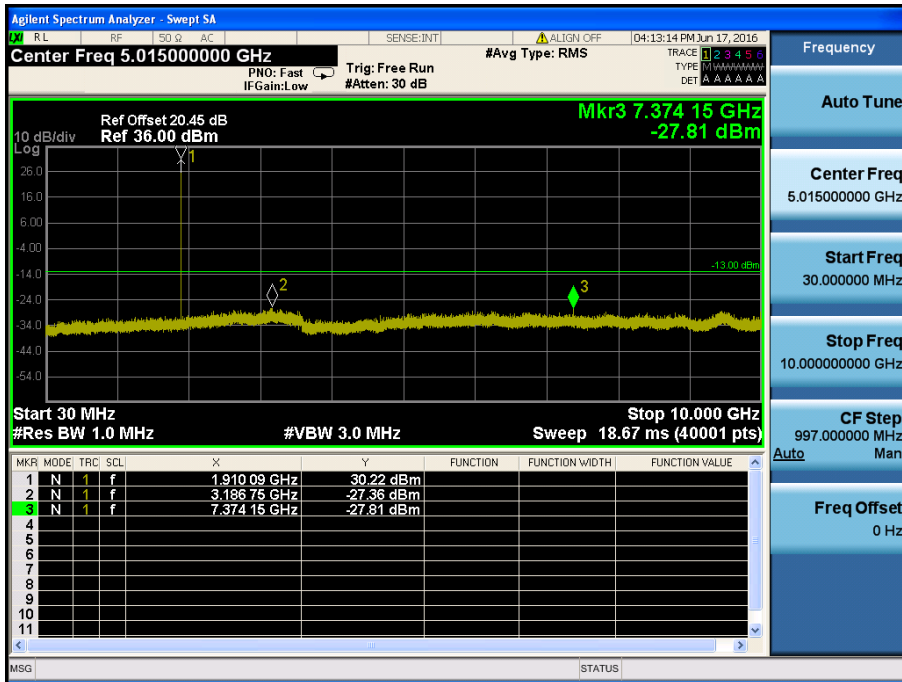

GPRS1900 & Channel: 810

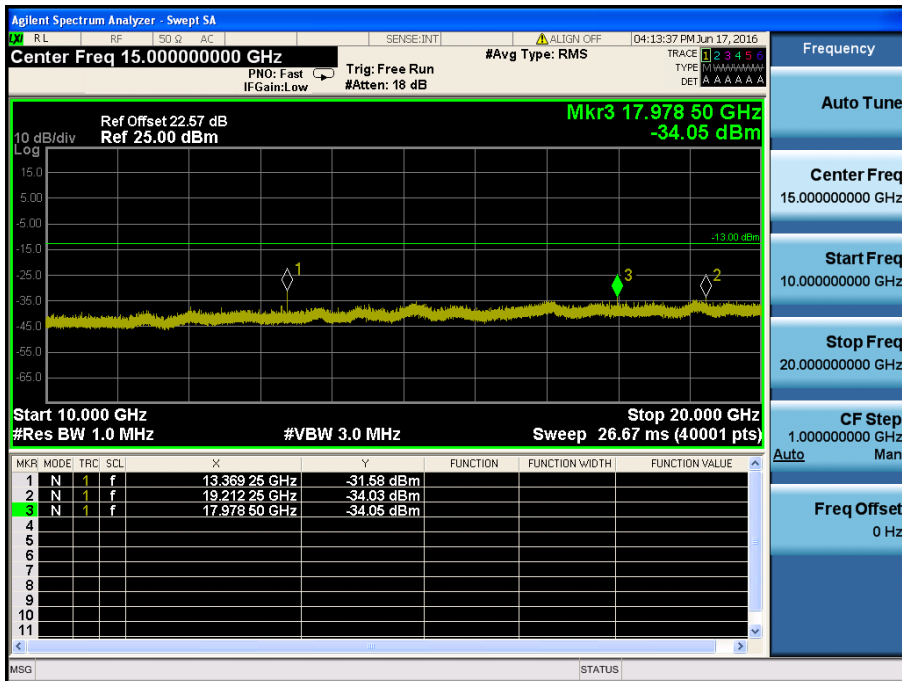

8.4 Band Edge

GPRS850 & Channel: 128

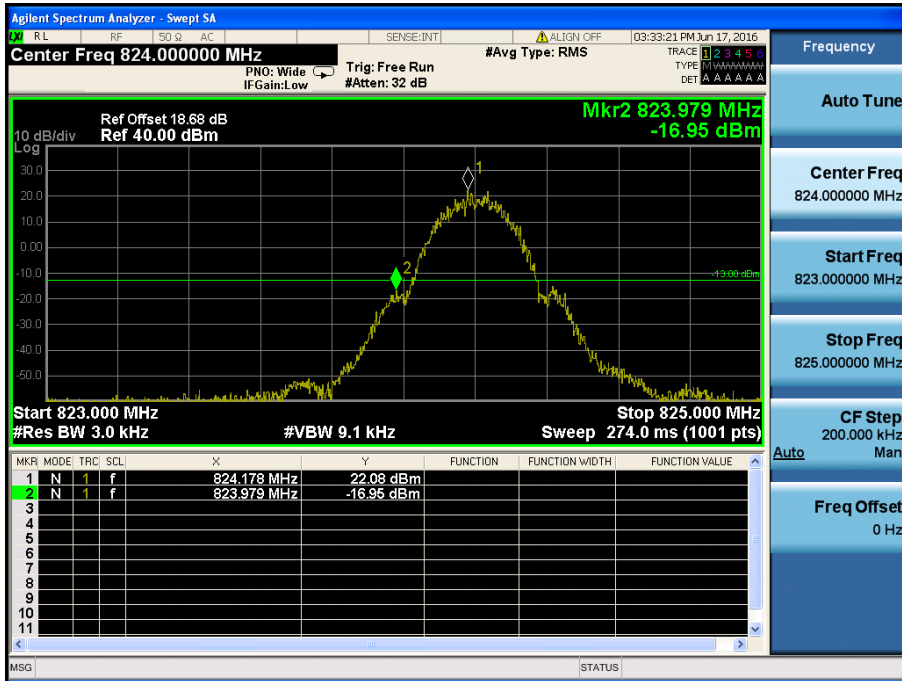

GPRS850 & Channel: 251

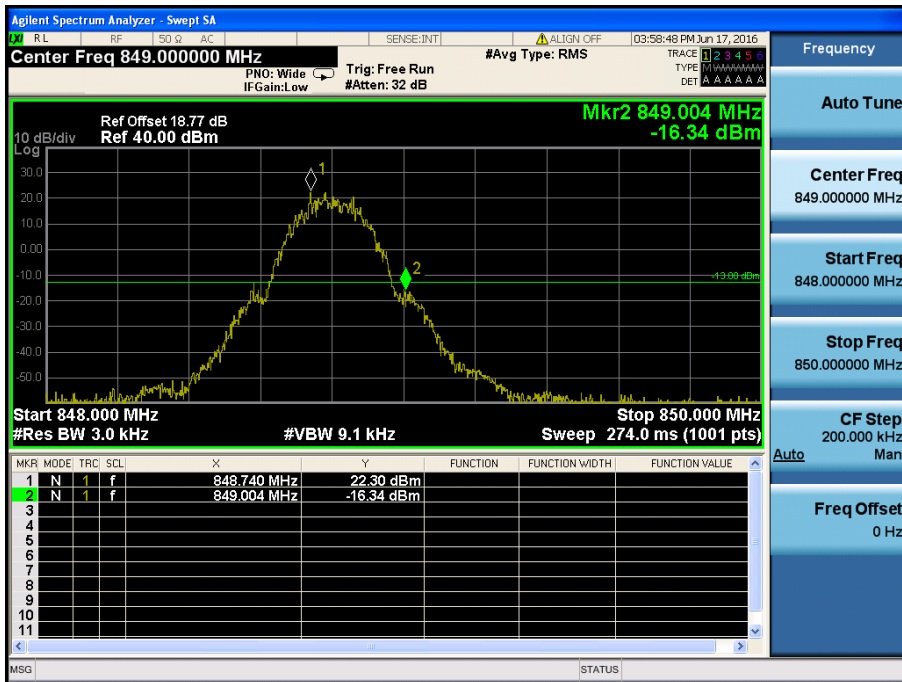

GPRS1900 & Channel: 512

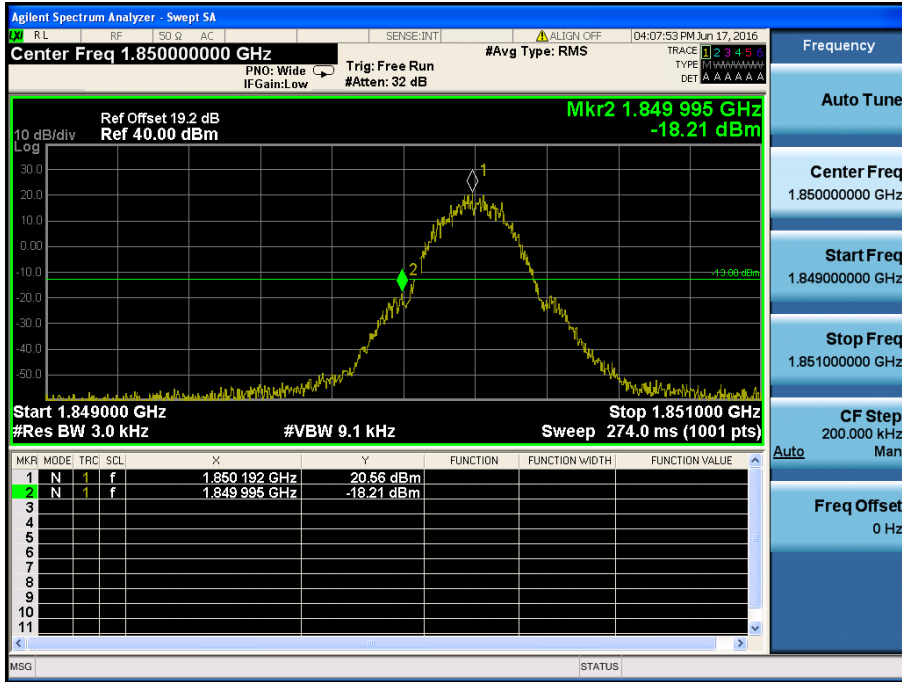

GPRS1900 & Channel: 810

