

## **ROGERS LABS, INC.**

4405 West 259<sup>th</sup> Terrace  
Louisburg, KS 66053  
Phone / Fax (913) 837-3214

# Application For Grant of Certification

Model: TDSPRMU1 (Aranet Radio Module)  
902-928 MHz (DTS) Hybrid Digital Transmission System

FCC ID: W9Z-ARANETRM

IC: 8855A-ARANETRM

**SAF Tehnika AS**

24a, Ganibu dambis  
Riga Latvia LV-1005

FCC Designation: US5305  
IC Test Site Registration: 3041A-1

Test Report Number: 191029

Test Date: October 29, 2019

Authorized Signatory: *Scot D. Rogers*

Scot D. Rogers  
Rogers Labs, Inc.  
4405 West 259<sup>th</sup> Terrace  
Louisburg, KS 66053  
Telephone/Facsimile: (913) 837-3214

This report shall not be reproduced except in full, without the written approval of the laboratory. This report must not be used by the client to claim product certification, approval, or endorsement by NVLAP, NIST, or any agency of the U.S. Government.

Rogers Labs, Inc.  
4405 W. 259th Terrace  
Louisburg, KS 66053  
Phone/Fax: (913) 837-3214  
Revision 1

SAF Tehnika AS  
Model: TDSPRMU1  
Test: 191029  
Test to: CFR47 15C, RSS-Gen RSS-247  
File: SAF TDSPRMU1 DTS TstRpt 191029 Page 1 of 47

S/N's: EUT1 / EUT2  
FCC ID: W9Z-ARANETRM  
IC: 8855A-ARANETRM  
Date: November 27, 2019

## Table of Contents

<b>TABLE OF CONTENTS.....</b>	<b>2</b>
<b>REVISIONS.....</b>	<b>4</b>
<b>FOREWORD.....</b>	<b>5</b>
<b>OPINION / INTERPRETATION OF RESULTS .....</b>	<b>5</b>
<b>EQUIPMENT TESTED.....</b>	<b>5</b>
<b>Equipment Function .....</b>	<b>6</b>
<b>Equipment Configuration.....</b>	<b>6</b>
<b>APPLICATION FOR CERTIFICATION.....</b>	<b>7</b>
<b>APPLICABLE STANDARDS &amp; TEST PROCEDURES .....</b>	<b>8</b>
<b>TESTING PROCEDURES .....</b>	<b>9</b>
<b>AC Line Conducted Emission Test Procedure .....</b>	<b>9</b>
<b>Radiated Emission Test Procedure.....</b>	<b>9</b>
<b>Antenna-Port Conducted Emission Test Procedure .....</b>	<b>9</b>
Diagram 1 Test arrangement for radiated emissions of tabletop equipment.....	10
Diagram 2 Test arrangement for radiated emissions tested on Open Area Test Site (OATS).....	11
Diagram 3 Test arrangement for Antenna Port Conducted emissions .....	12
<b>TEST SITE LOCATIONS .....</b>	<b>12</b>
<b>UNITS OF MEASUREMENTS .....</b>	<b>13</b>
<b>ENVIRONMENTAL CONDITIONS.....</b>	<b>13</b>
<b>STATEMENT OF MODIFICATIONS AND DEVIATIONS .....</b>	<b>13</b>
<b>LIST OF TEST EQUIPMENT .....</b>	<b>14</b>
<b>INTENTIONAL RADIATORS.....</b>	<b>15</b>

**Antenna Requirements .....15**

**Restricted Bands of Operation.....15**

Table 1 Harmonic Radiated Emissions in Restricted Bands M-Mode (Worst-case).....16

Table 2 Harmonic Radiated Emissions in Restricted Bands P-Mode (Worst-case) .....17

**Summary of Results for Radiated Emissions in Restricted Bands .....17**

**AC Line Conducted Emissions Procedure .....17**

**General Radiated Emissions Procedure .....18**

Table 3 General Radiated Emissions Data .....18

**Summary of Results for General Radiated Emissions .....19**

**Operation in the Band 902-928 MHz.....19**

Figure 1 Plot of Transmitter Emissions in Operational Frequency Band (M-Mode) .....21

Figure 2 Plot of Lower Band Edge (M-mode).....22

Figure 3 Plot of Upper Band Edge (M-mode) .....23

Figure 4 Plot of Transmitter 6-dB Occupied Bandwidth (M-mode).....24

Figure 5 Plot of Transmitter 99% Occupied Bandwidth (M-mode) .....25

Figure 6 Plot of Power Spectral Density (M-Mode).....26

Figure 7 Plot of Power Spectral Density (M-Mode).....27

Figure 8 Plot of Power Spectral Density (M-Mode).....28

Figure 9 Plot of Output Power (M-Mode).....28

Figure 10 Plot of Output Power (M-Mode).....29

Figure 11 Plot of Output Power (M-Mode).....29

Figure 12 Plot of Transmitter Emissions in Operational Frequency Band (P-Mode).....30

Figure 13 Plot of Lower Band Edge (P-mode).....31

Figure 14 Plot of Upper Band Edge (P-mode).....32

Figure 15 Plot of Transmitter 20-dB Occupied Bandwidth (P-mode).....33

Figure 16 Plot of Power Spectral Density (P-Mode).....	34
Figure 17 Plot of Power Spectral Density (P-Mode).....	35
Figure 18 Plot of Power Spectral Density (P-Mode).....	36
Figure 19 Plot of Channel Separation (P-mode).....	37
Figure 20 Plot of Output Power (P-Mode) .....	37
Figure 21 Plot of Output Power (P-Mode) .....	38
Figure 22 Plot of Output Power (P-Mode) .....	38
Figure 23 Plot of Out of Band Emissions .....	39
<b>Transmitter Emissions Data.....</b>	<b>40</b>
Table 4 Transmitter Radiated Emission M-mode Worst-case Data.....	40
Table 5 Transmitter Radiated Emission P-mode Worst-case Data.....	41
Table 6 Transmitter Antenna Port Data .....	42
<b>Summary of Results for Transmitter Radiated Emissions of Intentional Radiator .....</b>	<b>42</b>
<b>ANNEX.....</b>	<b>43</b>
Annex A Measurement Uncertainty Calculations.....	44
Annex B Additional Test Equipment.....	45
Annex C Rogers Qualifications .....	46
Annex D Laboratory Certificate of Accreditation.....	47

## Revisions

Revision 1 Issued November 27, 2019

## Foreword

The following information is submitted for consideration in obtaining Grant of Certification for License Exempt Hybrid Digital Transmission System Intentional Radiator operating under Code of Federal Regulations Title 47 (CFR 47) Paragraph 15.247 and Industry Canada RSS-GEN, Issue 5 and RSS-247 Issue 2, operation in the 902-928 MHz band.

Name of Applicant: SAF Tehnika AS  
 24a, Ganibu dambis  
 Riga Latvia LV-1005

M/N: TDSPRMU1 PMN: Aranet Radio Module  
 FCC ID: W9Z-ARANETRM IC: 8855A-ARANETRM  
 Frequency Range: 902.3-927.5 MHz  
 M-Mode, Output Power 0.030 W, 99% Occupied bandwidth 519.2 kHz  
 P-Mode, Output Power 0.031 W, 20-dB Occupied bandwidth 142.8 kHz

## Opinion / Interpretation of Results

Tests Performed	Margin (dB)	Results
Emissions 15.205, RSS-GEN	-33.1	Complies
Emissions as per CFR 47 paragraphs 2 and 15.207	N/A	Complies
Emissions as per CFR 47 paragraphs 2 and 15.209	-10.3	Complies
Harmonic Emissions per CFR 47 15.247	-26.6	Complies
Power Spectral Density per CFR 47 15.247	-6.3	Complies

## Equipment Tested

<u>Equipment</u>	<u>Model / PN</u>	<u>Serial Number</u>
EUT #1 (Integral Antenna)	TDSPRMU1	EUT1
EUT #2 (Antenna port connector)	TDSPRMU1	EUT2
Support Host	Development Board	

Test results in this report relate only to the items tested.

- Software version of “typical” TDSPRMU1: 92e19565c77b410285f7446588600697c5d68f67
- Software version of “modified for testing” TDSPRMU1:  
 b6780cbf28e9d71ff1957679ef6cfe938ec3ef21

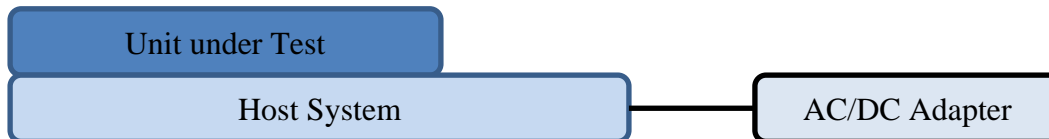
Rogers Labs, Inc. 4405 W. 259th Terrace Louisburg, KS 66053 Phone/Fax: (913) 837-3214 Revision 1	SAF Tehnika AS Model: TDSPRMU1 Test: 191029 Test to: CFR47 15C, RSS-Gen RSS-247 File: SAF TDSPRMU1 DTS TstRpt 191029 Page 5 of 47	S/N's: EUT1 / EUT2 FCC ID: W9Z-ARANETRM IC: 8855A-ARANETRM Date: November 27, 2019
--	---	---

## Equipment Function

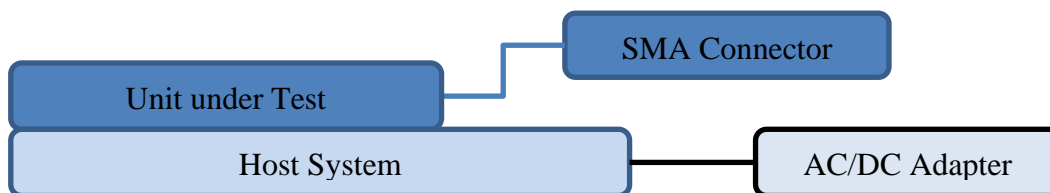
The EUT is a Radio Transceiver Module providing operational capabilities across the 902-928 MHz band offering wireless data transfer. The module was tested as a Hybrid Digital Transmission System employing a combination of both frequency hopping and digital modulation techniques. The test samples provided capability to operate in two modes, either M-mode (500 kHz) or P-mode (125 kHz) as described by the manufacturer. Operation in the M-mode operates as a Digital Modulation Transmission System and the P-Mode employs a combination of both frequency hopping and Digital Modulation Techniques. Each operational mode was tested for compliance as documented in this report. The module operates from Direct Current (DC) Power supplied the host system and offers no provision for alternate power source. The host system provided operational interface tot the radio module for testing. The host system contained a push button which was programed to advance through the operational channels and modes. Power was applied to the host system though a USB interface cable and AC/DC power adapter. The test software provided operation of the transmitter at 100% duty cycle in each mode for testing. The equipment was tested for emissions compliance using the available configurations with the worst-case data presented. Test results in this report relate only to the products described in this report.

## Equipment Configuration

- 1) Module operating as designed with integral antenna on support host board



- 2) Modified Unit providing connection to antenna port on support host board



## Application for Certification

- (1) Manufacturer: SAF Tehnika AS  
24a, Ganibu dambis  
Riga Latvia LV-1005
- (2) Identification: M/N: TDSPRMU1  
FCC ID: W9Z-ARANETRM IC: 8855A-ARANETRM
- (3) Instruction Book:  
Refer to Exhibit for Instruction Manual.
- (4) Description of Circuit Functions:  
Refer to Exhibit of Operational Description.
- (5) Block Diagram with Frequencies:  
Refer to Exhibit of Operational Description.
- (6) Report of Measurements:  
Report of measurements follows in this Report.
- (7) Photographs: Construction, Component Placement, etc.:  
Refer to Exhibit for photographs of equipment.
- (8) List of Peripheral Equipment Necessary for operation. The equipment operates from direct current power supplied from host system and provides no other interface options as presented in this filing. The EUT offers no other connection ports than those presented in this filing.
- (9) Transition Provisions of CFR47 15.37 are not requested.
- (10) Not Applicable. The unit is not a scanning receiver.
- (11) Not Applicable. The EUT does not operate in the 59 – 64 GHz frequency band.
- (12) The equipment is not software defined and this section is not applicable.
- (13) Applications for certification of U-NII devices in the 5.15-5.35 GHz and the 5.47-5.85 GHz bands must include a high-level operational description of the security procedures that control the radio frequency operating parameters and ensure that unauthorized modifications cannot be made. This requirement is not applicable to his DTS device.
- (14) Contain at least one drawing or photograph showing the test set-up for each of the required types of tests applicable to the device for which certification is requested. These drawings or photographs must show enough detail to confirm other information contained in the test report. Any photographs used must be focused originals without glare or dark spots and must clearly show the test configuration used. This information is provided in this report and Test Setup Exhibits provided with the application filing.

## Applicable Standards & Test Procedures

The following information is submitted in accordance with the eCFR Federal Communications Code of Federal Regulations, dated October 29, 2019, Part 2, Subpart J, Paragraphs 2.907, 2.911, 2.913, 2.925, 2.926, 2.1031 through 2.1057, and applicable parts of paragraph 15, Part 15C Paragraph 15.247, and Industry Canada RSS-247 Issue 2, and RSS-GEN Issue 5. This equipment operates as Hybrid Digital Transmission System. Hybrid systems are those that employ a combination of both frequency hopping and digital modulation techniques. The frequency hopping operation of the hybrid system, with the direct sequence or digital modulation operation turned-off, provides an average time of occupancy on any frequency not exceeding 0.4 seconds within a time period in seconds equal to the number of hopping frequencies employed multiplied by 0.4. The power spectral density conducted from the intentional radiator to the antenna due to the digital modulation operation of the hybrid system, with the frequency hopping operation turned off, remains below the 8 dBm in any 3-kHz band during any time interval of continuous transmission. Test procedures used are as defined in 558074 D01 15.247 Meas Guidance v05r02 and ANSI C63.10-2013.



## **Testing Procedures**

### ***AC Line Conducted Emission Test Procedure***

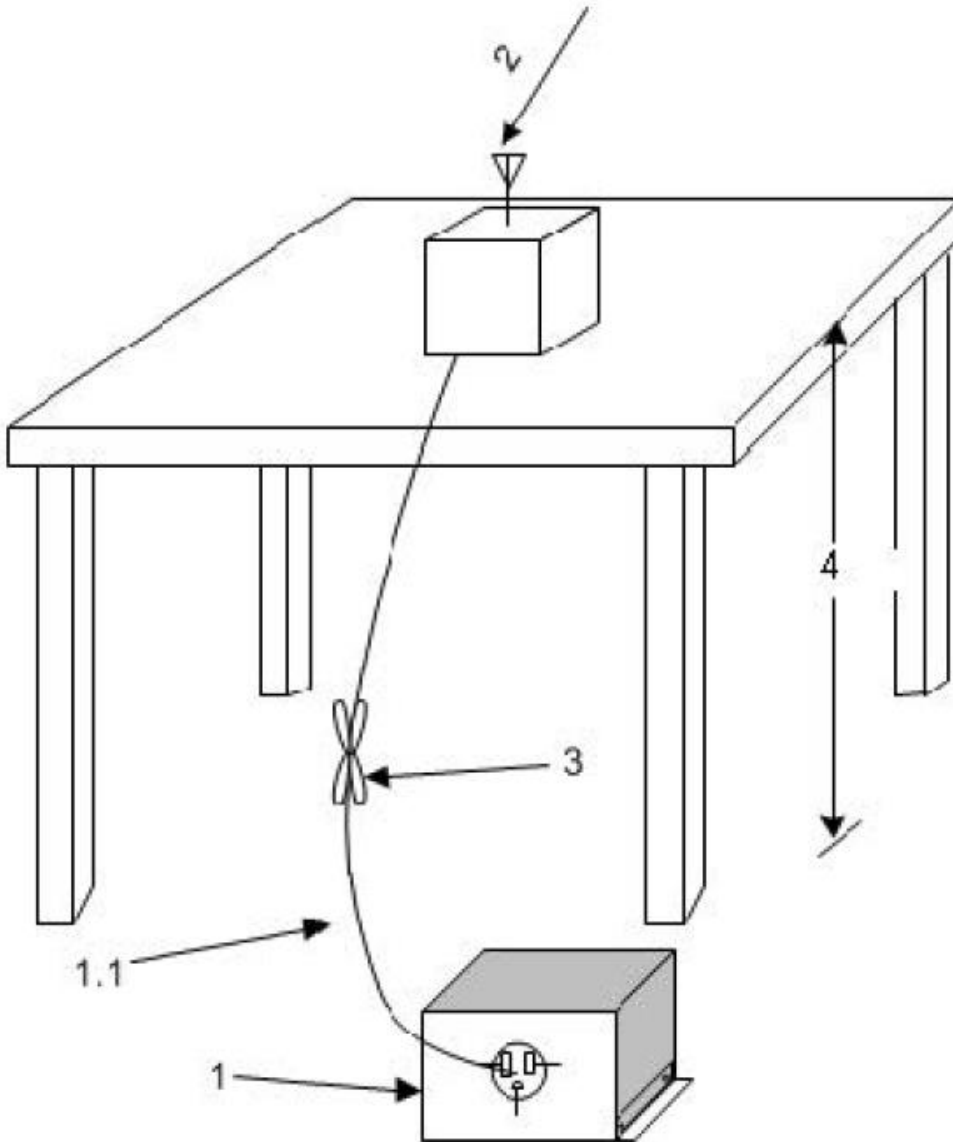
The design operates solely from direct current power provided from host system. The design offers no provision connection with Utility AC power system and therefore is exempt from AC Line conducted emissions testing.

### ***Radiated Emission Test Procedure***

Radiated emissions testing was performed as required in CFR47 15, RSS-247 and specified in ANSI C63.10-2013. The EUT was placed on a rotating 0.9 x 1.2-meter platform, elevated as required above the ground plane at a distance of 3 meters from the FSM antenna. EMI energy was maximized by equipment placement permitting orientation in three orthogonal axes, raising and lowering the FSM antenna, changing the antenna polarization, and by rotating the turntable. Each emission was maximized before data was taken using a spectrum analyzer. The frequency spectrum from 9 kHz to 25,000 MHz was searched for during preliminary investigation. Refer to diagrams one and two showing typical test arrangement and photographs in the test setup exhibits for specific EUT placement during testing.

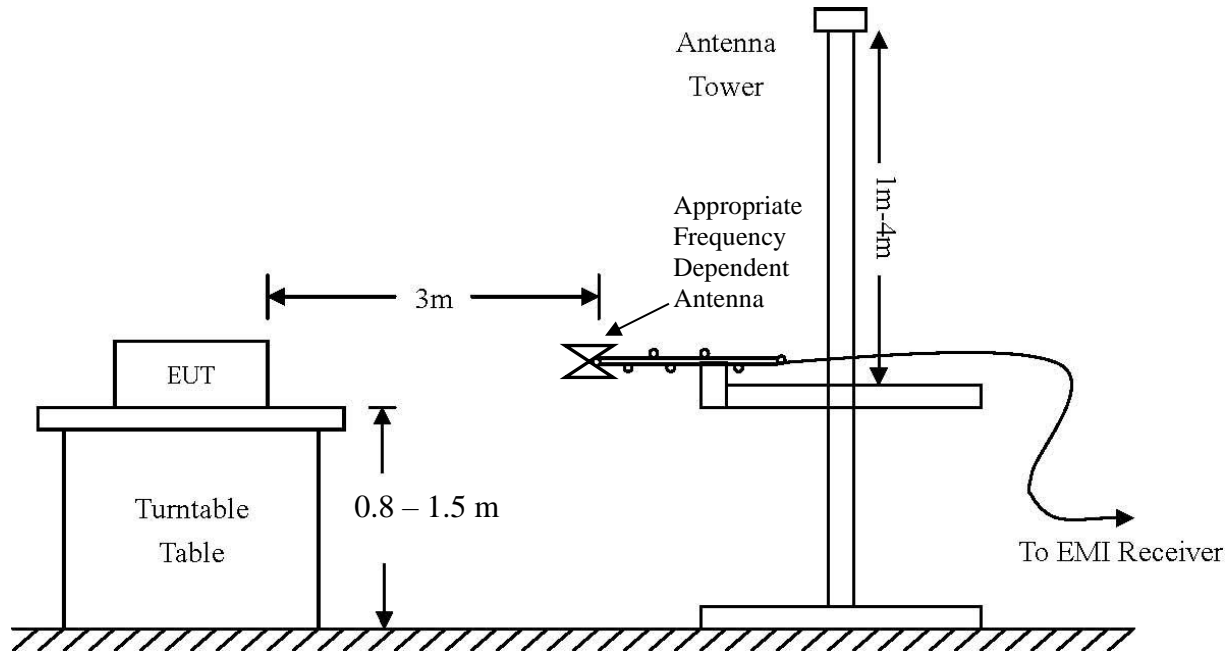
### ***Antenna-Port Conducted Emission Test Procedure***

The EUT was assembled as required for operation placed on a benchtop. This configuration provided the ability to connect test equipment to the provided test antenna port. Antenna Port conducted emissions testing was performed presented in the regulations and specified in ANSI C63.10-2013. Testing was completed on a laboratory bench in a shielded room. The active antenna port of the device was connected to appropriate attenuation and the spectrum analyzer. Refer to diagram three showing typical test arrangement and photographs in the test setup exhibits for specific EUT placement during testing.



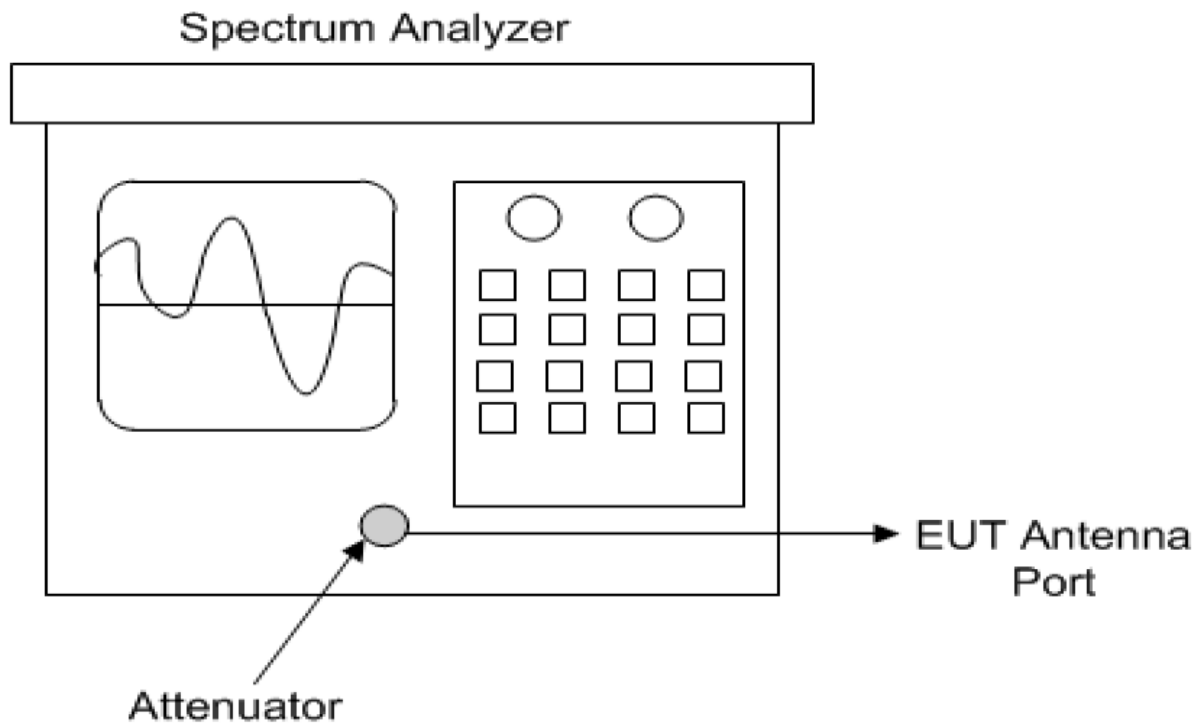
1. A LISN is optional for radiated measurements between 30 MHz and 1000 MHz but not allowed for measurements below 30 MHz and above 1000 MHz (see 6.3.1). If used, then connect EUT to one LISN. Unused LISN measuring port connectors shall be terminated in 50Ω loads. The LISN may be placed on top of, or immediately beneath, the reference ground plane (see 6.2.2 and 6.2.3.2).
- 1.1—LISN spaced at least 80 cm from the nearest part of the EUT chassis.
2. Antenna can be integral or detachable, depending on the EUT (see 6.3.1).
3. Interconnecting cables that hang closer than 40 cm to the ground plane shall be folded back and forth in the center forming a bundle 30 cm to 40 cm long (see 6.3.1).
4. For emission measurements at or below 1 GHz, the table height shall be 80 cm. For emission measurements above 1 GHz, the table height shall be 1.5 m for measurements, except as otherwise specified (see 6.3.1 and 6.6.3.1).

**Diagram 1 Test arrangement for radiated emissions of tabletop equipment**



AC Line Conducted Emissions (0.150 -30 MHz)		
RBW	AVG. BW	Detector Function
9 kHz	30 kHz	Peak / Quasi Peak
Emissions (30-1000 MHz)		
RBW	AVG. BW	Detector Function
120 kHz	300 kHz	Peak / Quasi Peak
Emissions (Above 1000 MHz)		
RBW	Video BW	Detector Function
100 kHz	100 kHz	Peak
1 MHz	1 MHz	Peak / Average

**Diagram 2 Test arrangement for radiated emissions tested on Open Area Test Site (OATS)**



**Diagram 3 Test arrangement for Antenna Port Conducted emissions**

### Test Site Locations

Conducted EMI AC line conducted emissions testing performed in a shielded screen room located at Rogers Labs, Inc., 4405 West 259<sup>th</sup> Terrace, Louisburg, KS

Antenna port Antenna port conducted emissions testing was performed in a shielded screen room located at Rogers Labs, Inc., 4405 West 259<sup>th</sup> Terrace, Louisburg, KS

Radiated EMI The radiated emissions tests were performed at the 3 meters, Open Area Test Site (OATS) located at Rogers Labs, Inc., 4405 West 259<sup>th</sup> Terrace, Louisburg, KS

Registered Site information: FCC Site: US5305, ISED: 3041A, CAB Identifier: US0096

NVLAP Accreditation Lab code 200087-0

## Units of Measurements

Conducted EMI            Data presented in dB $\mu$ V; dB referenced to one microvolt

Antenna port Conducted            Data is in dBm; dB referenced to one milliwatt

Radiated EMI            Data presented in dB $\mu$ V/m; dB referenced to one microvolt per meter

Note: Radiated limit may be expressed for measurement in dB $\mu$ V/m when the measurement is taken at a distance of 3 or 10 meters. Data taken for this report was taken at distance of 3 meters. Sample calculation demonstrates corrected field strength reading for Open Area Test Site using the measurement reading and correcting for receive antenna factor, cable losses, and amplifier gains.

Sample Calculation:

RFS = Radiated Field Strength, FSM = Field Strength Measured

A.F. = Receive antenna factor, Losses = attenuators/cable losses, Gain = amplification gains

$RFS (dB\mu V/m @ 3m) = FSM (dB\mu V) + A.F. (dB/m) + Losses (dB) - Gain (dB)$

## Environmental Conditions

Ambient Temperature            21.5° C

Relative Humidity            33%

Atmospheric Pressure            1022.8 mb

## Statement of Modifications and Deviations

No modifications to the EUT were required for the unit to demonstrate compliance with the CFR47 Part 15C, RSS-Gen, and RSS-247 emission requirements. There were no deviations to the specifications.

## List of Test Equipment

<u>Equipment</u>	<u>Manufacturer</u>	<u>Model (SN)</u>	<u>Band</u>	<u>Cal Date(m/d/y)</u>	<u>Due</u>
<input type="checkbox"/> LISN	FCC	FCC-LISN-50-25-10(1PA) (160611)	.15-30MHz	4/18/2019	4/18/2020
<input type="checkbox"/> LISN	Compliance Design	FCC-LISN-2.Mod.cd,(126)	.15-30MHz	10/14/2019	10/14/2020
<input checked="" type="checkbox"/> Cable	Huber & Suhner Inc.	Sucoflex102ea(L10M)(303073)	9kHz-40 GHz	10/14/2019	10/14/2020
<input checked="" type="checkbox"/> Cable	Huber & Suhner Inc.	Sucoflex102ea(1.5M)(303069)	9kHz-40 GHz	10/14/2019	10/14/2020
<input checked="" type="checkbox"/> Cable	Huber & Suhner Inc.	Sucoflex102ea(1.5M)(303071)	9kHz-40 GHz	10/14/2019	10/14/2020
<input type="checkbox"/> Cable	Belden	RG-58 (L1-CAT3-11509)	9kHz-30 MHz	10/14/2019	10/14/2020
<input type="checkbox"/> Cable	Belden	RG-58 (L2-CAT3-11509)	9kHz-30 MHz	10/14/2019	10/14/2020
<input checked="" type="checkbox"/> Antenna	Com Power	AL-130 (121055)	.001-30 MHz	10/14/2019	10/14/2020
<input type="checkbox"/> Antenna:	EMCO 6509			10/16/2018	10/16/2020
<input type="checkbox"/> Antenna	ARA	BCD-235-B (169)	20-350MHz	10/14/2019	10/14/2020
<input type="checkbox"/> Antenna:	Schwarzbeck Model: BBA 9106/VHBB 9124 (9124-627)			4/18/2019	4/18/2021
<input checked="" type="checkbox"/> Antenna	Sunol	JB-6 (A100709)	30-1000 MHz	10/14/2019	10/14/2020
<input type="checkbox"/> Antenna	ETS-Lindgren	3147 (40582)	200-1000MHz	10/14/2019	10/14/2020
<input type="checkbox"/> Antenna:	Schwarzbeck Model: VULP 9118 A (VULP 9118 A-534)			4/18/2019	4/18/2021
<input checked="" type="checkbox"/> Antenna	ETS-Lindgren	3117 (200389)	1-18 GHz	5/02/2019	5/2/2020
<input type="checkbox"/> Antenna	Com Power	AH-118 (10110)	1-18 GHz	10/14/2019	10/14/2020
<input type="checkbox"/> Antenna	Com Power	AH-840 (101046)	18-40 GHz	4/18/2019	4/18/2021
<input checked="" type="checkbox"/> Analyzer	Rohde & Schwarz	ESU40 (100108)	20Hz-40GHz	4/18/2019	4/18/2020
<input checked="" type="checkbox"/> Analyzer	Rohde & Schwarz	ESW44 (101534)	20Hz-44GHz	1/31/2019	1/31/2020
<input type="checkbox"/> Analyzer	Rohde & Schwarz	FS-Z60, 90, 140, and 220	40GHz-220GHz	12/22/2017	12/22/2027
<input checked="" type="checkbox"/> Amplifier	Com-Power	PA-010 (171003)	100Hz-30MHz	10/14/2019	10/14/2020
<input checked="" type="checkbox"/> Amplifier	Com-Power	CPPA-102 (01254)	1-1000 MHz	10/14/2019	10/14/2020
<input checked="" type="checkbox"/> Amplifier	Com-Power	PAM-118A (551014)	0.5-18 GHz	10/14/2019	10/14/2020
<input type="checkbox"/> Amplifier	Com-Power	PAM-840A (461328)	18-40 GHz	10/14/2019	10/14/2020
<input checked="" type="checkbox"/> Power Meter	Agilent	N1911A with N1921A	0.05-40 GHz	4/18/2019	4/18/2020
<input type="checkbox"/> Generator	Rohde & Schwarz	SMB100A6 (100150)	20Hz-6 GHz	4/18/2019	4/18/2020
<input type="checkbox"/> Generator	Rohde & Schwarz	SMBV100A6 (260771)	20Hz-6 GHz	4/18/2019	4/18/2020
<input type="checkbox"/> RF Filter	Micro-Tronics	BRC50722 (009).9G notch	30-1800 MHz	4/18/2019	4/18/2020
<input type="checkbox"/> RF Filter	Micro-Tronics	HPM50114 (017)1.5G HPF	30-18000 MHz	4/18/2019	4/18/2020
<input type="checkbox"/> RF Filter	Micro-Tronics	HPM50117 (063) 3G HPF	30-18000 MHz	4/18/2019	4/18/2020
<input type="checkbox"/> RF Filter	Micro-Tronics	HPM50105 (059) 6G HPF	30-18000 MHz	4/18/2019	4/18/2020
<input type="checkbox"/> RF Filter	Micro-Tronics	BRM50702 (172) 2G notch	30-1800 MHz	4/18/2019	4/18/2020
<input type="checkbox"/> RF Filter	Micro-Tronics	BRC50703 (G102) 5G notch	30-1800 MHz	4/18/2019	4/18/2020
<input type="checkbox"/> RF Filter	Micro-Tronics	BRC50705 (024) 5G notch	30-1800 MHz	4/18/2019	4/18/2020
<input type="checkbox"/> Attenuator	Fairview	SA6NFNF100W-40 (1625)	30-1800 MHz	4/18/2019	4/18/2020
<input checked="" type="checkbox"/> Attenuator	Mini-Circuits	VAT-3W2+ (1436)	30-6000 MHz	4/18/2019	4/18/2020
<input type="checkbox"/> Attenuator	Mini-Circuits	VAT-3W2+ (1445)	30-6000 MHz	4/18/2019	4/18/2020
<input type="checkbox"/> Attenuator	Mini-Circuits	VAT-3W2+ (1735)	30-6000 MHz	4/18/2019	4/18/2020
<input type="checkbox"/> Attenuator	Mini-Circuits	VAT-6W2+ (1438)	30-6000 MHz	4/18/2019	4/18/2020
<input type="checkbox"/> Attenuator	Mini-Circuits	VAT-6W2+ (1736)	30-6000 MHz	4/18/2019	4/18/2020
<input checked="" type="checkbox"/> Weather station	Davis	6312 (A81120N075)		10/26/2018	10/26/2019

Rogers Labs, Inc.  
4405 W. 259th Terrace  
Louisburg, KS 66053  
Phone/Fax: (913) 837-3214  
Revision 1

SAF Tehnika AS  
Model: TDSPRMU1  
Test: 191029  
Test to: CFR47 15C, RSS-Gen RSS-247  
File: SAF TDSPRMU1 DTS TstRpt 191029 Page 14 of 47

S/N's: EUT1 / EUT2  
FCC ID: W9Z-ARANETRM  
IC: 8855A-ARANETRM  
Date: November 27, 2019

## **Intentional Radiators**

The following information is submitted in support demonstration of compliance with the requirements of CFR47, Subpart C, paragraph 15.247 and Industry Canada RSS-247 and RSS-Gen the following information is submitted.

### ***Antenna Requirements***

The EUT incorporates integral antenna system and offers no provision for connection to alternate antenna system. The antenna connection point complies with the unique antenna connection requirements. There are no deviations or exceptions to the specification.

### ***Restricted Bands of Operation***

Spurious emissions falling in the restricted frequency bands of operation were measured at the OATS. The EUT utilizes frequency, determining circuitry, which generates harmonics falling in the restricted bands. Emissions were investigated at the OATS, using appropriate antennas or pyramidal horns, amplification stages, and a spectrum analyzer. Peak and average amplitudes of frequencies above 1000 MHz were compared to the required limits with worst-case data presented below. Test procedures of ANSI C63.10-2013 paragraph 6 and KDB 558074 paragraph 12 were used during testing. No other significant emission was observed which fell into the restricted bands of operation. Computed emission values consider the received radiated field strength, receive antenna correction factor, amplifier gain stage, and test system cable losses.

**Table 1 Harmonic Radiated Emissions in Restricted Bands M-Mode (Worst-case)**

Frequency in MHz	Horizontal Peak (dBµV/m)	Horizontal Average (dBµV/m)	Vertical Peak (dBµV/m)	Vertical Average (dBµV/m)	Limit @ 3m (dBµV/m)	Horizontal Average Margin (dB)	Vertical Average Margin (dB)
2709.6	48.3	16.6	46.8	13.8	54.0	-37.4	-40.2
2745.6	49.0	17.7	46.2	13.4	54.0	-36.3	-40.6
2781.6	48.8	17.4	46.2	12.0	54.0	-36.6	-42.0
3612.8	42.6	7.1	42.7	7.1	54.0	-46.9	-46.9
3660.8	45.5	9.4	45.1	9.4	54.0	-44.6	-44.6
3708.8	44.2	8.4	44.0	8.4	54.0	-45.6	-45.6
4516.0	48.6	10.9	46.7	10.9	54.0	-43.1	-43.1
4576.0	44.0	8.7	44.8	8.7	54.0	-45.3	-45.3
4636.0	47.0	10.9	47.3	10.9	54.0	-43.1	-43.1

Other emissions present had amplitudes at least 20 dB below the limit. Peak and Quasi-Peak amplitude emissions are recorded for frequency below 1000 MHz. Peak and Average amplitude emissions are recorded for frequency range above 1000 MHz.



**Table 2 Harmonic Radiated Emissions in Restricted Bands P-Mode (Worst-case)**

Frequency in MHz	Horizontal Peak (dBμV/m)	Horizontal Average (dBμV/m)	Vertical Peak (dBμV/m)	Vertical Average (dBμV/m)	Limit @ 3m (dBμV/m)	Horizontal Average Margin (dB)	Vertical Average Margin (dB)
2706.9	48.4	20.2	46.5	15.9	54.0	-33.8	-38.1
2745.3	48.9	20.9	46.6	16.3	54.0	-33.1	-37.7
2782.5	49.5	20.6	46.1	14.4	54.0	-33.4	-39.6
3609.2	43.8	7.2	43.1	7.3	54.0	-46.8	-46.7
3660.4	45.4	9.4	45.1	9.4	54.0	-44.6	-44.6
3710.0	43.9	8.4	44.0	8.4	54.0	-45.6	-45.6
4511.5	46.7	11.0	47.1	11.0	54.0	-43.0	-43.0
4575.5	44.5	8.6	44.5	8.6	54.0	-45.4	-45.4
4637.5	46.3	10.5	46.5	10.7	54.0	-43.5	-43.3

Other emissions present had amplitudes at least 20 dB below the limit. Peak and Quasi-Peak amplitude emissions are recorded for frequency below 1000 MHz. Peak and Average amplitude emissions are recorded for frequency range above 1000 MHz.

### **Summary of Results for Radiated Emissions in Restricted Bands**

The EUT demonstrated compliance with the radiated emissions requirements of CFR 47 Part 15C RSS-Gen, and RSS-247 Intentional Radiators. The EUT demonstrated a worst-case minimum radiated emission in restricted bands providing a minimum margin of -33.1 dB below the radiated emissions requirements. Peak and average amplitudes were checked for compliance with the regulations. Worst-case emissions are reported with other emissions found in the restricted frequency bands at least 20 dB below the requirements.

### **AC Line Conducted Emissions Procedure**

The design operates solely from direct current power provided from replaceable AAA batteries. The design offers no provision for connection with the Utility AC power system and therefore is exempt from AC Line conducted emissions testing.

### General Radiated Emissions Procedure

The EUT was arranged in a typical equipment configuration and operated through all available mode during testing. Preliminary testing was performed in a screen room with the EUT positioned 1 meter from the FSM. Radiated emissions measurements were performed to identify the frequencies, which produced the highest emissions. Each radiated emission was then maximized at the OATS location before final radiated measurements were performed. Final data was taken with the EUT located on the OATS at 3 meters distance between the EUT and the receiving antenna. The frequency spectrum from 9 kHz to 10,000 MHz was searched for general radiated emissions. Measured emission levels were maximized by EUT placement on the table, rotating the turntable through 360 degrees, varying the antenna height between 1 and 4 meters above the ground plane and changing antenna position between horizontal and vertical polarization. Antennas used were Loop from 9 kHz to 30 MHz, Broadband Biconical from 30 to 200 MHz, Biconilog from 30 to 1000 MHz, Log Periodic from 200 MHz to 1 GHz and or double Ridge or pyramidal horns and mixers above 1 GHz, notch filters and appropriate amplifiers and external mixers were utilized.

**Table 3 General Radiated Emissions Data**

Frequency in MHz	Horizontal Peak (dB $\mu$ V/m)	Horizontal Quasi-Peak (dB $\mu$ V/m)	Vertical Peak (dB $\mu$ V/m)	Vertical Quasi-Peak (dB $\mu$ V/m)	Limit @ 3m (dB $\mu$ V/m)	Horizontal Average Margin (dB)	Vertical Average Margin (dB)
40.0	32.5	27.0	33.4	29.7	40.0	-13.0	-10.3
56.0	27.4	22.5	30.1	25.8	40.0	-17.5	-14.2
72.0	29.1	24.1	29.2	24.8	40.0	-15.9	-15.2
72.0	32.3	22.9	27.0	22.7	40.0	-17.1	-17.3
80.0	33.1	25.4	28.9	21.4	40.0	-14.6	-18.6
120.0	28.9	20.3	35.7	26.3	40.0	-19.7	-13.7
136.0	30.4	24.5	28.7	21.9	40.0	-15.5	-18.1
432.0	32.5	26.6	29.1	23.5	47.0	-20.4	-23.5

Other emissions present had amplitudes at least 20 dB below the limit. Peak and Quasi-Peak amplitude emissions are recorded for frequency range below 1000 MHz. Peak and Average amplitude emissions are recorded for frequency range above 1000 MHz.

## **Summary of Results for General Radiated Emissions**

The EUT demonstrated compliance with the radiated emissions requirements of CFR47 Part 15C paragraph 15.209, RSS-247 and RSS-GEN Intentional Radiators. The EUT demonstrated a minimum margin of -10.3 dB below the requirements. Other emissions were present with amplitudes at least 20 dB below the Limits.

## **Operation in the Band 902-928 MHz**

This device provides operation as hybrid Digital Transmission System. The requirements and demonstration of compliance with RSS-247 and CFR47 subpart 15.247 are addressed below as specified in KDB 558074 D01 15.247 Meas Guidance v05r02.

Information from KDB 558074 D01 15.247 Meas Guidance v05r02

### **10. HYBRID SYSTEM EQUIPMENT UNDER SECTION 15.247**

The following information is for certification of hybrid spread-spectrum devices under Section 15.247.

- a) Use Form-731 equipment-class code DSS.
- b) Hybrid system device measurement guidelines are as follows.
  - 1) As specified in Section 15.247(f), a hybrid system must comply with the power density standard of 8 dBm in any 3 kHz band when the frequency hopping function is turned off.
  - 2) The transmission must comply with a 0.4 second/channel maximum dwell time when the hopping function is turned on.
  - 3) There is no requirement for this type of hybrid system to comply with the 500 kHz minimum bandwidth normally associated with a DTS device.
  - 4) There is no minimum number of hopping channels associated with this type of hybrid system. While there is not a specific minimum limit, the hop sequence is required to appear as pseudorandom per Section 15.247(a)(1) (see Section 3 of this document).
  - 5) The hopping function must be a true frequency hopping system, as described in Section 15.247(a)(1). The specific requirements in Section 15.247(a)(1) are:
    - i) a minimum channel separation;
    - ii) pseudo-random hop sequence;
    - iii) equal use of each frequency; and
    - iv) receiver matching bandwidth and synchronization.
  - 6) Generally, use the test procedures for DTS and FHSS devices in Clause 11 and 7.8 of ANSI C63.10, respectively.
    - i) Output power: use 11.9 of ANSI C63.10;
    - ii) Peak Power Density: use 11.10 of ANSI C63.10;
    - iii) Carrier channel separation: use 7.8.2 of ANSI C63.10;
    - iv) Dwell time: use 7.8.4 of ANSI C63.10.

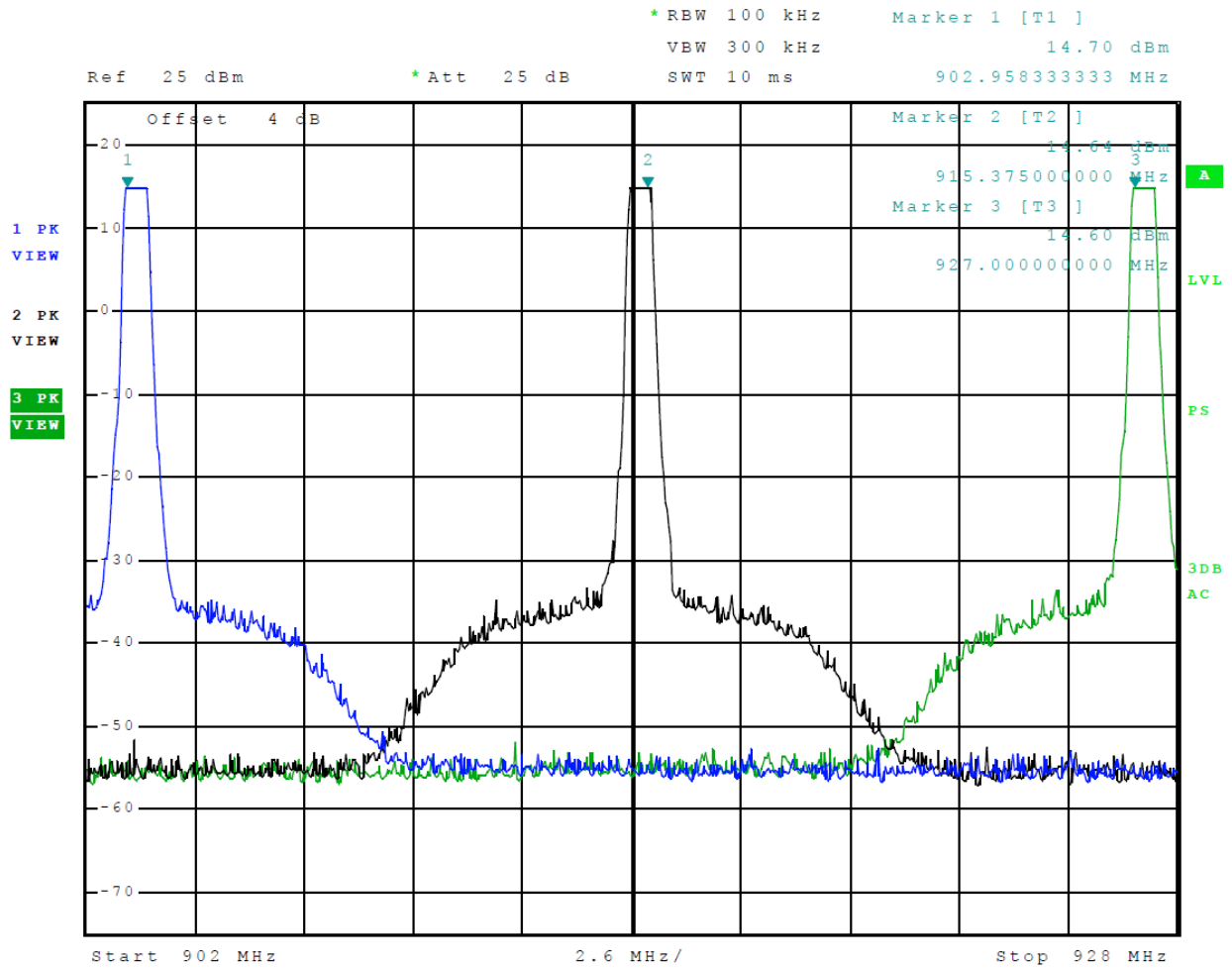
Compliance for operation as Digital Modulation System addresses the 6-dB DTS bandwidth, output power, power spectral density, and emissions in 100 kHz bands. Plots demonstrating

compliance with DTS requirements are presented in figures one through eleven and data in tables 4 and 6.

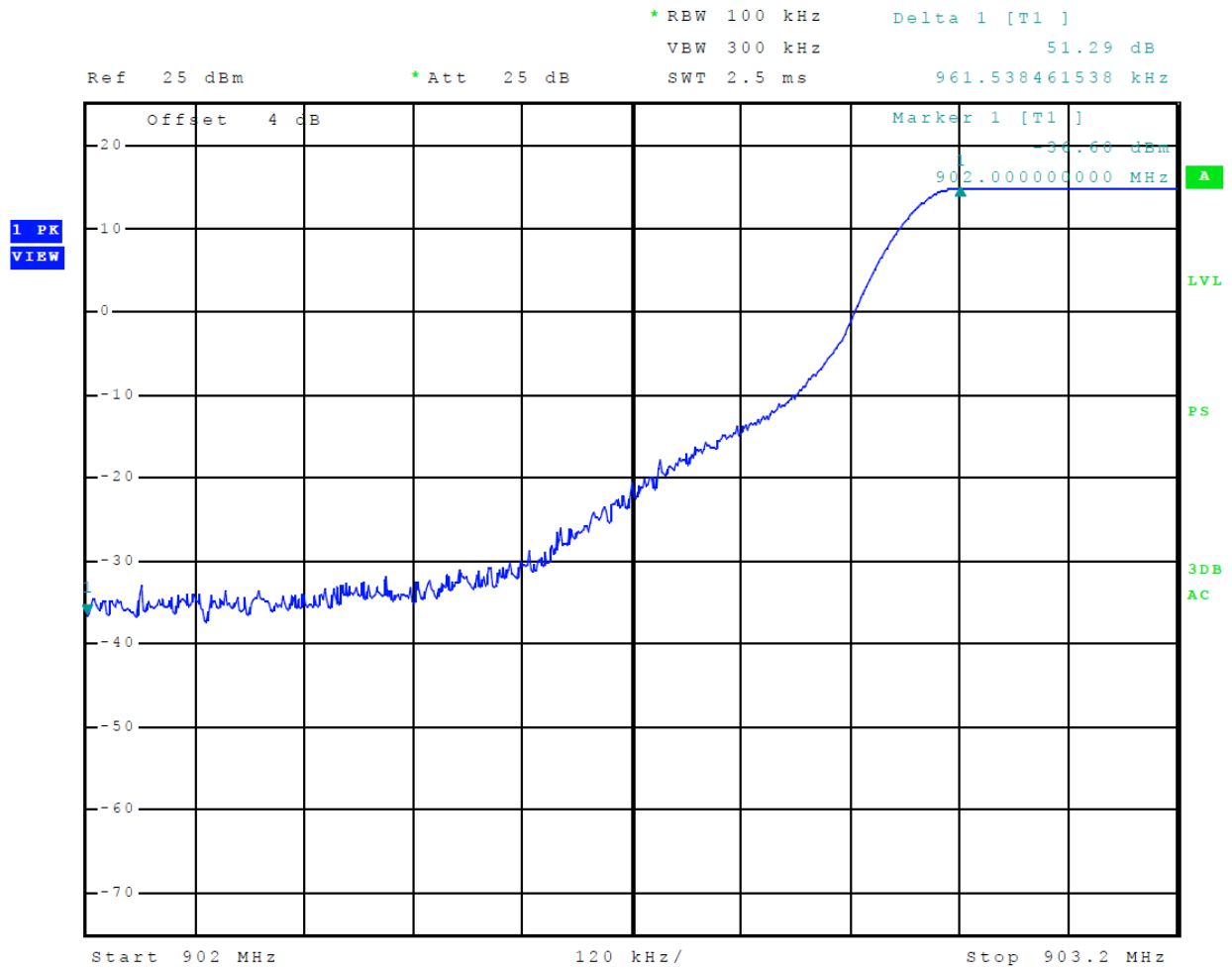
Compliance for Hybrid operation addresses 0.4 second/channel maximum dwell time, minimum channel separation, Pseudo-random hop sequence, equal use of frequency, receiver bandwidth matching and synchronization.

Plots demonstrating compliance with these requirements are presented in figures twelve through twenty-three and data in tables 5 and 6.

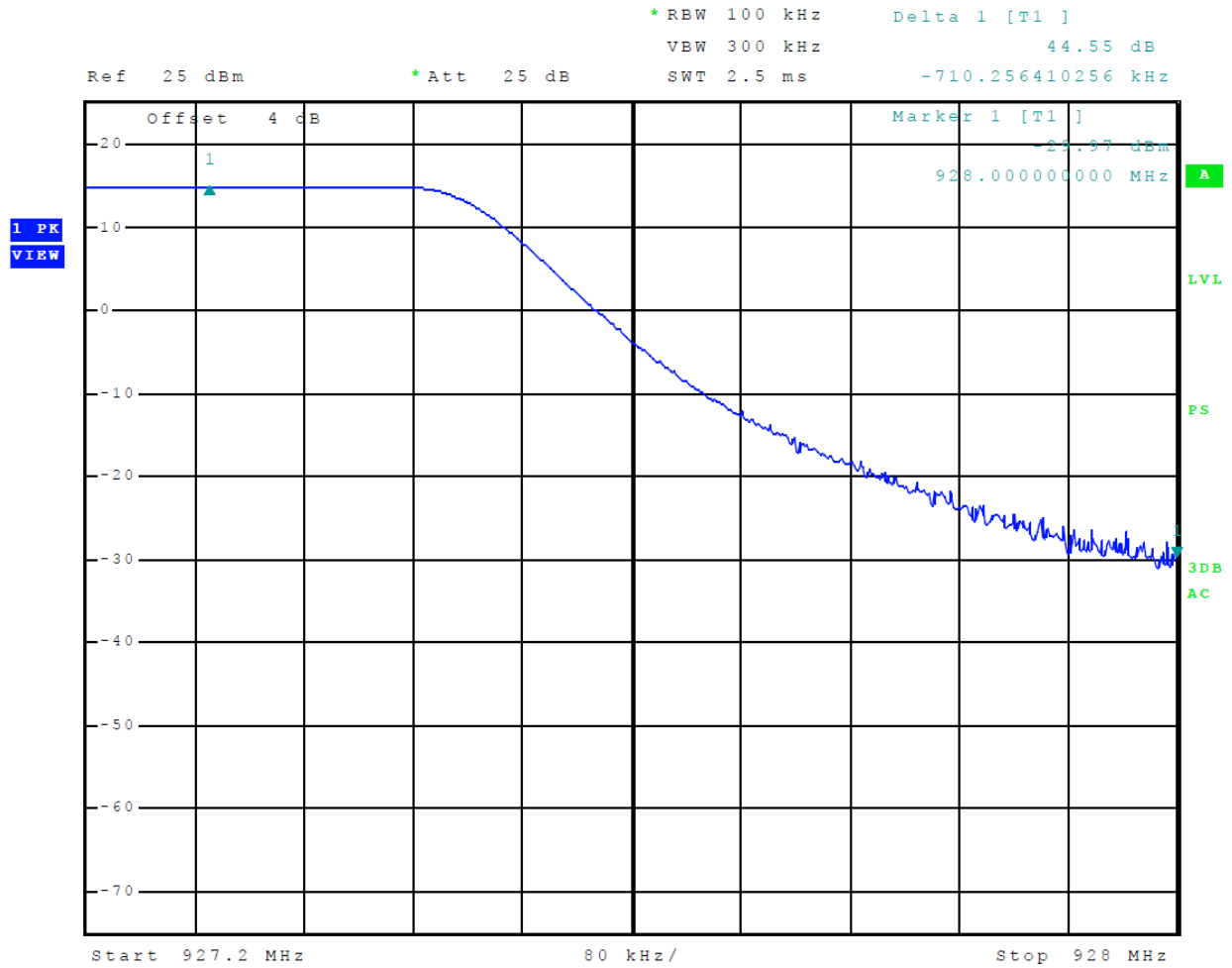
The amplitude of each harmonic and general radiated emission was measured on the OATS at distance of 3 meters from the FSM antenna (testing was performed on samples 1 representative of production equipment with integral antenna). The EUT was positioned on supporting turntable elevated as required above the ground plane, at a distance of 3 meters from the FSM antenna. Radiated emission investigations were performed from 9 kHz to 10,000 MHz. Each radiated emission was maximized by varying the FSM antenna height and polarization, and by rotating the turntable. The worst-case amplitude of each emission was then recorded from the analyzer display. The peak and quasi-peak amplitude of frequencies below 1000 MHz were measured using a spectrum analyzer. The peak and average amplitude of frequencies above 1000 MHz were measured using a spectrum analyzer. A Loop antenna was used for measuring emissions from 0.009 to 30 MHz, Biconilog Antenna for 30 to 1000 MHz, Double-Ridge, and/or Pyramidal Horn Antennas above 1 GHz. Test samples 3 and 4 were provided for antenna port conducted emissions testing. The se samples were modified by replacing the integral antenna with a 50-ohm antenna port connector for testing purposes. Plots were taken of transmitter performance (using samples 3 and 4 for reference).



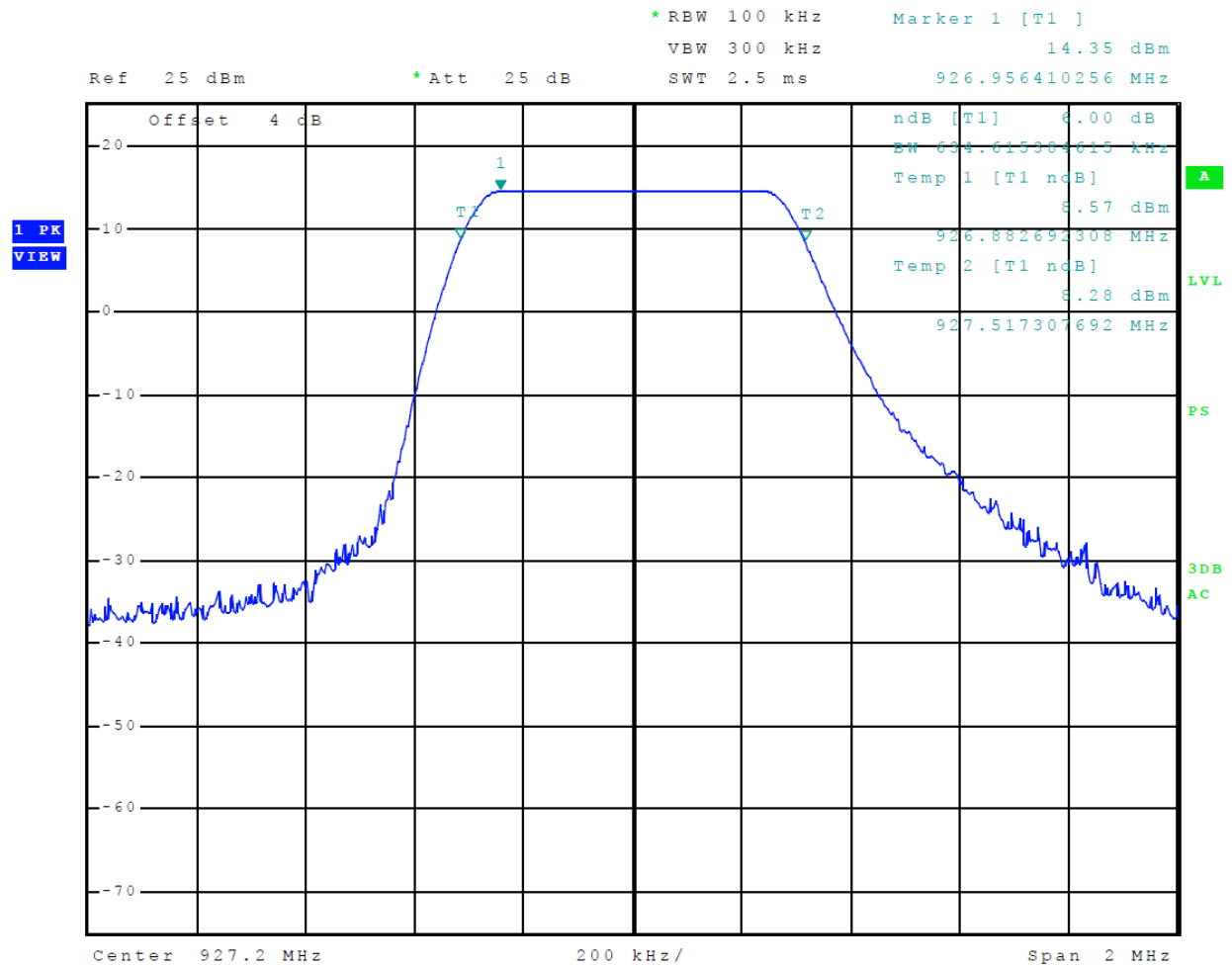
**Figure 1 Plot of Transmitter Emissions in Operational Frequency Band (M-Mode)**



**Figure 2 Plot of Lower Band Edge (M-mode)**



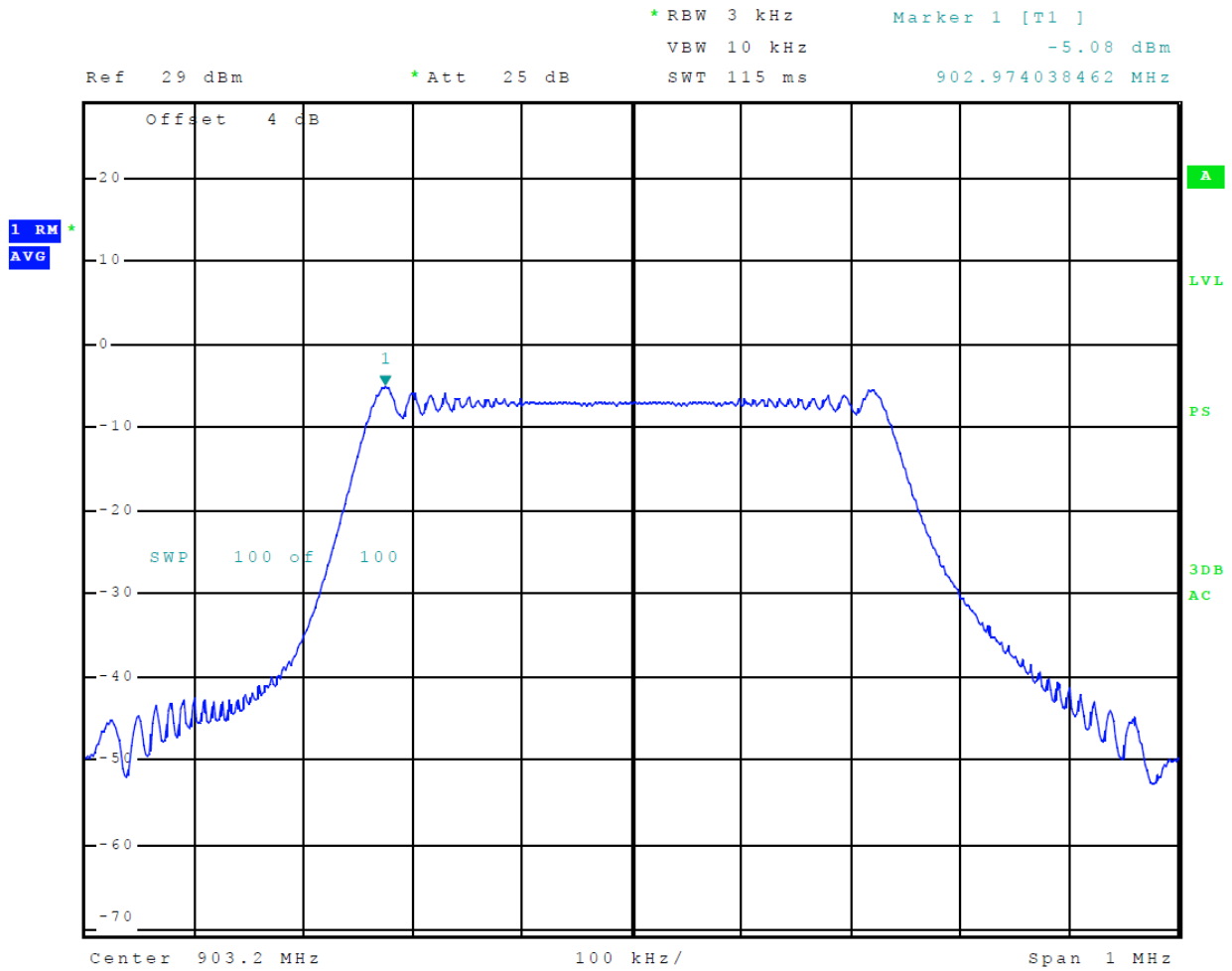
**Figure 3 Plot of Upper Band Edge (M-mode)**



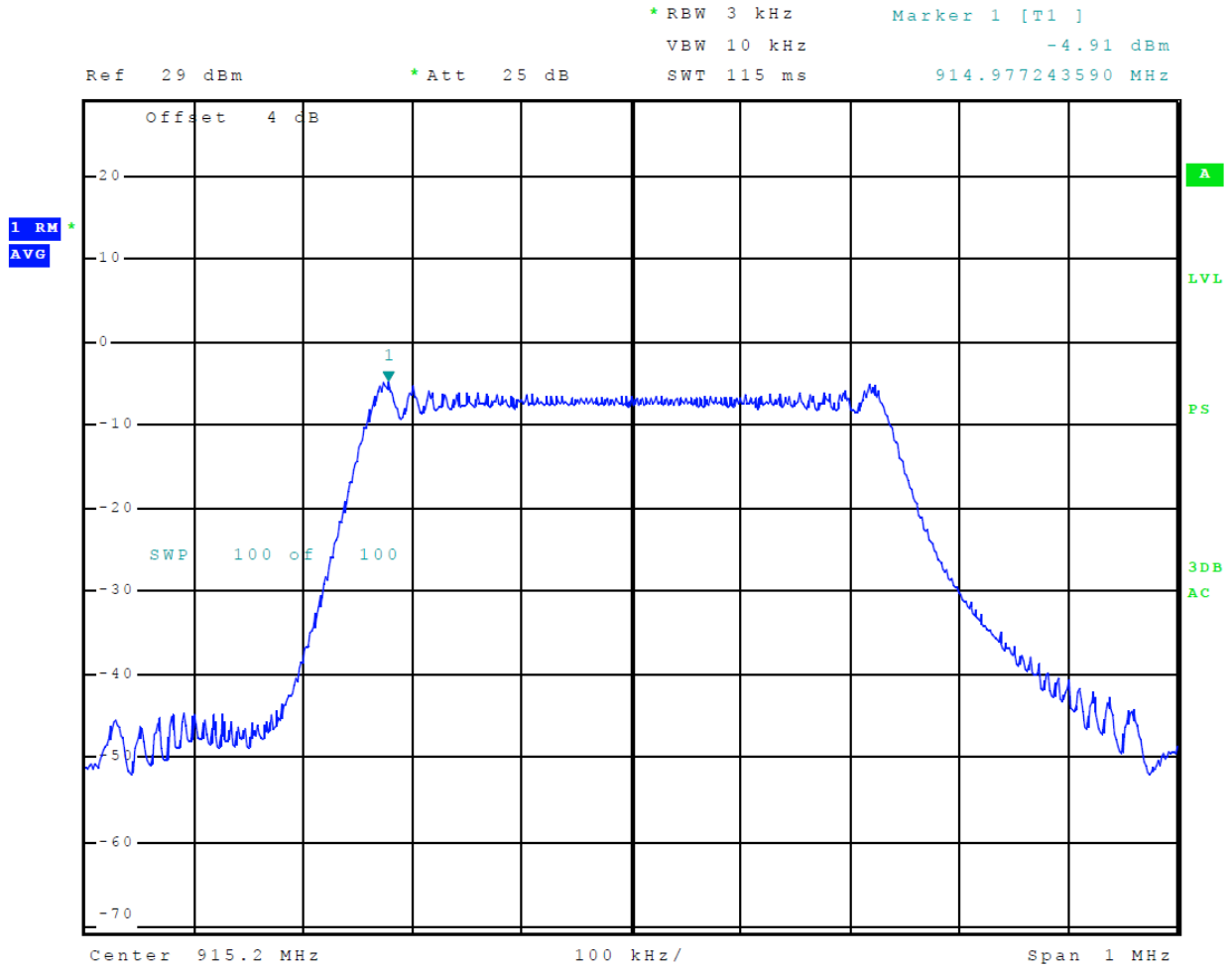
**Figure 4 Plot of Transmitter 6-dB Occupied Bandwidth (M-mode)**



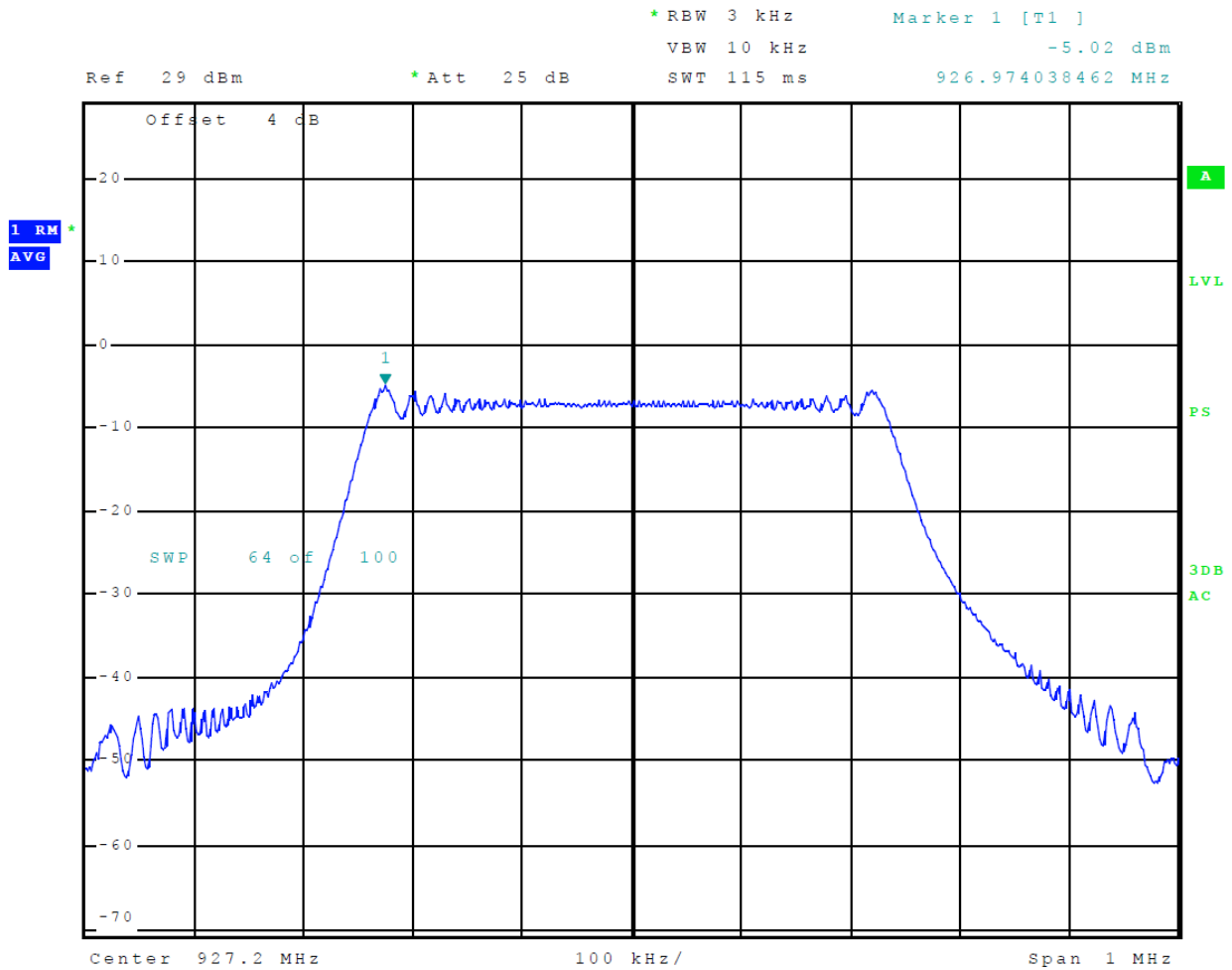




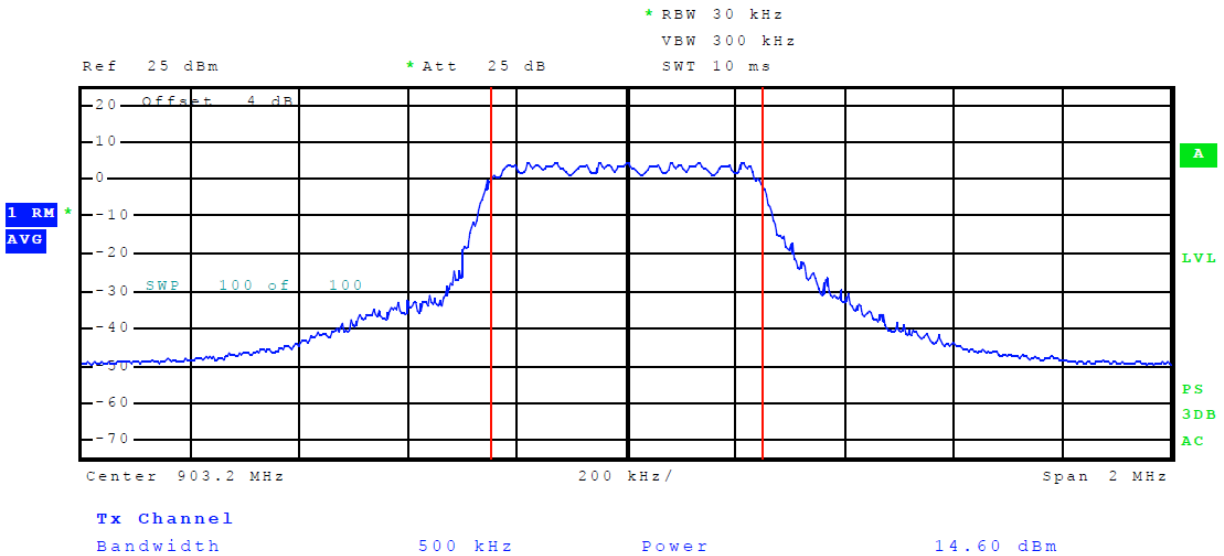
**Figure 6 Plot of Power Spectral Density (M-Mode)**



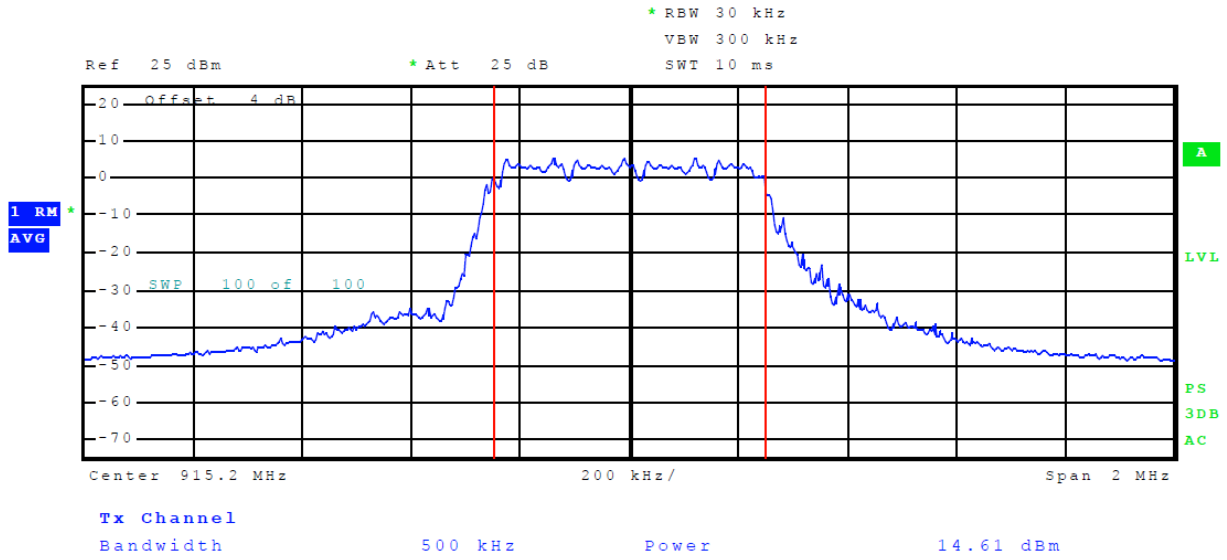
**Figure 7 Plot of Power Spectral Density (M-Mode)**



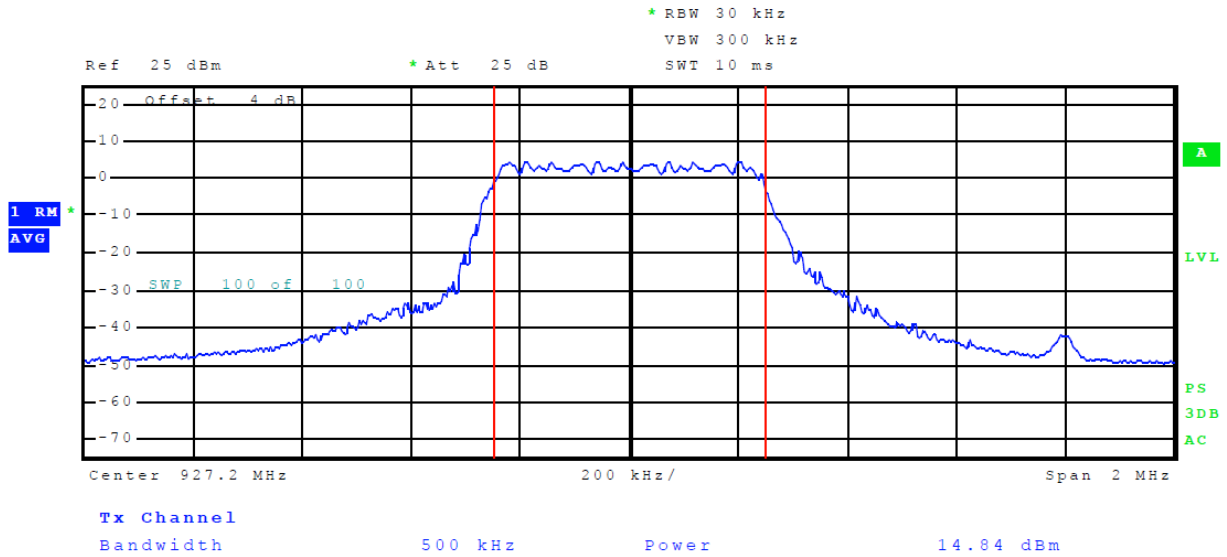
**Figure 8 Plot of Power Spectral Density (M-Mode)**



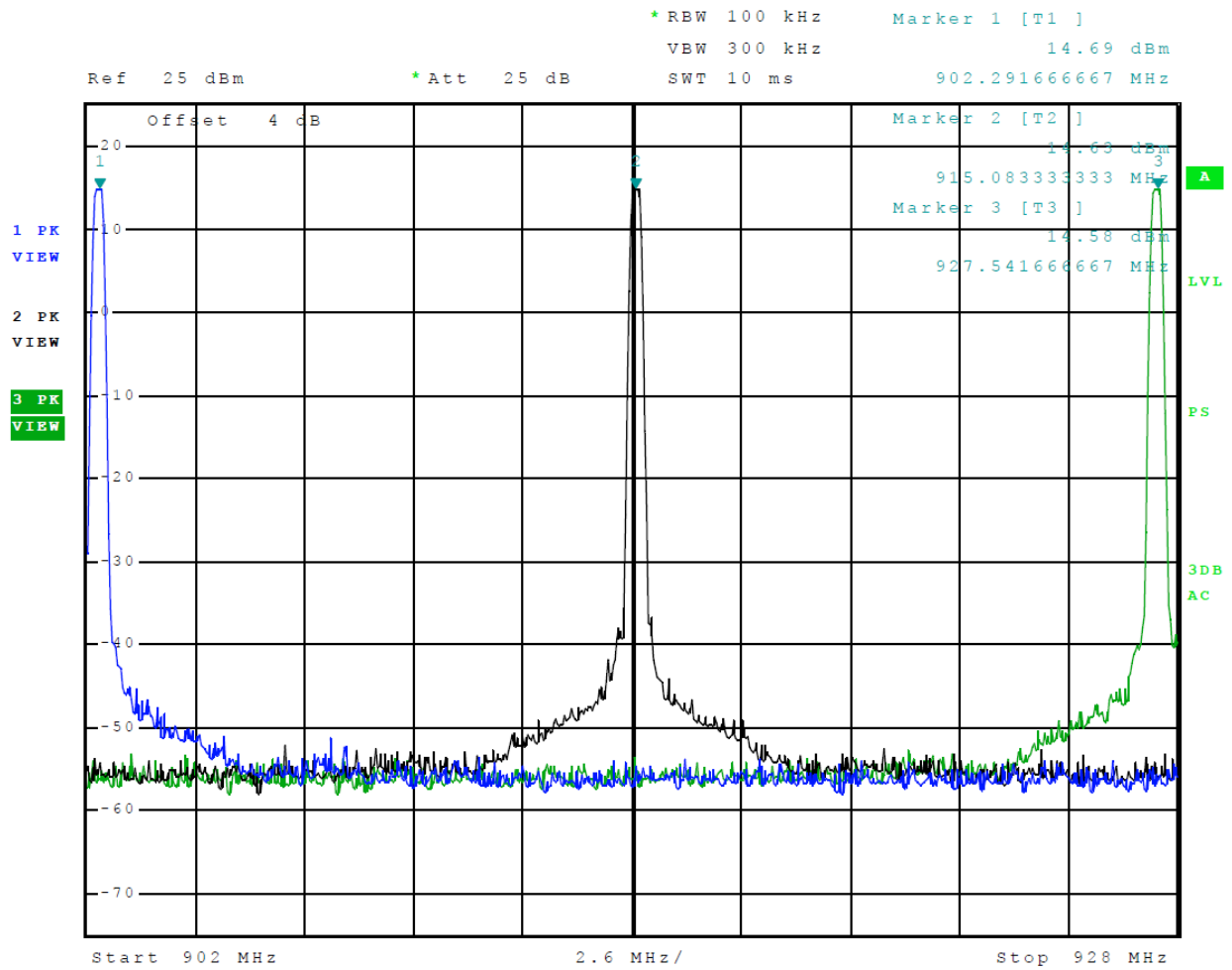
**Figure 9 Plot of Output Power (M-Mode)**



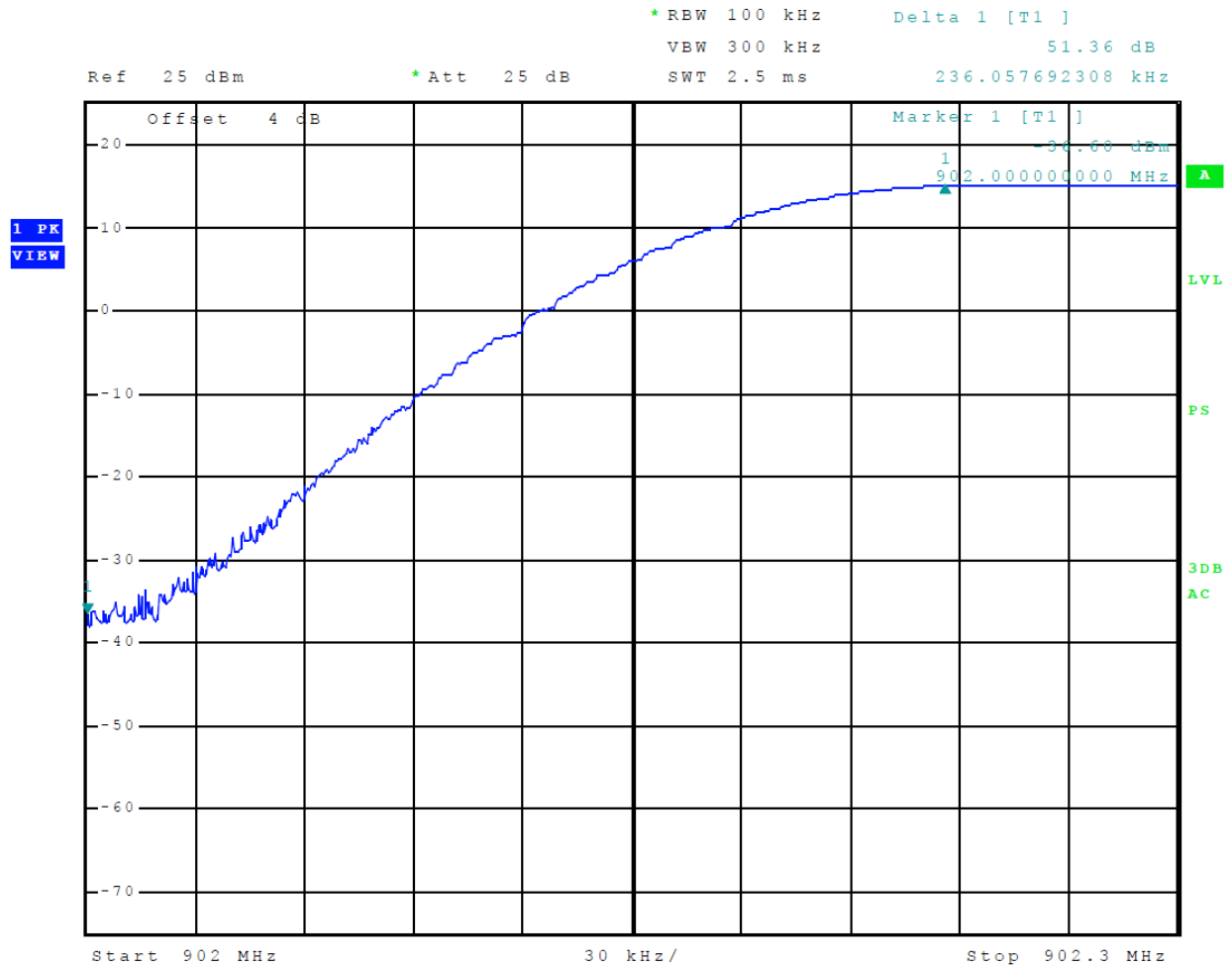
**Figure 10 Plot of Output Power (M-Mode)**



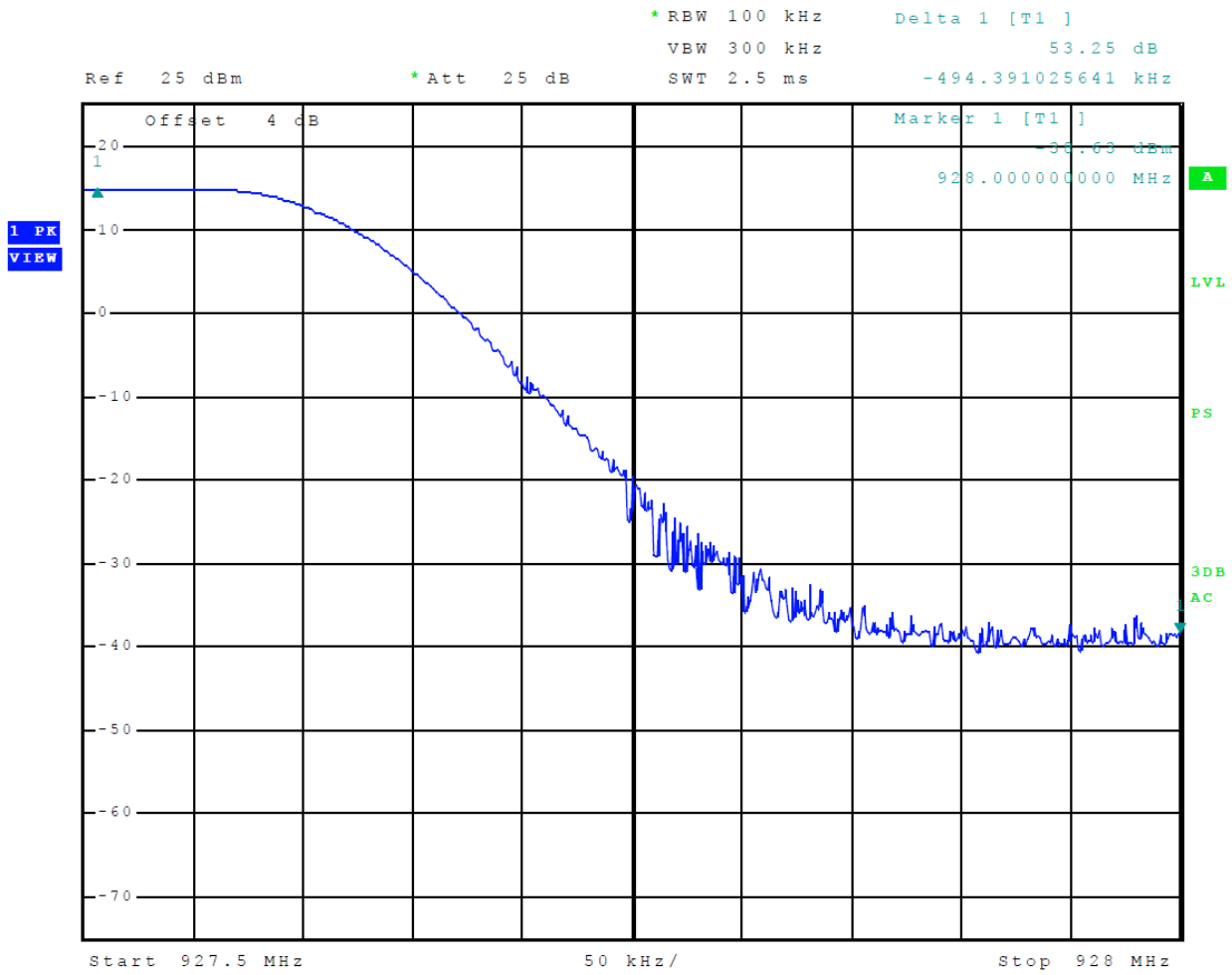
**Figure 11 Plot of Output Power (M-Mode)**



**Figure 12 Plot of Transmitter Emissions in Operational Frequency Band (P-Mode)**

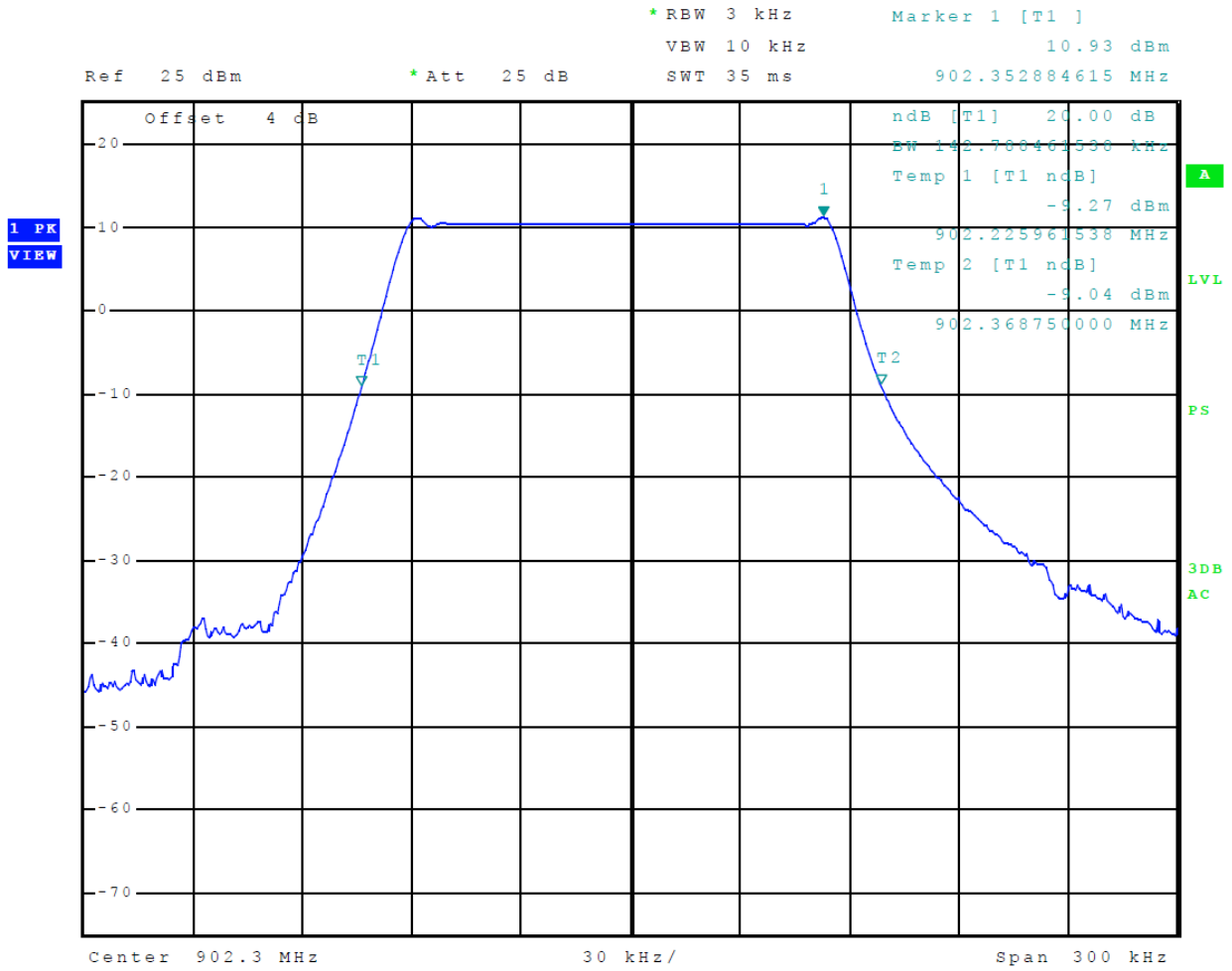


**Figure 13 Plot of Lower Band Edge (P-mode)**

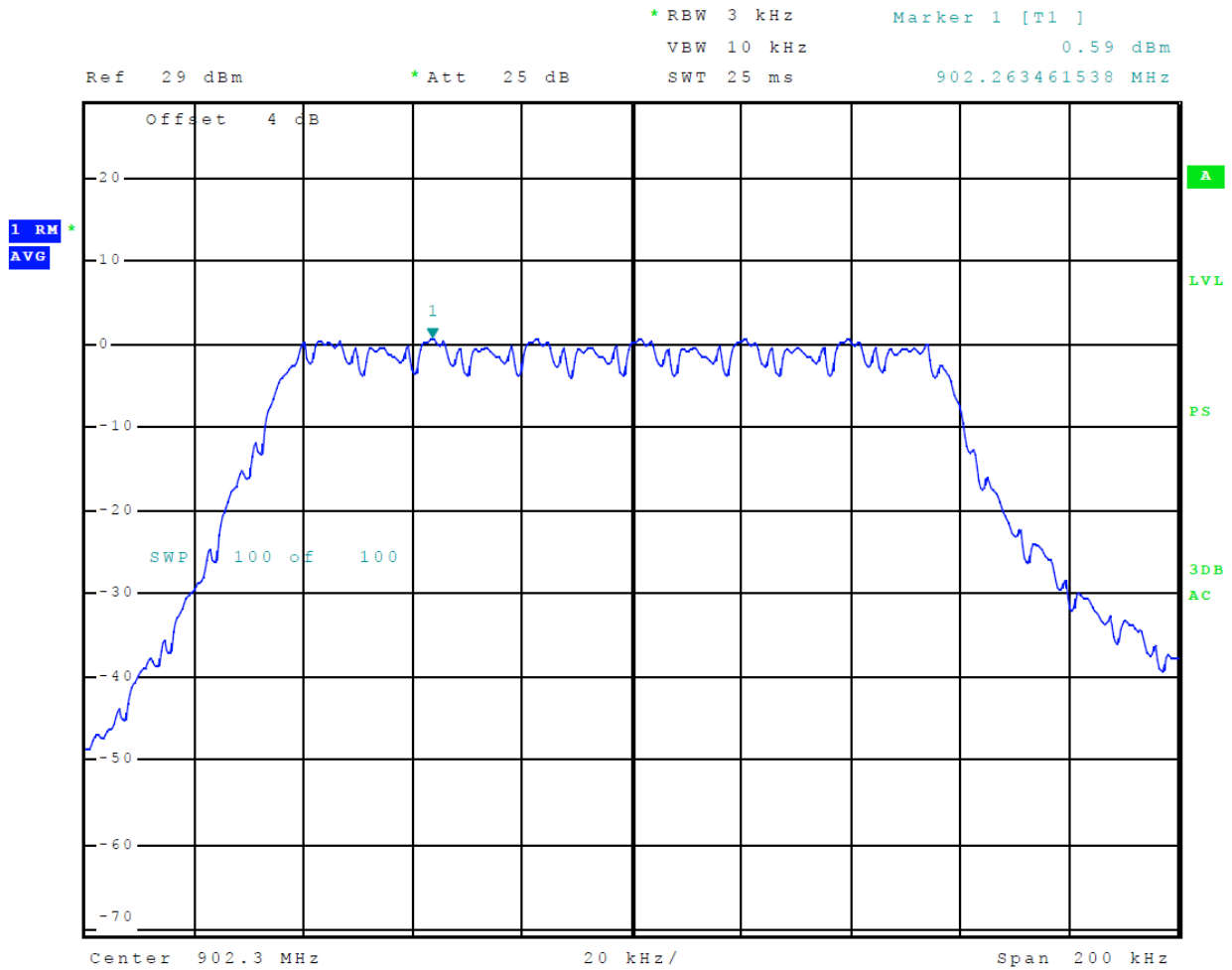


**Figure 14 Plot of Upper Band Edge (P-mode)**

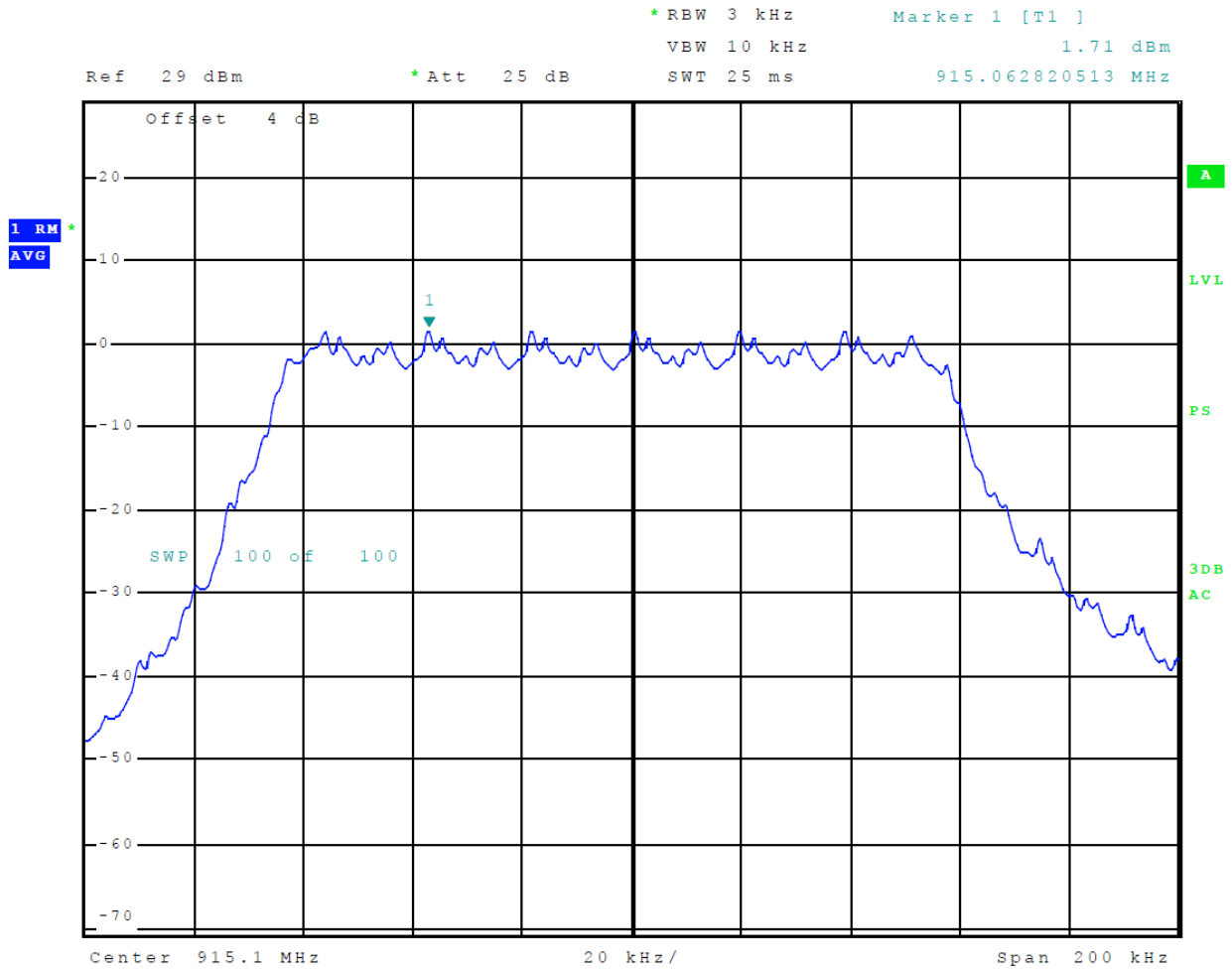




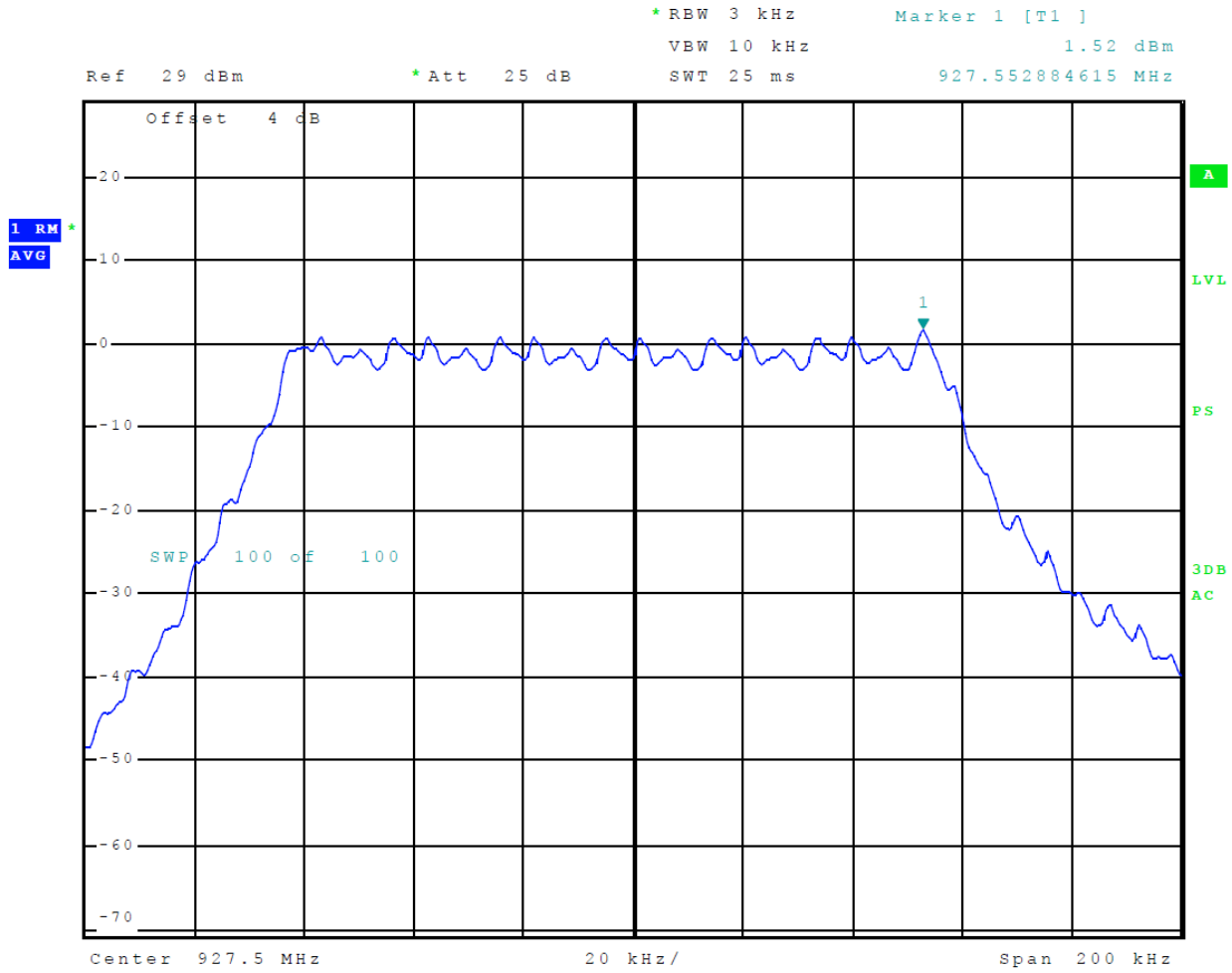
**Figure 15 Plot of Transmitter 20-dB Occupied Bandwidth (P-mode)**



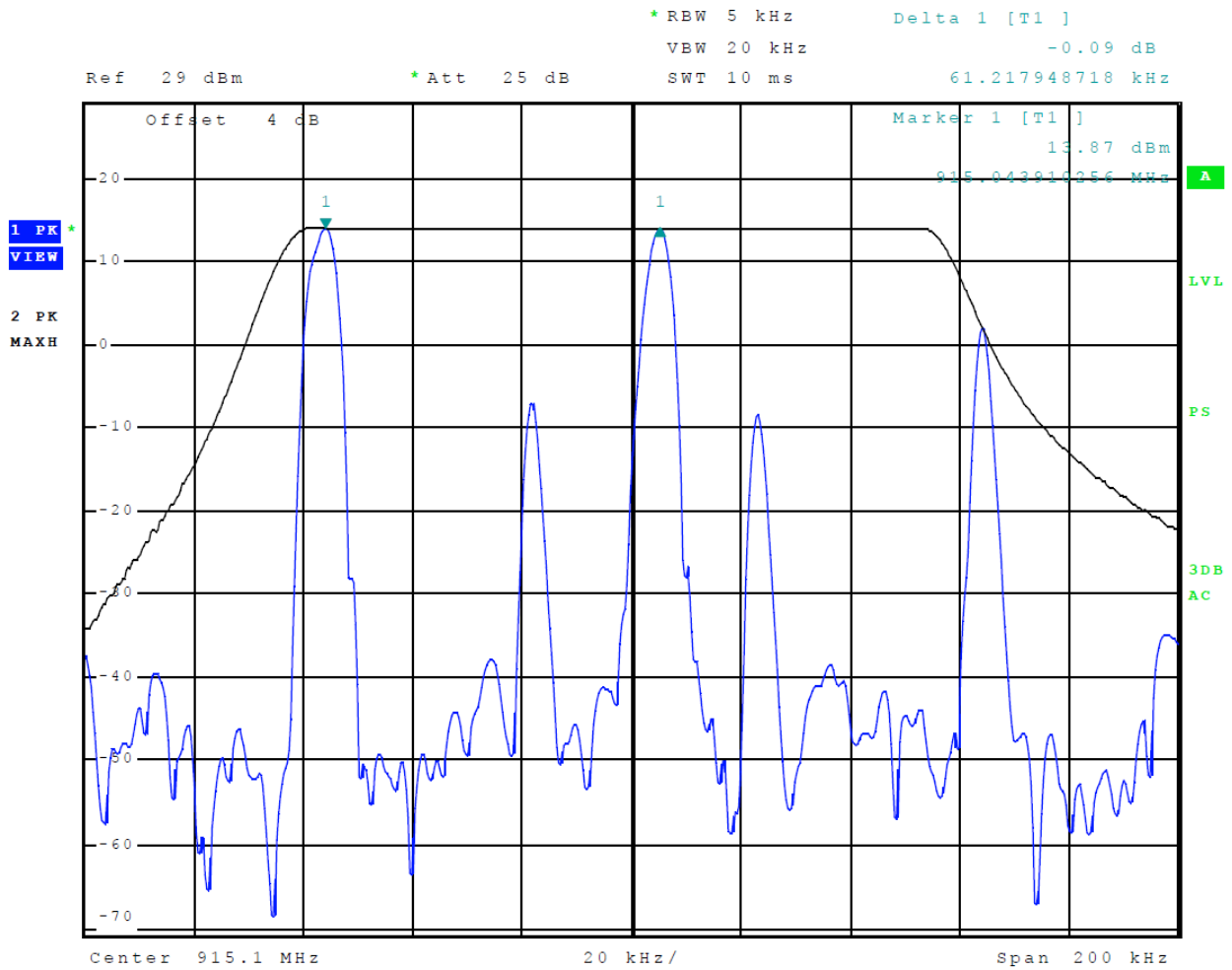
**Figure 16 Plot of Power Spectral Density (P-Mode)**



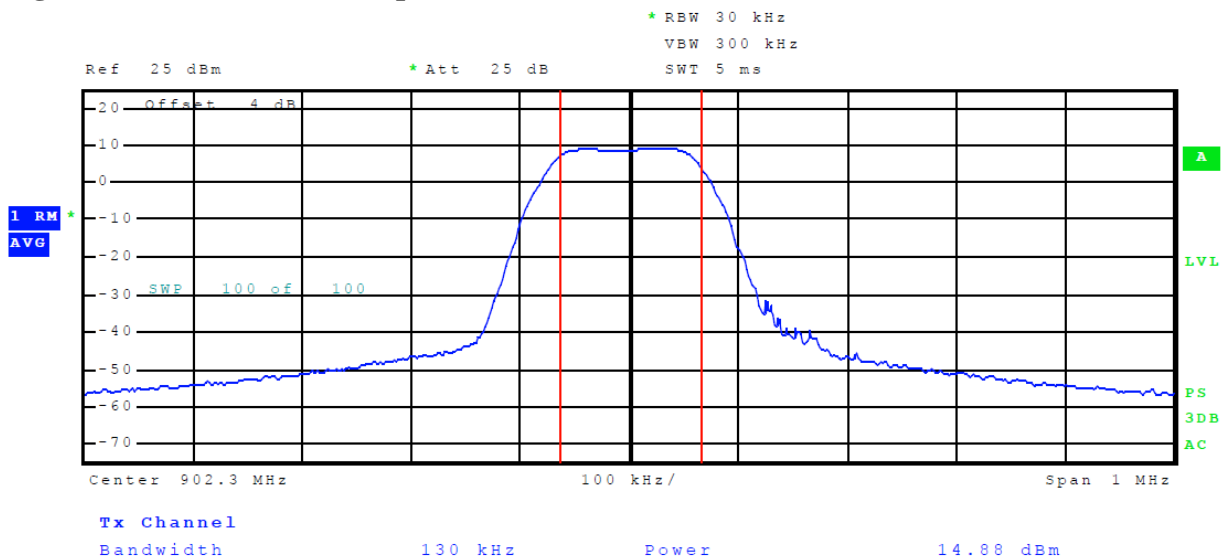
**Figure 17 Plot of Power Spectral Density (P-Mode)**



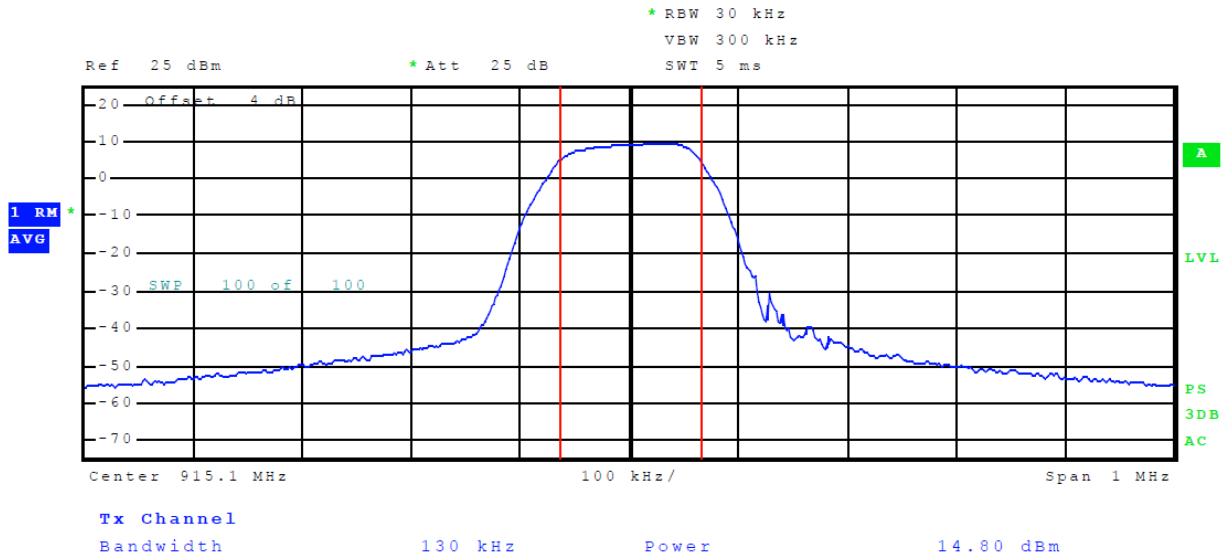
**Figure 18 Plot of Power Spectral Density (P-Mode)**



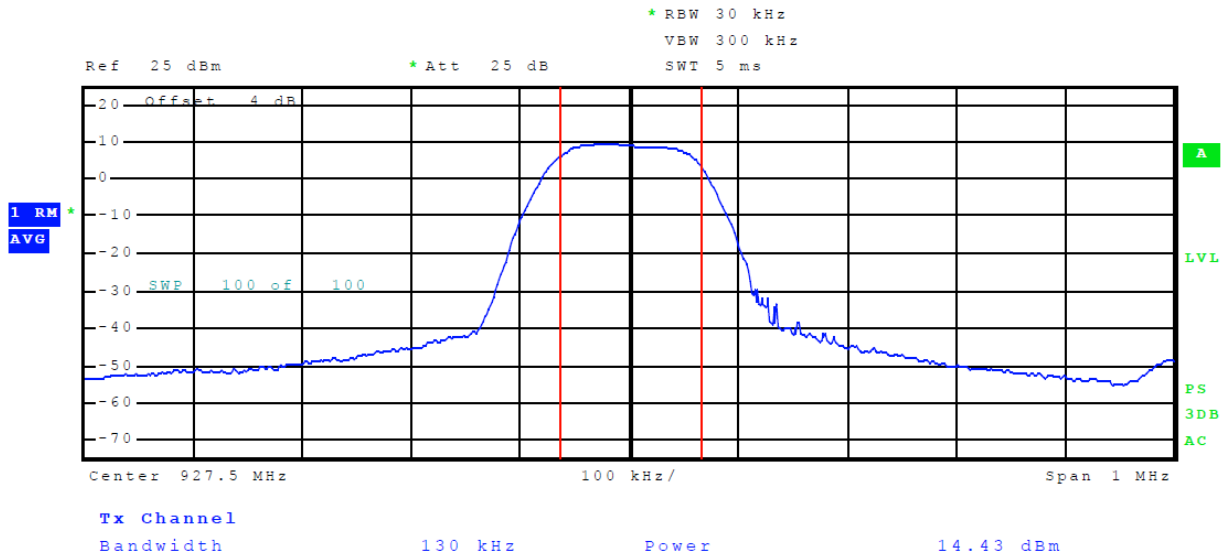
**Figure 19 Plot of Channel Separation (P-mode)**



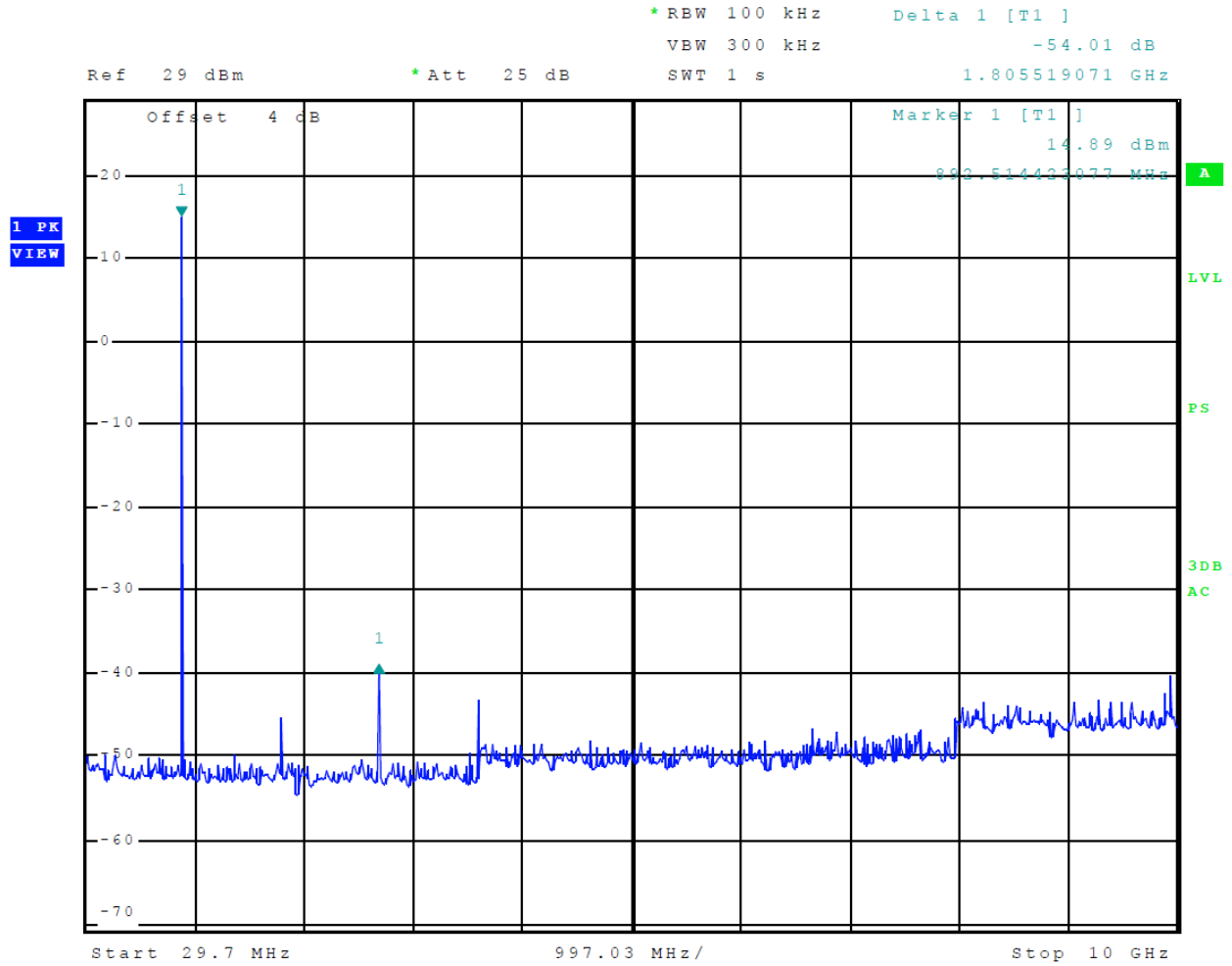
**Figure 20 Plot of Output Power (P-Mode)**



**Figure 21 Plot of Output Power (P-Mode)**



**Figure 22 Plot of Output Power (P-Mode)**



**Figure 23 Plot of Out of Band Emissions**

**Transmitter Emissions Data**

**Table 4 Transmitter Radiated Emission M-mode Worst-case Data**

Frequency in MHz	Horizontal Peak (dB $\mu$ V/m)	Horizontal Average (dB $\mu$ V/m)	Vertical Peak (dB $\mu$ V/m)	Vertical Average (dB $\mu$ V/m)	Limit @ 3m (dB $\mu$ V/m)	Horizontal Average Margin (dB)	Vertical Average Margin (dB)
903.2	--	--	--	--	--	--	--
1806.4	52.2	25.6	51.8	25.1	54.0	-28.4	-28.9
2709.6	48.3	16.6	46.8	13.8	54.0	-37.4	-40.2
3612.8	42.6	7.1	42.7	7.1	54.0	-46.9	-46.9
4516.0	48.6	10.9	46.7	10.9	54.0	-43.1	-43.1
5419.2	48.5	12.1	48.0	12.1	54.0	-41.9	-41.9
6322.4	47.8	12.1	47.8	12.1	54.0	-41.9	-41.9
915.2	--	--	--	--	--	--	--
1830.4	51.9	24.9	52.1	25.2	54.0	-29.1	-28.8
2745.6	49.0	17.7	46.2	13.4	54.0	-36.3	-40.6
3660.8	45.5	9.4	45.1	9.4	54.0	-44.6	-44.6
4576.0	44.0	8.7	44.8	8.7	54.0	-45.3	-45.3
5491.2	46.1	10.1	46.1	10.1	54.0	-43.9	-43.9
6406.4	49.5	13.7	50.3	13.7	54.0	-40.3	-40.3
927.2	--	--	--	--	--	--	--
1854.4	51.8	24.6	52.5	25.5	54.0	-29.4	-28.5
2781.6	48.8	17.4	46.2	12.0	54.0	-36.6	-42.0
3708.8	44.2	8.4	44.0	8.4	54.0	-45.6	-45.6
4636.0	47.0	10.9	47.3	10.9	54.0	-43.1	-43.1
5563.2	48.0	12.5	48.5	12.4	54.0	-41.5	-41.6
6490.4	49.6	13.6	49.5	13.6	54.0	-40.4	-40.4

Other emissions present had amplitudes at least 20 dB below the limit. Peak and Quasi-Peak amplitude emissions are recorded for frequency below 1000 MHz. Peak and Average amplitude emissions are recorded for frequency range above 1000 MHz.



**Table 5 Transmitter Radiated Emission P-mode Worst-case Data**

Frequency in MHz	Horizontal Peak (dB $\mu$ V/m)	Horizontal Average (dB $\mu$ V/m)	Vertical Peak (dB $\mu$ V/m)	Vertical Average (dB $\mu$ V/m)	Limit @ 3m (dB $\mu$ V/m)	Horizontal Average Margin (dB)	Vertical Average Margin (dB)
902.3	--	--	--	--	--	--	--
1804.6	52.5	27.4	52.2	27.1	54.0	-26.6	-26.9
2706.9	48.4	20.2	46.5	15.9	54.0	-33.8	-38.1
3609.2	43.8	7.2	43.1	7.3	54.0	-46.8	-46.7
4511.5	46.7	11.0	47.1	11.0	54.0	-43.0	-43.0
5413.8	47.9	12.2	48.0	12.2	54.0	-41.8	-41.8
6316.1	48.1	12.0	47.8	12.0	54.0	-42.0	-42.0
915.1	--	--	--	--	--	--	--
1830.2	52.1	26.6	52.2	26.8	54.0	-27.4	-27.2
2745.3	48.9	20.9	46.6	16.3	54.0	-33.1	-37.7
3660.4	45.4	9.4	45.1	9.4	54.0	-44.6	-44.6
4575.5	44.5	8.6	44.5	8.6	54.0	-45.4	-45.4
5490.6	46.2	10.3	45.9	10.2	54.0	-43.7	-43.8
6405.7	49.0	13.7	50.1	13.7	54.0	-40.3	-40.3
927.5	--	--	--	--	--	--	--
1855.0	52.3	26.3	52.4	27.1	54.0	52.3	26.3
2782.5	49.5	20.6	46.1	14.4	54.0	49.5	20.6
3710.0	43.9	8.4	44.0	8.4	54.0	43.9	8.4
4637.5	46.3	10.5	46.5	10.7	54.0	46.3	10.5
5565.0	49.2	13.1	49.0	12.9	54.0	49.2	13.1
6492.5	49.9	13.6	50.2	13.6	54.0	49.9	13.6

Other emissions present had amplitudes at least 20 dB below the limit. Peak and Quasi-Peak amplitude emissions are recorded for frequency below 1000 MHz. Peak and Average amplitude emissions are recorded for frequency range above 1000 MHz.

**Table 6 Transmitter Antenna Port Data**

Frequency MHz	Antenna Port Output Power (Watts)	99% Occupied Bandwidth (kHz)	20-dB Occupied Bandwidth (kHz)	6-dB Occupied Bandwidth (kHz)	Peak Power Spectral Density (dBm/3kHz)
M-mode					
903.2	0.029	516.0	N/A	631.4	-5.1
915.2	0.029	516.0	N/A	631.4	-4.9
927.2	0.030	519.2	N/A	634.6	-5.0
P-mode					
902.3	0.031	N/A	142.8	N/A	0.6
915.1	0.030	N/A	140.4	N/A	1.7
927.5	0.028	N/A	141.4	N/A	1.5

**Summary of Results for Transmitter Radiated Emissions of Intentional Radiator**

The EUT demonstrated compliance with the radiated emissions requirements of CFR47 Part 15.247, RSS-GEN, and RSS-247 Hybrid Digital Transmission Systems. Antenna port conducted output power of 0.031 Watts was measured at the temporary antenna port of the EUT. The power spectral density measured at the antenna port presented a minimum margin of -6.3 dB below the requirements. The EUT demonstrated a minimum margin of -26.6 dB below the harmonic emissions requirements. There were no other significantly measurable emissions in the restricted bands other than those recorded in this report. Other emissions were present with amplitudes at least 20 dB below the requirements. There were no other deviations or exceptions to the requirements.

## Annex

- Annex A Measurement Uncertainty Calculations
- Annex B Additional Test Equipment
- Annex C Rogers Qualifications
- Annex D Laboratory Certificate of Accreditation

## Annex A Measurement Uncertainty Calculations

The measurement uncertainty was calculated for all measurements listed in this test report according To CISPR 16-4. Result of measurement uncertainty calculations are recorded below. Component and process variability of production devices similar to those tested may result in additional deviations. The manufacturer has the sole responsibility of continued compliance.

Measurement	Expanded Measurement Uncertainty $U_{(lab)}$
3 Meter Horizontal 0.009-1000 MHz Measurements	4.16
3 Meter Vertical 0.009-1000 MHz Measurements	4.33
3 Meter Measurements 1-18 GHz	5.14
3 Meter Measurements 18-40 GHz	5.16
10 Meter Horizontal Measurements 0.009-1000 MHz	4.15
10 Meter Vertical Measurements 0.009-1000 MHz	4.32
AC Line Conducted	1.75
Antenna Port Conducted power	1.17
Frequency Stability	1.00E-11
Temperature	1.6°C
Humidity	3%

## Annex B Additional Test Equipment

List of Test Equipment	Calibration	Date (m/d/y)	Due
<input type="checkbox"/> Frequency Counter: Leader LDC-825 (8060153)		4/18/2019	4/18/2021
<input type="checkbox"/> LISN: Fischer Custom Communications Model: FCC-LISN-50-16-2-08		4/18/2019	4/18/2020
<input type="checkbox"/> Cable Huber & Suhner Inc. Sucoflex102ea(1.5M)(303070) 9kHz-40 GHz		10/14/2019	10/14/2020
<input type="checkbox"/> Cable Huber & Suhner Inc. Sucoflex102ea(1.5M)(303072) 9kHz-40 GHz		10/14/2019	10/14/2020
<input type="checkbox"/> Cable Huber & Suhner Inc. Sucoflex102ea(L4M)(281184) 9kHz-40 GHz		10/14/2019	10/14/2020
<input type="checkbox"/> Cable Huber & Suhner Inc. Sucoflex102ea(L10M)(317546)9kHz-40 GHz		10/14/2019	10/14/2020
<input type="checkbox"/> Cable Time Microwave 4M-750HF290-750 (4M) 9kHz-24 GHz		10/14/2019	10/14/2020
<input type="checkbox"/> RF Filter Micro-Tronics BRC17663 (001) 9.3-9.5 notch 30-1800 MHz		4/18/2019	4/18/2020
<input type="checkbox"/> RF Filter Micro-Tronics BRC19565 (001) 9.2-9.6 notch 30-1800 MHz		10/16/2018	4/18/2020
<input type="checkbox"/> Attenuator Mini-Circuits VAT-3W2+ (1735) 30-6000 MHz		4/18/2019	4/18/2020
<input type="checkbox"/> Analyzer HP 8562A (3051A05950) 9kHz-125GHz		4/18/2019	4/18/2020
<input type="checkbox"/> Analyzer HP External Mixers11571, 11970 25GHz-110GHz		4/18/2015	4/18/2025
<input type="checkbox"/> Analyzer HP 8591EM (3628A00871)		5/2/2018	5/2/2020
<input type="checkbox"/> LISN Com-Power LI-550C (20140004&5) .1-108MHz		10/14/2019	10/14/2020
<input type="checkbox"/> Antenna: Solar 9229-1 & 9230-1		2/22/2019	2/22/2020
<input type="checkbox"/> R.F. Generator: SMB100A6 s/n 100623		4/18/2019	4/18/2020
<input type="checkbox"/> R.F. Generator: SBMBV100A s/n: 260771		4/18/2019	4/18/2020
<input type="checkbox"/> R.F. Power Amp ACS 230-50W		2/22/2019	2/22/2020
<input type="checkbox"/> R.F. Power Amp EIN Model: A301		2/22/2019	2/22/2020
<input type="checkbox"/> R.F. Power Amp A.R. Model: 10W 1010M7		2/22/2019	2/22/2020
<input type="checkbox"/> LISN: Com-Power Model LI-550C		10/14/2019	10/14/2020
<input type="checkbox"/> LISN: Compliance Eng. Model 240/20		4/18/2019	4/18/2020
<input type="checkbox"/> LISN: Fischer Custom Communications Model: FCC-LISN-50-16-2-08		4/18/2019	4/18/2020
<input type="checkbox"/> Oscilloscope Scope: Tektronix MDO 4104		2/22/2019	2/22/2020
<input type="checkbox"/> EMC Transient Generator HVT TR 3000		2/22/2019	2/22/2020
<input type="checkbox"/> AC Power Source (Ametech, California Instruments)		2/22/2019	2/22/2020
<input type="checkbox"/> Field Intensity Meter: EFM-018		2/22/2019	2/22/2020
<input type="checkbox"/> ESD Simulator: MZ-15		2/22/2019	2/22/2020

Shielded Room not required

Rogers Labs, Inc.  
 4405 W. 259th Terrace  
 Louisburg, KS 66053  
 Phone/Fax: (913) 837-3214  
 Revision 1

SAF Tehnika AS  
 Model: TDSPRMU1  
 Test: 191029  
 Test to: CFR47 15C, RSS-Gen RSS-247  
 File: SAF TDSPRMU1 DTS TstRpt 191029 Page 45 of 47

S/N's: EUT1 / EUT2  
 FCC ID: W9Z-ARANETRM  
 IC: 8855A-ARANETRM  
 Date: November 27, 2019

## **Annex C Rogers Qualifications**

***Scot D. Rogers, Engineer***

### **Rogers Labs, Inc.**

Mr. Rogers has 32 years' experience in the field of electronics. Work experience includes working in the automated controls industry and remaining years working with the design, development and testing of radio communications and electronic equipment.

#### Positions Held:

Systems Engineer: A/C Controls Mfg. Co., Inc. 6 Years

Electrical Engineer: Rogers Consulting Labs, Inc. 5 Years

Electrical Engineer: Rogers Labs, Inc. Current

#### Educational Background:

- 1) Bachelor of Science Degree in Electrical Engineering from Kansas State University
- 2) Bachelor of Science Degree in Business Administration Kansas State University
- 3) Several Specialized Training courses and seminars pertaining to Microprocessors and Software programming.

**Annex D Laboratory Certificate of Accreditation**

United States Department of Commerce  
National Institute of Standards and Technology



**Certificate of Accreditation to ISO/IEC 17025:2017**

NVLAP LAB CODE: 200087-0

**Rogers Labs, Inc.**  
Louisburg, KS

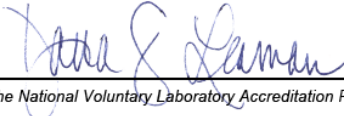
*is accredited by the National Voluntary Laboratory Accreditation Program for specific services,  
listed on the Scope of Accreditation, for:*

**Electromagnetic Compatibility & Telecommunications**

*This laboratory is accredited in accordance with the recognized International Standard ISO/IEC 17025:2017.  
This accreditation demonstrates technical competence for a defined scope and the operation of a laboratory quality  
management system (refer to joint ISO-ILAC-IAF Communique dated January 2009).*

2019-11-07 through 2020-03-31  
Effective Dates



  
For the National Voluntary Laboratory Accreditation Program

Rogers Labs, Inc.  
4405 W. 259th Terrace  
Louisburg, KS 66053  
Phone/Fax: (913) 837-3214  
Revision 1

SAF Tehnika AS  
Model: TDSPRMU1  
Test: 191029  
Test to: CFR47 15C, RSS-Gen RSS-247  
File: SAF TDSPRMU1 DTS TstRpt 191029 Page 47 of 47

S/N's: EUT1 / EUT2  
FCC ID: W9Z-ARANETRM  
IC: 8855A-ARANETRM  
Date: November 27, 2019