

ROGERS LABS, INC.

4405 West 259th Terrace
Louisburg, KS 66053
Phone / Fax (913) 837-3214

Application For Grant of Certification

Product Marketing Name: Aranet PRO Plus base
902-928 Digital Transmission System

FCC ID: W9Z-ARANETPP

IC: 8855A-ARANETPP

SAF Tehnika AS

24a, Ganibu dambis
Riga Latvia LV-1005

FCC Designation: US5305

IC Test Site Registration: 3041A-1

Test Report Number: 230227A

Test Date: February 27, 2023

Authorized Signatory: *Scot D Rogers*

Scot D. Rogers
Rogers Labs, Inc.
4405 West 259th Terrace
Louisburg, KS 66053
Telephone/Facsimile: (913) 837-3214

This report shall not be reproduced except in full, without the written approval of the laboratory. This report must not be used by the client to claim product certification, approval, or endorsement by NVLAP, NIST, or any agency of the U.S. Government.

Rogers Labs, Inc.

4405 W. 259th Terrace

Louisburg, KS 66053

Phone/Fax: (913) 837-3214

Revision r1

SAF Tehnika AS

M/N: TDSBOAU3 (4, 5, 6, 7)

Test: 230227A

Test to: 47CFR 15C, RSS-Gen RSS-247

File: SAF ARANETPP PRO Plus TstRpt 230227Ar1

S/N's: 5376 / 5865

FCC ID: W9Z-ARANETPP

IC: 8855A-ARANETPP

Date: April 11, 2023

Page 1 of 39

TABLE OF CONTENTS..... 2

REVISIONS..... 4

EXECUTIVE SUMMARY 5

OPINION / INTERPRETATION OF RESULTS 5

EQUIPMENT TESTED..... 6

Equipment Function6

Equipment Configuration.....7

APPLICATION FOR CERTIFICATION..... 8

APPLICABLE STANDARDS & TEST PROCEDURES 9

TESTING PROCEDURES 9

AC Line Conducted Emission Test Procedure9

Radiated Emission Test Procedure.....9

Antenna-Port Conducted Emission Test Procedure10

 Diagram 1 Test arrangement for Conducted emissions11

 Diagram 2 Test arrangement for radiated emissions of tabletop equipment.....12

 Diagram 3 Test arrangement for radiated emissions tested on Open Area Test Site (OATS)13

 Diagram 4 Test arrangement for Antenna Port Conducted emissions14

TEST SITE LOCATIONS 15

UNITS OF MEASUREMENTS 15

ENVIRONMENTAL CONDITIONS..... 15

STATEMENT OF MODIFICATIONS AND DEVIATIONS 16

INTENTIONAL RADIATORS..... 16

Antenna Requirements16

Restricted Bands of Operation.....16

Table 1 Harmonic Radiated Emissions in Restricted Bands.....17

Summary of Results for Radiated Emissions in Restricted Bands17

AC Line Conducted Emissions Procedure18

Figure 1 AC Line Conducted emissions line 119

Figure 2 AC Line Conducted emissions line 220

Table 2 AC Line Conducted Emissions Data L121

Table 3 AC Line Conducted Emissions Data L221

Summary of Results for AC Line Conducted Emissions Results21

General Radiated Emissions Procedure22

Table 4 General Radiated Emissions Data23

Summary of Results for General Radiated Emissions23

Operation in the Band 902 – 928 MHz24

Figure 3 Plot of Transmitter Emissions in Operational Frequency Band25

Figure 4 Plot of Transmitter Emissions Low Band Edge26

Figure 5 Plot of Transmitter Emissions High Band Edge.....27

Figure 6 Plot of Transmitter Emissions 6-dB Occupied Bandwidth.....28

Figure 7 Plot of Transmitter Emissions 99% dB Occupied Bandwidth.....29

Figure 8 Plot of Transmitter Power Spectral Density30

Figure 9 Plot of Transmitter Emissions at antenna port.....31

Transmitter Emissions Data.....32

Table 5 Transmitter Radiated Emission Worst-case Data32

Table 6 Transmitter Antenna Port Data32

Summary of Results for Transmitter Radiated Emissions of Intentional Radiator33

ANNEX..... 34

Annex A Measurement Uncertainty Calculations35

Annex B Test Equipment.....36



NVLAP Lab Code 200087-0

Annex C Rogers Qualifications38

Annex D Laboratory Certificate of Accreditation.....39

Revisions

Revision r1 Issued April 11, 2023

Executive Summary

The following information is submitted for consideration in obtaining Grant of Certification for License Exempt Hybrid Digital Transmission System Intentional Radiator operating under Title 47 Code of Federal Regulations (47CFR) Paragraph 15.247 and Industry Canada RSS-247 Issue 2, and RSS-GEN Issue 5, operation in the 902-928 MHz band.

Name of Applicant: SAF Tehnika AS
 24a, Ganibu dambis
 Riga Latvia LV-1005

FCC ID: W9Z-ARANETPP IC: 8855A-ARANETPP

PMN: Aranet PRO Plus base

HVIN's: TDSBOAU3, TDSBOAU4, TDSBOAU5, TDSBOAU6, TDSBOAU7

Antenna: PIFA (-14.1 dBi)

Frequency Range: 923.2 MHz

Output Power 0.001 W, 99% Occupied bandwidth 683.5 kHz

Opinion / Interpretation of Results

Tests Performed	Margin (dB)	Results
Restricted Bands Emissions per 47CFR 15.205, RSS-GEN	-18.0	Complies
AC Line Emissions per 47CFR 15.207, RSS-GEN	-9.4	Complies
General Emissions as per 47CFR 15.209, RSS-GEN	-3.0	Complies
Harmonic Emissions per 47CFR 15.247, RSS-247	-13.1	Complies
Power Spectral Density per 47CFR 15.247, RSS-247	-23.1	Complies

Equipment Tested

<u>Equipment</u>	<u>Model / PN</u>	<u>Serial Number</u>
EUT #1 (Integral Antenna)	TDSBOAU3	371642005376
EUT #2 (Antenna port connector)	TDSBOAU3	371642005865
AC/DC Power adapter	CFIP-AC-PS	361570124960
POE Adapter	CFIP-TPI	359440215450
Laptop Computer	Latitude E6520	6CB35Q1
USB Printer	Dell 0N5819	5D1SL61

Test results in this report relate only to the items tested.

- Software version of “typical” product: v3.3.3 or newer
- Software version of “modified test sample for testing”: v3.3.3-constantTx-1676468197

Equipment Function

The Equipment Under Test (EUT) provides sensor circuitry to monitor various environmental conditions. The design may be provided by different scopes of software functions using the identical Printed Circuit Board. The identification of different designs is provided under the different Hardware Version Identification Numbers (HVIN’s): TDSBOAU3, TDSBOAU4, TDSBOAU5, TDSBOAU6, TDSBOAU7. The design incorporates radio transceivers providing wireless interface operation with compatible 902-928 MHz LoRa (Long Rang) devices and incorporates 2412-2462 MHz 802.11b, g, n, n40 (Wi-Fi) wireless transceiver module (FCC ID: Z9W-CM2, IC: 11468A-CM2). The LoRa transmitter was tested for compliance as a Digital Transmission System employing a combination of both frequency hopping and digital modulation techniques with the Wi-Fi module active during testing. Two test samples were provided for testing; 1) representative of end product with integral antenna systems, and 2) modified by replacing the integral antenna with 50-ohm RF connection port. Both samples operated with special test software which provided testing personnel the capability to operate the transmitter in defined modes. The design operates from direct current power provided through compliant Power Over Ethernet (POE) adapter. The POE adapter was tested for compliance with AC Line conducted emission requirements. Test samples were provided with test software which engaged the transmitter systems in operational states during testing. The test software provided operation of the transmitter at 100% duty cycle for testing. For testing purposes, each test sample received power from the POE and was interfaced with laptop computer providing traffic over the network interface. The equipment was tested for emissions compliance using the

available configurations with the worst-case data presented. Test results in this report relate only to the products described in this report.

Equipment Configuration

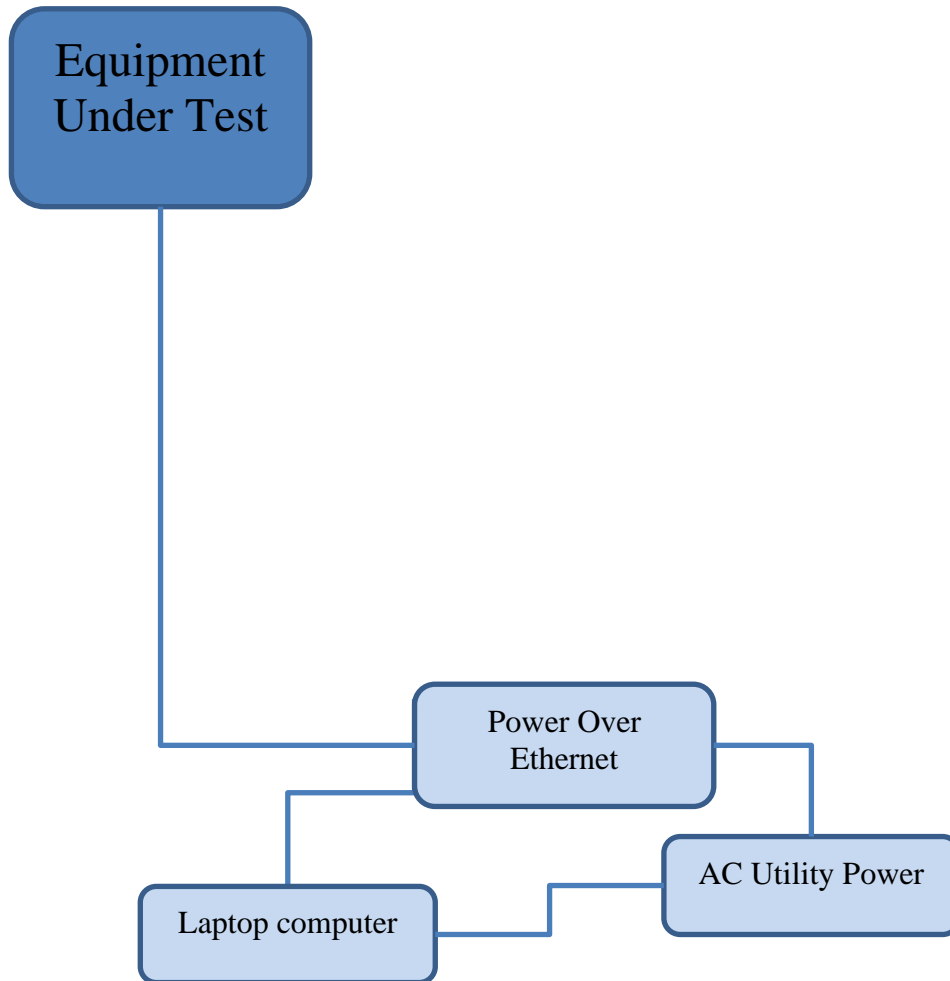

Application for Certification

- (1) Manufacturer: SAF Tehnika AS
24a, Ganibu dambis
Riga Latvia LV-1005
- (2) Identification: HVIN's: TDSBOAU3, TDSBOAU4, TDSBOAU5, TDSBOAU6,
TDSBOAU7
FCC ID: W9Z-ARANETPP IC: 8855A-ARANETPP
- (3) Instruction Book:
Refer to Exhibit for Instruction Manual.
- (4) Description of Circuit Functions:
Refer to Exhibit of Operational Description.
- (5) Block Diagram with Frequencies:
Refer to Exhibit of Operational Description.
- (6) Report of Measurements:
Report of measurements follows in this Report.
- (7) Photographs: Construction, Component Placement, etc.:
Refer to Exhibit for photographs of equipment.
- (8) List of Peripheral Equipment Necessary for operation. The equipment operates from direct current power supplied from Power Over Ethernet (POE) adapter and provides only network interface as presented in this filing. The EUT offers no other connection ports than those presented in this filing.
- (9) Transition Provisions of 47CFR 15.37 are not requested.
- (10) Not Applicable. The unit is not a scanning receiver.
- (11) Not Applicable. The EUT does not operate in the 59 – 64 GHz frequency band.
- (12) The equipment is not software defined and this section is not applicable.
- (13) Applications for certification of U-NII devices in the 5.15-5.35 GHz and the 5.47-5.85 GHz bands must include a high-level operational description of the security procedures that control the radio frequency operating parameters and ensure that unauthorized modifications cannot be made. This requirement is not applicable to his DTS device.
- (14) Contain at least one drawing or photograph showing the test set-up for each of the required types of tests applicable to the device for which certification is requested. These drawings or photographs must show enough detail to confirm other information contained in the test report. Any photographs used must be focused originals without glare or dark spots and must clearly show the test configuration used. This information is provided in this report and Test Setup Exhibits provided with the application filing.

Applicable Standards & Test Procedures

The following information is submitted in accordance with the eCFR Federal Communications Code of Federal Regulations, dated February 27, 2023, Part 2, Subpart J, Paragraphs 2.907, 2.911, 2.913, 2.925, 2.926, 2.1031 through 2.1057, applicable parts of paragraph 15, Part 15C Paragraph 15.247, and Industry Canada RSS-247 Issue 2, and RSS-GEN Issue 5. This equipment operates as Digital Transmission System. Test procedures used are as defined in 558074 D01 15.247 Meas Guidance v05r02 and ANSI C63.10-2013.

Testing Procedures

AC Line Conducted Emission Test Procedure

Testing for the AC line-conducted emissions were performed as required in 47CFR 15C, RSS-247 Issue 2, RSS-GEN and specified in ANSI C63.10-2013. The test setup, including the EUT, was arranged in the test configurations as presented during testing. The test configuration was placed on a 1 x 1.5-meter bench, 0.8 meters high located in a screen room. The power lines of the system were isolated from the power source using a standard LISN with a 50- μ Hy choke. EMI was coupled to the spectrum analyzer through a 0.1 μ F capacitor internal to the LISN. The LISN was positioned on the floor beneath the wooden bench supporting the EUT. The power lines and cables were draped over the back edge of the table. Refer to diagram one showing typical test arrangement and photographs in exhibits for EUT placement used during testing.

Radiated Emission Test Procedure

Radiated emissions testing was performed as required in 47CFR 15, RSS-247 and specified in ANSI C63.10-2013. The EUT was placed on a rotating 0.9 x 1.2-meter platform, elevated as required above the ground plane at a distance of 3 meters from the FSM antenna. EMI energy was maximized by equipment placement permitting orientation in three orthogonal axes, raising, and lowering the FSM antenna, changing the antenna polarization, and by rotating the turntable. Each emission was maximized before data was taken using a spectrum analyzer. The frequency spectrum from 9 kHz to 25,000 MHz was searched during preliminary investigation. Refer to diagrams two and three showing typical test arrangement and photographs in the test setup exhibits for specific EUT placement during testing.

Antenna-Port Conducted Emission Test Procedure

The EUT was assembled as required for operation and placed on a benchtop. This configuration provided the ability to connect test equipment to the provided test antenna port. Antenna Port conducted emissions testing was performed as presented in the regulations and specified in ANSI C63.10-2013. Antenna port conducted emissions testing was completed on a laboratory bench in a shielded room. The active antenna port of the device was connected to appropriate attenuation and the spectrum analyzer. Refer to diagram four showing typical test arrangement and photographs in the test setup exhibits for specific EUT placement during testing.

Diagram 1 Test arrangement for Conducted emissions

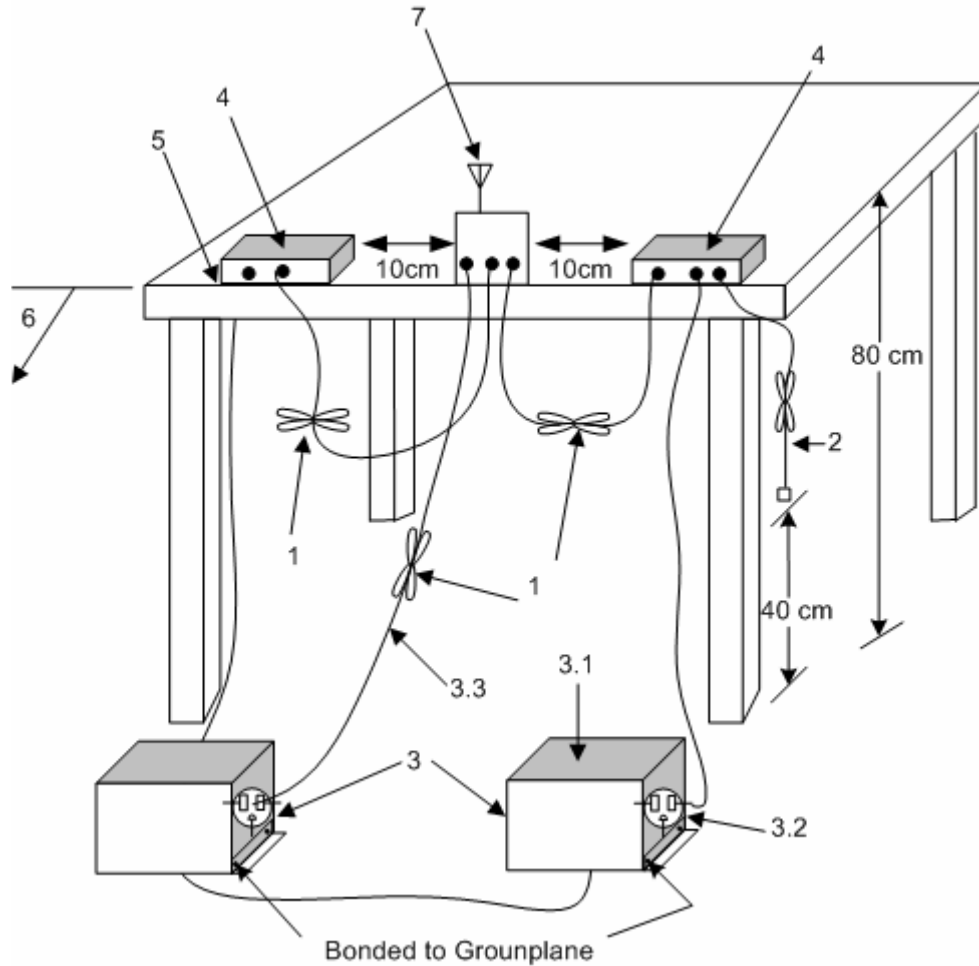

1. Interconnecting cables that hang closer than 40 cm to the ground plane shall be folded back and forth in the center forming a bundle 30 cm to 40 cm long see (see 6.2.3.1).
2. I/O cables that are not connected to an accessory shall be bundled in the center. The end of the cable may be terminated, if required, using the correct terminating impedance. The overall length shall not exceed 1 m (see 6.2.2).
3. EUT connected to one LISN. Unused LISN measuring port connectors shall be terminated in 50 Ω loads. LISN can be placed on top of, or immediately beneath, reference ground plane (see 6.2.2 and 6.2.3).
 - 3.1 All other equipment powered from additional LISN(s).
 - 3.2 Multiple-outlet strip can be used for multiple power cords of non-EUT equipment.
 - 3.3 LISN at least 80 cm from nearest part of EUT chassis.
4. Non-EUT components of EUT system being tested.
5. Rear of EUT, including peripherals, shall all be aligned and flush with rear of tabletop (see 6.2.3.1).
6. Edge of tabletop shall be 40 cm removed from a vertical conducting plane that is bonded to the ground plane (see 6.2.2 for options).
7. Antenna may be integral or detachable. If detachable, the antenna shall be attached for this test.

Diagram 2 Test arrangement for radiated emissions of tabletop equipment

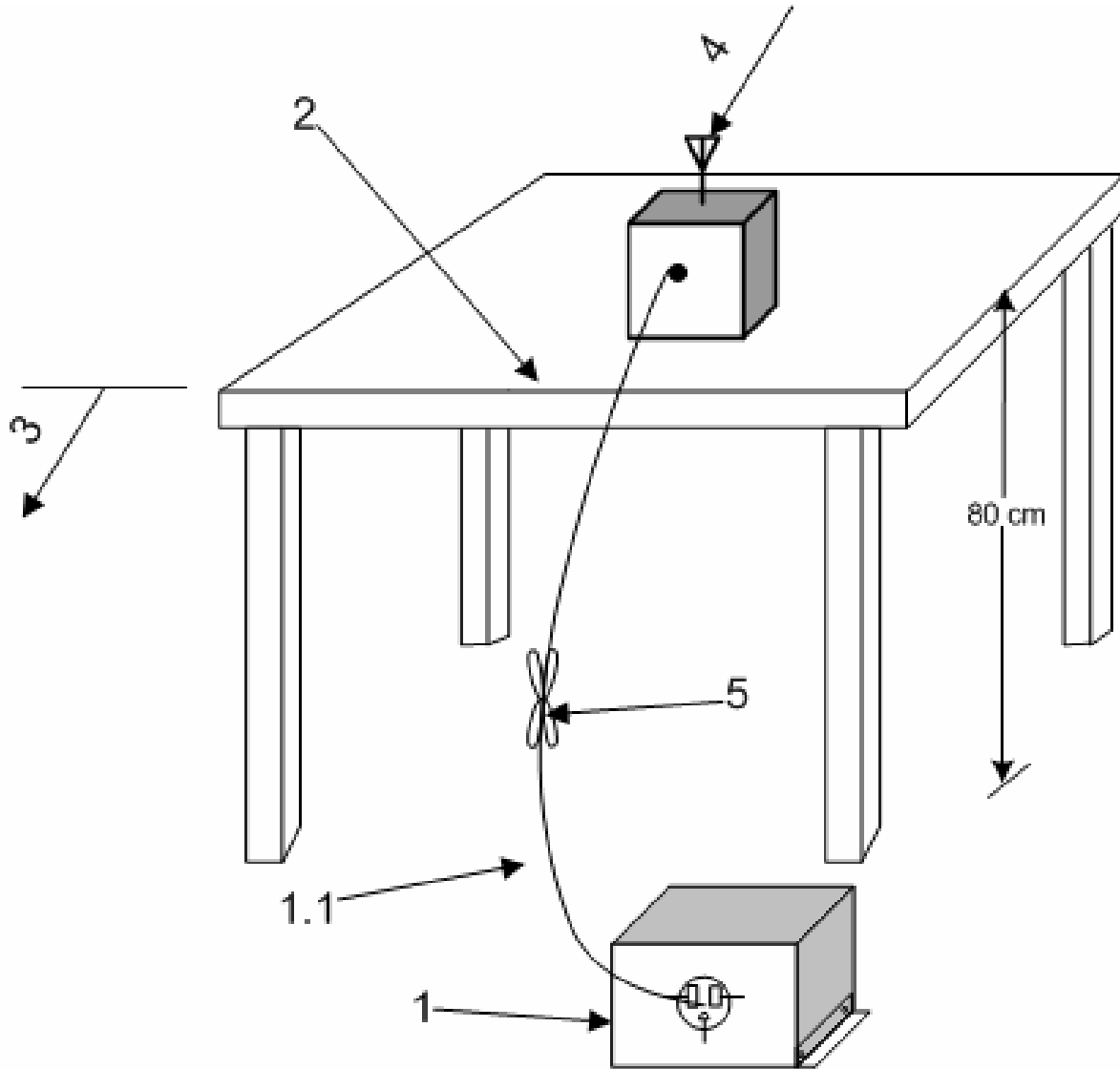

1—A LISN is optional for radiated measurements between 30 MHz and 1000 MHz but not allowed for measurements below 30 MHz and above 1000 MHz (see 6.3.1). If used, then connect EUT to one LISN. Unused LISN measuring port connectors shall be terminated in 50 Ω loads. The LISN may be placed on top of, or immediately beneath, the reference ground plane (see 6.2.2 and 6.2.3.2).

1.1—LISN spaced at least 80 cm from the nearest part of the EUT chassis.

2—Antenna can be integral or detachable, depending on the EUT (see 6.3.1).

3—Interconnecting cables that hang closer than 40 cm to the ground plane shall be folded back and forth in the center forming a bundle 30 cm to 40 cm long (see 6.3.1).

4—For emission measurements at or below 1 GHz, the table height shall be 80 cm. For emission measurements above 1 GHz, the table height shall be 1.5 m for measurements, except as otherwise specified (see 6.3.1 and 6.6.3.1).

Diagram 3 Test arrangement for radiated emissions tested on Open Area Test Site (OATS)

Test arrangement for radiated emissions Below 1 GHz

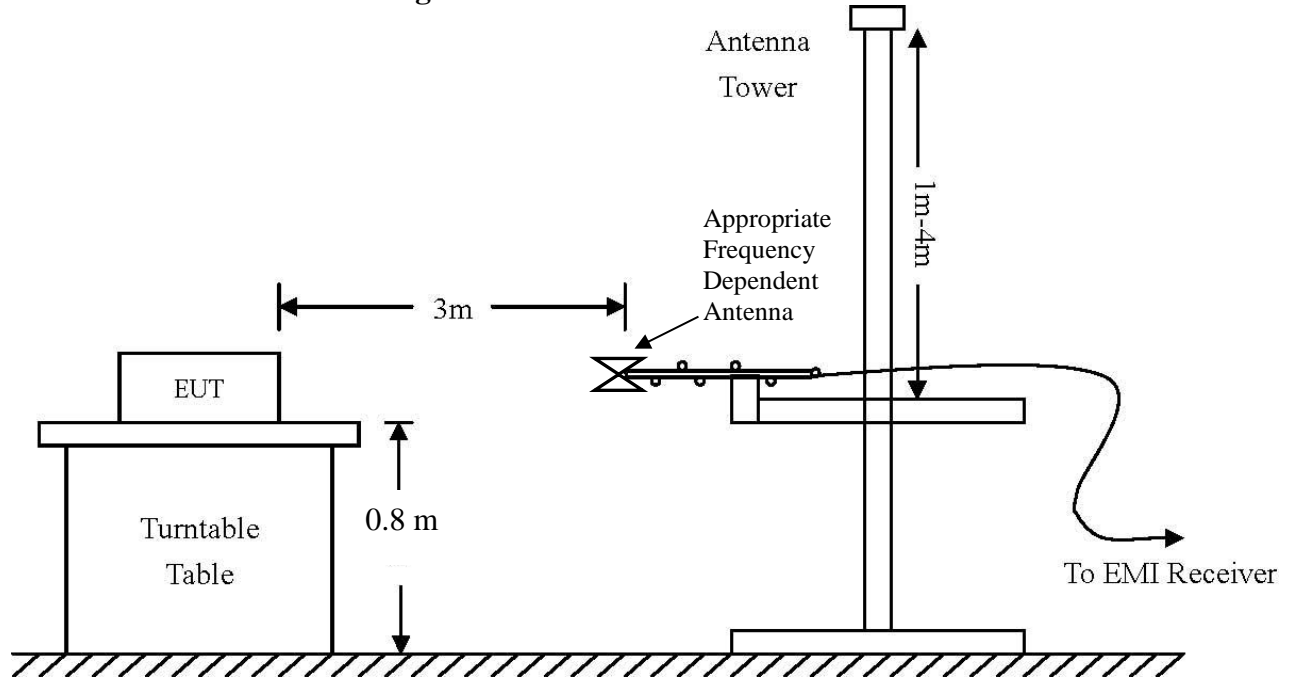

Test arrangement for radiated emissions Above 1 GHz

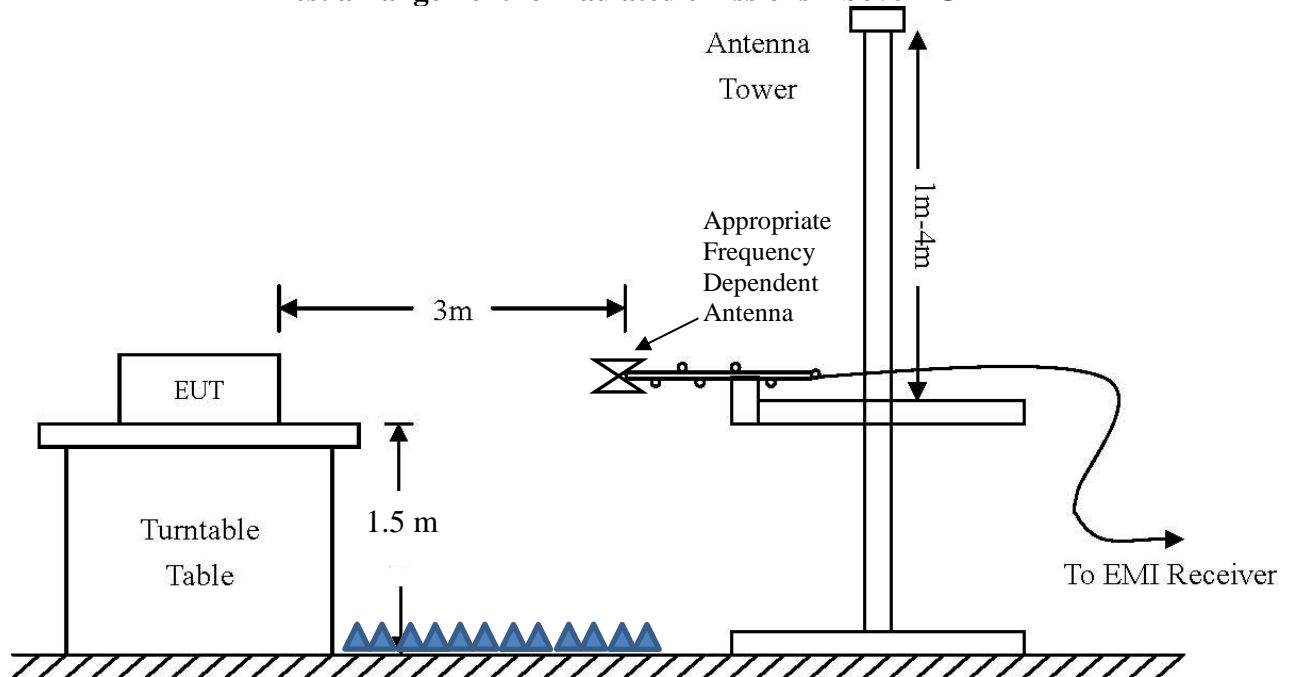
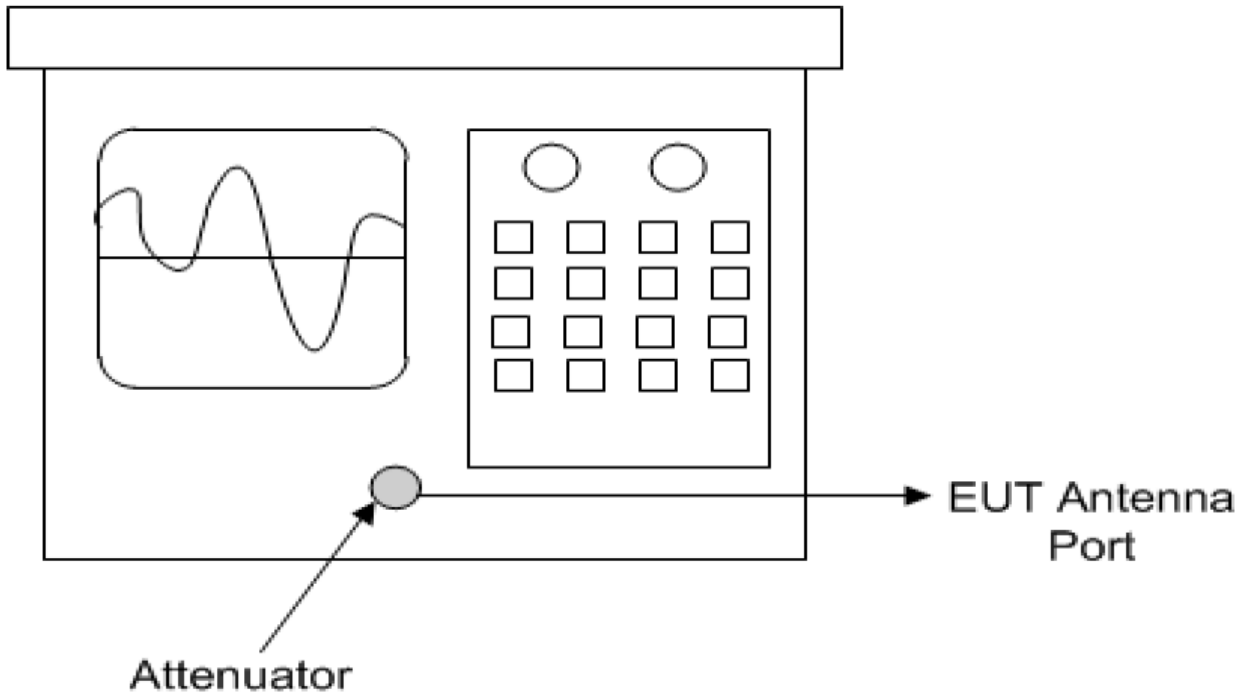

Diagram 4 Test arrangement for Antenna Port Conducted emissions Spectrum Analyzer



Test Site Locations

- Conducted EMI AC line conducted emissions testing performed in a shielded screen room located at Rogers Labs, Inc., 4405 West 259th Terrace, Louisburg, KS
- Antenna port Antenna port conducted emissions testing was performed in a shielded screen room located at Rogers Labs, Inc., 4405 West 259th Terrace, Louisburg, KS
- Radiated EMI The radiated emissions tests were performed at the 3 meters, Open Area Test Site (OATS) located at Rogers Labs, Inc., 4405 West 259th Terrace, Louisburg, KS

Registered Site information: FCC Site: US5305, ISED: 3041A, CAB Identifier: US0096

NVLAP Accreditation Lab code 200087-0

Units of Measurements

- Conducted EMI Data presented in dB μ V; dB referenced to one microvolt
- Antenna port Conducted Data is in dBm; dB referenced to one milliwatt
- Radiated EMI Data presented in dB μ V/m; dB referenced to one microvolt per meter

Note: Radiated limit may be expressed for measurement in dB μ V/m when the measurement is taken at a distance of 3 or 10 meters. Data taken for this report was taken at distance of 3 meters. Sample calculation demonstrates corrected field strength reading for Open Area Test Site using the measurement reading and correcting for receive antenna factor, cable and test system losses, and amplifier gains.

Sample Calculation:

RFS = Radiated Field Strength, FSM = Field Strength Measured

A.F. = Receive antenna factor, Losses = attenuators/cable losses, Gain = amplification gains

$RFS (dB\mu V/m @ 3m) = FSM (dB\mu V) + A.F. (dB/m) + Losses (dB) - Gain (dB)$

Environmental Conditions

Ambient Temperature 22.4° C

Relative Humidity 42%

Atmospheric Pressure 1002.0 mb

Rogers Labs, Inc.	SAF Tehnika AS	S/N's: 5376 / 5865
4405 W. 259th Terrace	M/N: TDSBOAU3 (4, 5, 6, 7)	FCC ID: W9Z-ARANETPP
Louisburg, KS 66053	Test: 230227A	IC: 8855A-ARANETPP
Phone/Fax: (913) 837-3214	Test to: 47CFR 15C, RSS-Gen RSS-247	Date: April 11, 2023
Revision r1	File: SAF ARANETPP PRO Plus TstRpt 230227Ar1	Page 15 of 39

Statement of Modifications and Deviations

No modifications to the EUT were required for the unit to demonstrate compliance with 47CFR Part 15C, RSS-247 Issue 2, and RSS-GEN Issue 5 emission requirements. There were no deviations to the specifications.

Intentional Radiators

The following information is submitted in support demonstration of compliance with the requirements of 47CFR, Paragraph 15 Subpart C, paragraph 15.247, Industry Canada RSS-247 Issue 2, and RSS-GEN Issue 5.

Antenna Requirements

The EUT incorporates integral antenna system and offers no provision for connection to alternate antenna system. The antenna connection point complies with the unique antenna connection requirements. There are no deviations or exceptions to the specification.

Restricted Bands of Operation

Spurious emissions falling in the restricted frequency bands of operation were measured at the OATS. The EUT utilizes frequency, determining circuitry, which generates harmonics falling in the restricted bands. Emissions were investigated at the OATS, using appropriate antennas or pyramidal horns, amplification stages, and a spectrum analyzer. Peak and average amplitudes of frequencies above 1000 MHz were compared to the required limits with worst-case data presented below. Test procedures of ANSI C63.10-2013 were used during testing. No other significant emission was observed which fell into the restricted bands of operation. Computed emission values consider the received radiated field strength, receive antenna correction factor, amplifier gain stage, and test system cable losses.

Table 1 Harmonic Radiated Emissions in Restricted Bands

Frequency in MHz	Horizontal Peak (dBμV/m)	Horizontal Average (dBμV/m)	Vertical Peak (dBμV/m)	Vertical Average (dBμV/m)	Limit @ 3m (dBμV/m)	Horizontal Average Margin (dB)	Vertical Average Margin (dB)
2769.6	47.8	35.8	45.7	32.8	54.0	-18.2	-21.2
3692.8	48.3	34.7	47.4	33.9	54.0	-19.3	-20.1
4616.0	49.4	36.0	48.8	35.6	54.0	-18.0	-18.4

Other emissions present had amplitudes at least 20 dB below the limit. Peak and Quasi-Peak amplitude emissions are recorded for frequency below 1000 MHz. Peak and Average amplitude emissions are recorded for frequency range above 1000 MHz.

Summary of Results for Radiated Emissions in Restricted Bands

The EUT demonstrated compliance with the radiated emissions requirements of 47CFR Part 15C, RSS-Gen, and RSS-247 Intentional Radiators. The EUT demonstrated a worst-case minimum radiated emission in restricted bands providing a minimum margin of -18.0 dB below the radiated emissions requirements. Peak and average amplitudes were checked for compliance with the regulations. Worst-case emissions are reported with other emissions found in the restricted frequency bands at least 20 dB below the requirements.

AC Line Conducted Emissions Procedure

The EUT was arranged in typical equipment configurations operating from AC power adapter. Testing was performed with the EUT placed on a 1 x 1.5-meter wooden bench 80 cm above the conducting ground plane, floor of a screen room. The bench was positioned 40 cm away from the wall of the screen room. The LISN was positioned on the floor of the screen room 80-cm from the rear of the EUT. Testing for the AC line-conducted emissions were the procedures of ANSI C63.10-2013 paragraph 6. The AC power adapter providing power to the EUT was connected to the LISN for AC line-conducted emissions testing. A second LISN was positioned on the floor of the screen room 80-cm from the rear of the supporting equipment of the EUT. All power cords except those providing power to the EUT were then powered from the second LISN. EMI was coupled to the spectrum analyzer through a 0.1 μ F capacitor, internal to the LISN. Power line conducted emissions testing was carried out individually for each current carrying conductor of the EUT. The excess length of lead between the system and the LISN receptacle was folded back and forth to form a bundle not exceeding 40 cm in length. The screen room, conducting ground plane, analyzer, and LISN were bonded together to the protective earth ground. Preliminary testing was performed to identify the frequencies of each of the emissions, which demonstrated the highest amplitudes. The cables were repositioned to obtain maximum amplitude of measured EMI level. Once the worst-case configuration was identified, plots were made of the EMI from 0.15 MHz to 30 MHz then data was recorded with maximum conducted emissions levels.

Refer to figures 1 and 2 for plots of the EUT – AC Line conducted emissions.

Figure 1 AC Line Conducted emissions line 1

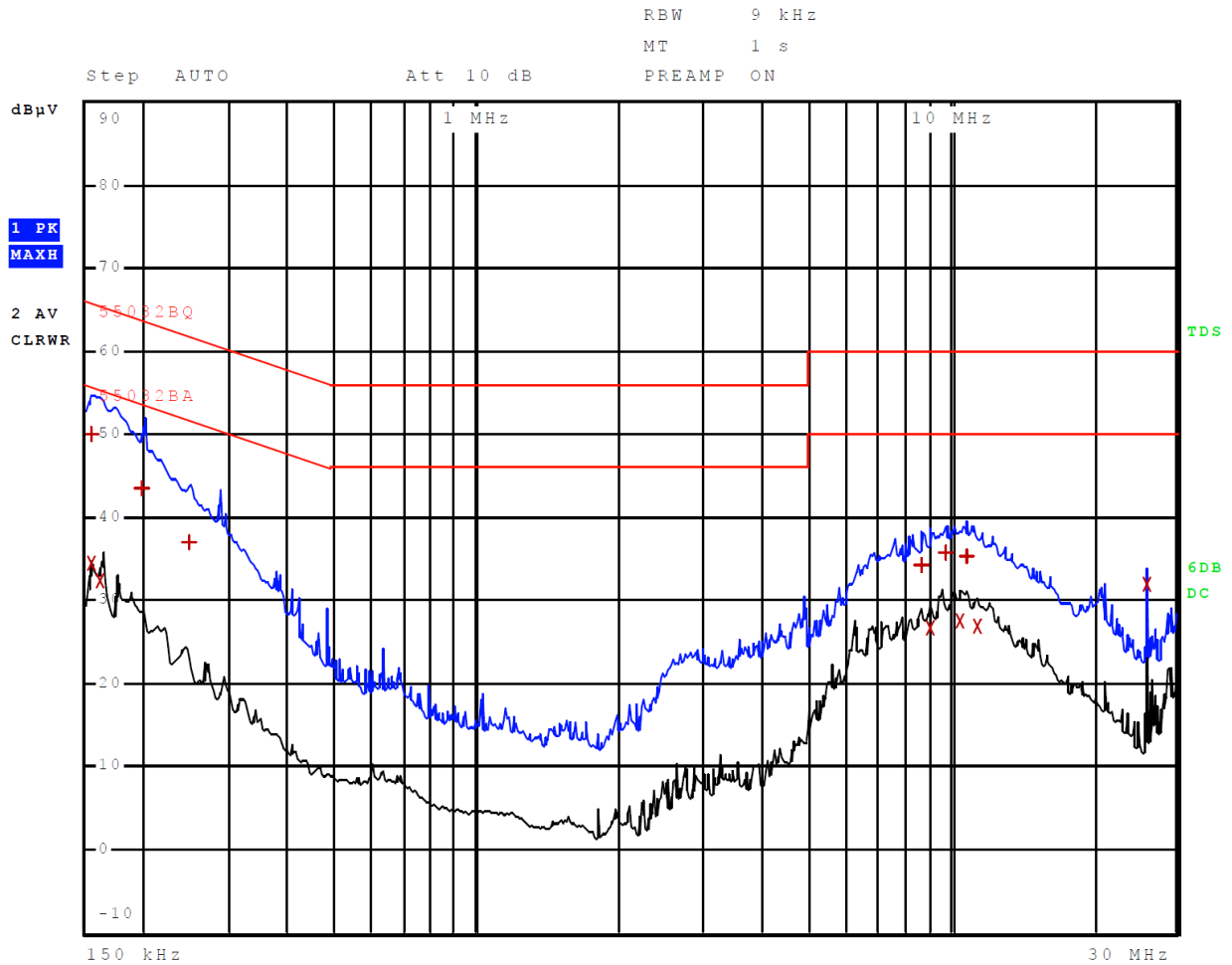

Figure 2 AC Line Conducted emissions line 2

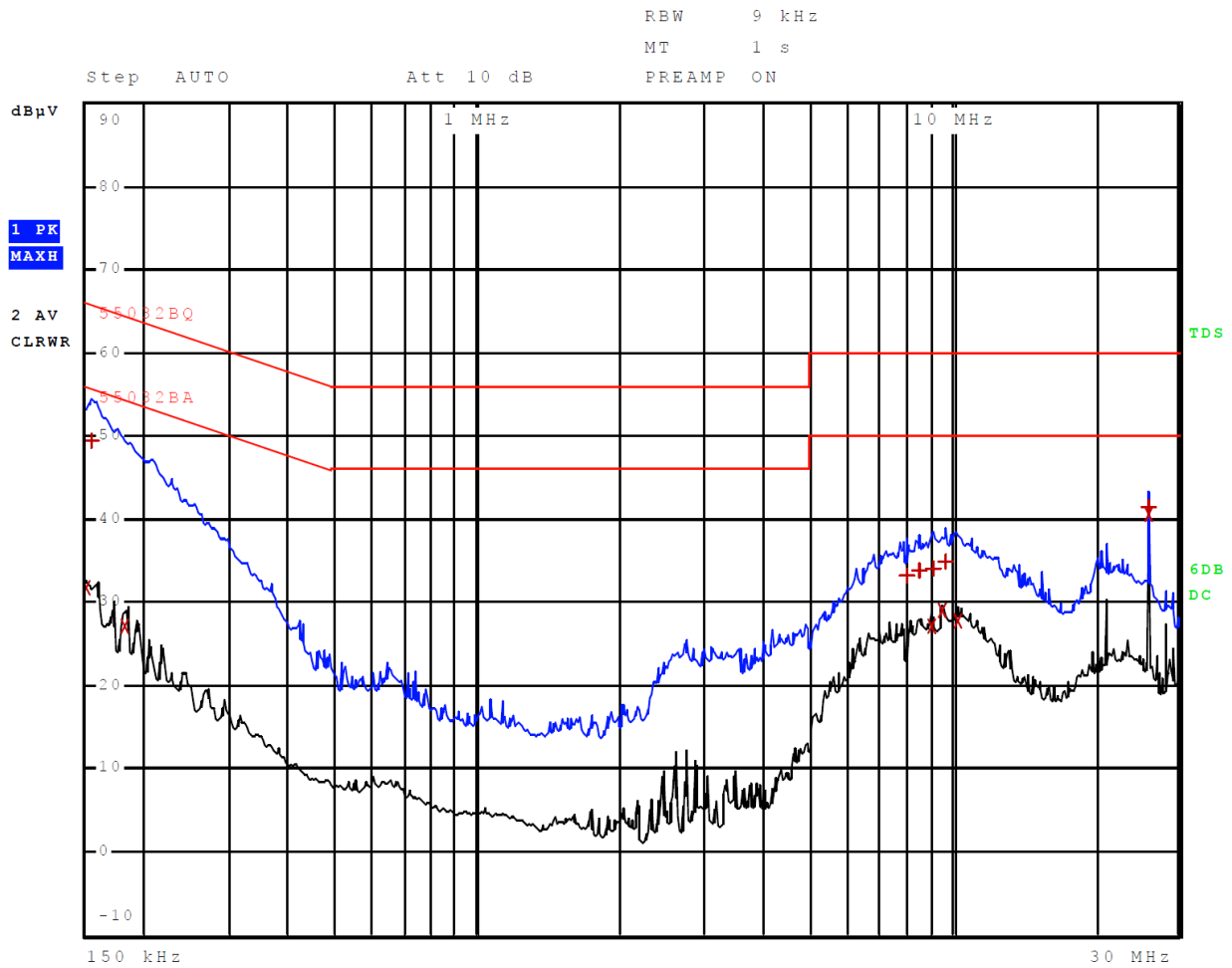

Table 2 AC Line Conducted Emissions Data L1

Trace	Frequency	Level (dBµV)	Detector	Delta Limit/dB
1	154.000000000 kHz	50.04	Quasi Peak	-15.74
2	154.000000000 kHz	34.41	Average	-21.37
2	162.000000000 kHz	32.39	Average	-22.97
1	198.000000000 kHz	43.47	Quasi Peak	-20.22
1	250.000000000 kHz	36.95	Quasi Peak	-24.81
1	8.647900000 MHz	34.19	Quasi Peak	-25.81
2	9.079900000 MHz	26.71	Average	-23.29
1	9.771900000 MHz	35.71	Quasi Peak	-24.29
2	10.491900000 MHz	27.58	Average	-22.42
1	10.859900000 MHz	35.25	Quasi Peak	-24.75
2	11.387900000 MHz	26.80	Average	-23.20
2	25.871900000 MHz	31.91	Average	-18.09

Other emissions present had amplitudes at least 20 dB below the limit.

Table 3 AC Line Conducted Emissions Data L2

Trace	Frequency	Level (dBµV)	Detector	Delta Limit/dB
2	150.000000000 kHz	31.66	Average	-24.34
1	154.000000000 kHz	49.31	Quasi Peak	-16.47
2	182.000000000 kHz	27.11	Average	-27.28
1	8.039900000 MHz	33.18	Quasi Peak	-26.82
1	8.527900000 MHz	33.70	Quasi Peak	-26.30
2	9.091900000 MHz	26.98	Average	-23.02
1	9.139900000 MHz	33.95	Quasi Peak	-26.05
2	9.539900000 MHz	29.04	Average	-20.96
1	9.699900000 MHz	34.75	Quasi Peak	-25.25
2	10.295900000 MHz	27.81	Average	-22.19
2	25.871900000 MHz	40.57	Average	-9.43
1	25.871900000 MHz	41.35	Quasi Peak	-18.65

Other emissions present had amplitudes at least 20 dB below the limit.

Summary of Results for AC Line Conducted Emissions Results

The EUT demonstrated compliance with the AC Line Conducted Emissions requirements of 47CFR Part 15C and other applicable emissions requirements. The worst-case configuration demonstrated a minimum margin of -9.4 dB below the requirement. Other emissions were present with amplitudes at least 20 dB below the limit and worst-case amplitudes recorded.

General Radiated Emissions Procedure

The EUT was arranged in a typical equipment configuration and operated through all available mode during testing. Both the LoRa and Wi-Fi transmitters were operating during testing. Preliminary testing was performed in a screen room with the EUT positioned 1 meter from the FSM. Radiated emissions measurements were performed to identify the frequencies, which produced the highest emissions. Each radiated emission was then maximized at the OATS location before final radiated measurements were performed. Final data was taken with the EUT located on the OATS at 3 meters distance between the EUT and the receiving antenna. The frequency spectrum from 9 kHz to 25,000 MHz was searched for general radiated emissions. Measured emission levels were maximized by EUT placement on the table, rotating the turntable through 360 degrees, varying the antenna height between 1 and 4 meters above the ground plane and changing antenna position between horizontal and vertical polarization. Antennas used were Loop from 9 kHz to 30 MHz, Broadband Biconical from 30 to 200 MHz, Biconilog from 30 to 1000 MHz, Log Periodic from 200 MHz to 1 GHz and or double Ridge or pyramidal horns and mixers above 1 GHz, notch filters and appropriate amplifiers and external mixers were utilized.

Table 4 General Radiated Emissions Data

Frequency in MHz	Horizontal Peak (dB μ V/m)	Horizontal Quasi-Peak (dB μ V/m)	Vertical Peak (dB μ V/m)	Vertical Quasi-Peak (dB μ V/m)	Limit @ 3m (dB μ V/m)	Horizontal Average Margin (dB)	Vertical Average Margin (dB)
63.5	37.7	32.0	38.1	32.2	40.0	-8.0	-7.8
68.2	35.4	31.5	36.6	29.4	40.0	-8.5	-10.6
94.4	40.6	36.7	40.1	37.0	40.0	-3.3	-3.0
145.2	35.4	31.0	38.2	32.9	40.0	-9.0	-7.1
148.1	37.1	31.4	37.3	32.6	40.0	-8.6	-7.4
151.5	32.4	28.3	38.3	31.9	40.0	-11.7	-8.1
159.6	35.9	24.9	35.2	32.4	40.0	-15.1	-7.6
219.4	36.5	31.3	35.1	30.5	40.0	-8.7	-9.5

Other emissions present had amplitudes at least 20 dB below the limit. Peak and Quasi-Peak amplitude emissions are recorded for frequency range below 1000 MHz. Peak and Average amplitude emissions are recorded for frequency range above 1000 MHz.

Summary of Results for General Radiated Emissions

The EUT demonstrated compliance with the radiated emissions requirements of 47CFR Part 15C paragraph 15.209, RSS-247 and RSS-GEN Intentional Radiators. The EUT demonstrated a minimum margin of -3.0 dB below the requirements. Other emissions were present with amplitudes at least 20 dB below the Limits.

Operation in the Band 902 – 928 MHz

The requirements and demonstration of compliance with RSS-247 and 47CFR subpart 15.247 are addressed below and as specified in KDB 558074 D01 15.247 Meas Guidance v05r02. Test sample #1 was used during radiated emissions measurements. Both the LoRa and Wi-Fi transmitters were operating during testing. Test sample #2 was provided for testing antenna port conducted emissions. Test sample #2 was modified by replacing the internal antenna with a 50-ohm antenna port connector and attenuator for testing purposes. The transmitter peak power was measured at the antenna port using a wideband RF power sensor as described in ANSI C63.10-2013 and KDB 558074. Radiated emission measurements were taken as required in ANSI C63.10-2013 and KDB 558074. The amplitude of each harmonic and general radiated emission was measured on the OATS at distance of 3 meters from the FSM antenna. Radiated emission testing was performed on sample #1 representative of production equipment with integral antenna. The EUT was positioned on supporting turntable elevated as required above the ground plane, at a distance of 3 meters from the FSM antenna. Radiated emission investigations were performed from 9 kHz to 25,000 MHz. Each radiated emission was maximized by varying the FSM antenna height and polarization, and by rotating the turntable. The worst-case amplitude of each emission was then recorded from the analyzer display. The peak and quasi-peak amplitude of frequencies below 1000 MHz were measured using a spectrum analyzer. The peak and average amplitude of frequencies above 1000 MHz were measured using a spectrum analyzer. A Loop antenna was used for measuring emissions from 0.009 to 30 MHz, Biconilog Antenna for 30 to 1000 MHz, Double-Ridge, and/or Pyramidal Horn Antennas from 1 GHz to 25 GHz. Radiated Emissions were measured in dB μ V/m @ 3 meters. Plots were taken of transmitter performance (using sample #2) for reference in this and other documentation displaying compliance with the specifications.

Figure 3 Plot of Transmitter Emissions in Operational Frequency Band

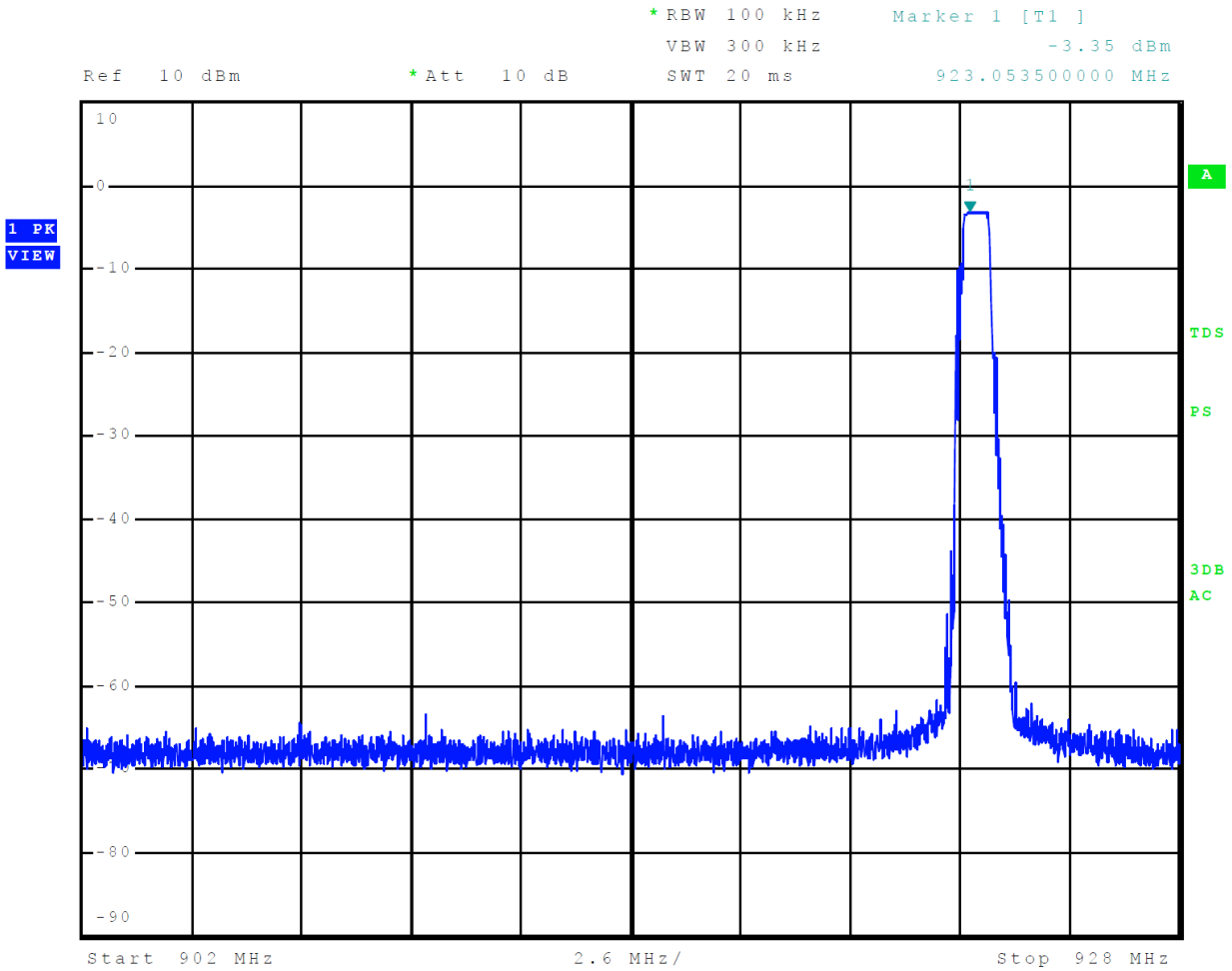

Figure 4 Plot of Transmitter Emissions Low Band Edge

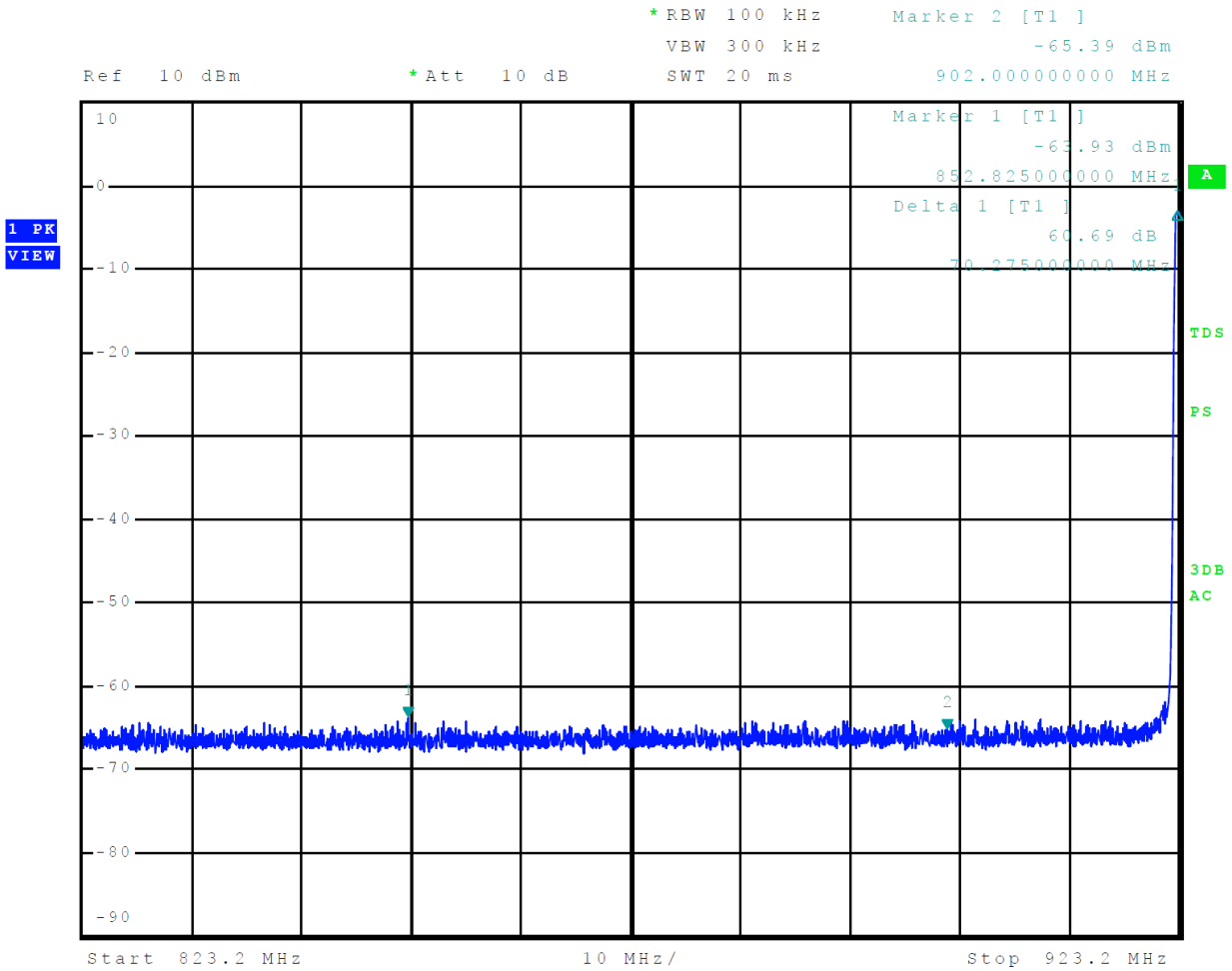

Figure 5 Plot of Transmitter Emissions High Band Edge

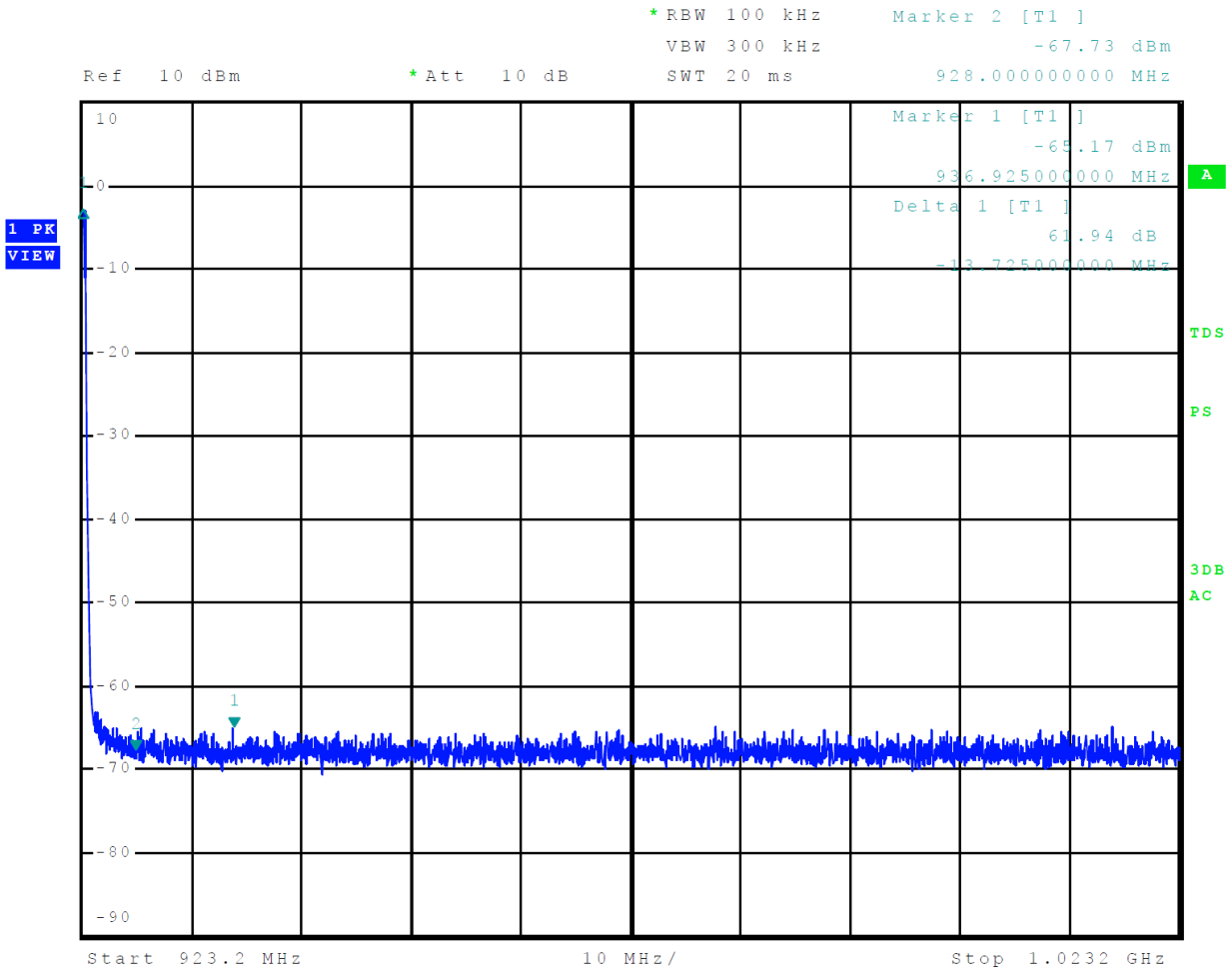

Figure 6 Plot of Transmitter Emissions 6-dB Occupied Bandwidth

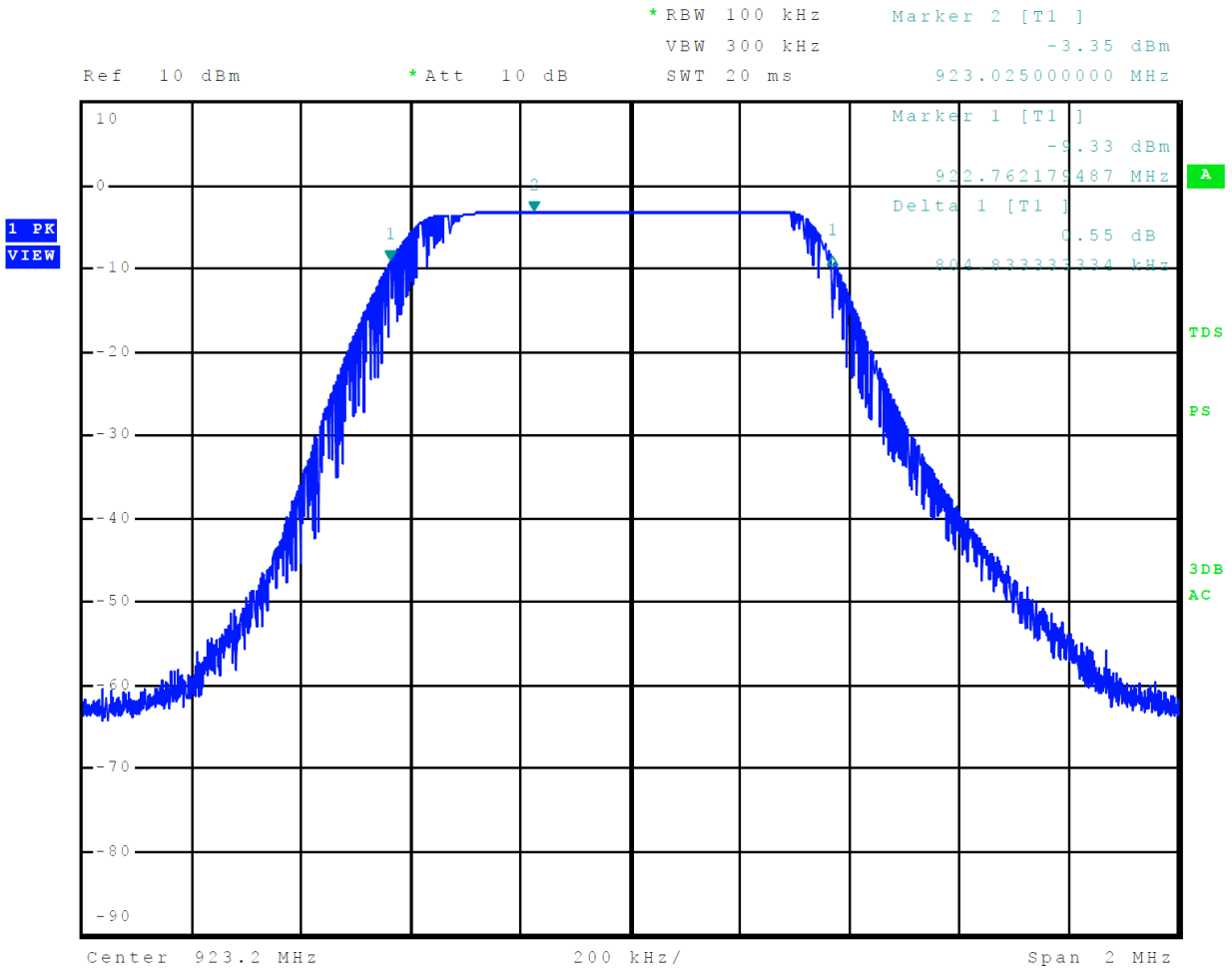

Figure 7 Plot of Transmitter Emissions 99% dB Occupied Bandwidth

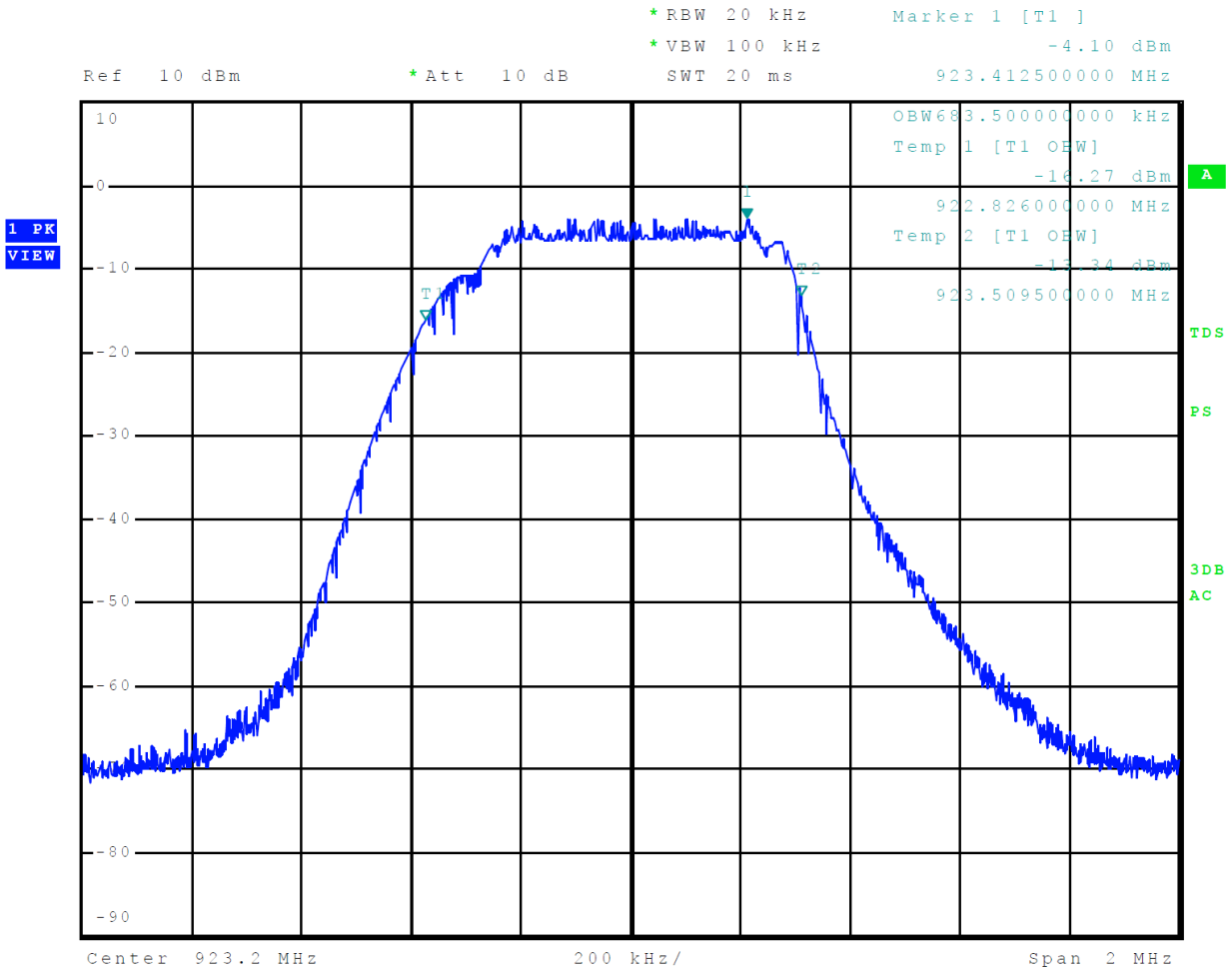

Figure 8 Plot of Transmitter Power Spectral Density

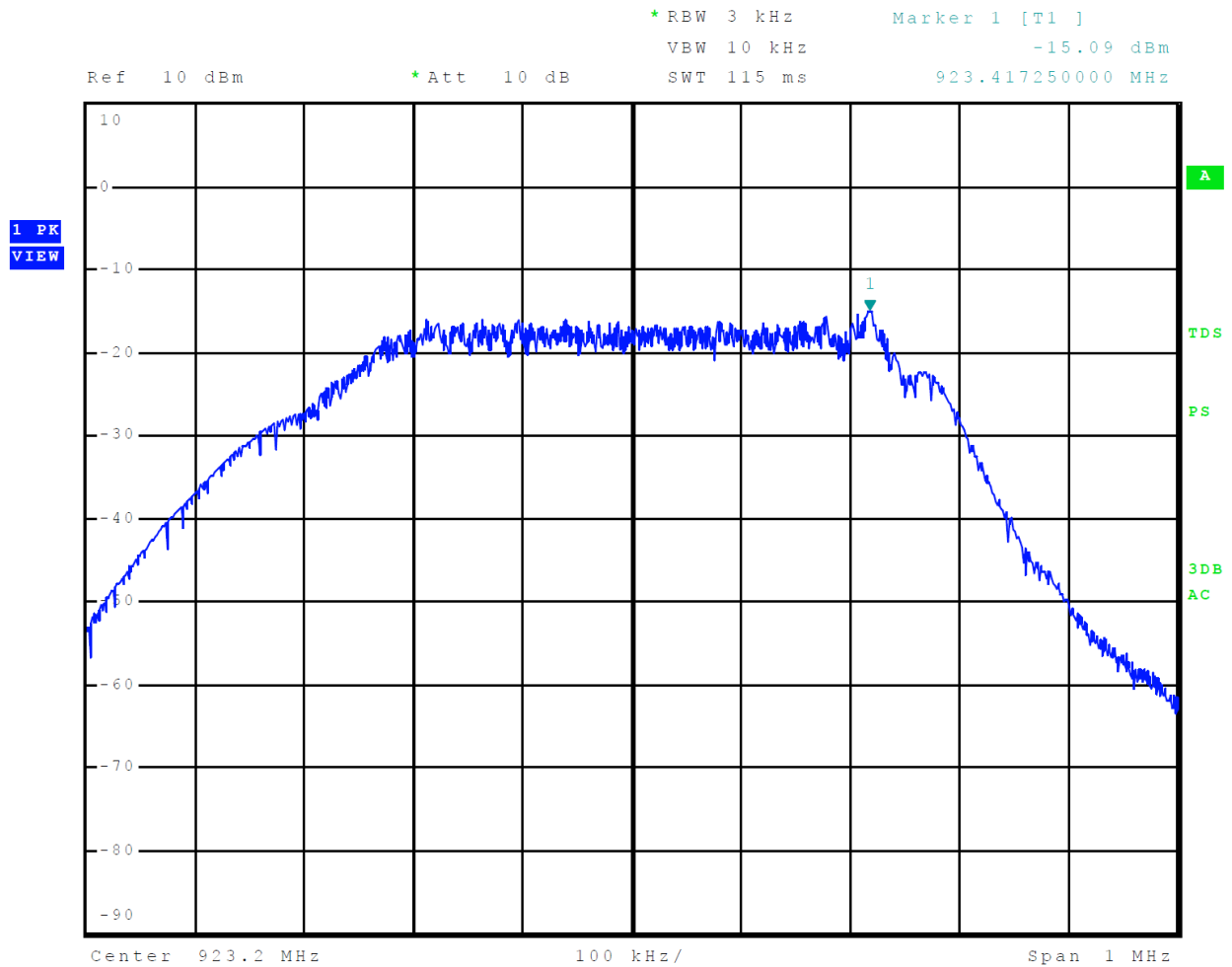
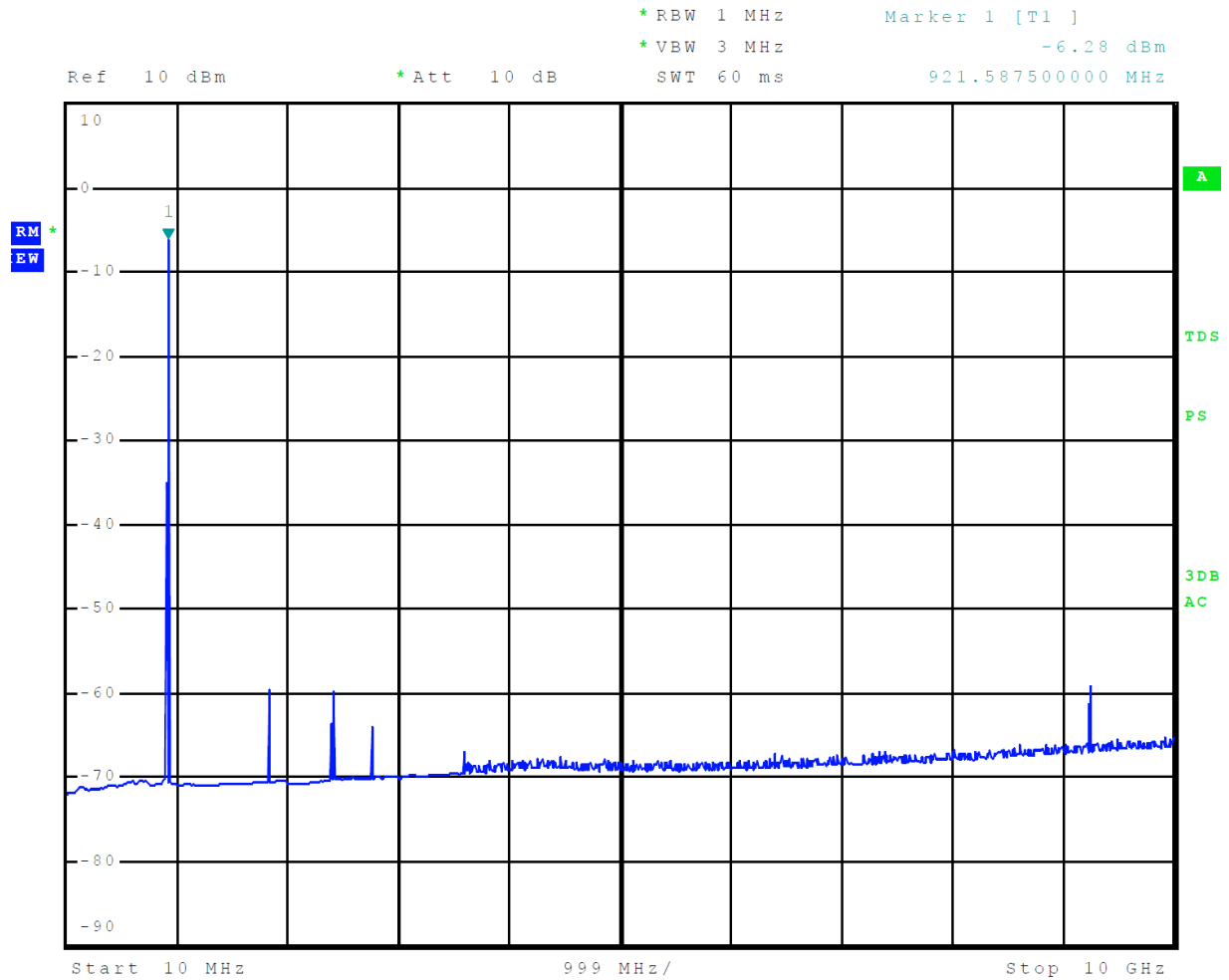

Figure 9 Plot of Transmitter Emissions at antenna port



Transmitter Emissions Data

Table 5 Transmitter Radiated Emission Worst-case Data

Frequency in MHz	Horizontal Peak (dB μ V/m)	Horizontal Average (dB μ V/m)	Vertical Peak (dB μ V/m)	Vertical Average (dB μ V/m)	Limit @ 3m (dB μ V/m)	Horizontal Average Margin (dB)	Vertical Average Margin (dB)
923.2	--	--	--	--	--	--	--
1846.4	46.3	37.6	47.4	40.9	54.0	-16.4	-13.1
2769.6	47.8	35.8	45.7	32.8	54.0	-18.2	-21.2
3692.8	48.3	34.7	47.4	33.9	54.0	-19.3	-20.1
4616.0	49.4	36.0	48.8	35.6	54.0	-18.0	-18.4
5539.2	51.3	37.3	50.5	37.2	54.0	-16.7	-16.8
6462.4	52.7	39.3	52.6	39.2	54.0	-14.7	-14.8

Other emissions present had amplitudes at least 20 dB below the limit. Peak and Quasi-Peak amplitude emissions are recorded for frequency below 1000 MHz. Peak and Average amplitude emissions are recorded for frequency range above 1000 MHz.

Table 6 Transmitter Antenna Port Data

Frequency MHz	Antenna Port Output Power (Watts)	99% Occupied Bandwidth (kHz)	20-dB Occupied Bandwidth (kHz)	6-dB Occupied Bandwidth (kHz)	Peak Power Spectral Density (dBm/3kHz)
923.2	0.001	683.5	782.4	804.8	-15.09

Summary of Results for Transmitter Radiated Emissions of Intentional Radiator

The EUT demonstrated compliance with the radiated emissions requirements of 47CFR Part 15.247, RSS-GEN, and RSS-247 Digital Transmission Systems. The antenna port conducted output power measured was 0.001 Watts. The spectral density measured at the antenna port presented a minimum margin of -23.1 dB below the requirements. The transmitter demonstrated a minimum margin of -13.1 dB below the harmonic emissions requirements. There were no other significantly measurable emissions in the restricted bands other than those recorded in this report. Other emissions were present with amplitudes at least 20 dB below the requirements. There were no other deviations or exceptions to the requirements.

Annex

- Annex A Measurement Uncertainty Calculations
- Annex B Test Equipment
- Annex C Rogers Qualifications
- Annex D Laboratory Certificate of Accreditation

Annex A Measurement Uncertainty Calculations

The measurement uncertainty was calculated for all measurements listed in this test report according to CISPR 16-4. Result of measurement uncertainty calculations are recorded below. Component and process variability of production devices similar to those tested may result in additional deviations. The manufacturer has the sole responsibility of continued compliance.

Measurement	Expanded Measurement Uncertainty $U_{(lab)}$
3 Meter Horizontal 0.009-1000 MHz Measurements	4.16
3 Meter Vertical 0.009-1000 MHz Measurements	4.33
3 Meter Measurements 1-18 GHz	5.14
3 Meter Measurements 18-40 GHz	5.16
10 Meter Horizontal Measurements 0.009-1000 MHz	4.15
10 Meter Vertical Measurements 0.009-1000 MHz	4.32
AC Line Conducted	1.75
Antenna Port Conducted power	1.17
Frequency Stability	1.00E-11
Temperature	1.6°C
Humidity	3%

Annex B Test Equipment

<u>Equipment</u>	<u>Manufacturer</u>	<u>Model (SN)</u>	<u>Band</u>	<u>Cal Date(m/d/y)</u>	<u>Due</u>
<input checked="" type="checkbox"/> LISN	FCC	FCC-LISN-50-25-10(1PA) (160611)	.15-30MHz	3/29/2022	3/29/2023
<input checked="" type="checkbox"/> LISN: Fischer Custom Communications Model: FCC-LISN-50-16-2-08				3/29/2022	3/29/2023
<input checked="" type="checkbox"/> Cable	Huber & Suhner Inc.	Sucoflex102ea(L10M)(303073)	9kHz-40 GHz	10/11/2022	10/11/2023
<input type="checkbox"/> Cable	Huber & Suhner Inc.	Sucoflex102ea(1.5M)(303069)	9kHz-40 GHz	10/11/2022	10/11/2023
<input checked="" type="checkbox"/> Cable	Huber & Suhner Inc.	Sucoflex102ea(1.5M)(303070)	9kHz-40 GHz	10/11/2022	10/11/2023
<input checked="" type="checkbox"/> Cable	Belden	RG-58 (L1-CAT3-11509)	9kHz-30 MHz	10/11/2022	10/11/2023
<input type="checkbox"/> Cable	Belden	RG-58 (L2-CAT3-11509)	9kHz-30 MHz	10/11/2022	10/11/2023
<input checked="" type="checkbox"/> Antenna	Com Power	AL-130 (121055)	.001-30 MHz	10/11/2022	10/11/2023
<input type="checkbox"/> Antenna:	EMCO	6509	.001-30 MHz	10/14/2020	10/11/2023
<input type="checkbox"/> Antenna	ARA	BCD-235-B (169)	20-350MHz	10/11/2022	10/11/2023
<input checked="" type="checkbox"/> Antenna	Sunol	JB-6 (A100709)	30-1000 MHz	10/11/2022	10/11/2023
<input type="checkbox"/> Antenna	ETS-Lindgren	3147 (40582)	200-1000MHz	10/11/2022	10/11/2024
<input checked="" type="checkbox"/> Antenna	ETS-Lindgren	3117 (200389)	1-18 GHz	3/29/2022	3/29/2024
<input type="checkbox"/> Antenna	Com Power	AH-118 (10110)	1-18 GHz	10/11/2022	10/11/2024
<input checked="" type="checkbox"/> Antenna	Com Power	AH-840 (101046)	18-40 GHz	4/6/2021	4/6/2023
<input checked="" type="checkbox"/> Analyzer	Rohde & Schwarz	ESU40 (100108)	20Hz-40GHz	3/9/2022	3/9/2023
<input checked="" type="checkbox"/> Analyzer	Rohde & Schwarz	ESW44 (101534)	20Hz-44GHz	1/25/2023	1/25/2024
<input type="checkbox"/> Analyzer	Rohde & Schwarz	FS-Z60, 90, 140, and 220	40GHz-220GHz	12/22/2017	12/22/2027
<input checked="" type="checkbox"/> Amplifier	Com-Power	PA-010 (171003)	100Hz-30MHz	10/11/2022	10/11/2023
<input checked="" type="checkbox"/> Amplifier	Com-Power	CPPA-102 (01254)	1-1000 MHz	10/11/2022	10/11/2023
<input checked="" type="checkbox"/> Amplifier	Com-Power	PAM-118A (551014)	0.5-18 GHz	10/11/2022	10/11/2023
<input checked="" type="checkbox"/> Amplifier	Com-Power	PAM-840A (461328)	18-40 GHz	10/11/2022	10/11/2023
<input checked="" type="checkbox"/> Pwr Sensor	Rohde & Schwarz	NRP33T	0.05-33 GHz	8/31/2022	8/31/2023
<input type="checkbox"/> Power Meter	Agilent	N1911A with N1921A	0.05-40 GHz	3/29/2022	3/29/2023
<input type="checkbox"/> Generator	Rohde & Schwarz	SMB100A6 (100150)	20Hz-6 GHz	3/29/2022	3/29/2023
<input type="checkbox"/> Generator	Rohde & Schwarz	SMBV100A6 (260771)	20Hz-6 GHz	3/29/2022	3/29/2023
<input type="checkbox"/> RF Filter	Micro-Tronics	HPM50114 (017)1.5G HPF	30-18000 MHz	4/6/2021	4/6/2023
<input type="checkbox"/> RF Filter	Micro-Tronics	HPM50117 (063) 3G HPF	30-18000 MHz	4/6/2021	4/6/2023
<input type="checkbox"/> RF Filter	Micro-Tronics	HPM50105 (059) 6G HPF	30-18000 MHz	4/6/2021	4/6/2023
<input type="checkbox"/> RF Filter	Micro-Tronics	BRM50702 (172) 2G notch	30-18000 MHz	4/6/2021	4/6/2023
<input type="checkbox"/> RF Filter	Micro-Tronics	BRC50703 (G102) 5G notch	30-18000 MHz	4/6/2021	4/6/2023
<input type="checkbox"/> RF Filter	Micro-Tronics	BRC50705 (024) 5G notch	30-18000 MHz	4/6/2021	4/6/2023
<input type="checkbox"/> Attenuator	Fairview	SA6NFNF100W-40 (1625)	30-18000 MHz	3/29/2022	3/29/2023
<input type="checkbox"/> Attenuator	Mini-Circuits	VAT-3W2+ (1436)	30-6000 MHz	3/29/2022	3/29/2023
<input type="checkbox"/> Attenuator	Mini-Circuits	VAT-3W2+ (1445)	30-6000 MHz	3/29/2022	3/29/2023
<input type="checkbox"/> Attenuator	Mini-Circuits	VAT-3W2+ (1735)	30-6000 MHz	3/29/2022	3/29/2023
<input type="checkbox"/> Attenuator	Mini-Circuits	VAT-6W2+ (1438)	30-6000 MHz	3/29/2022	3/29/2023
<input type="checkbox"/> Attenuator	Mini-Circuits	VAT-6W2+ (1736)	30-6000 MHz	3/29/2022	3/29/2023
<input checked="" type="checkbox"/> Weather station	Davis	6312 (A81120N075)		10/11/2022	10/11/2023

Rogers Labs, Inc.
 4405 W. 259th Terrace
 Louisburg, KS 66053
 Phone/Fax: (913) 837-3214
 Revision r1

SAF Tehnika AS
 M/N: TDSBOAU3 (4, 5, 6, 7)
 Test: 230227A

S/N's: 5376 / 5865
 FCC ID: W9Z-ARANETPP
 IC: 8855A-ARANETPP

Test to: 47CFR 15C, RSS-Gen RSS-247
 Date: April 11, 2023
 File: SAF ARANETPP PRO Plus TstRpt 230227Ar1
 Page 36 of 39

List of Test Equipment

Calibration Date (m/d/y) Due

<input type="checkbox"/>	Frequency Counter: Leader LDC-825 (8060153)	3/29/2022	3/29/2023
<input type="checkbox"/>	ISN: Com-Power Model ISN T-8	3/29/2022	3/29/2023
<input type="checkbox"/>	LISN Compliance Design FCC-LISN-2.Mod.cd,(126) .15-30MHz	10/11/2022	10/11/2024
<input type="checkbox"/>	LISN: Com-Power Model LI-220A	3/29/2022	3/29/2024
<input type="checkbox"/>	LISN: Com-Power Model LI-550C	10/11/2022	10/11/2024
<input type="checkbox"/>	Cable Huber & Suhner Inc. Sucoflex102ea(1.5M)(303072) 9kHz-40 GHz	10/11/2022	10/11/2023
<input type="checkbox"/>	Cable Huber & Suhner Inc. Sucoflex102ea(L1M)(281183) 9kHz-40 GHz	10/11/2022	10/11/2023
<input type="checkbox"/>	Cable Huber & Suhner Inc. Sucoflex102ea(L4M)(281184) 9kHz-40 GHz	10/11/2022	10/11/2023
<input type="checkbox"/>	Cable Huber & Suhner Inc. Sucoflex102ea(L10M)(317546)9kHz-40 GHz	10/11/2022	10/11/2023
<input type="checkbox"/>	Cable Time Microwave 4M-750HF290-750 (4M) 9kHz-24 GHz	10/11/2022	10/11/2023
<input type="checkbox"/>	RF Filter Micro-Tronics BRC17663 (001) 9.3-9.5 notch 30-1800 MHz	4/6/2021	4/6/2023
<input type="checkbox"/>	RF Filter Micro-Tronics BRC19565 (001) 9.2-9.6 notch 30-1800 MHz	10/14/2021	10/14/2023
<input type="checkbox"/>	Analyzer HP 8562A (3051A05950) 9kHz-125GHz	3/29/2022	3/29/2023
<input type="checkbox"/>	Wave Form Generator Keysight 33512B (MY57400128)	3/29/2022	3/29/2024
<input type="checkbox"/>	Antenna: Solar 9229-1 & 9230-1	2/18/2023	2/18/2024
<input type="checkbox"/>	CDN: Com-Power Model CDN325E	10/11/2022	10/11/2024
<input type="checkbox"/>	Oscilloscope Scope: Tektronix MDO 4104	2/18/2023	2/18/2024
<input type="checkbox"/>	EMC Transient Generator HVT TR 3000	2/18/2023	2/18/2024
<input type="checkbox"/>	AC Power Source (Ametech, California Instruments)	2/18/2023	2/18/2024
<input type="checkbox"/>	Field Intensity Meter: EFM-018	2/18/2023	2/18/2024
<input type="checkbox"/>	ESD Simulator: MZ-15	2/18/2023	2/18/2024
<input type="checkbox"/>	Injection Clamp Luthi Model EM101	not required	
<input type="checkbox"/>	R.F. Power Amp ACS 230-50W	not required	
<input type="checkbox"/>	R.F. Power Amp EIN Model: A301	not required	
<input type="checkbox"/>	R.F. Power Amp A.R. Model: 10W 1010M7	not required	
<input type="checkbox"/>	R.F. Power Amp A.R. Model: 50U1000	not required	
<input type="checkbox"/>	Temperature Chamber	not required	
<input checked="" type="checkbox"/>	Shielded Room	not required	



NVLAP Lab Code 200087-0

Annex C Rogers Qualifications

Scot D. Rogers, Engineer

Rogers Labs, Inc.

Mr. Rogers has approximately 36 years' experience in the field of electronics. Work experience includes working in the automated controls industry and remaining years working with the design, development and testing of radio communications and electronic equipment.

Positions Held:

Systems Engineer: A/C Controls Mfg. Co., Inc.

Electrical Engineer: Rogers Consulting Labs, Inc.

Electrical Engineer: Rogers Labs, Inc. Current

Educational Background:

Bachelor of Science Degree in Electrical Engineering from Kansas State University

Bachelor of Science Degree in Business Administration Kansas State University

Several Specialized Training courses and seminars pertaining to Microprocessors and Software programming

Annex D Laboratory Certificate of Accreditation

United States Department of Commerce
National Institute of Standards and Technology



Certificate of Accreditation to ISO/IEC 17025:2017

NVLAP LAB CODE: 200087-0

Rogers Labs, Inc.
Louisburg, KS

*is accredited by the National Voluntary Laboratory Accreditation Program for specific services,
listed on the Scope of Accreditation, for:*

Electromagnetic Compatibility & Telecommunications

*This laboratory is accredited in accordance with the recognized International Standard ISO/IEC 17025:2017.
This accreditation demonstrates technical competence for a defined scope and the operation of a laboratory quality
management system (refer to joint ISO-ILAC-IAF Communiqué dated January 2009).*

2022-03-22 through 2023-03-31

Effective Dates



For the National Voluntary Laboratory Accreditation Program

Rogers Labs, Inc.
4405 W. 259th Terrace
Louisburg, KS 66053

SAF Tehnika AS
M/N: TDSBOAU3 (4, 5, 6, 7)
Test: 230227A

S/N's: 5376 / 5865
FCC ID: W9Z-ARANETPP
IC: 8855A-ARANETPP

Phone/Fax: (913) 837-3214
Revision r1

Test to: 47CFR 15C, RSS-Gen RSS-247
File: SAF ARANETPP PRO Plus TstRpt 230227Ar1

Date: April 11, 2023
Page 39 of 39