

Application For Grant of Certification

Model: TDSB0P02 (Aranet Mini Base)
902-928 MHz (DXX)
Low Power Transmitter

FCC ID: W9Z-ARANETMINI
IC: 8855A-ARANETMINI

FOR

SAF Tehnika AS

24a, Ganibu dambis
Riga Latvia LV-1005

FCC Designation: US5305
IC Test Site Registration: 3041A-1

Test Report Number: 171114

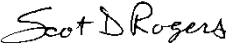
Authorized Signatory: 
Scot D. Rogers

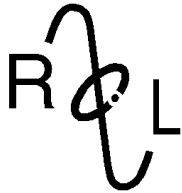

ROGERS LABS, INC.

4405 West 259th Terrace
Louisburg, KS 66053
Phone / Fax (913) 837-3214

Engineering Test Report For Grant of Certification Application

CFR 47, PART 15C - Intentional Radiators
CFR 47 Paragraph 15.249 and
Industry Canada RSS-210 Issue 9, RSS-GEN Issue 4
License Exempt Intentional Radiator

For

SAF Tehnika AS

24a, Ganību dambis
Rīga Latvia LV-1005

Hybrid Digital Transmission System
Model: TDSB0P02 (Aranet Mini Base)

Frequency Range 902-928 MHz
FCC ID: W9Z-ARANETMINI
IC: 8855A-ARANETMINI

Test Date: November 14, 2017

Certifying Engineer: *Scot D. Rogers*
Scot D. Rogers
Rogers Labs, Inc.
4405 West 259th Terrace
Louisburg, KS 66053
Telephone/Facsimile: (913) 837-3214

This report shall not be reproduced except in full, without the written approval of the laboratory.
This report must not be used by the client to claim product certification, approval, or
endorsement by NVLAP, NIST, or any agency of the Federal Government.

Rogers Labs, Inc.	SAF Tehnika AS	S/N: 336771 100001
4405 W. 259th Terrace	Model: TDSB0P02, Aranet Mini Base	FCC ID: W9Z-ARANETMINI
Louisburg, KS 66053	Test #: 171114	IC: 8855A- ARANETMINI
Phone/Fax: (913) 837-3214	Test to: CFR47 15C, RSS-Gen RSS-210	Date: February 1, 2018
Revision 1	File: SAF ARANETMINI DXX TstRpt 171114	Page 2 of 29

Table of Contents

TABLE OF CONTENTS.....	3
REVISIONS.....	5
FOREWORD.....	6
OPINION / INTERPRETATION OF RESULTS	6
EQUIPMENT TESTED.....	6
Equipment Function	7
Equipment Configuration.....	7
APPLICATION FOR CERTIFICATION.....	8
APPLICABLE STANDARDS & TEST PROCEDURES	9
TESTING PROCEDURES	9
AC Line Conducted Emission Test Procedure	9
Radiated Emission Test Procedure.....	9
Diagram 1 Test arrangement for Conducted emissions	10
Diagram 2 Test arrangement for radiated emissions of tabletop equipment.....	11
Diagram 3 Test arrangement for radiated emissions tested on Open Area Test Site (OATS).....	12
TEST SITE LOCATIONS	12
LIST OF TEST EQUIPMENT	13
UNITS OF MEASUREMENTS	14
ENVIRONMENTAL CONDITIONS.....	14
STATEMENT OF MODIFICATIONS AND DEVIATIONS	14
INTENTIONAL RADIATORS.....	14
Antenna Requirements	14

Restricted Bands of Operation.....15

Table 1 Harmonic Radiated Emissions in Restricted Bands Data15

Summary of Results for Radiated Emissions in Restricted Bands15

AC Line Conducted Emissions Procedure16

Figure 1 AC Line Conducted emissions of EUT line 117

Figure 2 AC Line Conducted emissions of EUT line 217

Table 2 AC Line Conducted Emissions Data L118

Table 3 AC Line Conducted Emissions Data L2.....18

Summary of Results for AC Line Conducted Emissions Results.....18

General Radiated Emissions Procedure.....19

Table 3 General Radiated Emissions Data19

Summary of Results for General Radiated Emissions19

Operation in the Band 902-928 MHz.....20

Figure 3 Plot of Transmitter Emissions in Operational Frequency Band21

Figure 4 Plot of Lower Band Edge21

Figure 5 Plot of Upper Band Edge.....22

Figure 6 Plot of Transmitter 99% Occupied Bandwidth.....22

Figure 7 Plot of Transmitter 6-dB Occupied Bandwidth.....23

Transmitter Emissions Data.....23

Table 4 Transmitter Radiated Emission Worst-case.....23

Summary of Results for Transmitter Radiated Emissions of Intentional Radiator.....24

ANNEX..... 25

Annex A Measurement Uncertainty Calculations.....26

Annex B Rogers Labs Test Equipment List.....27

Annex C Rogers Qualifications28

Revisions

Revision 1 Issued February 1, 2018

Foreword

The following information is submitted for consideration in obtaining Grant of Certification for License Exempt Low Power Transmitter System Intentional Radiator operating under Code of Federal Regulations Title 47 (CFR47) Paragraph 15.249 and Industry Canada RSS-GEN, Issue 4 and RSS-210 Issue 9, operation in the 902-928 MHz band.

Name of Applicant: SAF Tehnika AS
24a, Ganibu dambis
Riga Latvia LV-1005

M/N: TDSB0P02

FCC ID: W9Z-ARANETMINI IC: 8855A-ARANETMINI

Frequency Range: 923 MHz output power 93.7 dBμV/m @ 3 meters
(99% Occupied bandwidth 723.0 kHz)

Opinion / Interpretation of Results

Tests Performed	Margin (dB)	Results
Emissions 15.205, RSS-GEN	-19.8	Complies
Emissions as per CFR 47 paragraphs 2 and 15.207	-10.8	Complies
Emissions as per CFR 47 paragraphs 2 and 15.209	-3.7	Complies
Harmonic Emissions per CFR 47 15.249	-11.8	Complies

Equipment Tested

<u>Equipment</u>	<u>Model / PN</u>	<u>Serial Number</u>
EUT	TDSB0P02	336771 100001
AC Power Supply #1	PSA05A-050QL6	P161706139A2
AC Power Supply #2	SM5-5-V-1318	N/A

Test results in this report relate only to the items tested.

Equipment Function

The EUT is a low power transmitter system providing digital display of remotely located sensor information. The device is designed for placement on desk, shelf or mounted vertically mounted on wall. The unit provides operation while powered from AC/DC adapter or temporary use powered on internal rechargeable battery. The unit provides a Base Station function for the remotely located sensor and may display the sensor information. The EUT provides the base station function decrypting of the sensors data transmissions and providing the data for the end user. The test sample provided testing as a production unit for radiated emissions testing as well as modified to allow testing at the antenna port. The test sample was provided with test software to enable transmit operation for testing purposes. For testing purposes, the test sample received power from AC/DC power adapter and freshly charged battery and configured to operate in testing mode. The test software provided operation of the transmitter at 100% duty cycle for testing. The equipment was tested for emissions compliance using the available configurations with the worst-case data presented. Test results in this report relate only to the products described in this report.

Equipment Configuration

- 1) Unit operating from rechargeable internal battery



- 2) Unit operating from USB AC/DC Power Adapter with rechargeable internal battery

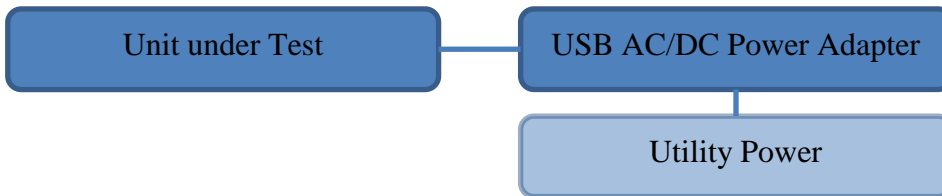

- 3) Antenna Port Conducted Testing operating USB AC/DC Power Adapter with rechargeable internal battery



Application for Certification

- (1) Manufacturer: SAF Tehnika AS
24a, Ganibu dambis
Riga Latvia LV-1005
- (2) Identification: M/N: TDSB0P02
FCC ID: W9Z-ARANETMINI IC: 8855A-ARANETMINI
- (3) Instruction Book:
Refer to Exhibit for Instruction Manual.
- (4) Description of Circuit Functions:
Refer to Exhibit of Operational Description.
- (5) Block Diagram with Frequencies:
Refer to Exhibit of Operational Description.
- (6) Report of Measurements:
Report of measurements follows in this Report.
- (7) Photographs: Construction, Component Placement, etc.:
Refer to Exhibit for photographs of equipment.
- (8) List of Peripheral Equipment Necessary for operation. The equipment operates from DC power only and requires interface with AC/DC power adapter or operation on rechargeable battery. No other interface options are provided as presented in this filing. The EUT offers no other connection ports than those presented in this filing.
- (9) Transition Provisions of CFR47 15.37 are not requested.
- (10) Not Applicable. The unit is not a scanning receiver.
- (11) Not Applicable. The EUT does not operate in the 59 – 64 GHz frequency band.
- (12) The equipment is not software defined and this section is not applicable.
- (13) Applications for certification of U-NII devices in the 5.15-5.35 GHz and the 5.47-5.85 GHz bands must include a high-level operational description of the security procedures that control the radio frequency operating parameters and ensure that unauthorized modifications cannot be made. This requirement is not applicable to his DXX device.
- (14) Contain at least one drawing or photograph showing the test set-up for each of the required types of tests applicable to the device for which certification is requested. These drawings or photographs must show enough detail to confirm other information contained in the test report. Any photographs used must be focused originals without glare or dark spots and must clearly show the test configuration used. This information is provided in this report and Test Setup Exhibits provided with the application filing.

Applicable Standards & Test Procedures

In accordance with the e-CFR Code of Federal Regulations Title 47, dated November 14, 2017: Part 2, Subpart J, Paragraphs 2.907, 2.911, 2.913, 2.925, 2.926, 2.1031 through 2.1057, and applicable parts of paragraph 15, Part 15C Paragraph 15.249, Industry Canada RSS-210 issue 9, and RSS-GEN issue 4 operation in the 900-928 MHz Frequency band. Test procedures used are the established Methods of Measurement of Radio-Noise Emissions as described in ANSI C63.10-2013.

Testing Procedures

AC Line Conducted Emission Test Procedure

Testing for the AC line-conducted emissions was performed as required in 47CFR 15C, RSS-210 and specified in ANSI C63.10-2013. The EUT battery must be recharged using the provided WPT station. Power for the WPT station is provided from compliant USB power source. The test setup, including the EUT, was arranged in the test configurations as presented during testing. The test configuration was placed on a 1 x 1.5-meter bench, 0.8 meters high located in a screen room. The power lines of the system were isolated from the power source using a standard LISN with a 50- μ Hy choke. EMI was coupled to the spectrum analyzer through a 0.1 μ F capacitor internal to the LISN. The LISN was positioned on the floor beneath the wooden bench supporting the EUT. The power lines and cables were draped over the back edge of the table. Refer to diagram one showing typical test arrangement and photographs in exhibits for EUT placement used during testing.

Radiated Emission Test Procedure

Radiated emissions testing was performed as required in 47CFR 15C, RSS-210 and specified in ANSI C63.10-2013. The EUT was placed on a rotating 0.9 x 1.2-meter platform, elevated as required above the ground plane at a distance of 3 meters from the FSM antenna. EMI energy was maximized by equipment placement permitting orientation in three orthogonal axes, raising and lowering the FSM antenna, changing the antenna polarization, and by rotating the turntable. Each emission was maximized before data was taken and recorded. The frequency spectrum from 9 kHz to 25,000 MHz was searched for emissions during preliminary investigation. Refer to diagrams two and three showing typical test setup. Refer to photographs in the test setup exhibits for specific EUT placement during testing.

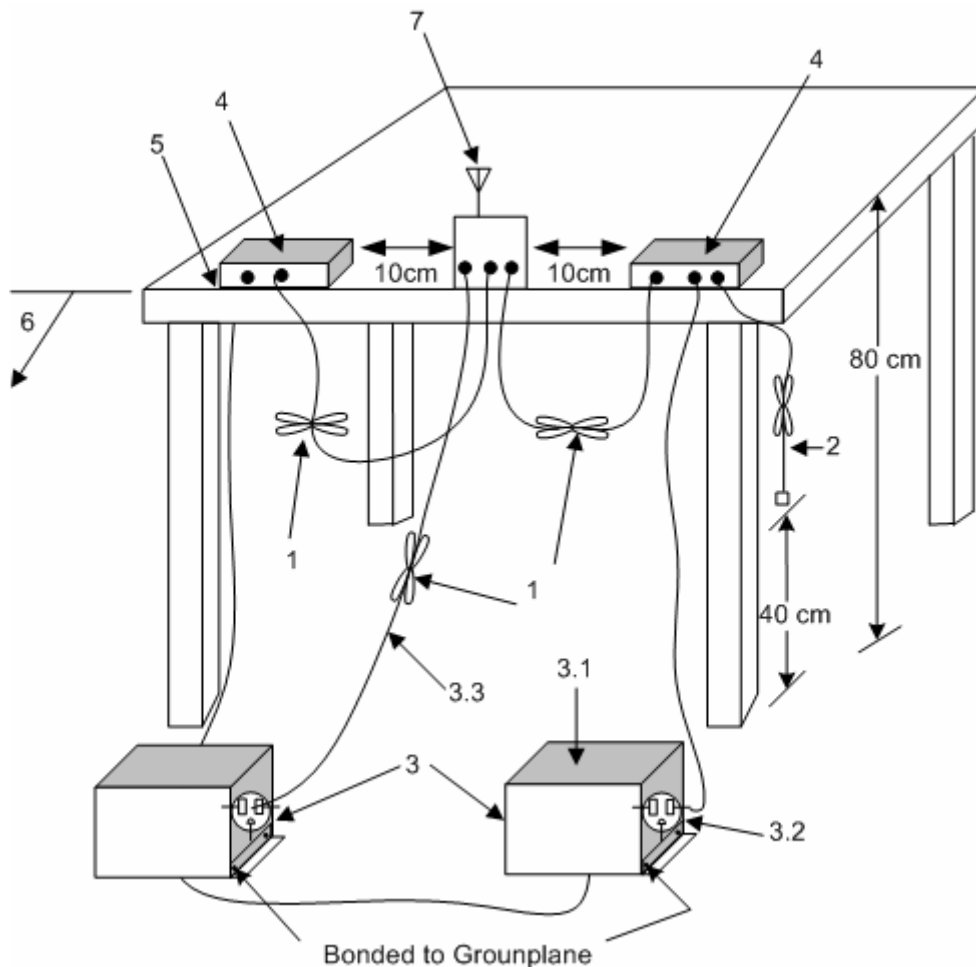

1. Interconnecting cables that hang closer than 40 cm to the ground plane shall be folded back and forth in the center forming a bundle 30 cm to 40 cm long see (see 6.2.3.1).
2. I/O cables that are not connected to an accessory shall be bundled in the center. The end of the cable may be terminated, if required, using the correct terminating impedance. The overall length shall not exceed 1 m (see 6.2.2).
3. EUT connected to one LISN. Unused LISN measuring port connectors shall be terminated in 50 Ω loads. LISN can be placed on top of, or immediately beneath, reference ground plane (see 6.2.2 and 6.2.3).
 - 3.1 All other equipment powered from additional LISN(s).
 - 3.2 Multiple-outlet strip can be used for multiple power cords of non-EUT equipment.
 - 3.3 LISN at least 80 cm from nearest part of EUT chassis.
4. Non-EUT components of EUT system being tested.
5. Rear of EUT, including peripherals, shall all be aligned and flush with rear of tabletop (see 6.2.3.1).
6. Edge of tabletop shall be 40 cm removed from a vertical conducting plane that is bonded to the ground plane (see 6.2.2 for options).
7. Antenna may be integral or detachable. If detachable, the antenna shall be attached for this test.

Diagram 1 Test arrangement for Conducted emissions

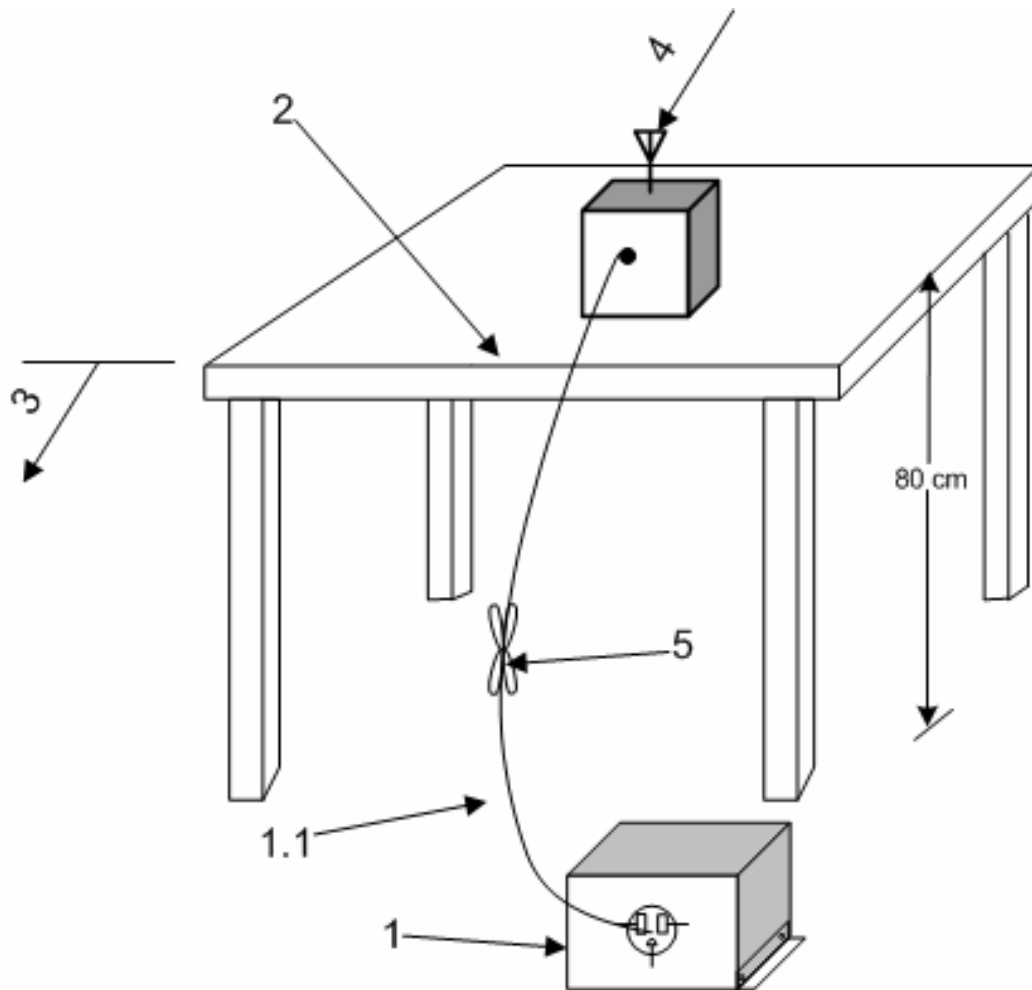

1—A LISN is optional for radiated measurements between 30 MHz and 1000 MHz but not allowed for measurements below 30 MHz and above 1000 MHz (see 6.3.1). If used, then connect EUT to one LISN. Unused LISN measuring port connectors shall be terminated in 50 Ω loads. The LISN may be placed on top of, or immediately beneath, the reference ground plane (see 6.2.2 and 6.2.3.2).

1.1—LISN spaced at least 80 cm from the nearest part of the EUT chassis.

2—Antenna can be integral or detachable, depending on the EUT (see 6.3.1).

3—Interconnecting cables that hang closer than 40 cm to the ground plane shall be folded back and forth in the center forming a bundle 30 cm to 40 cm long (see 6.3.1).

4—For emission measurements at or below 1 GHz, the table height shall be 80 cm. For emission measurements above 1 GHz, the table height shall be 1.5 m for measurements, except as otherwise specified (see 6.3.1 and 6.6.3.1).

Diagram 2 Test arrangement for radiated emissions of tabletop equipment

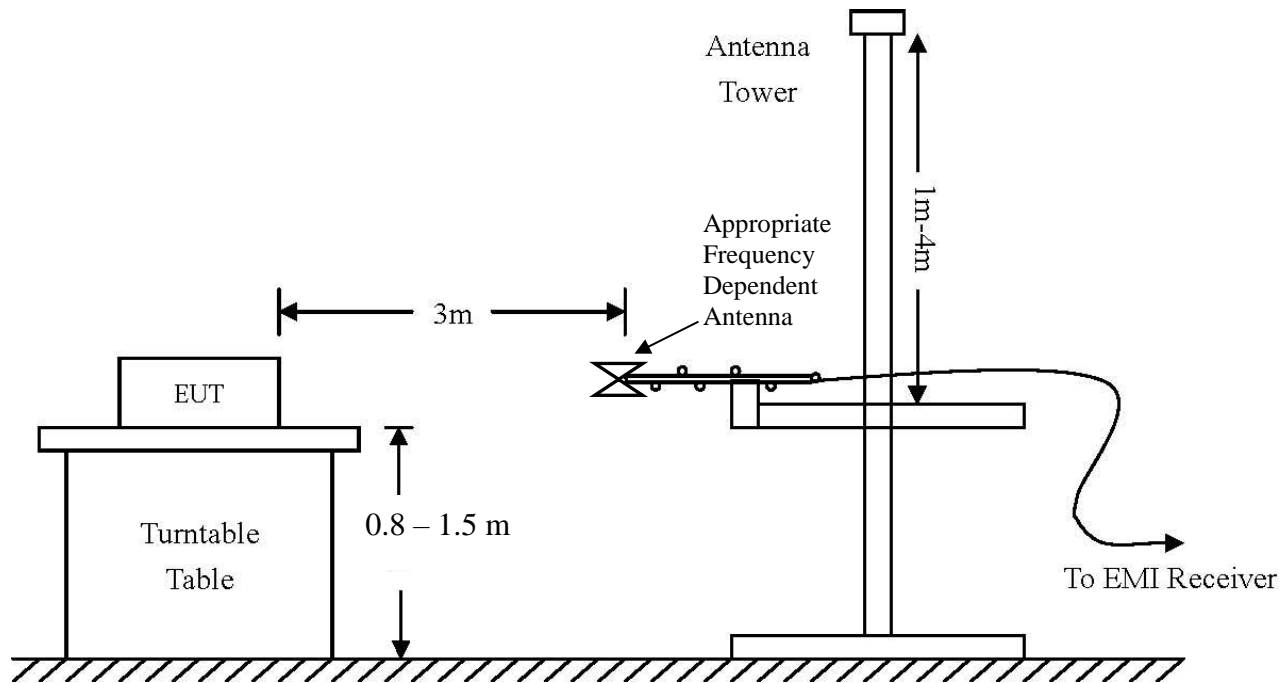

Frequency: 9 kHz-30 MHz	Frequency: 30 MHz- 1 GHZ	Frequency: Above 1 GHZ
Loop Antenna	Broadband Biconilog	Horn
RBW = 9 kHz	RBW = 120 kHz	RBW = 1 MHz
VBW = 30 kHz	VBW = 120 kHz	VBW = 1 MHz
Sweep time = Auto	Sweep time = Auto	Sweep time = Auto
Detector = PK, QP	Detector = PK, QP	Detector = PK, AV
Antenna Height 1m	Antenna Height 1-4m	Antenna Height 1-4m

Diagram 3 Test arrangement for radiated emissions tested on Open Area Test Site (OATS)

Test Site Locations

Conducted EMI: The AC power line conducted emissions testing performed in a shielded screen room located at Rogers Labs, Inc., 4405 West 259th Terrace, Louisburg, KS

Radiated EMI: The radiated emissions tests were performed at the 3 meters, Open Area Test Site (OATS) located at Rogers Labs, Inc., 4405 West 259th Terrace, Louisburg, KS

Site Registration: Refer to Annex for Site Registration Letters

NVLAP Accreditation: Lab code 200087-0

List of Test Equipment

<u>Equipment</u>	<u>Manufacturer</u>	<u>Model (SN)</u>	<u>Band</u>	<u>Cal Date</u>	<u>Due</u>
<input checked="" type="checkbox"/> LISN	FCC	FCC-LISN-50-2-10(1PA) (160611)	.15-30MHz	5/17	5/18
<input checked="" type="checkbox"/> Cable	Time Microwave	750HF290-750 (L10M)	9kHz-40 GHz	10/17	10/18
<input checked="" type="checkbox"/> Cable	Belden	RG-58 (L1-CAT3-11509)	9kHz-30 MHz	10/17	10/18
<input checked="" type="checkbox"/> Cable	Belden	RG-58 (L2-CAT3-11509)	9kHz-30 MHz	10/17	10/18
<input type="checkbox"/> Antenna	ARA	BCD-235-B (169)	20-350MHz	10/17	10/18
<input type="checkbox"/> Antenna	EMCO	3147 (40582)	200-1000MHz	10/17	10/18
<input checked="" type="checkbox"/> Antenna	ETS-Lindgren	3117 (200389)	1-18 GHz	5/17	5/18
<input type="checkbox"/> Antenna	Com Power	AH-118 (10110)	1-18 GHz	10/17	10/19
<input checked="" type="checkbox"/> Antenna	Com Power	AH-840 (101046)	18-40 GHz	5/17	5/19
<input checked="" type="checkbox"/> Antenna	Com Power	AL-130 (121055)	.001-30 MHz	10/17	10/18
<input checked="" type="checkbox"/> Antenna	Sunol	JB-6 (A100709)	30-1000 MHz	10/17	10/18
<input type="checkbox"/> Antenna	EMCO	3143 (9607-1277)	20-1200 MHz	5/17	5/18
<input type="checkbox"/> Analyzer	HP	8591EM (3628A00871)	9kHz-1.8GHz	5/17	5/18
<input type="checkbox"/> Analyzer	HP	8562A (3051A05950)	9kHz-110GHz	5/17	5/18
<input type="checkbox"/> Analyzer	HP External Mixers	11571, 11970	25GHz-110GHz	5/17	5/18
<input checked="" type="checkbox"/> Analyzer	Rohde & Schwarz	ESU40 (100108)	20Hz-40GHz	5/17	5/18
<input checked="" type="checkbox"/> Amplifier	Com-Power	PA-010 (171003)	100Hz-30MHz	10/17	10/18
<input checked="" type="checkbox"/> Amplifier	Com-Power	CPPA-102 (01254)	1-1000 MHz	10/17	10/18
<input checked="" type="checkbox"/> Amplifier	Com-Power	PAM-118A (551014)	0.5-18 GHz	10/17	10/18
<input type="checkbox"/> Power Mtr	Agilent	N1911A with N1921A	0.05-18 GHz	5/17	5/18

Units of Measurements

Conducted EMI Data is in dB μ V; dB referenced to one microvolt

Radiated EMI Data is in dB μ V/m; dB/m referenced to one microvolt per meter

Sample Calculation:

RFS = Radiated Field Strength, FSM = Field Strength Measured

A.F. = Receive antenna factor, Gain = amplification gains and/or cable losses

RFS (dB μ V/m @ 3m) = FSM (dB μ V) + A.F. (dB) - Gain (dB)

Environmental Conditions

Ambient Temperature 19.7° C

Relative Humidity 39%

Atmospheric Pressure 1015.8 mb

Statement of Modifications and Deviations

No modifications to the EUT were required for the unit to demonstrate compliance with the CFR47 Part 15C, RSS-Gen, and RSS-210 emission requirements. There were no deviations to the specifications.

Intentional Radiators

The following information is submitted in support demonstration of compliance with the requirements of CFR47, Subpart C, paragraph 15.249 and Industry Canada RSS-210 and RSS-Gen the following information is submitted.

Antenna Requirements

The EUT incorporates integral antenna system and offers no provision for connection to alternate antenna system. The antenna connection point complies with the unique antenna connection requirements. There are no deviations or exceptions to the specification.

Restricted Bands of Operation

Spurious emissions falling in the restricted frequency bands of operation were measured at the OATS. The EUT utilizes frequency, determining circuitry, which generates harmonics falling in the restricted bands. Emissions were investigated at the OATS, using appropriate antennas or pyramidal horns, amplification stages, and a spectrum analyzer. Peak and average amplitudes of frequencies above 1000 MHz were compared to the required limits with worst-case data presented below. Test procedures of ANSI C63.10-2013 paragraph 6 and KDB 558074 paragraph 12 were used during testing. No other significant emission was observed which fell into the restricted bands of operation. Computed emission values consider the received radiated field strength, receive antenna correction factor, amplifier gain stage, and test system cable losses.

Table 1 Harmonic Radiated Emissions in Restricted Bands Data

Frequency in MHz	Horizontal Peak (dB μ V/m)	Horizontal Quasi-Peak (dB μ V/m)	Horizontal Average (dB μ V/m)	Vertical Peak (dB μ V/m)	Vertical Quasi-Peak (dB μ V/m)	Vertical Average (dB μ V/m)	Limit @ 3m (dB μ V/m)
2769.6	45.2	N/A	34.2	39.5	N/A	26.9	54.0
3692.8	41.7	N/A	28.8	42.8	N/A	28.8	54.0
4616.0	44.6	N/A	30.7	43.5	N/A	30.7	54.0

Other emissions present had amplitudes at least 20 dB below the limit. Peak and Quasi-Peak amplitude emissions are recorded for frequency below 1000 MHz. Peak and Average amplitude emissions are recorded for frequency range above 1000 MHz.

Summary of Results for Radiated Emissions in Restricted Bands

The EUT demonstrated compliance with the radiated emissions requirements of CFR 47 Part 15C RSS-Gen, and RSS-210 Intentional Radiators. The EUT demonstrated a worst-case minimum radiated emission in restricted bands providing a minimum margin of -19.8 dB below the radiated emissions requirements. Peak and average amplitudes were checked for compliance with the regulations. Worst-case emissions are reported with other emissions found in the restricted frequency bands at least 20 dB below the requirements.

AC Line Conducted Emissions Procedure

The EUT was arranged in typical equipment configurations for AC Line Conducted emissions testing. The design provides replaceable battery operation as well as use with AC adapter. An AC/DC power adapter was used to power the EUT for AC Line Conducted emissions testing. Testing was performed with the EUT placed on a 1 x 1.5-meter wooden bench 80 cm above the conducting ground plane, floor of a screen room. The bench was positioned 40 cm away from the wall of the screen room. The LISN was positioned on the floor of the screen room 80-cm from the rear of the EUT. Testing for the line-conducted emissions were the procedures of ANSI C63.10-2013 paragraph 6. The AC adapter for the EUT was connected to the LISN for line-conducted emissions testing. A second LISN was positioned on the floor of the screen room 80-cm from the rear of the supporting equipment of the EUT. All power cords except the EUT were then powered from the second LISN. EMI was coupled to the spectrum analyzer through a 0.1 μ F capacitor, internal to the LISN. Power line conducted emissions testing was carried out individually for each current carrying conductor of the EUT. The excess length of lead between the system and the LISN receptacle was folded back and forth to form a bundle not exceeding 40 cm in length. The screen room, conducting ground plane, analyzer, and LISN were bonded together to the protective earth ground. Preliminary testing was performed to identify the frequencies of each of the emissions, which demonstrated the highest amplitudes. The cables were repositioned to obtain maximum amplitude of measured EMI level. Once the worst-case configuration was identified, plots were made of the EMI from 0.15 MHz to 30 MHz then data was recorded with maximum conducted emissions levels.

Refer to figures one through two showing plots of the AC/DC power adapter configuration AC Line conducted emissions.

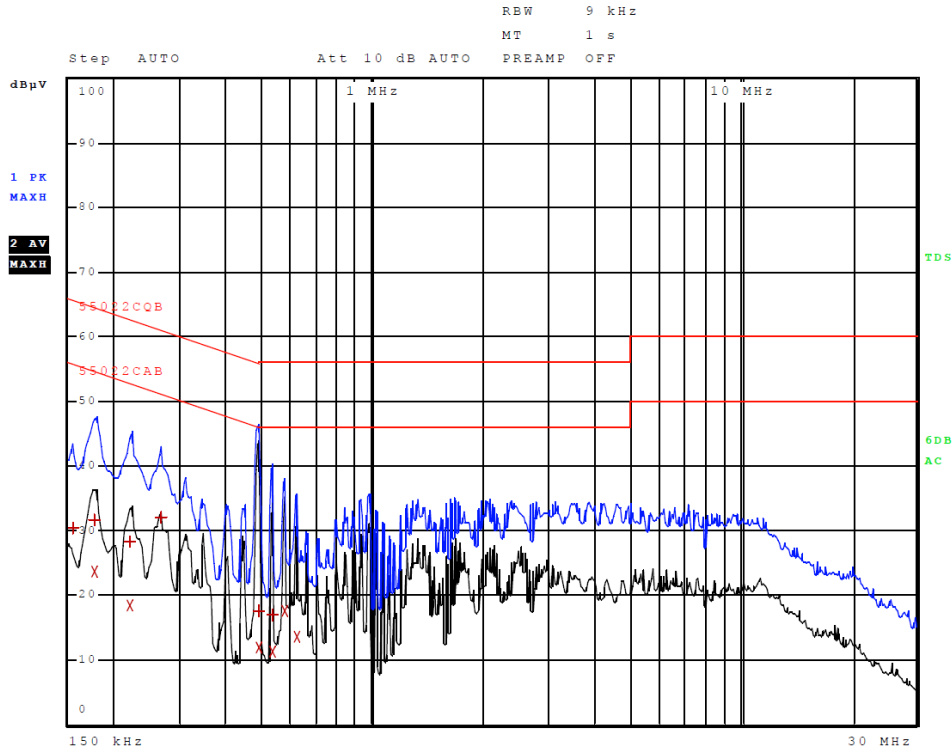

Figure 1 AC Line Conducted emissions of EUT line 1

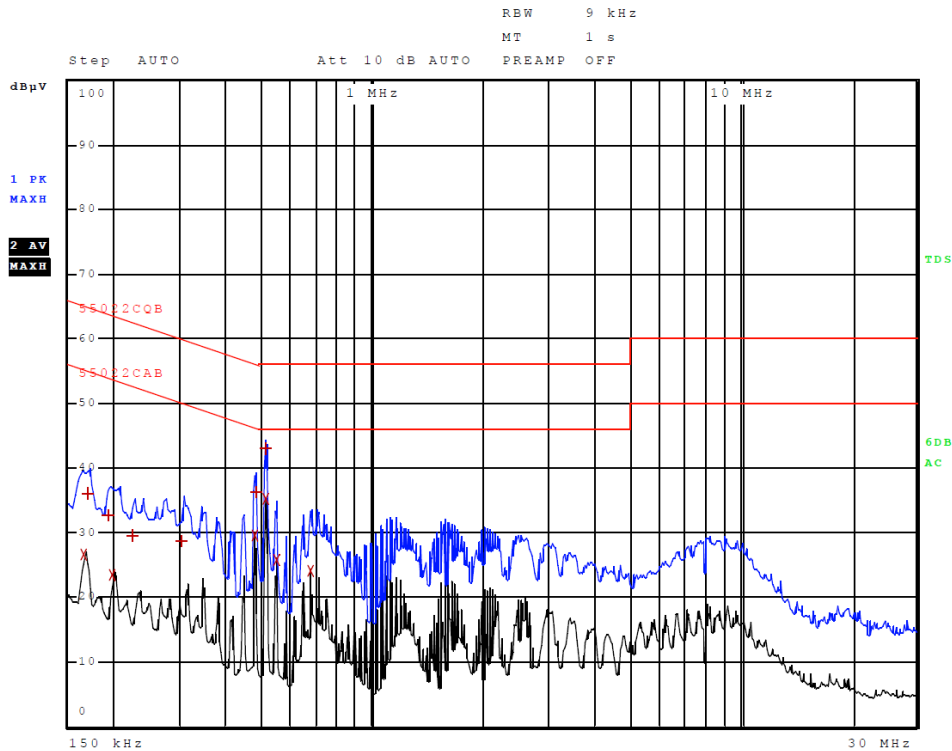

Figure 2 AC Line Conducted emissions of EUT line 2

Table 2 AC Line Conducted Emissions Data L1

Trace	Frequency	Level (dBµV)	Detector	Delta Limit/dB
1	154.000000000 kHz	30.29	Quasi Peak	-35.49
1	178.000000000 kHz	31.58	Quasi Peak	-33.00
2	178.000000000 kHz	23.67	Average	-30.90
1	222.000000000 kHz	28.20	Quasi Peak	-34.55
2	222.000000000 kHz	18.40	Average	-34.35
1	266.000000000 kHz	32.08	Quasi Peak	-29.16
2	490.000000000 kHz	11.87	Average	-34.30
1	490.000000000 kHz	17.61	Quasi Peak	-38.56
2	530.000000000 kHz	11.22	Average	-34.78
1	530.000000000 kHz	16.96	Quasi Peak	-39.04
2	574.000000000 kHz	17.49	Average	-28.51
2	618.000000000 kHz	13.50	Average	-32.50

Other emissions present had amplitudes at least 20 dB below the limit.

Table 3 AC Line Conducted Emissions Data L2

Trace	Frequency	Level (dBµV)	Detector	Delta Limit/dB
2	166.000000000 kHz	26.62	Average	-28.54
1	170.000000000 kHz	36.06	Quasi Peak	-28.90
1	194.000000000 kHz	32.65	Quasi Peak	-31.21
2	198.000000000 kHz	23.42	Average	-30.28
1	226.000000000 kHz	29.44	Quasi Peak	-33.16
1	306.000000000 kHz	28.74	Quasi Peak	-31.34
2	478.000000000 kHz	29.46	Average	-16.91
1	482.000000000 kHz	36.34	Quasi Peak	-19.97
2	510.000000000 kHz	35.13	Average	-10.87
1	510.000000000 kHz	42.93	Quasi Peak	-13.07
2	546.000000000 kHz	25.84	Average	-20.16
2	678.000000000 kHz	24.01	Average	-21.99

Other emissions present had amplitudes at least 20 dB below the limit.

Summary of Results for AC Line Conducted Emissions Results

The EUT demonstrated compliance with the AC Line Conducted Emissions requirements of 47CFR Part 15B and other applicable emissions requirements. The worst-case EUT configuration demonstrated a minimum margin of -10.8 dB below the FCC/IC requirements. Other emissions were present with amplitudes at least 20 dB below the limit and worst-case amplitudes recorded.

General Radiated Emissions Procedure

The EUT was arranged in a typical equipment configuration and operated through all available mode during testing. Preliminary testing was performed in a screen room with the EUT positioned 1 meter from the FSM. Radiated emissions measurements were performed to identify the frequencies, which produced the highest emissions. Each radiated emission was then maximized at the OATS location before final radiated measurements were performed. Final data was taken with the EUT located on the OATS at 3 meters distance between the EUT and the receiving antenna. The frequency spectrum from 9 kHz to 10,000 MHz was searched for general radiated emissions. Measured emission levels were maximized by EUT placement on the table, rotating the turntable through 360 degrees, varying the antenna height between 1 and 4 meters above the ground plane and changing antenna position between horizontal and vertical polarization. Antennas used were Loop from 9 kHz to 30 MHz, Broadband Biconical from 30 to 200 MHz, Biconilog from 30 to 1000 MHz, Log Periodic from 200 MHz to 1 GHz and or double Ridge or pyramidal horns and mixers above 1 GHz, notch filters and appropriate amplifiers and external mixers were utilized.

Table 3 General Radiated Emissions Data

Frequency in MHz	Horizontal Peak (dBμV/m)	Horizontal Quasi-Peak (dBμV/m)	Horizontal Average (dBμV/m)	Vertical Peak (dBμV/m)	Vertical Quasi-Peak (dBμV/m)	Vertical Average (dBμV/m)	Limit @ 3m (dBμV/m)
119.3	35.7	30.3	N/A	39.1	33.2	N/A	40
125.3	35.5	30.0	N/A	39.5	33.8	N/A	40
126.0	37.1	30.5	N/A	39.9	33.5	N/A	40
133.3	40.4	34.0	N/A	41.2	36.3	N/A	40
134.3	38.3	31.3	N/A	41.6	36.1	N/A	40
137.5	34.2	30.5	N/A	38.2	36.1	N/A	40

Other emissions present had amplitudes at least 20 dB below the limit. Peak and Quasi-Peak amplitude emissions are recorded for frequency range below 1000 MHz. Peak and Average amplitude emissions are recorded for frequency range above 1000 MHz.

Summary of Results for General Radiated Emissions

The EUT demonstrated compliance with the radiated emissions requirements of CFR47 Part 15C paragraph 15.209, RSS-210 and RSS-GEN Intentional Radiators. The EUT demonstrated a minimum margin of -3.7 dB below the requirements. Other emissions were present with amplitudes at least 20 dB below the Limits.

Operation in the Band 902-928 MHz

The transmitter output power; harmonics and general radiated emissions were measured on an open area test site @ 3 meters distance. The EUT was placed on a turntable elevated as required above the ground plane at a distance of 3 meters from the Field Strength Measuring (FSM) antenna. The peak and quasi-peak amplitude of frequencies below 1000 MHz were measured using a EMI receiver/spectrum analyzer. The peak and average amplitude of frequencies above 1000 MHz were measured using a EMI receiver/spectrum analyzer. The amplitude of each emission was then recorded from the EMI receiver/spectrum analyzer display. Emissions radiated outside of the specified bands, except for harmonics, shall be attenuated by at least 50 dB below the level of the fundamental or to the general radiated emission limits, whichever is the lesser attenuation. Antenna port emission plots were taken of transmitter performance for reference in this and other documentation. The amplitude of each radiated emission was measured on the OATS at a distance of 3 meters from the FSM antenna. Testing was performed on a sample representative of production with integral antenna with worse case data provided. The amplitude of each radiated emission was maximized by equipment orientation and placement on the turn table, raising and lowering the FSM antenna, changing the FSM antenna polarization, and by rotating the turntable. A Loop antenna was used for measuring emissions from 0.009 to 30 MHz, Biconilog Antenna for 30 to 1000 MHz, Double-Ridge, and/or Pyramidal Horn Antennas from 1 GHz to 10 GHz. Emissions were measured in dB μ V/m @ 3 meters. Refer to figures three through seven showing plots taken of transmitter performance for reference.

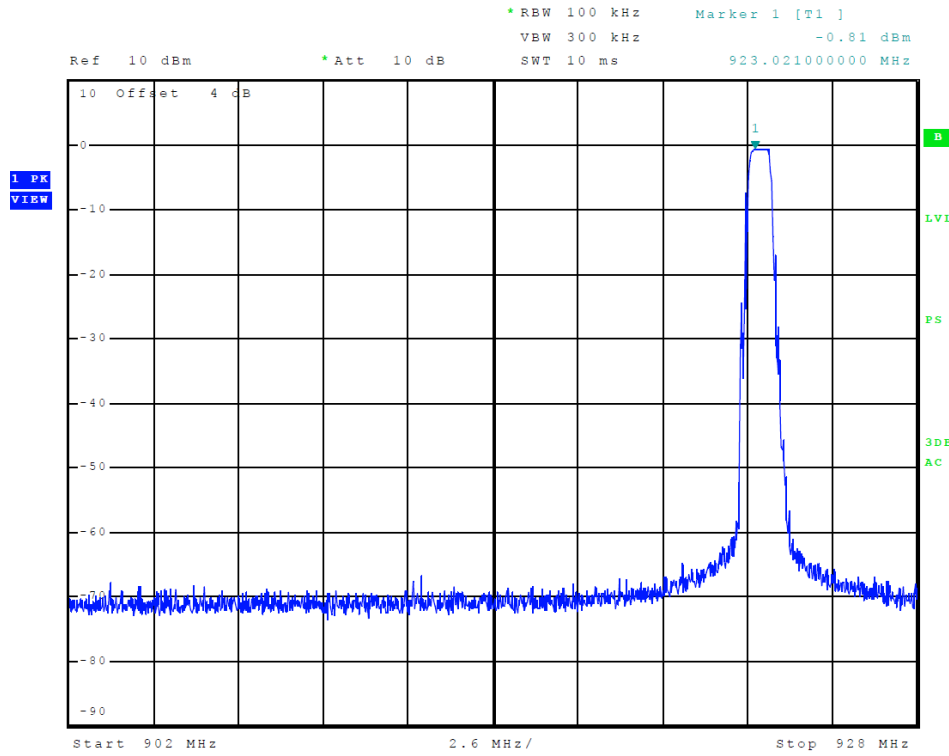

Figure 3 Plot of Transmitter Emissions in Operational Frequency Band

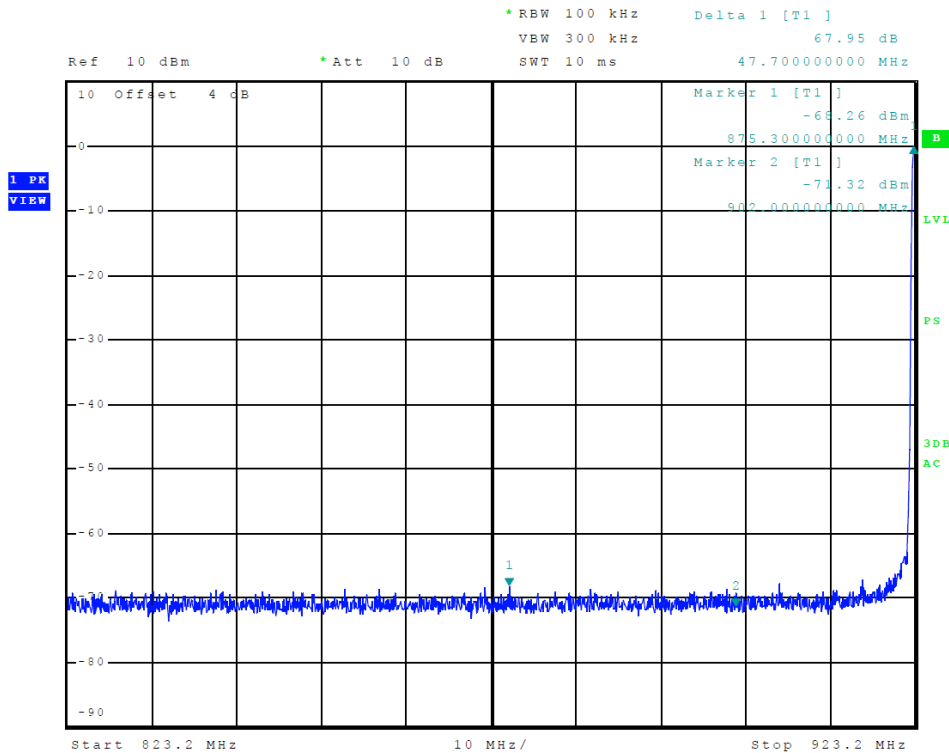

Figure 4 Plot of Lower Band Edge

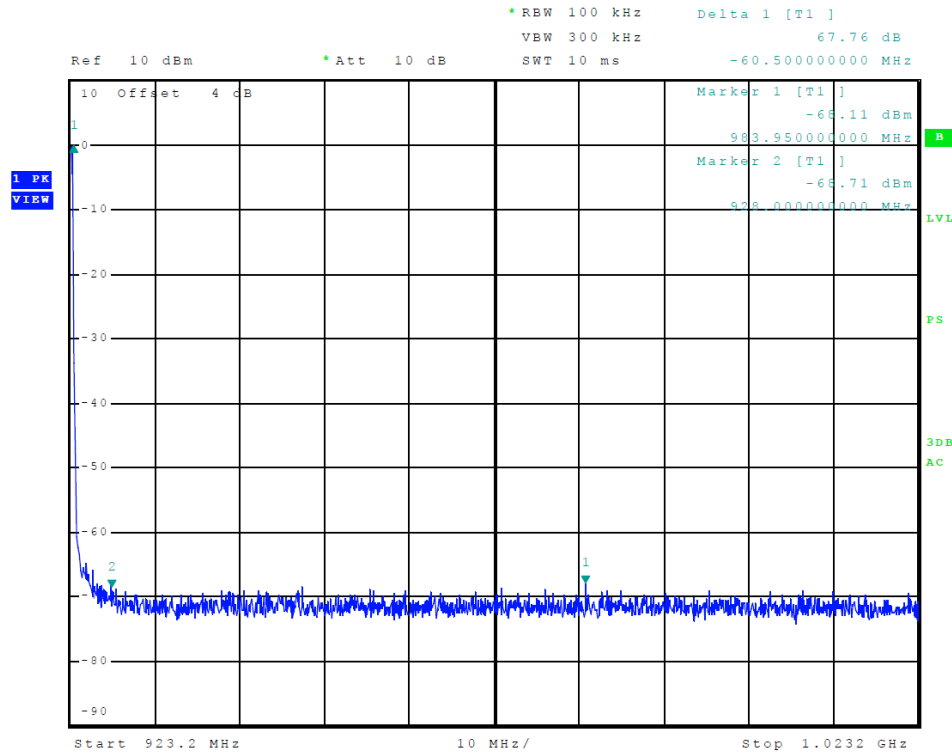

Figure 5 Plot of Upper Band Edge

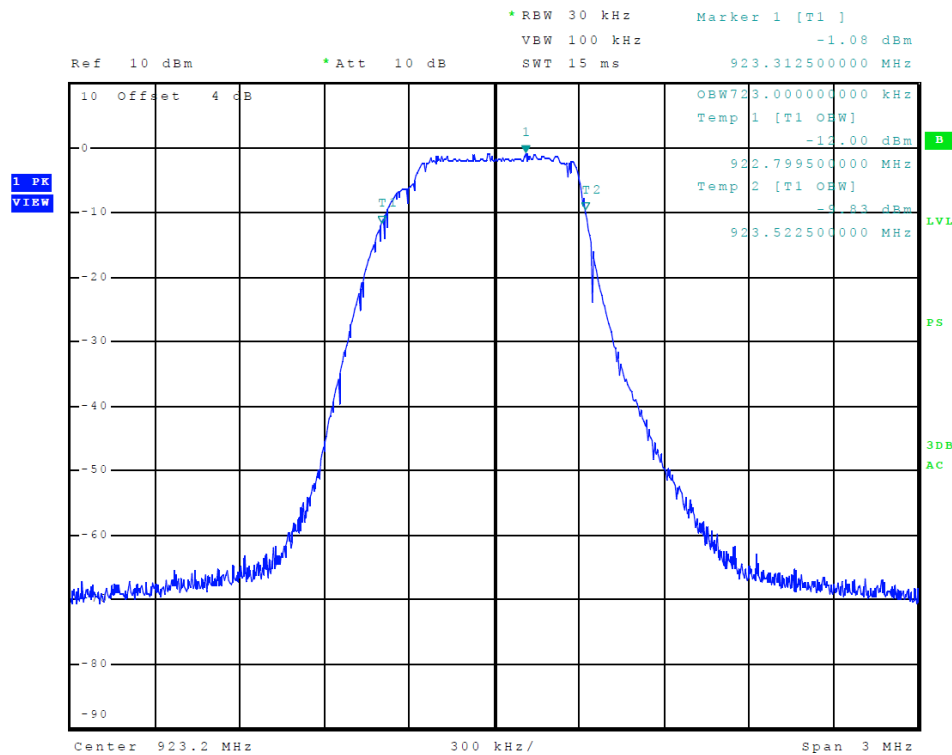

Figure 6 Plot of Transmitter 99% Occupied Bandwidth

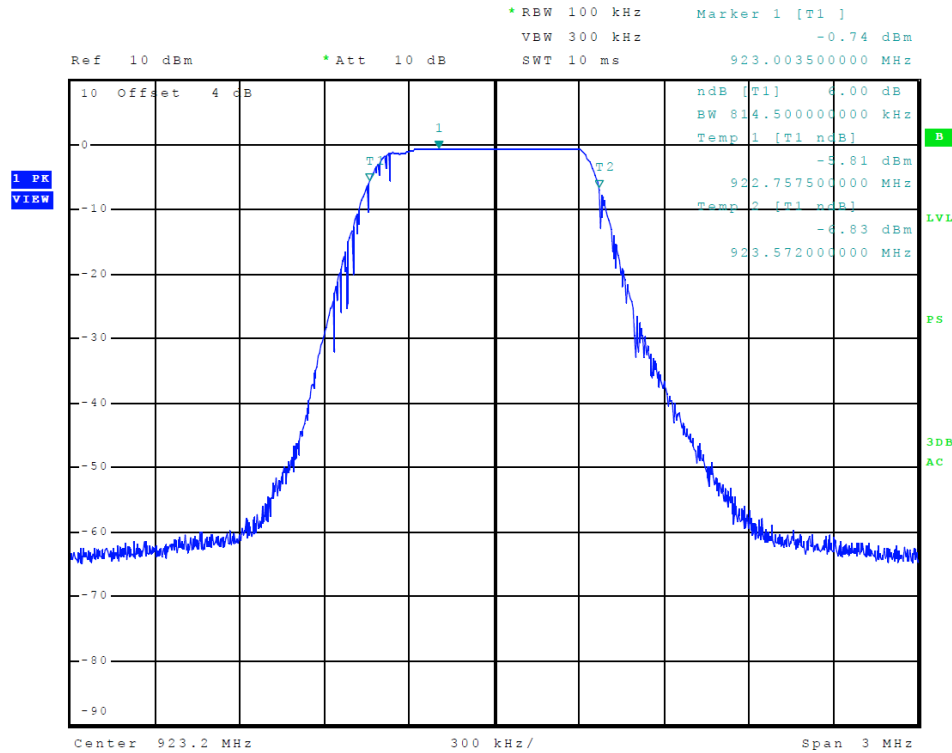

Figure 7 Plot of Transmitter 6-dB Occupied Bandwidth

Transmitter Emissions Data

Table 4 Transmitter Radiated Emission Worst-case

Frequency in MHz	Horizontal Peak (dBμV/m)	Horizontal Quasi-Peak (dBμV/m)	Horizontal Average (dBμV/m)	Vertical Peak (dBμV/m)	Vertical Quasi-Peak (dBμV/m)	Vertical Average (dBμV/m)	Limit @ 3m (dBμV/m)
923.20	87.2	86.7	N/A	94.2	93.7	N/A	94
1846.40	47.3	N/A	42.2	41.2	N/A	29.2	54.0
2769.60	45.2	N/A	34.2	39.5	N/A	26.9	54.0
3692.80	41.7	N/A	28.8	42.8	N/A	28.8	54.0
4616.00	44.6	N/A	30.7	43.5	N/A	30.7	54.0
5539.20	43.7	N/A	31.0	44.8	N/A	31.0	54.0

Other emissions present had amplitudes at least 20 dB below the limit. Peak and Quasi-Peak amplitude emissions are recorded for frequency below 1000 MHz. Peak and Average amplitude emissions are recorded for frequency range above 1000 MHz.

Summary of Results for Transmitter Radiated Emissions of Intentional Radiator

The EUT demonstrated compliance with the radiated emissions requirements of FCC 47 CFR Part 15.249, Industry Canada RSS-GEN issue 4, RSS-210 issue 9 Intentional Radiator regulations. The EUT worst-case configuration demonstrated minimum margin of -0.3 dB below the limit for the fundamental. The EUT worst-case configuration demonstrated minimum radiated harmonic emission margin of -11.8 dB below the limit. No other radiated emissions were found in the restricted bands less than 20 dB below limits than those recorded in this report. Other emissions were present with amplitudes at least 20 dB below the limits.

Annex

- Annex A Measurement Uncertainty Calculations
- Annex B Rogers Labs Test Equipment List
- Annex C Rogers Qualifications
- Annex D Rogers Labs Certificate of Accreditation

Annex A Measurement Uncertainty Calculations

Measurement uncertainty calculations were made for the laboratory. Result of measurement uncertainty calculations are recorded below for AC line conducted and radiated emission measurements.

Measurement Uncertainty	$U_{(E)}$	$U_{(lab)}$
3 Meter Horizontal 30-200 MHz Measurements	2.08	4.16
3 Meter Vertical 30-200 MHz Measurements	2.16	4.33
3 Meter Vertical Measurements 200-1000 MHz	2.99	5.97
10 Meter Horizontal Measurements 30-200 MHz	2.07	4.15
10 Meter Vertical Measurements 30-200 MHz	2.06	4.13
10 Meter Horizontal Measurements 200-1000 MHz	2.32	4.64
10 Meter Vertical Measurements 200-1000 MHz	2.33	4.66
3 Meter Measurements 1-6 GHz	2.57	5.14
3 Meter Measurements 6-18 GHz	2.58	5.16
AC Line Conducted	1.72	3.43

Annex B Rogers Labs Test Equipment List

List of Test Equipment	Calibration	Date	Due
Spectrum Analyzer: Rohde & Schwarz ESU40		5/17	5/18
Spectrum Analyzer: HP 8562A, HP Adapters: 11518, 11519, and 11520		5/17	5/18
Mixers: 11517A, 11970A, 11970K, 11970U, 11970V, 11970W			
Spectrum Analyzer: HP 8591EM		5/17	5/18
Antenna: EMCO Biconilog Model: 3143		5/17	5/18
Antenna: Sunol Biconilog Model: JB6		10/17	10/18
Antenna: EMCO Log Periodic Model: 3147		10/17	10/18
Antenna: Com Power Model: AH-118		10/17	10/18
Antenna: Com Power Model: AH-840		5/17	5/18
Antenna: Antenna Research Biconical Model: BCD 235		10/17	10/18
Antenna: Com Power Model: AL-130		10/17	10/18
Antenna: EMCO 6509		10/17	10/18
LISN: Compliance Design Model: FCC-LISN-2.Mod.cd, 50 µHy/50 ohms/0.1 µf		10/17	10/18
R.F. Preamp CPPA-102		10/17	10/18
Attenuator: HP Model: HP11509A		10/17	10/18
Attenuator: Mini Circuits Model: CAT-3		10/17	10/18
Attenuator: Mini Circuits Model: CAT-3		10/17	10/18
Cable: Belden RG-58 (L1)		10/17	10/18
Cable: Belden RG-58 (L2)		10/17	10/18
Cable: Belden 8268 (L3)		10/17	10/18
Cable: Time Microwave: 4M-750HF290-750		10/17	10/18
Cable: Time Microwave: 10M-750HF290-750		10/17	10/18
Frequency Counter: Leader LDC825		2/17	2/18
Oscilloscope Scope: Tektronix 2230		2/17	2/18
Wattmeter: Bird 43 with Load Bird 8085		2/17	2/18
Power Supplies: Sorensen SRL 20-25, SRL 40-25, DCR 150, DCR 140		2/17	2/18
R.F. Generators: HP 606A, HP 8614A, HP 8640B		2/17	2/18
R.F. Power Amp 65W Model: 470-A-1010		2/17	2/18
R.F. Power Amp 50W M185- 10-501		2/17	2/18
R.F. Power Amp A.R. Model: 10W 1010M7		2/17	2/18
R.F. Power Amp EIN Model: A301		2/17	2/18
LISN: Compliance Eng. Model 240/20		2/17	2/18
LISN: Fischer Custom Communications Model: FCC-LISN-50-16-2-08		2/17	2/18
Antenna: EMCO Dipole Set 3121C		2/17	2/18
Antenna: C.D. B-101		2/17	2/18
Antenna: Solar 9229-1 & 9230-1		2/17	2/18
Audio Oscillator: H.P. 201CD		2/17	2/18
ESD Test Set 2010i		2/17	2/18
Fast Transient Burst Generator Model: EFT/B-101		2/17	2/18
Field Intensity Meter: EFM-018		2/17	2/18
KEYTEK Ecat Surge Generator		2/17	2/18
Shielded Room 5 M x 3 M x 3.0 M			

Annex C Rogers Qualifications

Scot D. Rogers, Engineer

Rogers Labs, Inc.

Mr. Rogers has approximately 17 years' experience in the field of electronics. Engineering experience includes six years in the automated controls industry and remaining years working with the design, development and testing of radio communications and electronic equipment.

Positions Held

Systems Engineer: A/C Controls Mfg. Co., Inc. 6 Years

Electrical Engineer: Rogers Consulting Labs, Inc. 5 Years

Electrical Engineer: Rogers Labs, Inc. Current

Educational Background

- 1) Bachelor of Science Degree in Electrical Engineering from Kansas State University.
- 2) Bachelor of Science Degree in Business Administration Kansas State University.
- 3) Several Specialized Training courses and seminars pertaining to Microprocessors and Software programming.

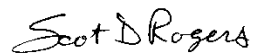

Scot D. Rogers

Annex D Rogers Labs Certificate of Accreditation

<p>United States Department of Commerce National Institute of Standards and Technology</p>  <hr/> <p>Certificate of Accreditation to ISO/IEC 17025:2005</p> <hr/> <p>NVLAP LAB CODE: 200087-0</p> <p>Rogers Labs, Inc. Louisburg, KS</p> <p><i>is accredited by the National Voluntary Laboratory Accreditation Program for specific services, listed on the Scope of Accreditation, for:</i></p> <p>Electromagnetic Compatibility & Telecommunications</p> <p><i>This laboratory is accredited in accordance with the recognized International Standard ISO/IEC 17025:2005. This accreditation demonstrates technical competence for a defined scope and the operation of a laboratory quality management system (refer to joint ISO-ILAC-IAF Communique dated January 2009).</i></p> <hr/> <table border="0" style="width: 100%;"><tr><td style="width: 33%;"><p>2017-03-01 through 2018-03-31 <i>Effective Dates</i></p></td><td style="width: 33%; text-align: center;"></td><td style="width: 33%; text-align: right;"> <i>For the National Voluntary Laboratory Accreditation Program</i></td></tr></table>			<p>2017-03-01 through 2018-03-31 <i>Effective Dates</i></p>		 <i>For the National Voluntary Laboratory Accreditation Program</i>
<p>2017-03-01 through 2018-03-31 <i>Effective Dates</i></p>		 <i>For the National Voluntary Laboratory Accreditation Program</i>			