

Application For Grant of Certification

FOR

Model: TDSPC0U1 (Aranet CO₂ Sensor)
902-928 MHz (DTS)
Hybrid Digital Transmission System
FCC ID: W9Z-ARANETCO2
IC: 8855A-ARANETCO2

FOR

SAF Tehnika AS

24a, Ganibu dambis
Riga Latvia LV-1005

FCC Designation: US5305
IC Test Site Registration: 3041A-1

Test Report Number: 171106B

Authorized Signatory: *Scot D. Rogers*
Scot D. Rogers

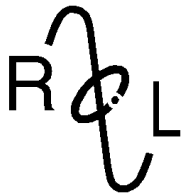

ROGERS LABS, INC.

4405 West 259th Terrace
Louisburg, KS 66053
Phone / Fax (913) 837-3214

Engineering Test Report For Grant of Certification Application

CFR 47, PART 15C - Intentional Radiators
CFR 47 Paragraph 15.247 and
Industry Canada RSS-GEN and RSS-247
License Exempt Intentional Radiator

For

SAF Tehnika AS

24a, Ganību dambis
Rīga Latvia LV-1005

Hybrid Digital Transmission System
Model: TDSPC0U1 (Aranet CO₂ Sensor)

Frequency Range 902-928 MHz
FCC ID: W9Z-ARANETCO2
IC: 8855A-ARANETCO2

Test Date: November 6, 2017

Certifying Engineer: *Scot D. Rogers*
Scot D. Rogers
Rogers Labs, Inc.
4405 West 259th Terrace
Louisburg, KS 66053
Telephone/Facsimile: (913) 837-3214

This report shall not be reproduced except in full, without the written approval of the laboratory.
This report must not be used by the client to claim product certification, approval, or
endorsement by NVLAP, NIST, or any agency of the Federal Government.

Rogers Labs, Inc.	SAF Tehnika AS	S/N's: 00001, 2, 3, 4 and 5
4405 W. 259th Terrace	Model: TDSPC0U1, Aranet CO ₂ Sensor	FCC ID: W9Z-ARANETCO2
Louisburg, KS 66053	Test #: 171106B	IC: 8855A- ARANETCO2
Phone/Fax: (913) 837-3214	Test to: CFR47 15C, RSS-Gen RSS-247	Date: February 1, 2018
Revision 1	File: SAF ARANETCO2 DTS TstRpt 171106B	Page 2 of 40

Table of Contents

TABLE OF CONTENTS.....	3
REVISIONS.....	5
FOREWORD.....	6
OPINION / INTERPRETATION OF RESULTS	6
EQUIPMENT TESTED.....	6
Equipment Function	7
Equipment Operations.....	8
Equipment Configuration.....	8
APPLICATION FOR CERTIFICATION.....	9
APPLICABLE STANDARDS & TEST PROCEDURES	10
TESTING PROCEDURES	10
AC Line Conducted Emission Test Procedure	10
Radiated Emission Test Procedure.....	10
Diagram 1 Test arrangement for radiated emissions of tabletop equipment.....	11
Diagram 2 Test arrangement for radiated emissions tested on Open Area Test Site (OATS).....	12
TEST SITE LOCATIONS	12
LIST OF TEST EQUIPMENT	13
UNITS OF MEASUREMENTS	14
ENVIRONMENTAL CONDITIONS.....	14
STATEMENT OF MODIFICATIONS AND DEVIATIONS	14
INTENTIONAL RADIATORS.....	14
Antenna Requirements	14

Restricted Bands of Operation.....15

Table 1 Harmonic Radiated Emissions in Restricted Bands Data M-mode (Worst-case).....15

Table 2 Harmonic Radiated Emissions in Restricted Bands Data P-mode (Worst-case)16

Summary of Results for Radiated Emissions in Restricted Bands16

AC Line Conducted Emissions Procedure16

General Radiated Emissions Procedure.....17

Table 3 General Radiated Emissions Data17

Summary of Results for General Radiated Emissions17

Operation in the Band 902-928 MHz.....18

Figure 1 Plot of Transmitter Emissions in Operational Frequency Band (M-Mode)22

Figure 2 Plot of Lower Band Edge (M-mode).....22

Figure 3 Plot of Upper Band Edge (M-mode)23

Figure 4 Plot of Transmitter 6-dB Occupied Bandwidth (M-mode).....23

Figure 5 Plot of Transmitter 99% Occupied Bandwidth (M-mode)24

Figure 6 Plot of Power Spectral Density (M-Mode).....24

Figure 7 Plot of Power Spectral Density (M-Mode).....25

Figure 8 Plot of Power Spectral Density (M-Mode).....25

Figure 9 Plot of Output Power (M-Mode).....26

Figure 10 Plot of Output Power (M-Mode).....26

Figure 11 Plot of Output Power (M-Mode).....26

Figure 12 Plot of Transmitter Emissions in Operational Frequency Band (P-Mode).....27

Figure 13 Plot of Lower Band Edge (P-mode).....27

Figure 14 Plot of Upper Band Edge (P-mode).....28

Figure 15 Plot of Transmitter 20-dB Occupied Bandwidth (P-mode).....28

Figure 16 Plot of Power Spectral Density (P-Mode).....29

Figure 17 Plot of Power Spectral Density (P-Mode).....29

Figure 18 Plot of Power Spectral Density (P-Mode).....30

Figure 19 Plot of Channel Separation (P-mode).....30

Figure 20 Plot of Output Power (P-Mode)31

Figure 21 Plot of Output Power (P-Mode)31

Figure 22 Plot of Output Power (P-Mode)31

Figure 23 Plot of Out of Band Emissions32

Transmitter Emissions Data.....33

Table 4 Transmitter Radiated Emission M-mode Worst-case Data.....33

Table 5 Transmitter Radiated Emission P-mode Worst-case Data.....34

Table 6 Transmitter Antenna Port Data35

Summary of Results for Transmitter Radiated Emissions of Intentional Radiator35

ANNEX..... 36

Annex A Measurement Uncertainty Calculations.....37

Annex B Rogers Labs Test Equipment List.....38

Annex C Rogers Qualifications39

Annex D Rogers Labs Certificate of Accreditation.....40

Revisions

Revision 1 Issued February 1, 2018

Foreword

The following information is submitted for consideration in obtaining Grant of Certification for License Exempt Hybrid Digital Transmission System Intentional Radiator operating under Code of Federal Regulations Title 47 (CFR 47) Paragraph 15.247 and Industry Canada RSS-GEN, Issue 4 and RSS-247 Issue 2, operation in the 902-928 MHz band.

Name of Applicant: SAF Tehnika AS
24a, Ganibu dambis
Riga Latvia LV-1005

M/N: TDSPC0U1

FCC ID: W9Z-ARANETCO2 IC: 8855A-ARANETCO2

Frequency Range: 917.3-923.5 MHz output power 0.029 W
(99% Occupied bandwidth 748.5 kHz)

Opinion / Interpretation of Results

Tests Performed	Margin (dB)	Results
Emissions 15.205, RSS-GEN	-14.2	Complies
Emissions as per CFR 47 paragraphs 2 and 15.207	N/A	Complies
Emissions as per CFR 47 paragraphs 2 and 15.209	-14.4	Complies
Harmonic Emissions per CFR 47 15.247	-14.2	Complies
Peak Power Spectral Density per CFR 47 15.247	-5.2	Complies

Equipment Tested

<u>Equipment</u>	<u>Model / PN</u>	<u>Serial Number</u>
EUT #1 (pair mode)	TDSPC0U1	00001
EUT #2 (Antenna port, M mode)	TDSPC0U1	00002
EUT #3 (Antenna port, P mode)	TDSPC0U1	00003
EUT #4 (Radiated, M mode)	TDSPC0U1	00004
EUT #5 (Radiated, P mode)	TDSPC0U1	00005

Test results in this report relate only to the items tested.

Equipment Function

The EUT is a battery operated mobile sensor incorporating 917.3-923.5 MHz Hybrid Digital Transmission System for wireless data transfer. The device provides a specific sensor to measure a parameter of interest (this device monitors Carbon Dioxide (CO₂)). The sensor data is then broadcast to a remotely located base station. The transmitter operates in a hybrid mode employing a combination of both frequency hopping and digital modulation techniques. The sensors transmitter function operates in one of two modes (either M-mode or P-mode) as described by the manufacturer. Operation in the P-Mode employs a combination of both frequency hopping and digital modulation techniques and the M-mode operates as a digital modulation transmission system. Operational mode is defined at moment of sensor pairing with either Aranet Pro (P-mode) or Aranet Mini (M-mode) base station. The sensor operates from 2 AAA replaceable batteries only and offers no provision for alternate power source. Pairing between the sensor and base station is completed when the sensor battery is inserted, and the pairing function activated. Once a sensor has been paired both devices (sensor and base station) are aware of the other and retain the system information in local memory. The sensor sends a request for pairing containing technical information about the sensor. The base station responds back with configuration information consisting of transmission mode, transmission channels and transmissions interval. The sensor then replies with an acknowledgement. Once the pairing has been completed, the sensor and base station are able to communicate. The base station performs decrypting of the sensors data transmissions and provides access to the data for the end user. Five test samples were provided to for testing purposes each configured for specific operation. Sample 1 represented a production product with production software. This sample requires being paired with a base station for operation. Samples 2 and 3 were modified samples with the integral Printed Circuit Board Trace antenna replaced with a coaxial cable and connector. These samples were provided for antenna port conducted emissions testing and were provided with test software to enable transmit operation on lowest, middle and highest operating channels. Sample 2 operated in M-mode and sample 3 operated in P-mode. Samples 4 and 5 were production printed circuit boards with integral antenna. Each of these contained the test software to provide M-mode or P-mode operation at the three required channels. Test samples 4 and 5 were used to during radiated emissions testing of the general and harmonic emissions. Samples 2 and 3 were used for antenna port

conducted emissions testing and demonstration of compliance. For testing purposes, each test sample received power from new replaceable AAA batteries and configured to operate in available modes. The test software provided operation of the transmitter at 100% duty cycle for testing. The equipment was tested for emissions compliance using the available configurations with the worst-case data presented. Test results in this report relate only to the products described in this report.

Equipment Operations

The Aranet products have three distinct operation modes, which use the following radio frequency channels:

- Pairing mode utilized by all of the products (TX and RX)
 - 923.2 MHz @ 500 kHz
- Aranet Pro system mode utilized by sensors(TX) and Aranet Pro(RX)
 - 917.3 MHz; 922.9 MHz @ 125kHz
 - 917.5 MHz; 923.1 MHz @ 125kHz
 - 917.7 MHz; 923.3 MHz @ 125kHz
 - 917.9 MHz; 923.5 MHz @ 125kHz
- Aranet Mini system mode utilized by sensors(TX) and Aranet Mini(RX)
 - 917.6 MHz @ 500 kHz
 - 918.4 MHz @ 500 kHz
 - 919.2 MHz @ 500 kHz
 - 920.0 MHz @ 500 kHz
 - 920.8 MHz @ 500 kHz
 - 921.6 MHz @ 500 kHz
 - 922.4 MHz @ 500 kHz
 - 923.5 MHz @ 500 kHz

Aranet Mini and Aranet Pro base stations choose their initial operational channel randomly, when the device is first powered up.

Equipment Configuration

- 1) Unit operating from replaceable AAA internal batteries

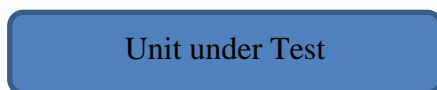

- 2) Antenna Port Modified Unit operating from replaceable AAA internal batteries



Application for Certification

- (1) Manufacturer: SAF Tehnika AS
24a, Ganibu dambis
Riga Latvia LV-1005
- (2) Identification: M/N: TDSPC0U1
FCC ID: W9Z-ARANETCO2 IC: 8855A-ARANETCO2
- (3) Instruction Book:
Refer to Exhibit for Instruction Manual.
- (4) Description of Circuit Functions:
Refer to Exhibit of Operational Description.
- (5) Block Diagram with Frequencies:
Refer to Exhibit of Operational Description.
- (6) Report of Measurements:
Report of measurements follows in this Report.
- (7) Photographs: Construction, Component Placement, etc.:
Refer to Exhibit for photographs of equipment.
- (8) List of Peripheral Equipment Necessary for operation. The equipment operates from replaceable AAA batteries only and provides no other interface options as presented in this filing. The EUT offers no other connection ports than those presented in this filing.
- (9) Transition Provisions of CFR47 15.37 are not requested.
- (10) Not Applicable. The unit is not a scanning receiver.
- (11) Not Applicable. The EUT does not operate in the 59 – 64 GHz frequency band.
- (12) The equipment is not software defined and this section is not applicable.
- (13) Applications for certification of U-NII devices in the 5.15-5.35 GHz and the 5.47-5.85 GHz bands must include a high-level operational description of the security procedures that control the radio frequency operating parameters and ensure that unauthorized modifications cannot be made. This requirement is not applicable to his DTS device.
- (14) Contain at least one drawing or photograph showing the test set-up for each of the required types of tests applicable to the device for which certification is requested. These drawings or photographs must show enough detail to confirm other information contained in the test report. Any photographs used must be focused originals without glare or dark spots and must clearly show the test configuration used. This information is provided in this report and Test Setup Exhibits provided with the application filing.

Applicable Standards & Test Procedures

The following information is submitted in accordance with the eCFR Federal Communications Code of Federal Regulations, dated November 6, 2017, Part 2, Subpart J, Paragraphs 2.907, 2.911, 2.913, 2.925, 2.926, 2.1031 through 2.1057, and applicable parts of paragraph 15, Part 15C Paragraph 15.247, and Industry Canada RSS-GEN Issue 4, and RSS-247 Issue 2. This equipment operates as hybrid Digital Transmission System. Hybrid systems are those that employ a combination of both frequency hopping and digital modulation techniques. The frequency hopping operation of the hybrid system, with the direct sequence or digital modulation operation turned-off, provides an average time of occupancy on any frequency not exceeding 0.4 seconds within a time period in seconds equal to the number of hopping frequencies employed multiplied by 0.4. The power spectral density conducted from the intentional radiator to the antenna due to the digital modulation operation of the hybrid system, with the frequency hopping operation turned off, remains below the 8 dBm in any 3-kHz band during any time interval of continuous transmission. Test procedures used are as defined in KDB 558074 D01 DTS Meas Guidance v04.

Testing Procedures

AC Line Conducted Emission Test Procedure

The design operates solely from direct current power provided from replaceable AAA batteries. The design offers no provision connection with Utility AC power system and therefore is exempt from AC Line conducted emissions testing.

Radiated Emission Test Procedure

Radiated emissions testing was performed as required in CFR47 15, RSS-247 and specified in ANSI C63.10-2013. The EUT was placed on a rotating 0.9 x 1.2-meter platform, elevated as required above the ground plane at a distance of 3 meters from the FSM antenna. EMI energy was maximized by equipment placement permitting orientation in three orthogonal axes, raising and lowering the FSM antenna, changing the antenna polarization, and by rotating the turntable. Each emission was maximized before data was taken using a spectrum analyzer. The frequency spectrum from 9 kHz to 25,000 MHz was searched for during preliminary investigation. Refer to diagrams one and two showing typical test arrangement and photographs in the test setup exhibits for specific EUT placement during testing.

Rogers Labs, Inc.

4405 W. 259th Terrace Model: TDSPC0U1, Aranet CO₂ Sensor

Louisburg, KS 66053

Phone/Fax: (913) 837-3214

Revision 1

SAF Tehnika AS

Test #: 171106B

Test to: CFR47 15C, RSS-Gen RSS-247

File: SAF ARANETCO2 DTS TstRpt 171106B

Page 10 of 40

S/N's: 00001, 2, 3, 4 and 5

FCC ID: W9Z-ARANETCO2

IC: 8855A- ARANETCO2

Date: February 1, 2018

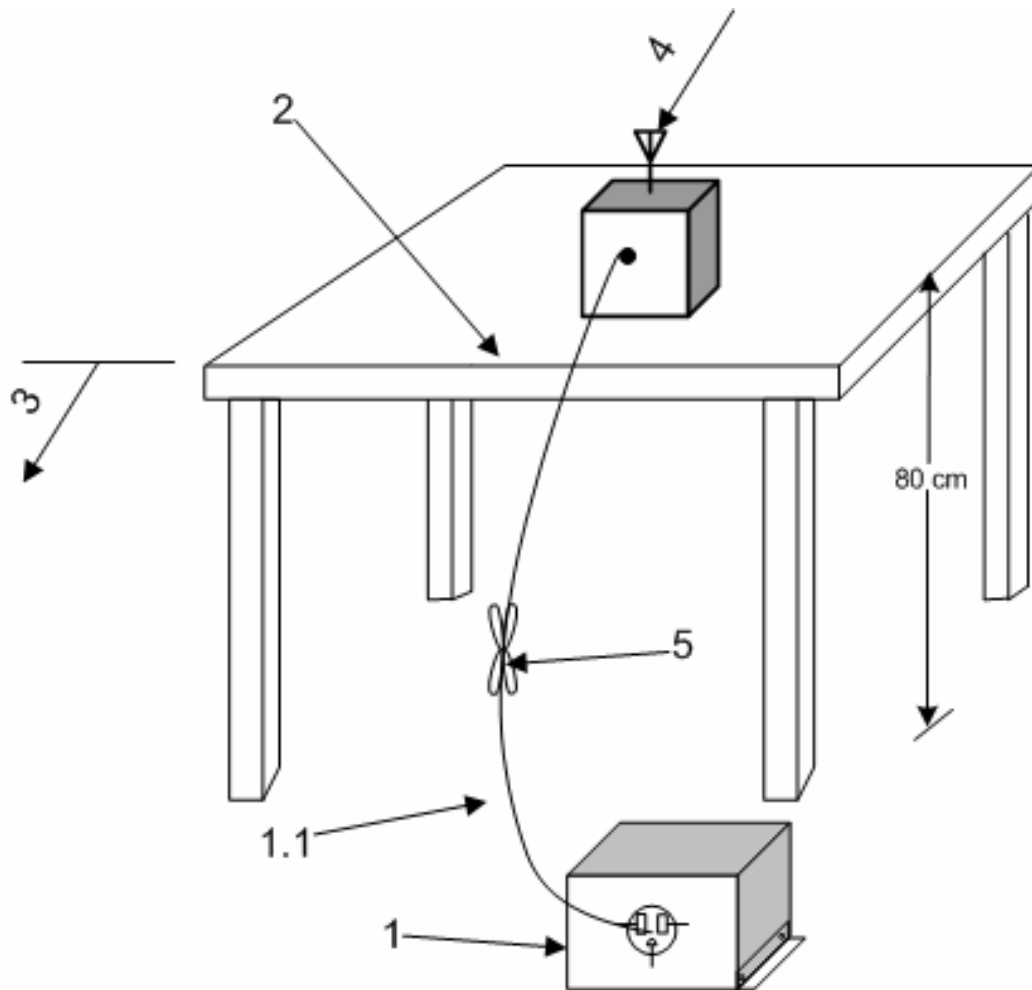

1. A LISN is optional for radiated measurements between 30 MHz to 1000 MHz, but not allowed for measurements below 30 MHz and above 1000 MHz. (See 6.4.3, 6.5.1, and 6.6.3.) If used, connect EUT to one LISN. Unused LISN measuring port connectors shall be terminated in 50Ω. LISN can be placed on top of, or immediately beneath, reference ground plane (see 6.2.2 and 6.2.3.1).
 - 1.1 LISN spaced at least 80 cm from nearest part of EUT chassis.
2. The EUT shall be placed in the center of the table to the extent possible. (See 6.2.3.1 and 6.3.4).
3. A vertical conducting plane, if used for conducted tests per 6.2.2, shall be removed for radiated emission tests.
4. Antenna may be integral or detachable, depending on the EUT.
5. Interconnecting cables that hang closer than 40 cm to the ground plane shall be folded back and forth in the center forming a bundle 30 cm to 40 cm long.

Diagram 1 Test arrangement for radiated emissions of tabletop equipment

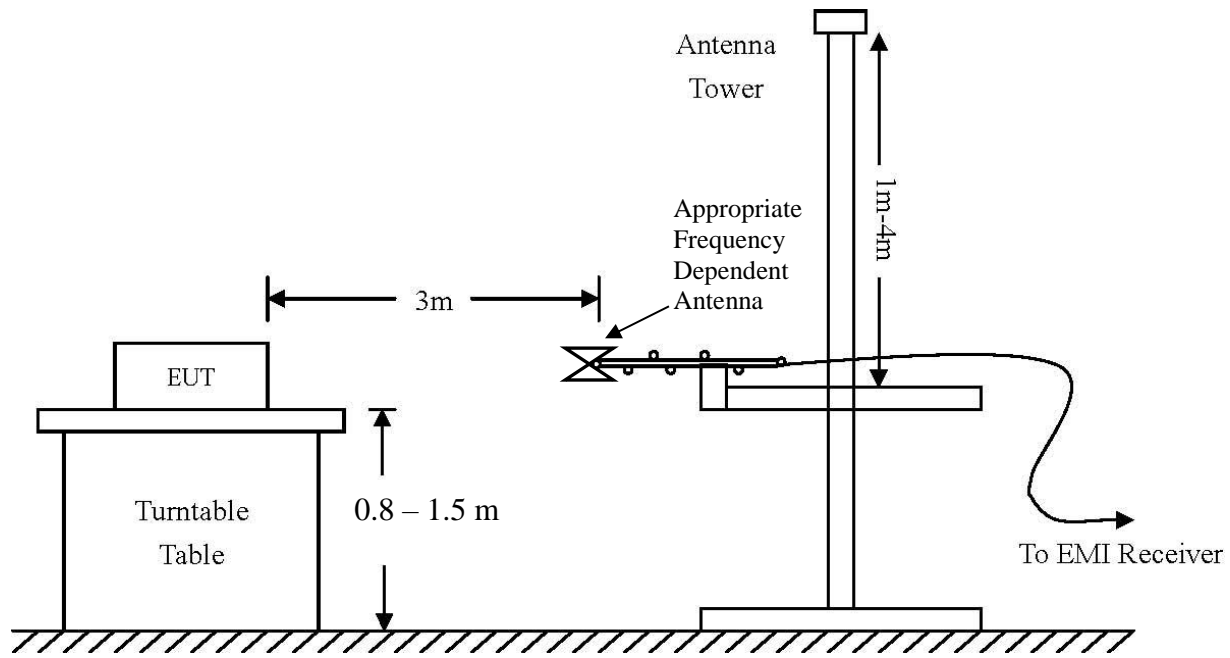

AC Line Conducted Emissions (0.150 -30 MHz)		
RBW	AVG. BW	Detector Function
9 kHz	30 kHz	Peak / Quasi Peak
Emissions (30-1000 MHz)		
RBW	AVG. BW	Detector Function
120 kHz	300 kHz	Peak / Quasi Peak
Emissions (Above 1000 MHz)		
RBW	Video BW	Detector Function
100 kHz	100 kHz	Peak
1 MHz	1 MHz	Peak / Average

Diagram 2 Test arrangement for radiated emissions tested on Open Area Test Site (OATS)

Test Site Locations

Conducted EMI: The AC power line conducted emissions testing performed in a shielded screen room located at Rogers Labs, Inc., 4405 West 259th Terrace, Louisburg, KS

Radiated EMI: The radiated emissions tests were performed at the 3 meters, Open Area Test Site (OATS) located at Rogers Labs, Inc., 4405 West 259th Terrace, Louisburg, KS

Site Registration: Refer to Annex for Site Registration Letters

NVLAP Accreditation: Lab code 200087-0

List of Test Equipment

<u>Equipment</u>	<u>Manufacturer</u>	<u>Model (SN)</u>	<u>Band</u>	<u>Cal Date</u>	<u>Due</u>
<input type="checkbox"/> LISN	FCC	FCC-LISN-50-2-10(1PA) (160611)	.15-30MHz	5/17	5/18
<input checked="" type="checkbox"/> Cable	Time Microwave	750HF290-750 (L10M)	9kHz-40 GHz	10/17	10/18
<input type="checkbox"/> Cable	Belden	RG-58 (L1-CAT3-11509)	9kHz-30 MHz	10/17	10/18
<input type="checkbox"/> Cable	Belden	RG-58 (L2-CAT3-11509)	9kHz-30 MHz	10/17	10/18
<input type="checkbox"/> Antenna	ARA	BCD-235-B (169)	20-350MHz	10/17	10/18
<input type="checkbox"/> Antenna	EMCO	3147 (40582)	200-1000MHz	10/17	10/18
<input checked="" type="checkbox"/> Antenna	ETS-Lindgren	3117 (200389)	1-18 GHz	5/17	5/18
<input type="checkbox"/> Antenna	Com Power	AH-118 (10110)	1-18 GHz	10/17	10/19
<input checked="" type="checkbox"/> Antenna	Com Power	AH-840 (101046)	18-40 GHz	5/17	5/19
<input checked="" type="checkbox"/> Antenna	Com Power	AL-130 (121055)	.001-30 MHz	10/17	10/18
<input checked="" type="checkbox"/> Antenna	Sunol	JB-6 (A100709)	30-1000 MHz	10/17	10/18
<input type="checkbox"/> Antenna	EMCO	3143 (9607-1277)	20-1200 MHz	5/17	5/18
<input type="checkbox"/> Analyzer	HP	8591EM (3628A00871)	9kHz-1.8GHz	5/17	5/18
<input type="checkbox"/> Analyzer	HP	8562A (3051A05950)	9kHz-110GHz	5/17	5/18
<input type="checkbox"/> Analyzer	HP External Mixers	11571, 11970	25GHz-110GHz	5/17	5/18
<input checked="" type="checkbox"/> Analyzer	Rohde & Schwarz	ESU40 (100108)	20Hz-40GHz	5/17	5/18
<input checked="" type="checkbox"/> Amplifier	Com-Power	PA-010 (171003)	100Hz-30MHz	10/17	10/18
<input checked="" type="checkbox"/> Amplifier	Com-Power	CPPA-102 (01254)	1-1000 MHz	10/17	10/18
<input checked="" type="checkbox"/> Amplifier	Com-Power	PAM-118A (551014)	0.5-18 GHz	10/17	10/18
<input type="checkbox"/> Power Mtr	Agilent	N1911A with N1921A	0.05-18 GHz	5/17	5/18

Units of Measurements

Conducted EMI Data is in dB μ V; dB referenced to one microvolt

Radiated EMI Data is in dB μ V/m; dB/m referenced to one microvolt per meter

Sample Calculation:

RFS = Radiated Field Strength, FSM = Field Strength Measured

A.F. = Receive antenna factor, Gain = amplification gains and/or cable losses

RFS (dB μ V/m @ 3m) = FSM (dB μ V) + A.F. (dB) - Gain (dB)

Environmental Conditions

Ambient Temperature 19.0° C

Relative Humidity 39%

Atmospheric Pressure 1020.2 mb

Statement of Modifications and Deviations

No modifications to the EUT were required for the unit to demonstrate compliance with the CFR47 Part 15C, RSS-Gen, and RSS-247 emission requirements. There were no deviations to the specifications.

Intentional Radiators

The following information is submitted in support demonstration of compliance with the requirements of CFR47, Subpart C, paragraph 15.247 and Industry Canada RSS-247 and RSS-Gen the following information is submitted.

Antenna Requirements

The EUT incorporates integral antenna system and offers no provision for connection to alternate antenna system. The antenna connection point complies with the unique antenna connection requirements. There are no deviations or exceptions to the specification.

Restricted Bands of Operation

Spurious emissions falling in the restricted frequency bands of operation were measured at the OATS. The EUT utilizes frequency, determining circuitry, which generates harmonics falling in the restricted bands. Emissions were investigated at the OATS, using appropriate antennas or pyramidal horns, amplification stages, and a spectrum analyzer. Peak and average amplitudes of frequencies above 1000 MHz were compared to the required limits with worst-case data presented below. Test procedures of ANSI C63.10-2013 paragraph 6 and KDB 558074 paragraph 12 were used during testing. No other significant emission was observed which fell into the restricted bands of operation. Computed emission values consider the received radiated field strength, receive antenna correction factor, amplifier gain stage, and test system cable losses.

Table 1 Harmonic Radiated Emissions in Restricted Bands Data M-mode (Worst-case)

Frequency in MHz	Horizontal Peak (dB μ V/m)	Horizontal Quasi-Peak (dB μ V/m)	Horizontal Average (dB μ V/m)	Vertical Peak (dB μ V/m)	Vertical Quasi-Peak (dB μ V/m)	Vertical Average (dB μ V/m)	Limit @ 3m (dB μ V/m)
2752.8	44.3	N/A	32.9	45.3	N/A	34.4	54.0
3670.4	42.8	N/A	29.6	42.7	N/A	29.7	54.0
4588.0	43.4	N/A	30.4	43.2	N/A	30.5	54.0
2760.0	44.8	N/A	32.9	44.8	N/A	33.5	54.0
3680.0	42.3	N/A	29.6	42.2	N/A	29.6	54.0
4600.0	45.9	N/A	31.9	45.0	N/A	32.0	54.0
2767.2	43.7	N/A	32.4	44.3	N/A	33.8	54.0
3689.6	43.6	N/A	30.5	43.1	N/A	30.5	54.0
4612.0	44.0	N/A	31.4	44.3	N/A	31.5	54.0

Other emissions present had amplitudes at least 20 dB below the limit. Peak and Quasi-Peak amplitude emissions are recorded for frequency below 1000 MHz. Peak and Average amplitude emissions are recorded for frequency range above 1000 MHz.

Table 2 Harmonic Radiated Emissions in Restricted Bands Data P-mode (Worst-case)

Frequency in MHz	Horizontal Peak (dB μ V/m)	Horizontal Quasi-Peak (dB μ V/m)	Horizontal Average (dB μ V/m)	Vertical Peak (dB μ V/m)	Vertical Quasi-Peak (dB μ V/m)	Vertical Average (dB μ V/m)	Limit @ 3m (dB μ V/m)
2751.9	44.6	N/A	35.5	46.8	N/A	38.6	54.0
3669.2	42.7	N/A	29.8	42.1	N/A	29.7	54.0
4586.5	43.1	N/A	30.7	43.3	N/A	30.7	54.0
2760.9	44.4	N/A	34.9	45.6	N/A	38.2	54.0
3681.2	42.6	N/A	29.8	42.2	N/A	29.7	54.0
4601.5	44.6	N/A	32.1	45.0	N/A	31.9	54.0
2770.5	44.5	N/A	34.9	46.7	N/A	39.8	54.0
3694.0	44.1	N/A	31.2	44.2	N/A	31.1	54.0
4617.5	44.2	N/A	30.9	43.2	N/A	30.8	54.0

Other emissions present had amplitudes at least 20 dB below the limit. Peak and Quasi-Peak amplitude emissions are recorded for frequency below 1000 MHz. Peak and Average amplitude emissions are recorded for frequency range above 1000 MHz.

Summary of Results for Radiated Emissions in Restricted Bands

The EUT demonstrated compliance with the radiated emissions requirements of CFR 47 Part 15C RSS-Gen, and RSS-247 Intentional Radiators. The EUT demonstrated a worst-case minimum radiated emission in restricted bands providing a minimum margin of -14.2 dB below the radiated emissions requirements. Peak and average amplitudes were checked for compliance with the regulations. Worst-case emissions are reported with other emissions found in the restricted frequency bands at least 20 dB below the requirements.

AC Line Conducted Emissions Procedure

The design operates solely from direct current power provided from replaceable AAA batteries. The design offers no provision connection with Utility AC power system and therefore is exempt from AC Line conducted emissions testing.

General Radiated Emissions Procedure

The EUT was arranged in a typical equipment configuration and operated through all available mode during testing. Preliminary testing was performed in a screen room with the EUT positioned 1 meter from the FSM. Radiated emissions measurements were performed to identify the frequencies, which produced the highest emissions. Each radiated emission was then maximized at the OATS location before final radiated measurements were performed. Final data was taken with the EUT located on the OATS at 3 meters distance between the EUT and the receiving antenna. The frequency spectrum from 9 kHz to 10,000 MHz was searched for general radiated emissions. Measured emission levels were maximized by EUT placement on the table, rotating the turntable through 360 degrees, varying the antenna height between 1 and 4 meters above the ground plane and changing antenna position between horizontal and vertical polarization. Antennas used were Loop from 9 kHz to 30 MHz, Broadband Biconical from 30 to 200 MHz, Biconilog from 30 to 1000 MHz, Log Periodic from 200 MHz to 1 GHz and or double Ridge or pyramidal horns and mixers above 1 GHz, notch filters and appropriate amplifiers and external mixers were utilized.

Table 3 General Radiated Emissions Data

Frequency in MHz	Horizontal Peak (dB μ V/m)	Horizontal Quasi-Peak (dB μ V/m)	Horizontal Average (dB μ V/m)	Vertical Peak (dB μ V/m)	Vertical Quasi-Peak (dB μ V/m)	Vertical Average (dB μ V/m)	Limit @ 3m (dB μ V/m)
1835.20	39.8	N/A	26.6	45.7	N/A	39.6	54.0
1840.00	40.4	N/A	29.1	44.4	N/A	37.1	54.0
1844.80	39.4	N/A	26.6	44.7	N/A	37.7	54.0
1834.60	42.6	N/A	34.4	43.7	N/A	37.2	54.0
1840.60	42.3	N/A	33.2	43.3	N/A	36.4	54.0
1847.00	41.5	N/A	32.0	43.7	N/A	37.1	54.0

Other emissions present had amplitudes at least 20 dB below the limit. Peak and Quasi-Peak amplitude emissions are recorded for frequency range below 1000 MHz. Peak and Average amplitude emissions are recorded for frequency range above 1000 MHz.

Summary of Results for General Radiated Emissions

The EUT demonstrated compliance with the radiated emissions requirements of CFR47 Part 15C paragraph 15.209, RSS-247 and RSS-GEN Intentional Radiators. The EUT demonstrated a minimum margin of -14.4 dB below the requirements. Other emissions were present with amplitudes at least 20 dB below the Limits.

Operation in the Band 902-928 MHz

This device provides operation as hybrid Digital Transmission System.

Text from FCC Publication 453039 is presented below to clarify interpretation of Hybrid operation and requirements.

“The third method of authorizing a combination system is as a hybrid system under the provisions described in Section 15.247(f) of the rules. Before the new rules on DTS operation, a hybrid system consisted of a transmission system that employed a combination of both direct sequence and frequency hopping techniques. Such systems were required to show compliance with a 17-dB processing gain. This is no longer required since the processing gain requirement has been replaced by the DTS regulations. A hybrid system uses both digital modulation and frequency hopping techniques at the same time on the same carrier. This is similar to the combination DTS/FHSS system described above in the first example but the system is subject to slightly different standards. As shown in Section 15.247(f), a hybrid system must comply with the power density standard of 8 dBm in any 3-kHz band when the frequency hopping function is turned off. The transmission also must comply with a 0.4 second/channel maximum dwell time when the hopping function is turned on. There is no requirement for this type of hybrid system to comply with the 500-kHz minimum bandwidth normally associated with a DTS transmission; and, there is no minimum number of hopping channels associated with this type of hybrid system.

However, the hopping function must be a true hopping system, as described in Section 15.247(a)(1). The specific requirements in Section 15.247(a)(1) are: 1) a minimum channel separation; 2) pseudo-random hop sequence; 3) equal use of each frequency; 4) receiver matching bandwidth and Synchronization; The additional requirements in Section 15.247 for a hybrid transmitter include the requirements the 1-watt output limit and RF safety requirements in Section 15.247(b) and the spurious emission limits of Section 15.247(c).”

The requirements and demonstration of compliance with RSS-247 and CFR47 subpart 15.247 applicable requirements of paragraphs (a) through (i) are addressed below.

“CFR47 15.247(a)(2) Systems using digital modulation techniques may operate in the 902-928 MHz, 2400-2483.5 MHz, and 5725-5850 MHz bands. The minimum 6 dB bandwidth shall be at least 500 kHz.

(b) The maximum peak conducted output power of the intentional radiator shall not exceed the following:

(3) For systems using digital modulation in the 902-928 MHz, 2400-2483.5 MHz, and 5725-5850 MHz bands: 1 Watt. As an alternative to a peak power measurement, compliance with the one-Watt limit can be based on a measurement of the maximum conducted output power. Maximum Conducted Output Power is defined as the total transmit power delivered to all antennas and antenna elements averaged across all symbols in the signaling alphabet when the transmitter is operating at its maximum power control level. Power must be summed across all antennas and antenna elements. The average must not include any time intervals during which the transmitter is off or is transmitting at a reduced power level. If multiple modes of operation are possible (e.g., alternative modulation methods), the maximum conducted output power is the highest total transmit power occurring in any mode.

(c) Operation with directional antenna gains greater than 6 dBi.

(d) In any 100-kHz bandwidth outside the frequency band in which the spread spectrum or digitally modulated intentional radiator is operating, the radio frequency power that is produced by the intentional radiator shall be at least 20 dB below that in the 100-kHz bandwidth within the band that contains the highest level of the desired power, based on either an RF conducted or a radiated measurement, provided the transmitter demonstrates compliance with the peak conducted power limits. If the transmitter complies with the conducted power limits based on the use of RMS averaging over a time interval, as permitted under paragraph (b)(3) of this section, the attenuation required under this paragraph shall be 30 dB instead of 20 dB. Attenuation below the general limits specified in §15.209(a) is not required. In addition, radiated emissions which fall in the restricted bands, as defined in §15.205(a), must also comply with the radiated emission limits specified in §15.209(a) (see §15.205(c)).

(e) For digitally modulated systems, the power spectral density conducted from the intentional radiator to the antenna shall not be greater than 8 dBm in any 3-kHz band during any time interval of continuous transmission. This power spectral density shall be determined in accordance with the provisions of paragraph (b) of this section. The same

method of determining the conducted output power shall be used to determine the power spectral density.

(f) For the purposes of this section, hybrid systems are those that employ a combination of both frequency hopping and digital modulation techniques. The frequency hopping operation of the hybrid system, with the direct sequence or digital modulation operation turned-off, shall have an average time of occupancy on any frequency not to exceed 0.4 seconds within a time period in seconds equal to the number of hopping frequencies employed multiplied by 0.4. The power spectral density conducted from the intentional radiator to the antenna due to the digital modulation operation of the hybrid system, with the frequency hopping operation turned off, shall not be greater than 8 dBm in any 3-kHz band during any time interval of continuous transmission.

(h) The incorporation of intelligence within a frequency hopping spread spectrum system that permits the system to recognize other users within the spectrum band so that it individually and independently chooses and adapts its hopsets to avoid hopping on occupied channels is permitted. The coordination of frequency hopping systems in any other manner for the express purpose of avoiding the simultaneous occupancy of individual hopping frequencies by multiple transmitters is not permitted.”

Compliance for operation as Digital Modulation System addresses the 6-dB DTS bandwidth, output power, power spectral density, and emissions in 100 kHz bands. Plots demonstrating compliance with these requirements are presented in figures one through eleven and data in tables 4 and 6.

Compliance for Hybrid operation addresses 0.4 second/channel maximum dwell time, minimum channel separation, Pseudo-random hop sequence, equal use of frequency, receiver bandwidth matching and synchronization. Plots demonstrating compliance with these requirements are presented in figures twelve through twenty-two and data in table 5 and 6.

Example of P-mode operation working in Channel 1 group

- After the initial pairing of sensor and base, the base continuously listens to both frequencies.
- Upon the sensor awakening, the wake-up counter is started.
- The sensor generates random number between 0.4 and 3.5. This variable is referenced as “T”

- Assuming the sensor operating in this channel group (for this example) is allowed to transmit data at either 917.3MHz or 922.9MHz
- Before each data transmission, the sensor will pseudo randomly chose frequency in which to transmit data - 917.3MHz or 922.9MHz
- Assuming that this time the pseudo random generation has chosen 917.3 MHz frequency in which to transmit data
- The sensor then “listens” to frequency 917.3MHz, to determine if the frequency is open or occupied.
- If frequency 917.3MHz is open, the sensor will send data to ARANET Pro base. If frequency is occupied, it will wait for “T” seconds and “listen” again. “Listening” can happen only 2 times. If both times frequency 917.3MHz is occupied, on 3rd time the sensor will transmit data at 917.3MHz.
- Length of data transmission from sensor to ARANET Pro base is 250ms.
- After data is transmitted, sensor goes to “sleep” and wakes up only when wake-up counter hits 600s + “T” seconds spent on listening if frequency 917.3MHz was occupied.
- When counter is done, sensor will wake-up and pseudo randomly chose frequency in which to transmit data - 917.3MHz or @ 922.9MHz and begin the cycle again.

The amplitude of each harmonic and general radiated emission was measured on the OATS at distance of 3 meters from the FSM antenna (testing was performed on samples 4 and 5 representative of production equipment with integral antenna). The EUT was positioned on supporting turntable elevated as required above the ground plane, at a distance of 3 meters from the FSM antenna. Radiated emission investigations were performed from 9 kHz to 10,000 MHz. Each radiated emission was maximized by varying the FSM antenna height and polarization, and by rotating the turntable. The worst-case amplitude of each emission was then recorded from the analyzer display. The peak and quasi-peak amplitude of frequencies below 1000 MHz were measured using a spectrum analyzer. The peak and average amplitude of frequencies above 1000 MHz were measured using a spectrum analyzer. A Loop antenna was used for measuring emissions from 0.009 to 30 MHz, Biconilog Antenna for 30 to 1000 MHz, Double-Ridge, and/or Pyramidal Horn Antennas above 1 GHz. Radiated Emissions were measured in dB μ V/m @ 3 meters. Test samples 2 and 3 were provided for antenna port conducted emissions testing. These samples were modified by replacing the internal antenna with a 50-ohm antenna port connector for testing purposes. Plots were taken of transmitter performance (using samples 2 and 3) for reference.

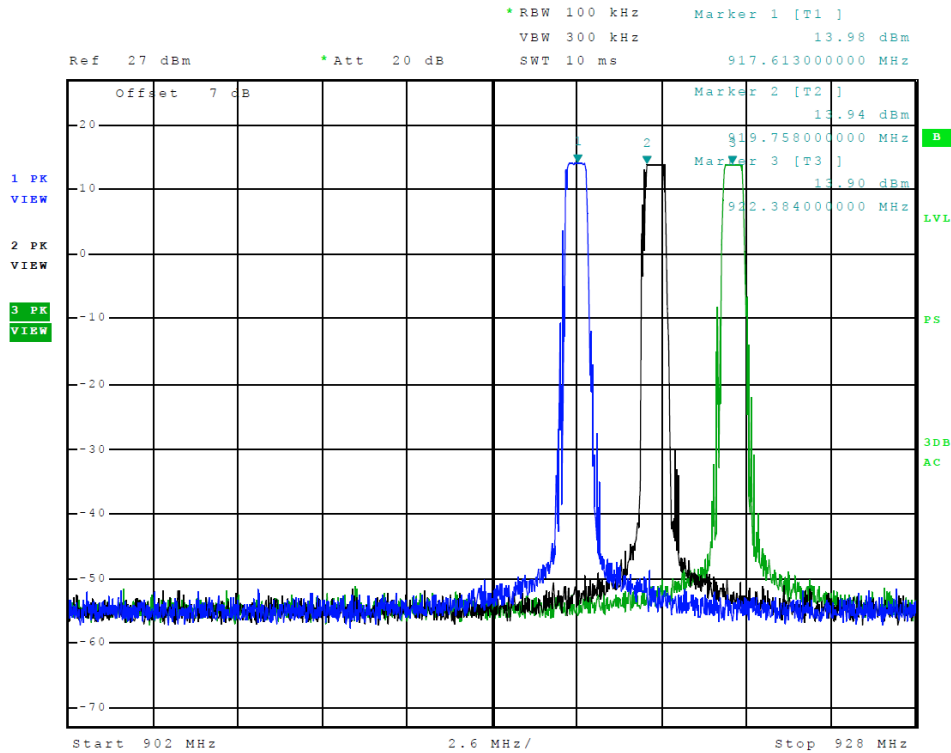

Figure 1 Plot of Transmitter Emissions in Operational Frequency Band (M-Mode)

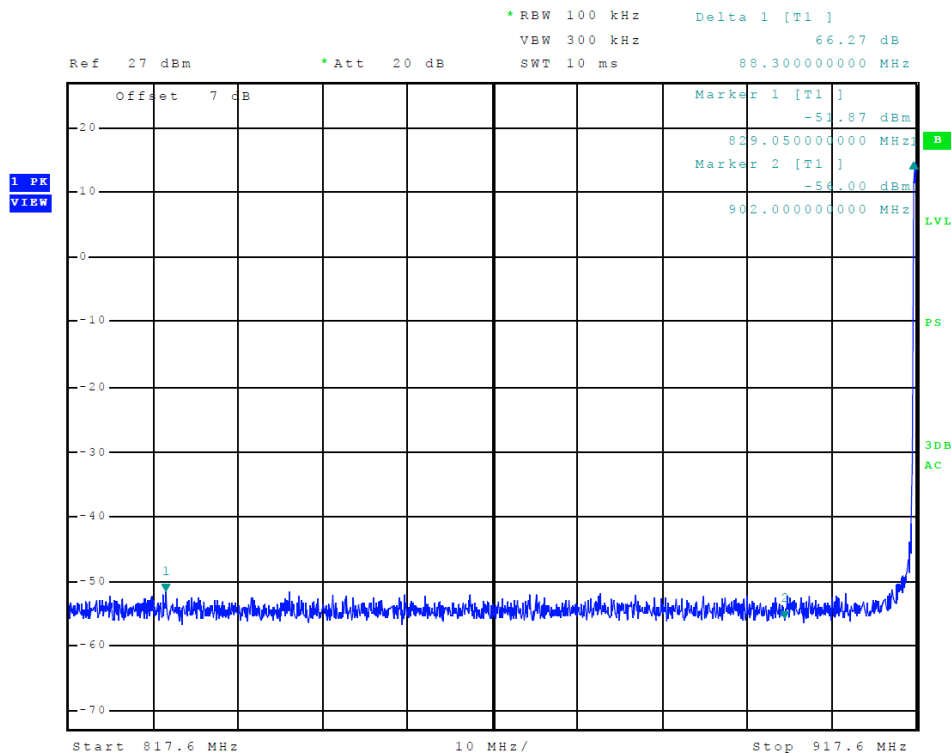

Figure 2 Plot of Lower Band Edge (M-mode)

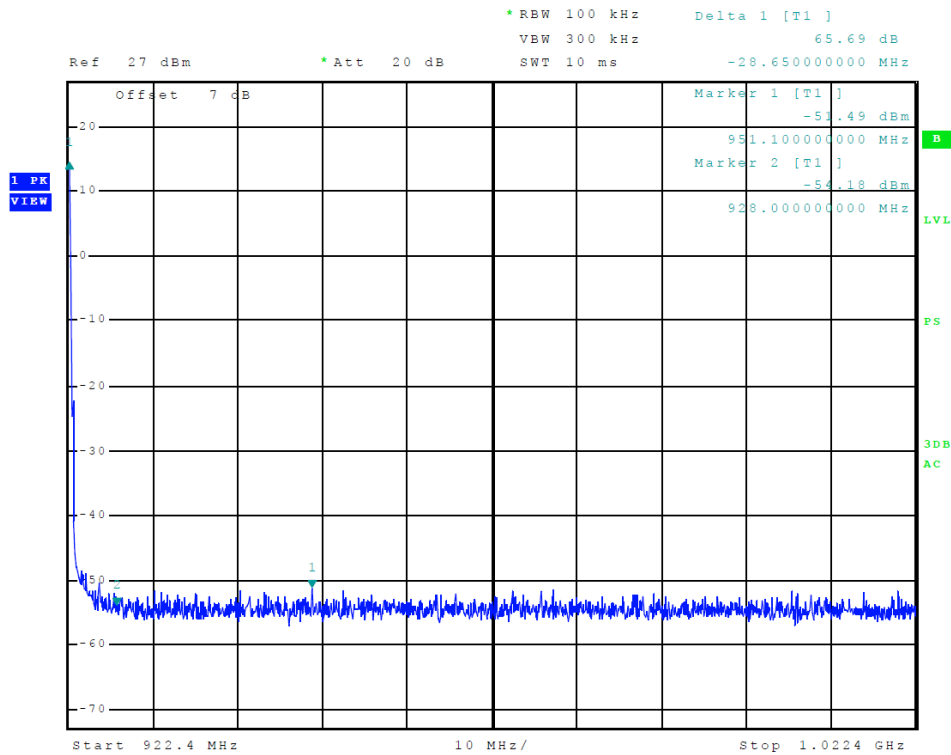

Figure 3 Plot of Upper Band Edge (M-mode)

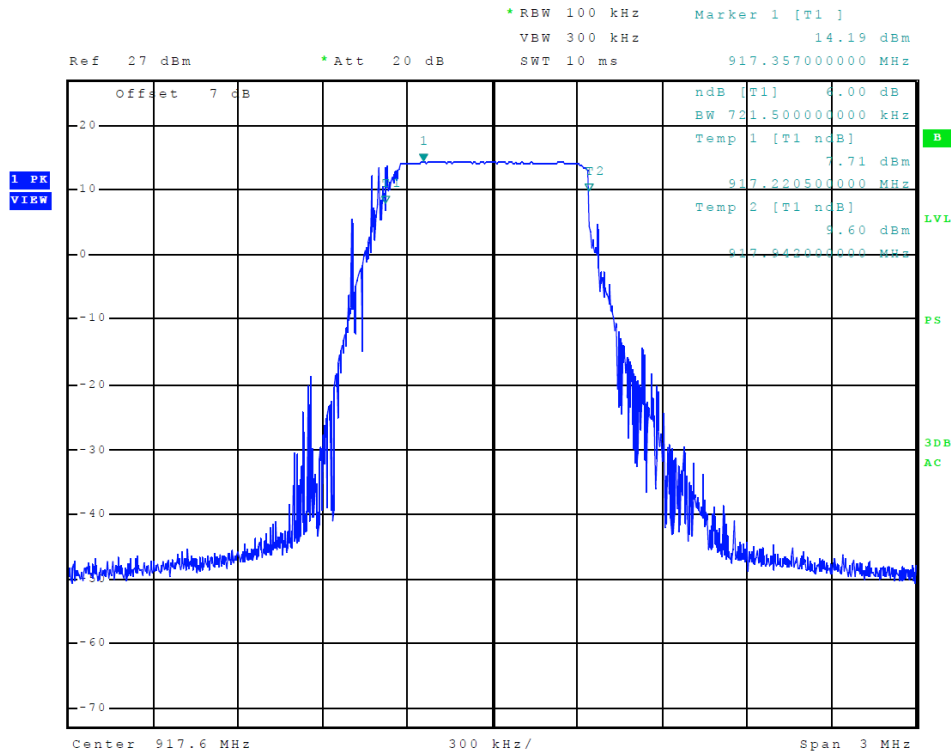

Figure 4 Plot of Transmitter 6-dB Occupied Bandwidth (M-mode)

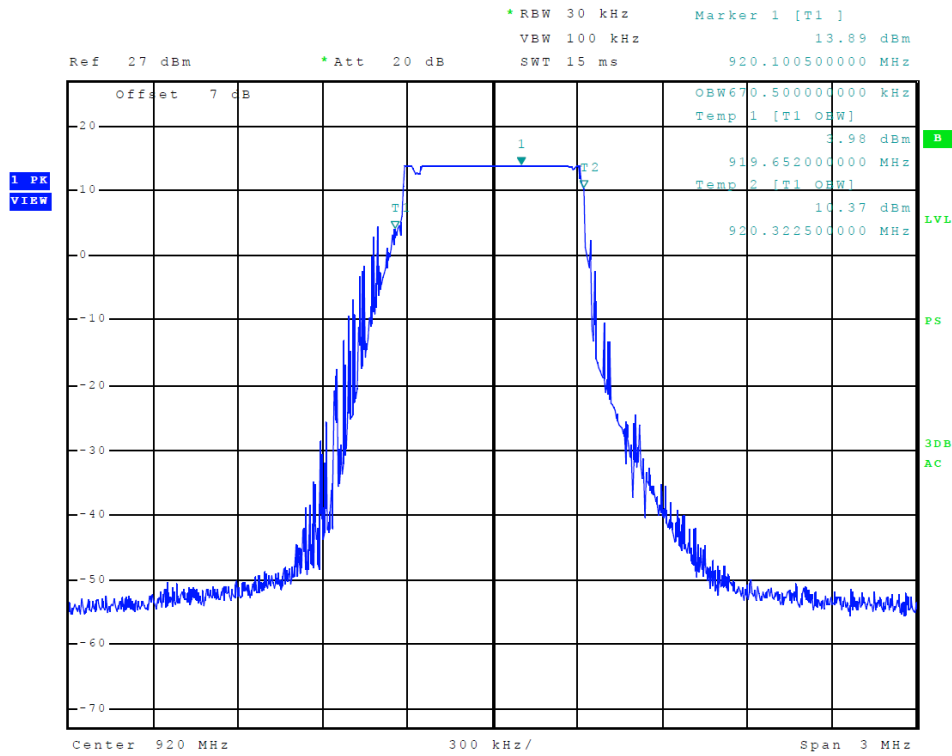

Figure 5 Plot of Transmitter 99% Occupied Bandwidth (M-mode)

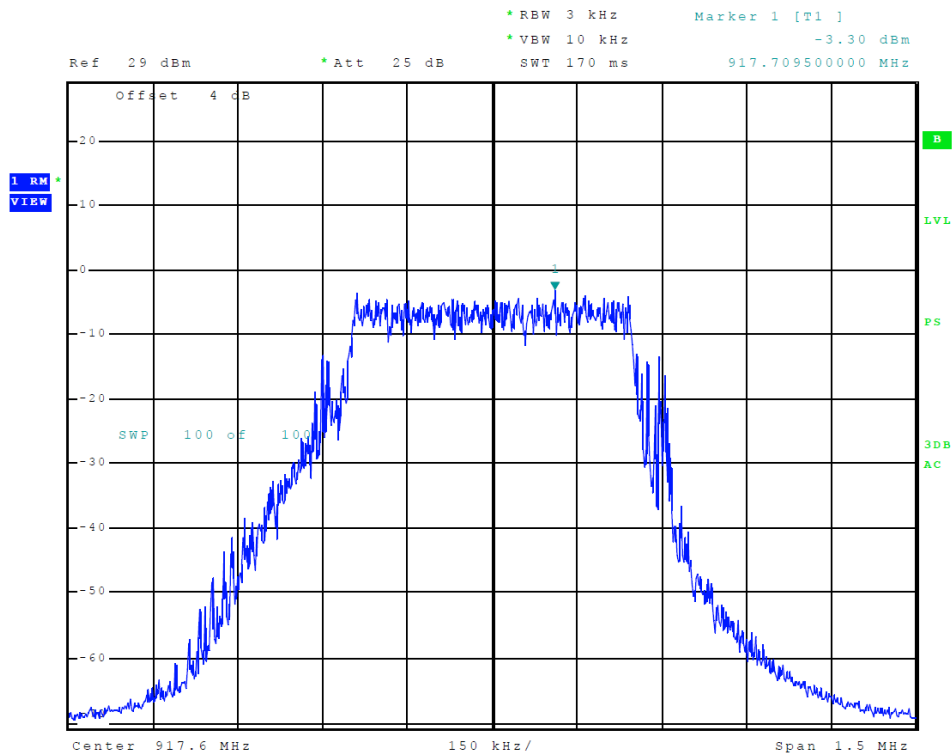

Figure 6 Plot of Power Spectral Density (M-Mode)

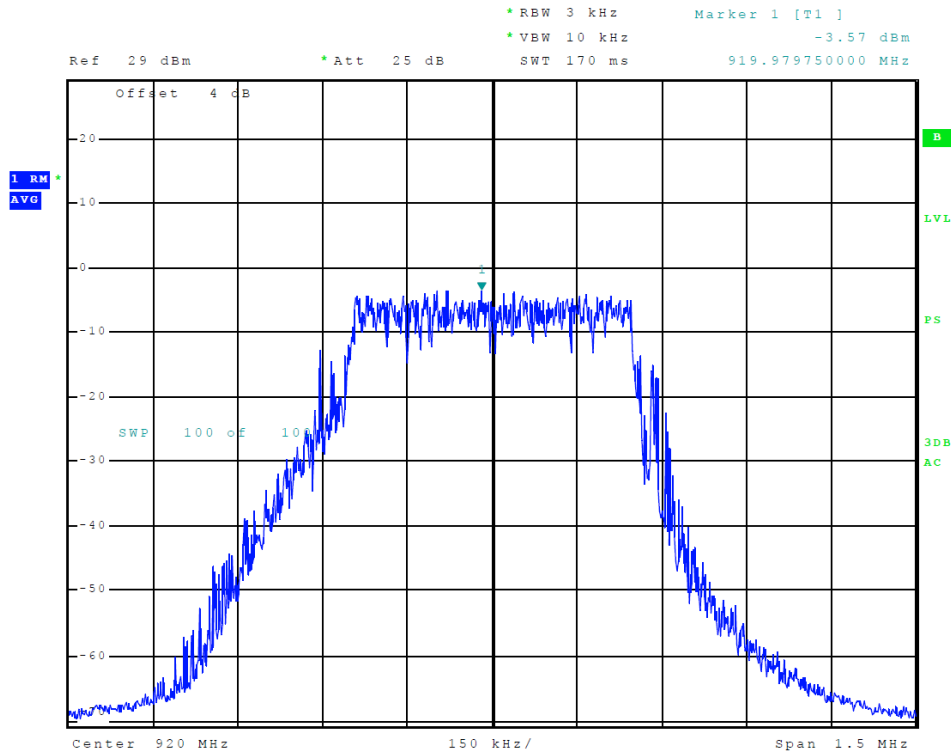

Figure 7 Plot of Power Spectral Density (M-Mode)

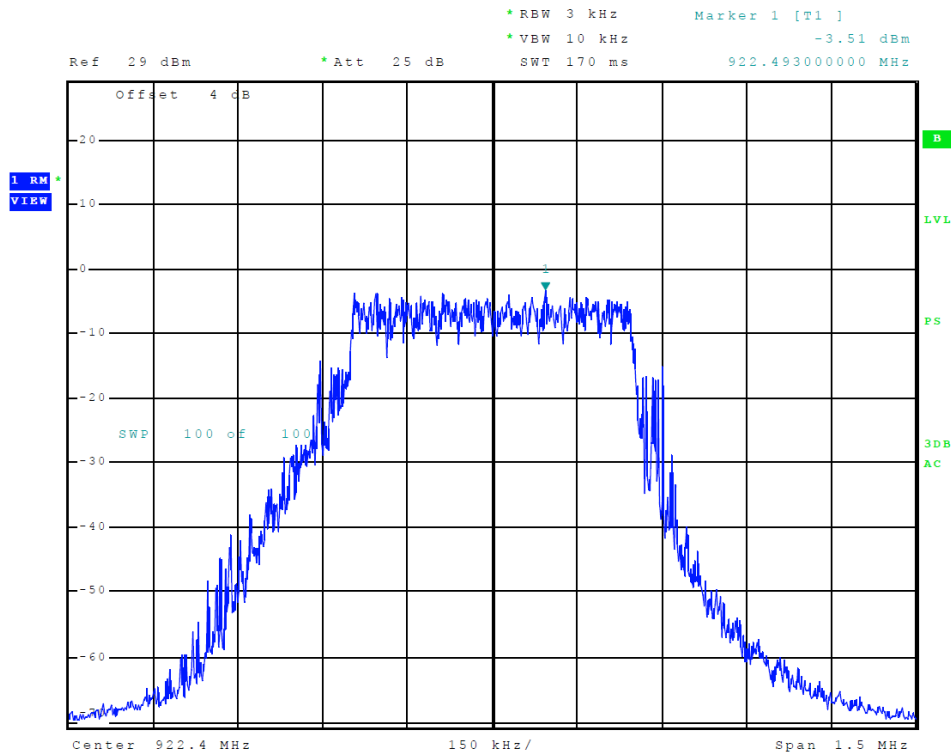

Figure 8 Plot of Power Spectral Density (M-Mode)

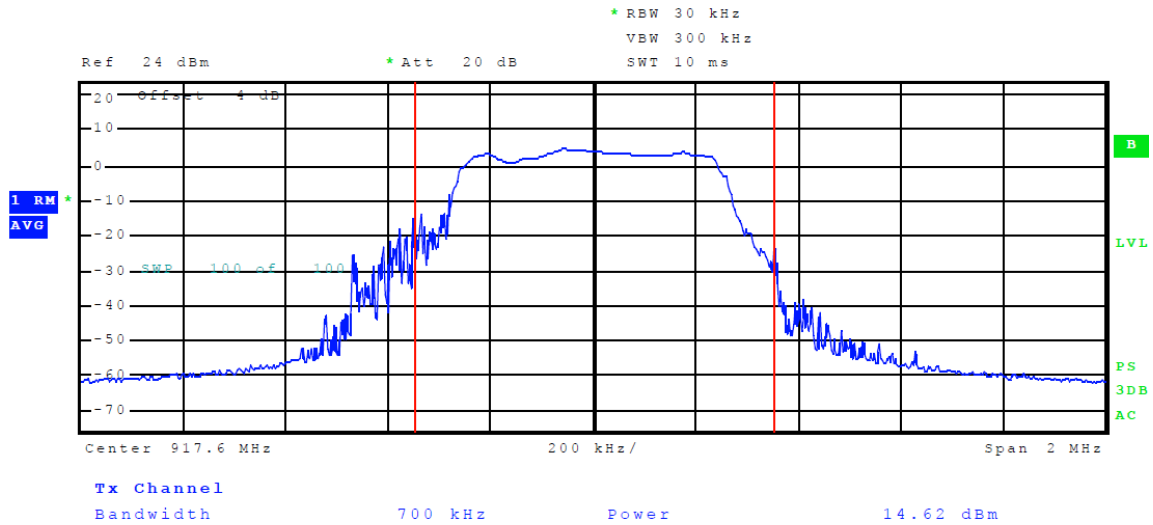

Figure 9 Plot of Output Power (M-Mode)

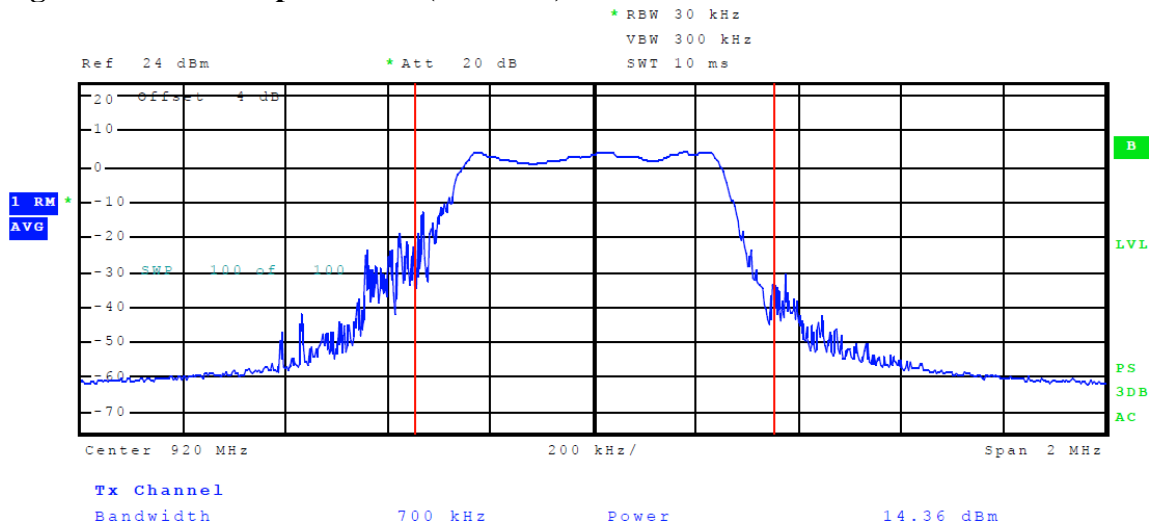

Figure 10 Plot of Output Power (M-Mode)

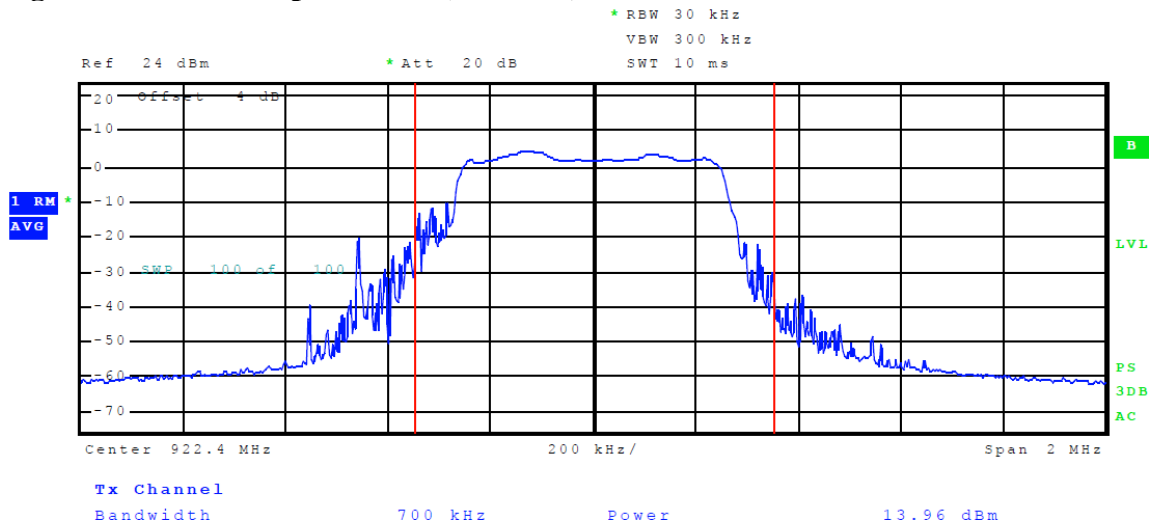

Figure 11 Plot of Output Power (M-Mode)

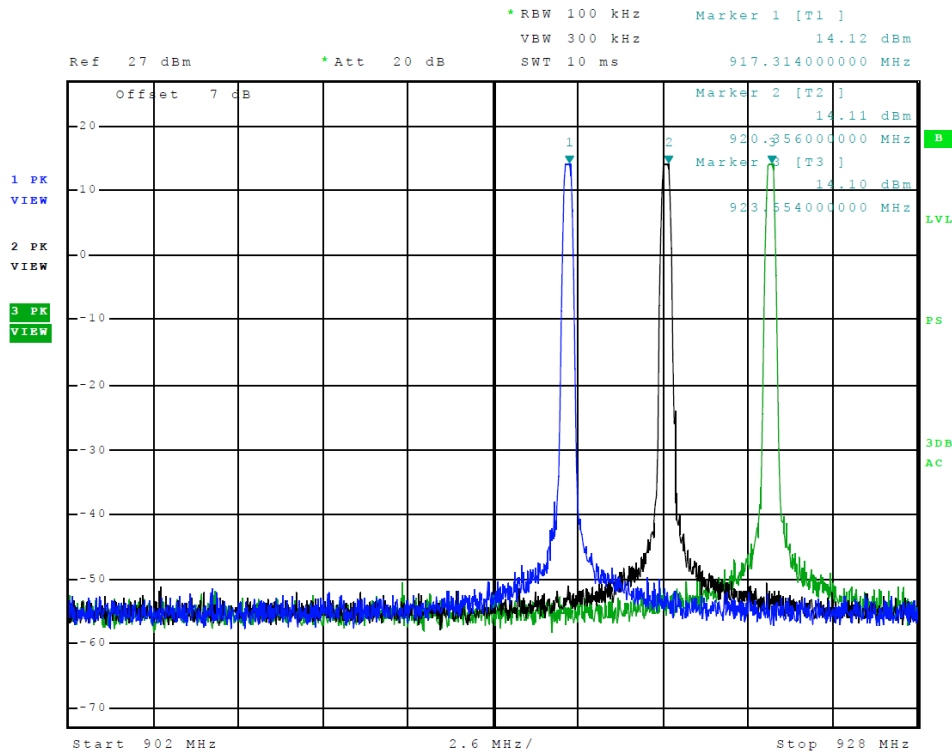

Figure 12 Plot of Transmitter Emissions in Operational Frequency Band (P-Mode)

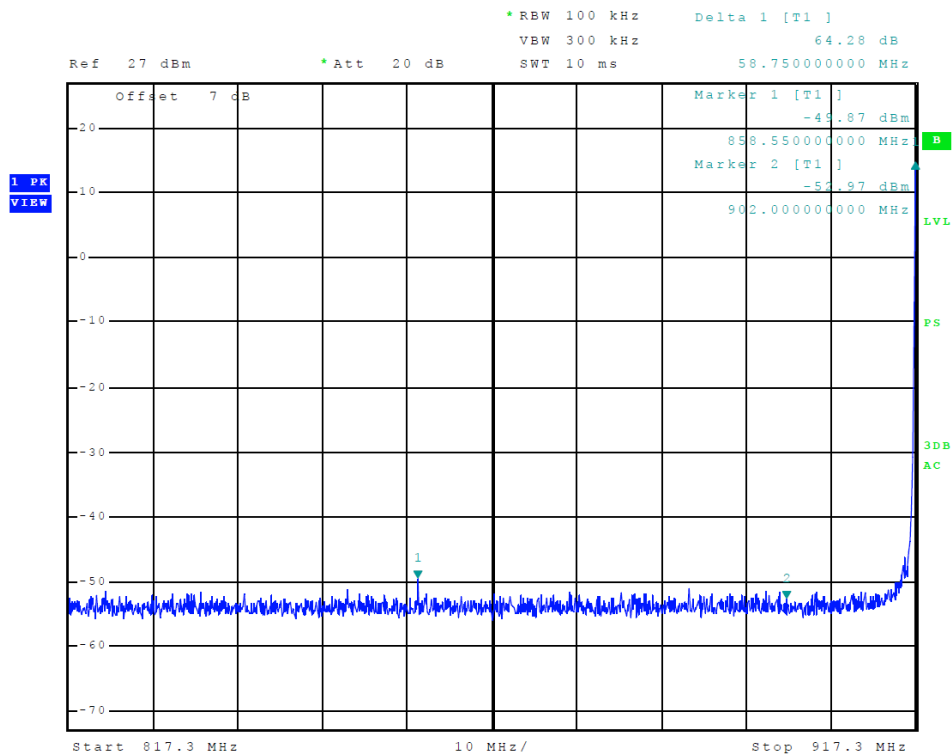

Figure 13 Plot of Lower Band Edge (P-mode)

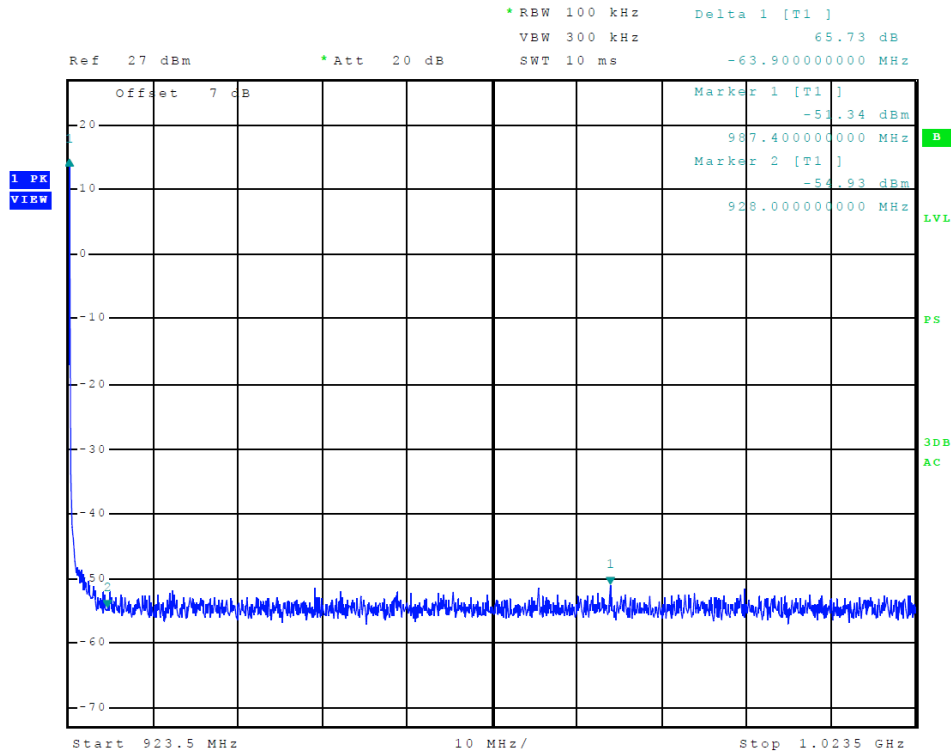

Figure 14 Plot of Upper Band Edge (P-mode)

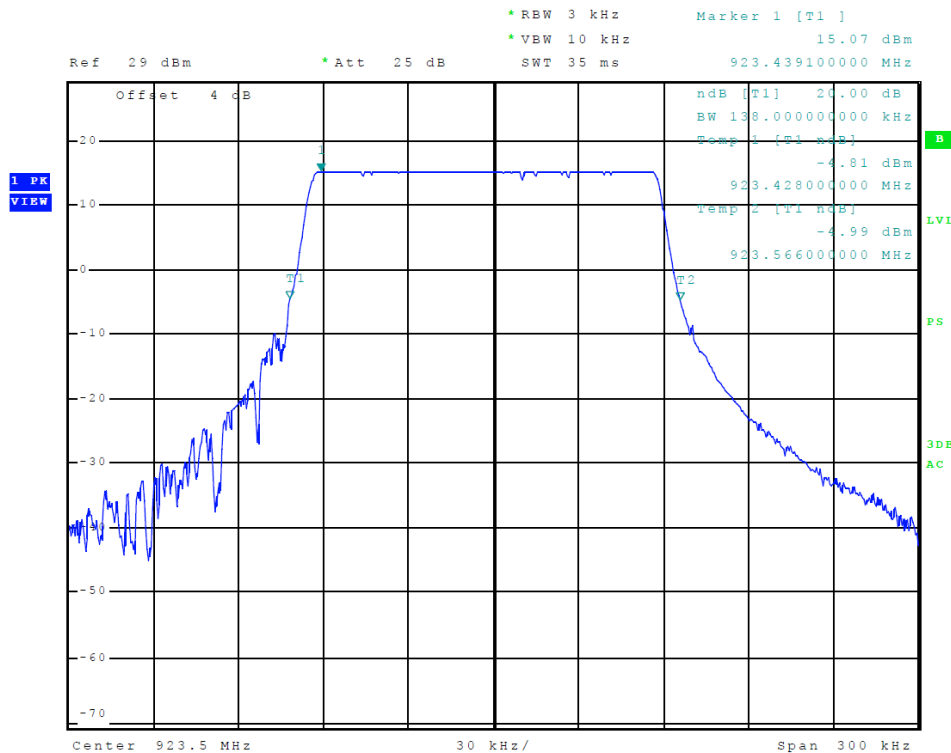

Figure 15 Plot of Transmitter 20-dB Occupied Bandwidth (P-mode)

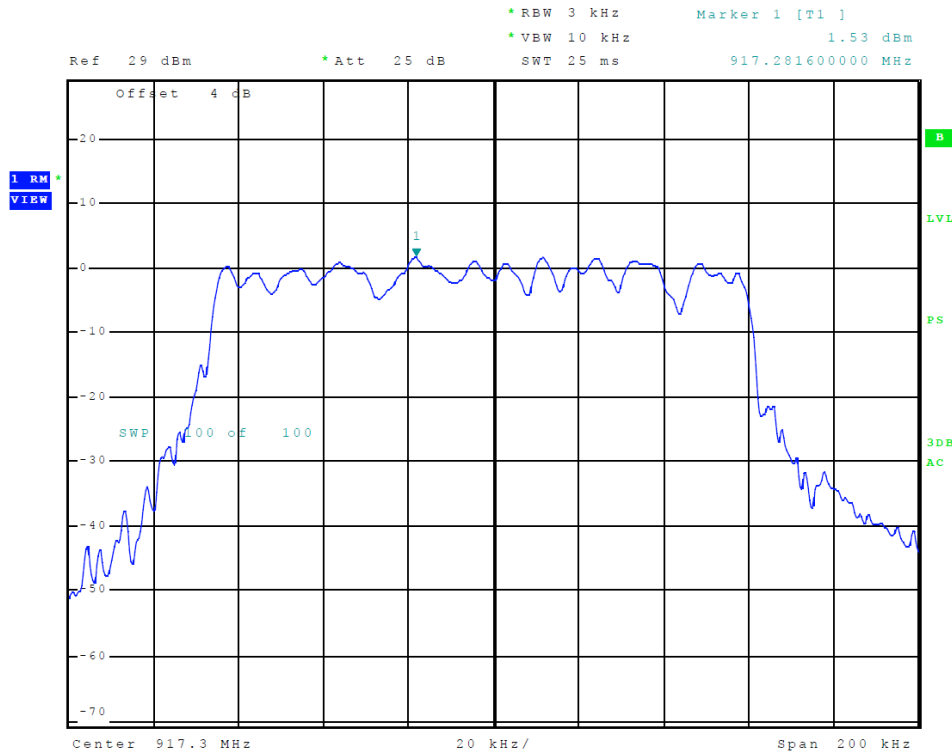

Figure 16 Plot of Power Spectral Density (P-Mode)

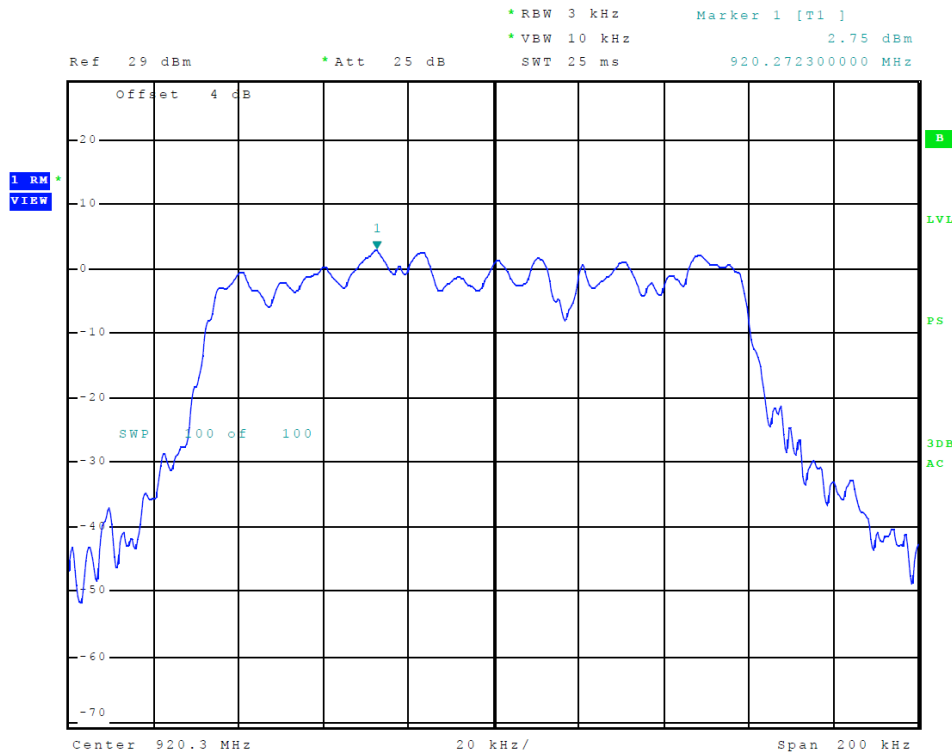

Figure 17 Plot of Power Spectral Density (P-Mode)

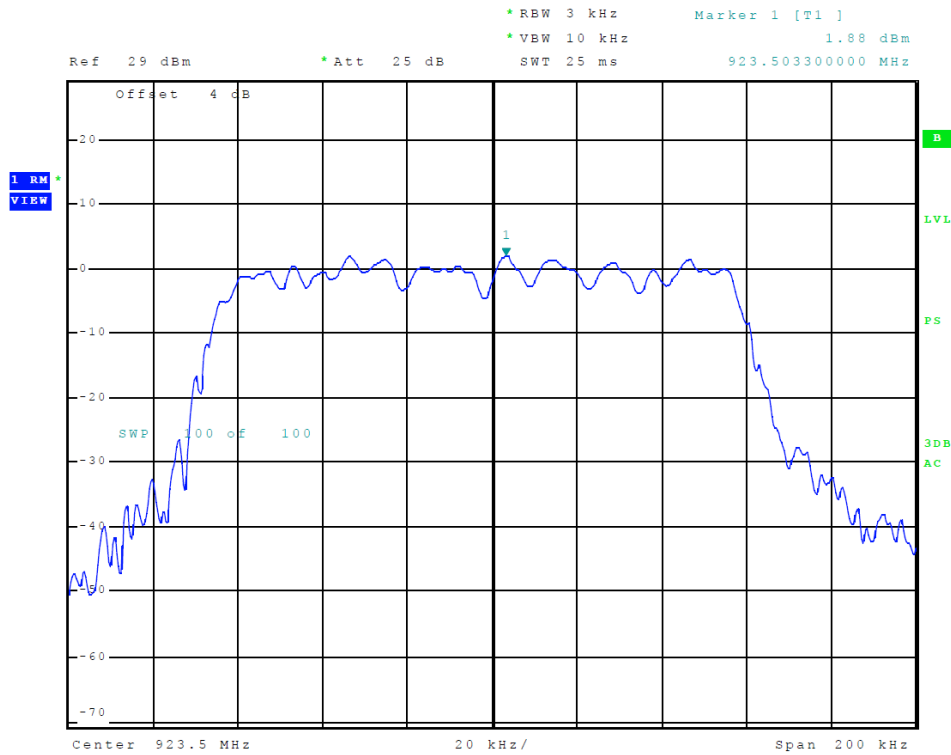

Figure 18 Plot of Power Spectral Density (P-Mode)

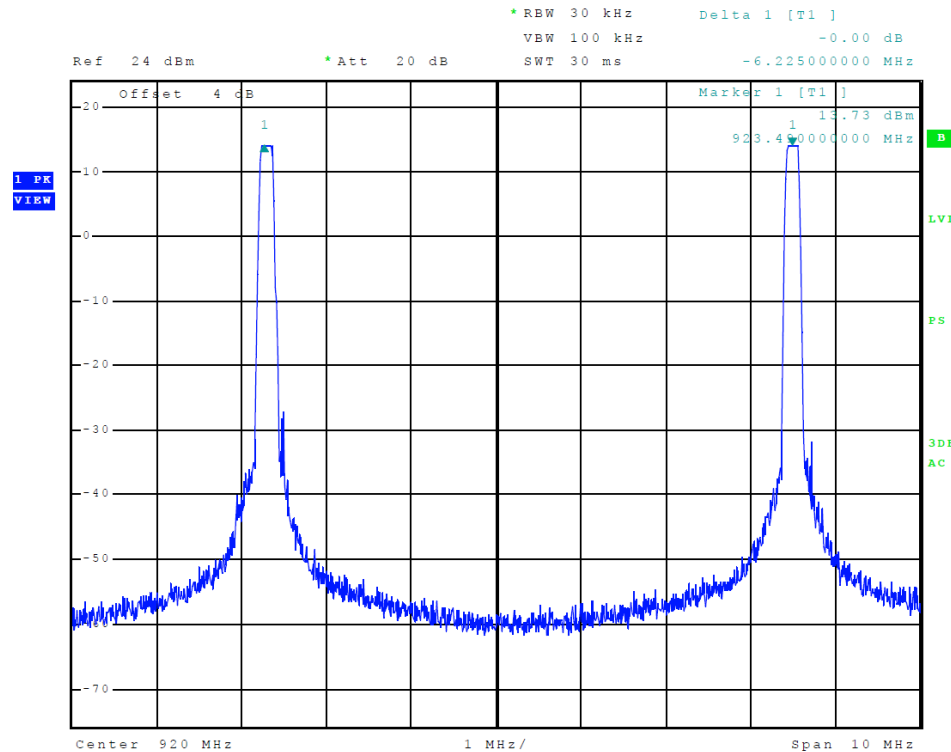

Figure 19 Plot of Channel Separation (P-mode)

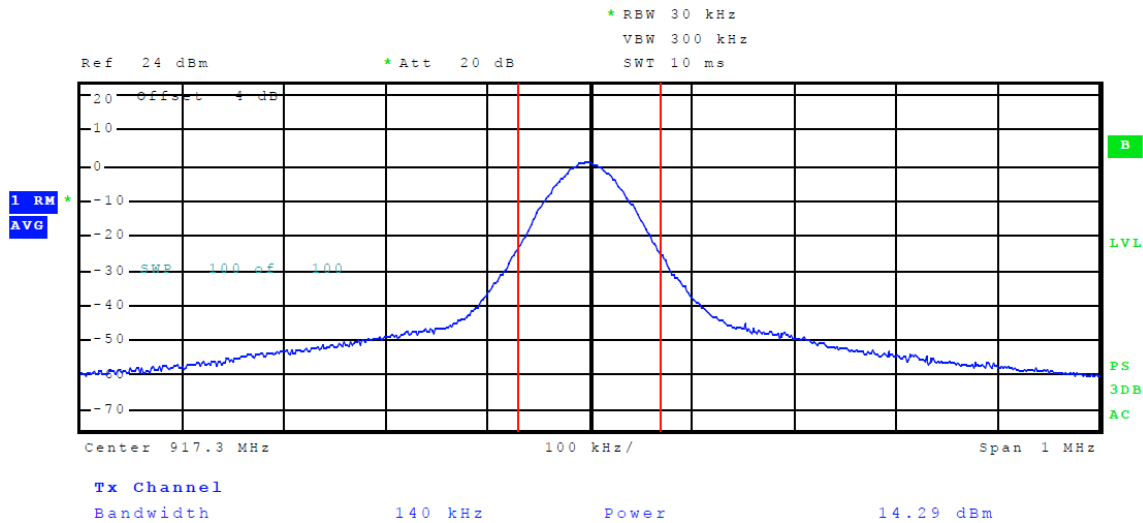

Figure 20 Plot of Output Power (P-Mode)

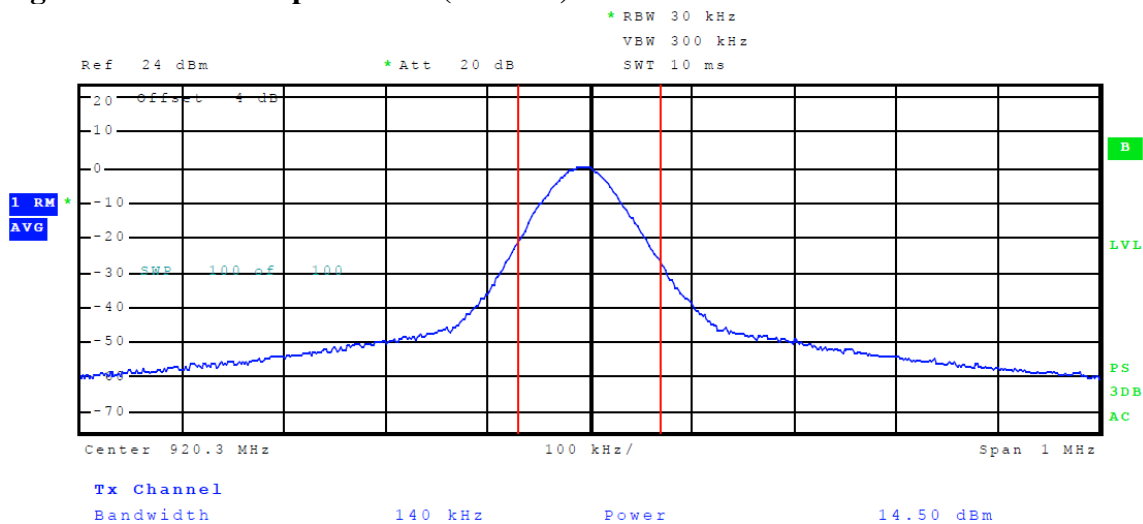

Figure 21 Plot of Output Power (P-Mode)

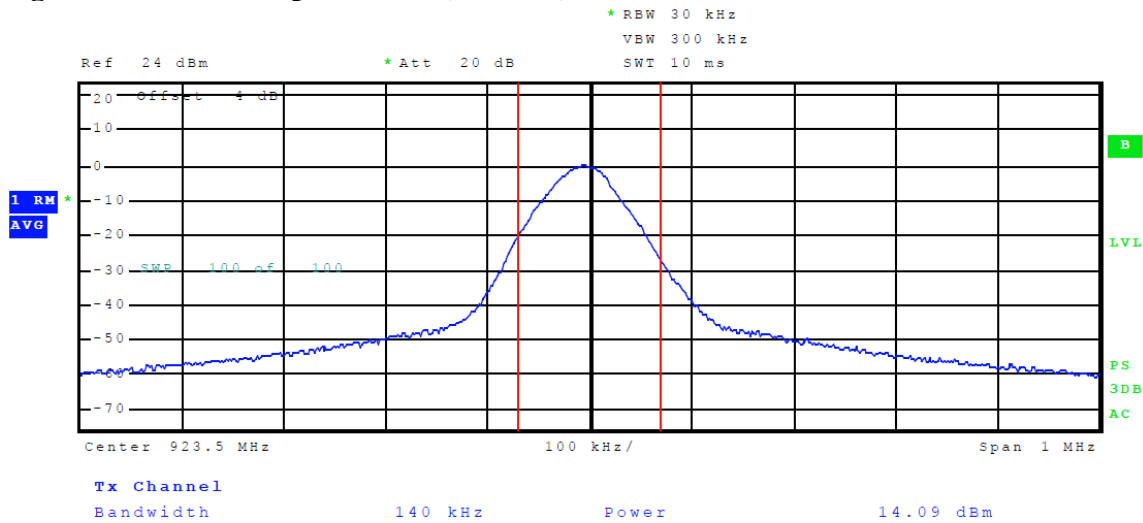

Figure 22 Plot of Output Power (P-Mode)

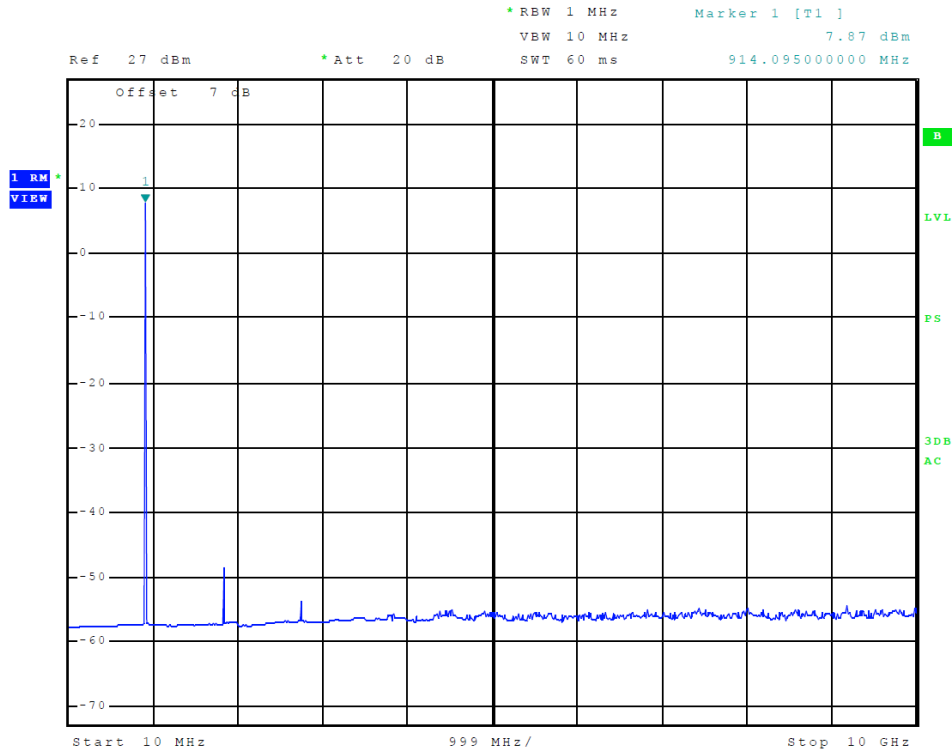

Figure 23 Plot of Out of Band Emissions

Transmitter Emissions Data

Table 4 Transmitter Radiated Emission M-mode Worst-case Data

Frequency in MHz	Horizontal Peak (dBµV/m)	Horizontal Average (dBµV/m)	Vertical Peak (dBµV/m)	Vertical Average (dBµV/m)	Limit @ 3m (dBµV/m)
917.60	--	--	--	--	--
1835.20	39.8	26.6	45.7	39.6	54.0
2752.80	44.3	32.9	45.3	34.4	54.0
3670.40	42.8	29.6	42.7	29.7	54.0
4588.00	43.4	30.4	43.2	30.5	54.0
5505.60	43.3	30.7	45.2	32.0	54.0
6423.20	45.1	32.0	45.8	32.3	54.0
920.00	--	--	--	--	--
1840.00	40.4	29.1	44.4	37.1	54.0
2760.00	44.8	32.9	44.8	33.5	54.0
3680.00	42.3	29.6	42.2	29.6	54.0
4600.00	45.9	31.9	45.0	32.0	54.0
5520.00	44.0	31.2	45.2	32.0	54.0
6440.00	45.6	32.5	45.4	32.5	54.0
922.40	--	--	--	--	--
1844.80	39.4	26.6	44.7	37.7	54.0
2767.20	43.7	32.4	44.3	33.8	54.0
3689.60	43.6	30.5	43.1	30.5	54.0
4612.00	44.0	31.4	44.3	31.5	54.0
5534.40	44.0	30.5	44.4	31.4	54.0
6456.80	46.2	32.8	46.1	32.7	54.0

Other emissions present had amplitudes at least 20 dB below the limit. Peak and Quasi-Peak amplitude emissions are recorded for frequency below 1000 MHz. Peak and Average amplitude emissions are recorded for frequency range above 1000 MHz.

Table 5 Transmitter Radiated Emission P-mode Worst-case Data

Frequency in MHz	Horizontal Peak (dB μ V/m)	Horizontal Average (dB μ V/m)	Vertical Peak (dB μ V/m)	Vertical Average (dB μ V/m)	Limit @ 3m (dB μ V/m)
917.30	--	--	--	--	--
1834.60	42.6	34.4	43.7	37.2	54.0
2751.90	44.6	35.5	46.8	38.6	54.0
3669.20	42.7	29.8	42.1	29.7	54.0
4586.50	43.1	30.7	43.3	30.7	54.0
5503.80	44.6	31.5	44.4	31.6	54.0
6421.10	45.1	32.1	43.0	30.5	54.0
920.30	--	--	--	--	--
1840.60	42.3	33.2	43.3	36.4	54.0
2760.90	44.4	34.9	45.6	38.2	54.0
3681.20	42.6	29.8	42.2	29.7	54.0
4601.50	44.6	32.1	45.0	31.9	54.0
5521.80	44.9	32.5	44.8	32.2	54.0
6442.10	45.7	32.7	43.4	31.1	54.0
923.50	--	--	--	--	--
1847.00	41.5	32.0	43.7	37.1	54.0
2770.50	44.5	34.9	46.7	39.8	54.0
3694.00	44.1	31.2	44.2	31.1	54.0
4617.50	44.2	30.9	43.2	30.8	54.0
5541.00	43.6	31.0	43.8	31.0	54.0
6464.50	45.9	32.8	44.1	31.5	54.0

Other emissions present had amplitudes at least 20 dB below the limit. Peak and Quasi-Peak amplitude emissions are recorded for frequency below 1000 MHz. Peak and Average amplitude emissions are recorded for frequency range above 1000 MHz.

Table 6 Transmitter Antenna Port Data

Frequency MHz	Antenna Port Output Power (Watts)	99% Occupied Bandwidth (kHz)	20-dB Occupied Bandwidth (kHz)	6-dB Occupied Bandwidth (kHz)	Peak Power Spectral Density (dBm/3kHz)
M-mode					
917.6	0.029	654.0	N/A	721.5	-3.30
920.0	0.028	670.5	N/A	738.0	-3.57
922.4	0.025	669.0	N/A	748.5	-3.51
P-mode					
917.3	0.027	129.5	138.0	N/A	1.53
920.3	0.028	129.5	136.8	N/A	2.75
923.5	0.026	129.5	138.0	N/A	1.88

Summary of Results for Transmitter Radiated Emissions of Intentional Radiator

The EUT demonstrated compliance with the radiated emissions requirements of CFR47 Part 15.247, RSS-GEN, and RSS-247 Hybrid Digital Transmission Systems. Antenna port conducted output power of 0.029 Watts was measured at the temporary antenna port of the EUT. The power spectral density measured at the antenna port presented a minimum margin of -5.2 dB below the requirements. The EUT demonstrated a minimum margin of -14.2 dB below the harmonic emissions requirements. There were no other significantly measurable emissions in the restricted bands other than those recorded in this report. Other emissions were present with amplitudes at least 20 dB below the requirements. There were no other deviations or exceptions to the requirements.

Annex

- Annex A Measurement Uncertainty Calculations
- Annex B Rogers Labs Test Equipment List
- Annex C Rogers Qualifications
- Annex D Rogers Labs Certificate of Accreditation

Annex A Measurement Uncertainty Calculations

Measurement uncertainty calculations were made for the laboratory. Result of measurement uncertainty calculations are recorded below for AC line conducted and radiated emission measurements.

Measurement Uncertainty	$U_{(E)}$	$U_{(lab)}$
3 Meter Horizontal 30-200 MHz Measurements	2.08	4.16
3 Meter Vertical 30-200 MHz Measurements	2.16	4.33
3 Meter Vertical Measurements 200-1000 MHz	2.99	5.97
10 Meter Horizontal Measurements 30-200 MHz	2.07	4.15
10 Meter Vertical Measurements 30-200 MHz	2.06	4.13
10 Meter Horizontal Measurements 200-1000 MHz	2.32	4.64
10 Meter Vertical Measurements 200-1000 MHz	2.33	4.66
3 Meter Measurements 1-6 GHz	2.57	5.14
3 Meter Measurements 6-18 GHz	2.58	5.16
AC Line Conducted	1.72	3.43

Annex B Rogers Labs Test Equipment List

List of Test Equipment	Calibration	Date	Due
Spectrum Analyzer: Rohde & Schwarz ESU40		5/17	5/18
Spectrum Analyzer: HP 8562A, HP Adapters: 11518, 11519, and 11520		5/17	5/18
Mixers: 11517A, 11970A, 11970K, 11970U, 11970V, 11970W			
Spectrum Analyzer: HP 8591EM		5/17	5/18
Antenna: EMCO Biconilog Model: 3143		5/17	5/18
Antenna: Sunol Biconilog Model: JB6		10/17	10/18
Antenna: EMCO Log Periodic Model: 3147		10/17	10/18
Antenna: Com Power Model: AH-118		10/17	10/18
Antenna: Com Power Model: AH-840		5/17	5/18
Antenna: Antenna Research Biconical Model: BCD 235		10/17	10/18
Antenna: Com Power Model: AL-130		10/17	10/18
Antenna: EMCO 6509		10/17	10/18
LISN: Compliance Design Model: FCC-LISN-2.Mod.cd, 50 µHy/50 ohms/0.1 µf		10/17	10/18
R.F. Preamp CPPA-102		10/17	10/18
Attenuator: HP Model: HP11509A		10/17	10/18
Attenuator: Mini Circuits Model: CAT-3		10/17	10/18
Attenuator: Mini Circuits Model: CAT-3		10/17	10/18
Cable: Belden RG-58 (L1)		10/17	10/18
Cable: Belden RG-58 (L2)		10/17	10/18
Cable: Belden 8268 (L3)		10/17	10/18
Cable: Time Microwave: 4M-750HF290-750		10/17	10/18
Cable: Time Microwave: 10M-750HF290-750		10/17	10/18
Frequency Counter: Leader LDC825		2/17	2/18
Oscilloscope Scope: Tektronix 2230		2/17	2/18
Wattmeter: Bird 43 with Load Bird 8085		2/17	2/18
Power Supplies: Sorensen SRL 20-25, SRL 40-25, DCR 150, DCR 140		2/17	2/18
R.F. Generators: HP 606A, HP 8614A, HP 8640B		2/17	2/18
R.F. Power Amp 65W Model: 470-A-1010		2/17	2/18
R.F. Power Amp 50W M185- 10-501		2/17	2/18
R.F. Power Amp A.R. Model: 10W 1010M7		2/17	2/18
R.F. Power Amp EIN Model: A301		2/17	2/18
LISN: Compliance Eng. Model 240/20		2/17	2/18
LISN: Fischer Custom Communications Model: FCC-LISN-50-16-2-08		2/17	2/18
Antenna: EMCO Dipole Set 3121C		2/17	2/18
Antenna: C.D. B-101		2/17	2/18
Antenna: Solar 9229-1 & 9230-1		2/17	2/18
Audio Oscillator: H.P. 201CD		2/17	2/18
ESD Test Set 2010i		2/17	2/18
Fast Transient Burst Generator Model: EFT/B-101		2/17	2/18
Field Intensity Meter: EFM-018		2/17	2/18
KEYTEK Ecat Surge Generator		2/17	2/18
Shielded Room 5 M x 3 M x 3.0 M			

Annex C Rogers Qualifications

Scot D. Rogers, Engineer

Rogers Labs, Inc.

Mr. Rogers has approximately 17 years' experience in the field of electronics. Engineering experience includes six years in the automated controls industry and remaining years working with the design, development and testing of radio communications and electronic equipment.

Positions Held

Systems Engineer: A/C Controls Mfg. Co., Inc. 6 Years

Electrical Engineer: Rogers Consulting Labs, Inc. 5 Years

Electrical Engineer: Rogers Labs, Inc. Current

Educational Background

- 1) Bachelor of Science Degree in Electrical Engineering from Kansas State University.
- 2) Bachelor of Science Degree in Business Administration Kansas State University.
- 3) Several Specialized Training courses and seminars pertaining to Microprocessors and Software programming.

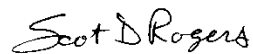

Scot D. Rogers

Annex D Rogers Labs Certificate of Accreditation

<p>United States Department of Commerce National Institute of Standards and Technology</p>  <hr/> <p>Certificate of Accreditation to ISO/IEC 17025:2005</p> <hr/> <p>NVLAP LAB CODE: 200087-0</p> <p>Rogers Labs, Inc. Louisburg, KS</p> <p><i>is accredited by the National Voluntary Laboratory Accreditation Program for specific services, listed on the Scope of Accreditation, for:</i></p> <p>Electromagnetic Compatibility & Telecommunications</p> <p><i>This laboratory is accredited in accordance with the recognized International Standard ISO/IEC 17025:2005. This accreditation demonstrates technical competence for a defined scope and the operation of a laboratory quality management system (refer to joint ISO-ILAC-IAF Communique dated January 2009).</i></p> <hr/> <table border="0" style="width: 100%;"><tr><td style="width: 33%; text-align: center;"><p>2017-03-01 through 2018-03-31 <i>Effective Dates</i></p></td><td style="width: 33%; text-align: center;"></td><td style="width: 33%; text-align: center;"> <i>For the National Voluntary Laboratory Accreditation Program</i></td></tr></table>			<p>2017-03-01 through 2018-03-31 <i>Effective Dates</i></p>		 <i>For the National Voluntary Laboratory Accreditation Program</i>
<p>2017-03-01 through 2018-03-31 <i>Effective Dates</i></p>		 <i>For the National Voluntary Laboratory Accreditation Program</i>			

Rogers Labs, Inc.
4405 W. 259th Terrace
Louisburg, KS 66053
Phone/Fax: (913) 837-3214
Revision 1

SAF Tehnika AS
Test #: 171106B
Test to: CFR47 15C, RSS-Gen RSS-247
File: SAF ARANETCO2 DTS TstRpt 171106B

S/N's: 00001, 2, 3, 4 and 5
FCC ID: W9Z-ARANETCO2
IC: 8855A- ARANETCO2
Date: February 1, 2018
Page 40 of 40