

ROGERS LABS, INC.

4405 West 259th Terrace
Louisburg, KS 66053
Phone / Fax (913) 837-3214

Application For Grant of Certification

FOR

Model: TDSPC0U3 (Aranet 4)
902-928 MHz (DTS)
Hybrid Digital Transmission System
FCC ID: W9Z-ARANET4
IC: 8855A-ARANET4

SAF Tehnika AS

24a, Ganibu dambis
Riga Latvia LV-1005

FCC Designation: US5305
IC Test Site Registration: 3041A-1

Test Report Number: 190530

Authorized Signatory: *Scot D Rogers*
Scot D. Rogers

Engineering Test Report For Grant of Certification Application

CFR 47, PART 15C - Intentional Radiators
CFR 47 Paragraph 15.247 and
Industry Canada RSS-GEN and RSS-247
License Exempt Intentional Radiator

For

SAF Tehnika AS

24a, Ganību dambis
Rīga Latvia LV-1005

Hybrid Digital Transmission System
Model: TDSPC0U3 (Aranet 4)

Frequency Range 902-928 MHz
FCC ID: W9Z-ARANET4
IC: 8855A-ARANET4

Test Date: May 30, 2019

Certifying Engineer: *Scot D. Rogers*
Scot D. Rogers
Rogers Labs, Inc.
4405 West 259th Terrace
Louisburg, KS 66053
Telephone/Facsimile: (913) 837-3214

This report shall not be reproduced except in full, without the written approval of the laboratory.
This report must not be used by the client to claim product certification, approval, or
endorsement by NVLAP, NIST, any Federal agency or the U.S. Government.

Table of Contents

TABLE OF CONTENTS.....	3
REVISIONS.....	5
FOREWORD.....	6
OPINION / INTERPRETATION OF RESULTS	6
EQUIPMENT TESTED.....	6
Equipment Function	7
Equipment Operations.....	8
Equipment Configuration.....	8
APPLICATION FOR CERTIFICATION.....	9
APPLICABLE STANDARDS & TEST PROCEDURES	10
TESTING PROCEDURES	11
AC Line Conducted Emission Test Procedure	11
Radiated Emission Test Procedure.....	11
Antenna-Port Conducted Emission Test Procedure	11
Diagram 1 Test arrangement for radiated emissions of tabletop equipment.....	12
Diagram 2 Test arrangement for radiated emissions tested on Open Area Test Site (OATS).....	13
Diagram 3 Test arrangement for Antenna Port Conducted emissions	14
TEST SITE LOCATIONS	14
LIST OF TEST EQUIPMENT	15
UNITS OF MEASUREMENTS	16
ENVIRONMENTAL CONDITIONS.....	16
STATEMENT OF MODIFICATIONS AND DEVIATIONS	16
INTENTIONAL RADIATORS.....	16

Antenna Requirements16

Restricted Bands of Operation.....17

Table 1 Harmonic Radiated Emissions in Restricted (Worst-case).....17

Summary of Results for Radiated Emissions in Restricted Bands18

AC Line Conducted Emissions Procedure18

General Radiated Emissions Procedure.....18

Table 2 General Radiated Emissions Data19

Summary of Results for General Radiated Emissions19

Operation in the Band 902-928 MHz.....19

Figure 1 Plot of Transmitter Emissions in Operational Frequency Band (Pairing)22

Figure 2 Plot of Transmitter 6-dB Occupied Bandwidth (Pairing).....23

Figure 3 Plot of Transmitter 99% Occupied Bandwidth (Pairing)24

Figure 4 Plot of Power Spectral Density (Pairing)25

Figure 5 Plot of Transmitter Emissions in Operational Frequency Band (P-Mode).....26

Figure 6 Plot of Lower Band Edge (P-mode).....27

Figure 7 Plot of Upper Band Edge (P-mode).....28

Figure 8 Plot of Transmitter 20-dB Occupied Bandwidth (P-mode).....29

Figure 9 Plot of Power Spectral Density (P-Mode).....30

Figure 10 Plot of Power Spectral Density (P-Mode).....31

Figure 11 Plot of Power Spectral Density (P-Mode).....32

Figure 12 Plot of Channel Separation (P-mode).....33

Figure 13 Plot of Output Power (P-Mode)34

Figure 14 Plot of Output Power (P-Mode)34

Figure 15 Plot of Output Power (P-Mode)35

Figure 16 Plot of Out of Band Emissions35

Transmitter Emissions Data.....36

Table 3 Transmitter Radiated Emission Worst-case Data36

Table 4 Transmitter Antenna Port Data37

Summary of Results for Transmitter Radiated Emissions of Intentional Radiator37

ANNEX..... 38

Annex A Measurement Uncertainty Calculations.....39

Annex B Additional Test Equipment List40

Annex C Rogers Qualifications41

Annex D Laboratory Certificate of Accreditation.....42

Revisions

Revision 2 Issued August 27, 2019 – corrected obw plot 24, page added modulation information page 21, software version and power settings page 6

Revision 1 Issued August 12, 2019

Foreword

The following information is submitted for consideration in obtaining Grant of Certification for License Exempt Hybrid Digital Transmission System Intentional Radiator operating under Code of Federal Regulations Title 47 (CFR 47) Paragraph 15.247 and Industry Canada RSS-GEN, Issue 5 and RSS-247 Issue 2, operation in the 902-928 MHz band.

Name of Applicant: SAF Tehnika AS
24a, Ganibu dambis
Riga Latvia LV-1005
M/N: TDSPC0U3 PMN: Aranet 4
FCC ID: W9Z-ARANET4 IC: 8855A-ARANET4
Frequency Range: 917.3-923.5 MHz
P-Mode, Output Power 0.028 W, 20-dB Occupied bandwidth 138.0 kHz

Opinion / Interpretation of Results

Tests Performed	Margin (dB)	Results
Emissions 15.205, RSS-GEN	-21.2	Complies
Emissions as per CFR 47 paragraphs 2 and 15.207	N/A	Complies
Emissions as per CFR 47 paragraphs 2 and 15.209	-14.2	Complies
Harmonic Emissions per CFR 47 15.247	-21.2	Complies
Peak Power Spectral Density per CFR 47 15.247	-5.7	Complies

Equipment Tested

<u>Equipment</u>	<u>Model / PN</u>	<u>Serial Number</u>
EUT #1 (Radiated Production)	TDSPC0U3	306681 000007
EUT #2 (Radiated Tx)	TDSPC0U3	306681 000005
EUT #3 (Antenna port connector)	TDSPC0U3	306681 000006

Test results in this report relate only to the items tested.

Software version of “typical” Aranet 4 unit: d3ca4ebe9a049bb24dfec0715edc94c08f06bc70
version of “modified for testing” Aranet 4 unit: bcb11f4c0df6a5de3a1eccfaa74fd62713f8d909
Both “typical” and “modified for testing” Aranet 4 conducted output powers are: during pairing 0dBm, during data transmission +14dBm

Equipment Function

The EUT is a battery-operated mobile Carbon dioxide (CO₂) sensor incorporating 917.3-923.5 MHz Hybrid Digital Transmission System for wireless data transfer. The device incorporates several sensors including Carbon dioxide (CO₂), temperature, relative humidity and air pressure. The design prominently displays the CO₂ sensor which monitors the amount of CO₂ present in close proximity. The sensor data may be then broadcast to a paired remotely located base station. The transmitter operates in a hybrid mode employing a combination of both frequency hopping and digital modulation techniques. The design operates from two AA replaceable batteries only and offers no provision for alternate power source. The EUT incorporates an authorized transmitter module (FCC ID: 2AA9B04 and IC: 12208A-04) operating in the 2400-2483.5 MHz Band. Three test samples were provided for testing purposes samples 1 and 2 represented production manufactured product with integral antenna and sample 3 was modified replacing the integral antenna with a 50-ohm antenna port connector. Test samples 2 and 3 were also modified with the addition of a push button switch and test software to enable transmit operation on lowest, middle and highest operating channels. For testing purposes, each test sample received power from new replaceable AA batteries and configured to operate in available modes. The test software provided operation of the transmitter at 100% duty cycle for testing. Testing was performed with both transmitters active and verify emissions compliance for co-located transmitters. The equipment was tested for emissions compliance using the available configurations with the worst-case data presented. Test results in this report relate only to the products described in this report.

Equipment Operations

The Aranet products have distinct operation modes, which use the following radio frequency channels:

- Pairing mode utilized by all of the products (TX and RX) (P-mode)
 - 923.2 MHz @ 500 kHz

- Aranet Pro system mode utilized by sensors(TX) and Aranet Pro(RX) (P-mode)
 - 917.3 MHz; 922.9 MHz @ 125kHz
 - 917.5 MHz; 923.1 MHz @ 125kHz
 - 917.7 MHz; 923.3 MHz @ 125kHz
 - 917.9 MHz; 923.5 MHz @ 125kHz

Aranet Pro base stations choose their initial operational channel randomly when the device is first powered up.

Equipment Configuration

- 1) Unit operating from replaceable AA internal batteries

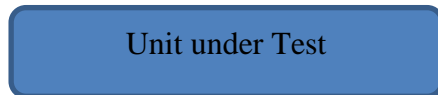

- 2) Antenna Port Modified Unit operating from replaceable AA internal batteries

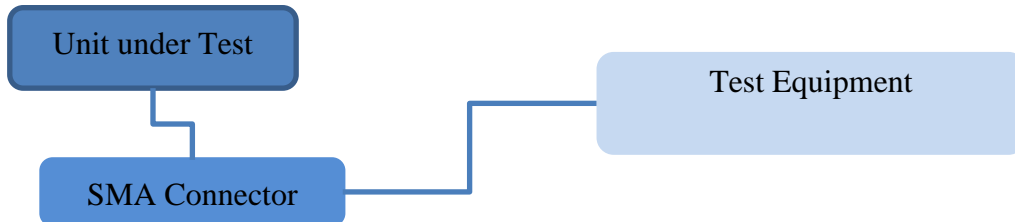

Application for Certification

- (1) Manufacturer: SAF Tehnika AS
24a, Ganibu dambis
Riga Latvia LV-1005
- (2) Identification: M/N: TDSPC0U3
FCC ID: W9Z-ARANET4 IC: 8855A-ARANET4
- (3) Instruction Book:
Refer to Exhibit for Instruction Manual.
- (4) Description of Circuit Functions:
Refer to Exhibit of Operational Description.
- (5) Block Diagram with Frequencies:
Refer to Exhibit of Operational Description.
- (6) Report of Measurements:
Report of measurements follows in this Report.
- (7) Photographs: Construction, Component Placement, etc.:
Refer to Exhibit for photographs of equipment.
- (8) List of Peripheral Equipment Necessary for operation. The equipment operates from replaceable AA batteries only and provides no other interface options as presented in this filing. The EUT offers no other connection ports than those presented in this filing.
- (9) Transition Provisions of CFR47 15.37 are not requested.
- (10) Not Applicable. The unit is not a scanning receiver.
- (11) Not Applicable. The EUT does not operate in the 59 – 64 GHz frequency band.
- (12) The equipment is not software defined and this section is not applicable.
- (13) Applications for certification of U-NII devices in the 5.15-5.35 GHz and the 5.47-5.85 GHz bands must include a high-level operational description of the security procedures that control the radio frequency operating parameters and ensure that unauthorized modifications cannot be made. This requirement is not applicable to his DTS device.
- (14) Contain at least one drawing or photograph showing the test set-up for each of the required types of tests applicable to the device for which certification is requested. These drawings or photographs must show enough detail to confirm other information contained in the test report. Any photographs used must be focused originals without glare or dark spots and must clearly show the test configuration used. This information is provided in this report and Test Setup Exhibits provided with the application filing.

Applicable Standards & Test Procedures

The following information is submitted in accordance with the eCFR Federal Communications Code of Federal Regulations, dated May 30, 2019, Part 2, Subpart J, Paragraphs 2.907, 2.911, 2.913, 2.925, 2.926, 2.1031 through 2.1057, and applicable parts of paragraph 15, Part 15C Paragraph 15.247, and Industry Canada RSS-247 Issue 2, and RSS-GEN Issue 5. This equipment operates as hybrid Digital Transmission System. Hybrid systems are those that employ a combination of both frequency hopping and digital modulation techniques. The frequency hopping operation of the hybrid system, with the direct sequence or digital modulation operation turned-off, provides an average time of occupancy on any frequency not exceeding 0.4 seconds within a time period in seconds equal to the number of hopping frequencies employed multiplied by 0.4. The power spectral density conducted from the intentional radiator to the antenna due to the digital modulation operation of the hybrid system, with the frequency hopping operation turned off, remains below the 8 dBm in any 3-kHz band during any time interval of continuous transmission. Test procedures used are as defined in 558074 D01 15.247 Meas Guidance v05r02 and ANSI C63.10-2013.

Testing Procedures

AC Line Conducted Emission Test Procedure

The design operates solely from direct current power provided from replaceable AAA battery. The design offers no provision connection with Utility AC power system and therefore is exempt from AC Line conducted emissions testing.

Radiated Emission Test Procedure

Radiated emissions testing was performed as required in CFR47 15, RSS-247 and specified in ANSI C63.10-2013. The EUT was placed on a rotating 0.9 x 1.2-meter platform, elevated as required above the ground plane at a distance of 3 meters from the FSM antenna. EMI energy was maximized by equipment placement permitting orientation in three orthogonal axes, raising and lowering the FSM antenna, changing the antenna polarization, and by rotating the turntable. Each emission was maximized before data was taken using a spectrum analyzer. The frequency spectrum from 9 kHz to 25,000 MHz was searched for during preliminary investigation. Refer to diagrams one and two showing typical test arrangement and photographs in the test setup exhibits for specific EUT placement during testing.

Antenna-Port Conducted Emission Test Procedure

The EUT was assembled as required for operation placed on a benchtop. This configuration provided the ability to connect test equipment to the provided test antenna port. Antenna Port conducted emissions testing was performed presented in the regulations and specified in ANSI C63.10-2013. Testing was completed on a laboratory bench in a shielded room. The active antenna port of the device was connected to appropriate attenuation and the spectrum analyzer. Refer to diagram three showing typical test arrangement and photographs in the test setup exhibits for specific EUT placement during testing.

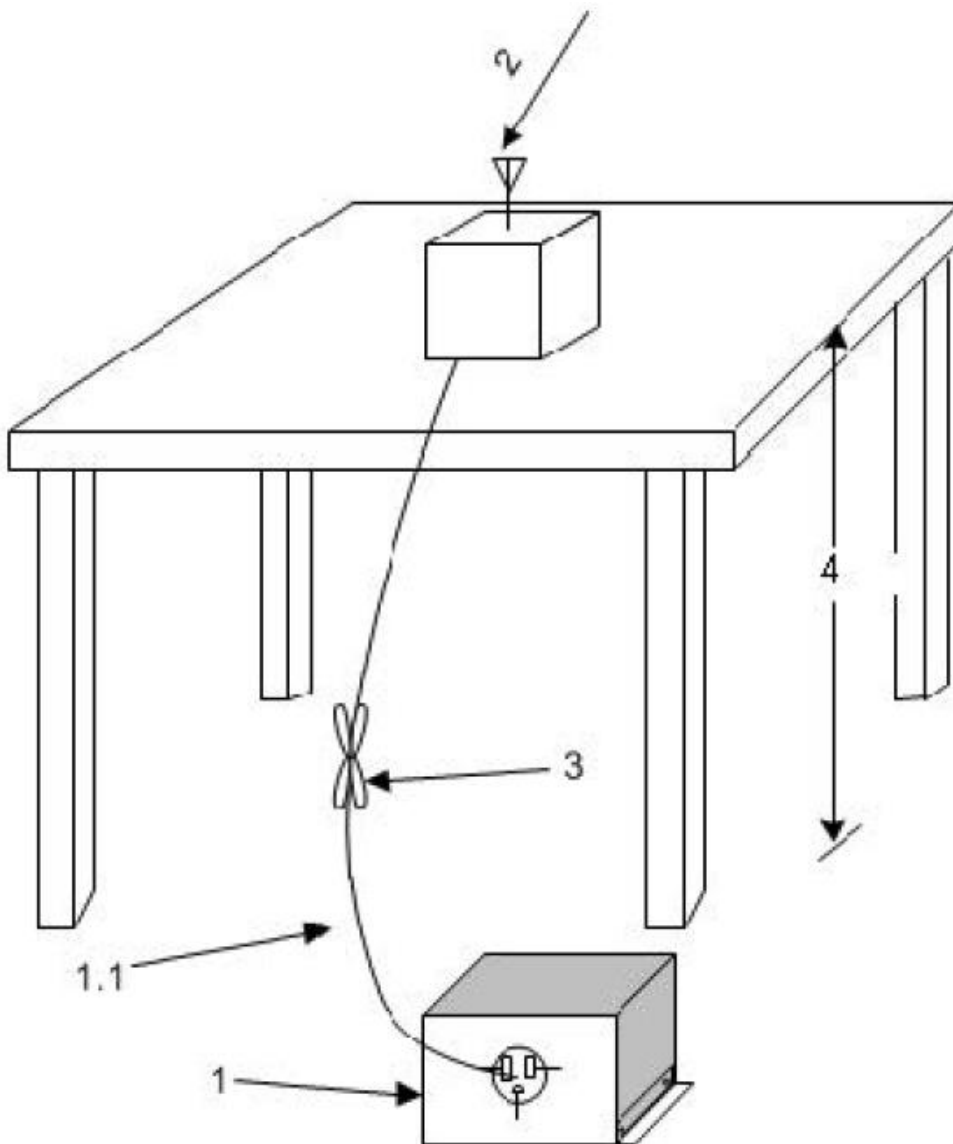

1. A LISN is optional for radiated measurements between 30 MHz and 1000 MHz but not allowed for measurements below 30 MHz and above 1000 MHz (see 6.3.1). If used, then connect EUT to one LISN. Unused LISN measuring port connectors shall be terminated in 50Ω loads. The LISN may be placed on top of, or immediately beneath, the reference ground plane (see 6.2.2 and 6.2.3.2).
 - 1.1—LISN spaced at least 80 cm from the nearest part of the EUT chassis.
2. Antenna can be integral or detachable, depending on the EUT (see 6.3.1).
3. Interconnecting cables that hang closer than 40 cm to the ground plane shall be folded back and forth in the center forming a bundle 30 cm to 40 cm long (see 6.3.1).
4. For emission measurements at or below 1 GHz, the table height shall be 80 cm. For emission measurements above 1 GHz, the table height shall be 1.5 m for measurements, except as otherwise specified (see 6.3.1 and 6.6.3.1).

Diagram 1 Test arrangement for radiated emissions of tabletop equipment

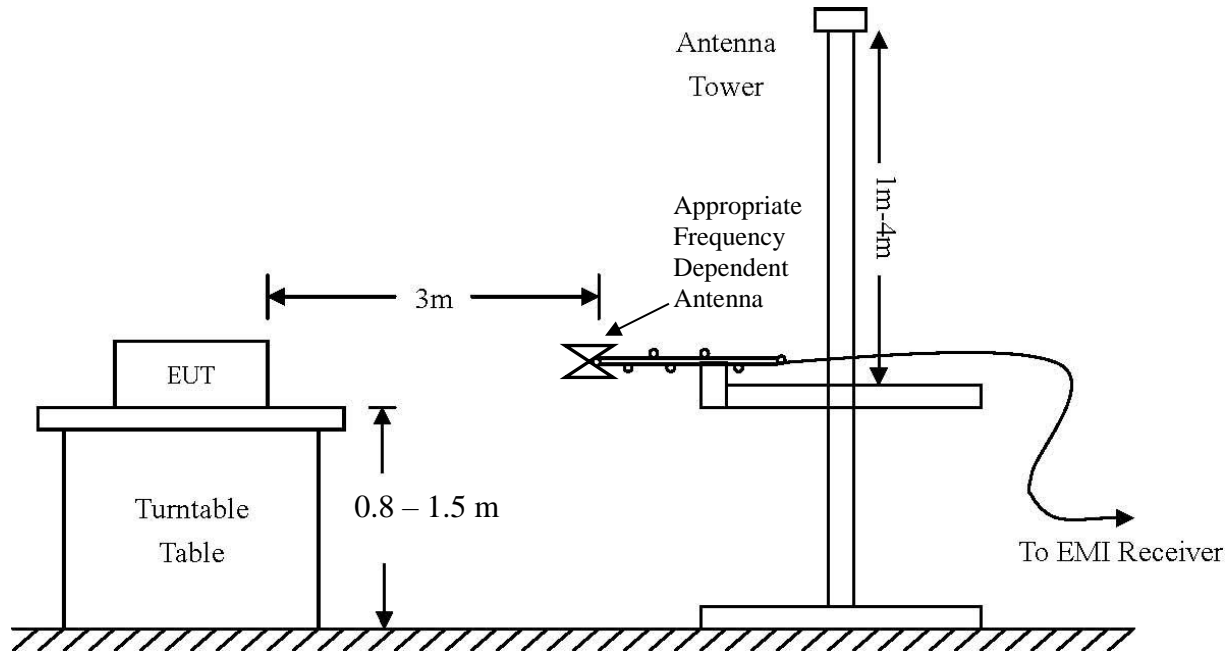

AC Line Conducted Emissions (0.150 -30 MHz)		
RBW	AVG. BW	Detector Function
9 kHz	30 kHz	Peak / Quasi Peak
Emissions (30-1000 MHz)		
RBW	AVG. BW	Detector Function
120 kHz	300 kHz	Peak / Quasi Peak
Emissions (Above 1000 MHz)		
RBW	Video BW	Detector Function
100 kHz	100 kHz	Peak
1 MHz	1 MHz	Peak / Average

Diagram 2 Test arrangement for radiated emissions tested on Open Area Test Site (OATS)

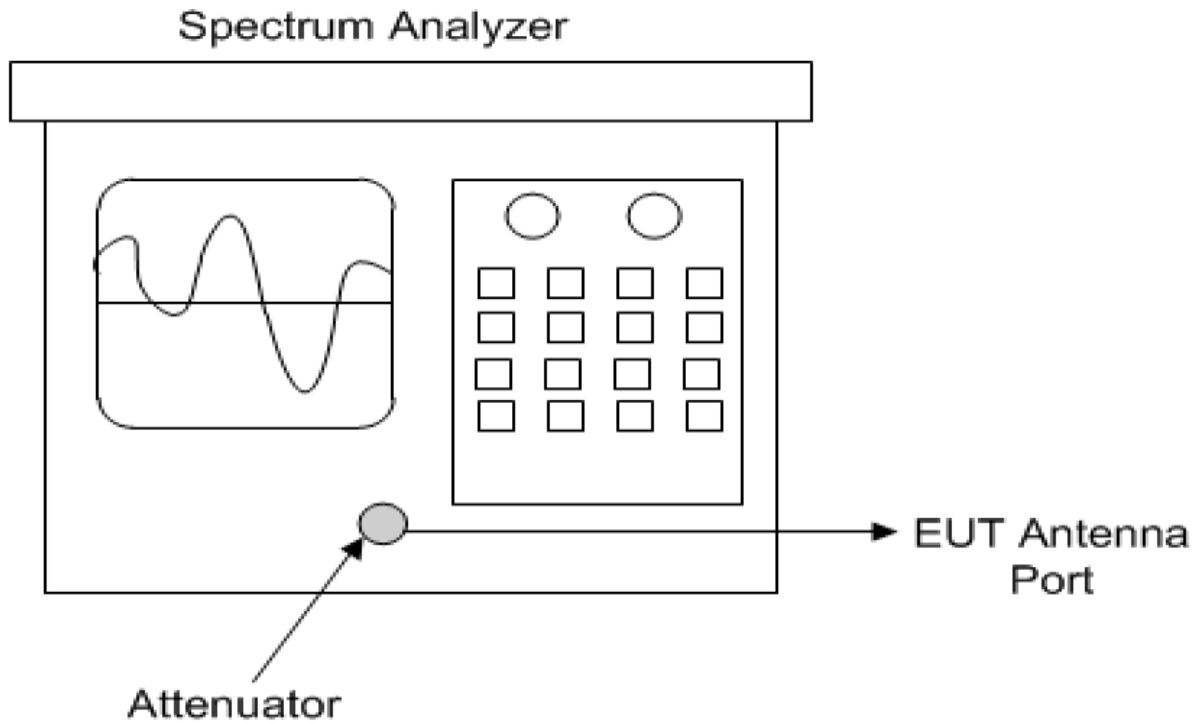

Diagram 3 Test arrangement for Antenna Port Conducted emissions

Test Site Locations

Conducted EMI: The AC power line conducted emissions testing performed in a shielded screen room located at Rogers Labs, Inc., 4405 West 259th Terrace, Louisburg, KS

Radiated EMI: The radiated emissions tests were performed at the 3 meters, Open Area Test Site (OATS) located at Rogers Labs, Inc., 4405 West 259th Terrace, Louisburg, KS

Registered Site information: FCC Site: US5305 and ISED #: 3041A, CAB Identifier: US0096

NVLAP Accreditation: Lab code 200087-0

List of Test Equipment

<u>Equipment</u>	<u>Manufacturer</u>	<u>Model (SN)</u>	<u>Band</u>	<u>Cal Date(m/d/y)</u>	<u>Due</u>
<input type="checkbox"/> LISN	FCC	FCC-LISN-50-25-10(1PA) (160611)	.15-30MHz	4/18/2019	4/18/2020
<input type="checkbox"/> LISN	Compliance Design	FCC-LISN-2.Mod.cd,(126)	.15-30MHz	10/16/2018	10/16/2019
<input checked="" type="checkbox"/> Cable	Huber & Suhner Inc.	Sucoflex102ea(L10M)(303073)	9kHz-40 GHz	10/16/2018	10/16/2019
<input checked="" type="checkbox"/> Cable	Huber & Suhner Inc.	Sucoflex102ea(1.5M)(303069)	9kHz-40 GHz	10/16/2018	10/16/2019
<input checked="" type="checkbox"/> Cable	Huber & Suhner Inc.	Sucoflex102ea(1.5M)(303071)	9kHz-40 GHz	10/16/2018	10/16/2019
<input type="checkbox"/> Cable	Belden	RG-58 (L1-CAT3-11509)	9kHz-30 MHz	10/16/2018	10/16/2019
<input type="checkbox"/> Cable	Belden	RG-58 (L2-CAT3-11509)	9kHz-30 MHz	10/16/2018	10/16/2019
<input type="checkbox"/> Antenna	ARA	BCD-235-B (169)	20-350MHz	10/16/2018	10/16/2019
<input type="checkbox"/> Antenna	EMCO	3147 (40582)	200-1000MHz	10/16/2018	10/16/2019
<input checked="" type="checkbox"/> Antenna	ETS-Lindgren	3117 (200389)	1-18 GHz	5/2/2018	5/2/2020
<input type="checkbox"/> Antenna	Com Power	AH-118 (10110)	1-18 GHz	10/16/2018	10/24/2019
<input type="checkbox"/> Antenna	Com Power	AH-840 (101046)	18-40 GHz	4/18/2019	4/18/2021
<input checked="" type="checkbox"/> Antenna	Com Power	AL-130 (121055)	.001-30 MHz	10/16/2018	10/16/2019
<input checked="" type="checkbox"/> Antenna	Sunol	JB-6 (A100709)	30-1000 MHz	10/16/2018	10/16/2019
<input checked="" type="checkbox"/> Analyzer	Rohde & Schwarz	ESU40 (100108)	20Hz-40GHz	4/18/2019	4/18/2020
<input checked="" type="checkbox"/> Analyzer	Rohde & Schwarz	ESW44 (101534)	20Hz-44GHz	1/31/2019	1/31/2020
<input type="checkbox"/> Analyzer	Rohde & Schwarz	FS-Z60, 90, 140, and 220	40GHz-220GHz	12/22/2017	12/22/2019
<input checked="" type="checkbox"/> Amplifier	Com-Power	PA-010 (171003)	100Hz-30MHz	10/16/2018	10/16/2019
<input checked="" type="checkbox"/> Amplifier	Com-Power	CPPA-102 (01254)	1-1000 MHz	10/16/2018	10/16/2019
<input checked="" type="checkbox"/> Amplifier	Com-Power	PAM-118A (551014)	0.5-18 GHz	10/16/2018	10/16/2019
<input type="checkbox"/> Amplifier	Com-Power	PAM-840A (461328)	18-40 GHz	10/16/2018	10/16/2019
<input checked="" type="checkbox"/> Power Meter	Agilent	N1911A with N1921A	0.05-40 GHz	4/18/2019	4/18/2020
<input type="checkbox"/> Generator	Rohde & Schwarz	SMB100A6 (100150)	20Hz-6 GHz	4/18/2019	4/18/2020
<input type="checkbox"/> Generator	Rohde & Schwarz	SMBV100A6 (260771)	20Hz-6 GHz	4/18/2019	4/18/2020
<input type="checkbox"/> RF Filter	Micro-Tronics	BRC50722 (009).9G notch	30-1800 MHz	4/18/2019	4/18/2020
<input type="checkbox"/> RF Filter	Micro-Tronics	HPM50114 (017)1.5G HPF	30-18000 MHz	4/18/2019	4/18/2020
<input type="checkbox"/> RF Filter	Micro-Tronics	HPM50117 (063) 3G HPF	30-18000 MHz	4/18/2019	4/18/2020
<input type="checkbox"/> RF Filter	Micro-Tronics	HPM50105 (059) 6G HPF	30-18000 MHz	4/18/2019	4/18/2020
<input type="checkbox"/> RF Filter	Micro-Tronics	BRM50702 (172) 2G notch	30-1800 MHz	4/18/2019	4/18/2020
<input type="checkbox"/> RF Filter	Micro-Tronics	BRC50703 (G102) 5G notch	30-1800 MHz	4/18/2019	4/18/2020
<input type="checkbox"/> RF Filter	Micro-Tronics	BRC50705 (024) 5G notch	30-1800 MHz	4/18/2019	4/18/2020
<input type="checkbox"/> Attenuator	Fairview	SA6NFNF100W-14 (1625)	30-1800 MHz	4/18/2019	4/18/2020
<input checked="" type="checkbox"/> Attenuator	Mini-Circuits	VAT-3W2+ (1436)	30-6000 MHz	4/18/2019	4/18/2020
<input type="checkbox"/> Attenuator	Mini-Circuits	VAT-3W2+ (1445)	30-6000 MHz	4/18/2019	4/18/2020
<input type="checkbox"/> Attenuator	Mini-Circuits	VAT-6W2+ (1438)	30-6000 MHz	4/18/2019	4/18/2020
<input type="checkbox"/> Attenuator	Mini-Circuits	VAT-6W2+ (1736)	30-6000 MHz	4/18/2019	4/18/2020
<input checked="" type="checkbox"/> Weather station	Davis	6312 (A81120N075)		10/26/2018	10/26/2019

Units of Measurements

Conducted EMI Data is in dB μ V; dB referenced to one microvolt

Radiated EMI Data is in dB μ V/m; dB/m referenced to one microvolt per meter

Sample Calculation:

RFS = Radiated Field Strength, FSM = Field Strength Measured

A.F. = Receive antenna factor, Gain = amplification gains and/or cable losses

RFS (dB μ V/m @ 3m) = FSM (dB μ V) + A.F. (dB) - Gain (dB)

Environmental Conditions

Ambient Temperature 23.8° C

Relative Humidity 49%

Atmospheric Pressure 1007.9 mb

Statement of Modifications and Deviations

No modifications to the EUT were required for the unit to demonstrate compliance with the CFR47 Part 15C, RSS-Gen, and RSS-247 emission requirements. There were no deviations to the specifications.

Intentional Radiators

The following information is submitted in support demonstration of compliance with the requirements of CFR47, Subpart C, paragraph 15.247 and Industry Canada RSS-247 and RSS-Gen the following information is submitted.

Antenna Requirements

The EUT incorporates integral antenna system and offers no provision for connection to alternate antenna system. The antenna connection point complies with the unique antenna connection requirements. There are no deviations or exceptions to the specification.

Restricted Bands of Operation

Spurious emissions falling in the restricted frequency bands of operation were measured at the OATS. The EUT utilizes frequency, determining circuitry, which generates harmonics falling in the restricted bands. Emissions were investigated at the OATS, using appropriate antennas or pyramidal horns, amplification stages, and a spectrum analyzer. Peak and average amplitudes of frequencies above 1000 MHz were compared to the required limits with worst-case data presented below. Test procedures of ANSI C63.10-2013 paragraph 6 and KDB 558074 were used during testing. No other significant emissions were observed which fell into the restricted bands of operation. Computed emission values consider the received radiated field strength, receive antenna correction factor, amplifier gain stage, and test system cable losses.

Table 1 Harmonic Radiated Emissions in Restricted (Worst-case)

Frequency in MHz	Horizontal Peak (dB μ V/m)	Horizontal Quasi-Peak (dB μ V/m)	Horizontal Average (dB μ V/m)	Vertical Peak (dB μ V/m)	Vertical Quasi-Peak (dB μ V/m)	Vertical Average (dB μ V/m)	Limit @ 3m (dB μ V/m)
2751.9	58.0	N/A	32.3	56.7	N/A	30.4	54.0
2760.9	58.6	N/A	32.8	58.0	N/A	32.1	54.0
2770.5	58.5	N/A	32.7	58.0	N/A	31.7	54.0
2769.6	51.5	N/A	18.7	49.1	N/A	14.0	54.0
3669.2	49.5	N/A	13.9	49.6	N/A	13.7	54.0
3681.2	50.4	N/A	14.1	50.0	N/A	13.9	54.0
3694.0	49.4	N/A	13.7	50.1	N/A	13.7	54.0
3692.8	49.9	N/A	13.8	49.4	N/A	13.8	54.0
4586.5	48.7	N/A	12.8	48.9	N/A	12.8	54.0
4601.5	48.3	N/A	12.7	48.8	N/A	12.7	54.0
4617.5	48.9	N/A	13.2	49.2	N/A	13.2	54.0
4616.0	49.0	N/A	13.1	48.9	N/A	13.1	54.0

Other emissions present had amplitudes at least 20 dB below the limit. Peak and Quasi-Peak amplitude emissions are recorded for frequency below 1000 MHz. Peak and Average amplitude emissions are recorded for frequency range above 1000 MHz.

Summary of Results for Radiated Emissions in Restricted Bands

The EUT demonstrated compliance with the radiated emissions requirements of CFR 47 Part 15C RSS-Gen, and RSS-247 Intentional Radiators. The EUT demonstrated a worst-case minimum radiated emission in restricted bands providing a minimum margin of -21.2 dB below the radiated emissions requirements. Peak and average amplitudes were checked for compliance with the regulations. Worst-case emissions are reported with other emissions found in the restricted frequency bands at least 20 dB below the requirements.

AC Line Conducted Emissions Procedure

The design operates solely from direct current power provided from replaceable AAA batteries. The design offers no provision for connection with the Utility AC power system and therefore is exempt from AC Line conducted emissions testing.

General Radiated Emissions Procedure

The EUT was arranged in a typical equipment configuration and operated through all available mode during testing. Preliminary testing was performed in a screen room with the EUT positioned 1 meter from the FSM. Radiated emissions measurements were performed to identify the frequencies, which produced the highest emissions. Each radiated emission was then maximized at the OATS location before final radiated measurements were performed. Final data was taken with the EUT located on the OATS at 3 meters distance between the EUT and the receiving antenna. The frequency spectrum from 9 kHz to 10,000 MHz was searched for general radiated emissions. Measured emission levels were maximized by EUT placement on the table, rotating the turntable through 360 degrees, varying the antenna height between 1 and 4 meters above the ground plane and changing antenna position between horizontal and vertical polarization. Antennas used were Loop from 9 kHz to 30 MHz, Broadband Biconical from 30 to 200 MHz, Biconilog from 30 to 1000 MHz, Log Periodic from 200 MHz to 1 GHz and or double Ridge or pyramidal horns and mixers above 1 GHz, notch filters and appropriate amplifiers and external mixers were utilized.

Table 2 General Radiated Emissions Data

Frequency in MHz	Horizontal Peak (dBµV/m)	Horizontal Quasi-Peak (dBµV/m)	Horizontal Average (dBµV/m)	Vertical Peak (dBµV/m)	Vertical Quasi-Peak (dBµV/m)	Vertical Average (dBµV/m)	Limit @ 3m (dBµV/m)
111.4	31.5	13.6	N/A	29.2	25.8	N/A	40.0
114.3	27.0	22.9	N/A	28.1	21.9	N/A	40.0
371.5	23.8	15.2	N/A	22.4	16.7	N/A	46.0
384.3	21.9	18.1	N/A	20.9	15.0	N/A	46.0

Other emissions present had amplitudes at least 20 dB below the limit. Peak and Quasi-Peak amplitude emissions are recorded for frequency range below 1000 MHz. Peak and Average amplitude emissions are recorded for frequency range above 1000 MHz.

Summary of Results for General Radiated Emissions

The EUT demonstrated compliance with the radiated emissions requirements of CFR47 Part 15C paragraph 15.209, RSS-247 and RSS-GEN Intentional Radiators. The EUT demonstrated a minimum margin of -14.2 dB below the requirements. Other emissions were present with amplitudes at least 20 dB below the Limits.

Operation in the Band 902-928 MHz

This device provides operation as hybrid Digital Transmission System. The requirements and demonstration of compliance with RSS-247 and CFR47 subpart 15.247 are addressed below as specified in KDB 558074 D01 15.247 Meas Guidance v05r02.

Information from KDB 558074 D01 15.247 Meas Guidance v05r02

10. HYBRID SYSTEM EQUIPMENT UNDER SECTION 15.247

The following information is for certification of hybrid spread-spectrum devices under Section 15.247.

- a) Use Form-731 equipment-class code DSS.
- b) Hybrid system device measurement guidelines are as follows.
 - 1) As specified in Section 15.247(f), a hybrid system must comply with the power density standard of 8 dBm in any 3 kHz band when the frequency hopping function is turned off.
 - 2) The transmission must comply with a 0.4 second/channel maximum dwell time when the hopping function is turned on.
 - 3) There is no requirement for this type of hybrid system to comply with the 500 kHz minimum bandwidth normally associated with a DTS device.

- 4) There is no minimum number of hopping channels associated with this type of hybrid system. While there is not a specific minimum limit, the hop sequence is required to appear as pseudorandom per Section 15.247(a)(1) (see Section 3 of this document).
- 5) The hopping function must be a true frequency hopping system, as described in Section 15.247(a)(1). The specific requirements in Section 15.247(a)(1) are:
 - i) a minimum channel separation;
 - ii) pseudo-random hop sequence;
 - iii) equal use of each frequency; and
 - iv) receiver matching bandwidth and synchronization.
- 6) Generally, use the test procedures for DTS and FHSS devices in Clause 11 and 7.8 of ANSI C63.10, respectively.
 - i) Output power: use 11.9 of ANSI C63.10;
 - ii) Peak Power Density: use 11.10 of ANSI C63.10;
 - iii) Carrier channel separation: use 7.8.2 of ANSI C63.10;
 - iv) Dwell time: use 7.8.4 of ANSI C63.10.

The design operates as P-mode equipment for communications during typical operation and pairing with remote base station.

Example of P-mode operation after initial pairing of sensor with base, the base continuously listens to both frequencies.

- Upon the sensor awakening, the wake-up counter is started.
- The sensor generates random number between 0.4 and 3.5. This variable is referenced as “T”
- Assuming the sensor operating in this channel group (for this example) is allowed to transmit data at either 917.3MHz or 922.9MHz
- Before each data transmission, the sensor will pseudo randomly chose frequency in which to transmit data - 917.3MHz or 922.9MHz
- Assuming that this time the pseudo random generation has chosen 917.3 MHz frequency in which to transmit data
- The sensor then “listens” to frequency 917.3MHz, to determine if the frequency is open or occupied.
- If frequency 917.3MHz is open, the sensor will send data to ARANET Pro base. If frequency is occupied, it will wait for “T” seconds and “listen” again. “Listening” can happen only 2 times. If both times frequency 917.3MHz is occupied, on 3rd time the sensor will transmit data at 917.3MHz.
- Length of data transmission from sensor to ARANET Pro base is 250ms.
- After data is transmitted, sensor goes to “sleep” and wakes up only when wake-up counter hits 600s + “T” seconds spent on listening if frequency 917.3MHz was occupied.
- When counter is done, sensor will wake-up and pseudo randomly chose frequency in which to transmit data - 917.3MHz or @ 922.9MHz and begin the cycle again.

The amplitude of each harmonic and general radiated emission was measured on the OATS at distance of 3 meters from the FSM antenna (testing was performed on samples 1 representative of production equipment with integral antenna). The EUT was positioned on supporting turntable elevated as required above the ground plane, at a distance of 3 meters from the FSM antenna. Radiated emission investigations were performed from 9 kHz to 10,000 MHz. Each radiated emission was maximized by varying the FSM antenna height and polarization, and by rotating the turntable. The worst-case amplitude of each emission was then recorded from the analyzer display. The peak and quasi-peak amplitude of frequencies below 1000 MHz were measured using a spectrum analyzer. The peak and average amplitude of frequencies above 1000 MHz were measured using a spectrum analyzer. A Loop antenna was used for measuring emissions from 0.009 to 30 MHz, Biconilog Antenna for 30 to 1000 MHz, Double-Ridge, and/or Pyramidal Horn Antennas above 1 GHz.

Plots of pairing mode are presented in figures 1 through 4. Plots of P-mode operations are presented in figures 5 through 16 and data in tables 3 and 4.

Radiated emissions testing was performed on the Open Area Test Site using samples 1 and 2. Test sample 3 was provided for antenna port conducted emissions testing. Test sample 3 was modified by replacing the integral antenna with a 50-ohm antenna port connector for testing purposes. Plots were taken of transmitter performance (using sample 3 for reference).

Modulation information:

Modulation parameters during sensor pairing mode (18229.17 bits per second; 0.26ms symbol time). Modulation parameters during regular operation (813.8 bits per second; 8.19ms symbol time)

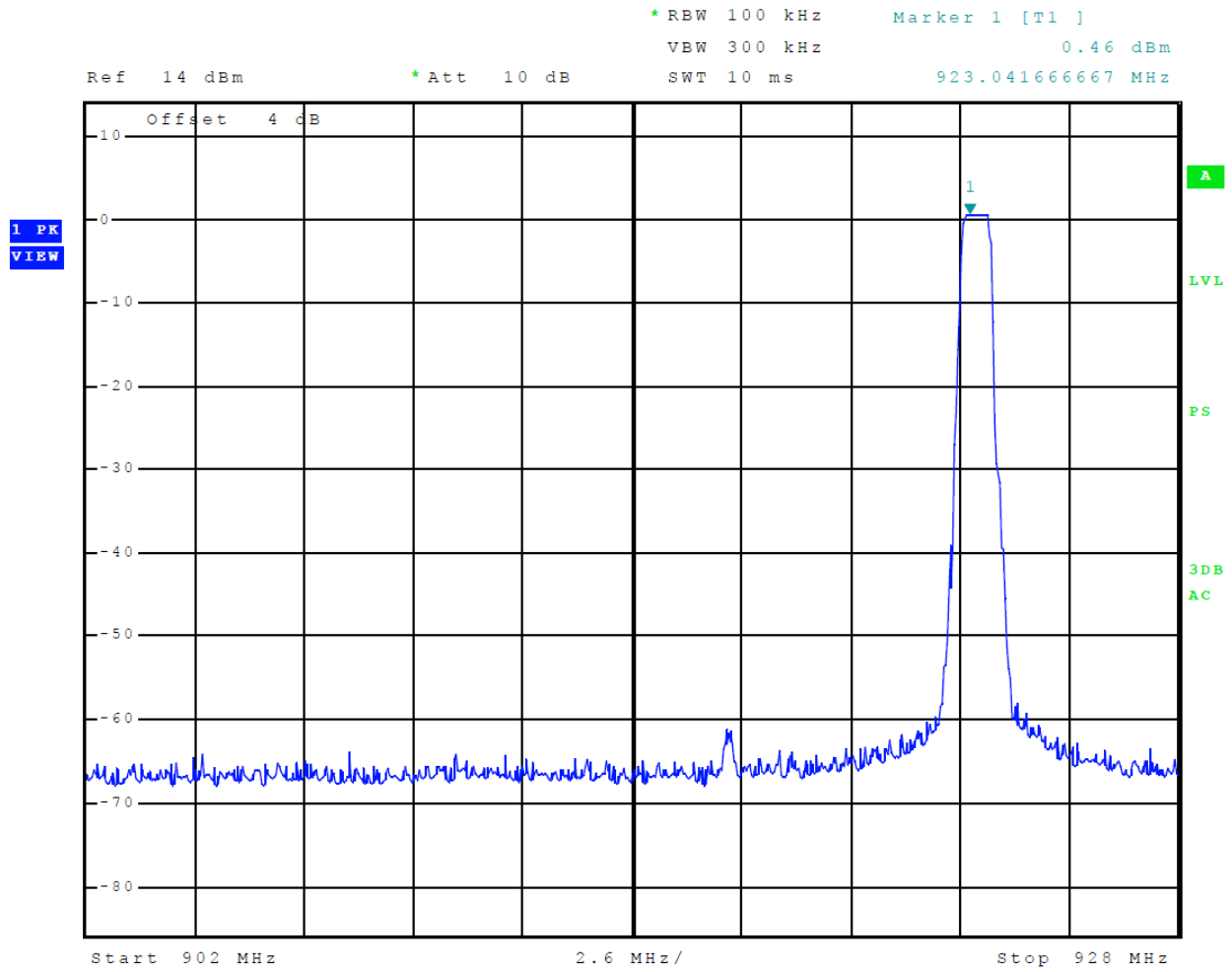

Figure 1 Plot of Transmitter Emissions in Operational Frequency Band (Pairing)

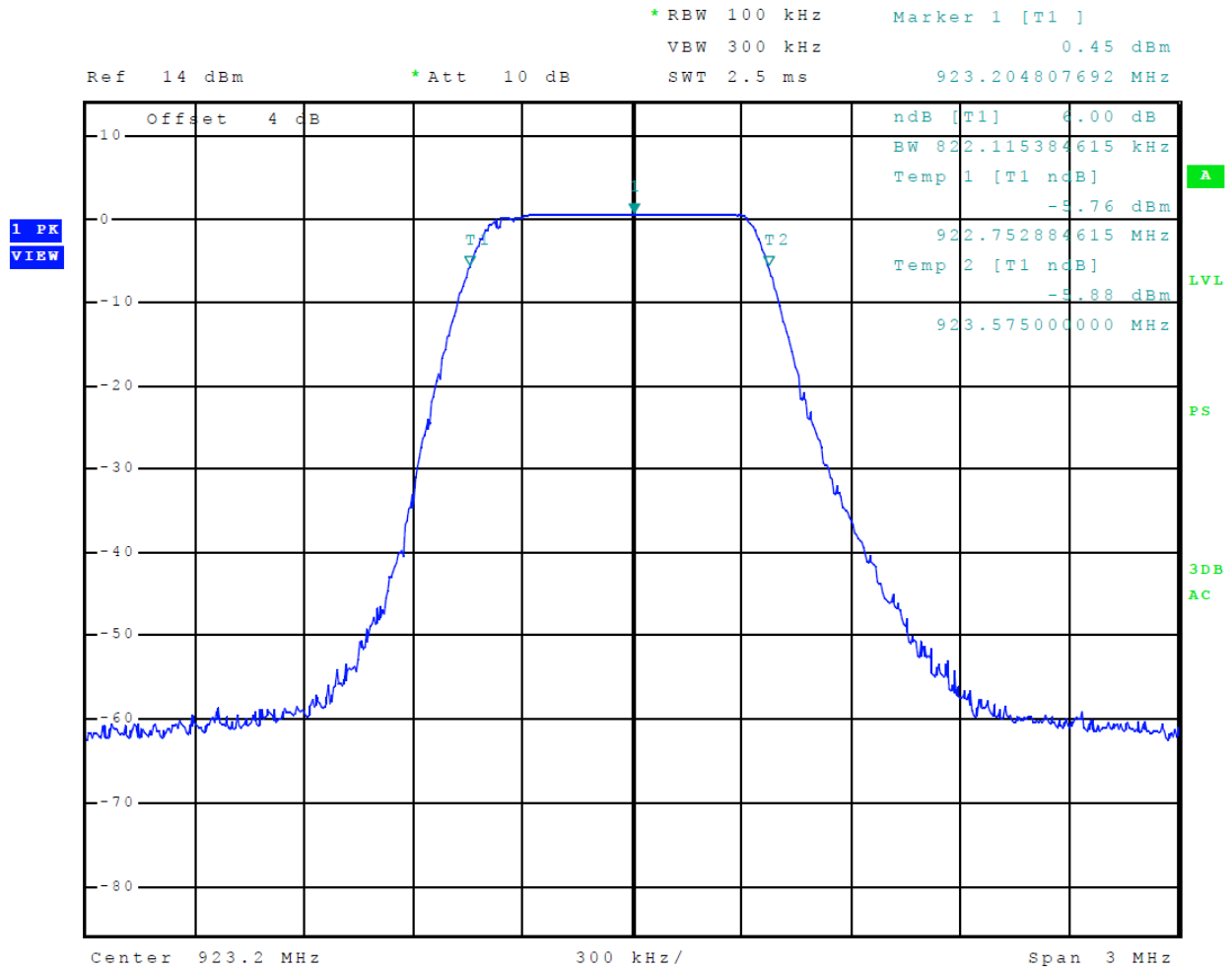

Figure 2 Plot of Transmitter 6-dB Occupied Bandwidth (Pairing)

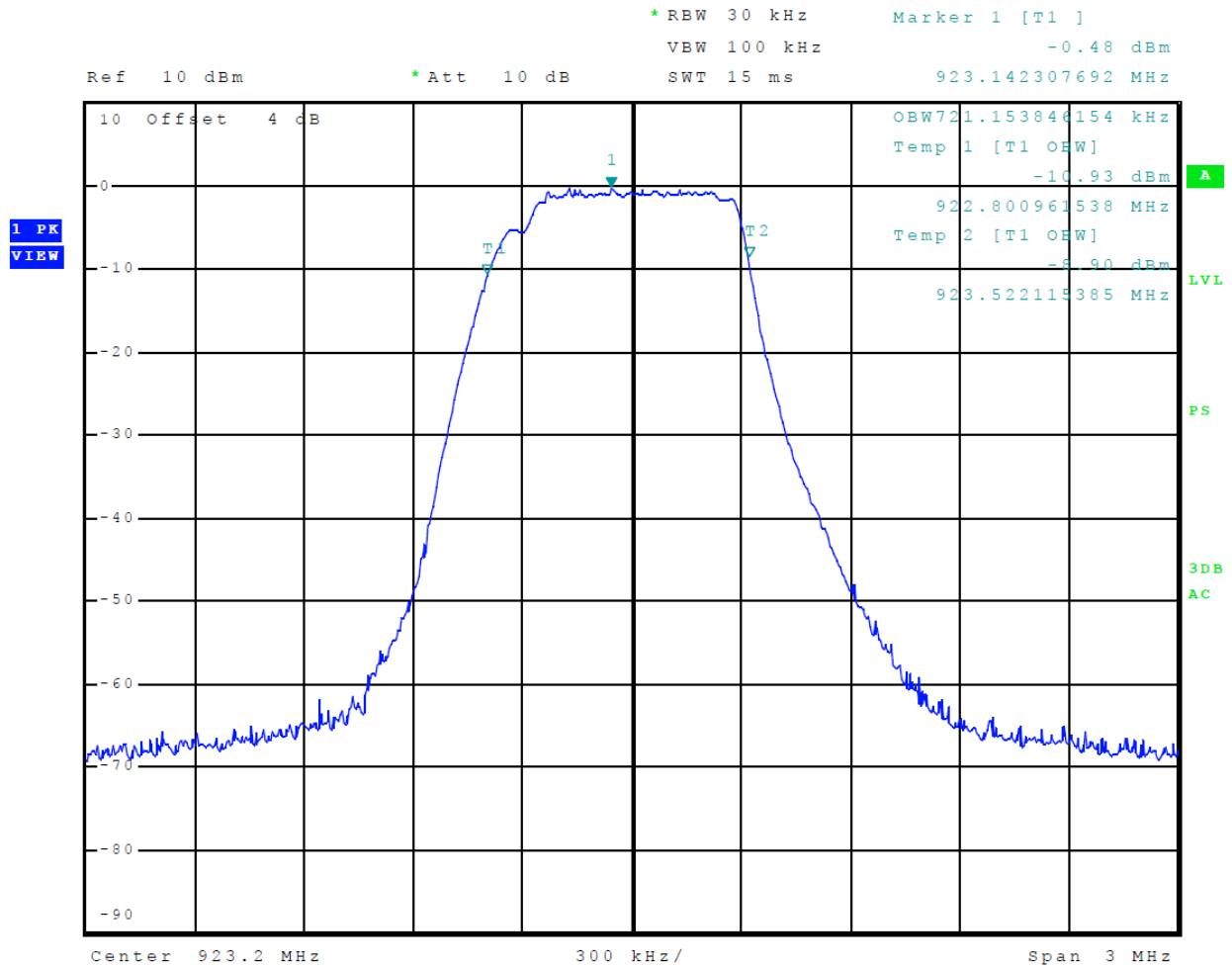

Figure 3 Plot of Transmitter 99% Occupied Bandwidth (Pairing)

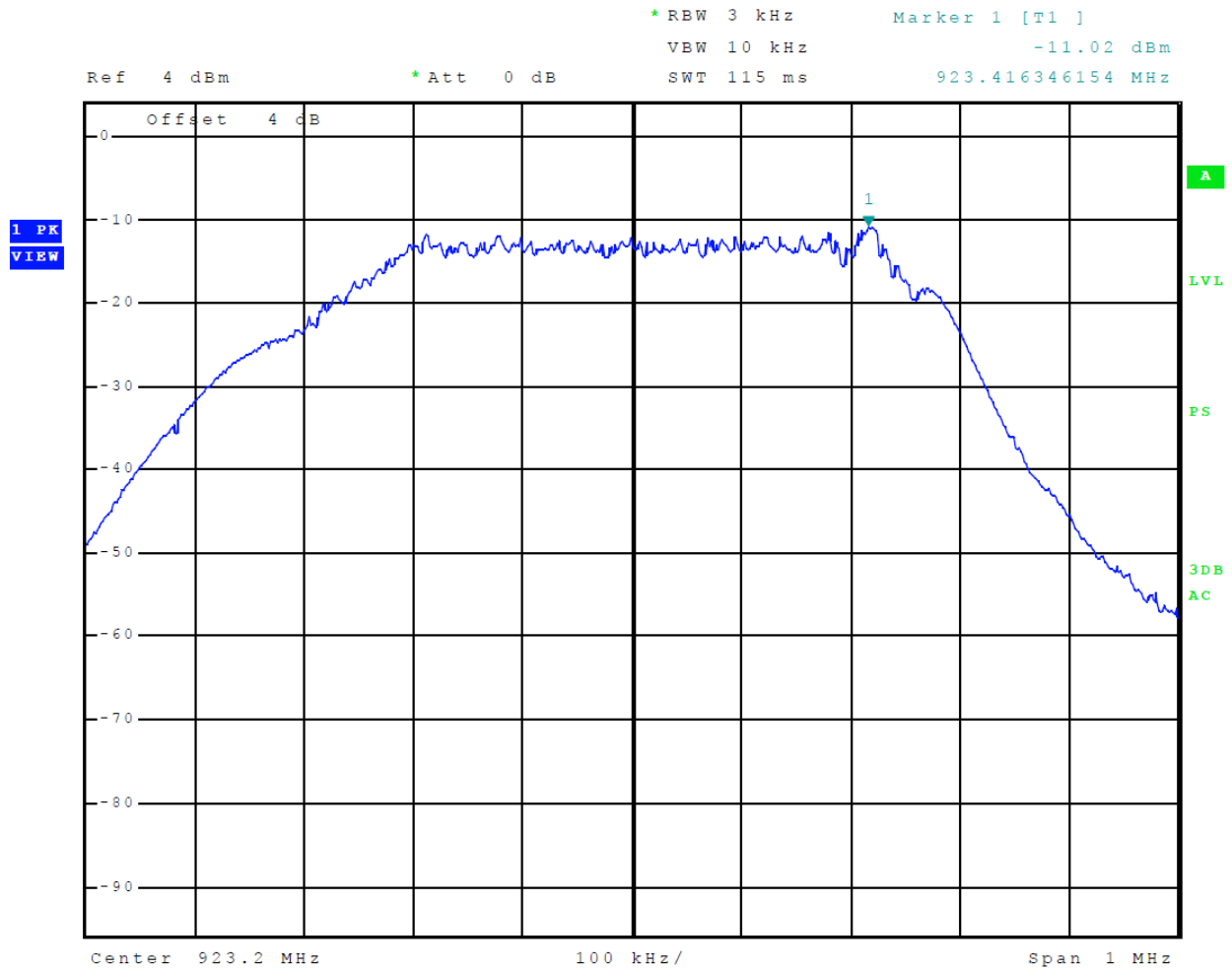

Figure 4 Plot of Power Spectral Density (Pairing)

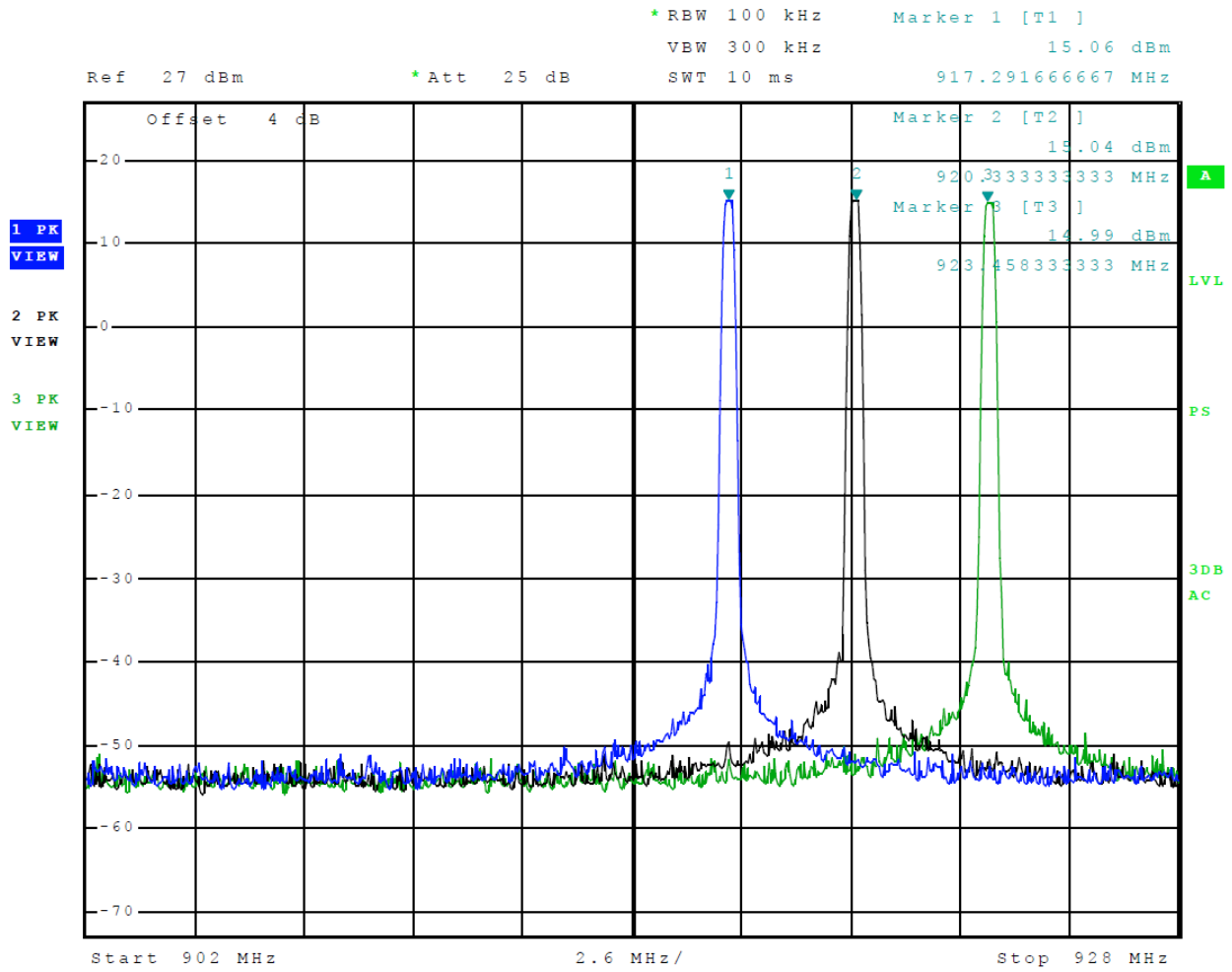

Figure 5 Plot of Transmitter Emissions in Operational Frequency Band (P-Mode)

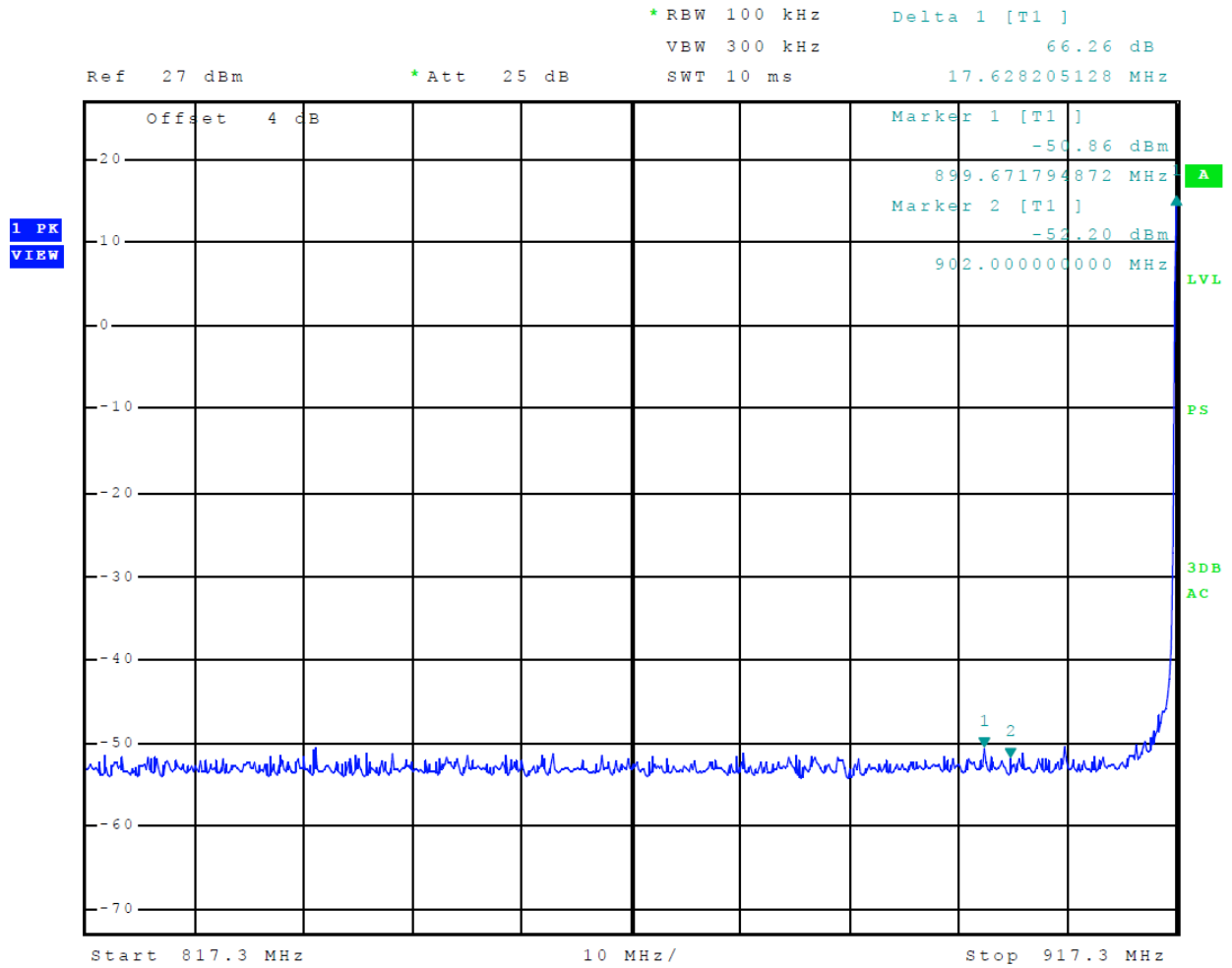

Figure 6 Plot of Lower Band Edge (P-mode)

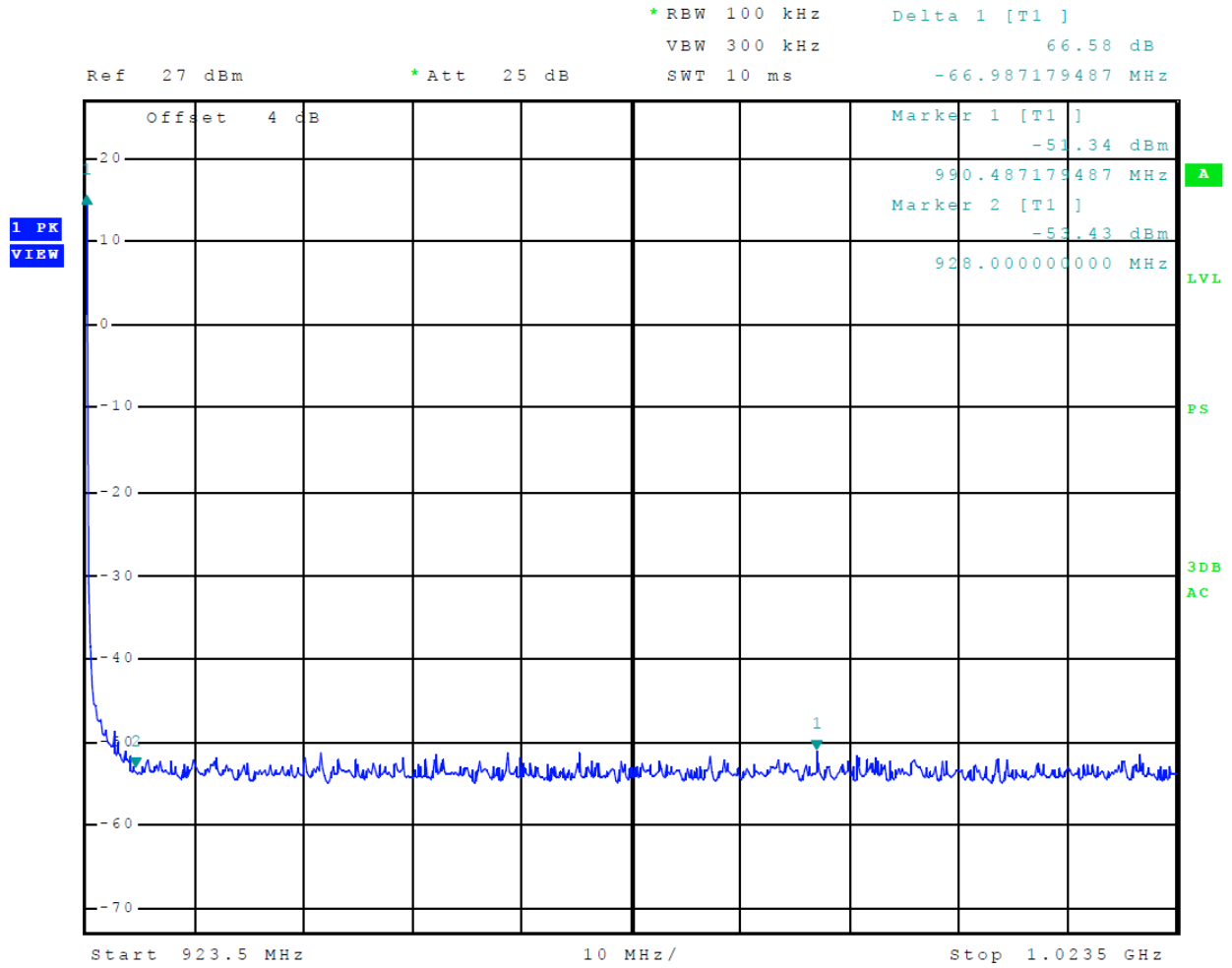

Figure 7 Plot of Upper Band Edge (P-mode)

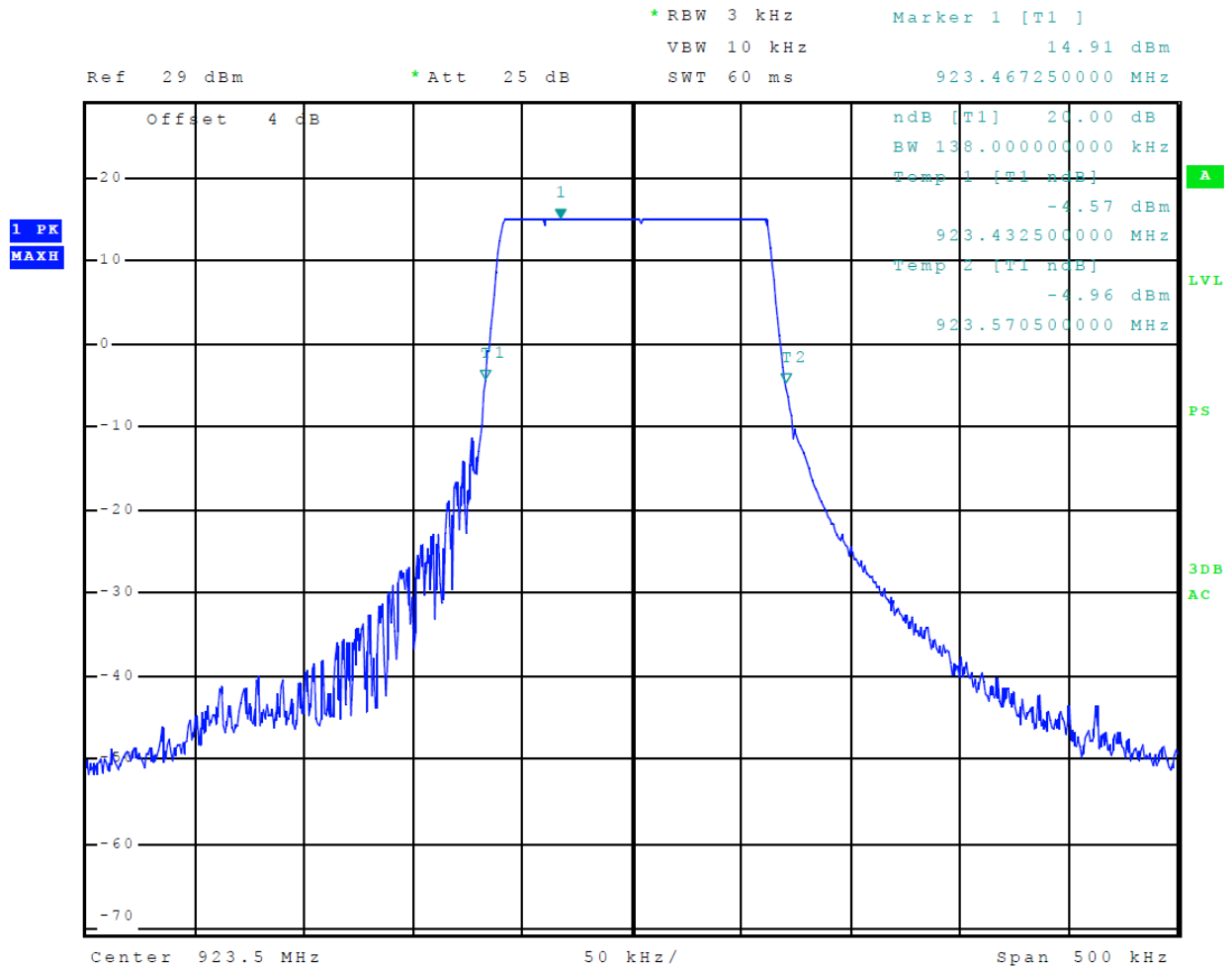

Figure 8 Plot of Transmitter 20-dB Occupied Bandwidth (P-mode)

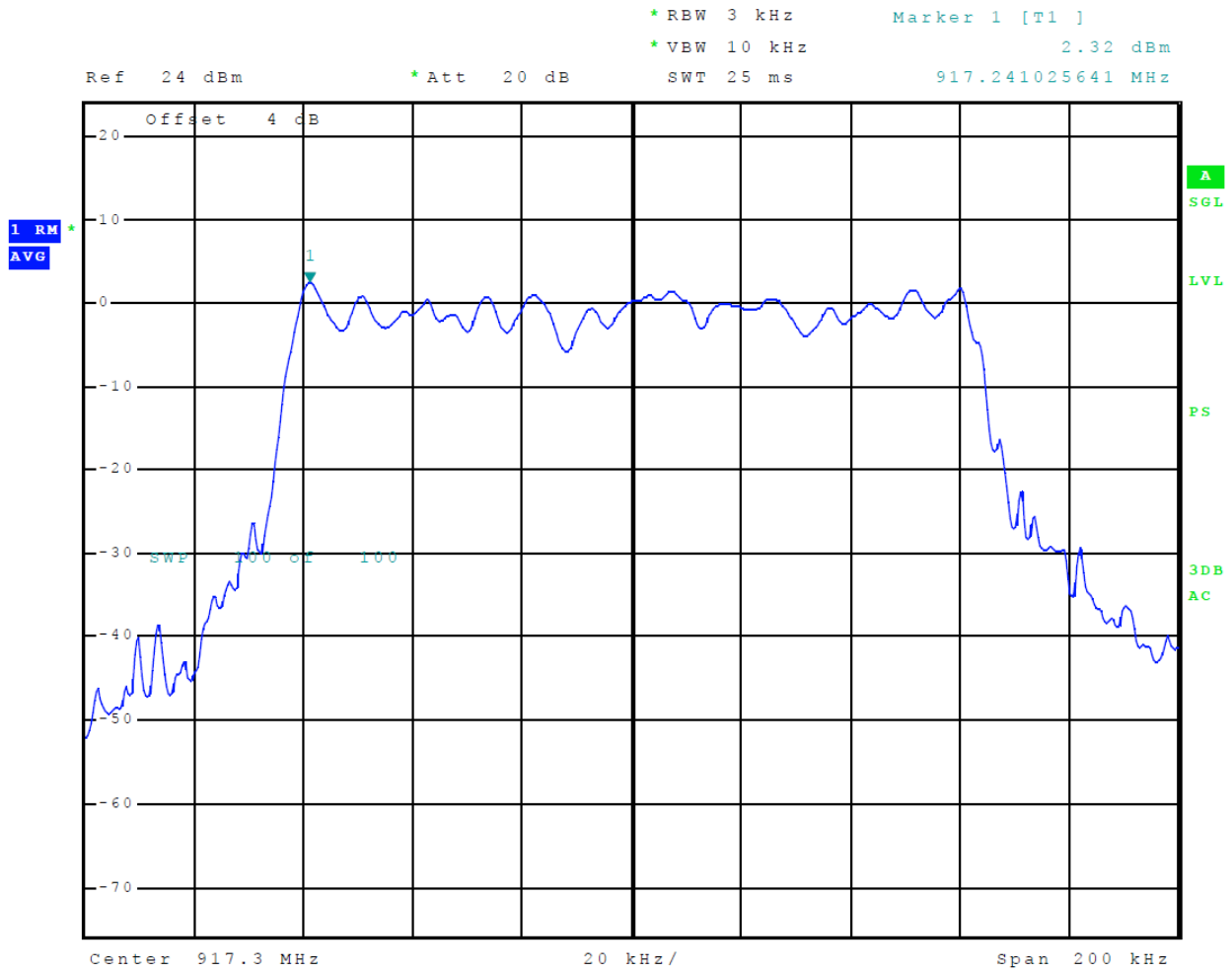

Figure 9 Plot of Power Spectral Density (P-Mode)

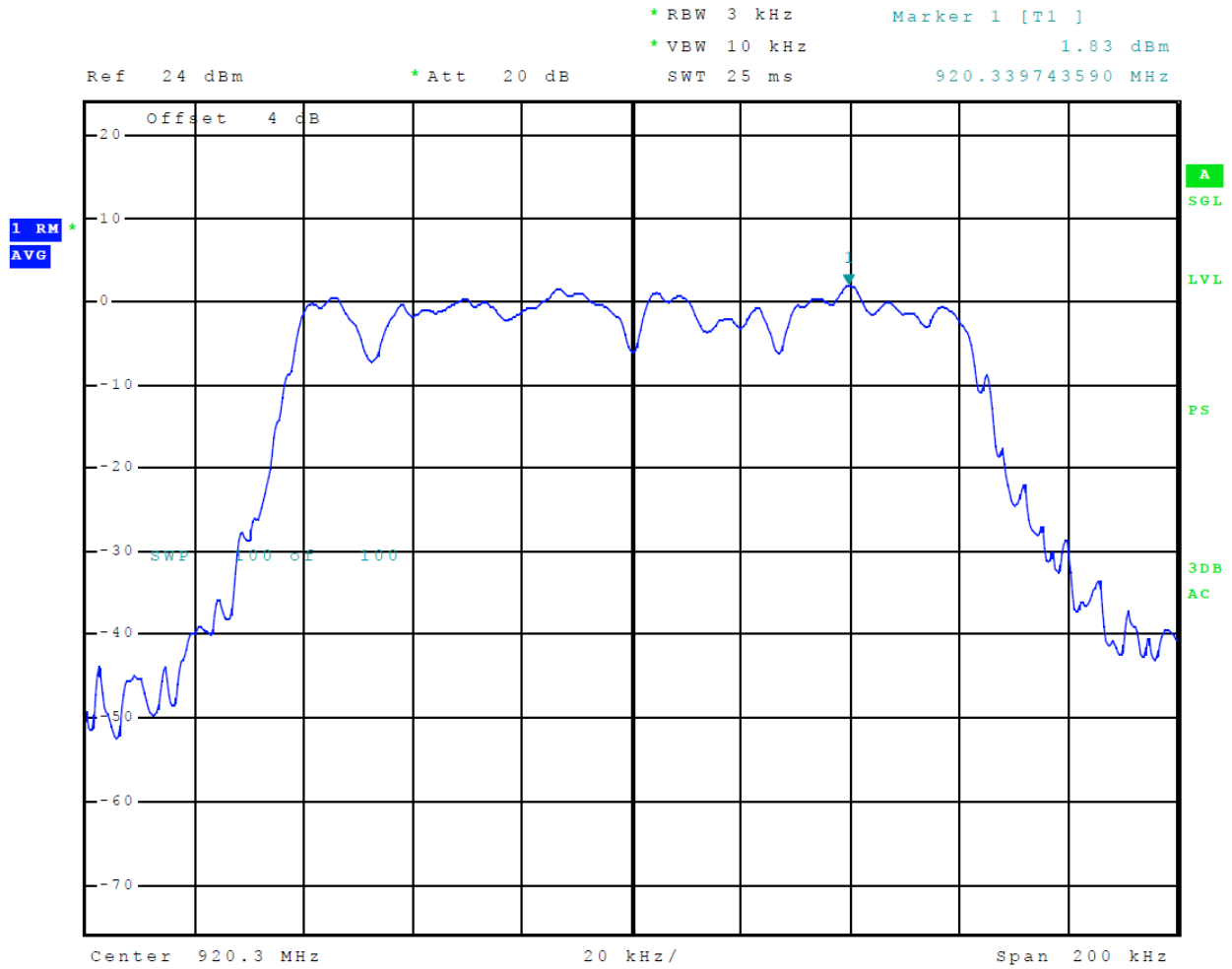

Figure 10 Plot of Power Spectral Density (P-Mode)

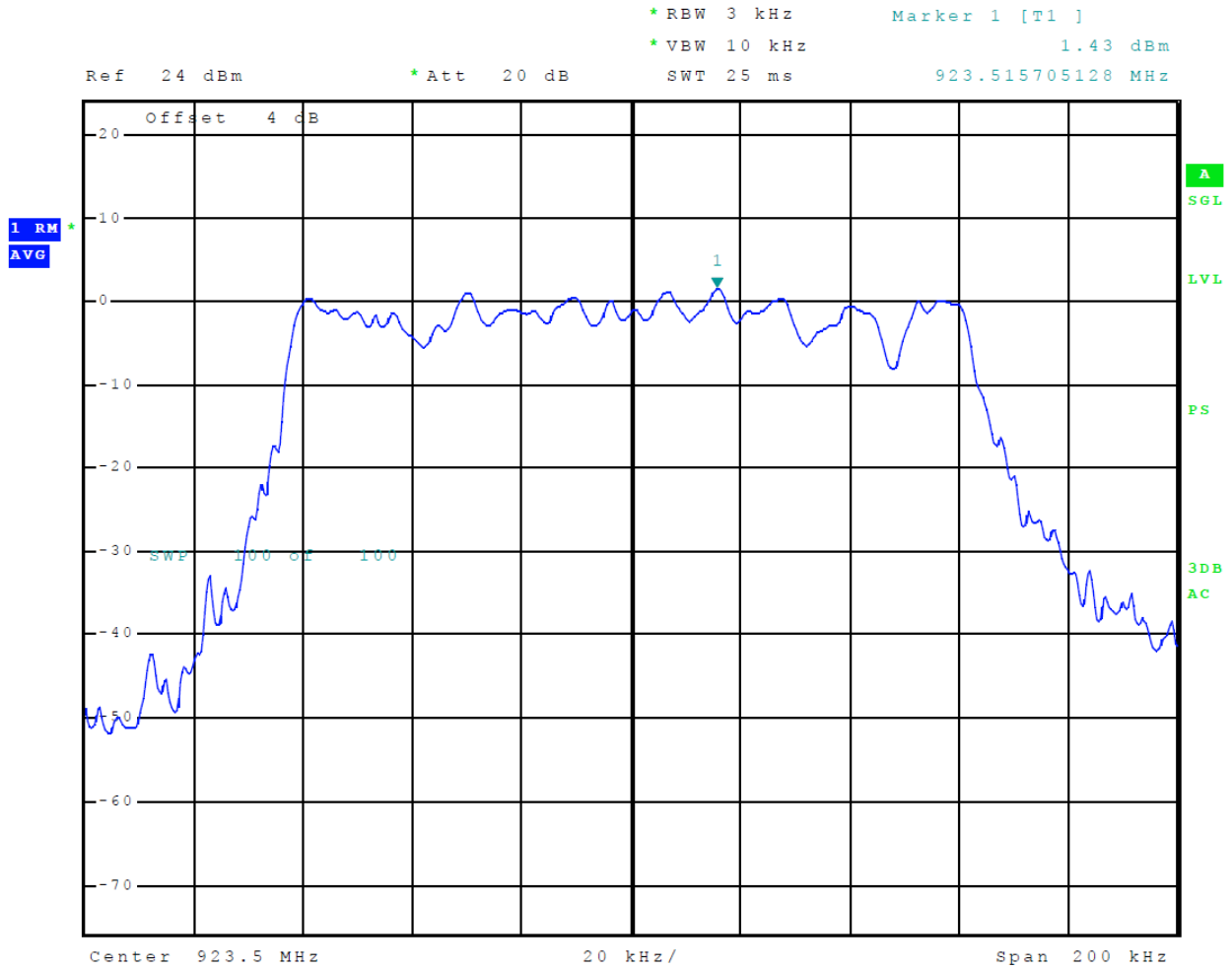

Figure 11 Plot of Power Spectral Density (P-Mode)

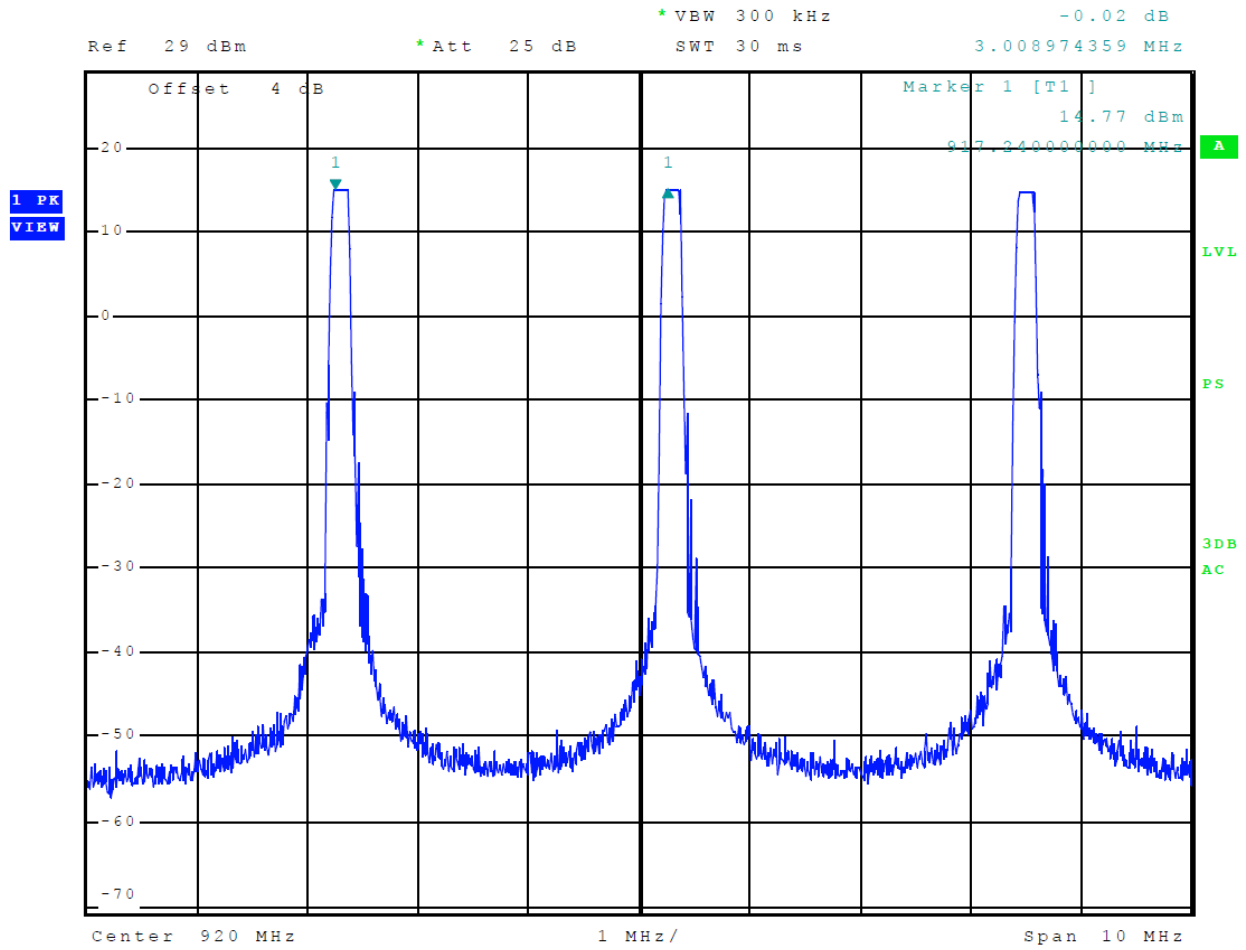

Figure 12 Plot of Channel Separation (P-mode)

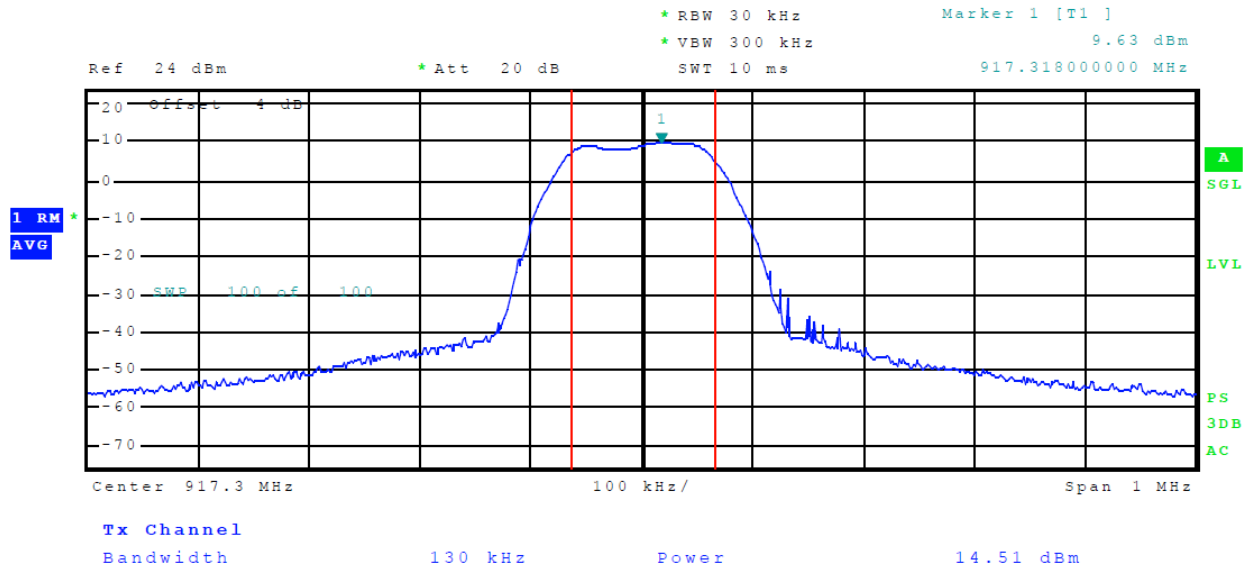

Figure 13 Plot of Output Power (P-Mode)

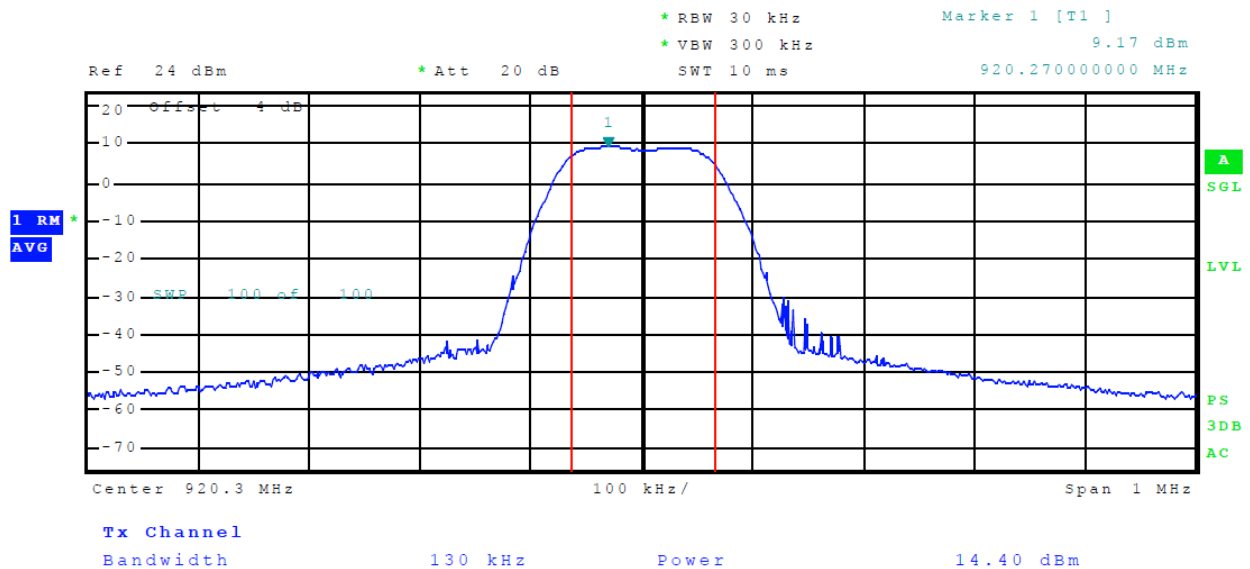

Figure 14 Plot of Output Power (P-Mode)

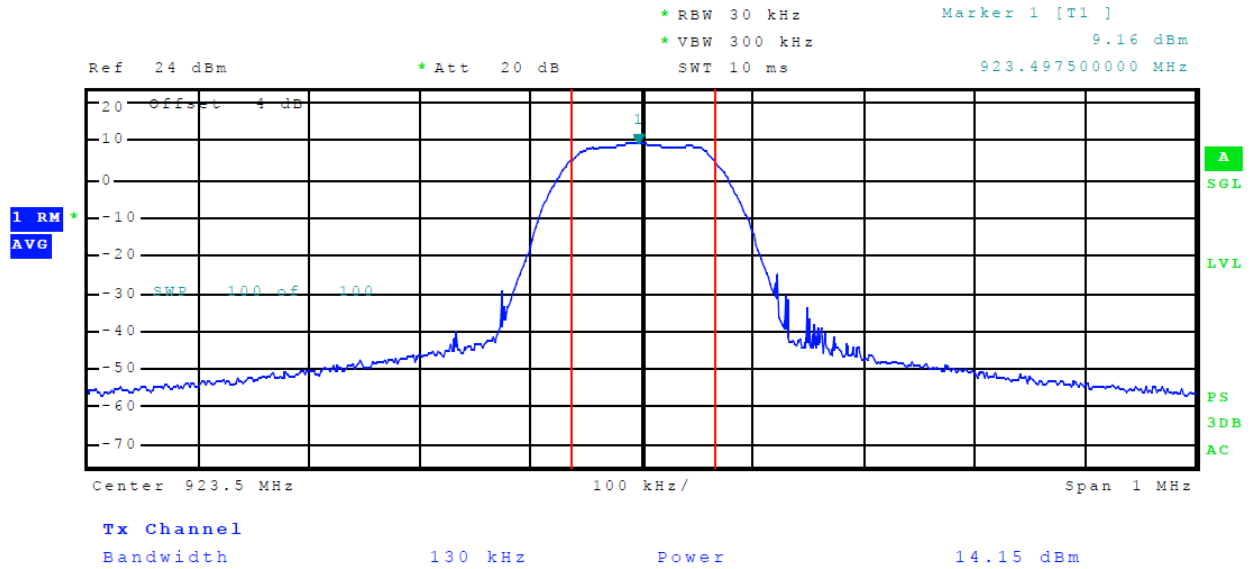

Figure 15 Plot of Output Power (P-Mode)

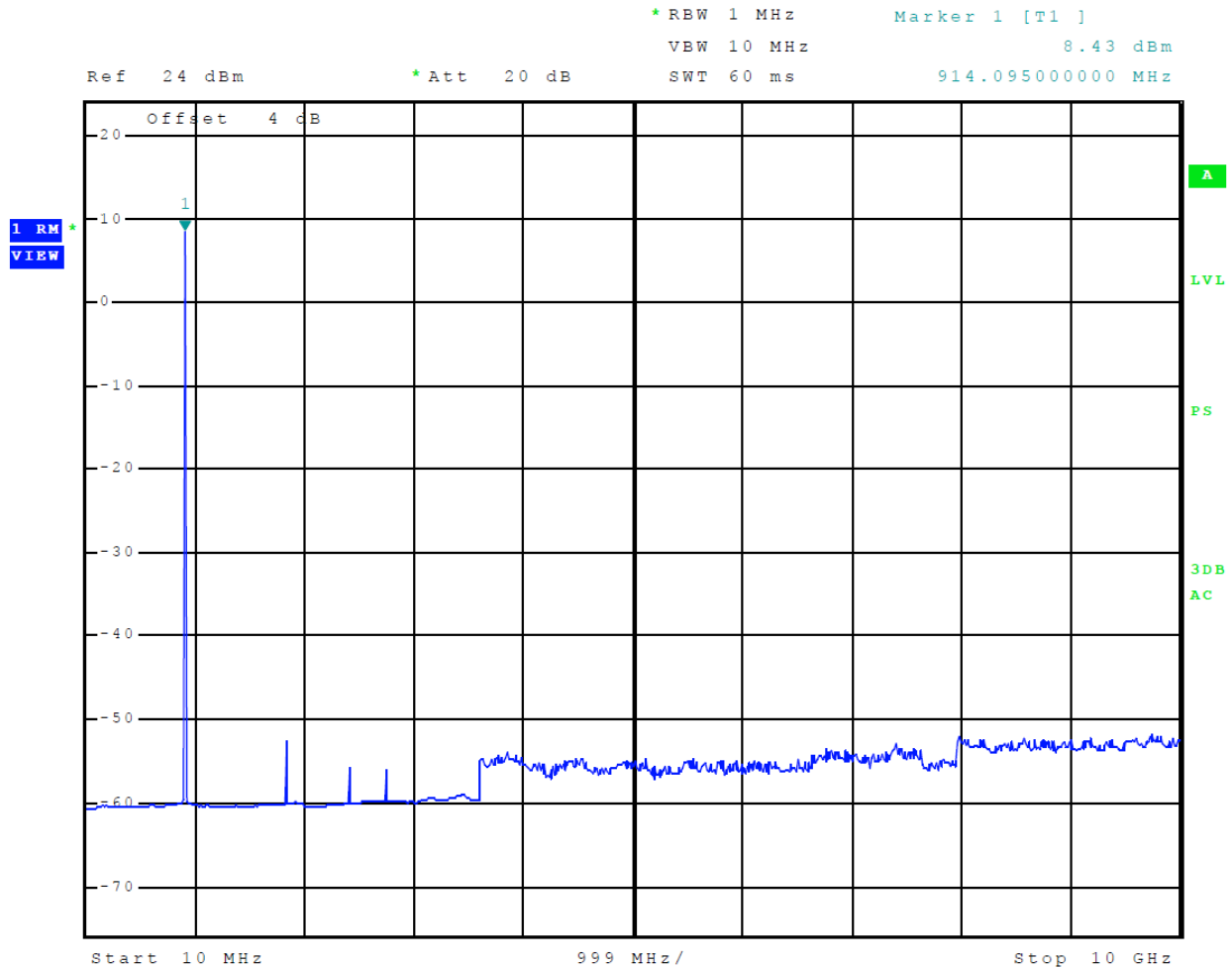

Figure 16 Plot of Out of Band Emissions

Transmitter Emissions Data

Table 3 Transmitter Radiated Emission Worst-case Data

Frequency in MHz	Horizontal Peak (dBµV/m)	Horizontal Average (dBµV/m)	Vertical Peak (dBµV/m)	Vertical Average (dBµV/m)	Limit @ 3m (dBµV/m)
917.3	--	--	--	--	--
1834.6	47.4	16.4	47.2	13.8	54.0
2751.9	58.0	32.3	56.7	30.4	54.0
3669.2	49.5	13.9	49.6	13.7	54.0
4586.5	48.7	12.8	48.9	12.8	54.0
5503.8	51.4	14.8	50.2	14.6	54.0
6421.1	55.5	22.6	54.4	19.2	54.0
920.3	--	--	--	--	--
1840.6	44.9	9.7	44.5	8.9	54.0
2760.9	58.6	32.8	58.0	32.1	54.0
3681.2	50.4	14.1	50.0	13.9	54.0
4601.5	48.3	12.7	48.8	12.7	54.0
5521.8	51.0	14.9	50.6	14.7	54.0
6442.1	56.4	24.0	55.1	20.0	54.0
923.5	--	--	--	--	--
1847.0	46.7	14.4	47.2	14.1	54.0
2770.5	58.5	32.7	58.0	31.7	54.0
3694.0	49.4	13.7	50.1	13.7	54.0
4617.5	48.9	13.2	49.2	13.2	54.0
5541.0	50.8	15.3	52.7	15.3	54.0
6464.5	54.5	18.8	55.5	22.0	54.0

Other emissions present had amplitudes at least 20 dB below the limit. Peak and Quasi-Peak amplitude emissions are recorded for frequency below 1000 MHz. Peak and Average amplitude emissions are recorded for frequency range above 1000 MHz.

Table 4 Transmitter Antenna Port Data

Frequency MHz	Antenna Port Output Power (Watts)	99% Occupied Bandwidth (kHz)	20-dB Occupied Bandwidth (kHz)	6-dB Occupied Bandwidth (kHz)	Peak Power Spectral Density (dBm/3kHz)
P-mode (Pairing)					
923.2	0.001	832.5	N/A	649.0	-11.5
P-mode (Operation)					
917.3	0.028	N/A	138.0	N/A	2.3
920.3	0.028	N/A	138.0	N/A	1.8
923.5	0.026	N/A	138.0	N/A	1.4

Summary of Results for Transmitter Radiated Emissions of Intentional Radiator

The EUT demonstrated compliance with the radiated emissions requirements of CFR47 Part 15.247, RSS-GEN, and RSS-247 Hybrid Digital Transmission Systems. Antenna port conducted output power of 0.028 Watts was measured at the temporary antenna port of the EUT. The power spectral density measured at the antenna port presented a minimum margin of -5.7 dB below the requirements. The EUT demonstrated a minimum margin of -21.2 dB below the harmonic emissions requirements. There were no other significantly measurable emissions in the restricted bands other than those recorded in this report. Other emissions were present with amplitudes at least 20 dB below the requirements. There were no other deviations or exceptions to the requirements.

Annex

- Annex A Measurement Uncertainty Calculations
- Annex B Additional Test Equipment List
- Annex C Rogers Qualifications
- Annex D Laboratory Certificate of Accreditation

Annex A Measurement Uncertainty Calculations

The measurement uncertainty was calculated for all measurements listed in this test report according To CISPR 16-4. Result of measurement uncertainty calculations are recorded below. Component and process variability of production devices similar to those tested may result in additional deviations. The manufacturer has the sole responsibility of continued compliance.

Measurement	Expanded Measurement Uncertainty $U_{(lab)}$
3 Meter Horizontal 0.009-1000 MHz Measurements	4.16
3 Meter Vertical 0.009-1000 MHz Measurements	4.33
3 Meter Measurements 1-18 GHz	5.14
3 Meter Measurements 18-40 GHz	5.16
10 Meter Horizontal Measurements 0.009-1000 MHz	4.15
10 Meter Vertical Measurements 0.009-1000 MHz	4.32
AC Line Conducted	1.75
Antenna Port Conducted power	1.17
Frequency Stability	1.00E-11
Temperature	1.6°C
Humidity	3%

Annex B Additional Test Equipment List

List of Test Equipment	Calibration	Date (m/d/y)	Due
Antenna: Schwarzbeck Model: BBA 9106/VHBB 9124 (9124-627)		4/18/2019	4/18/2020
Antenna: Schwarzbeck Model: VULP 9118 A (VULP 9118 A-534)		4/18/2019	4/18/2020
Antenna: EMCO 6509		10/16/2018	10/16/2020
Antenna: EMCO 3143 (9607-1277) 20-1200 MHz		4/18/2019	4/18/2020
Antenna: EMCO Dipole Set 3121C		2/22/2019	2/22/2020
Antenna: C.D. B-101		2/22/2019	2/22/2020
Antenna: Solar 9229-1 & 9230-1		2/22/2019	2/22/2020
Cable: Belden 8268 (L3)		10/16/2018	10/16/2019
Cable: Time Microwave: 4M-750HF290-750		10/16/2018	10/16/2019
Frequency Counter: Leader LDC-825 (8060153)		4/18/2019	4/18/2020
Oscilloscope Scope: Tektronix 2230		2/22/2019	2/22/2020
Wattmeter: Bird 43 with Load Bird 8085		2/22/2019	2/22/2020
R.F. Generators: HP 606A, HP 8614A, HP 8640B		2/22/2019	2/22/2020
R.F. Power Amp 65W Model: 470-A-1010		2/22/2019	2/22/2020
R.F. Power Amp 50W M185- 10-501		2/22/2019	2/22/2020
R.F. Power Amp A.R. Model: 10W 1010M7		2/22/2019	2/22/2020
R.F. Power Amp EIN Model: A301		2/22/2019	2/22/2020
LISN: Compliance Eng. Model 240/20		4/18/2019	4/18/2020
LISN: Fischer Custom Communications Model: FCC-LISN-50-16-2-08		4/18/2019	4/18/2020
Audio Oscillator: H.P. 201CD		2/22/2019	2/22/2020
ESD Test Set 2010i		2/22/2019	2/22/2020
Oscilloscope Scope: Tektronix MDO 4104		2/22/2019	2/22/2020
EMC Transient Generator HVT TR 3000		2/22/2019	2/22/2020
AC Power Source (Ametech, California Instruments)		2/22/2019	2/22/2020
Fast Transient Burst Generator Model: EFT/B-101		2/22/2019	2/22/2020
Field Intensity Meter: EFM-018		2/22/2019	2/22/2020
KEYTEK Ecat Surge Generator		2/22/2019	2/22/2020
ESD Simulator: MZ-15		2/22/2019	2/22/2020
Shielded Room not required			

Annex C Rogers Qualifications

Scot D. Rogers, Engineer

Rogers Labs, Inc.

Mr. Rogers has approximately 31 years' experience in the field of electronics. Work experience includes six years working in the automated controls industry and remaining years working with the design, development and testing of radio communications and electronic equipment.

Positions Held:

Systems Engineer: A/C Controls Mfg. Co., Inc. 6 Years

Electrical Engineer: Rogers Consulting Labs, Inc. 5 Years

Electrical Engineer: Rogers Labs, Inc. Current

Educational Background:

- 1) Bachelor of Science Degree in Electrical Engineering from Kansas State University
- 2) Bachelor of Science Degree in Business Administration Kansas State University
- 3) Several Specialized Training courses and seminars pertaining to Microprocessors and Software programming.

Annex D Laboratory Certificate of Accreditation

United States Department of Commerce
National Institute of Standards and Technology



Certificate of Accreditation to ISO/IEC 17025:2005

NVLAP LAB CODE: 200087-0

Rogers Labs, Inc.
Louisburg, KS

*is accredited by the National Voluntary Laboratory Accreditation Program for specific services,
listed on the Scope of Accreditation, for:*

Electromagnetic Compatibility & Telecommunications

*This laboratory is accredited in accordance with the recognized International Standard ISO/IEC 17025:2005.
This accreditation demonstrates technical competence for a defined scope and the operation of a laboratory quality
management system (refer to joint ISO-ILAC-IAF Communique dated January 2009).*

2019-03-27 through 2020-03-31
Effective Dates

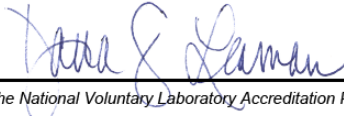

For the National Voluntary Laboratory Accreditation Program

Rogers Labs, Inc.
4405 W. 259th Terrace
Louisburg, KS 66053
Phone/Fax: (913) 837-3214
Revision 2

SAF Tehnika AS
Model: TDSPC0U3 (Aranet 4)
Test: 190530
Test to: CFR47 15C, RSS-Gen RSS-247
File: SAF TDSPC0U3 DTS TstRpt 190530 r2

S/N's: 306681 000005 / 306681 000006
FCC ID: W9Z-ARANET4
IC: 8855A-ARANET4
Date: August 27, 2019
Page 42 of 42