

FCC RF Test Report

APPLICANT : Green Packet Berhad, Taiwan
EQUIPMENT : WiMAX USB Modem
BRAND NAME : Green Packet
MODEL NAME : UT-235
FCC ID : W9V-UT235-GP
STANDARD : 47 CFR Part 2, 27(M)
CLASSIFICATION : Licensed Non-Broadcast Station Transmitter (TNB)
TX FREQUENCY RANGE : 2496 MHz ~ 2690 MHz
Rx FREQUENCY RANGE : 2496 MHz ~ 2690 MHz
MAX. EIRP POWER : 0.13 W (QPSK, BW 5MHz)
0.07 W (QPSK, BW 10MHz)
0.13 W (16QAM, BW 5MHz)
0.07 W (16QAM, BW 10MHz)
EMISSION DESIGNATOR : 4M48G7D (QPSK, BW 5MHz)
9M12G7D (QPSK, BW 10MHz)
4M48W7D (16QAM, BW 5MHz)
9M12W7D (16QAM, BW 10MHz)

The product was received on Feb. 25, 2011 and completely tested on Apr. 29, 2011. We, SPORTON INTERNATIONAL INC., would like to declare that the tested sample has been evaluated in accordance with the procedures given in ANSI C63.4-2003 and 47 CFR FCC Part 27 Subpart M and shown compliance with the applicable technical standards.

The test results in this report apply exclusively to the tested model / sample. Without written approval of SPORTON INTERNATIONAL INC., the test report shall not be reproduced except in full.

Reviewed by:



Jones Tsai / Manager



SPORTON INTERNATIONAL INC.

No. 52, Hwa Ya 1st Rd., Hwa Ya Technology Park, Kwei-Shan Hsiang, Tao Yuan Hsien, Taiwan, R.O.C.

SPORTON INTERNATIONAL INC.

TEL : 886-3-327-3456

FAX : 886-3-328-4978

FCC ID : W9V-UT235-GP

Page Number : 1 of 48

Report Issued Date : May 31, 2011

Report Version : Rev. 01



TABLE OF CONTENTS

REVISION HISTORY..... 3

SUMMARY OF TEST RESULT 4

1 GENERAL DESCRIPTION 5

 1.1 Applicant 5

 1.2 Manufacturer 5

 1.3 Feature of Equipment Under Test 6

 1.4 Testing Site 7

 1.5 Applied Standards 7

 1.6 Ancillary Equipment List 7

2 TEST CONFIGURATION OF EQUIPMENT UNDER TEST 8

 2.1 Test Mode 8

 2.2 Connection Diagram of Test System 10

3 TEST RESULT 11

 3.1 Maximum Output Power, Band Edge, and Effective Isotropic Radiated Power Measurement 11

 3.2 Emission Bandwidth 20

 3.3 Conducted Spurious Emission Measurement 25

 3.4 Radiated Emissions Measurement 38

 3.5 Frequency Stability Measurement 44

4 LIST OF MEASURING EQUIPMENTS..... 47

5 UNCERTAINTY OF EVALUATION 48

APPENDIX A. PHOTOGRAPHS OF EUT

APPENDIX B. SETUP PHOTOGRAPHS



SUMMARY OF TEST RESULT

Report Section	FCC Rule	Description	Limit	Result	Remark
3.1	§2.1033 §2.1046 §27.50	Maximum Output Power	< 2 Watts	PASS	-
3.1	§2.1033 §2.1046 §27.50	Band Edge Emissions	< 5.5MHz: -13 dBm ≥5.5MHz: -25 dBm	PASS	-
3.1	§27.50	Equivalent Isotropic Radiated Power	< 2 Watts	PASS	-
3.2	§2.1049 §27.53	Emissions Bandwidth	N/A	PASS	-
3.3	§2.1051 §27.53	Conducted Spurious Emissions	$< 55+10\log_{10}(P[\text{Watts}])$	PASS	-
3.4	§2.1053 §27.53	Field Strength of Spurious Radiation	$< 55+10\log_{10}(P[\text{Watts}])$	PASS	Under limit 12.51 dB at 7779 MHz
3.5	§2.1055 §27.54	Frequency Stability for Temperature & Voltage	2.5 ppm	PASS	-



1 General Description

1.1 Applicant

Green Packet Berhad, Taiwan

6F., No. 21, Lane 583, Rueiguang Rd., Neihu District, Taipei City, Taiwan (R.O.C.)

1.2 Manufacturer

Green Packet Berhad, Taiwan

1. 6F., No. 21, Lane 583, Rueiguang Rd., Neihu District, Taipei City, Taiwan (R.O.C.)
2. Suite 21211, No. 498, Guoshoujing Road, Pudong New Area, Shanghai, P.C.201203, China

1.3 Feature of Equipment Under Test

Product Feature & Specification	
Equipment	WiMAX USB Modem
Brand Name	Green Packet
Model Name	UT-235
FCC ID	W9V-UT235-GP
Tx Frequency	2496 MHz ~ 2690 MHz
Rx Frequency	2496 MHz ~ 2690 MHz
Channel Bandwidth	5MHz / 10MHz
Maximum Output Power to Antenna	Main Antenna : 20.06 dBm (QPSK, BW 5MHz) 20.23 dBm (QPSK, BW 10MHz) 19.99 dBm (16QAM, BW 5MHz) 20.19 dBm (16QAM, BW 10MHz) Aux. Antenna : 20.13 dBm (QPSK, BW 5MHz) 20.07 dBm (QPSK, BW 10MHz) 20.09 dBm (16QAM, BW 5MHz) 20.00 dBm (16QAM, BW 10MHz)
Maximum EIRP	0.13 W (20.99 dBm) (QPSK, BW 5MHz) 0.07 W (18.65 dBm) (QPSK, BW 10MHz) 0.13 W (21.15 dBm) (16QAM, BW 5MHz) 0.07 W (18.65 dBm) (16QAM, BW 10MHz)
Antenna Type	PCB Antenna
HW Version	MT7118
SW Version	UT235 BasicCM1_12 V3_7_10_3
Type of Modulation	Uplink : OFDMA (QPSK / 16QAM / 64QAM)
Type of Emission	4M48G7D (QPSK, BW 5MHz) 9M12G7D (QPSK, BW 10MHz) 4M48W7D (16QAM, BW 5MHz) 9M12W7D (16QAM, BW 10MHz)
EUT Stage	Production Unit

Remark:

1. This test report recorded only product characteristics and test results of Licensed Non-Broadcast Station Transmitter (TNB).
2. The above EUT's information was declared by manufacturer. Please refer to the specifications or user's manual for more detailed description.

1.4 Testing Site

Test Site	SPORTON INTERNATIONAL INC.		
Test Site Location	No. 52, Hwa Ya 1 st Rd., Hwa Ya Technology Park, Kwei-Shan Hsiang, Tao Yuan Hsien, Taiwan, R.O.C. TEL: +886-3-327-3456 FAX: +886-3-328-4978		
Test Site No.	Sporton Site No.		FCC / IC Registration No.
	TH02-HY	03CH07-HY	722060/4086B-1

1.5 Applied Standards

According to the specifications of the manufacturer, the EUT must comply with the requirements of the following standards:

- ♦ 47 CFR Part 2, 27(M)
- ♦ ANSI C63.4-2003
- ♦ ANSI TIA-603-C-2004

Remark:

1. All test items were verified and recorded according to the standards and without any deviation during the test.
2. This EUT has also been tested and complied with the requirements of FCC Part 15, Subpart B (DoC), recorded in a separate test report.

1.6 Ancillary Equipment List

Item	Equipment	Trade Name	Model No.	FCC ID	Data Cable	Power Cord
1.	System Simulator	Agilent	E6651A	N/A	N/A	Unshielded, 1.8 m
2.	Notebook	DELL	Vostro 1510	FCC DoC	N/A	AC I/P: Unshielded, 1.2 m DC O/P: Shielded, 1.8 m

2 Test Configuration of Equipment Under Test

2.1 Test Mode

Preliminary tests were performed in different data rate to find the worst radiated emission. The data rate shown in the table below is the worst-case rate with respect to the specific test item. Investigation has been done on all the possible configurations for searching the worst cases. The following table is a list of the test modes shown in this test report. The spurious emission measurements were carried out in semi-anechoic chamber with 3-meter test range.

Test Modes		
Band	Radiated TCs	Conducted TCs
802.16e (Modulation : OFDMA)	<ul style="list-style-type: none"> ■ QPSK, BW 5MHz Link ■ QPSK, BW 10MHz Link 	<ul style="list-style-type: none"> ■ QPSK, BW 5MHz Link ■ QPSK, BW 10MHz Link ■ 16QAM, BW 5MHz Link ■ 16QAM, BW 10MHz Link

Note: The maximum average power levels are on zone type, BAMC and coding rate, 1/2 mode for QPSK, BW 5MHz, QPSK, BW 10MHz, 16QAM, BW 5MHz, and 16QAM, BW 10MHz Link ; only these modes were used for all tests.

The conducted power tables are as follows:

Zone Type	Modulation	Coding Rate	Channel	Main Antenna			Aux. Antenna		
				Peak Power	Average Power	PAP	Peak Power	Average Power	PAP
PUSC	QPSK (BW 5MHz)	1/2	Low	32.99	19.72	13.27	31.98	19.13	12.85
			Middle	32.48	19.35	13.13	32.83	19.77	13.06
			High	31.94	20.02	11.92	32.83	20.13	12.70
		3/4	Low	32.39	19.65	12.74	31.91	19.24	12.67
			Middle	31.74	19.30	12.44	32.62	19.74	12.88
			High	32.38	20.06	12.32	32.52	20.09	12.43
	16QAM (BW 5MHz)	1/2	Low	32.36	19.80	12.56	32.42	19.47	12.95
			Middle	32.29	19.44	12.85	33.00	19.67	13.33
			High	32.26	19.99	12.27	32.60	20.09	12.51
		3/4	Low	32.27	19.47	12.80	31.96	19.01	12.95
			Middle	32.15	19.21	12.94	32.56	19.57	12.99
			High	32.56	19.90	12.66	32.44	19.92	12.52
	QPSK (BW 10MHz)	1/2	Low	32.37	19.14	13.23	32.76	19.24	13.52
			Middle	32.70	19.45	13.25	32.53	19.52	13.01
			High	33.50	20.23	13.27	32.99	20.07	12.92
		3/4	Low	32.52	19.14	13.38	32.70	19.21	13.49
			Middle	32.96	19.41	13.55	32.74	19.40	13.34
			High	33.44	20.22	13.22	32.75	20.00	12.75
	16QAM (BW 10MHz)	1/2	Low	32.57	19.16	13.41	32.15	19.19	12.96
			Middle	32.31	19.42	12.89	32.93	19.61	13.32
			High	33.23	20.19	13.04	32.91	20.00	12.91
		3/4	Low	32.35	19.02	13.33	32.34	19.06	13.28
			Middle	33.09	19.27	13.82	32.49	19.52	12.97
			High	33.61	20.05	13.56	32.74	19.85	12.89

Note: PAR = Peak to Average Ratio

2.2 Connection Diagram of Test System

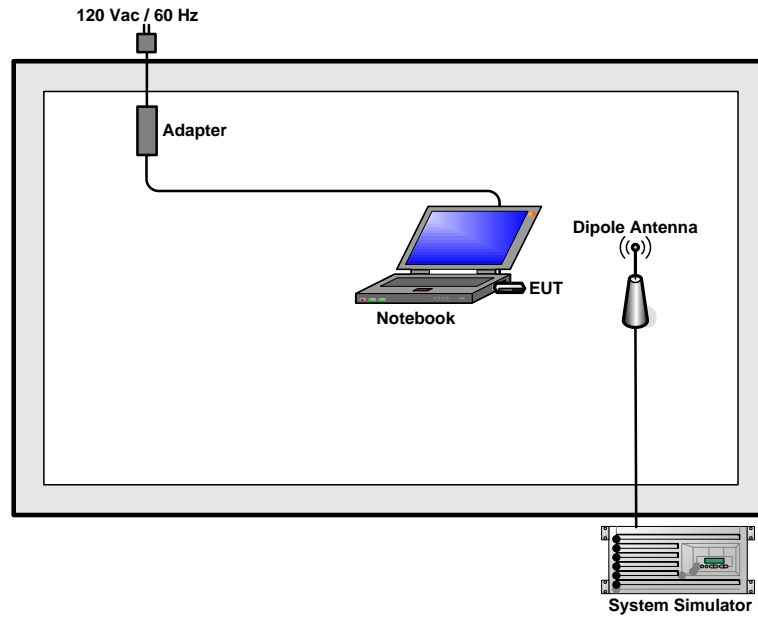

3 Test Result

3.1 Maximum Output Power, Band Edge, and Effective Isotropic Radiated Power Measurement

3.1.1 Limit

For mobile and other user stations, mobile stations are limited to 2.0 watts EIRP and all user stations are limited to 2.0 watts transmitter output power. The power of any emission outside of the authorized operating frequency ranges must be attenuated below the transmitting power (p) by a factor of mobile digital stations, the attenuation factor shall be not less than $43 + 10 \log (p)$ dB at the channel edge and $55 + 10 \log (p)$ dB at 5.5 MHz from the channel edges.

3.1.2 Measuring Instruments

See list of measuring instruments of this test report.

3.1.3 Test Procedures

For Conducted Power and Band Edge Measurement:

The RF output of the transmitter was connected to the input of the spectrum analyzer through sufficient attenuation.

For Effective Isotropic Radiated Power Measurement:

1. The EUT was placed on a non-conductive rotating platform with 0.8 meter height in a semi-anechoic chamber. The radiated emission at the fundamental frequency was measured at 3 m.
2. During the measurement, the EUT was enforced in maximum power. The highest emission was recorded from analyzer power level (LVL) from the 360 degrees rotation of the turntable and the test antenna raised and lowered over a range from 1 to 4 meters in both horizontally and vertically polarized orientations.
3. Effective Isotropic Radiated Power (EIRP) was measured by substitution method according to TIA/EIA-603-C. The EUT was replaced by dipole antenna (substitution antenna) at same location, and then a known power from S.G. was applied into the dipole antenna through a Tx cable, and then recorded the maximum Analyzer reading through raised and lowered the test antenna. The correction factor (in dB) = S.G. - Tx Cable loss + Substitution antenna gain - Analyzer reading. Then the EUT's EIRP was calculated with the correction factor, $EIRP = LVL + \text{Correction factor}$.

3.1.4 Test Setup

<Conducted Power and Band Edge Measurement>

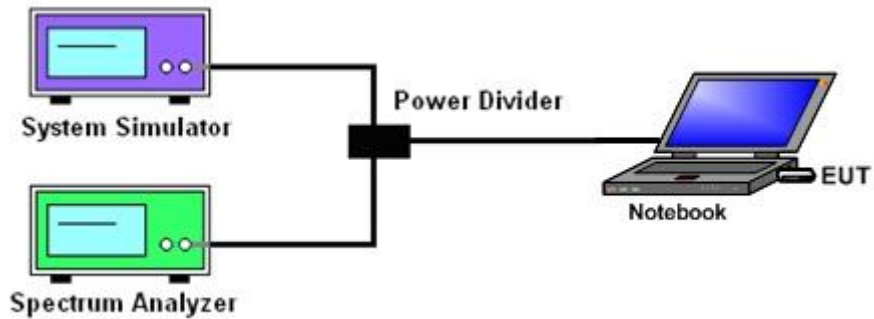

<Effective Isotropic Radiated Power Measurement>

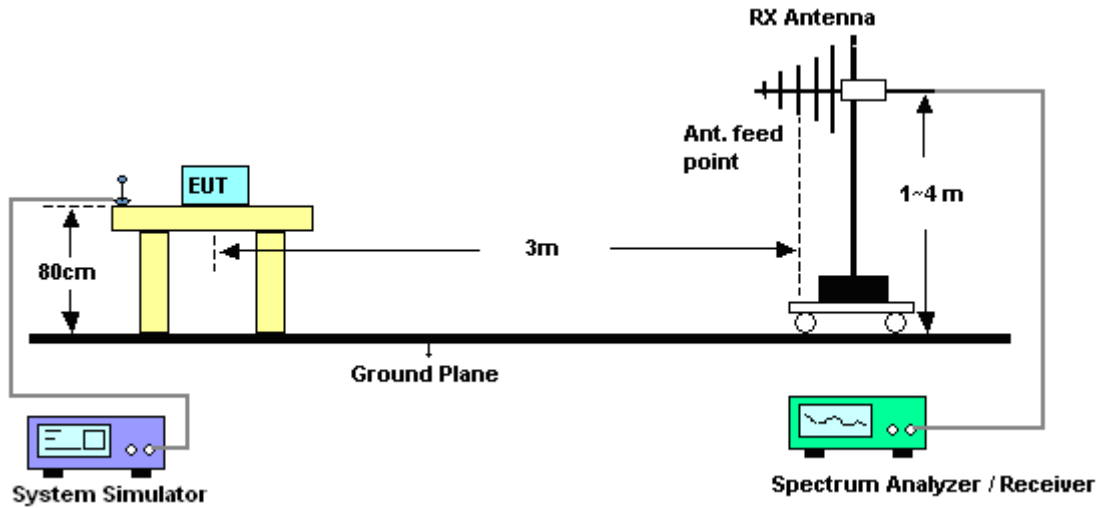



3.1.5 Test Result of Maximum Output Power

Channel	Modulation Type	Zone Type	Coding Rate	5MHz Bandwidth			10MHz Bandwidth		
				Peak Power	Average Power	PAR	Peak Power	Average Power	PAR
Low	QPSK	BAMC	1/2	31.98	19.13	12.85	32.37	19.14	13.23
Middle	QPSK	BAMC	1/2	32.83	19.77	13.06	32.70	19.45	13.25
High	QPSK	BAMC	1/2	32.83	20.13	12.70	33.50	20.23	13.27

Note: PAR = Peak to Average Ratio

Channel	Modulation Type	Zone Type	Coding Rate	5MHz Bandwidth			10MHz Bandwidth		
				Peak Power	Average Power	PAR	Peak Power	Average Power	PAR
Low	16QAM	BAMC	1/2	32.42	19.47	12.95	32.57	19.16	13.41
Middle	16QAM	BAMC	1/2	33.00	19.67	13.33	32.31	19.42	12.89
High	16QAM	BAMC	1/2	32.60	20.09	12.51	33.23	20.19	13.04

Note: PAR = Peak to Average Ratio



3.1.6 Test Result of Band Edge Measurement

Band :	802.16e	Power Stage :	High
Test Mode :	QPSK, BW 5MHz		

Band Edge Plot on Low Channel

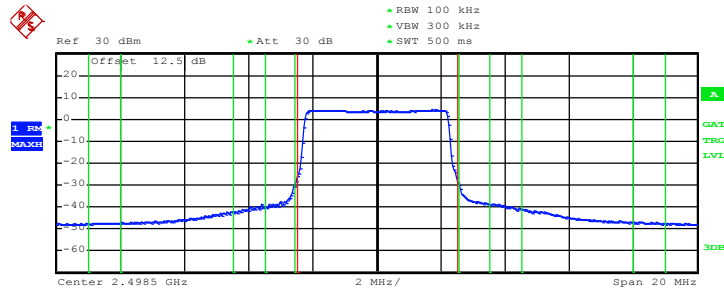

Tx Channel		USER (PART27-5)	
Bandwidth	5 MHz	Power	20.06 dBm
Adjacent Channel		Lower	-31.90 dBm
Bandwidth	50 kHz	Upper	-30.66 dBm
Spacing	2.525 MHz		
Alternate Channel		Lower	-31.37 dBm
Bandwidth	1 MHz	Upper	-29.93 dBm
Spacing	4 MHz		
2nd Alternate Channel		Lower	-37.84 dBm
Bandwidth	1 MHz	Upper	-37.61 dBm
Spacing	8.5 MHz		

Bandedge limit: -13dBm

Bandedge limit: -13dBm

Bandedge limit: -25dBm

Date: 13.APR.2011 12:49:08

Band Edge Plot on High Channel

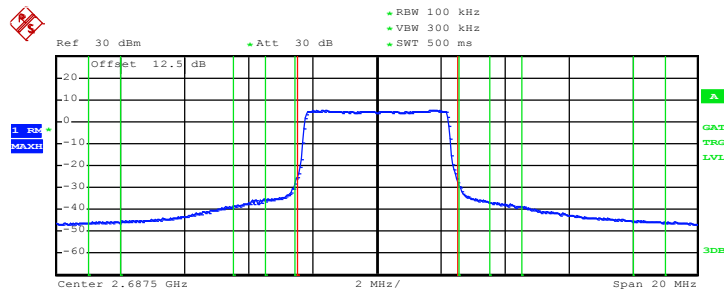

Tx Channel		USER (PART27-5)	
Bandwidth	5 MHz	Power	20.74 dBm
Adjacent Channel		Lower	-29.85 dBm
Bandwidth	50 kHz	Upper	-29.80 dBm
Spacing	2.525 MHz		
Alternate Channel		Lower	-27.42 dBm
Bandwidth	1 MHz	Upper	-27.92 dBm
Spacing	4 MHz		
2nd Alternate Channel		Lower	-36.25 dBm
Bandwidth	1 MHz	Upper	-35.93 dBm
Spacing	8.5 MHz		

Bandedge limit: -13dBm

Bandedge limit: -13dBm

Bandedge limit: -25dBm

Date: 13.APR.2011 13:01:46



Band :	802.16e	Power Stage :	High
Test Mode :	QPSK, BW 10MHz		

Edge Plot on Low Channel

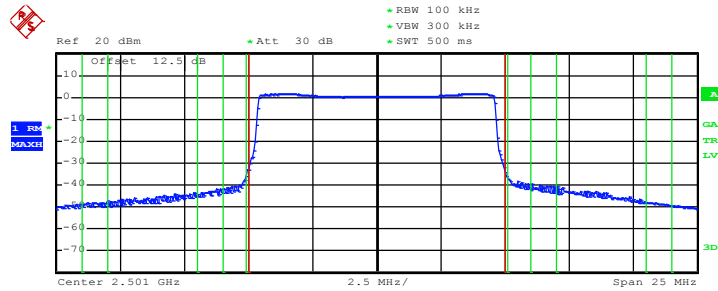

Tx Channel	Bandwidth 10 MHz	Power	20.20 dBm
Adjacent Channel	Bandwidth 100 kHz	Lower	-34.84 dBm
	Spacing 5.05 MHz	Upper	-35.14 dBm
Alternate Channel	Bandwidth 1 MHz	Lower	-33.75 dBm
	Spacing 6.5 MHz	Upper	-31.65 dBm
2nd Alternate Channel	Bandwidth 1 MHz	Lower	-39.15 dBm
	Spacing 11 MHz	Upper	-38.53 dBm

Bandedge limit: -13dBm
 Bandedge limit: -13dBm
 Bandedge limit: -25dBm

Date: 13.APR.2011 16:52:04

Band Edge Plot on High Channel

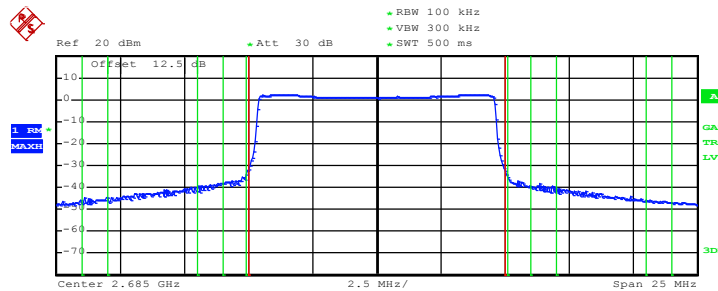

Tx Channel	Bandwidth 10 MHz	Power	20.87 dBm
Adjacent Channel	Bandwidth 100 kHz	Lower	-33.90 dBm
	Spacing 5.05 MHz	Upper	-33.83 dBm
Alternate Channel	Bandwidth 1 MHz	Lower	-29.84 dBm
	Spacing 6.5 MHz	Upper	-30.54 dBm
2nd Alternate Channel	Bandwidth 1 MHz	Lower	-36.44 dBm
	Spacing 11 MHz	Upper	-36.53 dBm

Bandedge limit: -13dBm
 Bandedge limit: -13dBm
 Bandedge limit: -25dBm

Date: 13.APR.2011 17:07:35



Band :	802.16e	Power Stage :	High
Test Mode :	16QAM, BW 5MHz		

Band Edge Plot on Low Channel

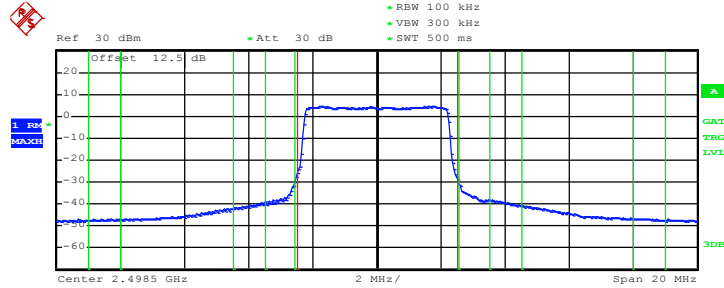

Tx Channel		USER (PART27-5)	
Bandwidth	5 MHz	Power	20.13 dBm
Adjacent Channel		Lower	-31.34 dBm
Bandwidth	50 kHz	Upper	-31.69 dBm
Spacing	2.525 MHz		
Alternate Channel		Lower	-31.25 dBm
Bandwidth	1 MHz	Upper	-29.71 dBm
Spacing	4 MHz		
2nd Alternate Channel		Lower	-37.59 dBm
Bandwidth	1 MHz	Upper	-37.38 dBm
Spacing	8.5 MHz		

Bandedge limit: -13dBm
Bandedge limit: -13dBm
Bandedge limit: -25dBm

Date: 13.APR.2011 12:54:17

Band Edge Plot on High Channel

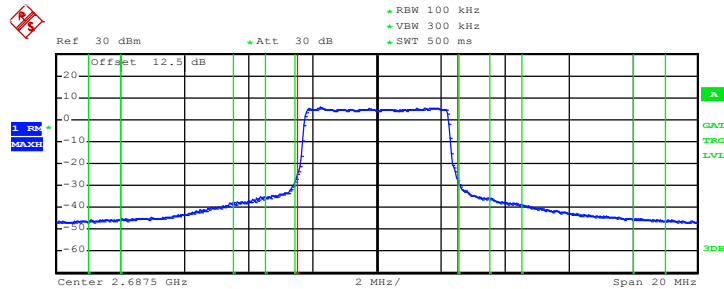

Tx Channel		USER (PART27-5)	
Bandwidth	5 MHz	Power	20.82 dBm
Adjacent Channel		Lower	-30.44 dBm
Bandwidth	50 kHz	Upper	-30.59 dBm
Spacing	2.525 MHz		
Alternate Channel		Lower	-27.34 dBm
Bandwidth	1 MHz	Upper	-27.91 dBm
Spacing	4 MHz		
2nd Alternate Channel		Lower	-36.32 dBm
Bandwidth	1 MHz	Upper	-36.10 dBm
Spacing	8.5 MHz		

Bandedge limit: -13dBm
Bandedge limit: -13dBm
Bandedge limit: -25dBm

Date: 13.APR.2011 12:56:34



Band :	802.16e	Power Stage :	High
Test Mode :	16QAM, BW 10MHz		

Band Edge Plot on Low Channel

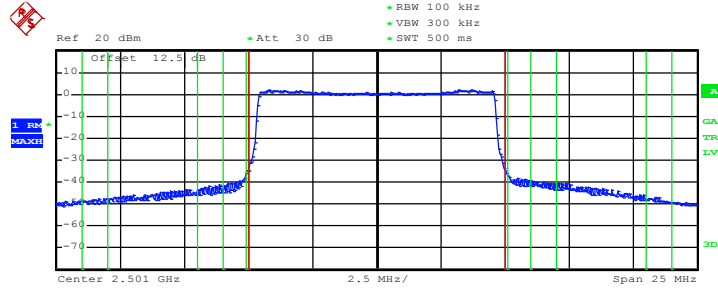

Tx Channel		USER (PART27-10)	
Bandwidth	10 MHz	Power	20.29 dBm
Adjacent Channel		Lower	-36.26 dBm
Bandwidth	100 kHz	Upper	-35.72 dBm
Spacing	5.05 MHz		
Alternate Channel		Lower	-33.66 dBm
Bandwidth	1 MHz	Upper	-31.43 dBm
Spacing	6.5 MHz		
2nd Alternate Channel		Lower	-39.02 dBm
Bandwidth	1 MHz	Upper	-38.44 dBm
Spacing	11 MHz		

Bandedge limit: -13dBm
 Bandedge limit: -13dBm
 Bandedge limit: -25dBm

Date: 13.APR.2011 16:51:30

Band Edge Plot on High Channel

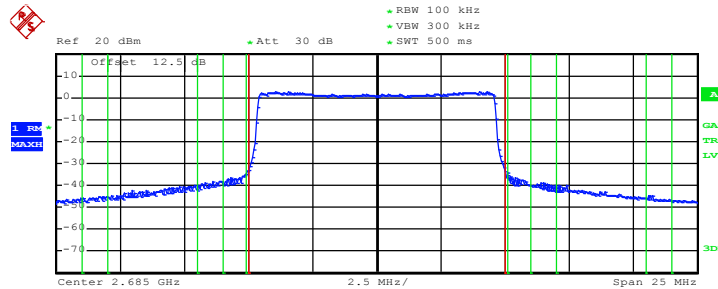

Tx Channel		USER (PART27-10)	
Bandwidth	10 MHz	Power	20.90 dBm
Adjacent Channel		Lower	-34.36 dBm
Bandwidth	100 kHz	Upper	-34.36 dBm
Spacing	5.05 MHz		
Alternate Channel		Lower	-30.05 dBm
Bandwidth	1 MHz	Upper	-30.60 dBm
Spacing	6.5 MHz		
2nd Alternate Channel		Lower	-36.48 dBm
Bandwidth	1 MHz	Upper	-36.46 dBm
Spacing	11 MHz		

Bandedge limit: -13dBm
 Bandedge limit: -13dBm
 Bandedge limit: -25dBm

Date: 13.APR.2011 17:06:54

3.1.7 Test Result of Effective Isotropic Radiated Power

802.16e (QPSK, BW 5MHz) Radiated Power (EIRP)				
Horizontal Polarization				
Channel	LVL (dBm)	Correction Factor (dB)	EIRP (dBm)	EIRP (W)
Low	-31.07	43.85	12.78	0.02
Middle	-29.61	44.06	14.45	0.03
High	-29.48	44.26	14.78	0.03
Vertical Polarization				
Channel	LVL (dBm)	Correction Factor (dB)	EIRP (dBm)	EIRP (W)
Low	-27.39	45.55	18.16	0.07
Middle	-25.73	46.72	20.99	0.13
High	-27.22	45.48	18.26	0.07

802.16e (QPSK, BW 10MHz) Radiated Power (EIRP)				
Horizontal Polarization				
Channel	LVL (dBm)	Correction Factor (dB)	EIRP (dBm)	EIRP (W)
Low	-30.78	43.85	13.07	0.02
Middle	-31.19	44.06	12.87	0.02
High	-30.02	44.26	14.24	0.03
Vertical Polarization				
Channel	LVL (dBm)	Correction Factor (dB)	EIRP (dBm)	EIRP (W)
Low	-29.42	45.55	16.13	0.04
Middle	-28.07	46.72	18.65	0.07
High	-27.95	45.48	17.53	0.06



802.16e (16QAM, BW 5MHz) Radiated Power (EIRP)				
Horizontal Polarization				
Channel	LVL (dBm)	Correction Factor (dB)	EIRP (dBm)	EIRP (W)
Low	-31.11	43.85	12.74	0.02
Middle	-29.54	44.06	14.52	0.03
High	-29.54	44.26	14.72	0.03
Vertical Polarization				
Channel	LVL (dBm)	Correction Factor (dB)	EIRP (dBm)	EIRP (W)
Low	-27.36	45.55	18.19	0.07
Middle	-25.57	46.72	21.15	0.13
High	-27.17	45.48	18.31	0.07

802.16e (16QAM, BW 10MHz) Radiated Power (EIRP)				
Horizontal Polarization				
Channel	LVL (dBm)	Correction Factor (dB)	EIRP (dBm)	EIRP (W)
Low	-30.79	43.85	13.06	0.02
Middle	-31.26	44.06	12.80	0.02
High	-30.01	44.26	14.25	0.03
Vertical Polarization				
Channel	LVL (dBm)	Correction Factor (dB)	EIRP (dBm)	EIRP (W)
Low	-29.41	45.55	16.14	0.04
Middle	-28.07	46.72	18.65	0.07
High	-28.01	45.48	17.47	0.06

3.2 Emission Bandwidth

3.2.1 Description of Emission Bandwidth Measurement

The emission bandwidth is defined as the width of the signal between two points, located at the 2 sides of the carrier frequency, outside of which all emissions are attenuated at least 26 dB below the transmitter power. The designated emission bandwidth using a resolution bandwidth of at least 1% of the emission bandwidth of the fundamental emission and a video bandwidth is more than resolution bandwidth.

3.2.2 Measuring Instruments

See list of measuring instruments of this test report.

3.2.3 Test Procedures

1. The EUT was connected to Spectrum Analyzer and System Simulator via power divider.
2. The 99% and 26 dB occupied bandwidth (BW) of the middle channel for the highest RF powers were measured.

3.2.4 Test Setup

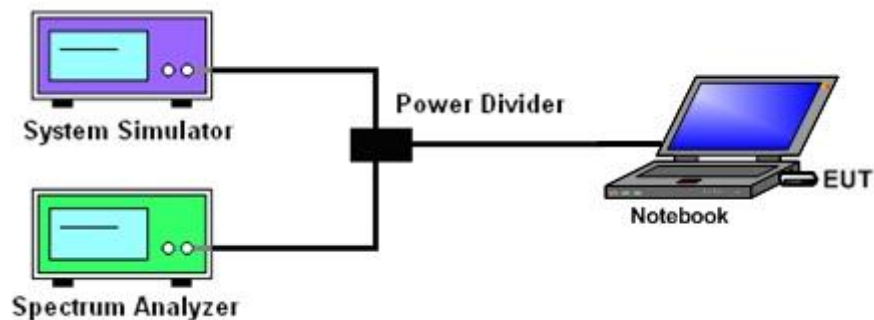



3.2.5 Test Result of Emission Bandwidth

Band :	802.16e	Power Stage :	High
Test Mode :	QPSK, BW 5MHz		

99% Occupied Bandwidth Plot on Middle Channel

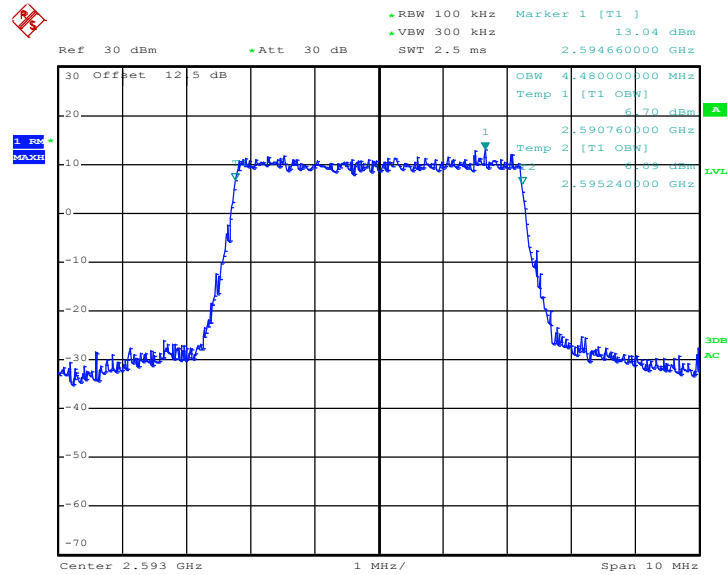

Date: 17.MAR.2011 14:29:23

26dB Bandwidth Plot on Middle Channel

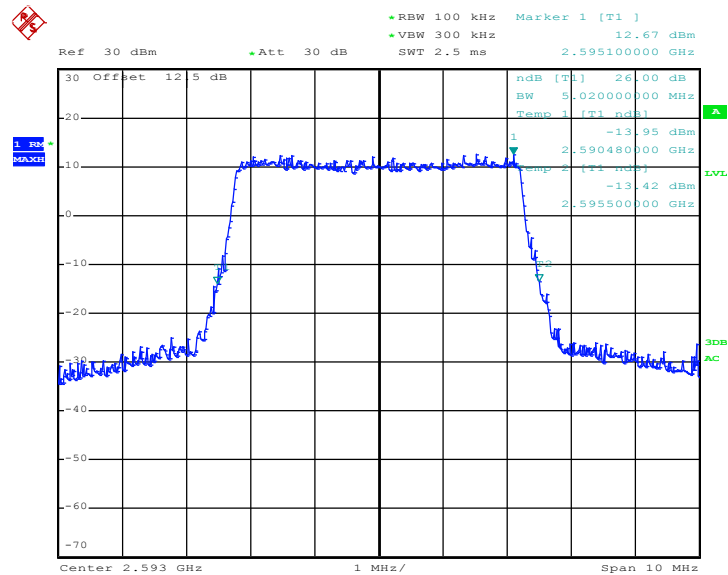

Date: 17.MAR.2011 14:32:57



Band :	802.16e	Power Stage :	High
Test Mode :	QPSK, BW 10MHz		

99% Occupied Bandwidth Plot on Middle Channel

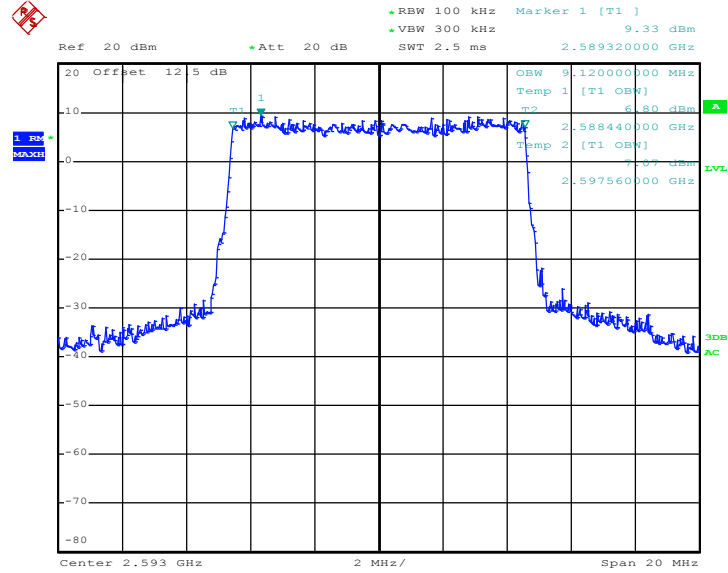

Date: 17.MAR.2011 10:27:03

26dB Bandwidth Plot on Middle Channel

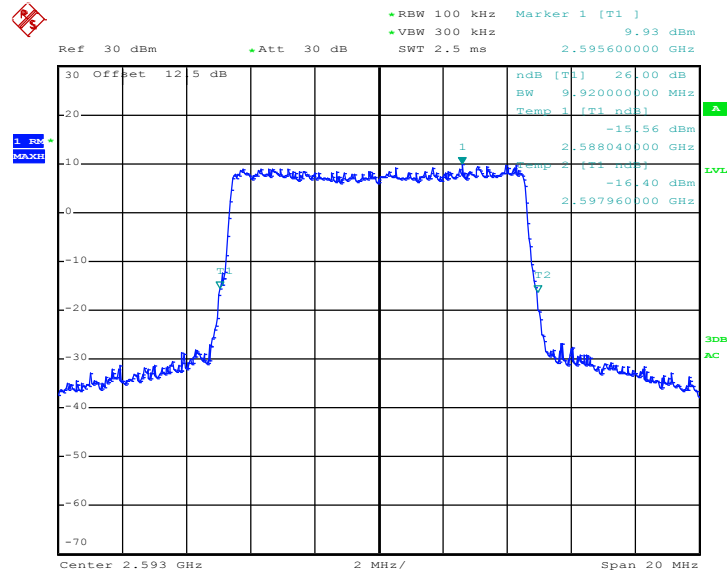

Date: 17.MAR.2011 11:02:20



Band :	802.16e	Power Stage :	High
Test Mode :	16QAM, BW 10MHz		

99% Occupied Bandwidth Plot on Middle Channel

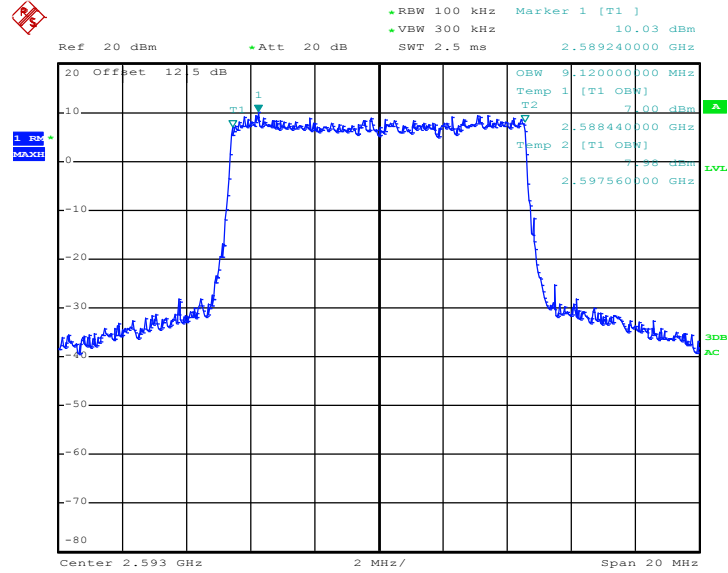

Date: 17.MAR.2011 10:26:29

26dB Bandwidth Plot on Middle Channel

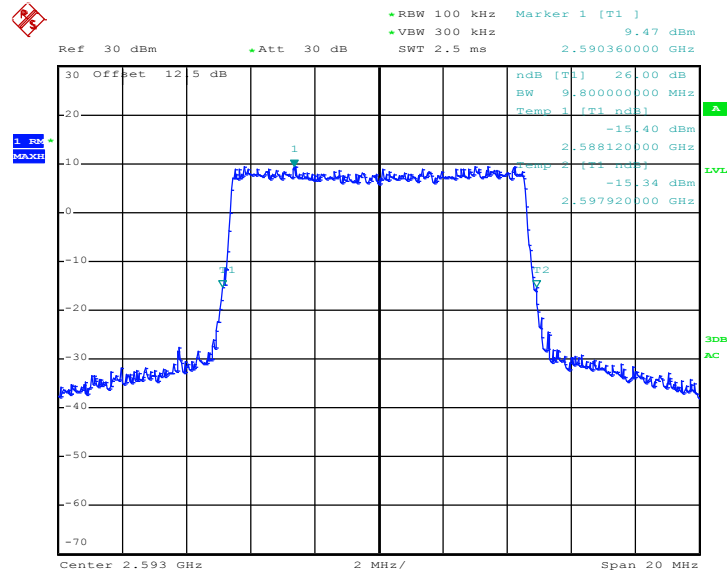

Date: 17.MAR.2011 11:00:23

3.3 Conducted Spurious Emission Measurement

3.3.1 Description of Conducted Spurious Emission Measurement

The power of any emission outside of the authorized operating frequency ranges must be lower than the transmitter power (P) by a factor of mobile digital stations, the attenuation factor shall be not less than $43 + 10 \log (P)$ dB at the channel edge and $55 + 10 \log (P)$ dB at 5.5 MHz from the channel edges. It is measured by means of a calibrated spectrum analyzer and scanned from 30 MHz up to a frequency including its 10th harmonic.

3.3.2 Measuring Instruments

See list of measuring instruments of this test report.

3.3.3 Test Procedures

1. The EUT was connected to spectrum analyzer and System Simulator via power divider.
2. The conducted spurious emission for the whole frequency range was taken.

3.3.4 Test Setup

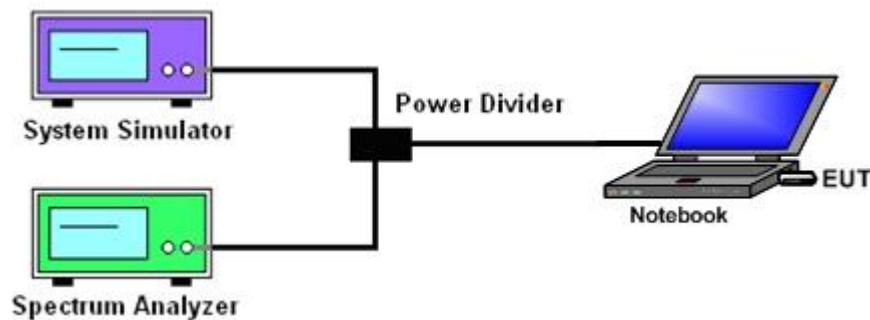

3.3.5 Test Plots of Spurious Emission

Band :	802.16e	Power Stage :	High
Test Mode :	QPSK, BW 5MHz	Channel :	Low

Conducted Spurious Emission Plot between 30MHz ~ 1GHz

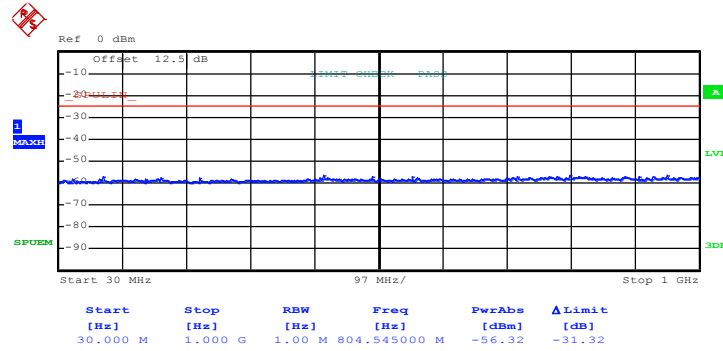

Date: 2.MAY.2011 17:52:31

Conducted Spurious Emission Plot between 1GHz ~ 27GHz

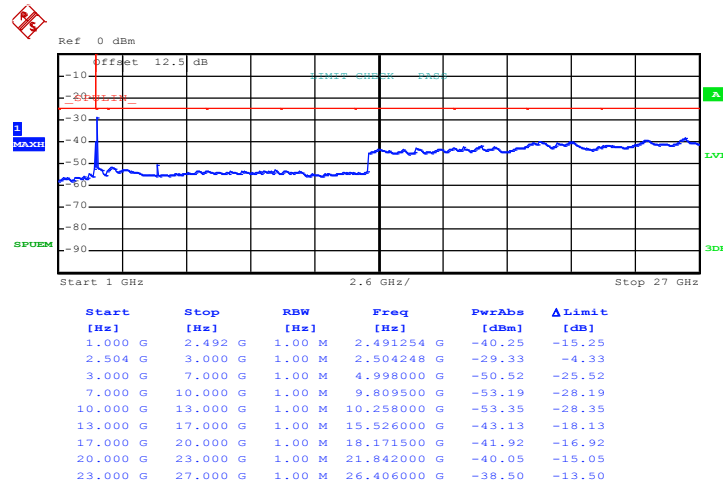

Date: 2.MAY.2011 17:43:57



Band :	802.16e	Power Stage :	High
Test Mode :	QPSK, BW 5MHz	Channel :	Middle

Conducted Spurious Emission Plot between 30MHz ~ 1GHz

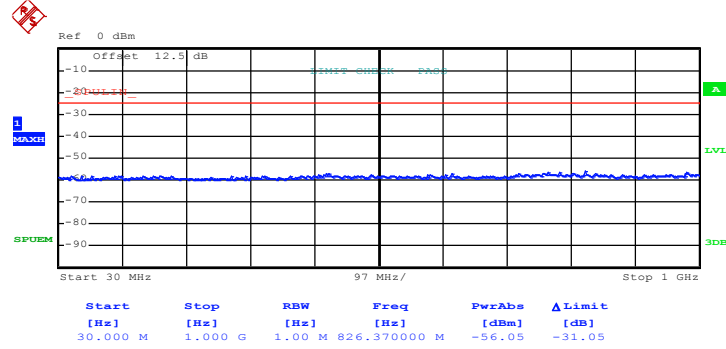

Date: 2.MAY.2011 17:52:58

Conducted Spurious Emission Plot between 1GHz ~ 27GHz

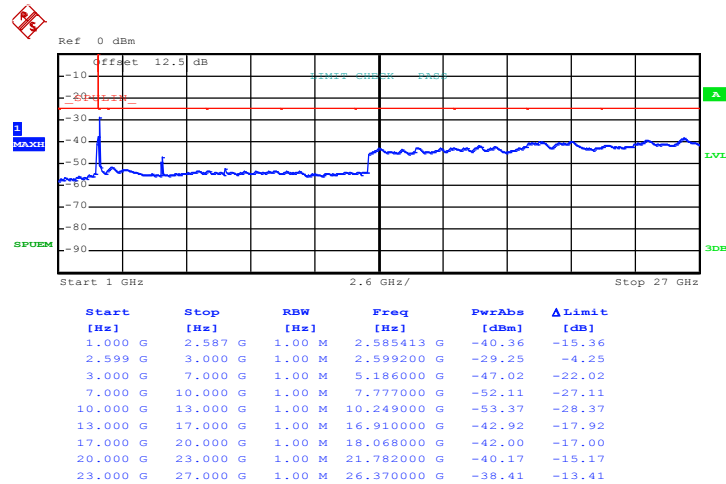

Date: 2.MAY.2011 17:36:27



Band :	802.16e	Power Stage :	High
Test Mode :	QPSK, BW 5MHz	Channel :	High

Conducted Spurious Emission Plot between 30MHz ~ 1GHz

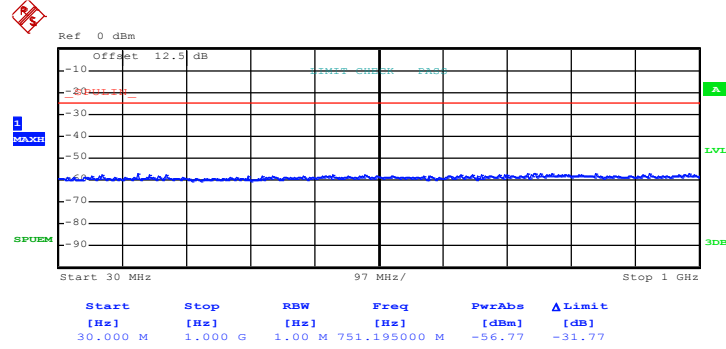

Date: 2.MAY.2011 17:54:04

Conducted Spurious Emission Plot between 1GHz ~ 27GHz

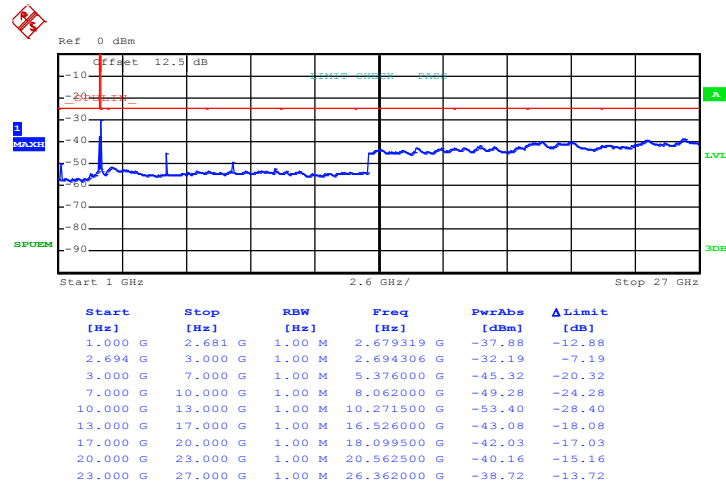

Date: 2.MAY.2011 17:41:59



Band :	802.16e	Power Stage :	High
Test Mode :	QPSK, BW 10MHz	Channel :	Low

Conducted Spurious Emission Plot between 30MHz ~ 1GHz

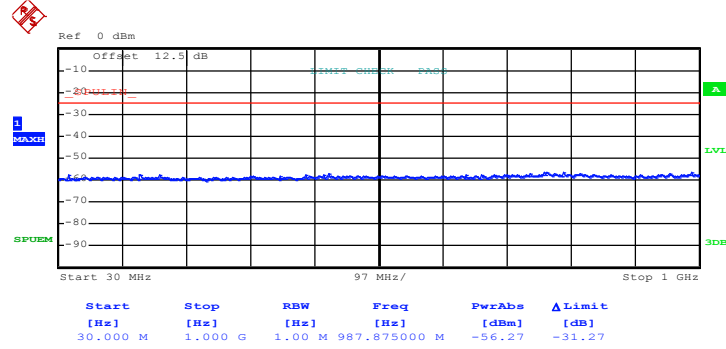

Date: 2.MAY.2011 17:55:15

Conducted Spurious Emission Plot between 1GHz ~ 27GHz

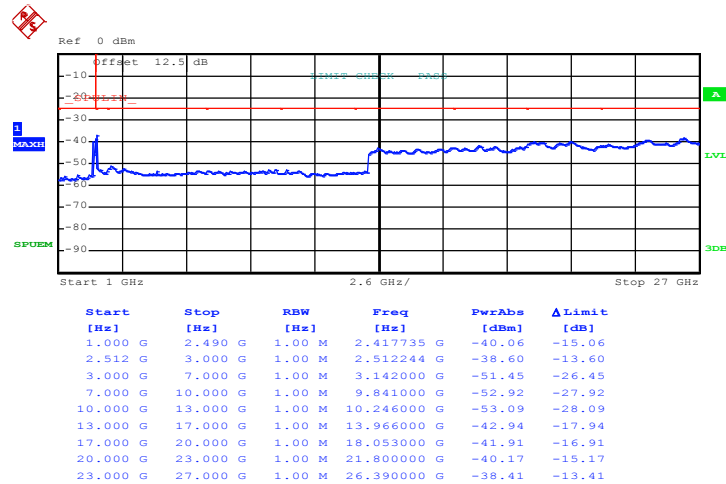

Date: 2.MAY.2011 17:29:34



Band :	802.16e	Power Stage :	High
Test Mode :	QPSK, BW 10MHz	Channel :	Middle

Conducted Spurious Emission Plot between 30MHz ~ 1GHz

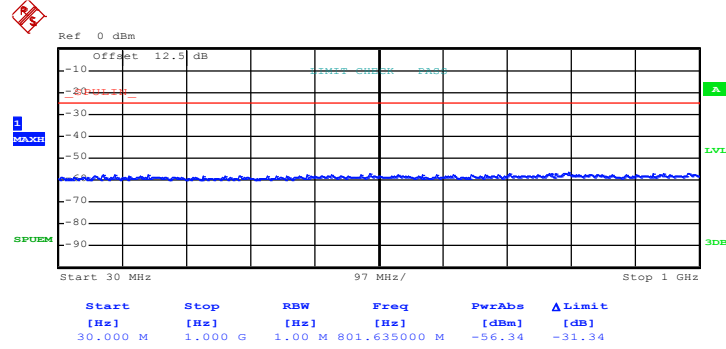

Date: 2.MAY.2011 17:55:33

Conducted Spurious Emission Plot between 1GHz ~ 27GHz

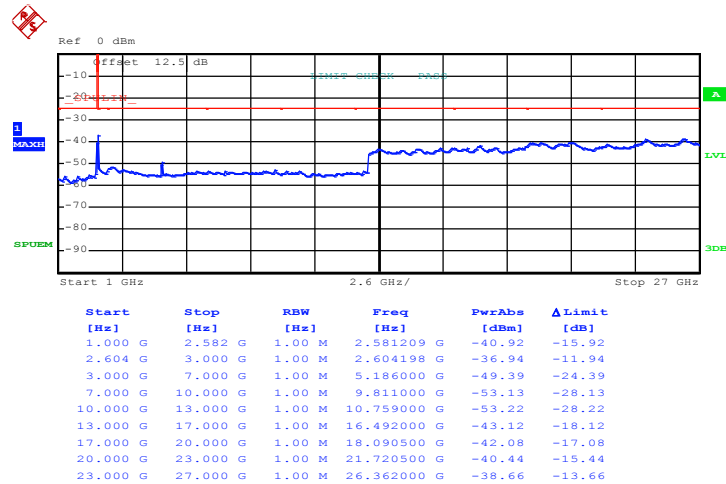

Date: 2.MAY.2011 17:33:39



Band :	802.16e	Power Stage :	High
Test Mode :	QPSK, BW 10MHz	Channel :	High

Conducted Spurious Emission Plot between 30MHz ~ 1GHz

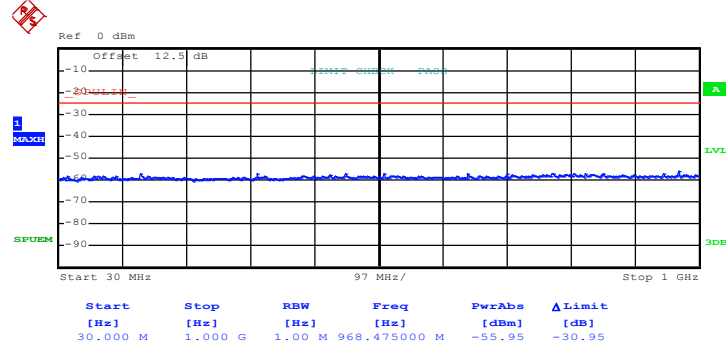

Date: 2.MAY.2011 17:54:20

Conducted Spurious Emission Plot between 1GHz ~ 27GHz

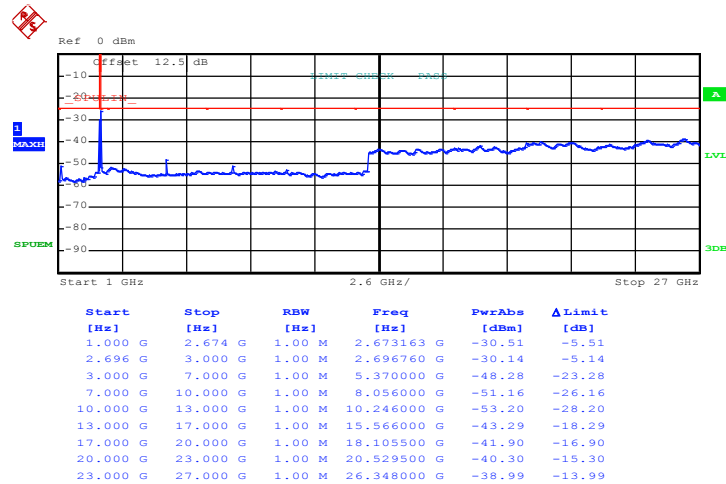

Date: 2.MAY.2011 17:27:25



Band :	802.16e	Power Stage :	High
Test Mode :	16QAM, BW 5MHz	Channel :	Low

Conducted Spurious Emission Plot between 30MHz ~ 1GHz

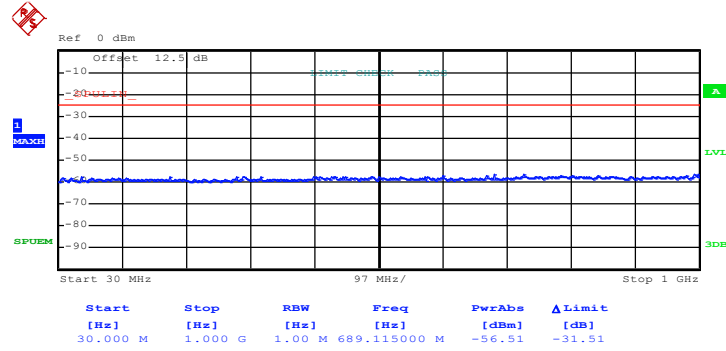

Date: 2.MAY.2011 17:52:01

Conducted Spurious Emission Plot between 1GHz ~ 27GHz

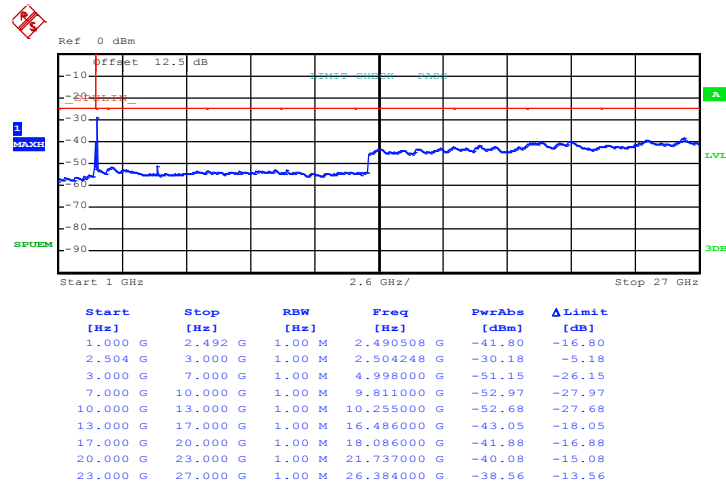

Date: 2.MAY.2011 17:45:16



Band :	802.16e	Power Stage :	High
Test Mode :	16QAM, BW 5MHz	Channel :	Middle

Conducted Spurious Emission Plot between 30MHz ~ 1GHz

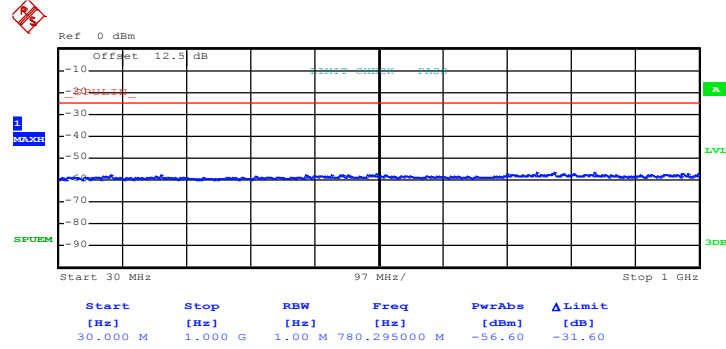

Date: 2.MAY.2011 17:53:27

Conducted Spurious Emission Plot between 1GHz ~ 27GHz

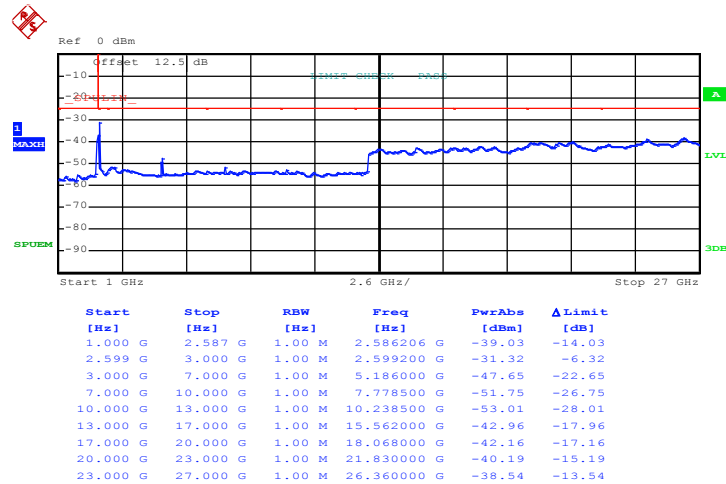

Date: 2.MAY.2011 17:37:55



Band :	802.16e	Power Stage :	High
Test Mode :	16QAM, BW 5MHz	Channel :	High

Conducted Spurious Emission Plot between 30MHz ~ 1GHz

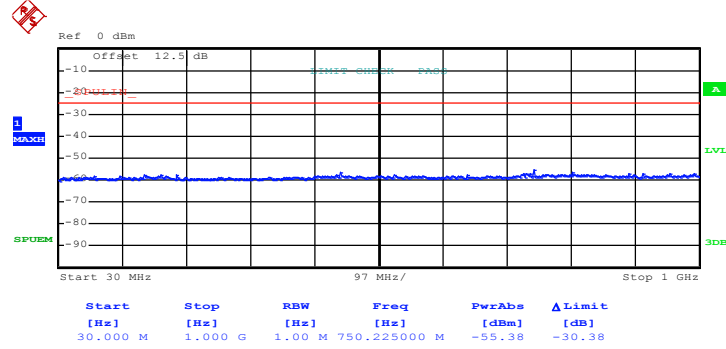

Date: 2.MAY.2011 17:53:50

Conducted Spurious Emission Plot between 1GHz ~ 27GHz

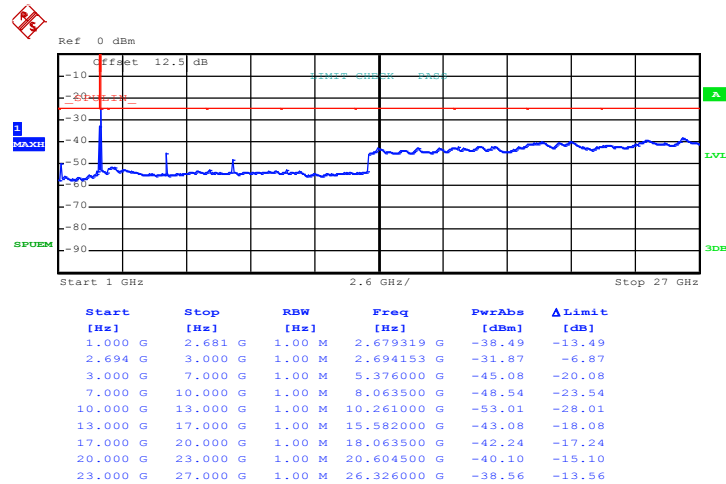

Date: 2.MAY.2011 17:41:08



Band :	802.16e	Power Stage :	High
Test Mode :	16QAM, BW 10MHz	Channel :	Low

Conducted Spurious Emission Plot between 30MHz ~ 1GHz

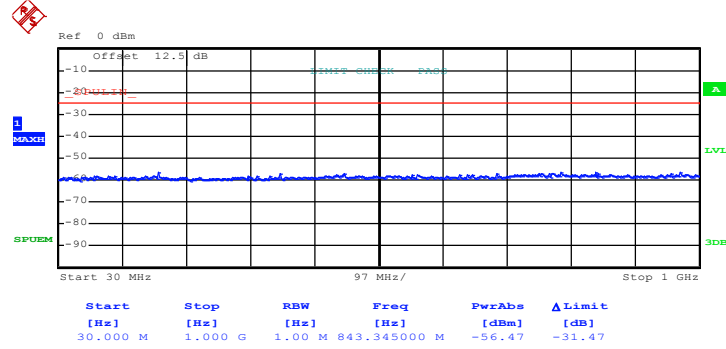

Date: 2.MAY.2011 17:54:55

Conducted Spurious Emission Plot between 1GHz ~ 27GHz



Date: 2.MAY.2011 17:30:49



Band :	802.16e	Power Stage :	High
Test Mode :	16QAM, BW 10MHz	Channel :	Middle

Conducted Spurious Emission Plot between 30MHz ~ 1GHz

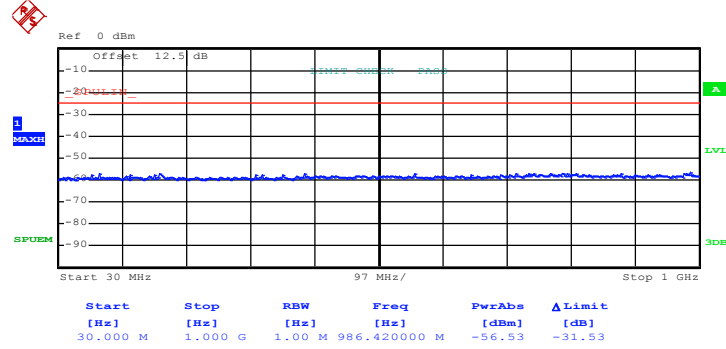

Date: 2.MAY.2011 17:55:54

Conducted Spurious Emission Plot between 1GHz ~ 27GHz

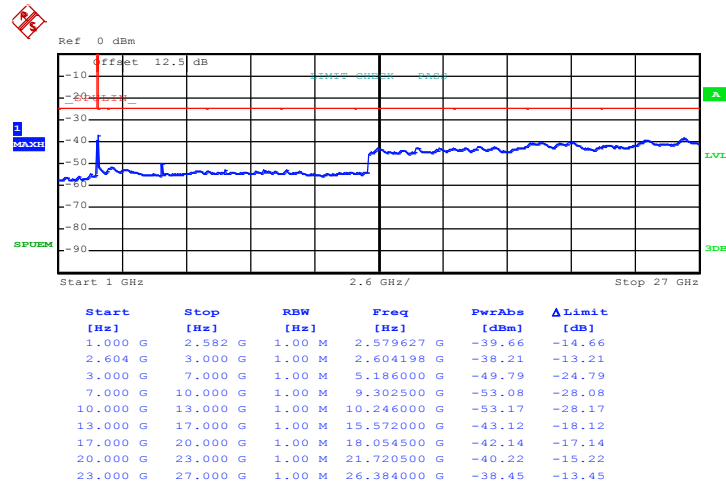

Date: 2.MAY.2011 17:32:56



Band :	802.16e	Power Stage :	High
Test Mode :	16QAM, BW 10MHz	Channel :	High

Conducted Spurious Emission Plot between 30MHz ~ 1GHz

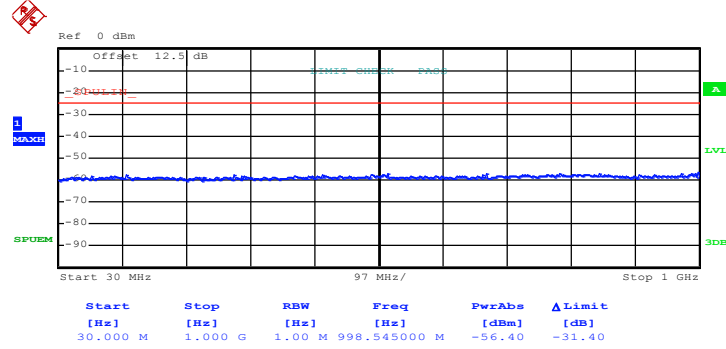

Date: 2.MAY.2011 17:54:38

Conducted Spurious Emission Plot between 1GHz ~ 27GHz

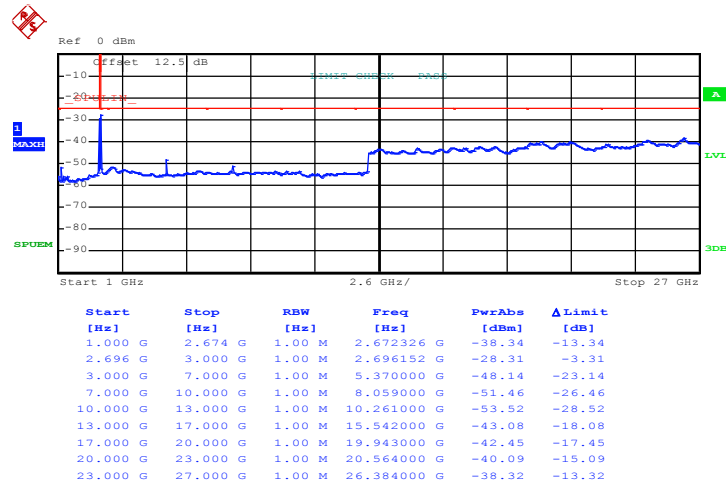

Date: 2.MAY.2011 17:26:13

3.4 Radiated Emissions Measurement

3.4.1 Description of Radiated Emissions Measurement

The power of any emission outside of the authorized operating frequency ranges must be lower than the transmitter power (P) by a factor of mobile digital stations, the attenuation factor shall be not less than $43 + 10 \log (P)$ dB at the channel edge and $55 + 10 \log (P)$ dB at 5.5 MHz from the channel edges. It is measured by means of a calibrated spectrum analyzer and scanned from 30 MHz up to a frequency including its 10th harmonic.

3.4.2 Measuring Instruments

See list of measuring instruments of this test report.

3.4.3 Test Procedures

1. The EUT was placed on a rotatable wooden table with 0.8 meter about ground.
2. The EUT was set 3 meters from the receiving antenna, which was mounted on the antenna tower.
3. The table was rotated 360 degrees to determine the position of the highest spurious emission.
4. The height of the receiving antenna is varied between one meter and four meters to search the maximum spurious emission for both horizontal and vertical polarizations.
5. Make the measurement with the spectrum analyzer's RBW = 1MHz, VBW = 1MHz, Sweep = 500ms, Taking the record of maximum spurious emission.
6. A horn antenna was substituted in place of the EUT and was driven by a signal generator.
7. Tune the output power of signal generator to the same emission level with EUT maximum spurious emission.
8. Taking the record of output power at antenna port.
9. Repeat step 7 to step 8 for another polarization.
10. Emission level (dBm) = output power + substitution Gain.

3.4.4 Test Setup

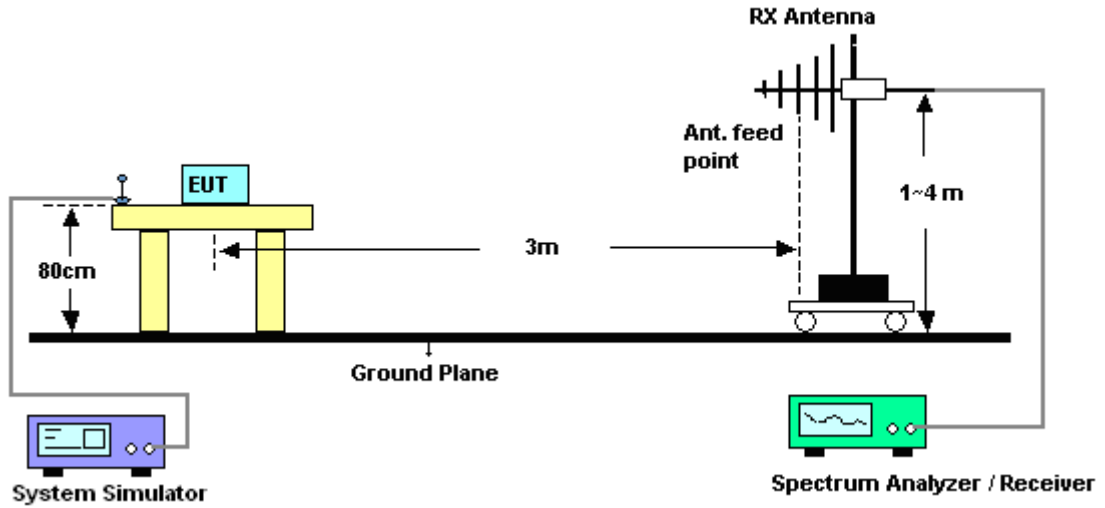



3.4.5 Test Result of Radiated Emissions

Band :	802.16e	Temperature :	21~23C
Test Mode :	QPSK, BW 5MHz, High Ch. (2687.5MHz)	Relative Humidity :	47~52%
Test Engineer :	Jason Wang	Polarization :	Horizontal
Remark :	Spurious emissions within 30-1000MHz were found more than 20dB below limit line.		

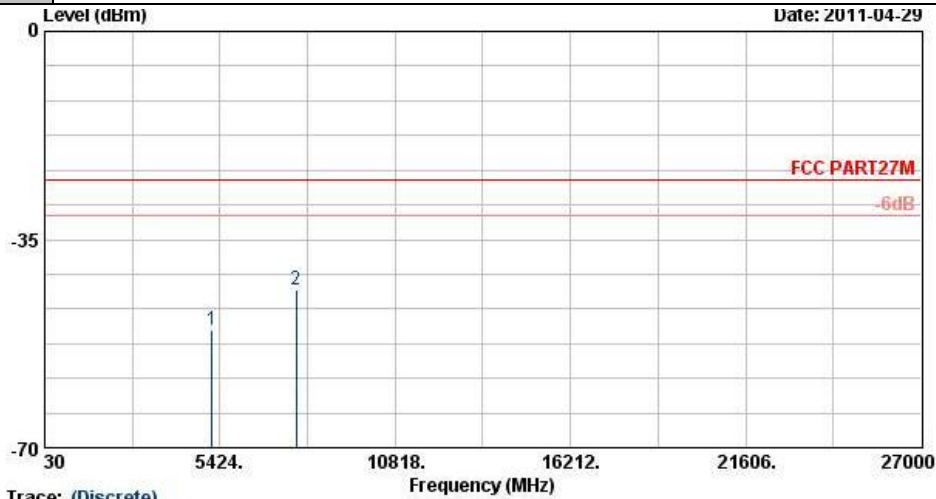

Trace: (Discrete)
 Site : D3CH07-HY
 Condition : FCC PART27M HF-ETRP(060306) HORIZONTAL
 Mode : Mode 1

Frequency (MHz)	EIRP (dBm)	Limit (dBm)	Over Limit (dB)	SPA Reading (dBm)	S.G. Power (dBm)	TX Cable loss (dB)	TX Antenna Gain (dBi)	Polarization (H/V)	Result
5186	-50.34	-25	-25.34	-69.72	-53.88	6.91	10.45	H	Pass
7779	-43.35	-25	-18.35	-69.28	-46.32	9.35	12.32	H	Pass



Band :	802.16e	Temperature :	21~23C
Test Mode :	QPSK, BW 5MHz, High Ch. (2687.5MHz)	Relative Humidity :	47~52%
Test Engineer :	Jason Wang	Polarization :	Vertical
Remark :	Spurious emissions within 30-1000MHz were found more than 20dB below limit line.		

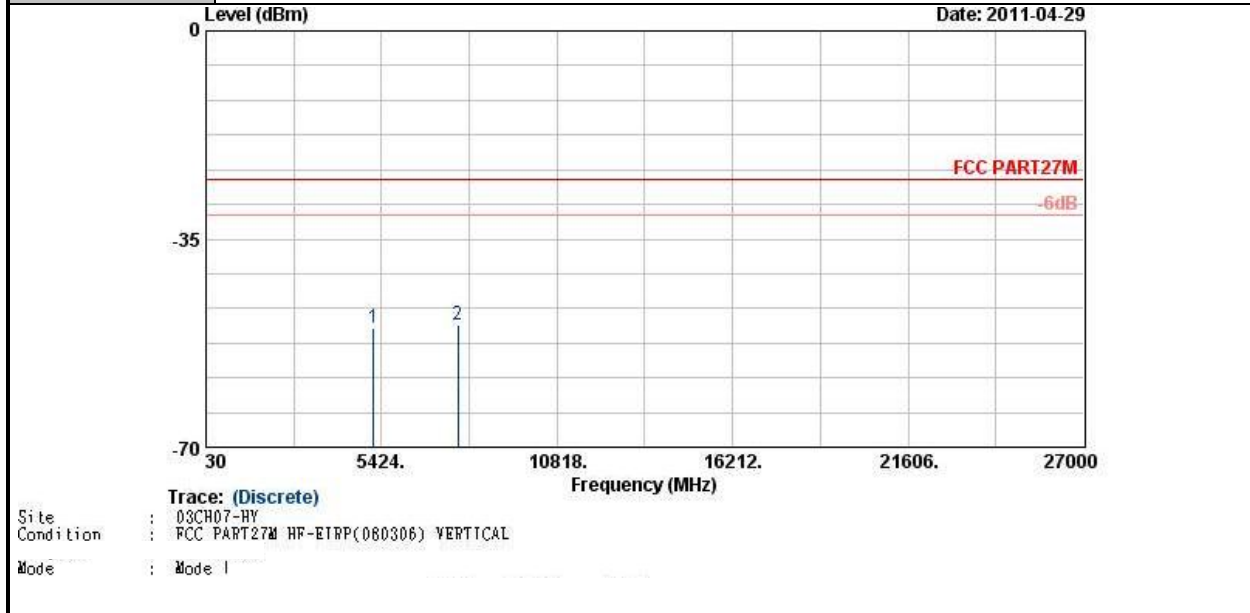

Frequency (MHz)	EIRP (dBm)	Limit (dBm)	Over Limit (dB)	SPA Reading (dBm)	S.G. Power (dBm)	TX Cable loss (dB)	TX Antenna Gain (dBi)	Polarization (H/V)	Result
5186	-49.92	-25	-24.92	-69.37	-53.46	6.91	10.45	V	Pass
7779	-49.39	-25	-24.39	-75.51	-52.36	9.35	12.32	V	Pass



Band :	802.16e	Temperature :	21~23C
Test Mode :	QPSK, BW 10MHz, High Ch. (2685MHz)	Relative Humidity :	47~52%
Test Engineer :	Jason Wang	Polarization :	Horizontal
Remark :	Spurious emissions within 30-1000MHz were found more than 20dB below limit line.		

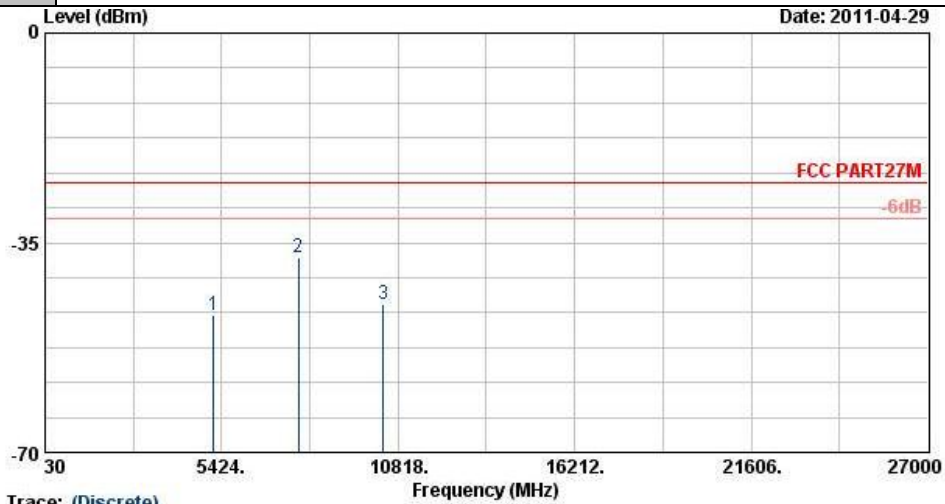

Trace: (Discrete)
 Site : 03CH07-HY
 Condition : FCC PART27M HF-EIRP(080306) HORIZONTAL
 Mode : Mode 2

Frequency (MHz)	EIRP (dBm)	Limit (dBm)	Over Limit (dB)	SPA Reading (dBm)	S.G. Power (dBm)	TX Cable loss (dB)	TX Antenna Gain (dBi)	Polarization (H/V)	Result
5186	-47.09	-25	-22.09	-66.55	-50.63	6.91	10.45	H	Pass
7779	-37.51	-25	-12.51	-63.5	-40.48	9.35	12.32	H	Pass
10372	-45.15	-25	-20.15	-74.89	-49.52	8.63	13.00	H	Pass



Band :	802.16e	Temperature :	21~23C
Test Mode :	QPSK, BW 10MHz, High Ch. (2685MHz)	Relative Humidity :	47~52%
Test Engineer :	Jason Wang	Polarization :	Vertical
Remark :	Spurious emissions within 30-1000MHz were found more than 20dB below limit line.		

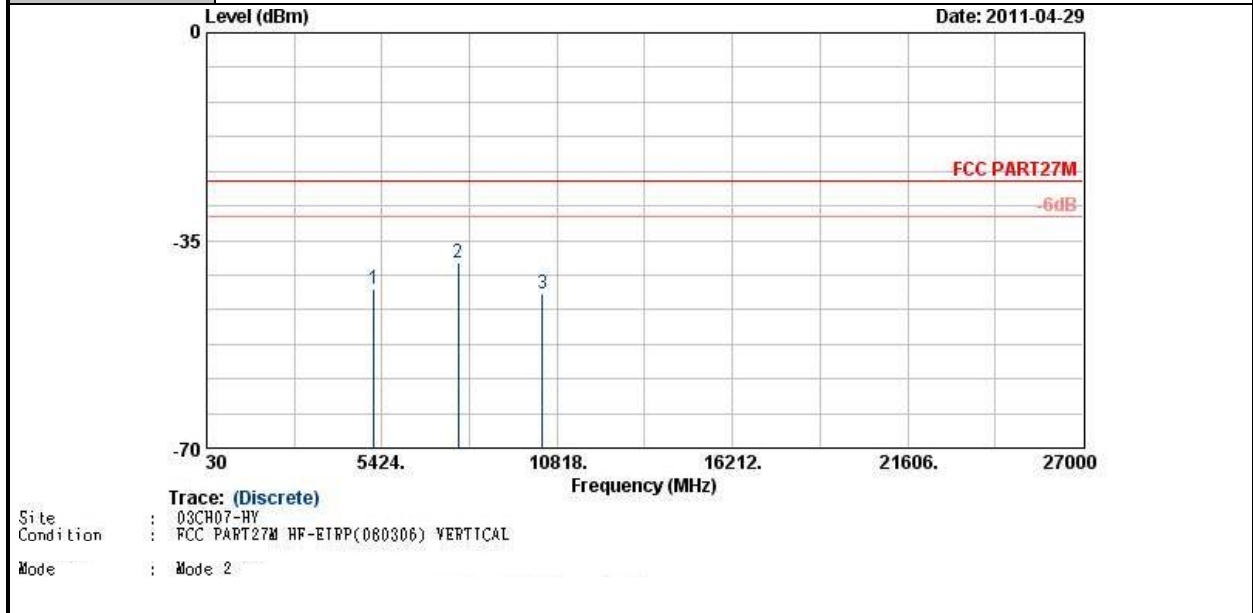

Frequency (MHz)	EIRP (dBm)	Limit (dBm)	Over Limit (dB)	SPA Reading (dBm)	S.G. Power (dBm)	TX Cable loss (dB)	TX Antenna Gain (dBi)	Polarization (H/V)	Result
5186	-43.09	-25	-18.09	-62.63	-46.63	6.91	10.45	V	Pass
7779	-38.89	-25	-13.89	-64.84	-41.86	9.35	12.32	V	Pass
10372	-44.09	-25	-19.09	-73.06	-48.46	8.63	13.00	V	Pass

3.5 Frequency Stability Measurement

3.5.1 Description of Frequency Stability Measurement

The frequency stability shall be sufficient to ensure that the fundamental emissions stay within the authorized frequency band. For equipment authorization purposes, this is a reporting requirement only.

3.5.2 Measuring Instruments

See list of measuring instruments of this test report.

3.5.3 Test Procedures for Temperature Variation

1. The EUT was set up in the thermal chamber and connected with the System Simulator.
2. With power OFF, the temperature was decreased to -30°C and the EUT was stabilized for three hours. Power was applied and the maximum change in frequency was recorded within one minute.
3. With power OFF, the temperature was raised in 10°C step up to 50°C . The EUT was stabilized at each step for at least half an hour. Power was applied and the maximum frequency change was recorded within one minute.
4. If the EUT can not be turned on at -30°C , the testing lowest temperature will be raised in 10°C step until the EUT can be turned on.

3.5.4 Test Procedures for Voltage Variation

1. The EUT was placed in a temperature chamber at $25\pm 5^{\circ}\text{C}$ and connected with the System Simulator.
2. The power supply voltage to the EUT was varied from BEP to 115% of the nominal value measured at the input to the EUT.
3. The variation in frequency was measured for the worst case.

3.5.5 Test Setup

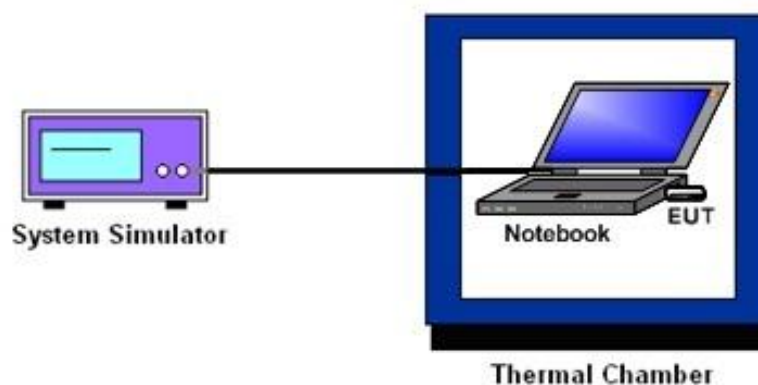

3.5.6 Test Result of Temperature Variation

Band :	802.16e	Channel :	Middle (2593MHz)
Limit (ppm) :	2.5		

Temperature (°C)	QPSK, BW 5MHz		QPSK, BW 10MHz		Result
	Freq. Dev. (Hz)	Deviation (ppm)	Freq. Dev. (Hz)	Deviation (ppm)	
-30	-24.11	-0.0093	-30.48	-0.0118	PASS
-20	-27.31	-0.0105	-32.01	-0.0123	
-10	-30.20	-0.0116	-27.05	-0.0104	
0	-23.53	-0.0091	-27.84	-0.0107	
10	-21.09	-0.0081	-22.53	-0.0087	
20	-22.07	-0.0085	-22.74	-0.0088	
30	-22.72	-0.0088	-22.85	-0.0088	
40	-23.04	-0.0089	-21.37	-0.0082	
50	-24.22	-0.0093	-21.97	-0.0085	

Note: The manufacturer declared that the EUT could work properly between temperatures 0°C~50°C.

Band :	802.16e	Channel :	Middle (2593MHz)
Limit (ppm) :	2.5		

Temperature (°C)	16QAM, BW 5MHz		16QAM, BW 10MHz		Result
	Freq. Dev. (Hz)	Deviation (ppm)	Freq. Dev. (Hz)	Deviation (ppm)	
-30	-23.79	-0.0092	-20.03	-0.0077	PASS
-20	-25.84	-0.0100	-21.25	-0.0082	
-10	-23.28	-0.0090	-22.74	-0.0088	
0	-22.71	-0.0088	-28.09	-0.0108	
10	-23.64	-0.0091	-21.44	-0.0083	
20	-26.83	-0.0103	-25.37	-0.0098	
30	-23.10	-0.0089	-19.00	-0.0073	
40	-23.85	-0.0092	-19.82	-0.0076	
50	-22.00	-0.0085	-23.04	-0.0089	

Note: The manufacturer declared that the EUT could work properly between temperatures 0°C~50°C.



3.5.7 Test Result of Voltage Variation

Band & Channel	Mode	Voltage (Volt)	Freq. Dev. (Hz)	Deviation (ppm)	Result
802.16e Middle (2593MHz)	QPSK, BW 5MHz	5	-22.93	-0.0088	PASS
		4.25	-21.01	-0.0081	
		5.75	-22.17	-0.0085	
	QPSK, BW 10MHz	5	-22.62	-0.0087	PASS
		4.25	-20.72	-0.0080	
		5.75	-21.06	-0.0081	
	16QAM, BW 5MHz	5	-19.88	-0.0077	PASS
		4.25	-24.51	-0.0095	
		5.75	-23.92	-0.0092	
	16QAM, BW 10MHz	5	-26.47	-0.0102	PASS
		4.25	-25.31	-0.0098	
		5.75	-27.86	-0.0107	

Note: Normal Voltage = 5V.

4 List of Measuring Equipments

Instrument	Manufacturer	Model No.	Serial No.	Characteristics	Calibration Date	Due Date	Remark
Spectrum Analyzer	R&S	FSP40	100055	9kHz~40GHz	Jun. 11, 2010	Jun. 10, 2011	Conducted (TH02-HY)
Power Meter	Anritsu	ML2495A	0932001	N/A	Sep. 13, 2010	Sep. 12, 2011	Conducted (TH02-HY)
Power Sensor	Anritsu	MA2411B	0846202	N/A	Sep. 14, 2010	Sep. 13, 2011	Conducted (TH02-HY)
Power Meter	Agilent	E4416A	GB41292344	N/A	Feb. 18, 2011	Feb. 17, 2012	Conducted (TH02-HY)
Power Sensor	Agilent	E9327A	US40441548	N/A	Feb. 18, 2011	Feb. 17, 2012	Conducted (TH02-HY)
Thermal Chamber	Ten Billion	TTH-D35P	TBN-930701	N/A	Jul. 30, 2010	Jul. 29, 2011	Conducted (TH02-HY)
Bilog Antenna	SCHAFFNER	CBL6111C	2726	30MHz ~ 1GHz	Oct. 31, 2010	Oct. 30, 2011	Radiation (03CH07-HY)
Spectrum Analyzer	R&S	FSP	101067	9KHz ~ 30GHz	Dec. 03, 2010	Dec. 02, 2011	Radiation (03CH07-HY)
Double Ridge Horn Antenna	ESCO	3117	00075962	1GHz ~ 18GHz	Aug. 19, 2010	Aug. 18, 2011	Radiation (03CH07-HY)
SHF-EHF Horn Antenna	SCHWARZBECK	BBHA 9170	BBHA917025 1	15GHz- 40GHz	Oct. 18, 2010	Oct. 17, 2011	Radiation (03CH07-HY)
Pre Amplifier	Agilent	8449B	3008A02362	1GHz~ 26.5GHz	Dec. 06, 2010	Dec. 05, 2011	Radiation (03CH07-HY)
Pre Amplifier	COM-POWER	PA-103A	161241	10-1000MHz.32dB. GAIN	Mar. 29, 2011	Mar. 28, 2012	Radiation (03CH07-HY)
Loop Antenna	R&S	HFH2-Z2	860004/001	9 kHz~30 MHz	Jul. 29, 2010	Jul. 28, 2011	Radiation (03CH07-HY)
WiMAX Base Station (System Simulator)	Agilent	E6651A	N/A	N/A	N/A	N/A	-

5 Uncertainty of Evaluation

Uncertainty of Radiated Emission Measurement (30 MHz ~ 1000 MHz)

Contribution	Uncertainty of X_i		$u(X_i)$
	dB	Probability Distribution	
Receiver Reading	0.41	Normal (k=2)	0.21
Antenna Factor Calibration	0.83	Normal (k=2)	0.42
Cable Loss Calibration	0.25	Normal (k=2)	0.13
Pre-Amplifier Gain Calibration	0.27	Normal (k=2)	0.14
RCV/SPA Specification	2.50	Rectangular	0.72
Antenna Factor Interpolation for Frequency	1.00	Rectangular	0.29
Site Imperfection	1.43	Rectangular	0.83
Mismatch	+0.39 / -0.41	U-Shape	0.28
Combined Standard Uncertainty $U_c(y)$	1.27		
Measuring Uncertainty for a Level of Confidence of 95% ($U = 2U_c(y)$)	2.54		

Uncertainty of Radiated Emission Measurement (1 GHz ~ 40 GHz)

Contribution	Uncertainty of X_i		$u(X_i)$	C_i	$C_i * u(X_i)$
	dB	Probability Distribution			
Receiver Reading	± 0.10	Normal (k=2)	0.10	1	0.10
Antenna Factor Calibration	± 1.70	Normal (k=2)	0.85	1	0.85
Cable Loss Calibration	± 0.50	Normal (k=2)	0.25	1	0.25
Receiver Correction	± 2.00	Rectangular	1.15	1	1.15
Antenna Factor Directional	± 1.50	Rectangular	0.87	1	0.87
Site Imperfection	± 2.80	Triangular	1.14	1	1.14
Mismatch Receiver VSWR $\Gamma_1 = 0.197$ Antenna VSWR $\Gamma_2 = 0.194$ Uncertainty = $20\text{Log}(1-\Gamma_1*\Gamma_2)$	+0.34 / -0.35	U-Shape	0.244	1	0.244
Combined Standard Uncertainty $U_c(y)$	2.36				
Measuring Uncertainty for a Level of Confidence of 95% ($U = 2U_c(y)$)	4.72				



Appendix A. Photographs of EUT

Please refer to Sporton report number EP122523 as below.