



A D T

# FCC TEST REPORT (PART 27)

**REPORT NO.:** RF980311L12

**MODEL NO.:** OS-250

**RECEIVED:** Mar. 11, 2009

**TESTED:** Mar. 19 ~ Mar. 30, 2009

**ISSUED:** Apr. 09, 2009

**APPLICANT:** Green Packet INC

**ADDRESS:** 4F, NO 53, Lane 258, Rueiguang Rd, Neihu District,  
Taipei City 114, Taiwan

**ISSUED BY:** Bureau Veritas Consumer Products Services  
(H.K.) Ltd., Taoyuan Branch

**LAB ADDRESS:** No. 47, 14th Ling, Chia Pau Tsuen, Lin Kou  
Hsiang, Taipei Hsien 244, Taiwan, R.O.C.

**TEST LOCATION:** No. 19, Hwa Ya 2nd Rd, Wen Hwa Tsuen, Kwei  
Shan Hsiang, Taoyuan Hsien 333, Taiwan, R.O.C.

This test report consists of 67 pages in total. It may be duplicated completely for legal use with the approval of the applicant. It should not be reproduced except in full, without the written approval of our laboratory. The client should not use it to claim product endorsement by TAF or any government agencies. The test results in the report only apply to the tested sample.





# TABLE OF CONTENTS

1	CERTIFICATION.....	4
2	SUMMARY OF TEST RESULTS .....	5
2.1	MEASUREMENT UNCERTAINTY.....	5
3	GENERAL INFORMATION.....	6
3.1	GENERAL DESCRIPTION OF EUT .....	6
3.2	DESCRIPTION OF TEST MODES.....	8
3.2.1	CONFIGURATION OF SYSTEM UNDER TEST .....	8
3.2.2	TEST MODE APPLICABILITY AND TESTED CHANNEL DETAIL .....	9
3.3	GENERAL DESCRIPTION OF APPLIED STANDARDS .....	11
3.4	DESCRIPTION OF SUPPORT UNITS .....	11
4	TEST TYPES AND RESULTS .....	12
4.1	OUTPUT POWER MEASUREMENT .....	12
4.1.1	LIMITS OF OUTPUT POWER MEASUREMENT .....	12
4.1.2	TEST INSTRUMENTS.....	13
4.1.3	TEST PROCEDURES .....	14
4.1.4	TEST SETUP.....	15
4.1.5	EUT OPERATING CONDITIONS .....	15
4.1.6	TEST RESULTS .....	16
4.2	FREQUENCY STABILITY MEASUREMENT.....	18
4.2.1	LIMITS OF FREQUENCY STABILITY MEASUREMENT .....	18
4.2.2	TEST INSTRUMENTS.....	18
4.2.3	TEST PROCEDURE.....	19
4.2.4	TEST SETUP.....	19
4.2.5	EUT OPERATING CONDITIONS .....	19
4.2.6	TEST RESULTS .....	20
4.3	EMISSION BANDWIDTH MEASUREMENT .....	22
4.3.1	LIMITS OF EMISSION BANDWIDTH MEASUREMENT .....	22
4.3.2	TEST INSTRUMENTS.....	22
4.3.3	TEST PROCEDURE.....	22
4.3.4	TEST SETUP.....	23
4.3.5	EUT OPERATING CONDITIONS .....	23
4.3.6	TEST RESULTS .....	24
4.4	CHANNEL EDGE MEASUREMENT.....	28
4.4.1	LIMITS OF CHANNEL EDGE MEASUREMENT .....	28
4.4.2	TEST INSTRUMENTS.....	28
4.4.3	TEST SETUP.....	28
4.4.4	TEST PROCEDURES .....	29
4.4.5	EUT OPERATING CONDITION.....	29
4.4.6	TEST RESULTS .....	30
4.5	CONDUCTED SPURIOUS EMISSIONS.....	36
4.5.1	LIMITS OF CONDUCTED SPURIOUS EMISSIONS MEASUREMENT.....	36
4.5.2	TEST INSTRUMENTS.....	36
4.5.3	TEST PROCEDURE.....	37
4.5.4	TEST SETUP.....	37
4.5.5	EUT OPERATING CONDITIONS .....	37
4.5.6	TEST RESULTS .....	38
4.6	RADIATED EMISSION MEASUREMENT (BELOW 1GHz).....	50
4.6.1	LIMITS OF RADIATED EMISSION MEASUREMENT .....	50
4.6.2	TEST INSTRUMENTS.....	51



A D T

4.6.3	TEST PROCEDURES .....	52
4.6.4	DEVIATION FROM TEST STANDARD .....	52
4.6.5	TEST SETUP .....	53
4.6.6	EUT OPERATING CONDITIONS .....	53
4.6.7	TEST RESULTS .....	54
4.7	RADIATED EMISSION MEASUREMENT (ABOVE 1GHz) .....	56
4.7.1	LIMITS OF RADIATED EMISSION MEASUREMENT .....	56
4.7.2	TEST INSTRUMENTS.....	57
4.7.3	TEST PROCEDURES .....	58
4.7.4	DEVIATION FROM TEST STANDARD .....	58
4.7.5	TEST SETUP .....	59
4.7.6	EUT OPERATING CONDITIONS .....	59
4.7.7	TEST RESULTS .....	60
5	PHOTOGRAPHS OF THE TEST CONFIGURATION.....	66
6	INFORMATION ON THE TESTING LABORATORIES .....	67



A D T

## 1 CERTI FICATION

**PRODUCT:** WiMAX 16e 2.5-2.7GHz Outdoor CPE

**MODEL:** OS-250

**BRAND:** GreenPacket

**APPLICANT:** Green Packet INC

**TESTED:** Mar. 19 ~ Mar. 30, 2009

**TEST SAMPLE:** ENGINEERING SAMPLE

**TEST STANDARDS:** FCC Part 27, Subpart C & M

The above equipment (Model no.: OS-250) has been tested by **Bureau Veritas Consumer Products Services (H.K.) Ltd., Taoyuan Branch**, and found compliance with the requirement of the above standards. The test record, data evaluation & Equipment Under Test (EUT) configurations represented herein are true and accurate accounts of the measurements of the sample's EMC characteristics under the conditions specified in this report.

**PREPARED BY** : Andrea Hsia , **DATE** : Apr. 09, 2009  
Andrea Hsia / Specialist

**TECHNICAL ACCEPTANCE** : Long Chen , **DATE** : Apr. 09, 2009  
Responsible for RF Long Chen / Senior Engineer

**APPROVED BY** : Gary Chang , **DATE** : Apr. 09, 2009  
Gary Chang / Assistant Manager



A D T

## 2 SUMMARY OF TEST RESULTS

The EUT has been tested according to the following specifications:

STANDARD SECTION	TEST TYPE AND LIMIT	RESULT	REMARK
FCC Part 27 & Part 2			
2.1046 27.50(h)(2)	Maximum Peak Output Power Limit: max. 2000watt.	PASS	Meet the requirement of limit. Minimum passing margin is 39.67dBm at 2685.00MHz.
2.1055 27.54	Frequency Stability Stay with the authorized bands of operation	PASS	Meet the requirement of limit.
2.1049 27.53(m)(6)	Emission Bandwidth	PASS	Meet the requirement of limit.
2.1051 27.53(m)(4)(6)	Band Edge Measurements	PASS	Meet the requirement of limit.
2.1051 27.53(m)(4)(6)	Conducted Spurious Emissions	PASS	Meet the requirement of limit.
2.1053 27.53(m)(4)(6)	Radiated Spurious Emissions	PASS	Meet the requirement of limit. Minimum passing margin is -5.84dB at 5375.00MHz.

### 2.1 MEASUREMENT UNCERTAINTY

Where relevant, the following measurement uncertainty levels have been estimated for tests performed on the EUT as specified in CISPR 16-4-2:

MEASUREMENT	FREQUENCY	UNCERTAINTY
Conducted emissions	9kHz~30MHz	2.44 dB
Radiated emissions	30MHz ~ 200MHz	3.19 dB
	200MHz ~1000MHz	3.21 dB
	1GHz ~ 18GHz	2.26 dB
	18GHz ~ 40GHz	1.94 dB

This uncertainty represents an expanded uncertainty expressed at approximately the 95% confidence level using a coverage factor of  $k = 2$ .



A D T

### 3 GENERAL INFORMATION

#### 3.1 GENERAL DESCRIPTION OF EUT

<b>PRODUCT</b>	WiMAX 16e 2.5-2.7GHz Outdoor CPE
<b>MODEL NO.</b>	OS-250
<b>FCC ID</b>	W9V-OS250-GP
<b>POWER SUPPLY</b>	48Vdc from PoE
<b>MODULATION TYPE</b>	BPSK, QPSK, 16QAM, 64QAM (refer to NOTE for more details)
<b>CODING RATE</b>	1/2, 2/3, 3/4, 5/6 (refer to NOTE for more details)
<b>MODULATION TECHNOLOGY</b>	OFDMA
<b>DUPLEX METHOD</b>	TDD
<b>OPERATING RANGE</b>	2502.5MHz ~ 2687.5MHz
<b>CHANNEL BANDWIDTH</b>	5MHz, 10MHz
<b>MAX. E.I.R.P. POWER</b>	39.67dBm
<b>ANTENNA TYPE</b>	refer to NOTE for more details
<b>OPERATION TEMPERATURE RANGE</b>	-40°C ~ 70°C
<b>DATA CABLE</b>	1.7m shielded RJ45 cable
<b>I/O PORTS</b>	Refer to user's manual
<b>ACCESSORY DEVICES</b>	POE

**NOTE:**

1. The EUT was powered by the following POE:

<b>BRAND:</b>	PowerDsine™ 3001
<b>MODEL:</b>	PD-3001/AC
<b>INPUT:</b>	100-250Vac, 50-60Hz, 0.5A
<b>OUTPUT:</b>	48Vdc, 0.35A
<b>POWER LINE:</b>	AC: 1.7 m non-shielded without core

2. The following antennas were provided to this EUT.

ITEM	ANTENNA TYPE	GAIN	CONNECTOR	MODEL
Antenna 1	Patched	14.13dBi at E-plane	UFL	SDW2352A1
Antenna 2	Patched	14.82dBi at H E-plane	UFL	97-A002-03005

\*\*We chosen the highest gain of antenna for final test and presented in the test report.

3. EUT can supports different duty cycle of transmission, max duty cycle is up to 75%. After pretesting of output power and spurious emission, 75 % duty cycle was found to be worst case and was selected for the final test configuration.



**A D T**

4. For the EUT with modulation type and coding rate. After pre-testing in test items of output power and spurious emissions, QPSK was found to be worst case and was selected for the final test configuration.

DOWN LINK		UP LINK	
MODULATION	CODING RATE	MODULATION	CODING RATE
BPSK	1/2	QPSK	1/2
	2/3		3/4
	3/4	16QAM	1/2
1/2	3/4		
QPSK	2/3	/	
	3/4		
	1/2		
16QAM	2/3		
	3/4		
	1/2		
64QAM	2/3		
	3/4		
	3/4		
	5/6		

5. The above EUT information was declared by manufacturer and for more detailed features description, please refers to the manufacturer's specifications or User's Manual.

### 3.2 DESCRIPTION OF TEST MODES

Three channels had been tested for each channel bandwidth.

CHANNEL BANDWIDTH: 5MHz	CHANNEL BANDWIDTH: 10MHz
Low channel (L): 2502.5MHz.	Low channel (L): 2505.0MHz.
Middle channel (M): 2595.0MHz.	Middle channel (M): 2595.0MHz.
High channel (H): 2687.5MHz.	High channel (H): 2685.0MHz.

#### 3.2.1 CONFIGURATION OF SYSTEM UNDER TEST

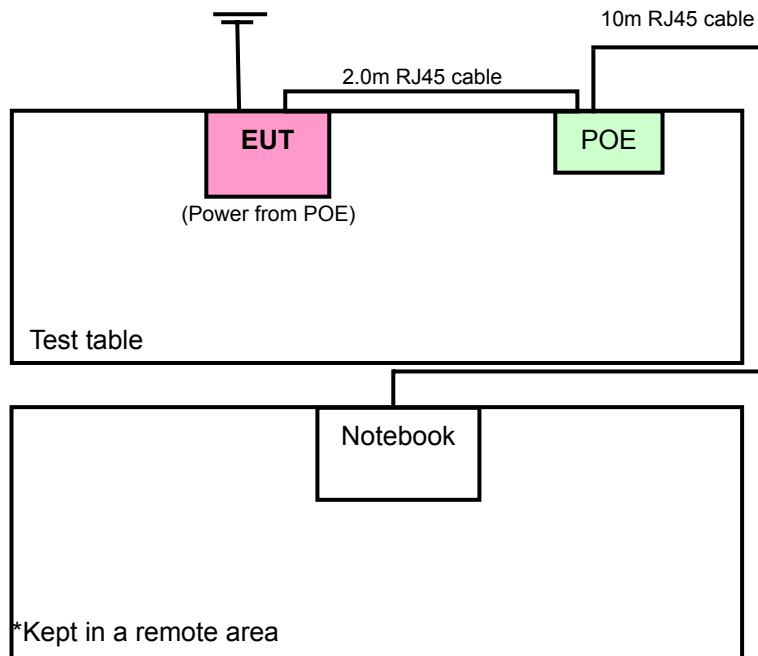





### 3.2.2 TEST MODE APPLICABILITY AND TESTED CHANNEL DETAIL

EUT CONFIGURE MODE	APPLICABLE TO							DESCRIPTION
	OP	FS	EB	CE	CSE	RE<1G	RE≥1G	
-	√	√	√	√	√	√	√	-

Where **OP**: Output power **FS**: Frequency stability  
**EB**: Emission bandwidth **CE**: Channel edge  
**CSE**: : Conducted spurious emissions **RE<1G**: Radiated emission below 1GHz  
**RE** ≥1G: Radiated emission above 1GHz

#### **OUTPUT POWER MEASUREMENT:**

- Pre-Scan has been conducted to determine the worst-case mode from all possible combinations between available modulations, coding rate, XYZ axis and antenna ports (if EUT with antenna diversity architecture).
- Following channel(s) was (were) selected for the final test as listed below.

TESTED CHANNEL	MODULATION TECHNOLOGY	MODULATION TYPE	CHANNEL BANDWIDTH	CODING RATE	AXIS
L, M, H	OFDMA	QPSK	5MHz	1/2	Z
L, M, H	OFDMA	QPSK	10MHz	1/2	Z

#### **FREQUENCY STABILITY MEASUREMENT:**

- Pre-Scan has been conducted to determine the worst-case mode from all possible combinations between available modulations, coding rate, and antenna ports (if EUT with antenna diversity architecture).
- Following channel(s) was (were) selected for the final test as listed below.

TESTED CHANNEL	MODULATION TECHNOLOGY	MODULATION TYPE	CHANNEL BANDWIDTH	CODING RATE
L	OFDMA	QPSK	5MHz	1/2
L	OFDMA	QPSK	10MHz	1/2

#### **EMISSION BANDWIDTH MEASUREMENT:**

- Pre-Scan has been conducted to determine the worst-case mode from all possible combinations between available modulations, coding rate, and antenna ports (if EUT with antenna diversity architecture).
- Following channel(s) was (were) selected for the final test as listed below.

TESTED CHANNEL	MODULATION TECHNOLOGY	MODULATION TYPE	CHANNEL BANDWIDTH	CODING RATE
L, M, H	OFDMA	QPSK	5MHz	1/2
L, M, H	OFDMA	QPSK	10MHz	1/2



A D T

### **CHANNEL EDGE MEASUREMENT:**

- Pre-Scan has been conducted to determine the worst-case mode from all possible combinations between available modulations, coding rate, and antenna ports (if EUT with antenna diversity architecture).
- Following channel(s) was (were) selected for the final test as listed below.

TESTED CHANNEL	MODULATION TECHNOLOGY	MODULATION TYPE	CHANNEL BANDWIDTH	CODING RATE
L, M, H	OFDMA	QPSK	5MHz	1/2
L, M, H	OFDMA	QPSK	10MHz	1/2

### **CONDUCTED SPURIOUS EMISSIONS MEASUREMENT:**

- Pre-Scan has been conducted to determine the worst-case mode from all possible combinations between available modulations, coding rate, and antenna ports (if EUT with antenna diversity architecture).
- Following channel(s) was (were) selected for the final test as listed below.

TESTED CHANNEL	MODULATION TECHNOLOGY	MODULATION TYPE	CHANNEL BANDWIDTH	CODING RATE
L, M, H	OFDMA	QPSK	5MHz	1/2
L, M, H	OFDMA	QPSK	10MHz	1/2

### **RADIATED EMISSION MEASUREMENT (BELOW 1 GHz):**

- Pre-Scan has been conducted to determine the worst-case mode from all possible combinations between available modulations, coding rate, XYZ axis and antenna ports (if EUT with antenna diversity architecture).
- Following channel(s) was (were) selected for the final test as listed below.

TESTED CHANNEL	MODULATION TECHNOLOGY	MODULATION TYPE	CHANNEL BANDWIDTH	CODING RATE	AXIS
M	OFDMA	QPSK	5MHz	1/2	Z
M	OFDMA	QPSK	10MHz	1/2	Z

### **RADIATED EMISSION MEASUREMENT (ABOVE 1 GHz):**

- Pre-Scan has been conducted to determine the worst-case mode from all possible combinations between available modulations, coding rate, XYZ axis and antenna ports (if EUT with antenna diversity architecture).
- Following channel(s) was (were) selected for the final test as listed below.

TESTED CHANNEL	MODULATION TECHNOLOGY	MODULATION TYPE	CHANNEL BANDWIDTH	CODING RATE	AXIS
L, M, H	OFDMA	QPSK	5MHz	1/2	Z
L, M, H	OFDMA	QPSK	10MHz	1/2	Z

### 3.3 GENERAL DESCRIPTION OF APPLIED STANDARDS

The EUT is a RF product. According to the specifications of the manufacturer, it must comply with the requirements of the following standards:

**FCC 47 CFR Part 2**

**FCC 47 CFR Part 27**

**ANSI/TIA/EIA-603-C-2004**

**NOTE:** The EUT is also considered as a kind of computer peripheral, because the connection to computer is necessary for typical use. It has been verified to comply with the requirements of FCC Part 15, Subpart B, Class B (DoC). The test report has been issued separately.

### 3.4 DESCRIPTION OF SUPPORT UNITS

The EUT has been tested as an independent unit together with other necessary accessories or support units. The following support units or accessories were used to form a representative test configuration during the tests.

NO.	PRODUCT	BRAND	MODEL NO.	SERIAL NO.	FCC ID
1	NOTEBOOK	DELL	D820	21498926752	FCC DoC Approved

NO.	SIGNAL CABLE DESCRIPTION OF THE ABOVE SUPPORT UNITS
1	2.0m RJ45 shielded cable

**NOTE:** All power cords of the above support units are non shielded (1.8m).

## **4 TEST TYPES AND RESULTS**

### **4.1 OUTPUT POWER MEASUREMENT**

#### **4.1.1 LIMITS OF OUTPUT POWER MEASUREMENT**

The radiated peak output power shall be according to the specific rule Part 27.50(h)(1) that “The maximum EIRP of a main, booster or base station shall not exceed  $33\text{dBW} + 10\log(X/Y)\text{dBW}$ ” and 27.50(i) specific that “Peak transmit power must be measure over any interval of continuous transmission using instrumentation calibration in terms of rms-equivalent voltage.”



A D T

#### 4.1.2 TEST INSTRUMENTS

DESCRIPTION & MANUFACTURER	MODEL NO.	SERIAL NO.	DATE OF CALIBRATION	DUE DATE OF CALIBRATION
Test Receiver ROHDE & SCHWARZ	ESI7	838496/016	Dec. 29, 2008	Dec. 28, 2009
Spectrum Analyzer ROHDE & SCHWARZ	FSP40	100039	Dec. 08, 2008	Dec. 07, 2009
BILOG Antenna SCHWARZBECK	VULB9168	9168-155	Apr. 30, 2008	Apr. 29, 2009
HORN Antenna SCHWARZBECK	BBHA 9120D	9120D-408	Dec. 29, 2008	Dec. 28, 2009
HORN Antenna SCHWARZBECK	BBHA 9170	BBHA9170242	Jan. 06, 2009	Jan. 05, 2010
Preamplifier Agilent	8449B	3008A01960	Nov. 03, 2008	Nov. 02, 2009
Preamplifier Agilent	8447D	2944A10631	Nov. 03, 2008	Nov. 02, 2009
RF signal cable HUBER+SUHNNER	SUCOFLEX 104	274041/4	Aug. 21, 2008	Aug. 20, 2009
RF signal cable HUBER+SUHNNER	SUCOFLEX 104	283397/4	Aug. 21, 2008	Aug. 20, 2009
Software ADT.	ADT_Radiated_ V7.6.15.9.2	NA	NA	NA
Antenna Tower inn-co GmbH	MA 4000	010303	NA	NA
Antenna Tower Controller inn-co GmbH	CO2000	019303	NA	NA
Turn Table ADT.	TT100.	TT93021704	NA	NA
Turn Table Controller ADT.	SC100.	SC93021704	NA	NA

- NOTE:**
1. The calibration interval of the above test instruments is 12 months and the calibrations are traceable to NML/ROC and NIST/USA.
  2. The test was performed in HwaYa Chamber 4.
  3. The horn antenna and HP preamplifier (model: 8449B) are used only for the measurement of emission frequency above 1GHz if tested.
  4. The FCC Site Registration No. is 988962.
  5. The IC Site Registration No. is IC7450F-4.

### 4.1.3 TEST PROCEDURES

#### EIRP MEASUREMENT

- a. The power was measured with R&S Spectrum Analyzer. All measurements were done at 3 channels (low, middle and high channel of operational frequency range.)
- b. Substitution method is used for E.I.R.P measurement. In the semi-anechoic chamber, EUT placed on the 0.8m height of Turn Table, rotated the table around 360 degrees to search the maximum radiation power and receiver antenna shall be rotated vertical and horizontal polarization and moved height from 1m to 4m to find the maximum polar radiated power. The “Read Value” is the spectrum reading the maximum power value.
- c. The substitution horn antenna is substituted for EUT at the same position and signals generator export the CW signal to the substitution antenna via a tx cable. Rotated the Turn Table and moved receiving antenna to find the maximum radiation power. Adjust output power level of S.G to get a Value of spectrum reading equal to “Read Value “ of step b. Record the power level of S.G
- d.  $EIRP = \text{Output power level of S.G} - \text{TX cable loss} + \text{Antenna gain of substitution horn}$

**NOTE:** The resolution bandwidth and video bandwidth of test receiver/spectrum analyzer is 1MHz/3MHz

#### CONDUCTED POWER MEASUREMENT

- a. Set span to encompass the entire emission bandwidth (EBW) of the signal.
- b. Set RBW = 51kHz, VBW = 160kHz. Detector mode = RMS ( 5MHz bandwidth)
- c. Set RBW = 100kHz, VBW = 300kHz. Detector mode = RMS ( 10MHz bandwidth)
- d. Computer power by integrating the spectrum across the 26dB EBW of the signal.
- e. Record the power level

#### 4.1.4 TEST SETUP

##### EIRP Power MEASUREMENT:

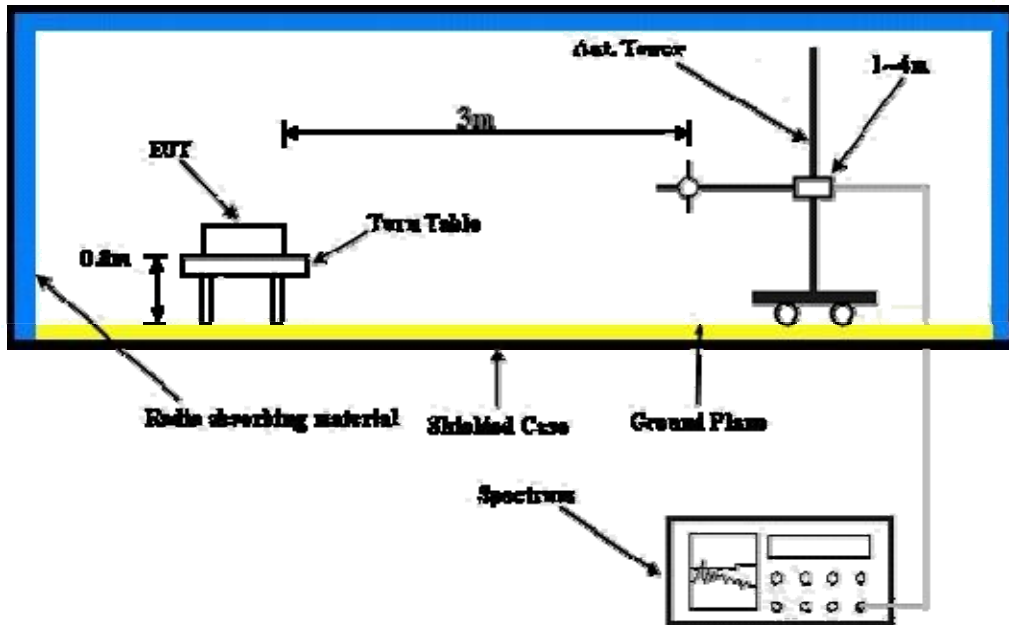

For the actual test configuration, please refer to the related item – Photographs of the Test Configuration.

##### CONDUCTED POWER MEASUREMENT

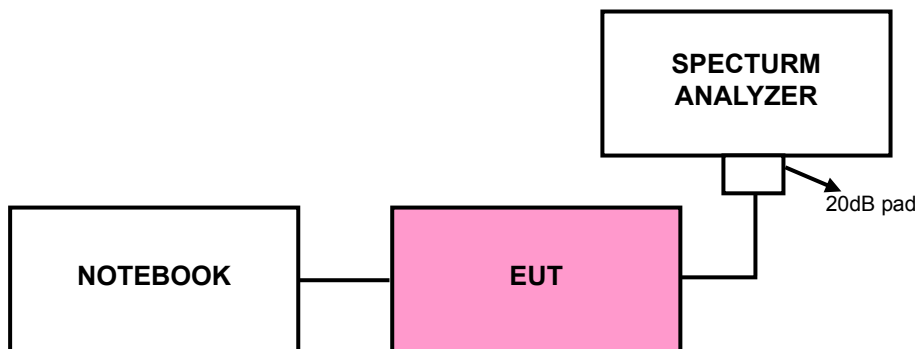

#### 4.1.5 EUT OPERATING CONDITIONS

- Placed the EUT on a testing table.
- Prepared a notebook computer and placed it outside of testing area to act as communication partner for EUT.
- The EUT ran a test program (provided by manufacturer) to enable all functions under transmission condition continuously at specific channel frequency.
- The necessary accessories enable the EUT in full functions.



A D T

#### 4.1.6 TEST RESULTS

<b>INPUT POWER</b>	120Vac, 60Hz	<b>DETECTOR FUNCTION</b>	RMS
<b>ENVIRONMENTAL CONDITIONS</b>	22deg°C, 60%RH 991hPa	<b>CHANNEL BANDWIDTH</b>	5MHz
<b>TESTED BY</b>	Dean Wang		

EIRP POWER (RMS)					
CHANNEL	FREQUENCY (MHz)	C.F (dB)	S.G. READING (dBm)	TOTAL POWER (dBm)	TOTAL POWER (W)
Low	2502.50	9.3	30.16	39.46	8.831
Middle	2595.00	9.3	29.83	39.13	8.185
High	2687.50	9.3	29.59	38.89	7.745

**NOTE:** C.F = Antenna gain of substitution horn- tx cable loss

CONDUCTED POWER (RMS)					
CHANNEL	FREQUENCY (MHz)	C.F (dB)	S.A. READING (dBm)	TOTAL POWER (dBm)	TOTAL POWER (W)
Low	2502.50	21.00	5.43	26.43	0.440
Middle	2595.00	21.00	5.66	26.66	0.463
High	2687.50	21.00	5.10	26.10	0.407

**NOTE:** C.F = attenuator + cable loss





A D T

<b>INPUT POWER</b>	120Vac, 60Hz	<b>DETECTOR FUNCTION</b>	RMS
<b>ENVIRONMENTAL CONDITIONS</b>	25deg°C, 63%RH 991hPa	<b>CHANNEL BANDWIDTH</b>	10MHz
<b>TESTED BY</b>	Dean Wang		

<b>EIRP POWER (RMS)</b>					
<b>CHANNEL</b>	<b>FREQUENCY (MHz)</b>	<b>C.F (dB)</b>	<b>S.G. READING (dBm)</b>	<b>TOTAL POWER (dBm)</b>	<b>TOTAL POWER (W)</b>
Low	2505.00	9.3	30.12	39.42	8.750
Middle	2595.00	9.3	29.78	39.08	8.091
High	<b>2685.00</b>	<b>9.3</b>	<b>30.37</b>	<b>39.67</b>	<b>9.268</b>

**NOTE:** C.F = Antenna gain of substitution horn- tx cable loss

<b>CONDUCTED POWER (RMS)</b>					
<b>CHANNEL</b>	<b>FREQUENCY (MHz)</b>	<b>C.F (dB)</b>	<b>S.A. READING (dBm)</b>	<b>TOTAL POWER (dBm)</b>	<b>TOTAL POWER (W)</b>
Low	2505.00	21.00	5.65	26.56	0.453
Middle	2595.00	21.00	5.23	26.23	0.420
High	2685.00	21.00	5.66	26.66	0.463

**NOTE:** C.F = attenuator + cable loss

## 4.2 FREQUENCY STABILITY MEASUREMENT

### 4.2.1 LIMITS OF FREQUENCY STABILITY MEASUREMENT

According to the FCC part 2.1055 shall be tested the frequency stability. The rule is defined that "The frequency stability shall be sufficient to ensure that the fundamental emission stays within the authorized frequency block." The test extreme voltage is according to the 2.1055(d)(1) Vary primary supply voltage from 85 to 115 percent of the nominal value for other than hand carried battery equipment and the extreme temperature rule is comply with specification of EUT  $-40^{\circ}\text{C} \sim 70^{\circ}\text{C}$ .

### 4.2.2 TEST INSTRUMENTS

DESCRIPTION & MANUFACTURER	MODEL NO.	SERIAL NO.	DATE OF CALIBRATION	DUE DATE OF CALIBRATION
Spectrum Analyzer Agilent	E4446A	MY44360128	Dec. 12, 2008	Dec.11. 2009
* Hewlett Packard RF cable	8120-6192	01428251	NA	NA
* Suhner RF cable	Sucoflex104	204850/4	NA	NA
* WIT Standard Temperature & Humidity Chamber	TH-4S-C	W981030	Jun. 26, 2008	Jun. 25, 2009

- NOTE:**
1. The calibration interval of the above test instruments is 12 months. And the calibrations are traceable to NML/ROC and NIST/USA.
  2. "\*" = These equipments are used for the final measurement.
  3. The test was performed in ADT RF OVEN room.

### 4.2.3 TEST PROCEDURE

- a. Power must be removed when changing from one temperature to another or one voltage to another voltage. Power warm up is at least 15 min and power applied should perform before recording frequency error.
- b. EUT is connected the external power supply to control the AC input power. The various Volts from the minimum 93.5 Volts to 126.5 Volts. Each step shall be record the frequency error rate.
- c. The temperature range step is 10 degrees in this test items. All temperature levels shall be hold the  $\pm 0.5^{\circ}\text{C}$  during the measurement testing.
- d. The each temperature step shall be at least 0.5 hours, consider the EUT could be test under the stability condition.

### 4.2.4 TEST SETUP

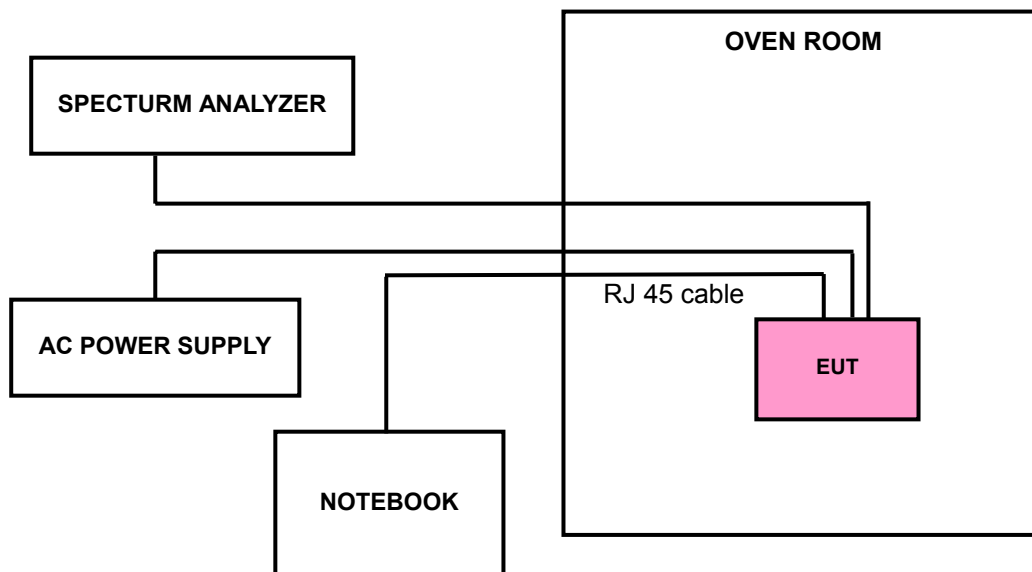

### 4.2.5 EUT OPERATING CONDITIONS

The EUT connected to the notebook. Use software to control the EUT channel and transmit a single tone.



A D T

#### 4.2.6 TEST RESULTS

<b>MODE</b>	Low channel	<b>INPUT POWER</b>	120Vac, 60Hz
<b>ENVIRONMENTAL CONDITIONS</b>	25deg°C, 63%RH 991hPa	<b>CHANNEL BANDWIDTH</b>	5MHz
<b>TESTED BY</b>	Dean Wang		

<b>AFC FREQUENCY ERROR VS. VOLTAGE</b>		
<b>VOLTAGE (Volts)</b>	<b>FREQUENCY (MHz)</b>	<b>FREQUENCY ERROR (ppm)</b>
126.5	2502.495750	-1.6983017
110.0	2502.495640	-1.7422577
93.5	2502.495420	-1.8301698

<b>AFC FREQUENCY ERROR VS. TEMP.</b>		
<b>TEMP. (°C)</b>	<b>FREQUENCY (MHz)</b>	<b>FREQUENCY ERROR (ppm)</b>
70	2502.495885	-1.6443556
60	2502.496119	-1.5508492
50	2502.495960	-1.6143856
40	2502.495465	-1.8121878
30	2502.495258	-1.8949051
20	2502.495640	-1.7422577
10	2502.495371	-1.8497502
0	2502.495823	-1.6691309
-10	2502.495520	-1.7902098
-20	2502.495520	-1.7902098
-30	2502.495362	-1.8533467
-40	2502.495248	-1.8989011



A D T

<b>MODE</b>	Low channel	<b>INPUT POWER</b>	120Vac, 60Hz
<b>ENVIRONMENTAL CONDITIONS</b>	25deg°C, 63%RH 991hPa	<b>CHANNEL BANDWIDTH</b>	10MHz
<b>TESTED BY</b>	Dean Wang		

**AFC FREQUENCY ERROR VS. VOLTAGE**

<b>VOLTAGE (Volts)</b>	<b>FREQUENCY (MHz)</b>	<b>FREQUENCY ERROR (ppm)</b>
126.5	2505.002364	0.9437126
110.0	2505.002420	0.9660679
93.5	2505.002636	1.0522954

**AFC FREQUENCY ERROR VS. TEMP.**

<b>TEMP. (°C)</b>	<b>FREQUENCY (MHz)</b>	<b>FREQUENCY ERROR (ppm)</b>
70	2505.002410	0.9620758
60	2505.002399	0.9576846
50	2505.002324	0.9277445
40	2505.002434	0.9716567
30	2505.002088	0.8335329
20	2505.002420	0.9660679
10	2505.002627	1.0487026
0	2505.002104	0.8399202
-10	2505.002244	0.8958084
-20	2505.002657	1.0606786
-30	2505.002468	0.9852295
-40	2505.002304	0.9197605

## 4.3 EMISSION BANDWIDTH MEASUREMENT

### 4.3.1 LIMITS OF EMISSION BANDWIDTH MEASUREMENT

According to FCC 27.53(m)(6) specified that emission bandwidth is defined as the width of the signal between two points, one below the carrier center frequency and one above the carrier center frequency, outside of which all emissions are attenuated at least 26dB below the transmitter power.

### 4.3.2 TEST INSTRUMENTS

DESCRIPTION & MANUFACTURER	MODEL NO.	SERIAL NO.	DATE OF CALIBRATION	DUE DATE OF CALIBRATION
Spectrum Analyzer Agilent	E4446A	MY44360128	Dec. 12, 2008	Dec.11. 2009
* Hewlett Packard RF cable	8120-6192	01428251	NA	NA
* Suhner RF cable	Sucoflex104	204850/4	NA	NA
* WIT Standard Temperature & Humidity Chamber	TH-4S-C	W981030	Jun. 26, 2008	Jun. 25, 2009

**NOTE:** 1. The calibration interval of the above test instruments is 12 months. And the calibrations are traceable to NML/ROC and NIST/USA.

2. "\*" = These equipments are used for the final measurement.

### 4.3.3 TEST PROCEDURE

The transmitter output was connected to the spectrum analyzer through an attenuator. The bandwidth of the fundamental frequency was measured by spectrum analyzer with RBW = 51kHz, VBW = 160kHz (for test mode A), RBW = 100kHz, VBW = 300kHz (for test mode B). The 26dB bandwidth is defined as the total spectrum the power of which is higher than peak power minus 26dB.

#### 4.3.4 TEST SETUP

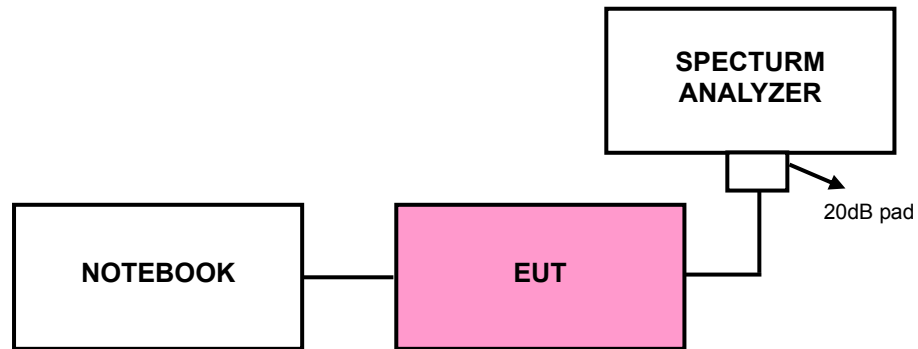

#### 4.3.5 EUT OPERATING CONDITIONS

Same as 4.1.5



A D T

### 4.3.6 TEST RESULTS

#### CHANNEL BANDWIDTH: 5MHz

CHANNEL	-26dBc BANDWIDTH (MHz)
Low	4.815
Middle	4.813
High	4.816

#### LOW CHANNEL

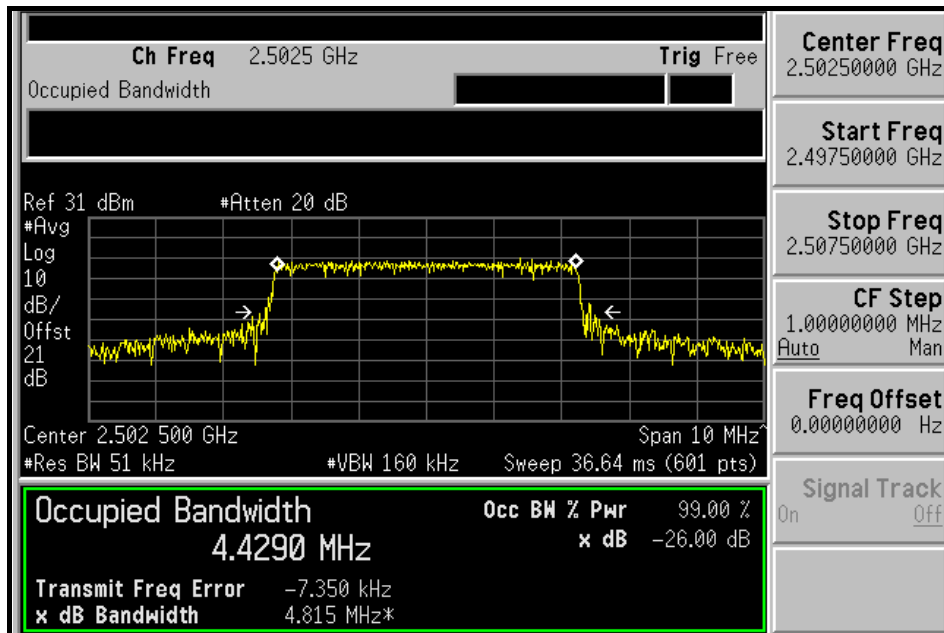





A D T

### MIDDLE CHANNEL

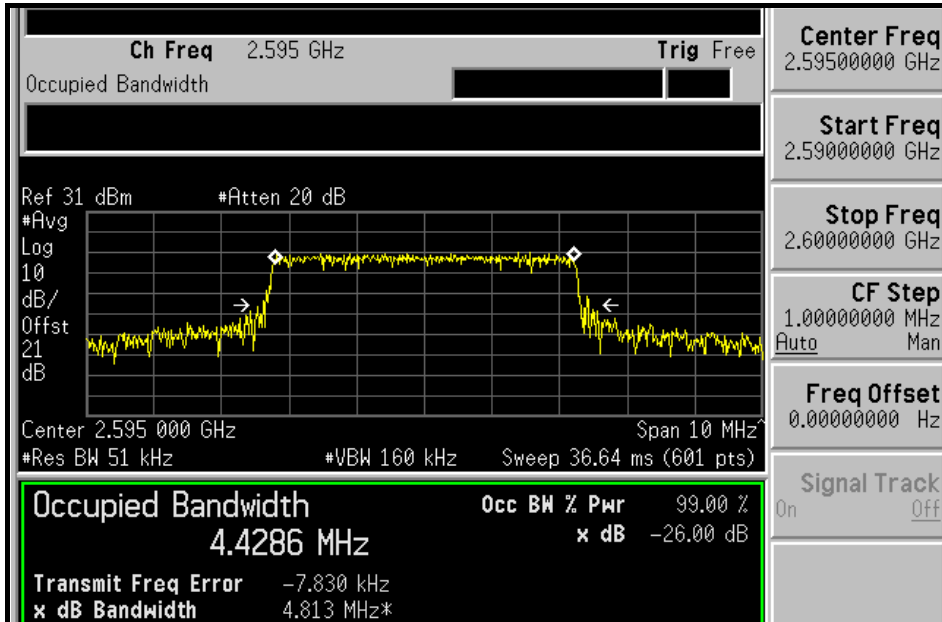

### HIGH CHANNEL

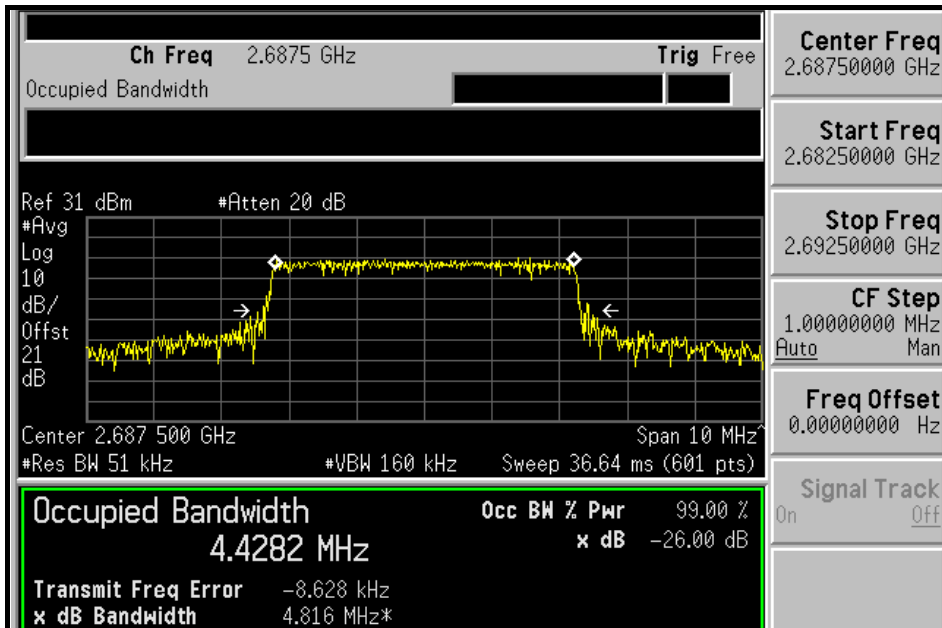



A D T

**CHANNEL BANDWIDTH: 10MHz**

CHANNEL	-26dBc BANDWIDTH (MHz)
Low	9.483
Middle	9.481
High	9.479

**LOW CHANNEL**

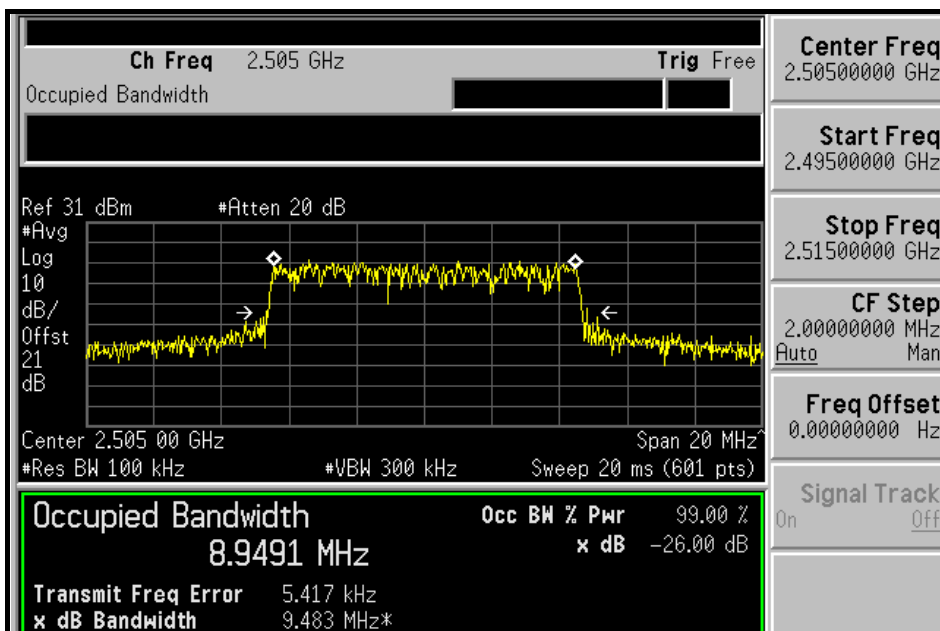



A D T

### MIDDLE CHANNEL

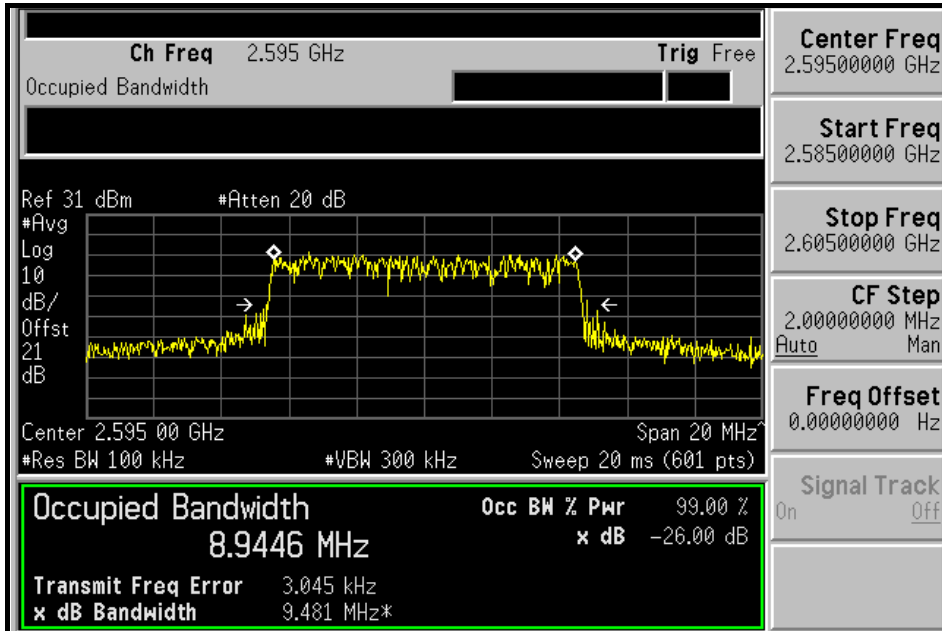

### HIGH CHANNEL

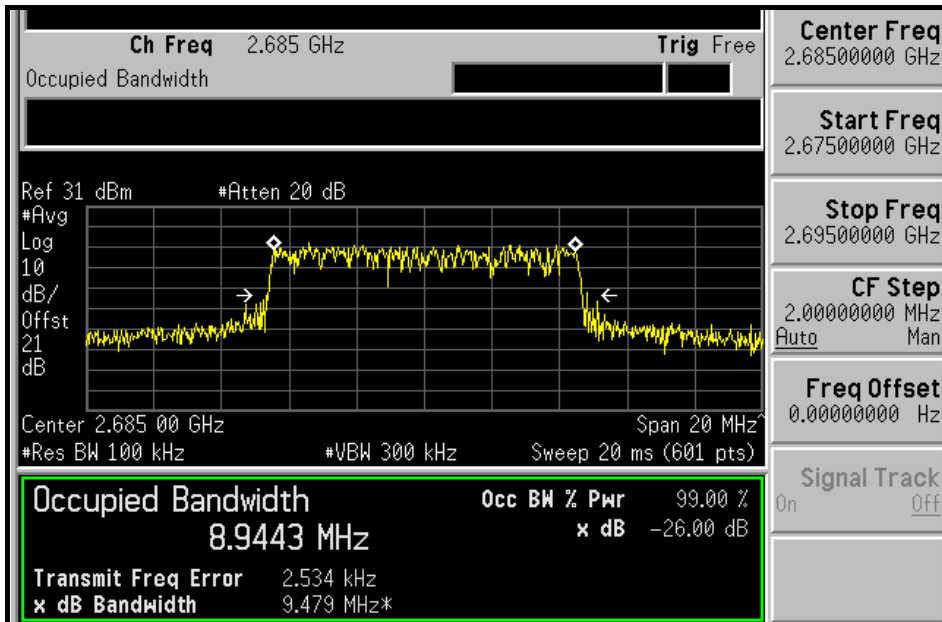

## 4.4 CHANNEL EDGE MEASUREMENT

### 4.4.1 LIMITS OF CHANNEL EDGE MEASUREMENT

According to FCC 27.53(m)(2) specified that power of any emission outside of the channel edge must be attenuated below the transmitting power (P) by a factor shall be not less than  $43 + 10 \log (P)$  dB, the limit of emission equal to  $-13\text{dBm}$ . In the 1MHz bands immediately outside and adjacent to the frequency block a resolution bandwidth of at least one percent of the emission bandwidth of the fundamental emission of the transmitter may be employed.

### 4.4.2 TEST INSTRUMENTS

DESCRIPTION & MANUFACTURER	MODEL NO.	SERIAL NO.	DATE OF CALIBRATION	DUE DATE OF CALIBRATION
Spectrum Analyzer Agilent	E4446A	MY44360128	Dec. 12, 2008	Dec.11. 2009
* JFW 10dB attenuation	50HF-010-SMA	NA	NA	NA
* Suhner RF cable	Sucoflex104	204850/4	NA	NA
* WIT Standard Temperature & Humidity Chamber	TH-4S-C	W981030	Jun. 26, 2008	Jun. 25, 2009

- NOTE:** 1. The calibration interval of the above test instruments is 12 months. And the calibrations are traceable to NML/ROC and NIST/USA.  
2. "\*" = These equipments are used for the final measurement.

### 4.4.3 TEST SETUP

Same as Item 4.3.3



A D T

#### 4.4.4 TEST PROCEDURES

- a. The EUT was set up for the rated peak power. The power was measured with Spectrum Analyzer. All measurements were done at 3 channels: low, middle and high operational frequency range.
- b. The center frequency of spectrum is the band edge frequency and span is 20MHz (Channel Bandwidth: 5MHz) / 30MHz (Channel Bandwidth: 10MHz). RBW of the spectrum is 51kHz (Channel Bandwidth: 5MHz) / 100kHz (Channel Bandwidth: 10MHz).
- c. Record the max trace plot into the test report.

#### 4.4.5 EUT OPERATING CONDITION

Same as 4.1.5



A D T

#### 4.4.6 TEST RESULTS

##### CHANNEL BANDWIDTH: 5MHz

##### LOW CHANNEL

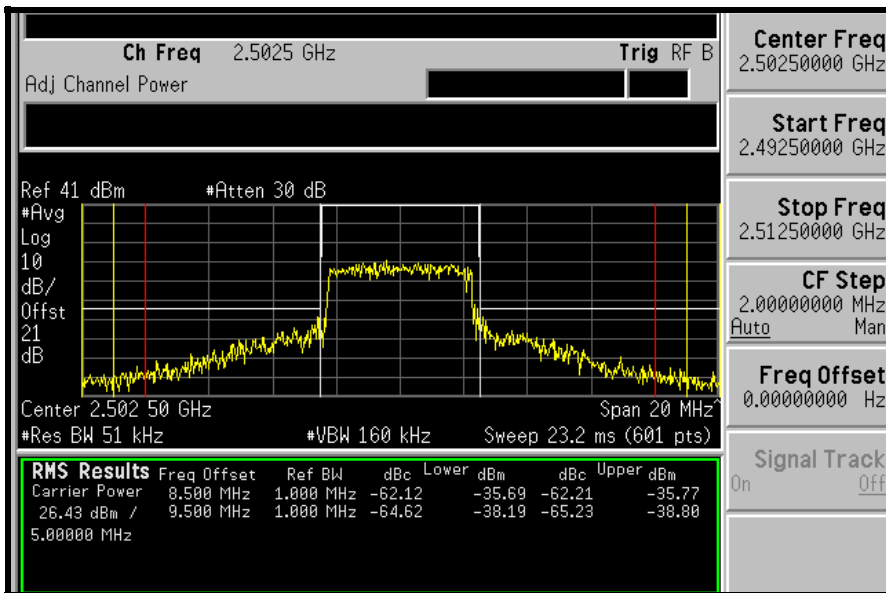
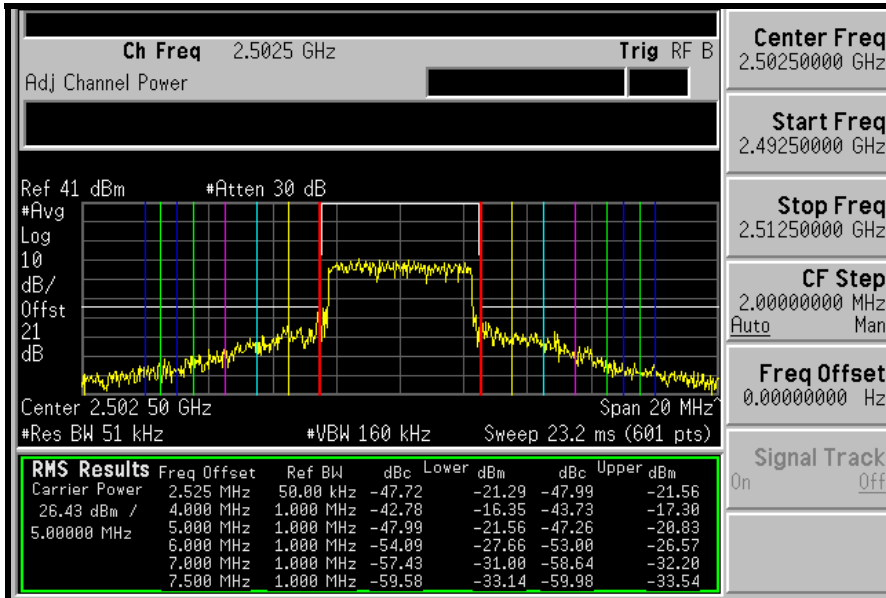



A D T

### MIDDLE CHANNEL

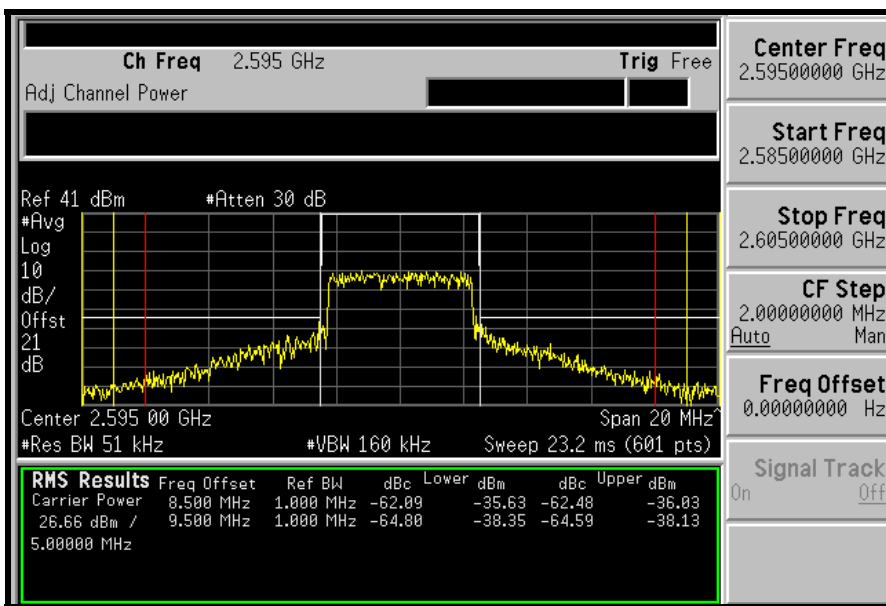
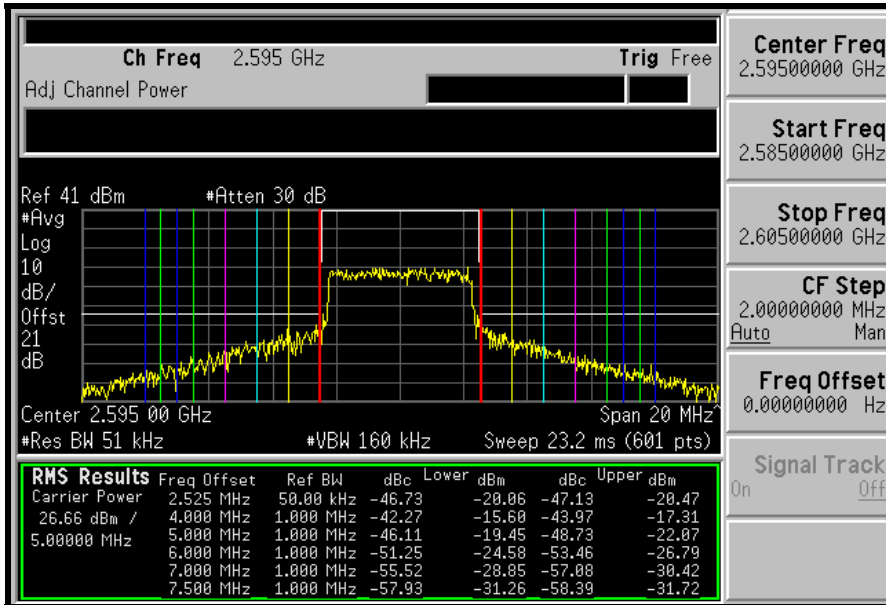



A D T

### HIGH CHANNEL

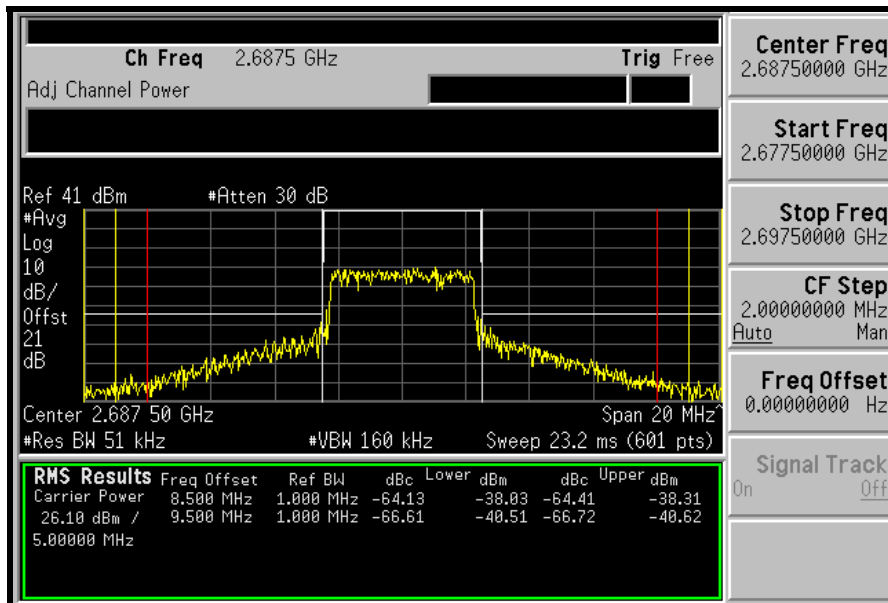
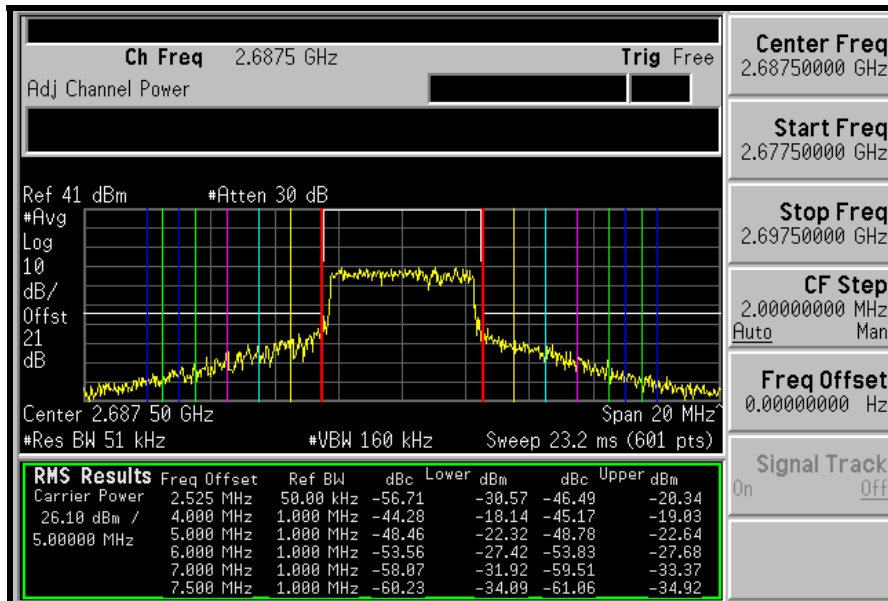





A D T

**CHANNEL BANDWIDTH: 10MHz**

**LOW CHANNEL**

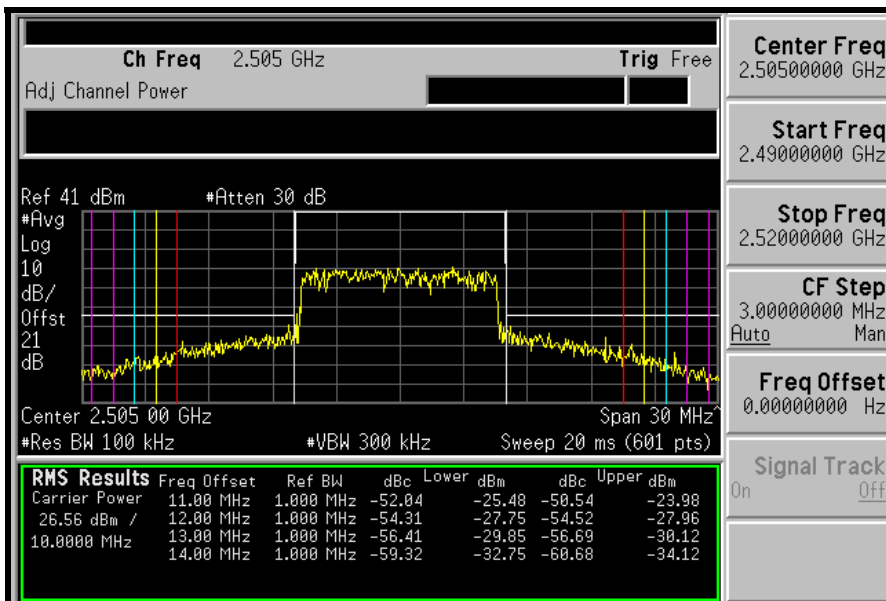
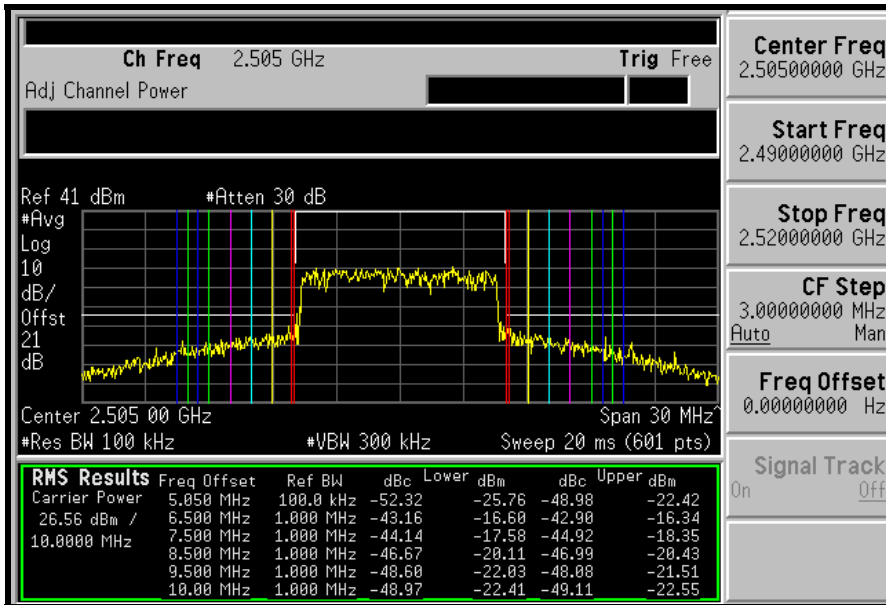



A D T

**MIDDLE CHANNEL**

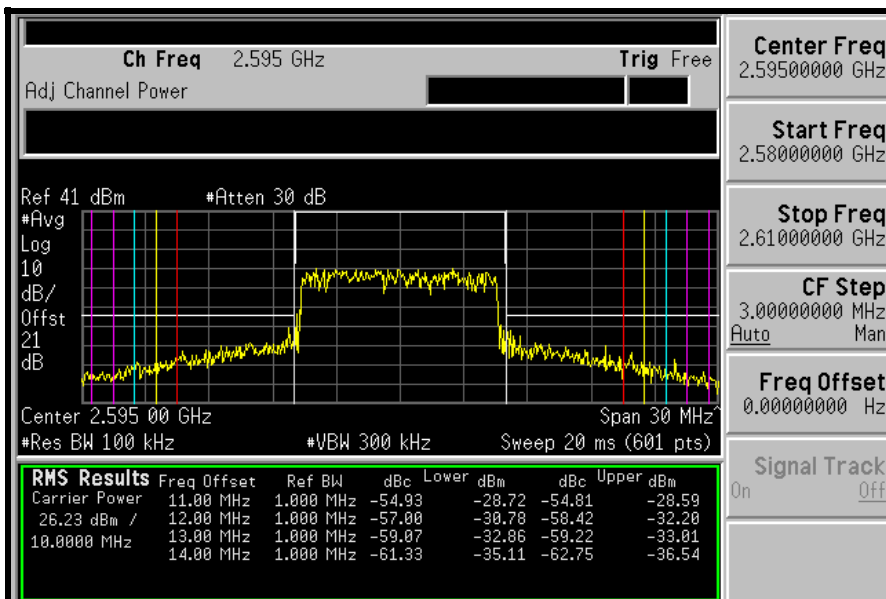
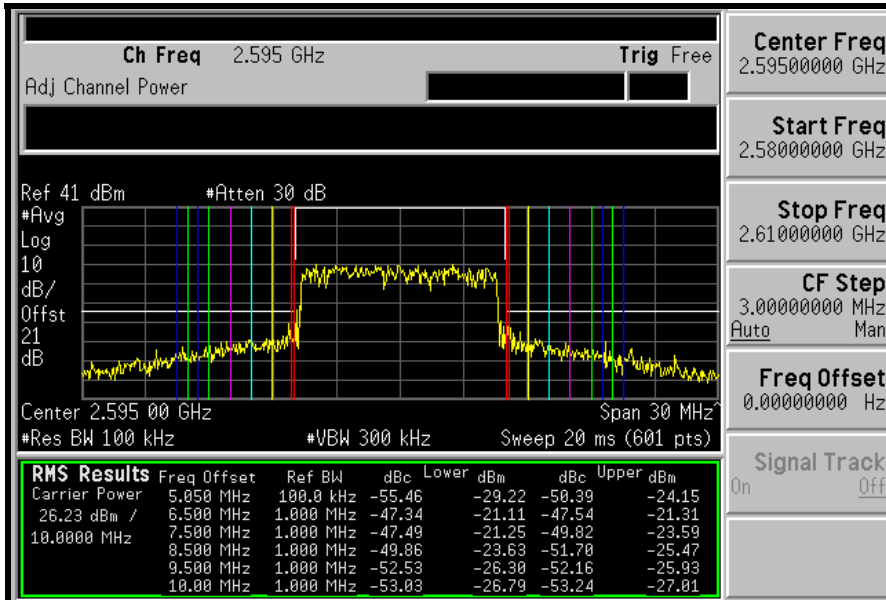



A D T

**HIGH CHANNEL**

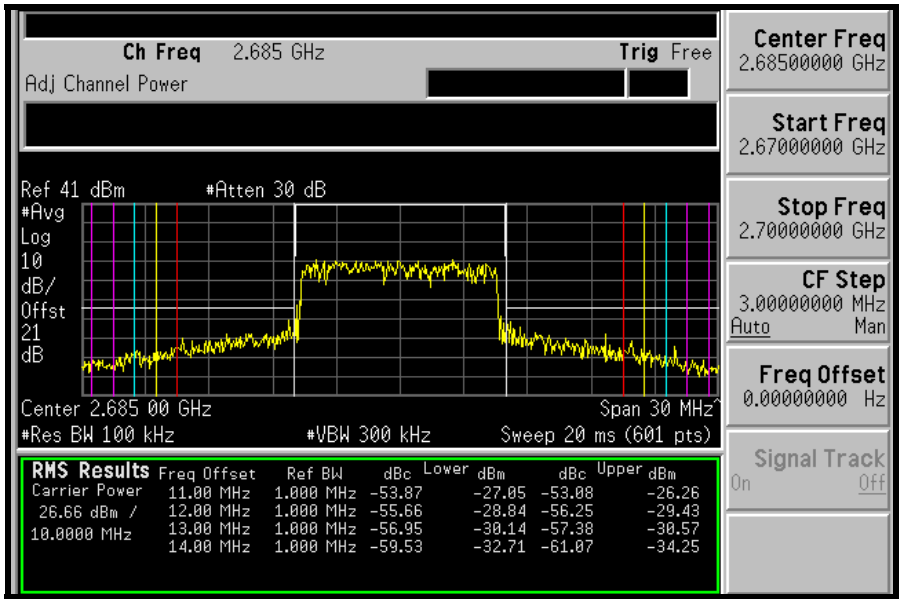
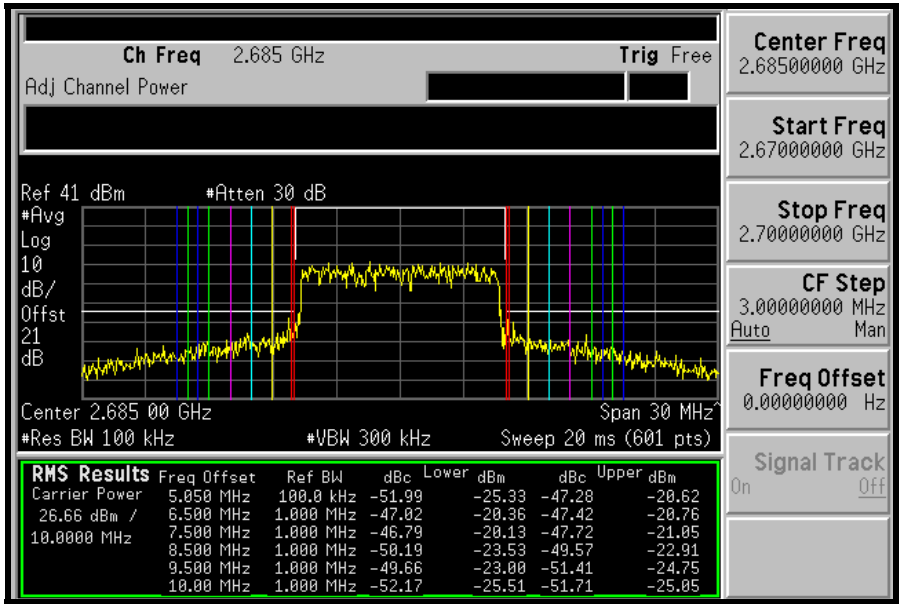



A D T

## 4.5 CONDUCTED SPURIOUS EMISSIONS

### 4.5.1 LIMITS OF CONDUCTED SPURIOUS EMISSIONS MEASUREMENT

In the FCC 27.53(m)(2), On any frequency outside a licensee's frequency block, the power of any emission shall be attenuated below the transmitter power (P) by at least  $43+10 \log (P)$ dB. The limit of emission equal to  $-13m$ .

### 4.5.2 TEST INSTRUMENTS

DESCRIPTION & MANUFACTURER	MODEL NO.	SERIAL NO.	DATE OF CALIBRATION	DUE DATE OF CALIBRATION
Spectrum Analyzer Agilent	E4446A	MY44360128	Dec. 12, 2008	Dec.11. 2009
* Wainwright Instruments High Pass Filter	WHK3.1/18G-10 SS	ZZ-010091	NA	NA
* JFW 10dB attenuation	50HF-010-SMA	NA	NA	NA
* Suhner RF cable	Sucoflex104	204850/4	NA	Jun. 25, 2009

**NOTE:** 1. The calibration interval of the above test instruments is 12 months. And the calibrations are traceable to NML/ROC and NIST/USA.

2. "\*" = These equipments are used for the final measurement.

#### 4.5.3 TEST PROCEDURE

- a. All measurements were done at 3 channels: low, middle and high operational frequency range.
- b. When the spectrum scanned from 30MHz to 3GHz, it shall be connected to the 20dB pad attenuated the carried frequency. The spectrum set  $RB = 1\text{MHz}$ ,  $VB = 3\text{MHz}$ .
- c. When the spectrum scanned from 3GHz to 27GHz, it shall be connected to the high pass filter attenuated the carried frequency. The spectrum set  $RB = 1\text{MHz}$ ,  $VB = 3\text{MHz}$ .

#### 4.5.4 TEST SETUP

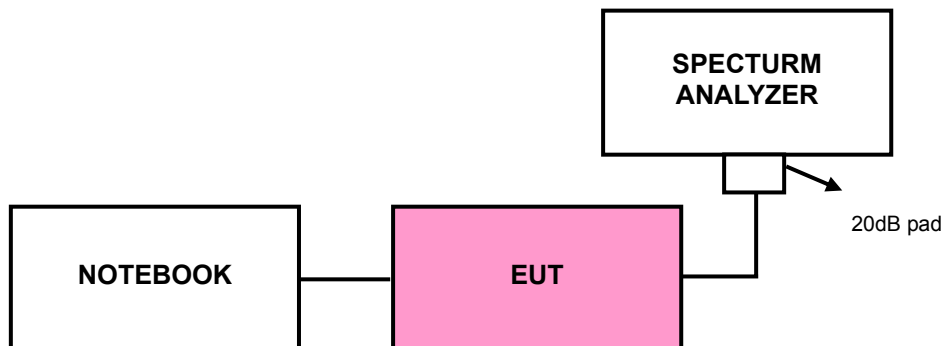

#### 4.5.5 EUT OPERATING CONDITIONS

Same as 4.1.5

## 4.5.6 TEST RESULTS

### CHANNEL BANDWIDTH: 5MHz

#### LOW CHANNEL: 30MHz ~ 1GHz:

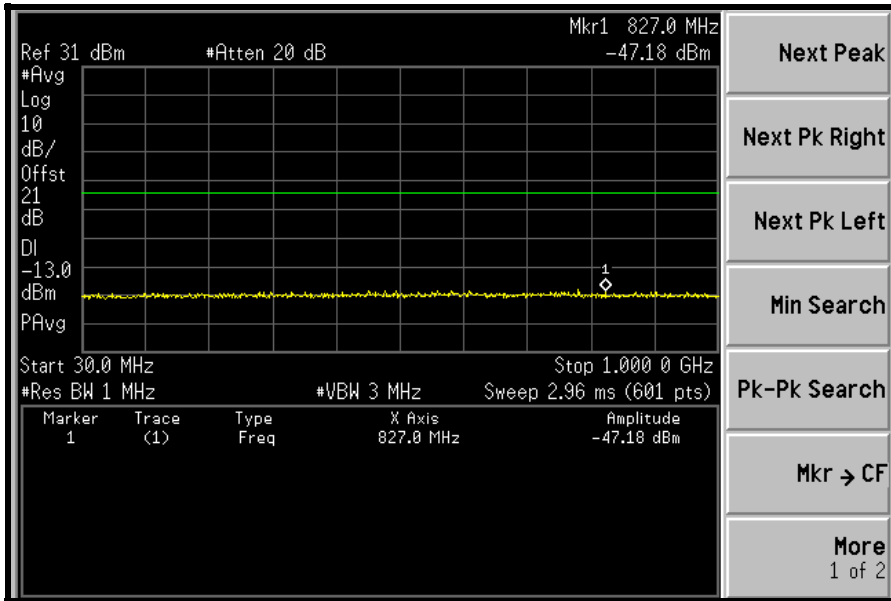

#### 1GHz ~ 3GHz:

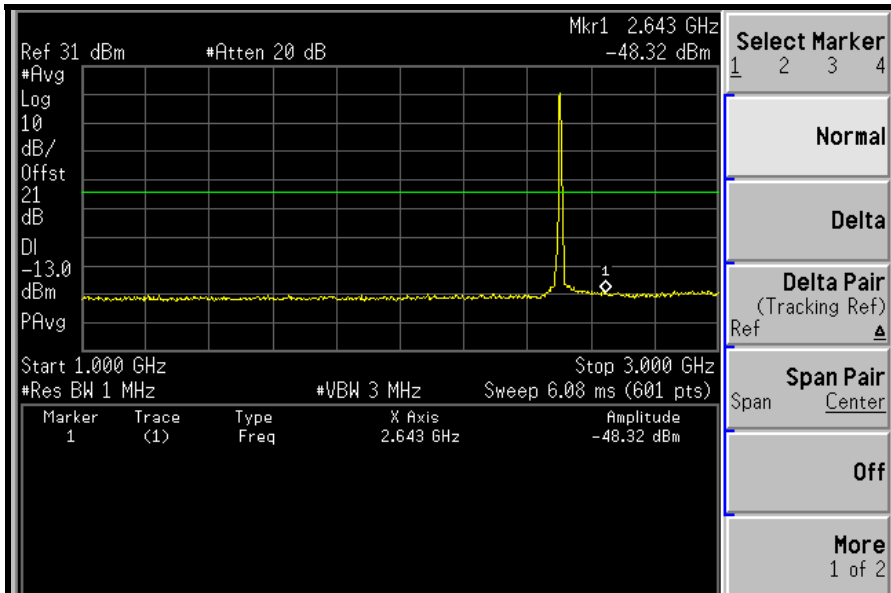



A D T

3GHz ~ 10GHz:

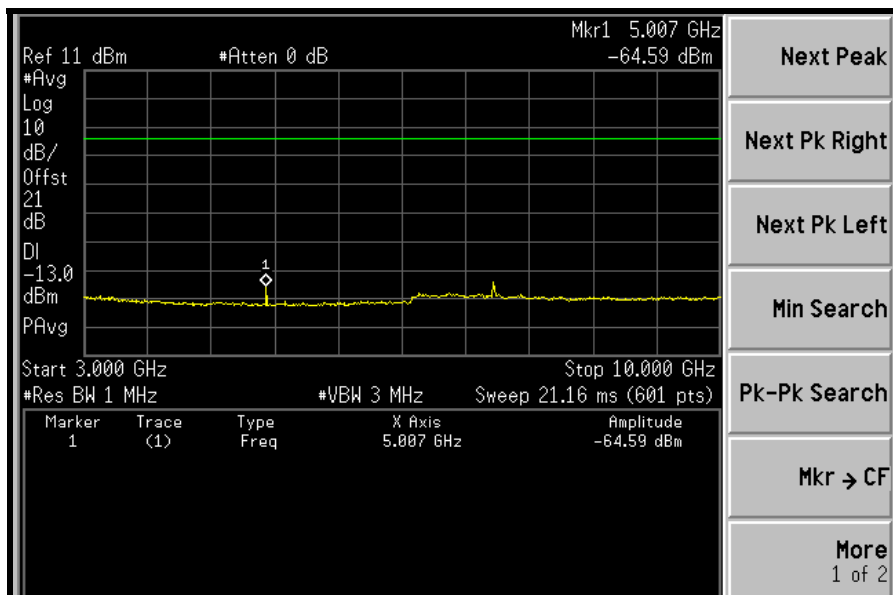

10GHz ~ 27GHz:

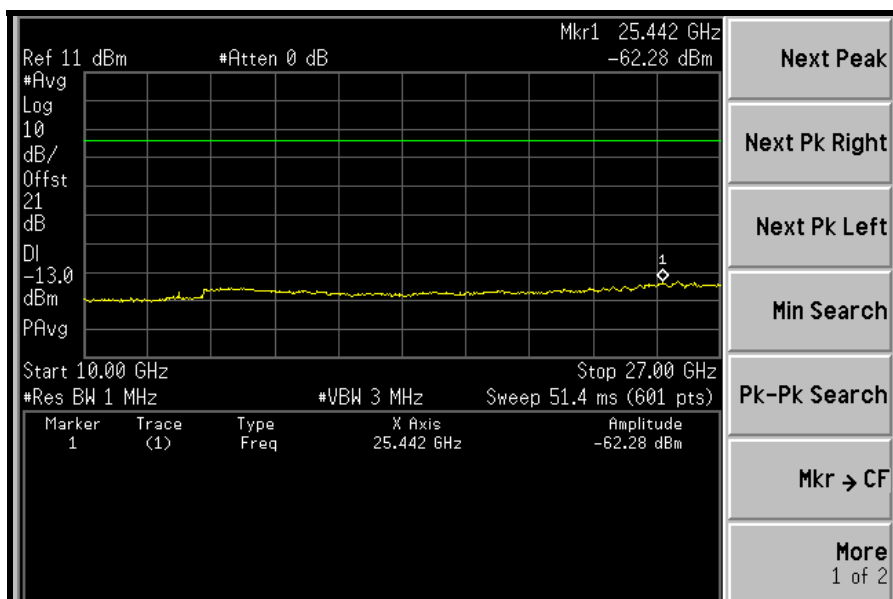



A D T

**MIDDLE CHANNEL: 30MHz ~ 1GHz:**

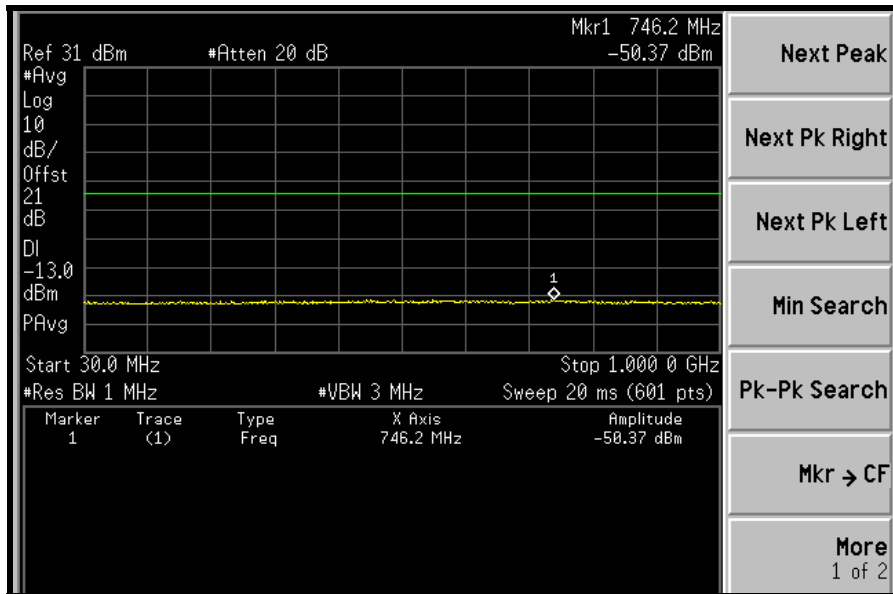

**1GHz ~ 3GHz:**

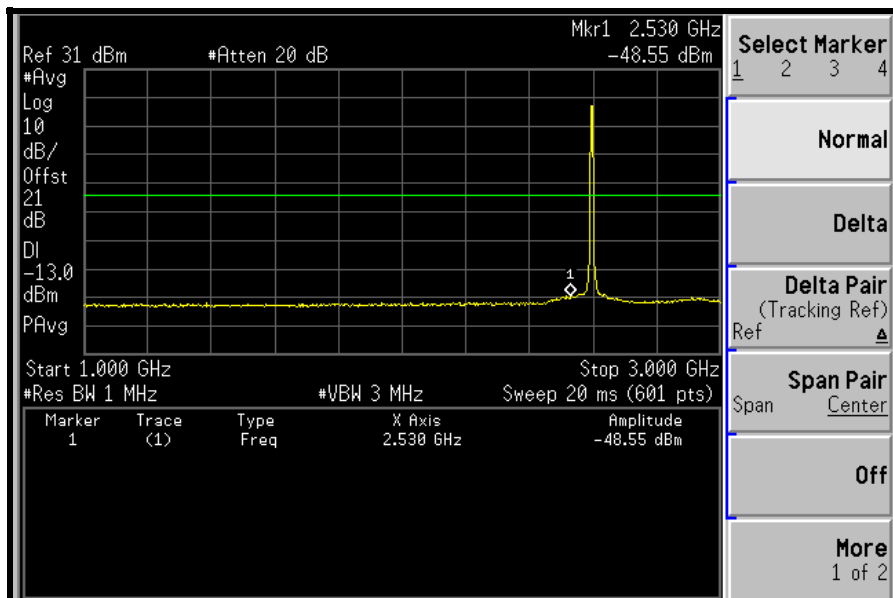





A D T

3GHz ~ 10GHz:

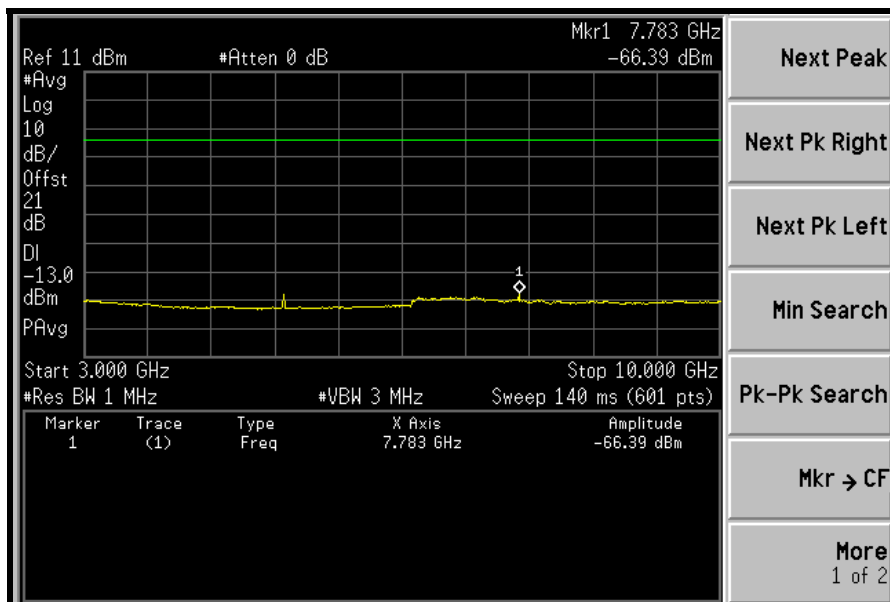

10GHz ~ 27GHz:

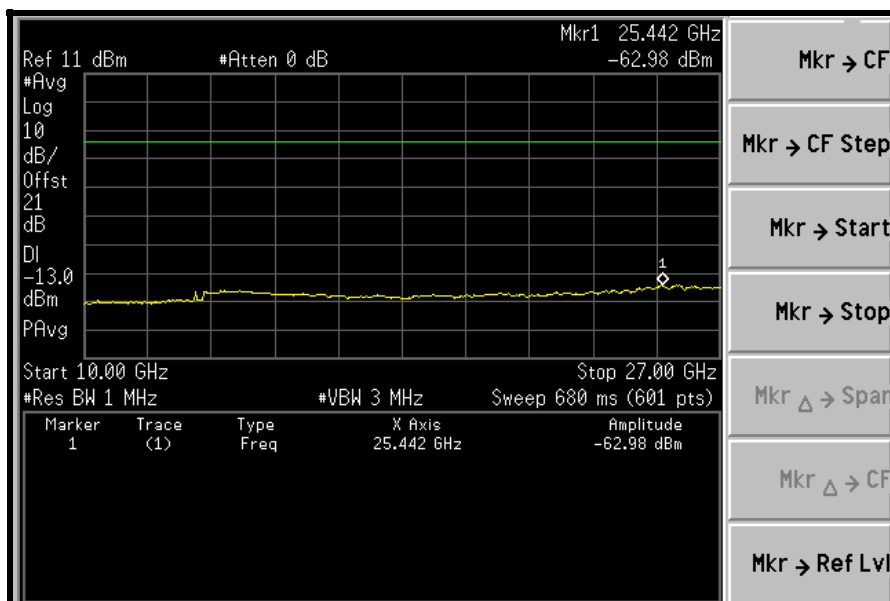



A D T

### HIGH CHANNEL: 30MHz ~ 1GHz:

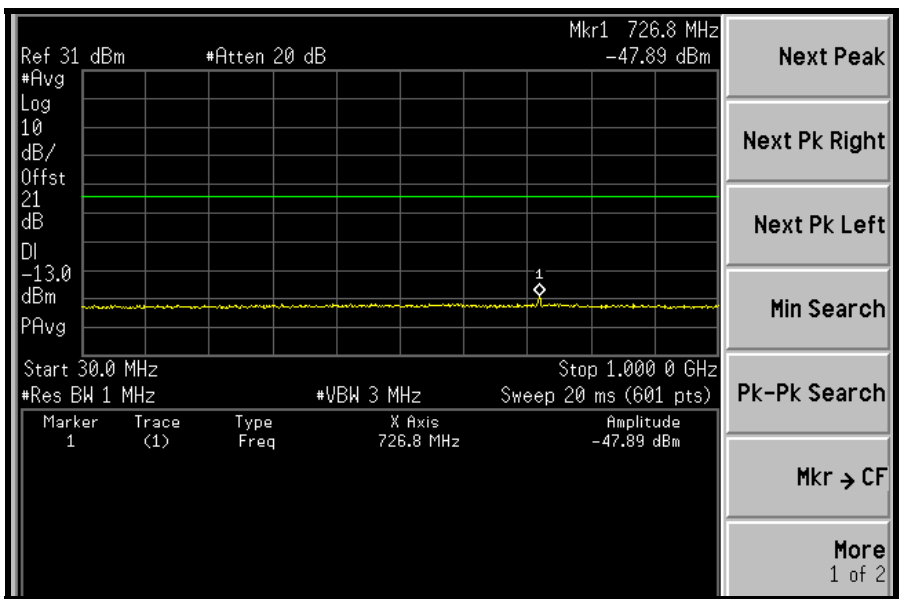

### 1GHz ~ 3GHz:

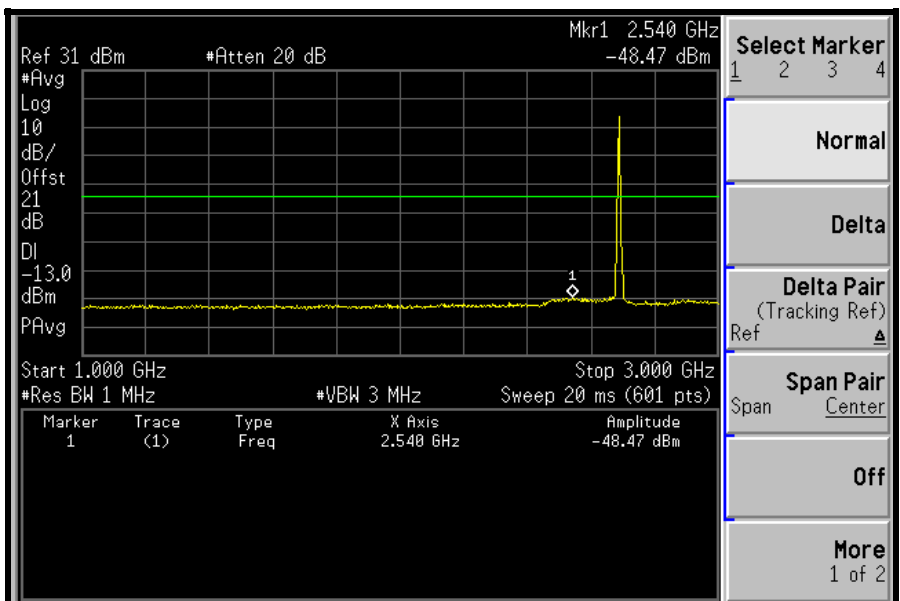



A D T

3GHz ~ 10GHz:

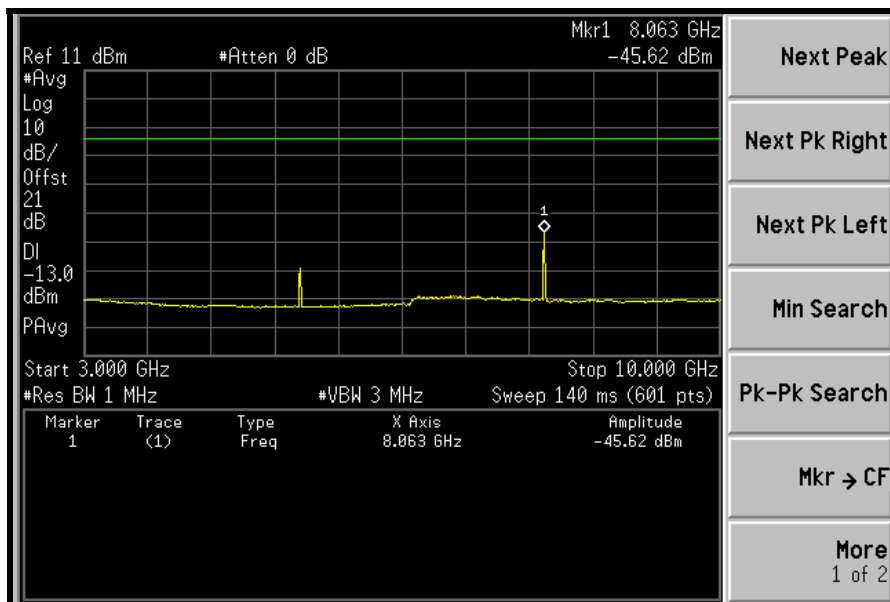

10GHz ~ 27GHz:

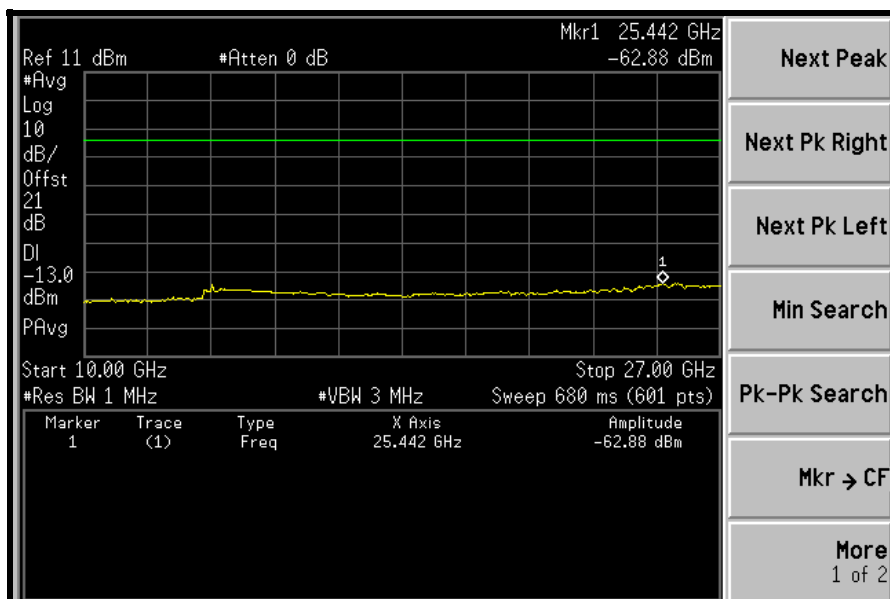



A D T

### CHANNEL BANDWIDTH: 10MHz

LOW CHANNEL: 30MHz ~ 1GHz:

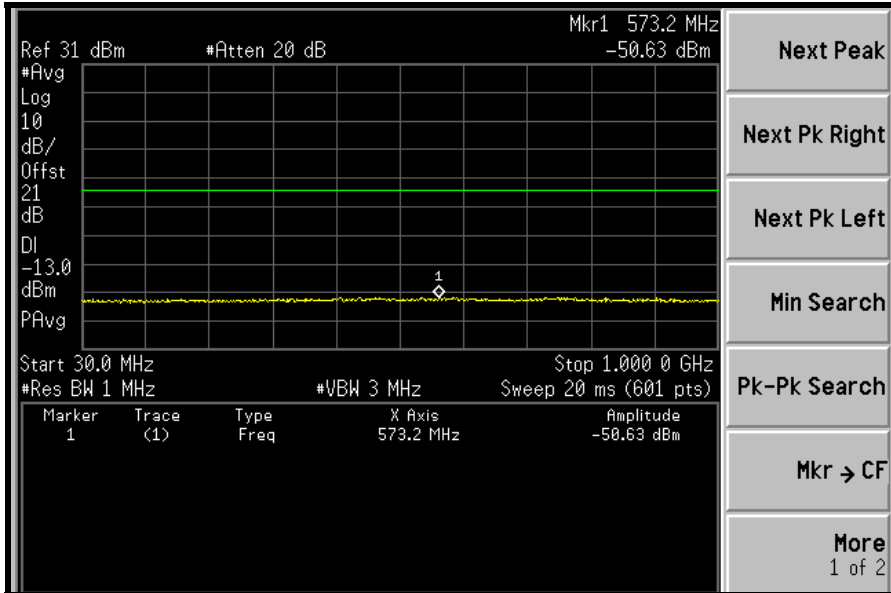

1GHz ~ 3GHz:

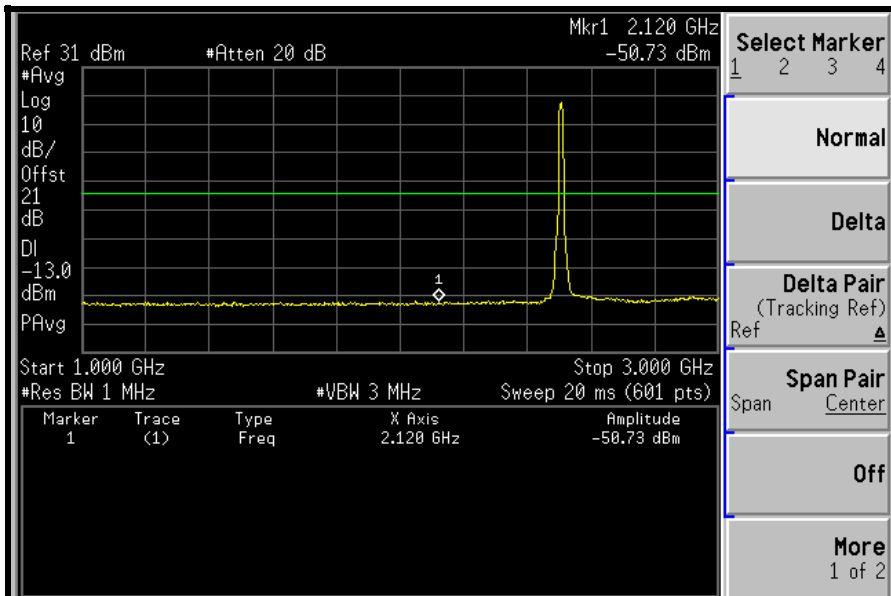



A D T

3GHz ~ 10GHz:

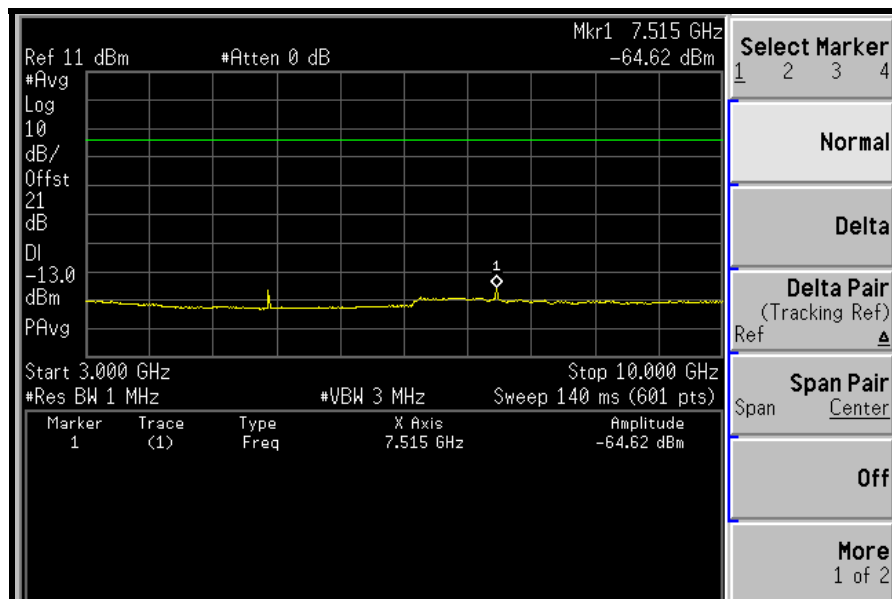

10GHz ~ 27GHz:

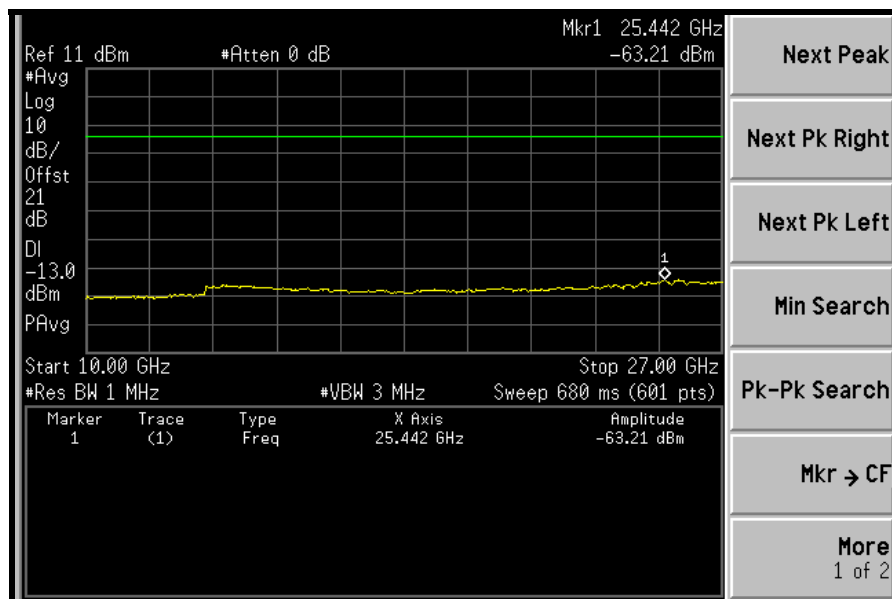



A D T

### MIDDLE CHANNEL: 30MHz ~ 1GHz:

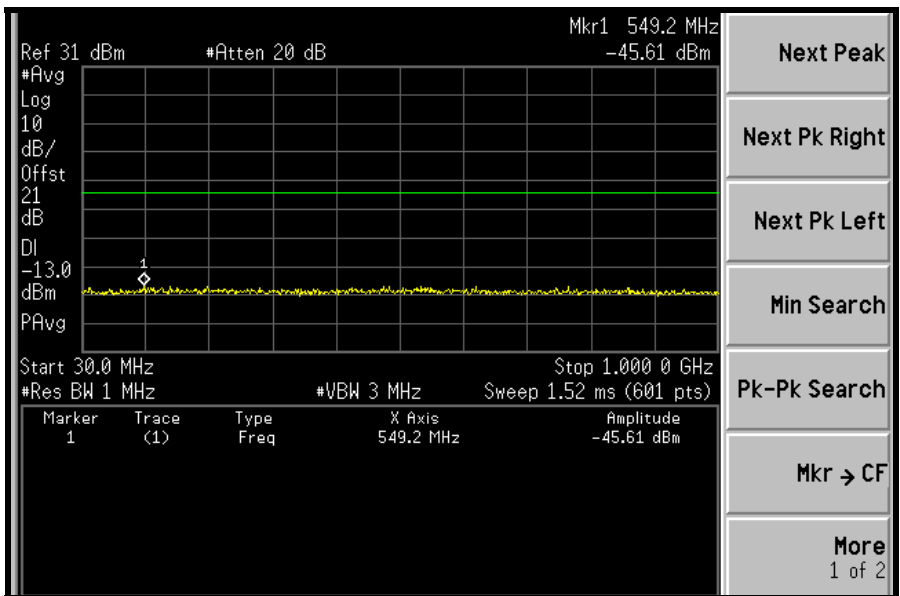

### 1GHz ~ 3GHz:

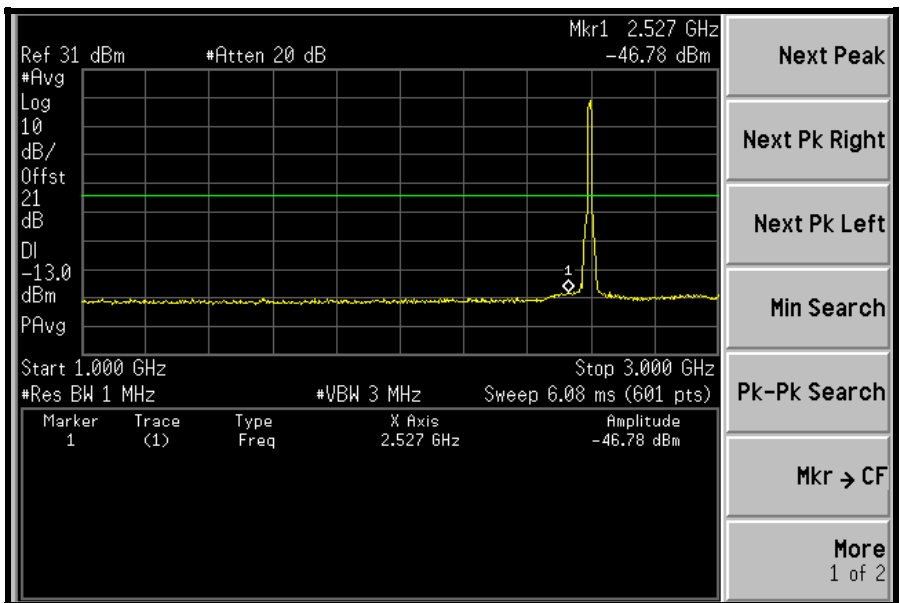



A D T

3GHz ~ 10GHz:

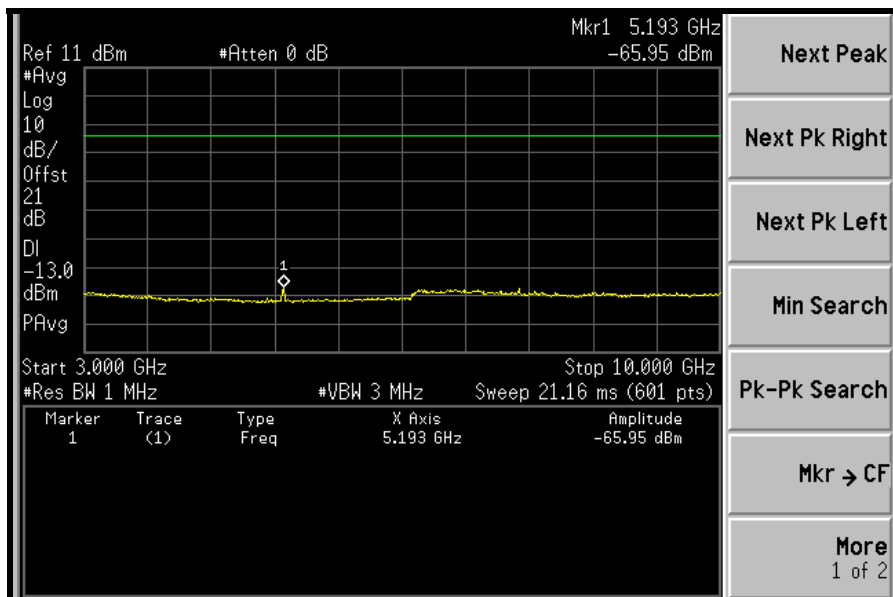

10GHz ~ 27GHz:

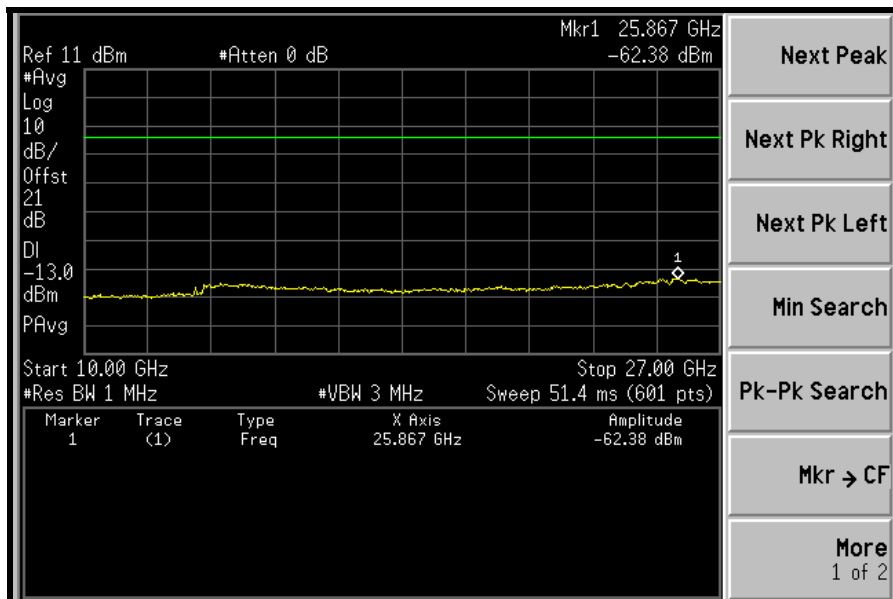



A D T

### HIGH CHANNEL: 30MHz ~ 1GHz:

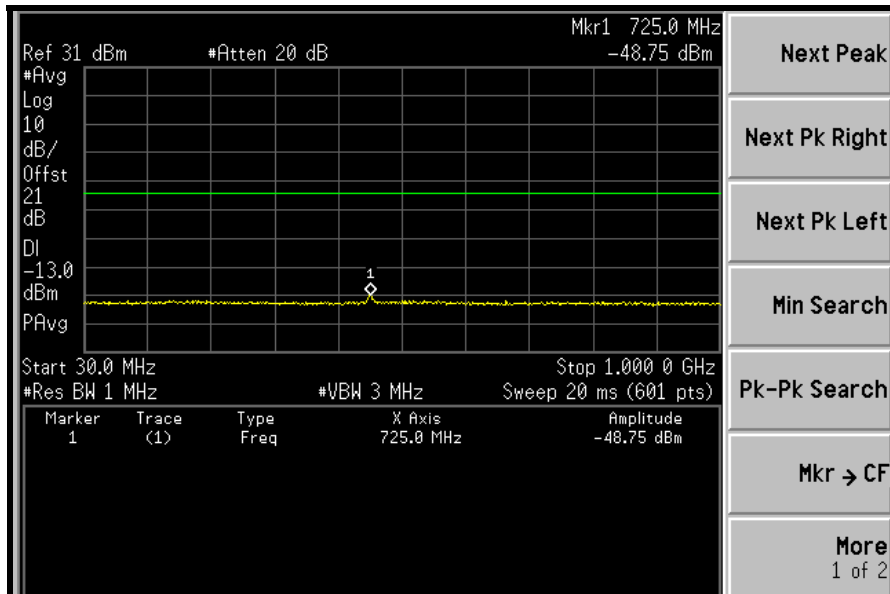

### 1GHz ~ 3GHz:

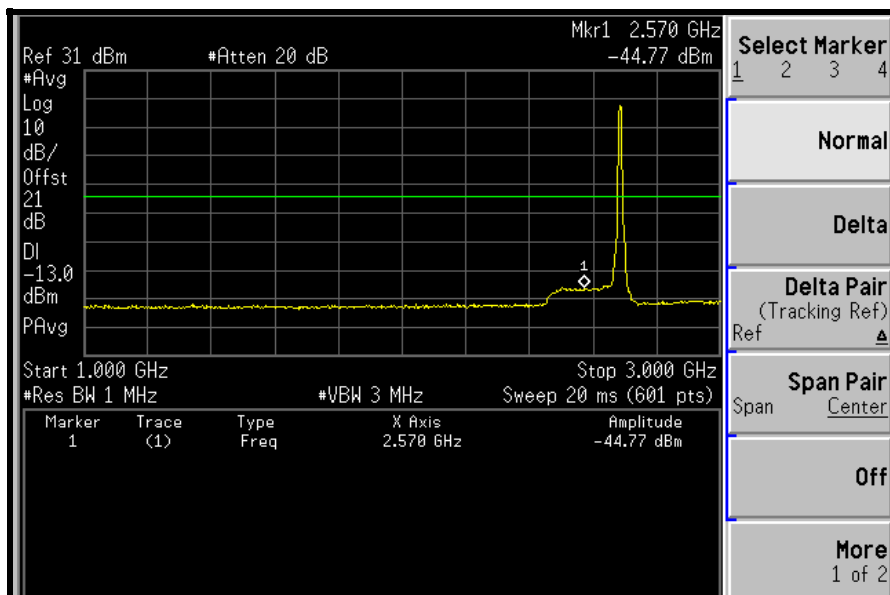





A D T

3GHz ~ 10GHz:

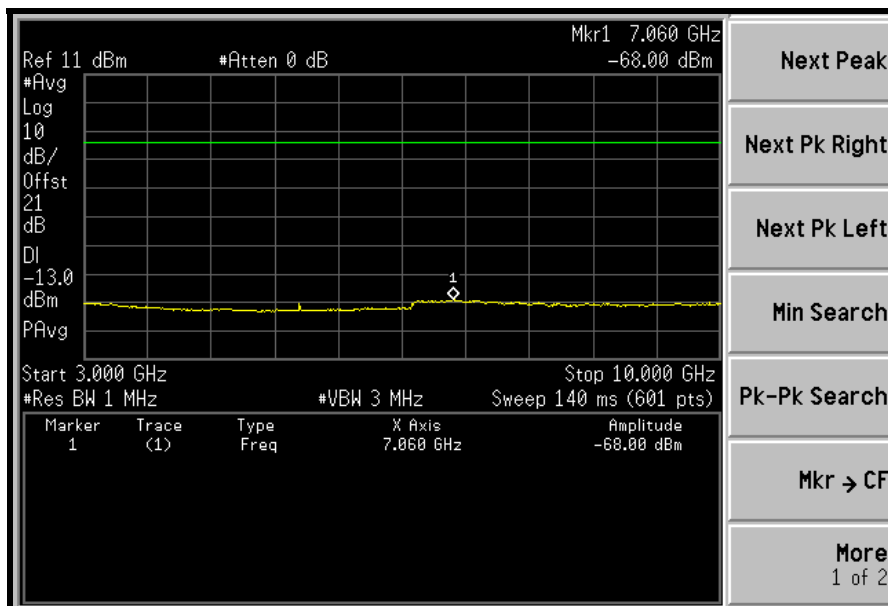

10GHz ~ 27GHz:

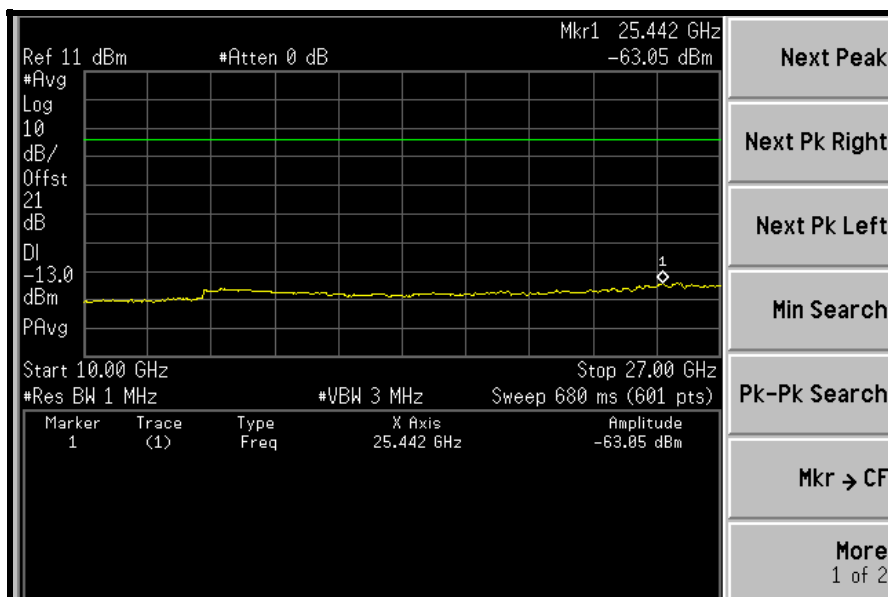



A D T

## 4.6 RADIATED EMISSION MEASUREMENT (BELOW 1GHz)

### 4.6.1 LIMITS OF RADIATED EMISSION MEASUREMENT

In the FCC 27.53(m) (2), On any frequency outside a licensee's frequency block the power of any emission shall be attenuated below the transmitter power (P) by at least  $43 + 10 \log (P)$ dB. The limit of emission equal to  $-13$ dBm.



A D T

#### 4.6.2 TEST INSTRUMENTS

DESCRIPTION & MANUFACTURER	MODEL NO.	SERIAL NO.	DATE OF CALIBRATION	DUE DATE OF CALIBRATION
Test Receiver ROHDE & SCHWARZ	ESI7	838496/016	Dec. 29, 2008	Dec. 28, 2009
Spectrum Analyzer ROHDE & SCHWARZ	FSP40	100039	Dec. 08, 2008	Dec. 07, 2009
BILOG Antenna SCHWARZBECK	VULB9168	9168-155	Apr. 30, 2008	Apr. 29, 2009
HORN Antenna SCHWARZBECK	BBHA 9120D	9120D-408	Dec. 29, 2008	Dec. 28, 2009
HORN Antenna SCHWARZBECK	BBHA 9170	BBHA9170242	Jan. 06, 2009	Jan. 05, 2010
Preamplifier Agilent	8449B	3008A01960	Nov. 03, 2008	Nov. 02, 2009
Preamplifier Agilent	8447D	2944A10631	Nov. 03, 2008	Nov. 02, 2009
RF signal cable HUBER+SUHNNER	SUCOFLEX 104	274041/4	Aug. 21, 2008	Aug. 20, 2009
RF signal cable HUBER+SUHNNER	SUCOFLEX 104	283397/4	Aug. 21, 2008	Aug. 20, 2009
Software ADT.	ADT_Radiated_ V7.6.15.9.2	NA	NA	NA
Antenna Tower inn-co GmbH	MA 4000	010303	NA	NA
Antenna Tower Controller inn-co GmbH	CO2000	019303	NA	NA
Turn Table ADT.	TT100.	TT93021704	NA	NA
Turn Table Controller ADT.	SC100.	SC93021704	NA	NA

- NOTE:**
1. The calibration interval of the above test instruments is 12 months and the calibrations are traceable to NML/ROC and NIST/USA.
  2. The test was performed in HwaYa Chamber 4.
  3. The horn antenna and HP preamplifier (model: 8449B) are used only for the measurement of emission frequency above 1GHz if tested.
  4. The FCC Site Registration No. is 988962.
  5. The IC Site Registration No. is IC7450F-4.



A D T

#### 4.6.3 TEST PROCEDURES

- a. The power was measured with R&S Spectrum Analyzer. All measurements were done at 3 channels (low, middle and high channel of operational frequency range.)
- b. Substitution method is used for E.I.R.P measurement . In the semi-anechoic chamber, EUT placed on the 0.8m height of Turn Table, rotated the table around 360 degrees to search the maximum radiation power and receiver antenna shall be rotated vertical and horizontal polarization and moved height from 1m to 4m to find the maximum polar radiated power. The “Read Value” is the spectrum reading the maximum power value.
- c. The substitution antenna is substituted for EUT at the same position and signals generator export the CW signal to the substitution antenna via a tx cable . Rotated the Turn Table and moved receiving antenna to find the maximum radiation power. Adjust output power level of S.G to get a Value of spectrum reading equal to “Read Value “ of step b. Record the power level of S.G
- d.  $EIRP = \text{Output power level of S.G} - \text{TX cable loss} + \text{Antenna gain of substitution antenna.}$

**NOTE:** The resolution bandwidth and video bandwidth of test receiver/spectrum analyzer is 1MHz/3MHz

#### 4.6.4 DEVIATION FROM TEST STANDARD

No deviation

#### 4.6.5 TEST SETUP

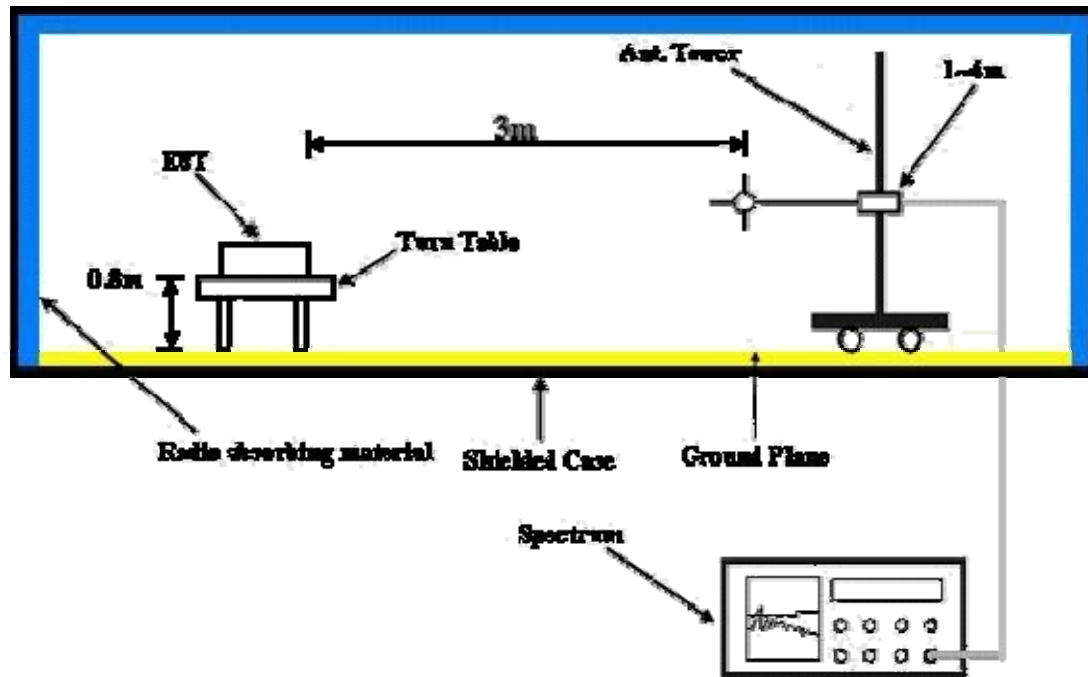

For the actual test configuration, please refer to the related item – Photographs of the Test Configuration.

#### 4.6.6 EUT OPERATING CONDITIONS

Same as 4.1.5



A D T

#### 4.6.7 TEST RESULTS

<b>MODE</b>	Middle channel	<b>FREQUENCY RANGE</b>	Below 1000MHz
<b>INPUT POWER</b>	120Vac, 60Hz	<b>ENVIRONMENTAL CONDITIONS</b>	25deg°C, 63%RH 991hPa
<b>CHANNEL BANDWIDTH</b>	5MHz	<b>TESTED BY</b>	Dean Wang

ANTENNA POLARITY & TEST DISTANCE: HORIZONTAL AT 3m						
NO.	FREQ. (MHz)	EMISSION LEVEL (dBuV)	LIMIT (dBm)	S.G POWER VALUE (dBm)	CORRECTION FACTOR (dB)	POWER VALUE (dBm)
1	33.89	54.17	-13.00	-32.46	-7.40	-39.86
2	99.98	44.33	-13.00	-42.51	-7.40	-49.91
3	203.01	44.08	-13.00	-42.74	-7.50	-50.24
4	243.83	44.32	-13.00	-42.18	-7.50	-49.68
5	284.65	39.18	-13.00	-47.31	-7.50	-54.81
6	552.91	38.65	-13.00	-47.66	-7.60	-55.26
ANTENNA POLARITY & TEST DISTANCE: VERTICAL AT 3m						
NO.	FREQ. (MHz)	EMISSION LEVEL (dBuV/m)	LIMIT (dBm)	S.G POWER VALUE (dBm)	CORRECTION FACTOR (dB)	POWER VALUE (dBm)
1	37.78	47.74	-13.00	-41.12	-7.40	-48.52
2	109.70	38.57	-13.00	-50.02	-7.40	-57.42
3	175.79	35.54	-13.00	-53.19	-7.40	-60.59
4	282.71	38.97	-13.00	-49.94	-7.50	-57.44
5	370.18	34.62	-13.00	-54.12	-7.50	-61.62
6	521.80	39.25	-13.00	-49.54	-7.60	-57.14

**NOTE 1:** Power Value (dBum) = S.G Power Value (dBm) + Correction Factor (dB).

**NOTE 2:** Correction Factor = Antenna gain of substitution antenna- tx cable loss



A D T

<b>MODE</b>	Middle channel	<b>FREQUENCY RANGE</b>	Below 1000MHz
<b>INPUT POWER</b>	120Vac, 60Hz	<b>ENVIRONMENTAL CONDITIONS</b>	25deg°C, 63%RH 991hPa
<b>CHANNEL BANDWIDTH</b>	10MHz	<b>TESTED BY</b>	Dean Wang

ANTENNA POLARITY & TEST DISTANCE: HORIZONTAL AT 3m						
NO.	FREQ. (MHz)	EMISSION LEVEL (dBuV)	LIMIT (dBm)	S.G POWER VALUE (dBm)	CORRECTION FACTOR (dB)	POWER VALUE (dBm)
1	80.54	42.93	-13.00	-46.05	-7.40	-53.45
2	107.76	50.06	-13.00	-38.86	-7.40	-46.26
3	150.52	50.09	-13.00	-38.63	-7.40	-46.03
4	288.54	43.61	-13.00	-45.19	-7.50	-52.69
5	803.67	42.20	-13.00	-46.44	-7.70	-54.14
6	933.91	48.28	-13.00	-39.96	-7.70	-47.66
ANTENNA POLARITY & TEST DISTANCE: VERTICAL AT 3m						
NO.	FREQ. (MHz)	EMISSION LEVEL (dBuV/m)	LIMIT (dBm)	S.G POWER VALUE (dBm)	CORRECTION FACTOR (dB)	POWER VALUE (dBm)
1	37.78	58.50	-13.00	-28.22	-7.40	-35.62
2	115.53	54.16	-13.00	-32.81	-7.40	-40.21
3	249.66	57.36	-13.00	-29.02	-7.50	-36.52
4	490.70	51.57	-13.00	-34.85	-7.60	-42.45
5	679.26	51.84	-13.00	-34.61	-7.60	-42.21
6	751.18	55.93	-13.00	-30.34	-7.70	-38.04

**NOTE 1:** Power Value (dBum) = S.G Power Value (dBm) + Correction Factor (dB).

**NOTE 2:** Correction Factor = Antenna gain of substitution antenna- tx cable loss



A D T

## **4.7 RADIATED EMISSION MEASUREMENT (ABOVE 1GHz)**

### **4.7.1 LIMITS OF RADIATED EMISSION MEASUREMENT**

In the FCC 27.53(m) (4), On any frequency outside a licensee's frequency block, the power of any emission shall be attenuated below the transmitter power (P) by at least  $55 + 10 \log (P)$ dB. The limit of emission equal to  $-25$ dBm.





#### 4.7.2 TEST INSTRUMENTS

DESCRIPTION & MANUFACTURER	MODEL NO.	SERIAL NO.	DATE OF CALIBRATION	DUE DATE OF CALIBRATION
Test Receiver ROHDE & SCHWARZ	ESI7	838496/016	Dec. 29, 2008	Dec. 28, 2009
Spectrum Analyzer ROHDE & SCHWARZ	FSP40	100039	Dec. 08, 2008	Dec. 07, 2009
BILOG Antenna SCHWARZBECK	VULB9168	9168-155	Apr. 30, 2008	Apr. 29, 2009
HORN Antenna SCHWARZBECK	BBHA 9120D	9120D-408	Dec. 29, 2008	Dec. 28, 2009
HORN Antenna SCHWARZBECK	BBHA 9170	BBHA9170242	Jan. 06, 2009	Jan. 05, 2010
Preamplifier Agilent	8449B	3008A01960	Nov. 03, 2008	Nov. 02, 2009
Preamplifier Agilent	8447D	2944A10631	Nov. 03, 2008	Nov. 02, 2009
RF signal cable HUBER+SUHNNER	SUCOFLEX 104	274041/4	Aug. 21, 2008	Aug. 20, 2009
RF signal cable HUBER+SUHNNER	SUCOFLEX 104	283397/4	Aug. 21, 2008	Aug. 20, 2009
Software ADT.	ADT_Radiated_ V7.6.15.9.2	NA	NA	NA
Antenna Tower inn-co GmbH	MA 4000	010303	NA	NA
Antenna Tower Controller inn-co GmbH	CO2000	019303	NA	NA
Turn Table ADT.	TT100.	TT93021704	NA	NA
Turn Table Controller ADT.	SC100.	SC93021704	NA	NA

- NOTE:**
1. The calibration interval of the above test instruments is 12 months and the calibrations are traceable to NML/ROC and NIST/USA.
  2. The test was performed in HwaYa Chamber 4.
  3. The horn antenna and HP preamplifier (model: 8449B) are used only for the measurement of emission frequency above 1GHz if tested.
  4. The FCC Site Registration No. is 988962.
  5. The IC Site Registration No. is IC7450F-4.

#### 4.7.3 TEST PROCEDURES

- a. The power was measured with R&S Spectrum Analyzer. All measurements were done at 3 channels (low, middle and high channel of operational frequency range.)
- b. Substitution method is used for E.I.R.P measurement. In the semi-anechoic chamber, EUT placed on the 0.8m height of Turn Table, rotated the table around 360 degrees to search the maximum radiation power and receiver antenna shall be rotated vertical and horizontal polarization and moved height from 1m to 4m to find the maximum polar radiated power. The “Read Value” is the spectrum reading the maximum power value.
- c. The substitution antenna is substituted for EUT at the same position and signals generator export the CW signal to the substitution antenna via a tx cable . Rotated the Turn Table and moved receiving antenna to find the maximum radiation power. Adjust output power level of S.G to get a Value of spectrum reading equal to “Read Value “ of step b. Record the power level of S.G
- d.  $EIRP = \text{Output power level of S.G} - \text{TX cable loss} + \text{Antenna gain of substitution antenna.}$

**NOTE:** The resolution bandwidth and video bandwidth of test receiver/spectrum analyzer is 1MHz/3MHz

#### 4.7.4 DEVIATION FROM TEST STANDARD

No deviation

#### 4.7.5 TEST SETUP

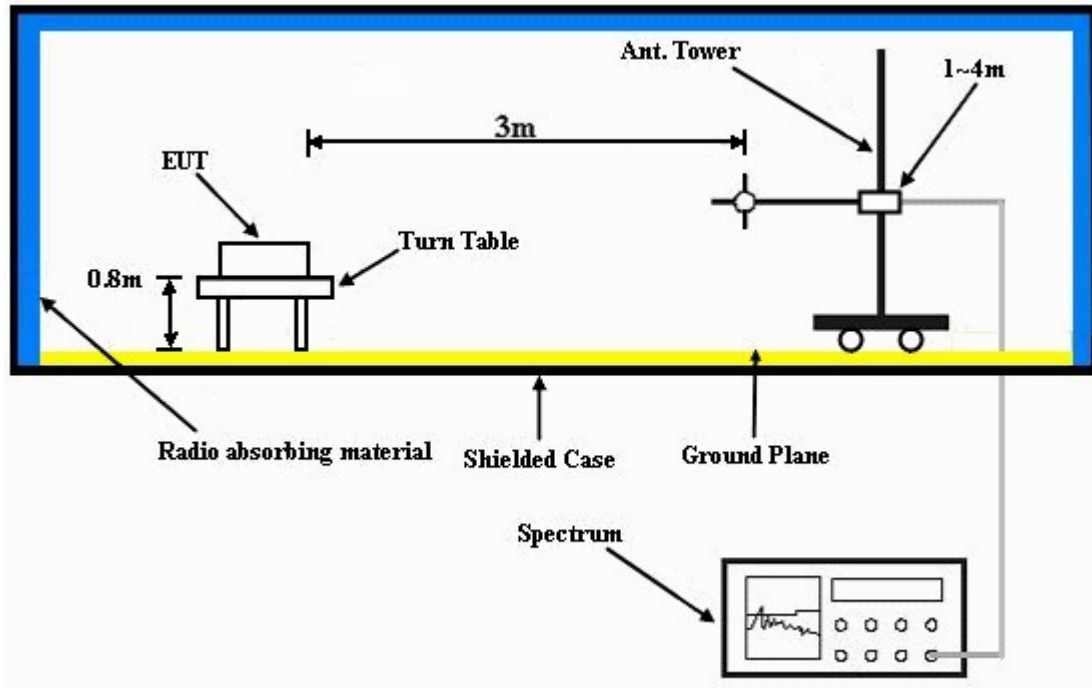

For the actual test configuration, please refer to the related item – Photographs of the Test Configuration.

#### 4.7.6 EUT OPERATING CONDITIONS

Same as 4.6.6.



A D T

#### 4.7.7 TEST RESULTS

<b>MODE</b>	Low channel	<b>FREQUENCY RANGE</b>	Above 1000MHz
<b>INPUT POWER</b>	120Vac, 60Hz	<b>ENVIRONMENTAL CONDITIONS</b>	25deg°C, 63%RH 991hPa
<b>CHANNEL BANDWIDTH</b>	5MHz	<b>TESTED BY</b>	Dean Wang

ANTENNA POLARITY & TEST DISTANCE: HORIZONTAL AT 3m						
NO.	FREQ. (MHz)	EMISSION LEVEL (dBuV)	LIMIT (dBm)	S.G POWER VALUE (dBm)	CORRECTION FACTOR (dB)	POWER VALUE (dBm)
1	5005.00	58.23	-13.00	-45.30	9.49	-35.81
2	7507.50	66.16	-13.00	-35.98	7.83	-28.15

ANTENNA POLARITY & TEST DISTANCE: VERTICAL AT 3m						
NO.	FREQ. (MHz)	EMISSION LEVEL (dBuV/m)	LIMIT (dBm)	S.G POWER VALUE (dBm)	CORRECTION FACTOR (dB)	POWER VALUE (dBm)
1	5005.00	55.57	-13.00	-50.07	9.49	-40.58
2	7507.50	67.52	-13.00	-36.77	7.83	-28.94

**NOTE 1:** Power Value (dBm) = S.G Power Value (dBm) + Correction Factor (dB).

**NOTE 2:** Correction Factor = Antenna gain of substitution antenna- tx cable loss



A D T

<b>MODE</b>	Middle channel	<b>FREQUENCY RANGE</b>	Above 1000MHz
<b>INPUT POWER</b>	120Vac, 60Hz	<b>ENVIRONMENTAL CONDITIONS</b>	25deg°C, 63%RH 991hPa
<b>CHANNEL BANDWIDTH</b>	5MHz	<b>TESTED BY</b>	Dean Wang

<b>ANTENNA POLARITY &amp; TEST DISTANCE: HORIZONTAL AT 3m</b>						
<b>NO.</b>	<b>FREQ. (MHz)</b>	<b>EMISSION LEVEL (dBuV)</b>	<b>LIMIT (dBm)</b>	<b>S.G POWER VALUE (dBm)</b>	<b>CORRECTION FACTOR (dB)</b>	<b>POWER VALUE (dBm)</b>
1	5190.00	61.72	-13.00	-41.99	9.74	-32.25
2	7785.00	67.67	-13.00	-36.25	7.76	-28.49
<b>ANTENNA POLARITY &amp; TEST DISTANCE: VERTICAL AT 3m</b>						
<b>NO.</b>	<b>FREQ. (MHz)</b>	<b>EMISSION LEVEL (dBuV/m)</b>	<b>LIMIT (dBm)</b>	<b>S.G POWER VALUE (dBm)</b>	<b>CORRECTION FACTOR (dB)</b>	<b>POWER VALUE (dBm)</b>
1	5190.00	59.55	-13.00	-46.55	9.74	-36.81
2	7785.00	68.45	-13.00	-35.60	7.76	-27.84

**NOTE 1:** Power Value (dBum) = S.G Power Value (dBm) + Correction Factor (dB).

**NOTE 2:** Correction Factor = Antenna gain of substitution antenna- tx cable loss



A D T

<b>MODE</b>	High channel	<b>FREQUENCY RANGE</b>	Above 1000MHz
<b>INPUT POWER</b>	120Vac, 60Hz	<b>ENVIRONMENTAL CONDITIONS</b>	25deg°C, 63%RH 991hPa
<b>CHANNEL BANDWIDTH</b>	5MHz	<b>TESTED BY</b>	Dean Wang

ANTENNA POLARITY & TEST DISTANCE: HORIZONTAL AT 3m						
NO.	FREQ. (MHz)	EMISSION LEVEL (dBuV)	LIMIT (dBm)	S.G POWER VALUE (dBm)	CORRECTION FACTOR (dB)	POWER VALUE (dBm)
1	5375.00	75.11	-13.00	-28.63 9.79	18.84	
2	8062.00	64.41	-13.00	-37.47	7.82	-29.65
ANTENNA POLARITY & TEST DISTANCE: VERTICAL AT 3m						
NO.	FREQ. (MHz)	EMISSION LEVEL (dBuV/m)	LIMIT (dBm)	S.G POWER VALUE (dBm)	CORRECTION FACTOR (dB)	POWER VALUE (dBm)
1	5375.00	70.41	-13.00	-35.67	9.79	-25.88
2	8062.50	64.98	-13.00	-36.93	7.82	-29.11

**NOTE 1:** Power Value (dBum) = S.G Power Value (dBm) + Correction Factor (dB).

**NOTE 2:** Correction Factor = Antenna gain of substitution antenna- tx cable loss



A D T

<b>MODE</b>	Low channel	<b>FREQUENCY RANGE</b>	Above 1000MHz
<b>INPUT POWER</b>	120Vac, 60Hz	<b>ENVIRONMENTAL CONDITIONS</b>	25deg°C, 63%RH 991hPa
<b>CHANNEL BANDWIDTH</b>	10MHz	<b>TESTED BY</b>	Dean Wang

ANTENNA POLARITY & TEST DISTANCE: HORIZONTAL AT 3m						
NO.	FREQ. (MHz)	EMISSION LEVEL (dBuV)	LIMIT (dBm)	S.G POWER VALUE (dBm)	CORRECTION FACTOR (dB)	POWER VALUE (dBm)
1	5010.00	54.16	-13.00	-49.41	9.49	-39.92
2	7515.00	61.35	-13.00	-42.45	7.83	-34.62
ANTENNA POLARITY & TEST DISTANCE: VERTICAL AT 3m						
NO.	FREQ. (MHz)	EMISSION LEVEL (dBuV/m)	LIMIT (dBm)	S.G POWER VALUE (dBm)	CORRECTION FACTOR (dB)	POWER VALUE (dBm)
1	5010.00	52.41	-13.00	-53.30	9.49	-43.81
2	7515.00	63.48	-13.00	-38.42	7.83	-30.59

**NOTE 1:** Power Value (dBm) = S.G Power Value (dBm) + Correction Factor (dB).

**NOTE 2:** Correction Factor = Antenna gain of substitution antenna- tx cable loss



A D T

<b>MODE</b>	Middle channel	<b>FREQUENCY RANGE</b>	Above 1000MHz
<b>INPUT POWER</b>	120Vac, 60Hz	<b>ENVIRONMENTAL CONDITIONS</b>	25deg°C, 63%RH 991hPa
<b>CHANNEL BANDWIDTH</b>	10MHz	<b>TESTED BY</b>	Dean Wang

<b>ANTENNA POLARITY &amp; TEST DISTANCE: HORIZONTAL AT 3m</b>						
<b>NO.</b>	<b>FREQ. (MHz)</b>	<b>EMISSION LEVEL (dBuV)</b>	<b>LIMIT (dBm)</b>	<b>S.G POWER VALUE (dBm)</b>	<b>CORRECTION FACTOR (dB)</b>	<b>POWER VALUE (dBm)</b>
1	5190.00	57.61	-13.00	-46.60	9.74	-36.86
2	7785.00	63.54	-13.00	-40.27	7.76	-32.51

<b>ANTENNA POLARITY &amp; TEST DISTANCE: VERTICAL AT 3m</b>						
<b>NO.</b>	<b>FREQ. (MHz)</b>	<b>EMISSION LEVEL (dBuV/m)</b>	<b>LIMIT (dBm)</b>	<b>S.G POWER VALUE (dBm)</b>	<b>CORRECTION FACTOR (dB)</b>	<b>POWER VALUE (dBm)</b>
1	5190.00	56.27	-13.00	-49.59	9.74	-39.85
2	7785.00	64.87	-130.0	-36.89	7.76	-29.13

**NOTE 1:** Power Value (dBum) = S.G Power Value (dBm) + Correction Factor (dB).

**NOTE 2:** Correction Factor = Antenna gain of substitution antenna- tx cable loss





A D T

<b>MODE</b>	High channel	<b>FREQUENCY RANGE</b>	Above 1000MHz
<b>INPUT POWER</b>	120Vac, 60Hz	<b>ENVIRONMENTAL CONDITIONS</b>	25deg°C, 63%RH 991hPa
<b>CHANNEL BANDWIDTH</b>	10MHz	<b>TESTED BY</b>	Dean Wang

ANTENNA POLARITY & TEST DISTANCE: HORIZONTAL AT 3m						
NO.	FREQ. (MHz)	EMISSION LEVEL (dBuV)	LIMIT (dBm)	S.G POWER VALUE (dBm)	CORRECTION FACTOR (dB)	POWER VALUE (dBm)
1	5370.00	67.13	-13.00	-38.93	9.79	-29.14
2	8055.00	61.57	-13.00	-40.30	7.82	-32.48
ANTENNA POLARITY & TEST DISTANCE: VERTICAL AT 3m						
NO.	FREQ. (MHz)	EMISSION LEVEL (dBuV/m)	LIMIT (dBm)	S.G POWER VALUE (dBm)	CORRECTION FACTOR (dB)	POWER VALUE (dBm)
1	5370.00	70.89	-13.00	-32.94	9.79	-23.15
2	8055.00	60.46	-13.00	-43.44	7.82	-35.62

**NOTE 1:** Power Value (dBum) = S.G Power Value (dBm) + Correction Factor (dB).

**NOTE 2:** Correction Factor = Antenna gain of substitution antenna- tx cable loss



A D T

## 5 PHOTOG RAPHS OF THE TEST CONFIGURATION

Please refer to the attached file (Test Setup Photo).



A D T

## 6 INFORMATION ON THE TESTING LABORATORIES

We, Bureau Veritas Consumer Products Services (H.K.) Ltd., Taoyuan Branch, were founded in 1988 to provide our best service in EMC, Radio, Telecom and Safety consultation. Our laboratories are accredited and approved by the following approval agencies according to ISO/IEC 17025.

<b>USA</b>	FCC, NVLAP
<b>GERMANY</b>	TUV Rheinland
<b>JAPAN</b>	VCCI
<b>NORWAY</b>	NEMKO
<b>CANADA</b>	INDUSTRY CANADA , CSA
<b>R.O.C.</b>	TAF, BSMI, NCC
<b>NETHERLANDS</b>	Telefication
<b>SINGAPORE</b>	GOST-ASIA (MOU)
<b>RUSSIA</b>	CERTIS (MOU)

Copies of accreditation certificates of our laboratories obtained from approval agencies can be downloaded from our web site:

[www.adt.com.tw/index.5/phtml](http://www.adt.com.tw/index.5/phtml). If you have any comments, please feel free to contact us at the following:

**Linko EMC/RF Lab:**

Tel: 886-2-26052180

Fax: 886-2-26051924

**Hsin Chu EMC/RF Lab:**

Tel: 886-3-5935343

Fax: 886-3-5935342

**Hwa Ya EMC/RF/Safety/Telecom Lab: Web Site: [www.adt.com.tw](http://www.adt.com.tw)**

Tel: 886-3-3183232

Fax: 886-3-3185050

The address and road map of all our labs can be found in our web site also.

---END---