



FCC RF Test Report

APPLICANT : Green Packet Berhad, Taiwan
EQUIPMENT : LTE Band 7 Outdoor CPE
BRAND NAME : Green Packet
MODEL NAME : OF-250
FCC ID : W9V-OF250-GP
STANDARD : 47 CFR Part 2, 27
CLASSIFICATION : Licensed Non-Broadcast Station Transmitter (TNB)

The product was received on May 09, 2014 and testing was completed on Jun. 06, 2014. We, SPORTON INTERNATIONAL INC., would like to declare that the tested sample has been evaluated in accordance with the test procedures given in ANSI / TIA / EIA-603-C-2004 and the testing has shown the tested sample to be in compliance with the applicable technical standards.

The test results in this report apply exclusively to the tested model / sample. Without written approval of SPORTON INTERNATIONAL INC., the test report shall not be reproduced except in full.

Reviewed by: Joseph Lin / Supervisor

Approved by: Jones Tsai / Manager



SPORTON INTERNATIONAL INC.

No. 52, Hwa Ya 1st Rd., Hwa Ya Technology Park, Kwei-Shan Hsiang, Tao Yuan Hsien, Taiwan, R.O.C.



TABLE OF CONTENTS

REVISION HISTORY.....3

SUMMARY OF TEST RESULT4

1 GENERAL DESCRIPTION5

 1.1 Applicant.....5

 1.2 Manufacturer.....5

 1.3 Product Feature of Equipment Under Test.....5

 1.4 Product Specification subjective to this standard5

 1.5 Modification of EUT5

 1.6 Maximum ERP/EIRP Power, Frequency Tolerance, and Emission Designator6

 1.7 Testing Location7

 1.8 Applicable Standards.....7

2 TEST CONFIGURATION OF EQUIPMENT UNDER TEST8

 2.1 Test Mode.....8

 2.2 Connection Diagram of Test System.....9

 2.3 Support Unit used in test configuration and system9

 2.4 Measurement Results Explanation Example.....9

3 TEST RESULT.....10

 3.1 Conducted Output Power Measurement and ERP/EIRP Measurement10

 3.2 Peak-to-Average Ratio15

 3.3 Occupied Bandwidth.....20

 3.4 Conducted Band Edge Measurement45

 3.5 Conducted Spurious Emission Measurement62

 3.6 Radiated Spurious Emission Measurement76

 3.7 Frequency Stability Measurement.....91

4 LIST OF MEASURING EQUIPMENT93

5 UNCERTAINTY OF EVALUATION.....94

APPENDIX A. SETUP PHOTOGRAPHS



SUMMARY OF TEST RESULT

Report Section	FCC Rule	Description	Limit	Result	Remark
3.1	§2.1046	Conducted Output Power	Reporting Only	PASS	-
3.2	-	Peak-to-Average Ratio	Reporting Only	PASS	-
3.3	§27.50(h)(1)	Equivalent Isotropic Radiated Power	EIRP < 2Watt	PASS	-
	§2.1049 §27.53(m)(6)	Occupied Bandwidth	Reporting Only	PASS	-
3.4	§2.1051 §27.53(m)(2)	Conducted Band Edge Measurement	< 43+10log10(P[Watts])	PASS	-
3.5	§2.1051 §27.53(m)(2)	Conducted Spurious Emission	< 43+10log10(P[Watts])	PASS	-
3.6	§2.1053 §27.53(m)(2)	Radiated Spurious Emission	< 43+10log10(P[Watts])	PASS	Under limit 0.25 dB at 5002.000 MHz
3.7	§2.1055	Frequency Stability Temperature & Voltage	< 2.5 ppm	PASS	-



1 General Description

1.1 Applicant

Green Packet Berhad, Taiwan

6F, No.21, Lane 583, Rueiguang Rd. Neihu District, Taipei City 11492, Taiwan

1.2 Manufacturer

Green Packet Berhad, Taiwan

6F, No.21, Lane 583, Rueiguang Rd. Neihu District, Taipei City 11492, Taiwan

1.3 Product Feature of Equipment Under Test

Product Feature	
Equipment	LTE Band 7 Outdoor CPE
Brand Name	Green Packet
Model Name	OF-250
FCC ID	W9V-OF250-GP
EUT supports Radios application	LTE
HW Version	A1
SW Version	OF-250_e37i
EUT Stage	Production Unit

Remark: The above EUT's information was declared by manufacturer. Please refer to the specifications or user's manual for more detailed description.

1.4 Product Specification subjective to this standard

Product Specification subjective to this standard	
Tx Frequency	LTE Band 7 : 2502.5 MHz ~ 2567.5 MHz
Rx Frequency	LTE Band 7 : 2622.5MHz ~ 2687.5 MHz
Bandwidth	LTE Band 7 : 5MHz/ 10MHz / 15MHz / 20MHz
Maximum Output Power to Antenna	LTE Band 7 : 21.66 dBm
Antenna Type	PATCH Antenna
Antenna Gain	LTE Band 7 :11.00 dBi
Type of Modulation	QPSK / 16QAM

1.5 Modification of EUT

No modifications are made to the EUT during all test items.



1.6 Maximum ERP/EIRP Power, Frequency Tolerance, and Emission Designator

FCC Rule	System	Type of Modulation	BW	Emission Designator	Frequency Tolerance (ppm)	Maximum ERP/EIRP
Part 27	LTE Band 7	QPSK	5MHz	4M51G7D	-	1.75W
Part 27	LTE Band 7	16QAM	5MHz	4M51D7W	-	1.38W
Part 27	LTE Band 7	QPSK	10MHz	9M12G7D	0.012 ppm	1.67W
Part 27	LTE Band 7	16QAM	10MHz	9M08D7W	-	1.46W
Part 27	LTE Band 7	QPSK	15MHz	13M5G7D	-	1.70W
Part 27	LTE Band 7	16QAM	15MHz	13M6D7W	-	1.46W
Part 27	LTE Band 7	QPSK	20MHz	22M4G7D	-	1.85W
Part 27	LTE Band 7	16QAM	20MHz	22M4D7W	-	1.55W



1.7 Testing Location

Sporton Lab is accredited to ISO 17025 by Taiwan Accreditation Foundation (TAF code : 1190) and the FCC designation No. TW1022 under the FCC 2.948(e) by Mutual Recognition Agreement (MRA) in FCC Test.

Test Site	SPORTON INTERNATIONAL INC.	
Test Site Location	No. 52, Hwa Ya 1 st Rd., Hwa Ya Technology Park, Kwei-Shan Hsiang, Tao Yuan Hsien, Taiwan, R.O.C. TEL: +886-3-327-3456 FAX: +886-3-328-4978	
Test Site No.	Sporton Site No.	
	TH02-HY	03CH07-HY

1.8 Applicable Standards

According to the specifications of the manufacturer, the EUT must comply with the requirements of the following standards:

- ♦ 47 CFR Part 2, 27
- ♦ ANSI / TIA / EIA-603-C-2004
- ♦ FCC KDB 971168 D01 Power Meas. License Digital Systems v02r01
- ♦ FCC KDB 412172 D01 Determining ERP and EIRP v01

Remark:

1. All test items were verified and recorded according to the standards and without any deviation during the test.
2. This EUT has also been tested and complied with the requirements of FCC Part 15, Subpart B, recorded in a separate test report.



2 Test Configuration of Equipment Under Test

2.1 Test Mode

Antenna port conducted and radiated test items listed below are performed according to KDB 971168 D01 Power Meas. License Digital Systems v02r01 with maximum output power.

Radiated measurements are performed by rotating the EUT in three different orthogonal test planes to find the maximum emission.

Test Items	Band	Bandwidth (MHz)						Modulation		RB #			Test Channel		
		1.4	3	5	10	15	20	QPSK	16QAM	1	Half	Full	L	M	H
Max. Output Power	7	-	-	Y	Y	Y	Y	Y	Y	Y	Y	Y	Y	Y	Y
Peak-to-Average Ratio	7	-	-				Y		Y	Y		Y	Y	Y	Y
26dB and 99% Bandwidth	7	-	-	Y	Y	Y	Y	Y	Y			Y	Y	Y	Y
Conducted Band Edge	7	-	-	Y	Y	Y	Y	Y	Y	Y		Y	Y		Y
Conducted Spurious Emission	7	-	-	Y	Y	Y	Y	Y	Y	Y				Y	
Frequency Stability	7	-	-		Y			Y				Y		Y	
E.R.P/ E.I.R.P.	7	-	-	Y			Y	Y	Y	Y			Y	Y	Y
Radiated Spurious Emission	7	-	-	Y	Y	Y	Y	Y		Y				Y	
Note	<ol style="list-style-type: none"> The mark "v " means that this configuration is chosen for testing The mark "- " means that this bandwidth is not supported. For E.R.P/E.I.R.P. measurement, the widest bandwidth of each band is chosen for testing due to highest conducted power. Besides, the lowest bandwidth of each band is also measured for reporting only. The device is investigated from 30MHz to 10 times of fundamental signal for radiated spurious emission test under different RB size/offset and modulations in exploratory test. Subsequently, only the worst case emissions are reported. 														

2.2 Connection Diagram of Test System

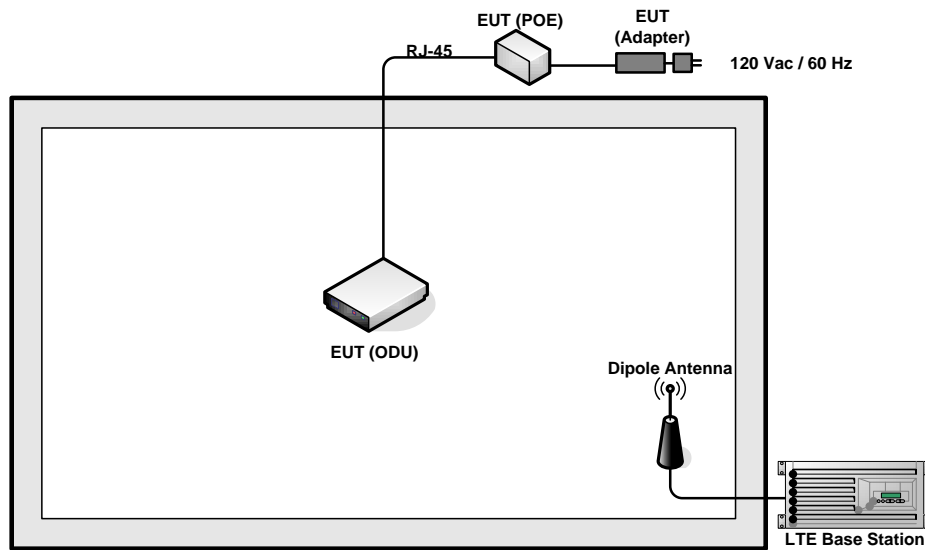

2.3 Support Unit used in test configuration and system

Item	Equipment	Trade Name	Model No.	FCC ID	Data Cable	Power Cord
1.	LTE Base Station	Anritsu	MT8820C	N/A	N/A	Unshielded, 1.8 m

2.4 Measurement Results Explanation Example

For all conducted test items:

The offset level is set in the spectrum analyzer to compensate the RF cable loss and attenuator factor between EUT conducted output port and spectrum analyzer. With the offset compensation, the spectrum analyzer reading level is exactly the EUT RF output level.

The spectrum analyzer offset is derived from RF cable loss and attenuator factor.

Offset = RF cable loss + attenuator factor.

Following shows an offset computation example with cable loss 4.2 dB and 10dB attenuator.

Example :

$$\begin{aligned} \text{Offset(dB)} &= \text{RF cable loss(dB)} + \text{attenuator factor(dB)}. \\ &= 4.2 + 10 = 14.2 \text{ (dB)} \end{aligned}$$

3 Test Result

3.1 Conducted Output Power Measurement and ERP/EIRP Measurement

3.1.1 Description of the Conducted Output Power Measurement and ERP/EIRP Measurement

A system simulator was used to establish communication with the EUT. Its parameters were set to force the EUT transmitting at maximum output power. The measured power in the radio frequency on the transmitter output terminals shall be reported.

The EIRP of mobile transmitters must not exceed 2 Watts for LTE Band 7.

3.1.2 Measuring Instruments

The measuring equipment is listed in the section 4 of this test report.

3.1.3 Test Procedures

1. The transmitter output port was connected to the system simulator.
2. Set EUT at maximum power through the system simulator.
3. Select lowest, middle, and highest channels for each band and different modulation.
4. Measure and record the power level from the system simulator.

3.1.4 Test Setup

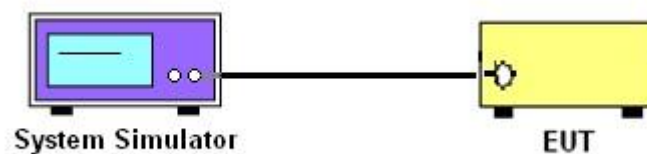



3.1.5 Test Result of Conducted Output Power

<LTE Band 7 Conducted Power>

BW [MHz]	Modulation	RB Size	RB Offset	Power (dBm) Low Ch. / Freq.	Power (dBm) Middle Ch. / Freq.	Power (dBm) High Ch. / Freq.
Channel				20850	21100	21350
Frequency (MHz)				2510	2535	2560
20	QPSK	1	0	21.45	21.28	21.66
20	QPSK	1	49	21.24	21.16	21.59
20	QPSK	1	99	21.03	21.11	21.37
20	QPSK	50	0	20.41	20.56	20.97
20	QPSK	50	24	20.42	20.53	20.97
20	QPSK	50	49	20.39	20.42	21.10
20	QPSK	100	0	20.78	20.35	20.79
20	16QAM	1	0	20.91	20.20	20.56
20	16QAM	1	49	20.79	20.07	20.49
20	16QAM	1	99	20.35	20.00	20.30
20	16QAM	50	0	19.84	19.93	20.41
20	16QAM	50	24	19.87	19.90	20.29
20	16QAM	50	49	19.83	19.94	20.40
20	16QAM	100	0	20.14	19.73	20.15
Channel				20825	21100	21375
Frequency (MHz)				2507.5	2535.0	2562.5
15	QPSK	1	0	21.31	21.18	21.21
15	QPSK	1	37	21.13	21.09	21.12
15	QPSK	1	74	21.01	21.03	21.06
15	QPSK	36	0	20.22	20.41	20.52
15	QPSK	36	18	20.23	20.45	20.35
15	QPSK	36	37	20.44	20.35	20.37
15	QPSK	75	0	20.35	20.56	20.85
15	16QAM	1	0	20.65	20.52	20.37
15	16QAM	1	37	20.50	20.24	20.23
15	16QAM	1	74	20.21	20.22	20.07
15	16QAM	36	0	19.64	19.77	19.87
15	16QAM	36	18	19.64	19.76	19.75
15	16QAM	36	37	19.86	19.68	19.75
15	16QAM	75	0	19.71	19.90	20.06



BW [MHz]	Modulation	RB Size	RB Offset	Power (dBm) Low Ch. / Freq.	Power (dBm) Middle Ch. / Freq.	Power (dBm) High Ch. / Freq.
Channel				20800	21100	21400
Frequency (MHz)				2505.0	2535.0	2565.0
10	QPSK	1	0	21.23	21.12	21.22
10	QPSK	1	24	21.13	21.11	21.02
10	QPSK	1	49	21.00	21.06	21.06
10	QPSK	25	0	20.17	20.33	20.36
10	QPSK	25	12	20.32	20.34	20.47
10	QPSK	25	24	20.24	20.33	20.27
10	QPSK	50	0	20.37	20.61	20.74
10	16QAM	1	0	20.63	20.20	20.27
10	16QAM	1	24	20.54	20.17	20.07
10	16QAM	1	49	20.22	20.11	20.04
10	16QAM	25	0	19.55	19.69	19.70
10	16QAM	25	12	19.76	19.68	19.67
10	16QAM	25	24	19.67	19.65	19.61
10	16QAM	50	0	19.78	20.00	20.12
Channel				20775	21100	21425
Frequency (MHz)				2502.5	2535.0	2567.5
5	QPSK	1	0	21.43	21.13	21.22
5	QPSK	1	12	21.29	21.08	21.20
5	QPSK	1	24	21.01	21.10	21.06
5	QPSK	12	0	20.10	20.35	20.38
5	QPSK	12	6	20.15	20.31	20.26
5	QPSK	12	11	20.25	20.29	20.38
5	QPSK	25	0	20.18	20.36	20.26
5	16QAM	1	0	20.40	20.13	20.25
5	16QAM	1	12	20.25	20.11	20.23
5	16QAM	1	24	20.11	20.06	20.03
5	16QAM	12	0	19.63	19.61	19.62
5	16QAM	12	6	19.74	19.61	19.54
5	16QAM	12	11	19.84	19.62	19.55
5	16QAM	25	0	19.78	19.63	19.57

Note: maximum average power for LTE.



3.1.6 Test Result of Conducted Output Power and ERP/EIRP

LTE Band 7 ($G_T - L_C = 11.00$ dB)						
Modes	LTE Band 7 (QPSK,BW=5M)			LTE Band 7 (16QAM,BW=5M)		
Channel	20775(Low)	21100 (Mid)	21425 (High)	20775(Low)	21100 (Mid)	21425 (High)
Frequency (MHz)	2502.5	2535	2567.5	2502.5	2535	2567.5
Conducted Power P_T (dBm)	21.43	21.13	21.22	20.4	20.13	20.25
Conducted Power P_T (Watts)	0.14	0.13	0.13	0.11	0.10	0.11
EIRP(dBm)	32.43	32.13	32.22	31.40	31.13	31.25
EIRP(Watts)	1.75	1.63	1.67	1.38	1.30	1.33

LTE Band 7 ($G_T - L_C = 11.00$ dB)						
Modes	LTE Band 7 (QPSK,BW=10M)			LTE Band 7 (16QAM,BW=10M)		
Channel	26055 (Low)	26340 (Mid)	26675 (High)	26055 (Low)	26340 (Mid)	26675 (High)
Frequency (MHz)	1851.5	1880	1913.5	1851.5	1880	1913.5
Conducted Power P_T (dBm)	21.23	21.12	21.22	20.63	20.2	20.27
Conducted Power P_T (Watts)	0.13	0.13	0.13	0.12	0.10	0.11
EIRP(dBm)	32.23	32.12	32.22	31.63	31.2	31.27
EIRP(Watts)	1.67	1.63	1.67	1.46	1.32	1.34



LTE Band 7 ($G_T - L_C = 11.00$ dB)						
Modes	LTE Band 7 (QPSK, BW=15M)			LTE Band 7 (16QAM, BW=15M)		
Channel	20825 (Low)	21100 (Mid)	21375 (High)	20825 (Low)	21100 (Mid)	21375 (High)
Frequency (MHz)	2507.5	2535	2562.5	2507.5	2535	2562.5
Conducted Power P_T (dBm)	21.31	21.18	21.21	20.65	20.52	20.37
Conducted Power P_T (Watts)	0.14	0.13	0.13	0.12	0.11	0.11
EIRP(dBm)	32.31	32.18	32.21	31.65	31.52	31.37
EIRP(Watts)	1.70	1.65	1.66	1.46	1.42	1.37

LTE Band 7 ($G_T - L_C = 11.00$ dB)						
Modes	LTE Band 7 (QPSK, BW=20M)			LTE Band 7 (16QAM, BW=20M)		
Channel	20850 (Low)	21100 (Mid)	21350 (High)	20850 (Low)	21100 (Mid)	21350 (High)
Frequency (MHz)	2510	2535	2560	2510	2535	2560
Conducted Power P_T (dBm)	21.45	21.28	21.66	20.91	20.2	20.56
Conducted Power P_T (Watts)	0.14	0.13	0.15	0.12	0.10	0.11
EIRP(dBm)	32.45	32.28	32.66	31.91	31.2	31.56
EIRP(Watts)	1.76	1.69	1.85	1.55	1.32	1.43

3.2 Peak-to-Average Ratio

3.2.1 Description of the PAR Measurement

Power Complementary Cumulative Distribution Function (CCDF) curves provide a means for characterizing the power peaks of a digitally modulated signal on a statistical basis. A CCDF curve depicts the probability of the peak signal amplitude exceeding the average power level. Most contemporary measurement instrumentation include the capability to produce CCDF curves for an input signal provided that the instrument's resolution bandwidth can be set wide enough to accommodate the entire input signal bandwidth. In measuring transmissions in this band using an average power technique, the peak-to-average ratio (PAR) of the transmission may not exceed 13 dB.

3.2.2 Measuring Instruments

The measuring equipment is listed in the section 4 of this test report.

3.2.3 Test Procedures

1. The EUT was connected to spectrum and system simulator via a power divider.
2. Set the CCDF (Complementary Cumulative Distribution Function) option in spectrum analyzer.
3. The highest RF powers were measured and recorded the maximum PAPR level associated with a probability of 0.1 %.
4. Record the deviation as Peak to Average Ratio.

3.2.4 Test Setup

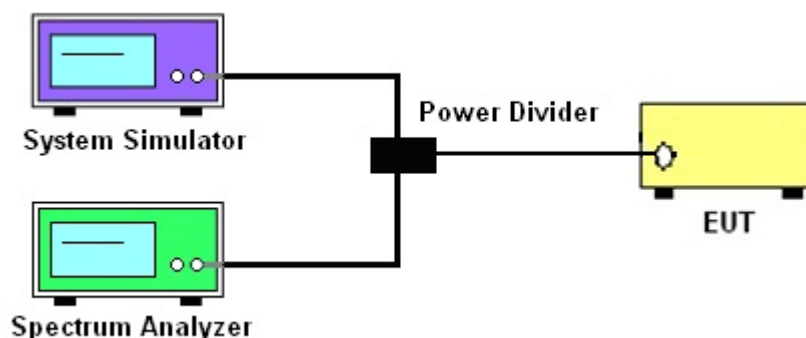



3.2.5 Test Result of Peak-to-Average Ratio

LTE Band 7						
BW [MHz]	Modulation	RB Size	RB Offset	Power (dBm) Low Ch. / Freq.	Power (dBm) Middle Ch. / Freq.	Power (dBm) High Ch. / Freq.
Channel				20850	21100	21350
Frequency (MHz)				2510	2535	2560
20	16QAM	1	0	6.19	5.99	5.80
20	16QAM	100	0	6.09	6.12	5.96



3.2.6 Peak to Average Power Ratio

Peak-to-Average Ratio on LTE Band 7 20MHz / 16QAM in Ch. 20850 (1RB Size)

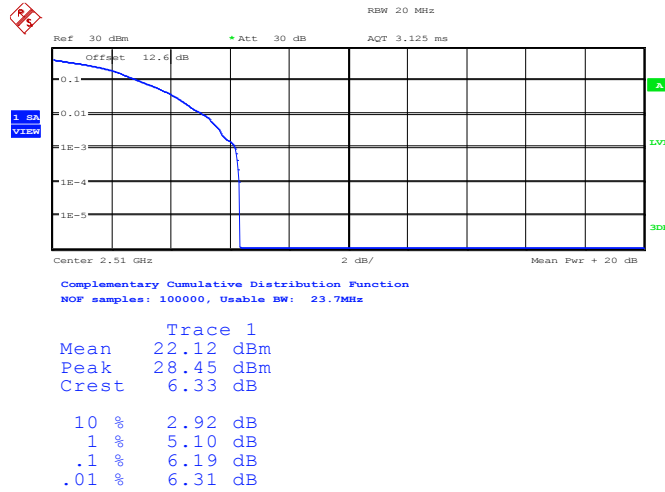

Date: 6.JUN.2014 09:52:02

Peak-to-Average Ratio on LTE Band 7 20MHz / 16QAM in Ch. 21100 (1RB Size)

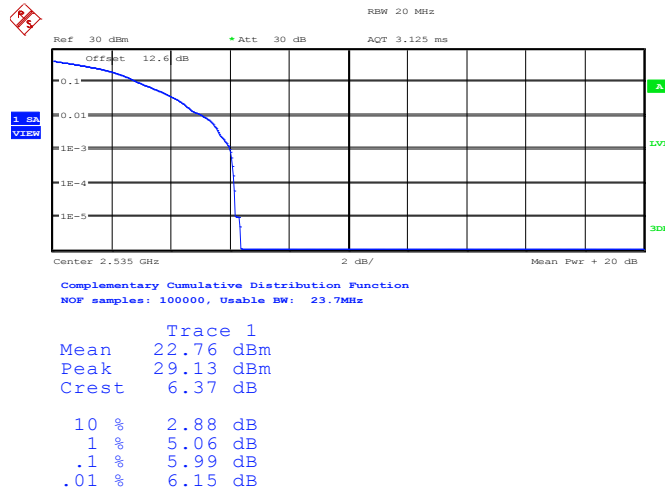

Date: 6.JUN.2014 09:54:53



Peak-to-Average Ratio on LTE Band 7
20MHz / 16QAM in Ch. 21350 (1RB Size)

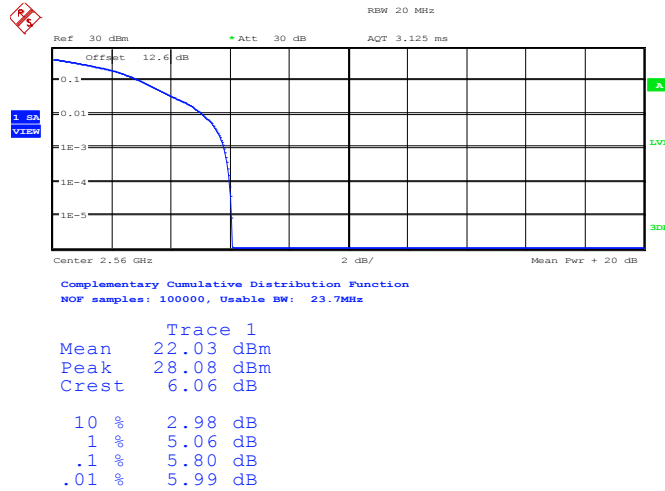

Date: 6.JUN.2014 10:01:07

Peak-to-Average Ratio on LTE Band 7
20MHz / 16QAM in Ch. 20850 (100RB Size)

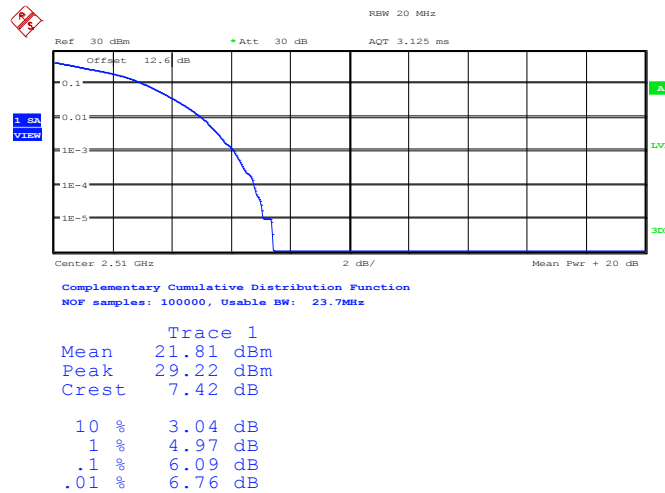

Date: 6.JUN.2014 09:53:21



Peak-to-Average Ratio on LTE Band 7
20MHz / 16QAM in Ch. 21100 (100RB Size)

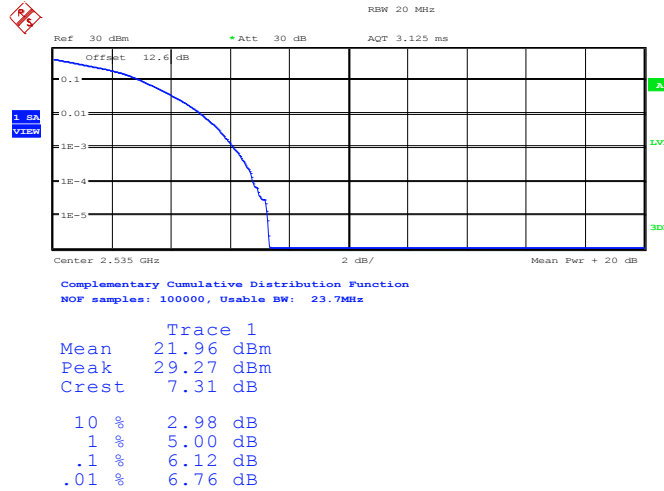

Date: 6.JUN.2014 09:54:10

Peak-to-Average Ratio on LTE Band 7
20MHz / 16QAM in Ch. 21350 (100RB Size)

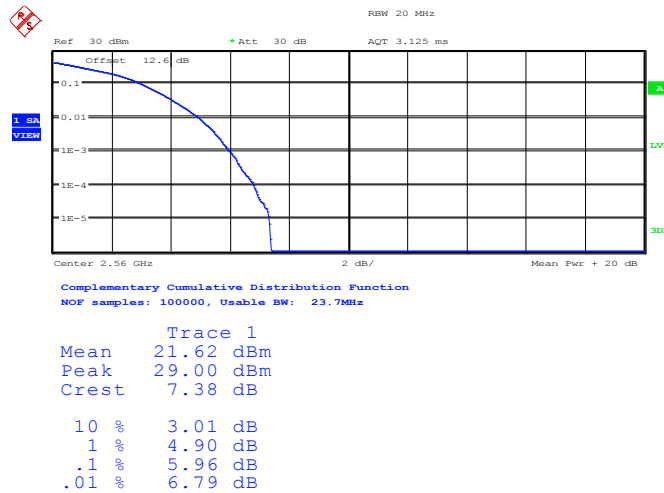

Date: 6.JUN.2014 10:01:41

3.3 Occupied Bandwidth

3.3.1 Description of Occupied Bandwidth Measurement

The occupied bandwidth is the width of a frequency band such that, below the lower and above the upper frequency limits, the mean powers emitted are each equal to a specified percentage 0.5% of the total mean transmitted power.

The 26 dB emission bandwidth is defined as the frequency range between two points, one above and one below the carrier frequency, at which the spectral density of the emission is attenuated 26 dB below the maximum in-band spectral density of the modulated signal. Spectral density (power per unit bandwidth) is to be measured with a detector of resolution bandwidth equal to approximately 1.0% of the emission bandwidth.

3.3.2 Measuring Instruments

The measuring equipment is listed in the section 4 of this test report.

3.3.3 Test Procedures

1. The EUT was connected to spectrum analyzer and system simulator via a power divider.
2. The 26dB and 99% occupied bandwidth (BW) of the middle channel for the highest RF power with full RB sizes were measured.

3.3.4 Test Setup

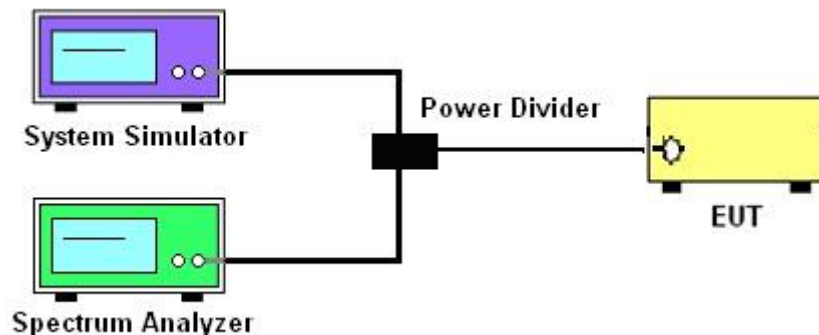



3.3.5 Test Result (Plots) of Occupied Bandwidth

Band :	LTE Band 7	BW / Mod. :	5MHz / QPSK
--------	------------	-------------	-------------

99% Occupied Bandwidth Plot on Channel 20775

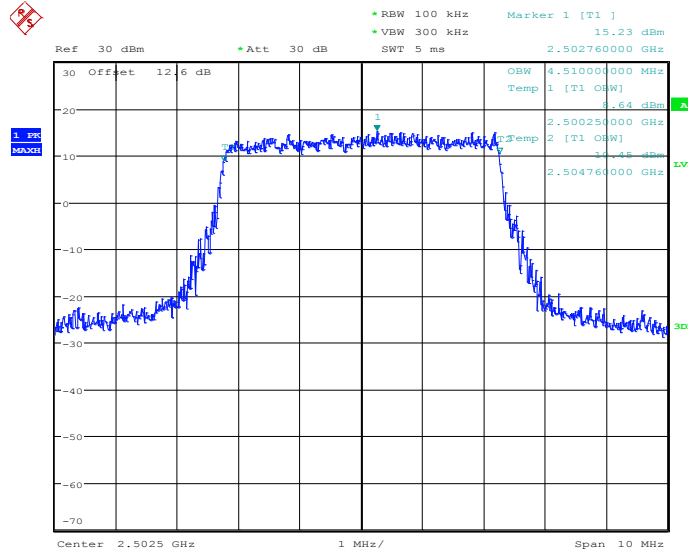

Date: 6.JUN.2014 09:31:09

26dB Bandwidth Plot on Channel 20775

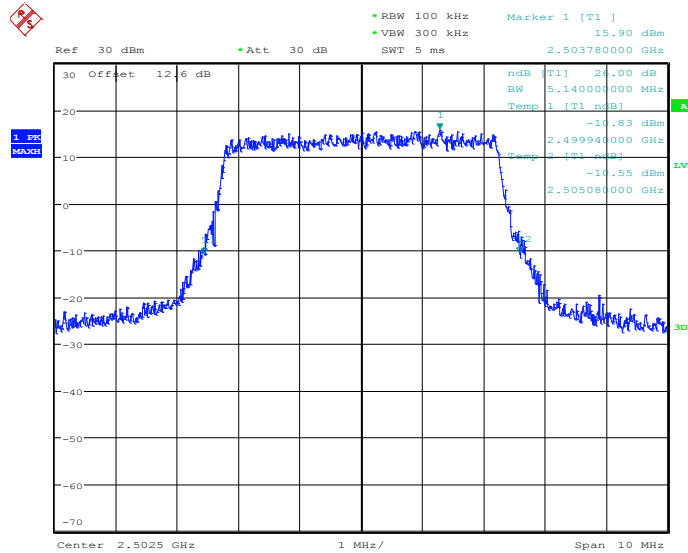

Date: 6.JUN.2014 09:31:45



99% Occupied Bandwidth Plot on Channel 21100

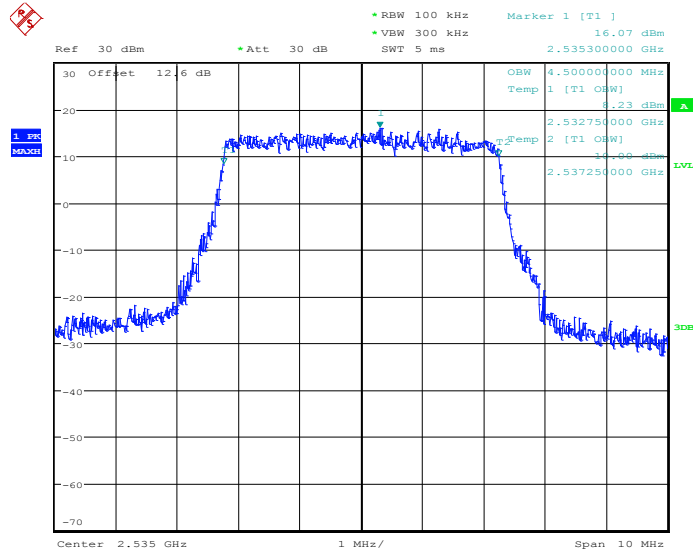

Date: 6.JUN.2014 09:37:43

26dB Bandwidth Plot on Channel 21100

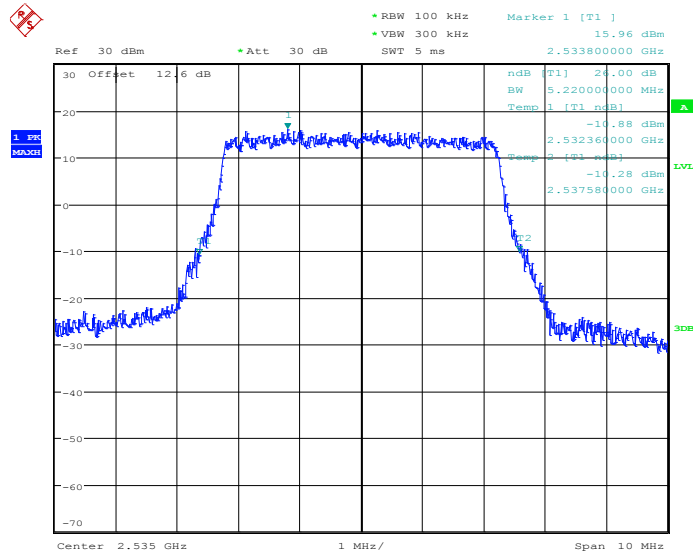

Date: 6.JUN.2014 09:38:20



99% Occupied Bandwidth Plot on Channel 21425

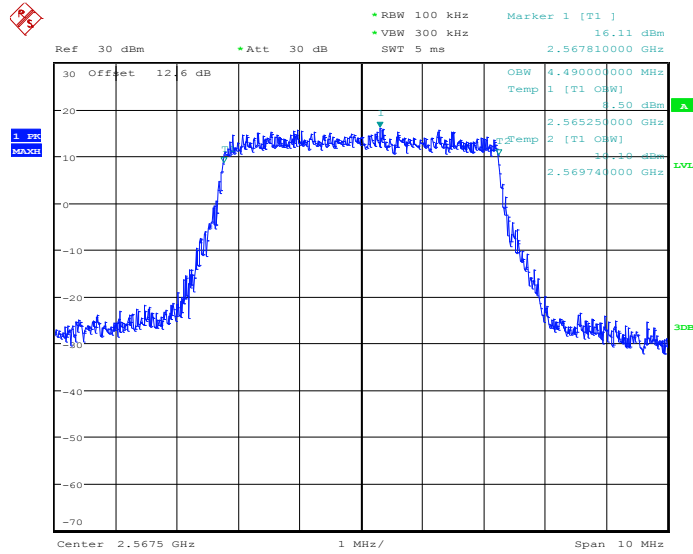

Date: 6.JUN.2014 09:41:04

26dB Bandwidth Plot on Channel 21425

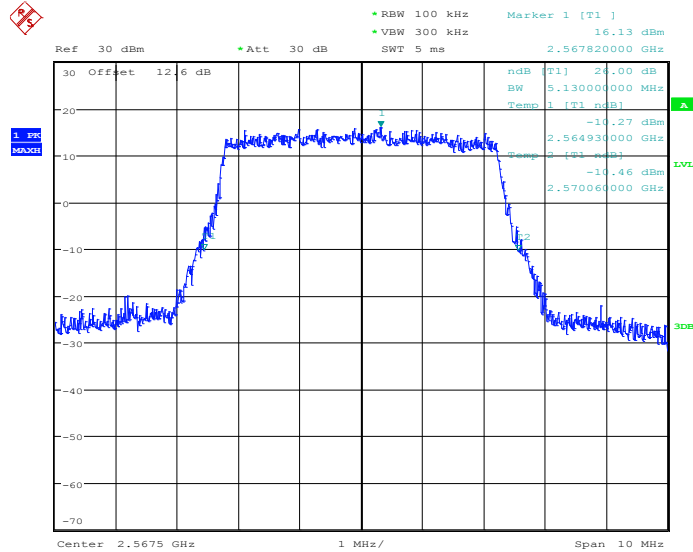

Date: 6.JUN.2014 09:41:40



Band :	LTE Band 7	BW / Mod. :	5MHz / 16QAM
---------------	------------	--------------------	--------------

99% Occupied Bandwidth Plot on Channel 20775

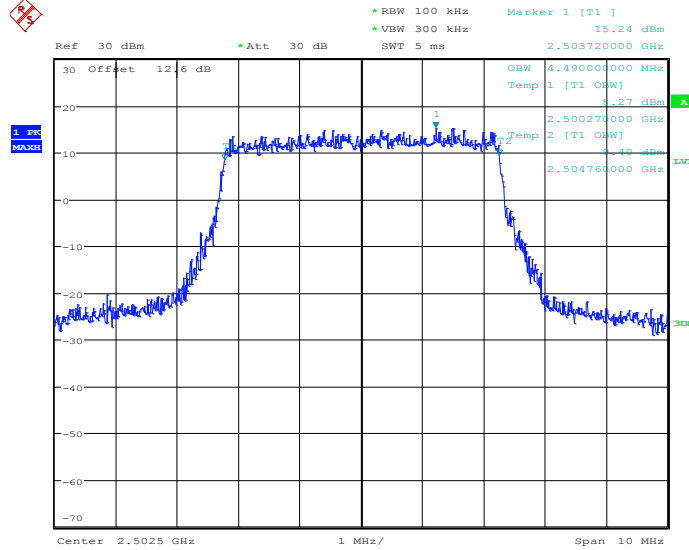

Date: 6.JUN.2014 09:31:27

26dB Bandwidth Plot on Channel 20775

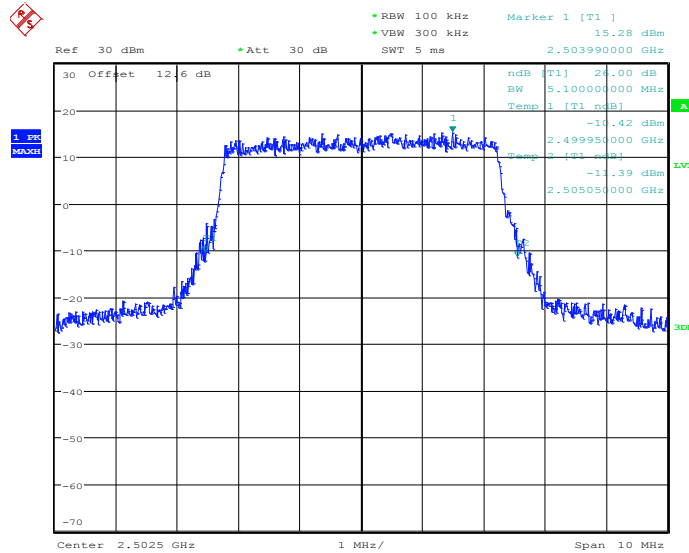

Date: 6.JUN.2014 09:32:04



99% Occupied Bandwidth Plot on Channel 21100

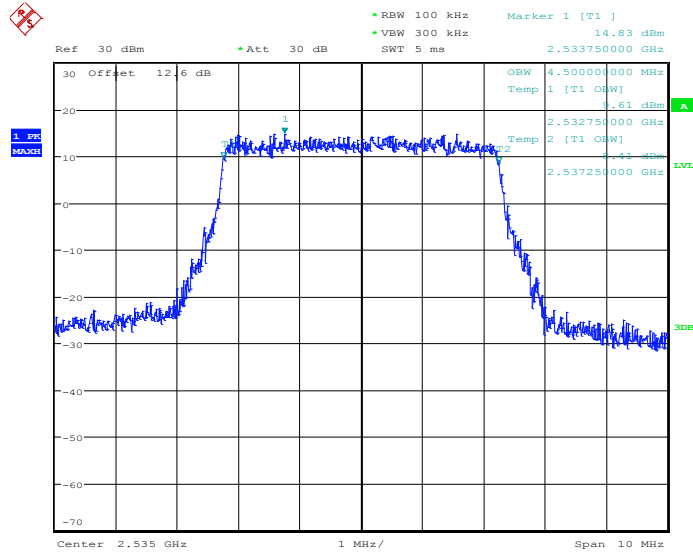

Date: 6.JUN.2014 09:38:01

26dB Bandwidth Plot on Channel 21100

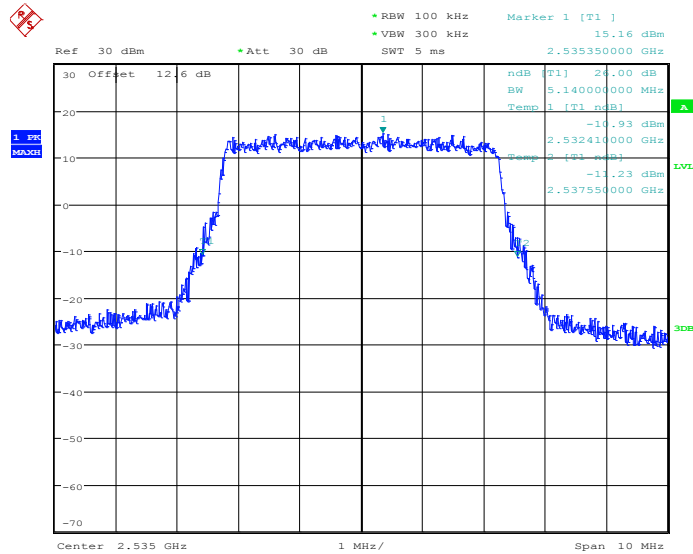

Date: 6.JUN.2014 09:38:39



99% Occupied Bandwidth Plot on Channel 21425

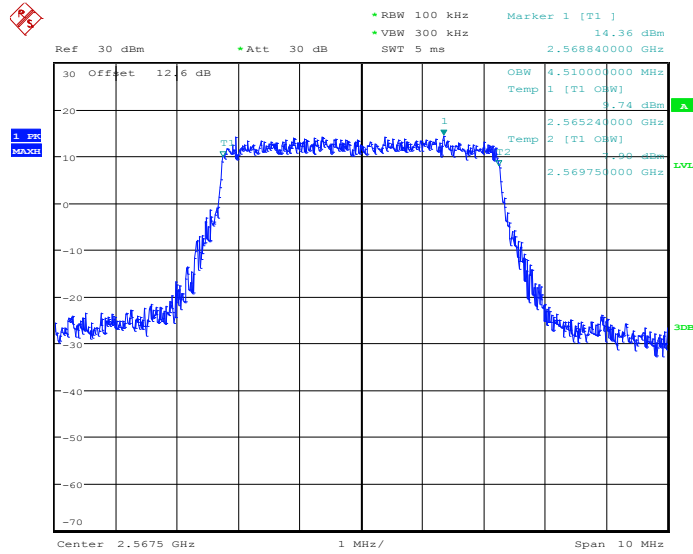

Date: 6.JUN.2014 09:41:21

26dB Bandwidth Plot on Channel 21425

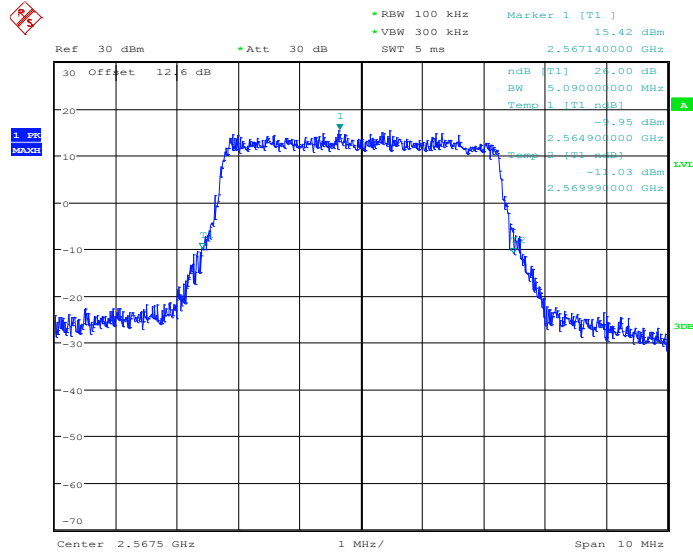

Date: 6.JUN.2014 09:41:59



Band :	LTE Band 7	BW / Mod. :	10MHz / QPSK
--------	------------	-------------	--------------

99% Occupied Bandwidth Plot on Channel 20800

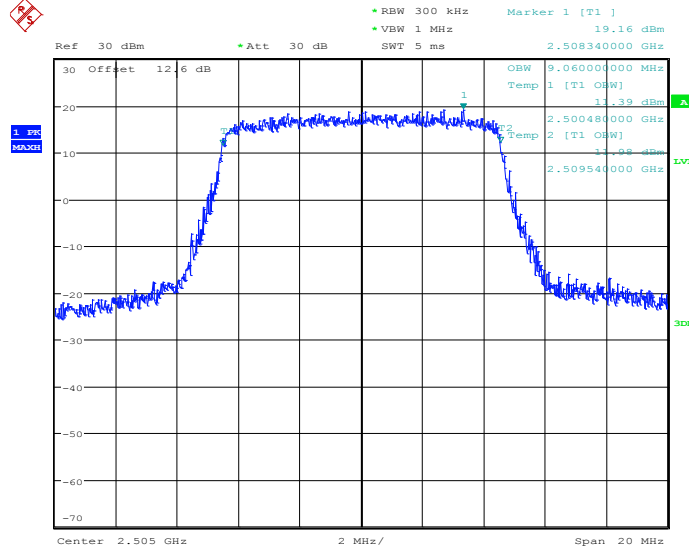

Date: 5.JUN.2014 23:45:38

26dB Bandwidth Plot on Channel 20800

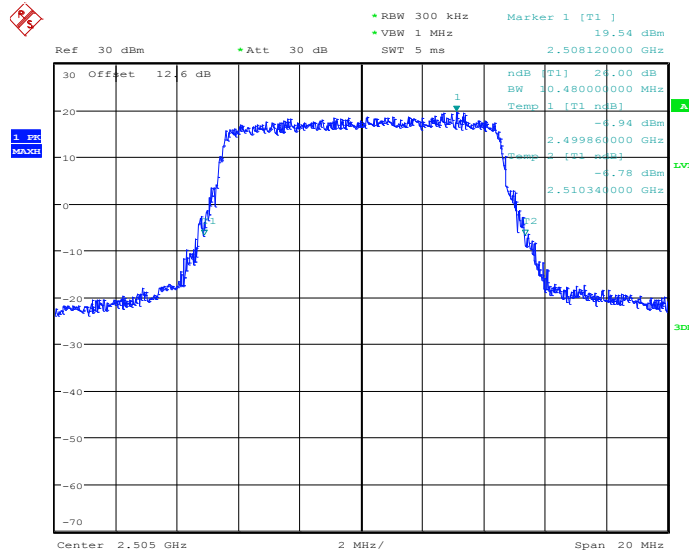

Date: 5.JUN.2014 23:32:40



99% Occupied Bandwidth Plot on Channel 21100

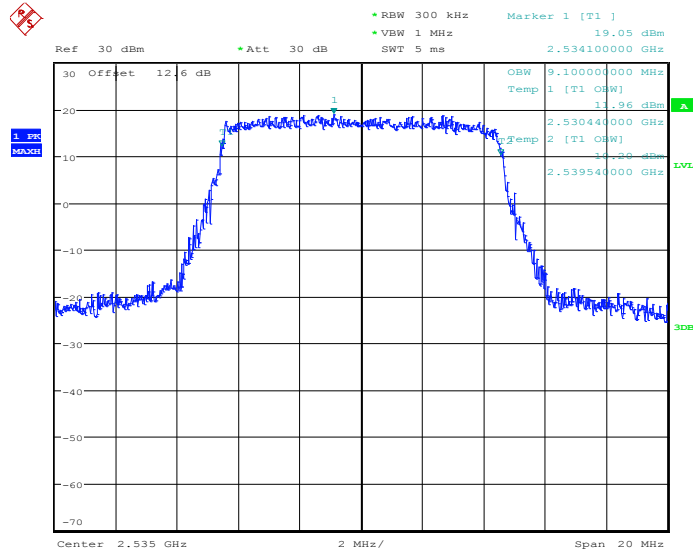

Date: 5.JUN.2014 23:46:11

26dB Bandwidth Plot on Channel 21100

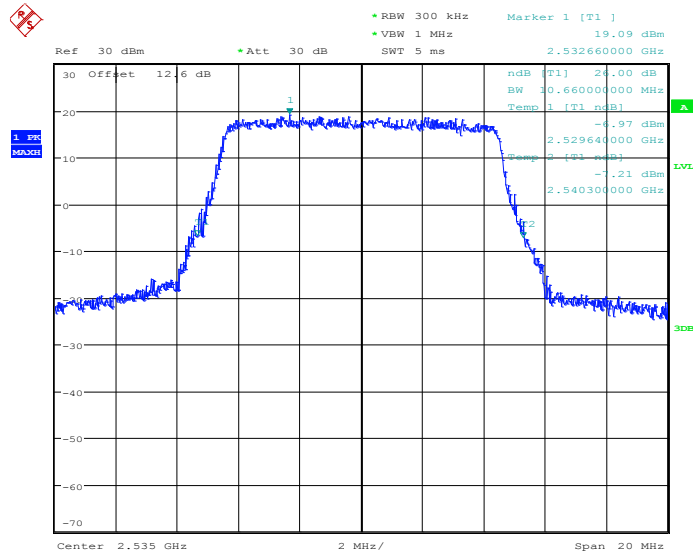

Date: 5.JUN.2014 23:36:00



99% Occupied Bandwidth Plot on Channel 21400

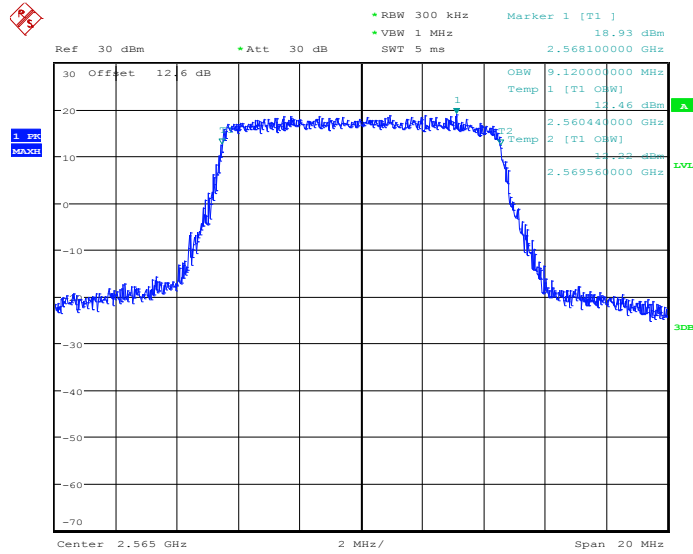

Date: 5.JUN.2014 23:46:44

26dB Bandwidth Plot on Channel 21400

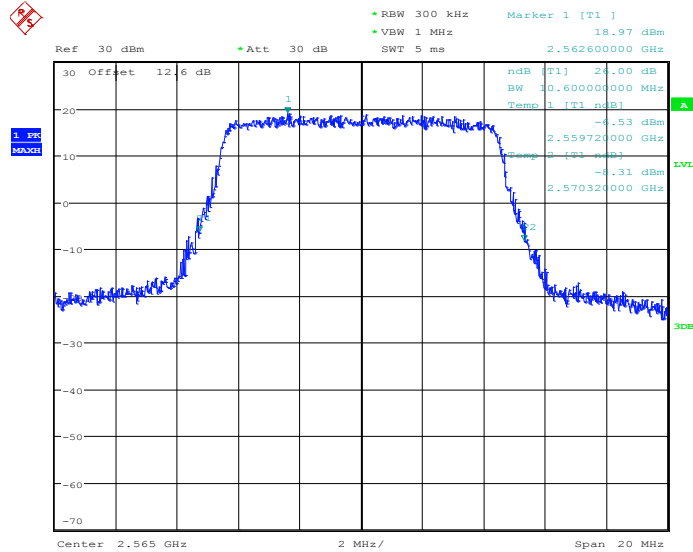

Date: 5.JUN.2014 23:39:21



Band :	LTE Band 7	BW / Mod. :	10MHz / 16QAM
---------------	------------	--------------------	---------------

99% Occupied Bandwidth Plot on Channel 20800

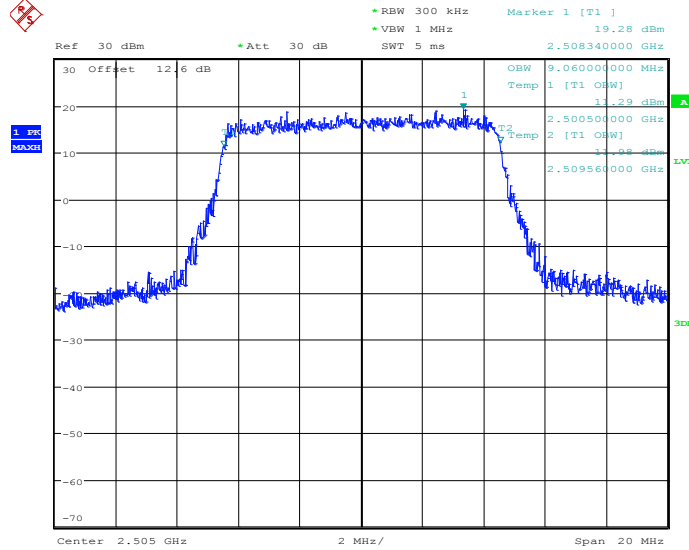

Date: 5.JUN.2014 23:45:55

26dB Bandwidth Plot on Channel 20800

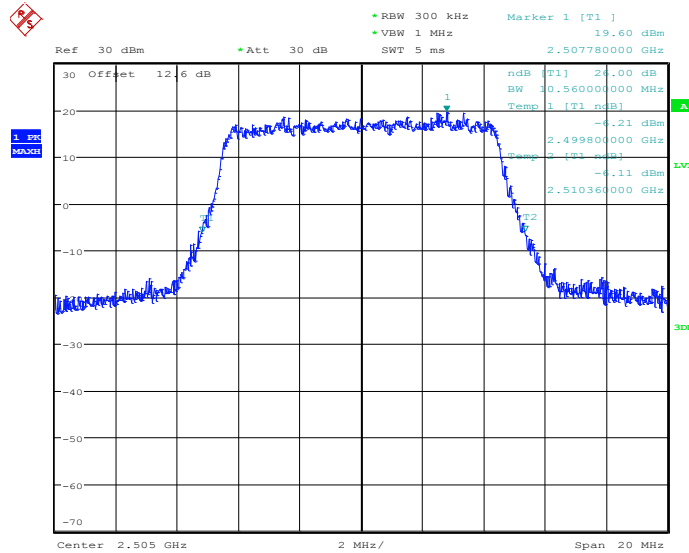

Date: 5.JUN.2014 23:32:59



99% Occupied Bandwidth Plot on Channel 21100

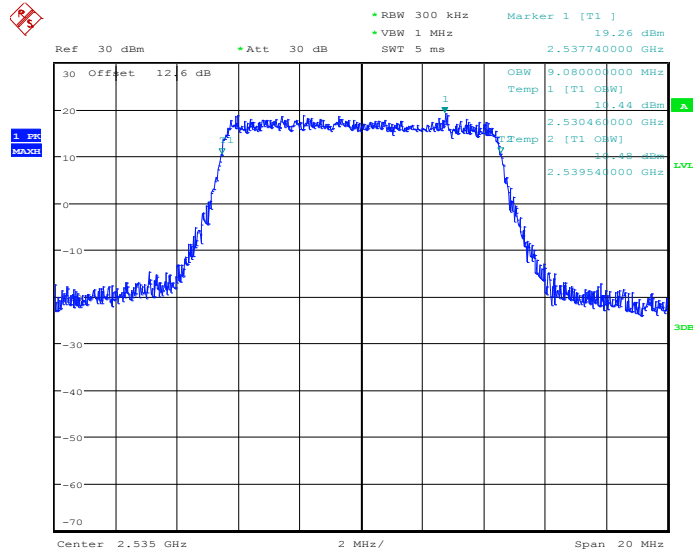

Date: 5.JUN.2014 23:46:28

26dB Bandwidth Plot on Channel 21100

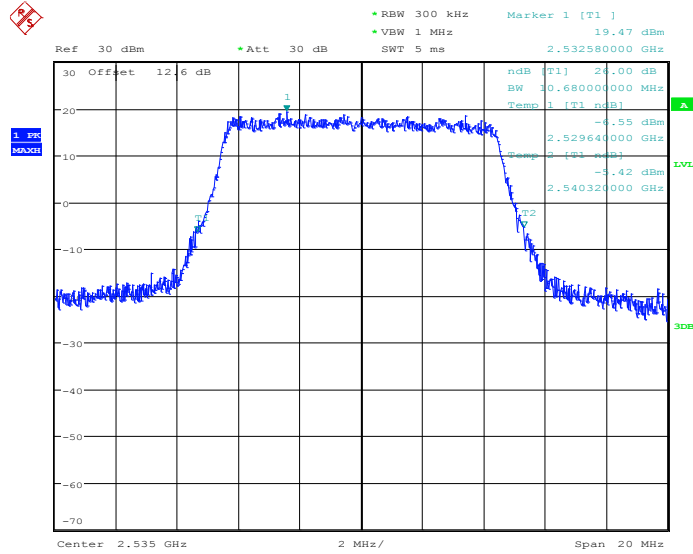

Date: 5.JUN.2014 23:36:19



99% Occupied Bandwidth Plot on Channel 21400

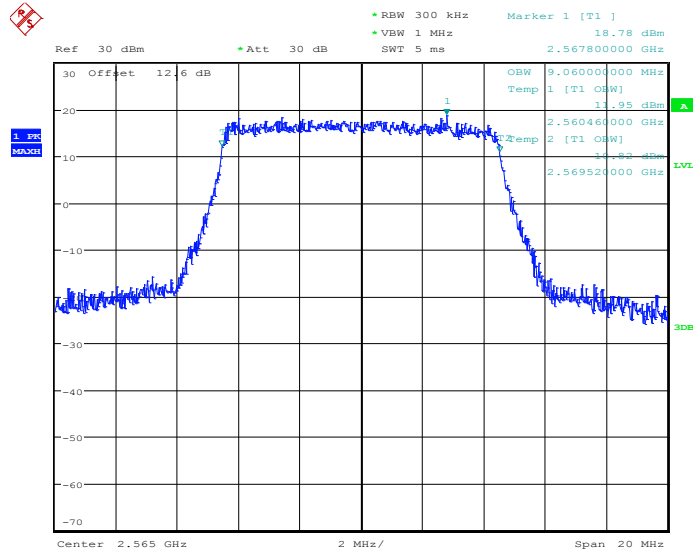

Date: 5.JUN.2014 23:47:00

26dB Bandwidth Plot on Channel 21400

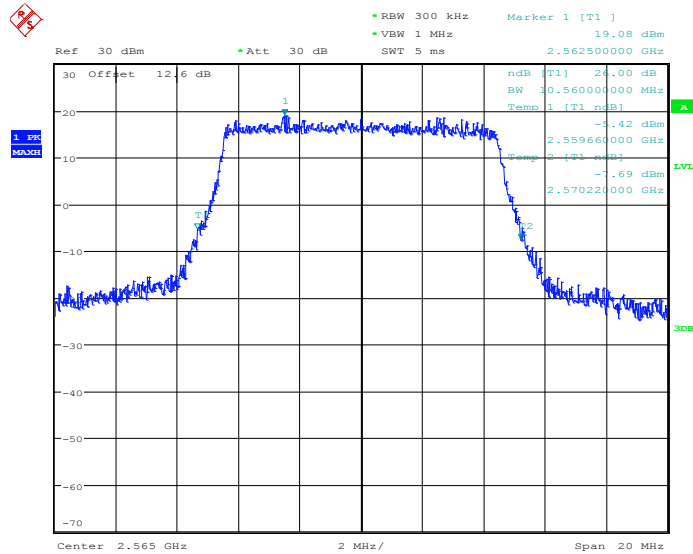

Date: 5.JUN.2014 23:39:40



Band :	LTE Band 7	BW / Mod. :	15MHz / QPSK
--------	------------	-------------	--------------

99% Occupied Bandwidth Plot on Channel 20825

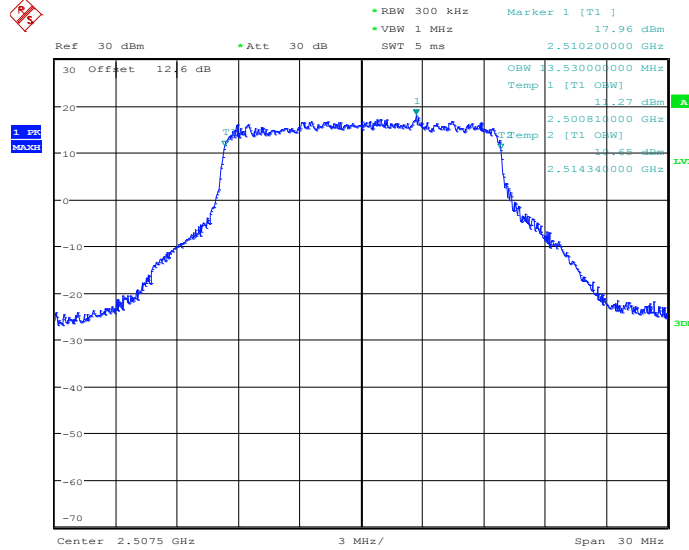

Date: 6.JUN.2014 15:28:52

26dB Bandwidth Plot on Channel 20825

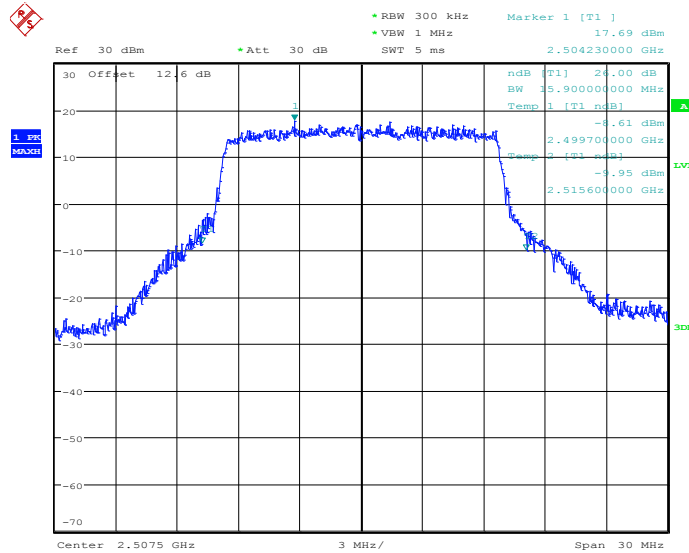

Date: 5.JUN.2014 23:48:51



99% Occupied Bandwidth Plot on Channel 21100

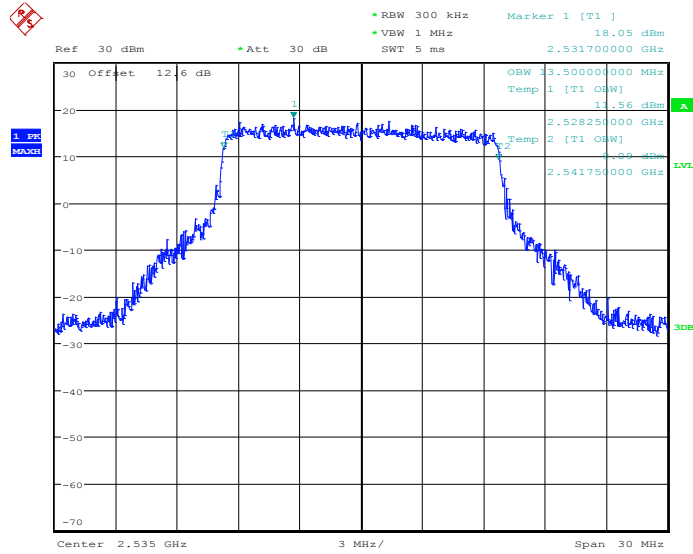

Date: 5.JUN.2014 23:51:26

26dB Bandwidth Plot on Channel 21100

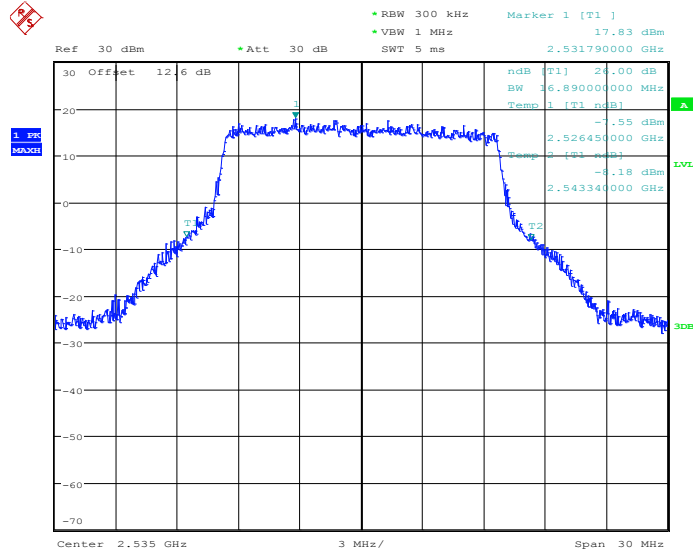

Date: 5.JUN.2014 23:52:00



99% Occupied Bandwidth Plot on Channel 21375

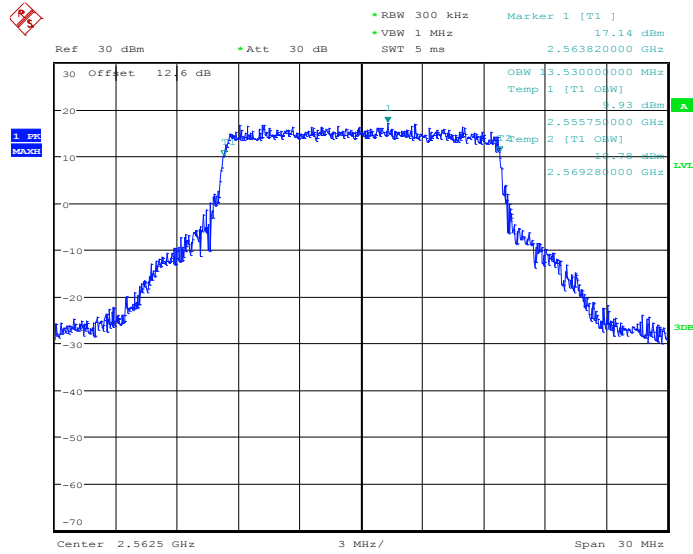

Date: 5.JUN.2014 23:54:34

26dB Bandwidth Plot on Channel 21375

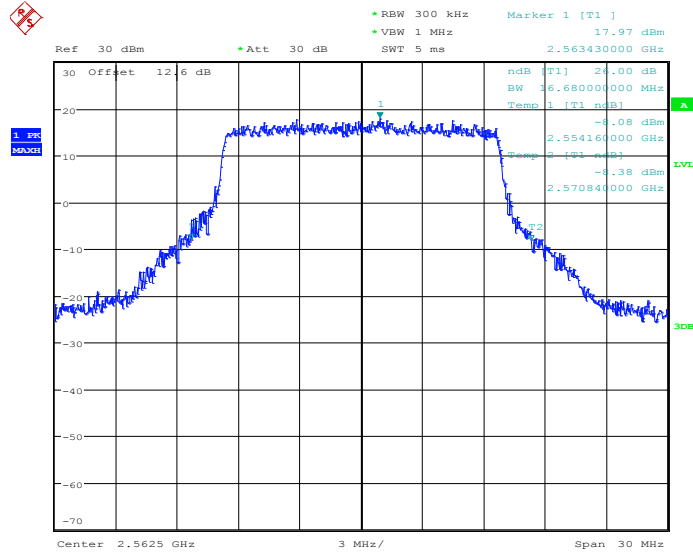

Date: 5.JUN.2014 23:55:09



Band :	LTE Band 7	BW / Mod. :	15MHz / 16QAM
--------	------------	-------------	---------------

99% Occupied Bandwidth Plot on Channel 20825

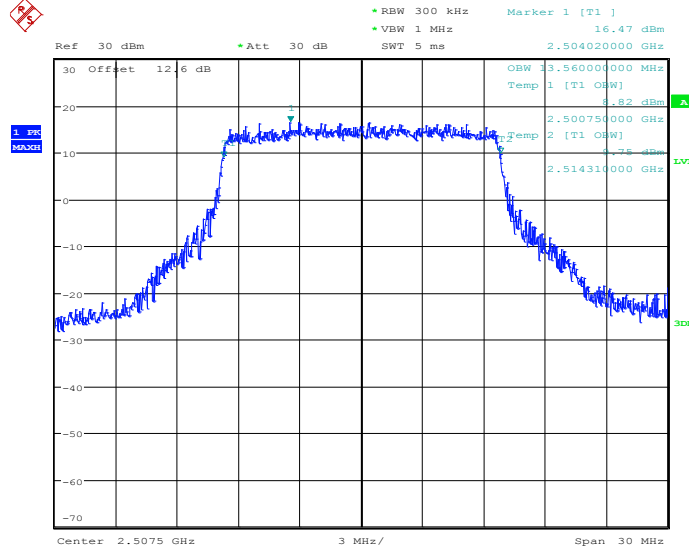

Date: 5.JUN.2014 23:48:33

26dB Bandwidth Plot on Channel 20825

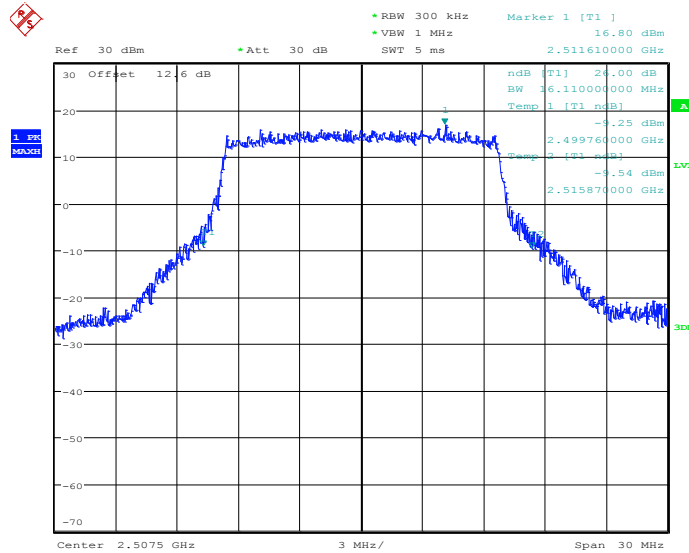

Date: 5.JUN.2014 23:49:10



99% Occupied Bandwidth Plot on Channel 21100

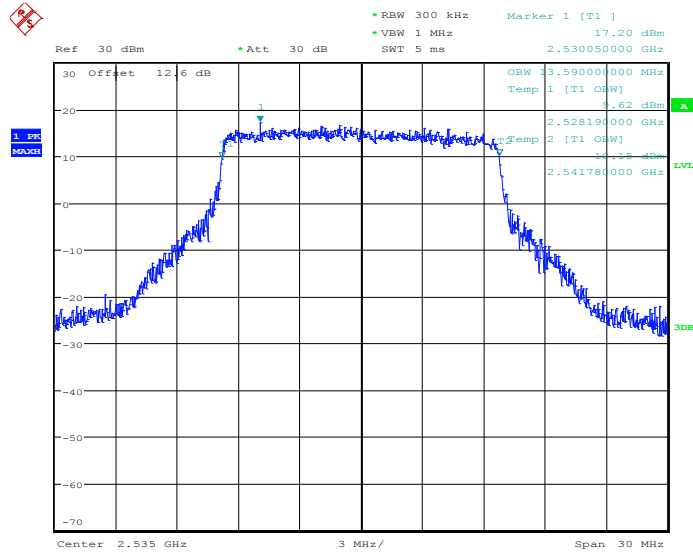

Date: 5.JUN.2014 23:51:42

26dB Bandwidth Plot on Channel 21100

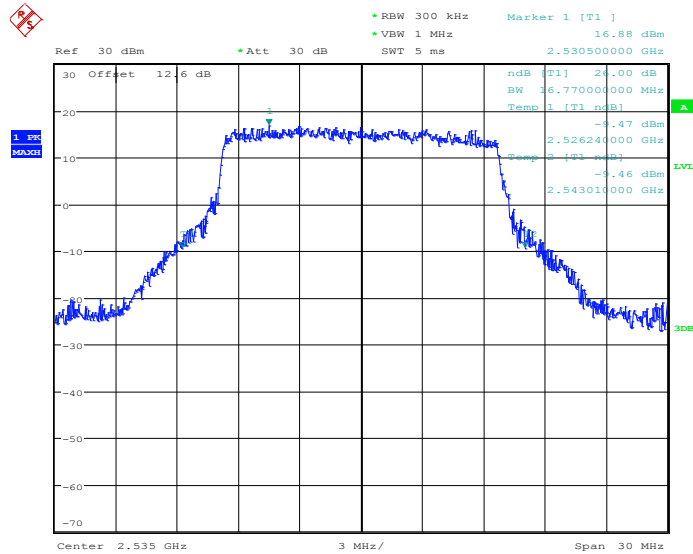

Date: 5.JUN.2014 23:52:18



99% Occupied Bandwidth Plot on Channel 21375

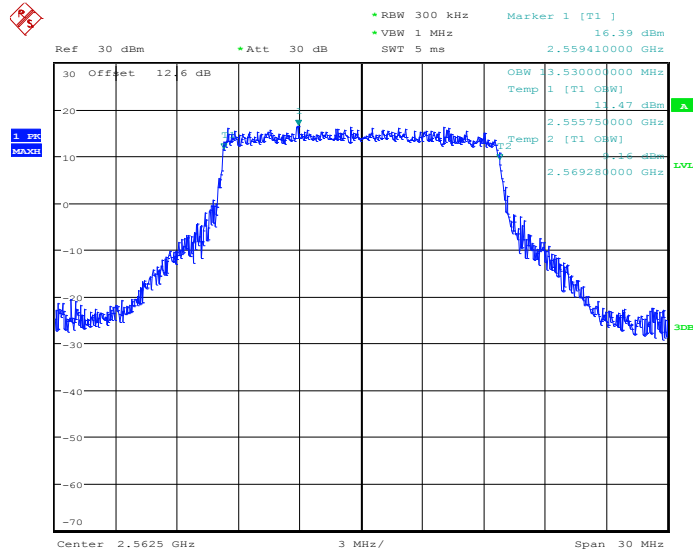

Date: 5.JUN.2014 23:54:51

26dB Bandwidth Plot on Channel 21375

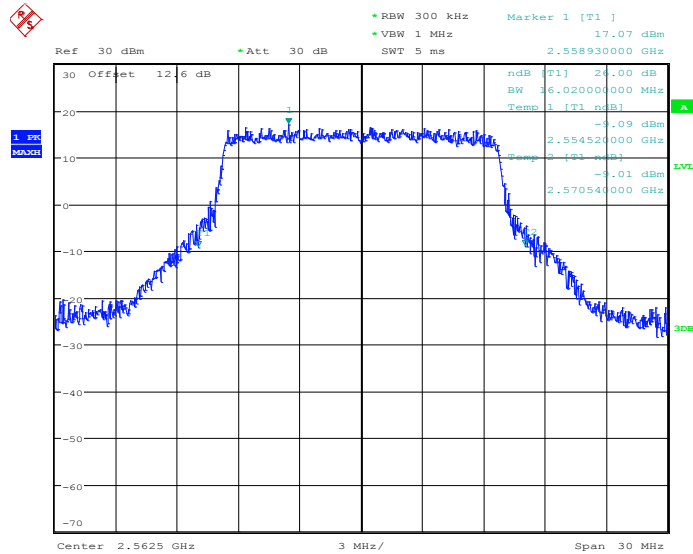

Date: 5.JUN.2014 23:55:27



Band :	LTE Band 7	BW / Mod. :	20MHz / QPSK
--------	------------	-------------	--------------

99% Occupied Bandwidth Plot on Channel 20850

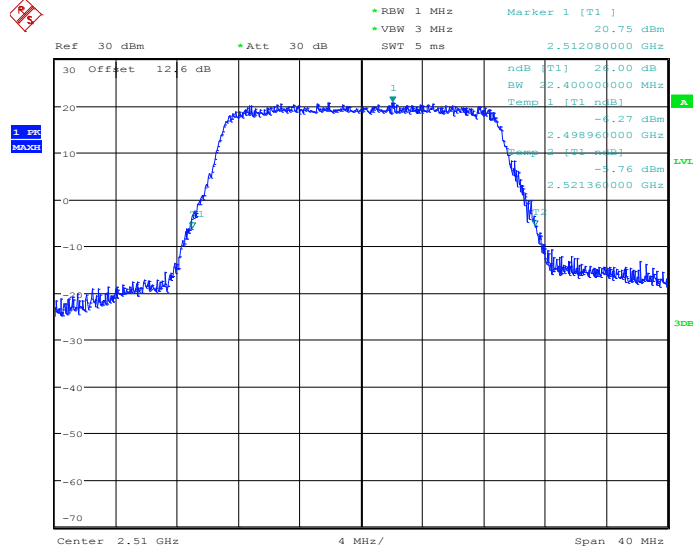

Date: 6.JUN.2014 00:01:20

26dB Bandwidth Plot on Channel 20850

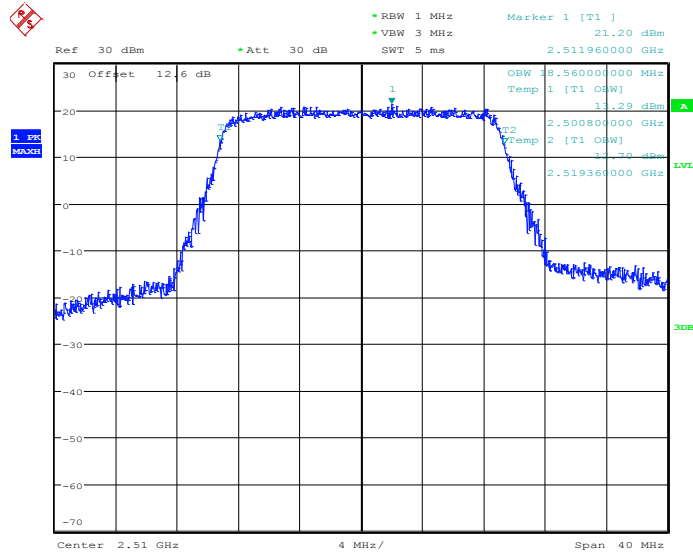

Date: 6.JUN.2014 00:00:44



99% Occupied Bandwidth Plot on Channel 21100

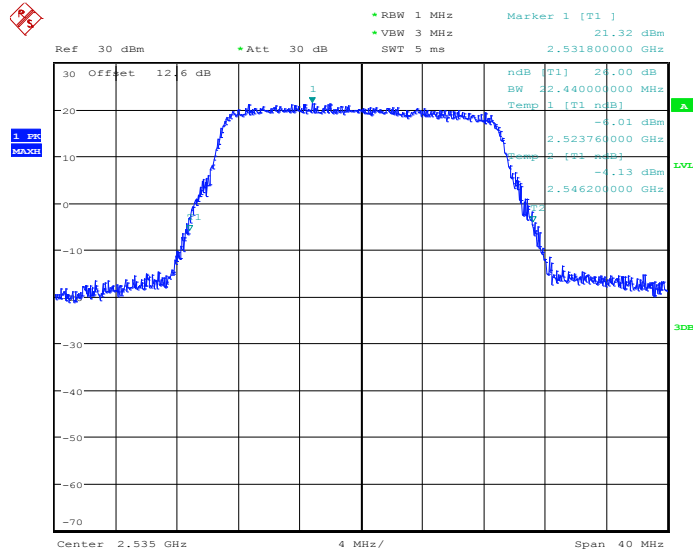

Date: 6.JUN.2014 00:04:39

26dB Bandwidth Plot on Channel 21100

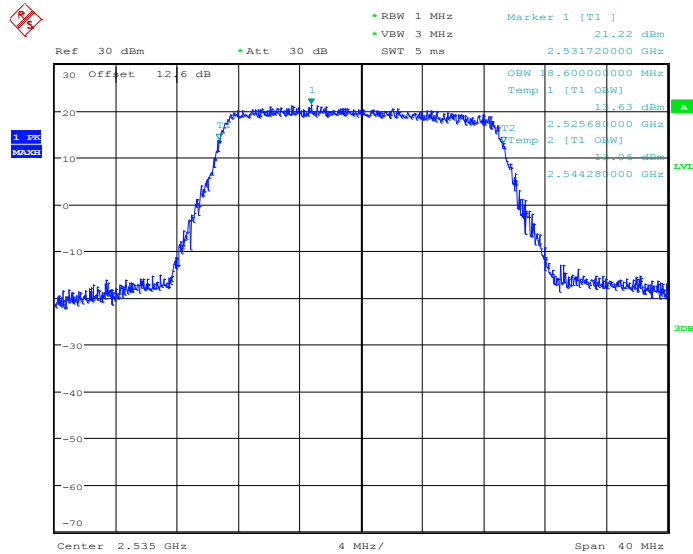

Date: 6.JUN.2014 00:04:03



99% Occupied Bandwidth Plot on Channel 21350

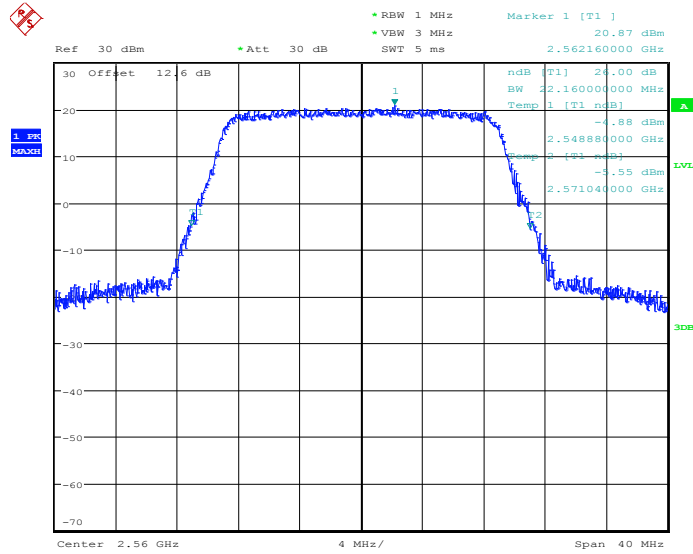

Date: 6.JUN.2014 00:07:58

26dB Bandwidth Plot on Channel 21350

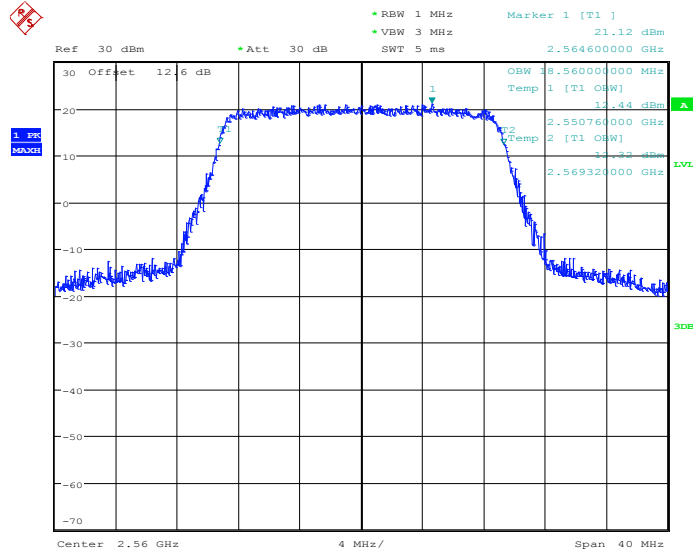

Date: 6.JUN.2014 00:07:22



Band :	LTE Band 7	BW / Mod. :	20MHz / 16QAM
--------	------------	-------------	---------------

99% Occupied Bandwidth Plot on Channel 20850

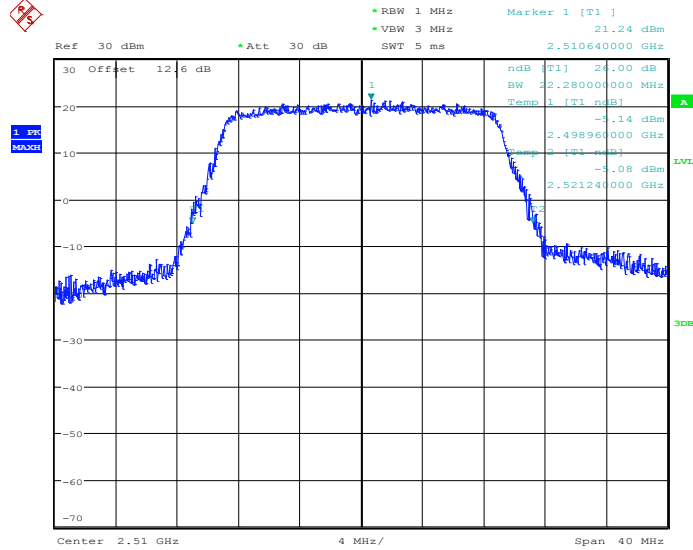

Date: 6.JUN.2014 00:01:38

26dB Bandwidth Plot on Channel 20850

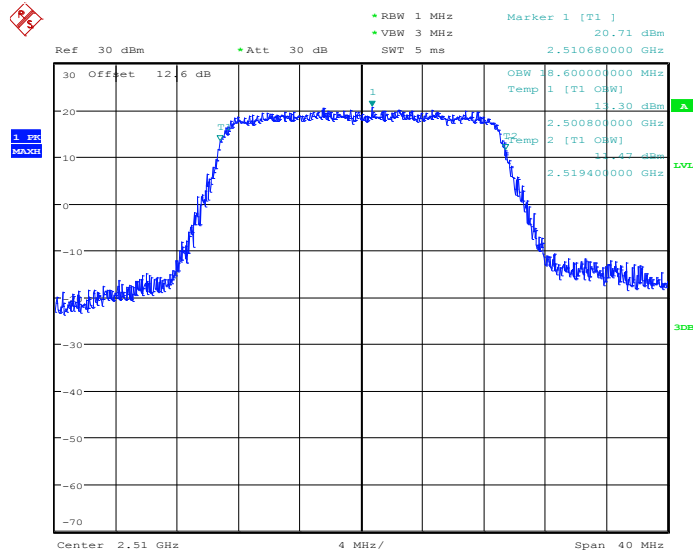

Date: 6.JUN.2014 00:01:01



99% Occupied Bandwidth Plot on Channel 21100

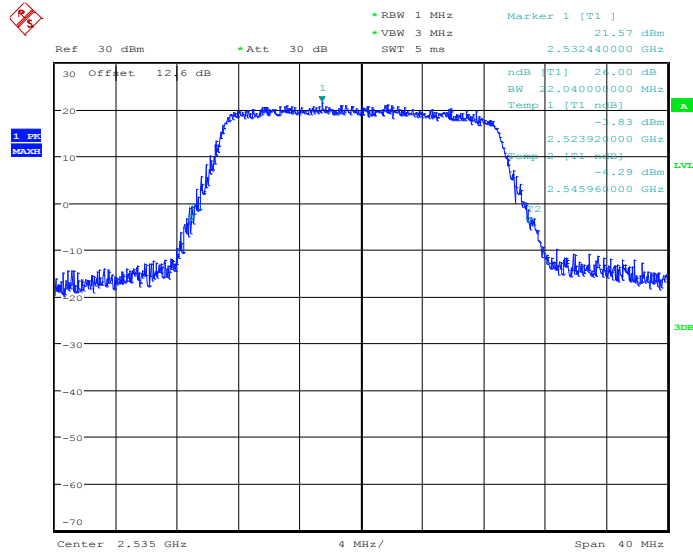

Date: 6.JUN.2014 00:04:58

26dB Bandwidth Plot on Channel 21100

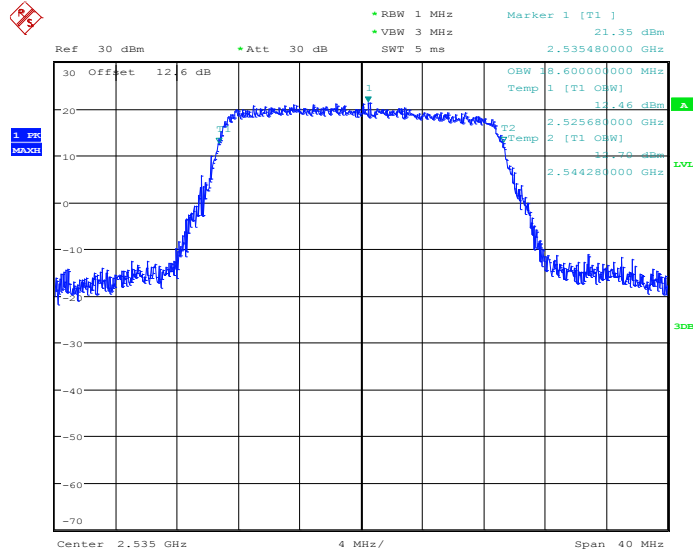

Date: 6.JUN.2014 00:04:20



99% Occupied Bandwidth Plot on Channel 21350

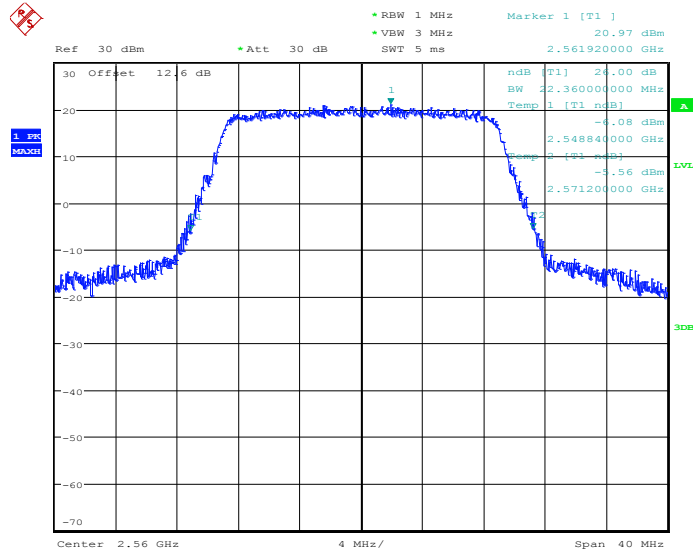

Date: 6.JUN.2014 00:08:17

26dB Bandwidth Plot on Channel 21350

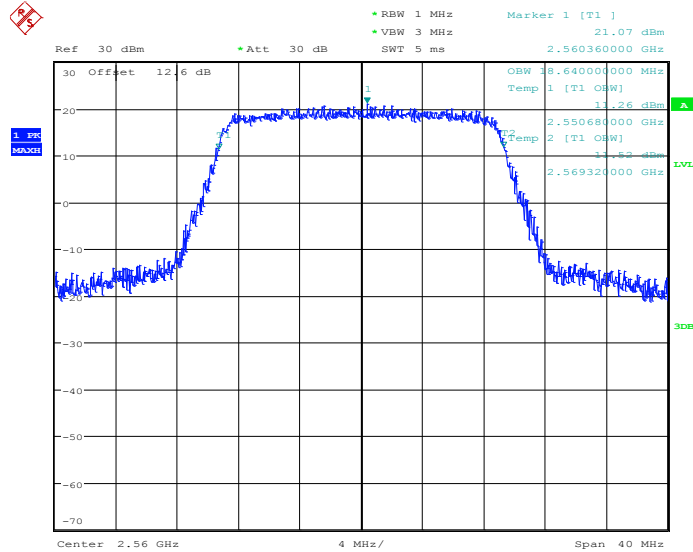

Date: 6.JUN.2014 00:07:39

3.4 Conducted Band Edge Measurement

3.4.1 Description of Conducted Band Edge Measurement

27.53 (l)(4) and RSS – 199

The emissions be operated in the 2496-2690 MHz band, the attenuation factor of transmitter Power (P) shall be not less than $55 + 10 \log (P)$ dB at the channel edge

*The test limit in the test data chooses worse limit to make sure test data is fine for different kinds of product. the real limit for fixed digital user station should be $43 + 10\log(P(W))$.

3.4.2 Measuring Instruments

The measuring equipment is listed in the section 4 of this test report.

3.4.3 Test Procedures

1. The EUT was connected to spectrum analyzer and system simulator via a power divider.
2. The band edges of low and high channels for the highest RF powers were measured. Set RBW $\geq 1\%$ EBW in the 1MHz band immediately outside and adjacent to the band edge.
3. Set spectrum analyzer with RMS detector.
4. The RF fundamental frequency should be excluded against the limit line in the operating frequency band.
5. The limit line is derived from $43 + 10\log(P)$ dB below the transmitter power P(Watts)
 $= P(W) - [43 + 10\log(P)]$ (dB)
 $= [30 + 10\log(P)]$ (dBm) - $[43 + 10\log(P)]$ (dB)
 $= -13$ dBm.

3.4.4 Test Setup

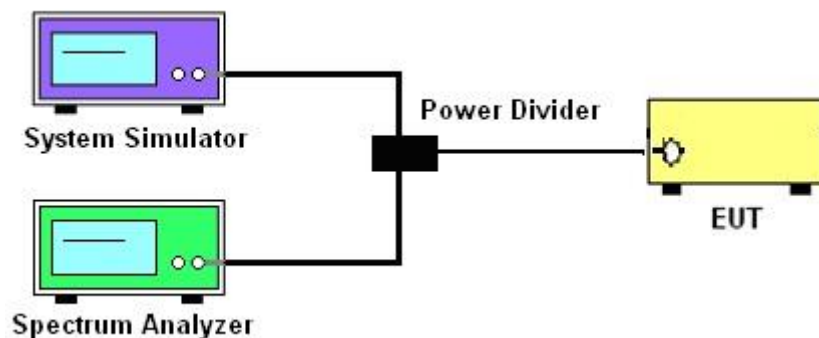



3.4.5 Test Result (Plots) of Conducted Band Edge

Band :	LTE Band 7	Band Width :	5MHz / QPSK
--------	------------	--------------	-------------

Lower Band Edge Plot for QPSK-RB Size 1, RB Offset 0

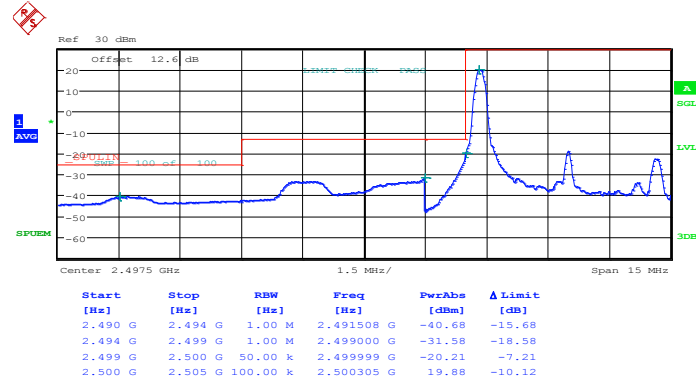

Date: 6.JUN.2014 09:32:52

Lower Band Edge Plot for QPSK-RB Size 25, RB Offset 0

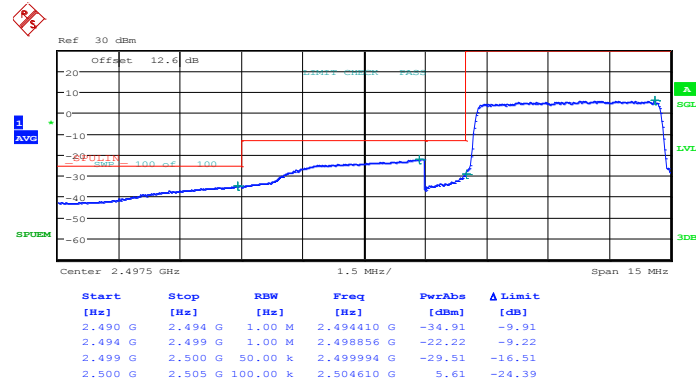

Date: 6.JUN.2014 09:34:29



Higher Band Edge Plot for QPSK-RB Size 1, RB Offset 24

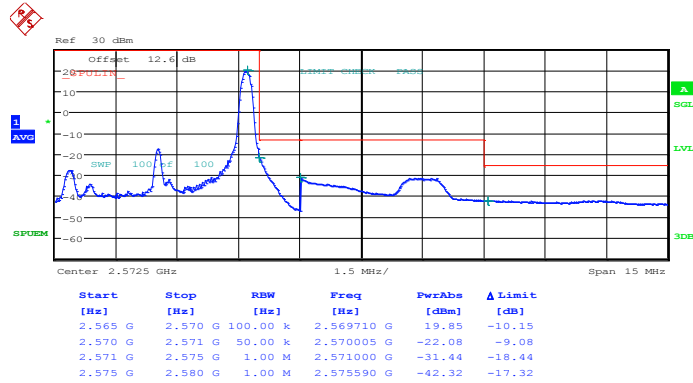

Date: 6.JUN.2014 09:42:47

Higher Band Edge Plot for QPSK-RB Size 25, RB Offset 0

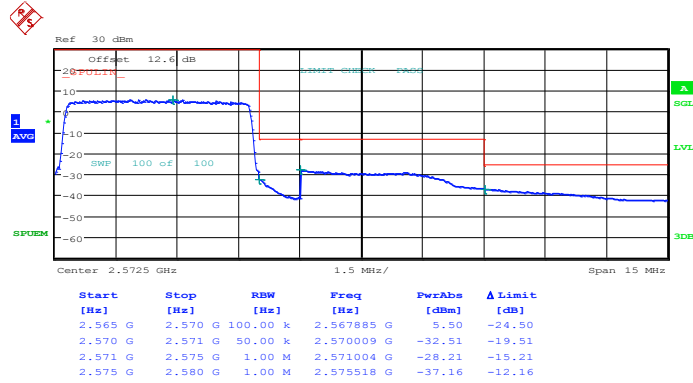

Date: 6.JUN.2014 09:44:24



Band :	LTE Band 7	Band Width :	5MHz / 16QAM
---------------	------------	---------------------	--------------

Lower Band Edge Plot for 16QAM-RB Size 1, RB Offset 0

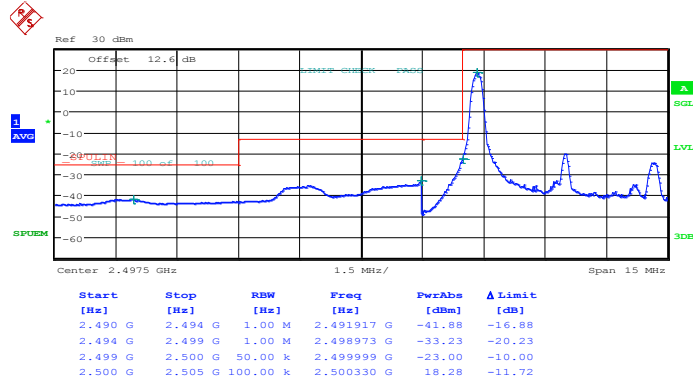

Date: 6.JUN.2014 09:33:41

Lower Band Edge Plot for 16QAM-RB Size 25, RB Offset 0

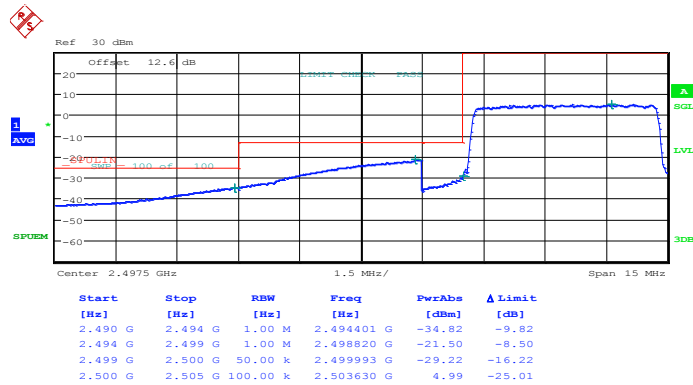

Date: 6.JUN.2014 09:35:17



Higher Band Edge Plot for 16QAM-RB Size 1, RB Offset 24

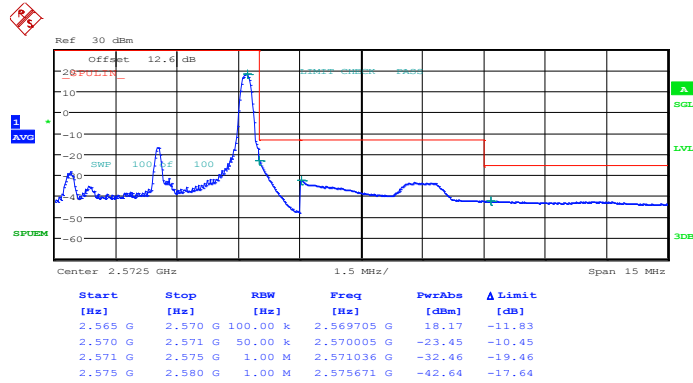

Date: 6.JUN.2014 09:43:35

Higher Band Edge Plot for 16QAM-RB Size 25, RB Offset 0

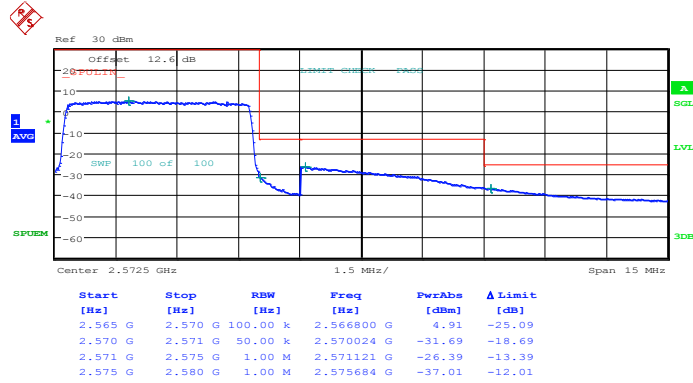

Date: 6.JUN.2014 09:45:12



Band :	LTE Band 7	Band Width :	10MHz / QPSK
--------	------------	--------------	--------------

Lower Band Edge Plot for QPSK-RB Size 1, RB Offset 0

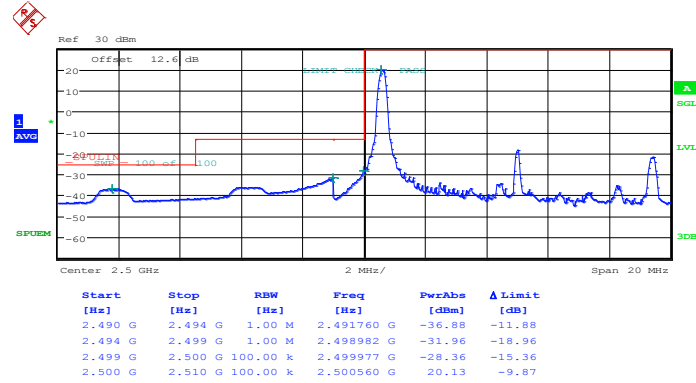

Date: 5.JUN.2014 21:54:28

Lower Band Edge Plot for QPSK-RB Size 50, RB Offset 0

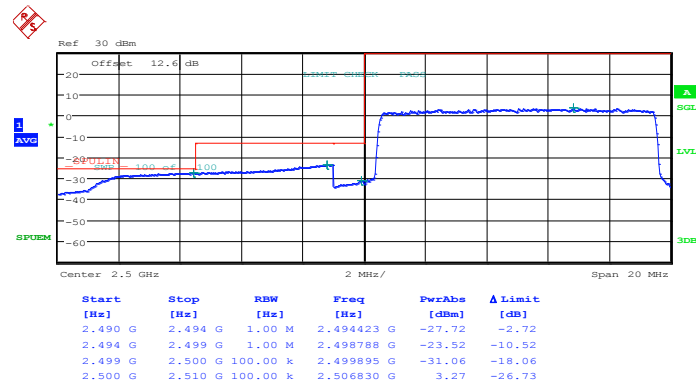

Date: 5.JUN.2014 21:56:03



Higher Band Edge Plot for QPSK-RB Size 1, RB Offset 49

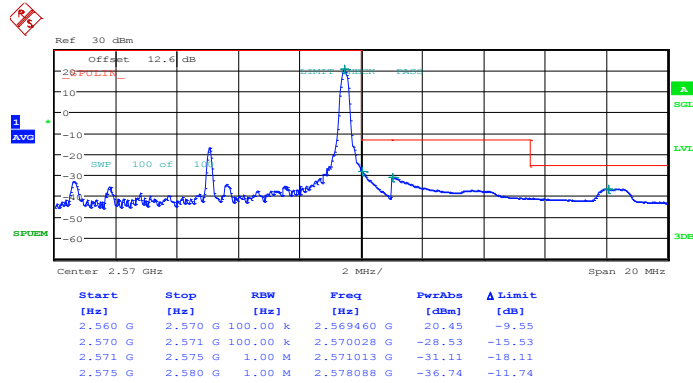

Date: 5.JUN.2014 21:57:39

Higher Band Edge Plot for QPSK-RB Size 50, RB Offset 0

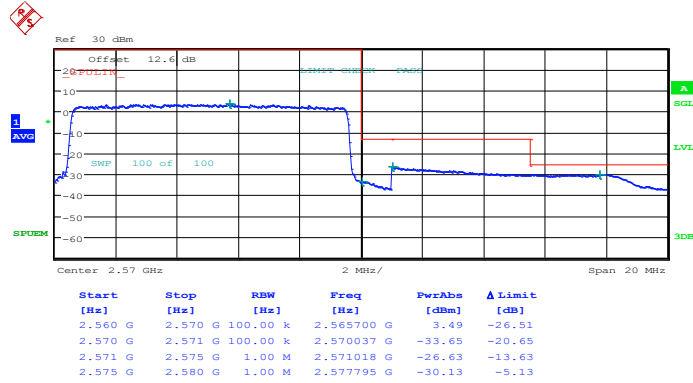

Date: 5.JUN.2014 21:59:15



Band :	LTE Band 7	Band Width :	10MHz / 16QAM
---------------	------------	---------------------	---------------

Lower Band Edge Plot for 16QAM-RB Size 1, RB Offset 0

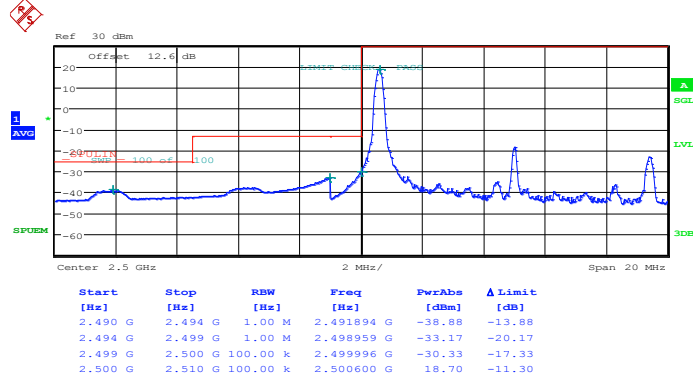

Date: 5.JUN.2014 21:55:16

Lower Band Edge Plot for 16QAM-RB Size 50, RB Offset 0

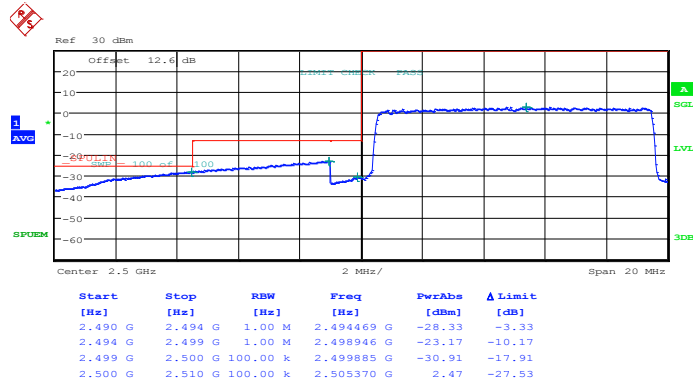

Date: 5.JUN.2014 21:56:51



Higher Band Edge Plot for 16QAM-RB Size 1, RB Offset 49

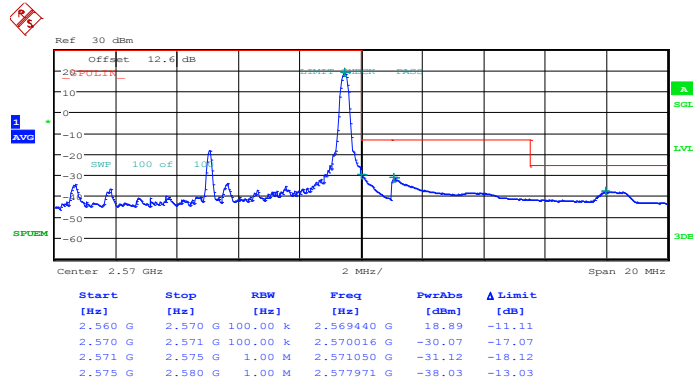

Date: 5.JUN.2014 21:58:27

Higher Band Edge Plot for 16QAM-RB Size 50, RB Offset 0

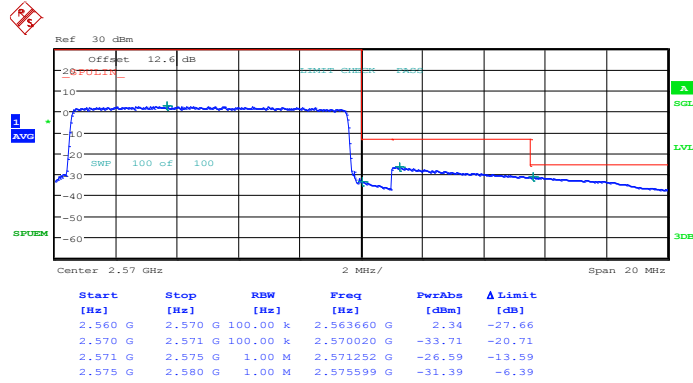

Date: 5.JUN.2014 22:00:02



Band :	LTE Band 7	Band Width :	15MHz / QPSK
--------	------------	--------------	--------------

Lower Band Edge Plot for QPSK-RB Size 1, RB Offset 0

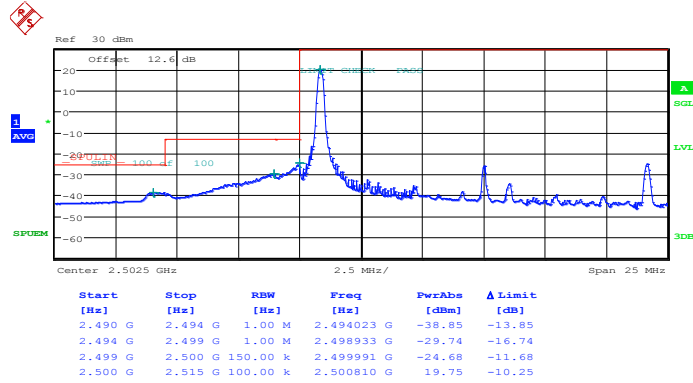

Date: 5.JUN.2014 22:01:05

Lower Band Edge Plot for QPSK-RB Size 75, RB Offset 0

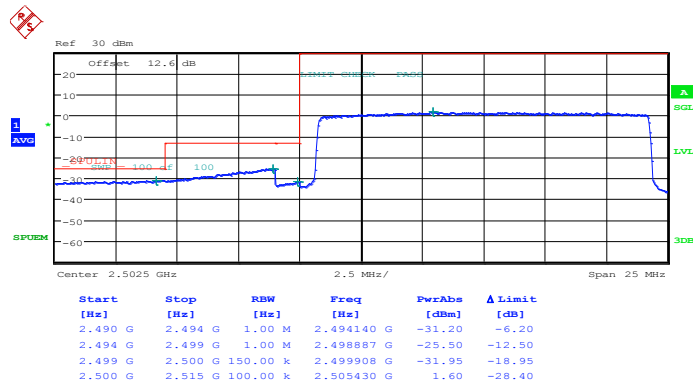

Date: 5.JUN.2014 22:02:41



Higher Band Edge Plot for QPSK-RB Size 1, RB Offset 74

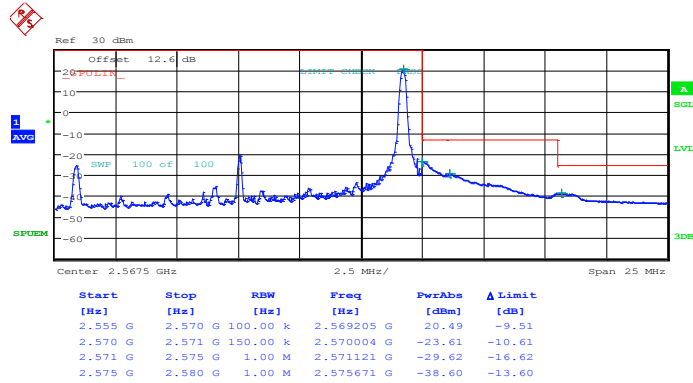

Date: 5.JUN.2014 22:04:17

Higher Band Edge Plot for QPSK-RB Size 75, RB Offset 0

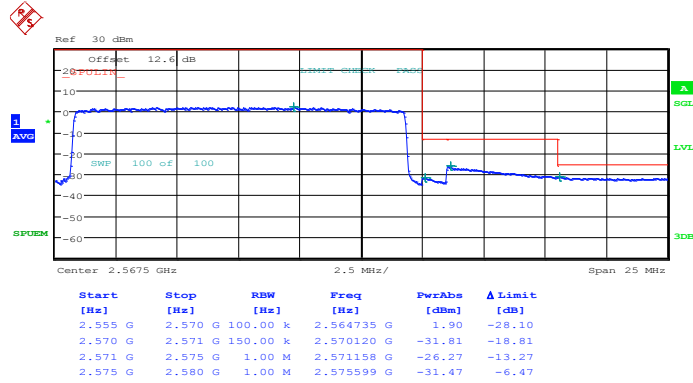

Date: 5.JUN.2014 22:05:52



Band :	LTE Band 7	Band Width :	15MHz / 16QAM
---------------	------------	---------------------	---------------

Lower Band Edge Plot for 16QAM-RB Size 1, RB Offset 0

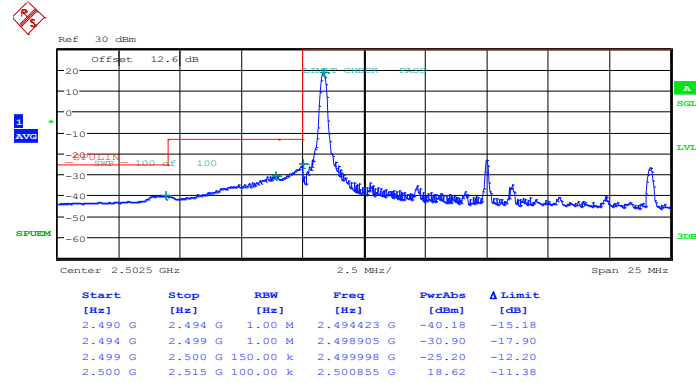

Date: 5.JUN.2014 22:01:53

Lower Band Edge Plot for 16QAM-RB Size 75, RB Offset 0

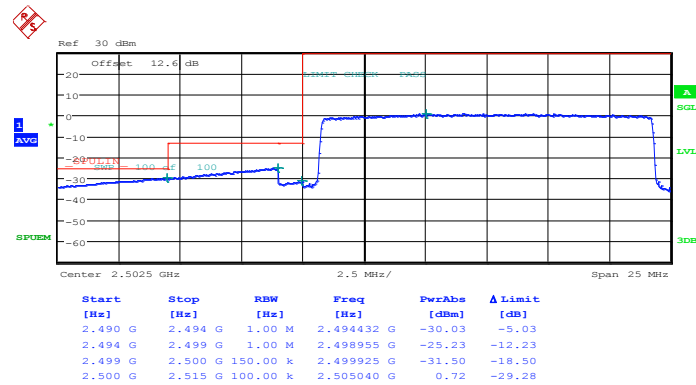

Date: 5.JUN.2014 22:03:29



Higher Band Edge Plot for 16QAM-RB Size 1, RB Offset 74

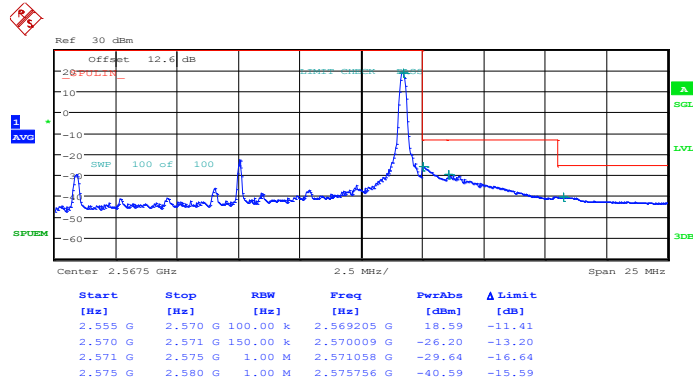

Date: 5.JUN.2014 22:05:04

Higher Band Edge Plot for 16QAM-RB Size 75, RB Offset 0

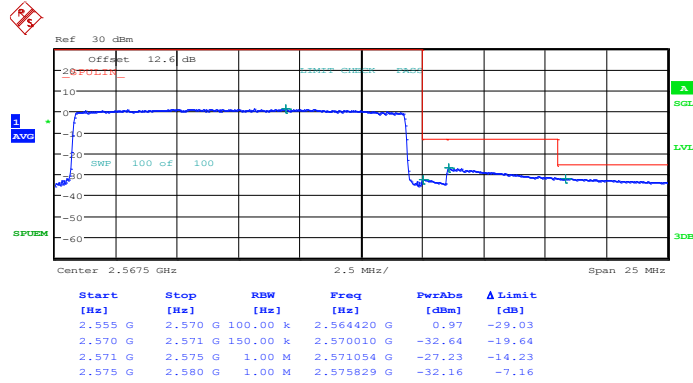

Date: 5.JUN.2014 22:06:40



Band :	LTE Band 7	Band Width :	20MHz / QPSK
---------------	------------	---------------------	--------------

Lower Band Edge Plot for QPSK-RB Size 1, RB Offset 0

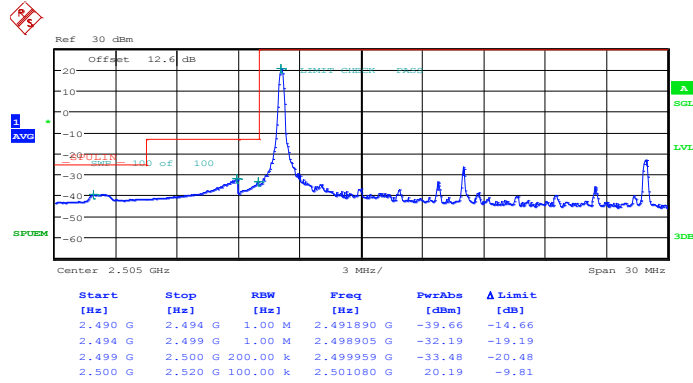

Date: 5.JUN.2014 22:07:47

Lower Band Edge Plot for QPSK-RB Size 100, RB Offset 0

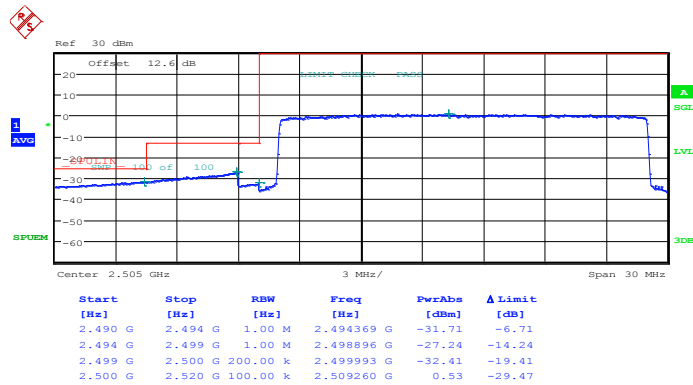

Date: 5.JUN.2014 22:09:23



Higher Band Edge Plot for QPSK-RB Size 1, RB Offset 99

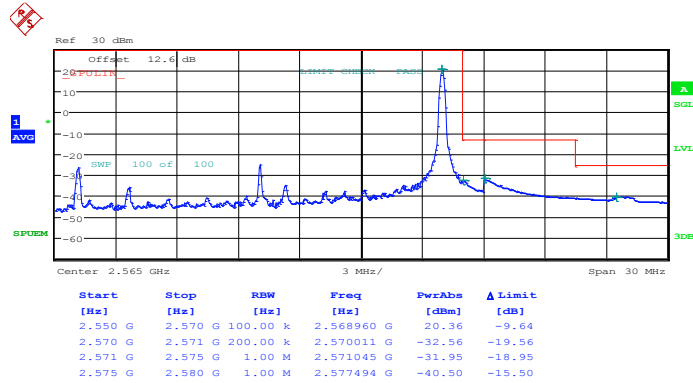

Date: 5.JUN.2014 22:10:58

Higher Band Edge Plot for QPSK-RB Size 100, RB Offset 0

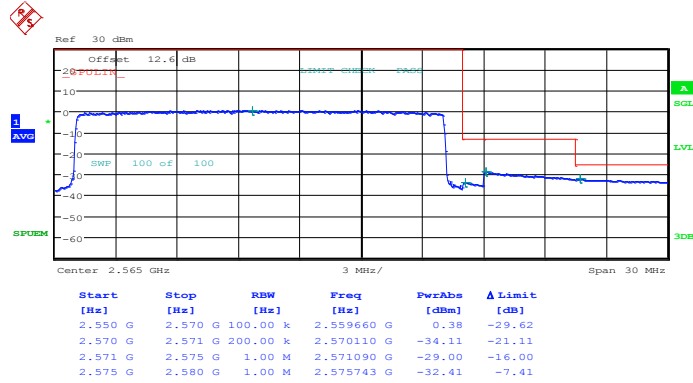

Date: 5.JUN.2014 22:13:21



Band :	LTE Band 7	Band Width :	20MHz / 16QAM
---------------	------------	---------------------	---------------

Lower Band Edge Plot for 16QAM-RB Size 1, RB Offset 0

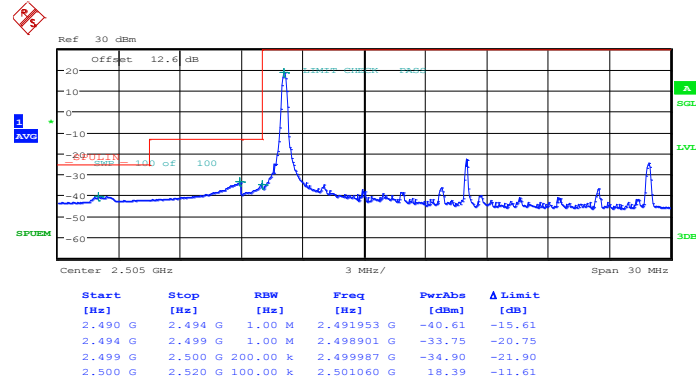

Date: 5.JUN.2014 22:08:35

Lower Band Edge Plot for 16QAM-RB Size 100, RB Offset 0

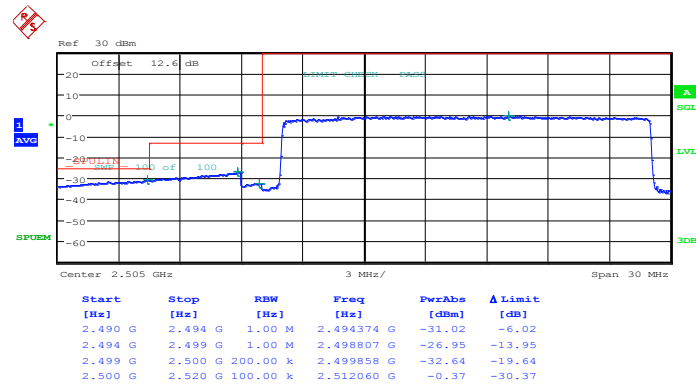

Date: 5.JUN.2014 22:10:11



Higher Band Edge Plot for 16QAM-RB Size 1, RB Offset 99

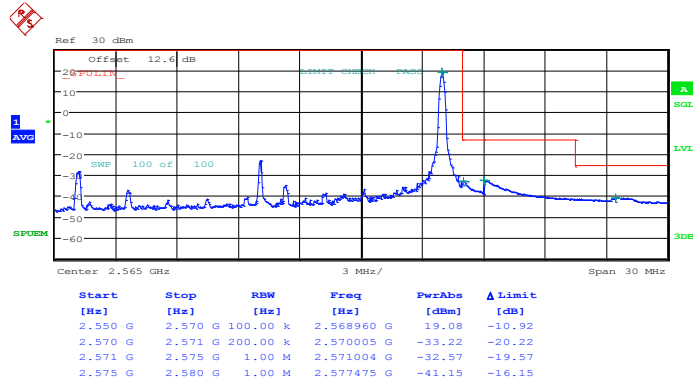

Date: 5.JUN.2014 22:11:46

Higher Band Edge Plot for 16QAM-RB Size 100, RB Offset 0

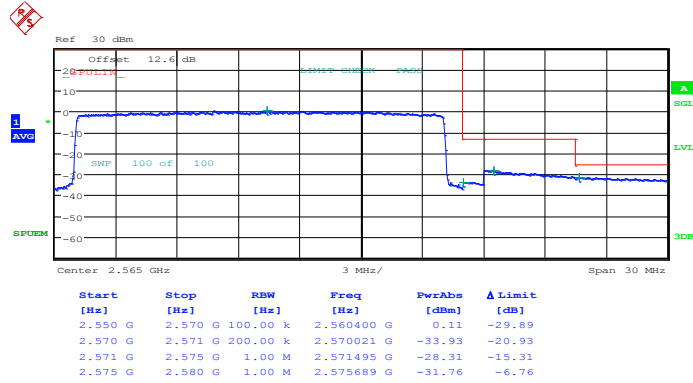

Date: 5.JUN.2014 22:12:33



3.5 Conducted Spurious Emission Measurement

3.5.1 Description of Conducted Spurious Emission Measurement

The power of any emission outside of the authorized operating frequency ranges must be lower than the transmitter power (P) by a factor of at least $43 + 10 \log (P)$ dB.

For Band 7

It is measured by means of a calibrated spectrum analyzer and scanned from 30MHz up to a frequency including its 10th harmonic.

*The test limit in the test data chooses worse limit to make sure test data is fine for different kinds of product. the real limit for fixed digital user station should be $43 + 10\log P(W)$.

3.5.2 Measuring Instruments

The measuring equipment is listed in the section 4 of this test report.

3.5.3 Test Procedures

1. The EUT was connected to spectrum analyzer and system simulator via a power divider.
2. The RF output of EUT was connected to the spectrum analyzer by RF cable and attenuator. The path loss was compensated to the results for each measurement.
3. The middle channel for the highest RF power within the transmitting frequency was measured.
4. The conducted spurious emission for the whole frequency range was taken.
5. Make the measurement with the spectrum analyzer's RBW = 1MHz, VBW = 3MHz, taking the record of maximum spurious emission.
6. The RF fundamental frequency should be excluded against the limit line in the operating frequency band.
7. The limit line is derived from $43 + 10\log(P)$ dB below the transmitter power P(Watts)
= $P(W) - [43 + 10\log(P)]$ (dB)
= $[30 + 10\log(P)]$ (dBm) - $[43 + 10\log(P)]$ (dB)
= -13dBm.
8. For Band 7
The limit line is derived from $55 + 10\log(P)$ dB below the transmitter power P(Watts)

3.5.4 Test Setup

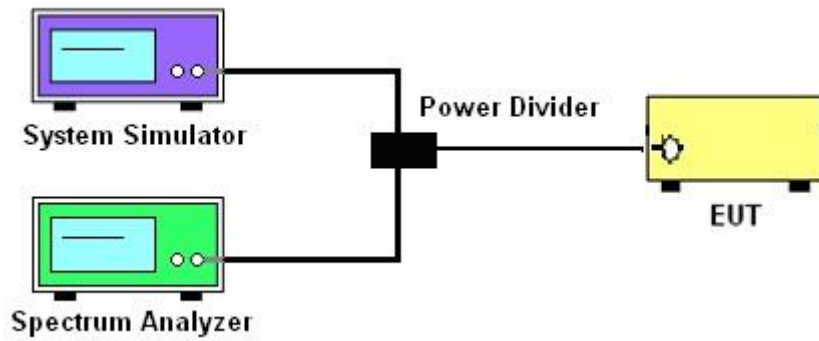



3.5.5 Test Result (Plots) of Conducted Spurious Emission

Band :	LTE Band 7	Channel :	CH20775 (Low)
Band Width :	5MHz		

QPSK (RB Size 1, RB Offset 0)

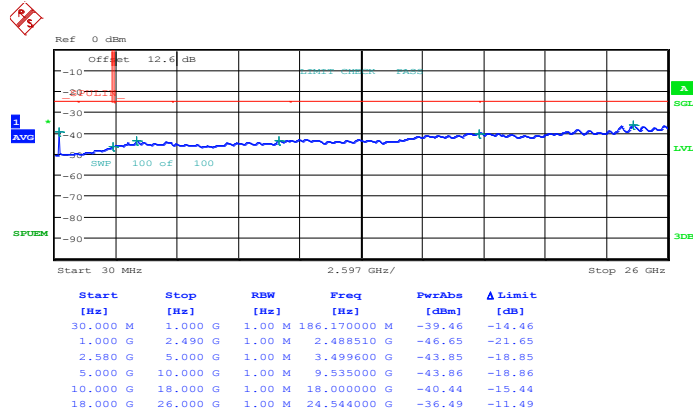

Date: 6.JUN.2014 09:36:22

16QAM (RB Size 1, RB Offset 0)

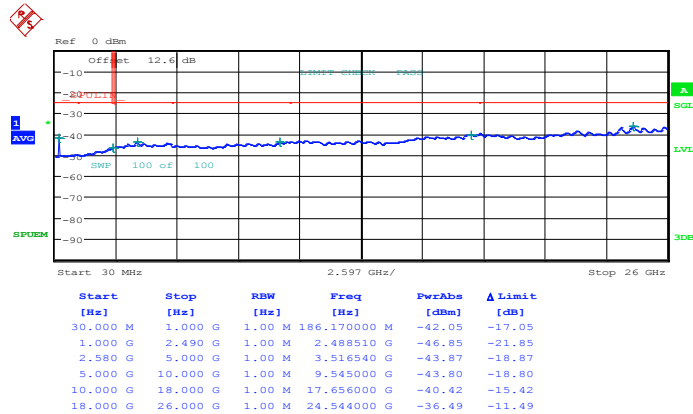

Date: 6.JUN.2014 09:37:26



Band :	LTE Band 7	Channel :	CH21100 (Middle)
Band Width :	5MHz		

QPSK (RB Size 1, RB Offset 0)

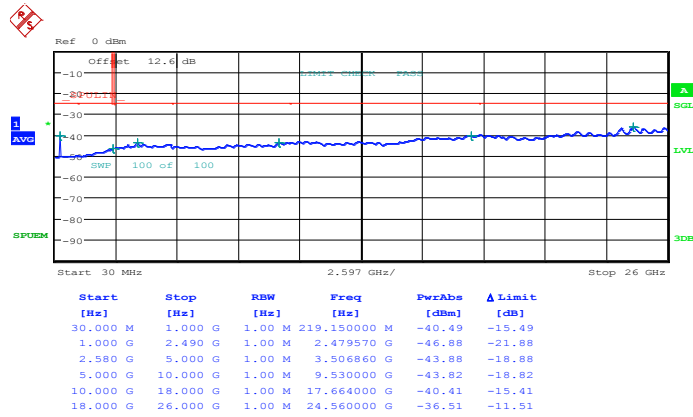

Date: 6.JUN.2014 09:39:43

16QAM (RB Size 1, RB Offset 0)

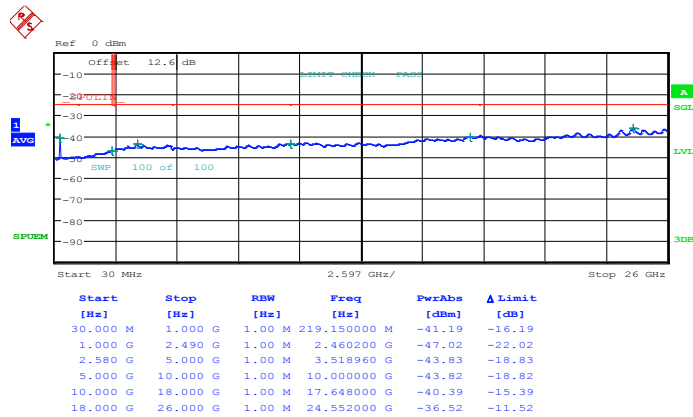

Date: 6.JUN.2014 09:40:47



Band :	LTE Band 7	Channel :	CH21425 (High)
Band Width :	5MHz		

QPSK (RB Size 1, RB Offset 0)

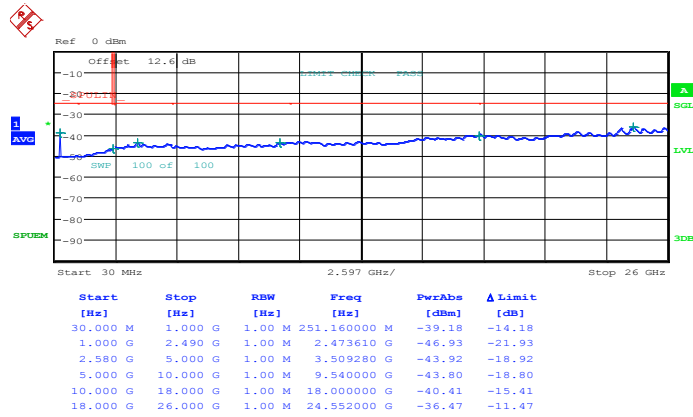

Date: 6.JUN.2014 09:46:16

16QAM (RB Size 1, RB Offset 0)

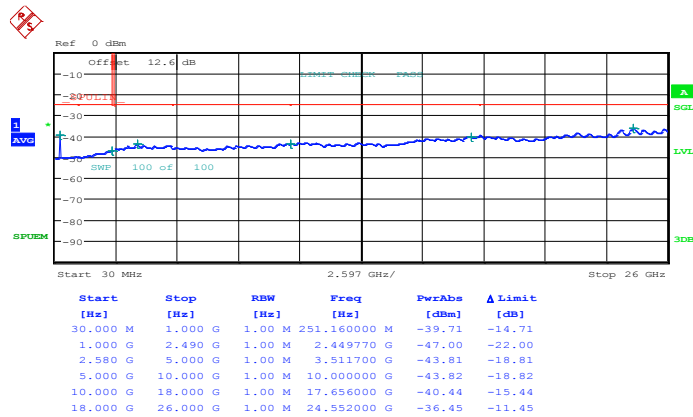

Date: 6.JUN.2014 09:47:21



Band :	LTE Band 7	Channel :	CH20800 (Low)
Band Width :	10MHz		

QPSK (RB Size 1, RB Offset 0)

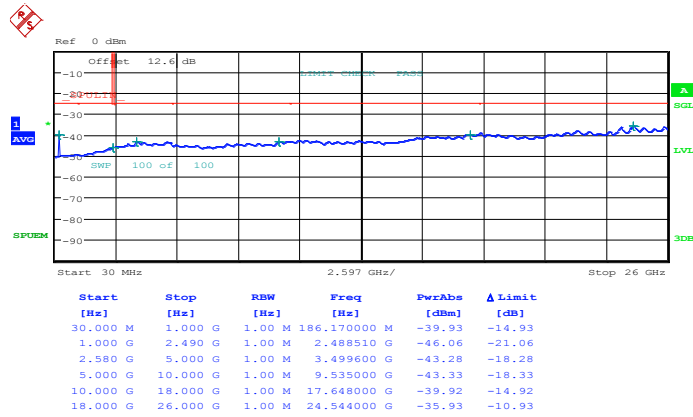

Date: 5.JUN.2014 23:34:03

16QAM (RB Size 1, RB Offset 0)

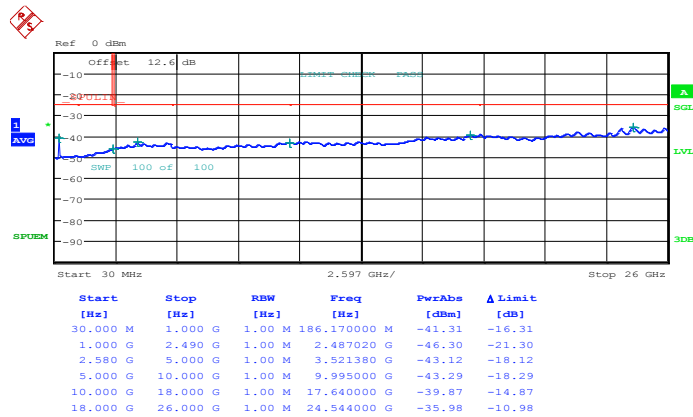

Date: 5.JUN.2014 23:35:07



Band :	LTE Band 7	Channel :	CH21100 (Middle)
Band Width :	10MHz		

QPSK (RB Size 1, RB Offset 0)

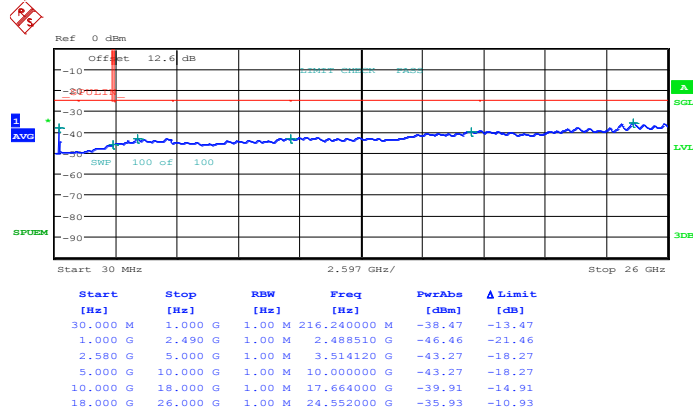

Date: 5.JUN.2014 23:37:24

16QAM (RB Size 1, RB Offset 0)

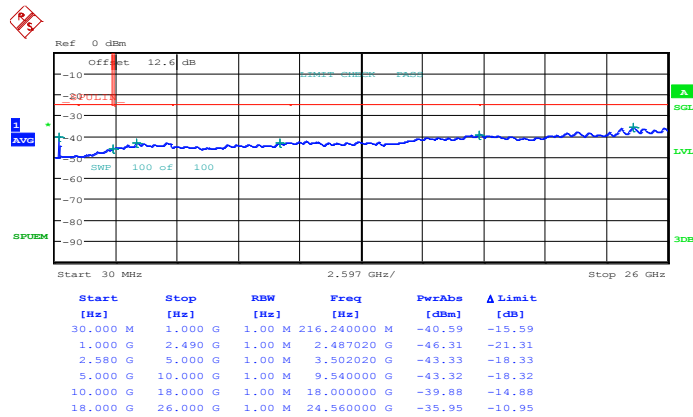

Date: 5.JUN.2014 23:38:28



Band :	LTE Band 7	Channel :	CH21400 (High)
Band Width :	10MHz		

QPSK (RB Size 1, RB Offset 0)

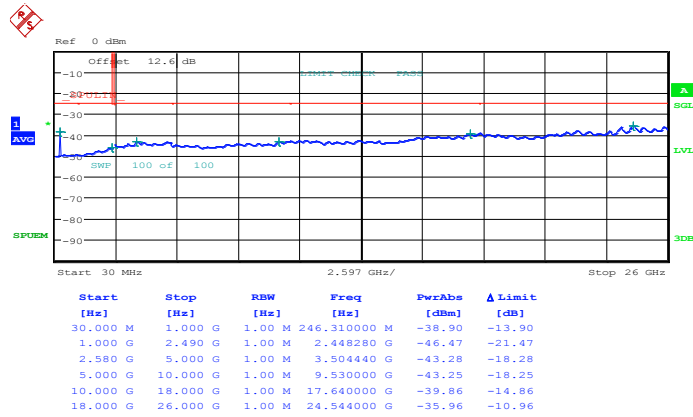

Date: 5.JUN.2014 23:40:44

16QAM (RB Size 1, RB Offset 0)

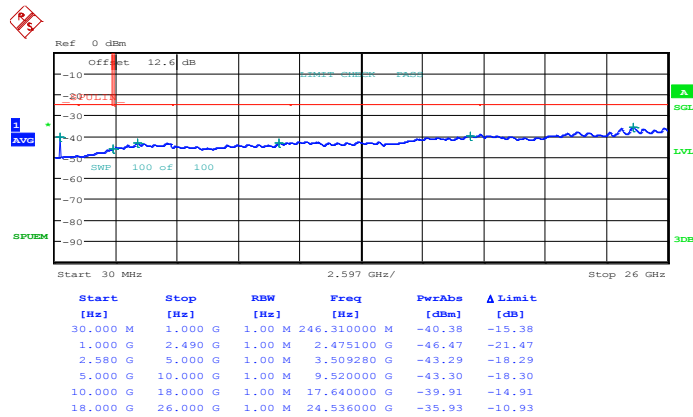

Date: 5.JUN.2014 23:41:48



Band :	LTE Band 7	Channel :	CH20825 (Low)
Band Width :	15MHz		

QPSK (RB Size 1, RB Offset 0)

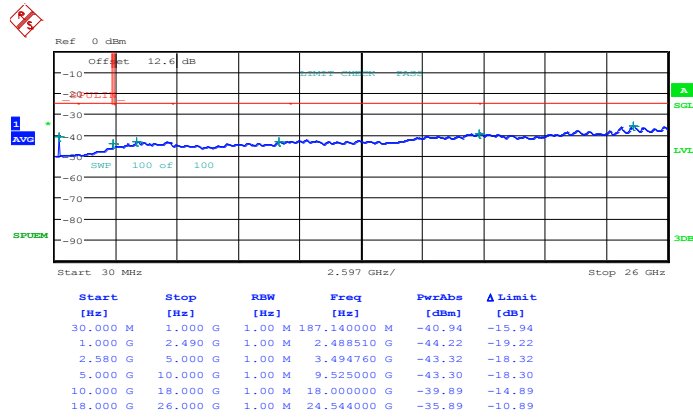

Date: 5.JUN.2014 23:50:09

16QAM (RB Size 1, RB Offset 0)

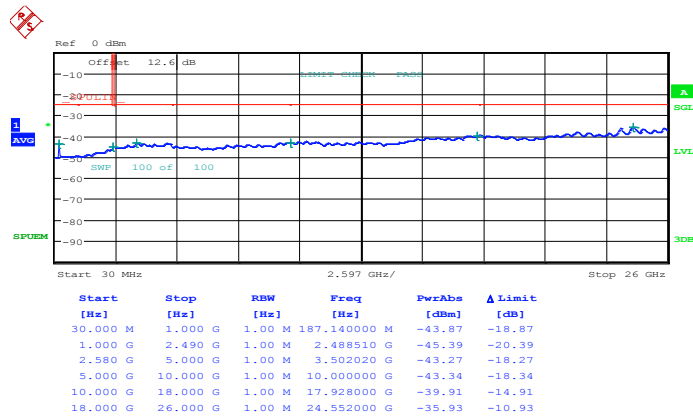

Date: 5.JUN.2014 23:51:09



Band :	LTE Band 7	Channel :	CH21100 (Middle)
Band Width :	15MHz		

QPSK (RB Size 1, RB Offset 0)

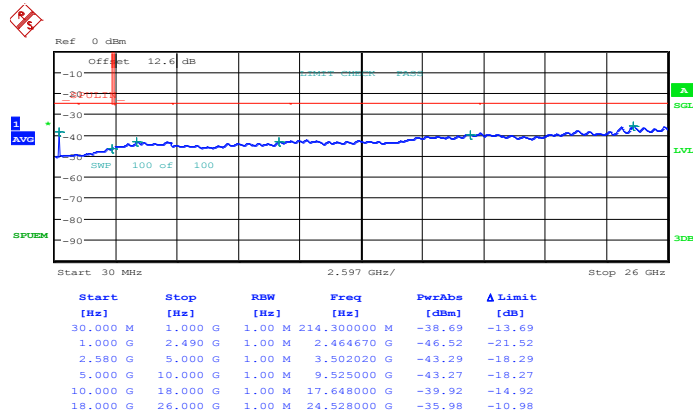

Date: 5.JUN.2014 23:53:18

16QAM (RB Size 1, RB Offset 0)

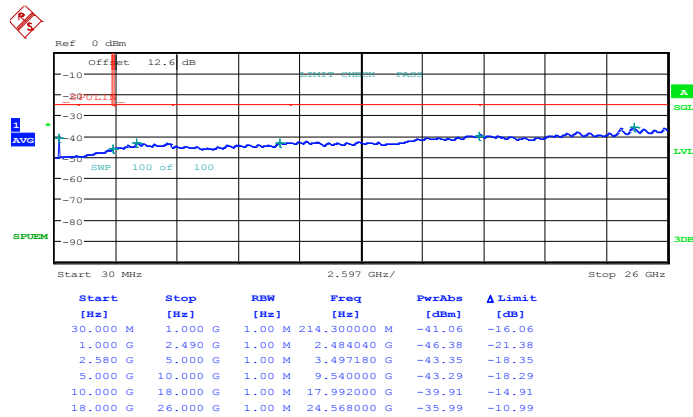

Date: 5.JUN.2014 23:54:18



Band :	LTE Band 7	Channel :	CH21375 (High)
Band Width :	15MHz		

QPSK (RB Size 1, RB Offset 0)

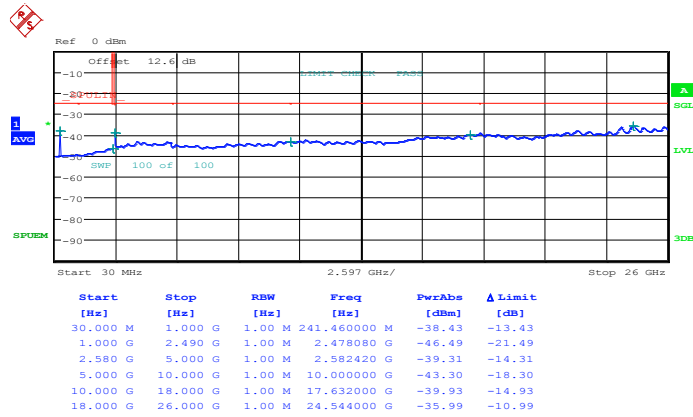

Date: 5.JUN.2014 23:56:27

16QAM (RB Size 1, RB Offset 0)

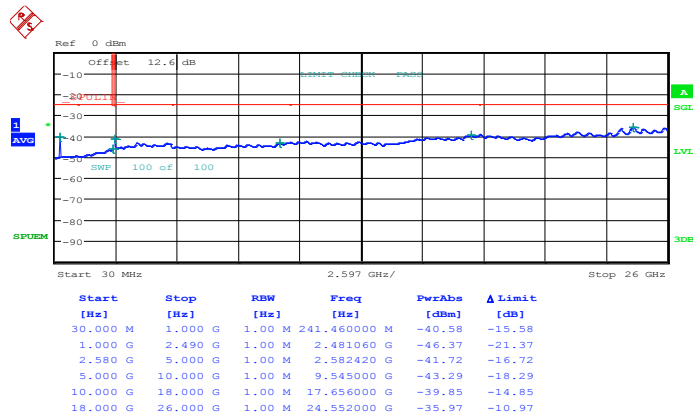

Date: 5.JUN.2014 23:57:27



Band :	LTE Band 7	Channel :	CH20850 (Low)
Band Width :	20MHz		

QPSK (RB Size 1, RB Offset 0)

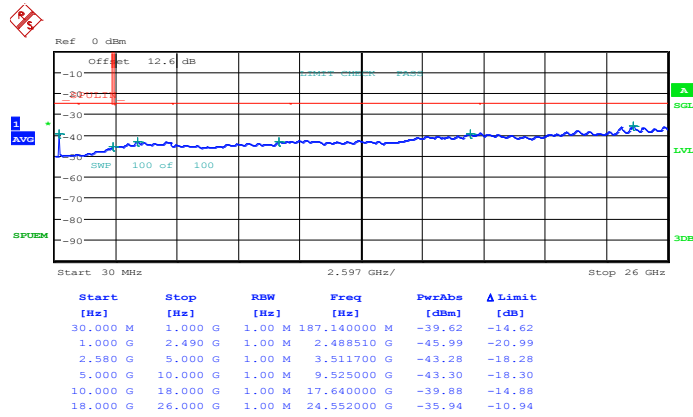

Date: 6.JUN.2014 00:02:42

16QAM (RB Size 1, RB Offset 0)

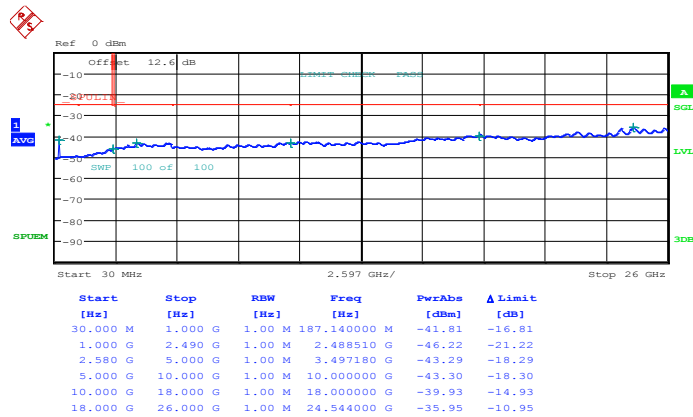

Date: 6.JUN.2014 00:03:46



Band :	LTE Band 7	Channel :	CH21100 (Middle)
Band Width :	20MHz		

QPSK (RB Size 1, RB Offset 0)

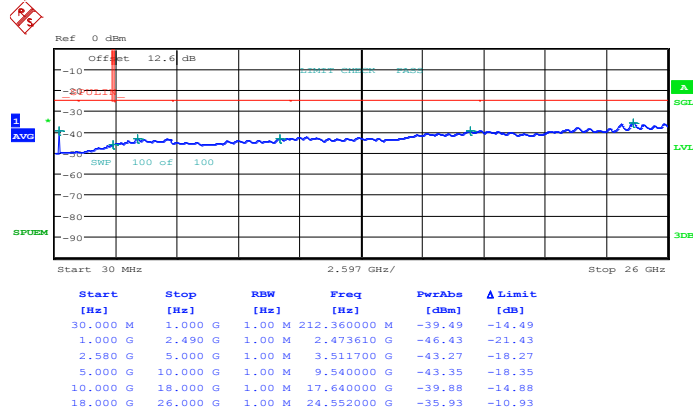

Date: 6.JUN.2014 00:06:01

16QAM (RB Size 1, RB Offset 0)

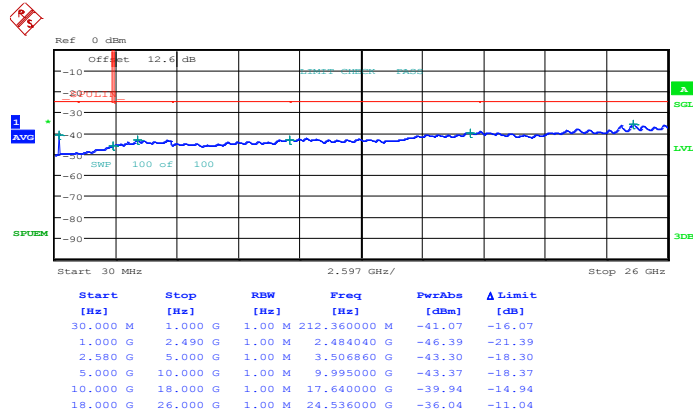

Date: 6.JUN.2014 00:07:05



Band :	LTE Band 7	Channel :	CH21350 (High)
Band Width :	20MHz		

QPSK (RB Size 1, RB Offset 0)

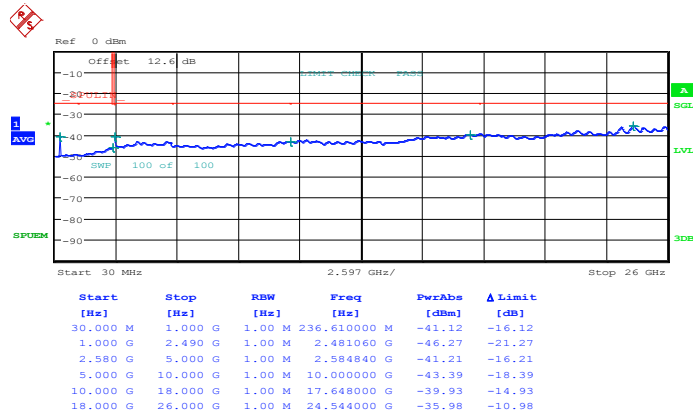

Date: 6.JUN.2014 00:09:21

16QAM (RB Size 1, RB Offset 0)

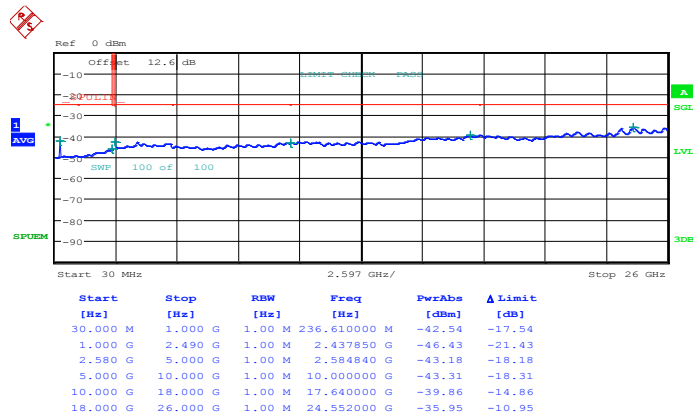

Date: 6.JUN.2014 00:10:24



3.6 Radiated Spurious Emission Measurement

3.6.1 Description of Radiated Spurious Emission

The radiated spurious emission was measured by substitution method according to ANSI / TIA / EIA-603-C-2004. The power of any emission outside of the authorized operating frequency ranges must be attenuated below the transmitter power (P) by a factor of at least $43 + 10 \log (P)$ dB.

For Band 7

The power of any emission outside of the authorized operating frequency ranges must be attenuated below the transmitter power (P) by a factor of at least $55 + 10 \log (P)$ dB.

The spectrum is scanned from 30 MHz up to a frequency including its 10th harmonic.

*The test limit in the test data chooses worse limit to make sure test data is fine for different kinds of product. the real limit for fixed digital user station should be $43 + 10 \log P(W)$.

3.6.2 Measuring Instruments

The measuring equipment is listed in the section 4 of this test report.

3.6.3 Test Procedures

1. The EUT was placed on a rotatable wooden table with 0.8 meter above ground.
2. The EUT was set 3 meters from the receiving antenna, which was mounted on the antenna tower.
3. The table was rotated 360 degrees to determine the position of the highest spurious emission.
4. The height of the receiving antenna is varied between one meter and four meters to search the maximum spurious emission for both horizontal and vertical polarizations.
5. Make the measurement with the spectrum analyzer's RBW = 1MHz, VBW = 3MHz, taking the record of maximum spurious emission.
6. A horn antenna was substituted in place of the EUT and was driven by a signal generator.
7. Tune the output power of signal generator to the same emission level with EUT maximum spurious emission.
8. Taking the record of output power at antenna port.
9. Repeat step 7 to step 8 for another polarization.
10. The RF fundamental frequency should be excluded against the limit line in the operating frequency band.

The limit line is derived from $43 + 10 \log(P)$ dB below the transmitter power P(Watts)
= $P(W) - [43 + 10 \log(P)]$ (dB)
= $[30 + 10 \log(P)]$ (dBm) - $[43 + 10 \log(P)]$ (dB)
= -13dBm.

For Band 7

The limit line is derived from $55 + 10 \log(P)$ dB below the transmitter power P(Watts)

11. EIRP (dBm) = S.G. Power – Tx Cable Loss + Tx Antenna Gain



12. ERP (dBm) = EIRP - 2.15

3.6.4 Test Setup

For radiated emissions from 30MHz to 1GHz

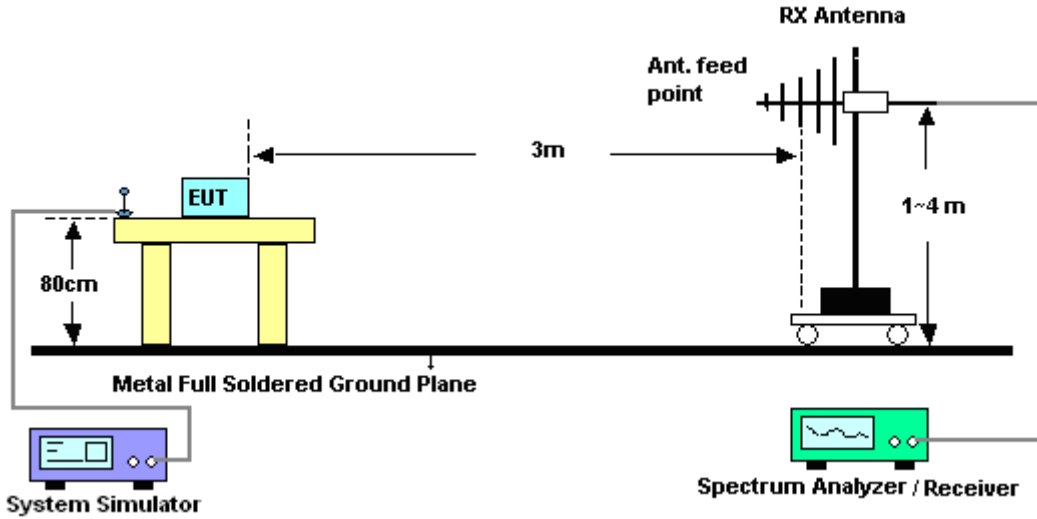

For radiated emissions above 1GHz

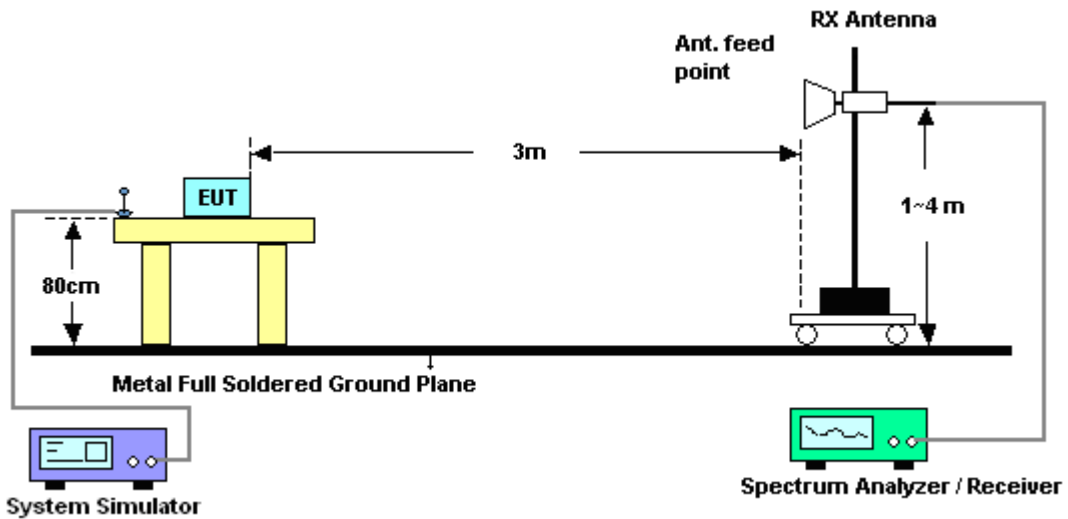



3.6.5 Test Result of Field Strength of Spurious Radiated

<Low Channel>

Band :	LTE Band 7		Temperature :	21~24°C					
Test Mode :	20MHz QPSK RB Size 1 Offset 0		Relative Humidity :	44~48%					
Test Engineer :	Eric Shih		Polarization :	Horizontal					
Remark :	Spurious emissions within 30-10th harmonic were found more than 20dB below limit line.								
Frequency (MHz)	EIRP (dBm)	Limit (dBm)	Over Limit (dB)	SPA Reading (dBm)	S.G. Power (dBm)	TX Cable loss (dB)	TX Antenna Gain (dBi)	Polarization (H/V)	Result
5002	-31.15	-25	-6.15	-48.99	-34.7	6.83	10.38	H	Pass
7503	-32.03	-25	-7.03	-59.52	-35	9.28	12.25	H	Pass
10002	-37.15	-25	-12.15	-66.07	-41.5	8.54	12.89	H	Pass

Band :	LTE Band 7		Temperature :	21~24°C					
Test Mode :	20MHz QPSK RB Size 1 Offset 0		Relative Humidity :	44~48%					
Test Engineer :	Eric Shih		Polarization :	Vertical					
Remark :	Spurious emissions within 30-10th harmonic were found more than 20dB below limit line.								
Frequency (MHz)	EIRP (dBm)	Limit (dBm)	Over Limit (dB)	SPA Reading (dBm)	S.G. Power (dBm)	TX Cable loss (dB)	TX Antenna Gain (dBi)	Polarization (H/V)	Result
5002	-25.35	-25	-0.35	-42.5	-28.9	6.83	10.38	V	Pass
7500	-35.13	-25	-10.13	-62.55	-38.1	9.28	12.25	V	Pass
10002	-37.55	-25	-12.55	-65.42	-41.9	8.54	12.89	V	Pass



<Middle Channel>

Band :	LTE Band 7	Temperature :	21~24°C						
Test Mode :	20MHz QPSK RB Size 1 Offset 0	Relative Humidity :	44~48%						
Test Engineer :	Eric Shih	Polarization :	Horizontal						
Remark :	Spurious emissions within 30-10th harmonic were found more than 20dB below limit line.								
Frequency (MHz)	EIRP (dBm)	Limit (dBm)	Over Limit (dB)	SPA Reading (dBm)	S.G. Power (dBm)	TX Cable loss (dB)	TX Antenna Gain (dBi)	Polarization (H/V)	Result
5052	-33.61	-25	-8.61	-51.82	-37.1	6.86	10.35	H	Pass
7578	-30.01	-25	-5.01	-56.88	-32.9	9.34	12.23	H	Pass
10104	-35.10	-25	-10.10	-64.11	-39.2	8.64	12.74	H	Pass

Band :	LTE Band 7	Temperature :	21~24°C						
Test Mode :	20MHz QPSK RB Size 1 Offset 0	Relative Humidity :	44~48%						
Test Engineer :	Eric Shih	Polarization :	Vertical						
Remark :	Spurious emissions within 30-10th harmonic were found more than 20dB below limit line.								
Frequency (MHz)	EIRP (dBm)	Limit (dBm)	Over Limit (dB)	SPA Reading (dBm)	S.G. Power (dBm)	TX Cable loss (dB)	TX Antenna Gain (dBi)	Polarization (H/V)	Result
5052	-29.71	-25	-4.71	-48.12	-33.2	6.86	10.35	V	Pass
7578	-36.01	-25	-11.01	-62.85	-38.9	9.34	12.23	V	Pass
10102	-38.10	-25	-13.10	-66.21	-42.2	8.64	12.74	V	Pass



<High Channel>

Band :	LTE Band 7					Temperature :	21~24°C		
Test Mode :	20MHz QPSK RB Size 1 Offset 0					Relative Humidity :	44~48%		
Test Engineer :	Eric Shih					Polarization :	Horizontal		
Remark :	Spurious emissions within 30-10th harmonic were found more than 20dB below limit line.								
Frequency (MHz)	EIRP (dBm)	Limit (dBm)	Over Limit (dB)	SPA Reading (dBm)	S.G. Power (dBm)	TX Cable loss (dB)	TX Antenna Gain (dBi)	Polarization (H/V)	Result
5100	-31.66	-25	-6.66	-50.04	-36.2	5.84	10.38	H	Pass
7650	-32.36	-25	-7.36	-58.97	-35.3	9.33	12.27	H	Pass
10204	-37.60	-25	-12.60	-66.6	-41.8	8.6	12.80	H	Pass

Band :	LTE Band 7					Temperature :	21~24°C		
Test Mode :	20MHz QPSK RB Size 1 Offset 0					Relative Humidity :	44~48%		
Test Engineer :	Eric Shih					Polarization :	Vertical		
Remark :	Spurious emissions within 30-10th harmonic were found more than 20dB below limit line.								
Frequency (MHz)	EIRP (dBm)	Limit (dBm)	Over Limit (dB)	SPA Reading (dBm)	S.G. Power (dBm)	TX Cable loss (dB)	TX Antenna Gain (dBi)	Polarization (H/V)	Result
5100	-25.36	-25	-0.36	-42.96	-29.9	5.84	10.38	V	Pass
7653	-37.16	-25	-12.16	-63.21	-40.1	9.33	12.27	V	Pass
10204	-39.70	-25	-14.70	-67.88	-43.9	8.6	12.80	V	Pass



<Low Channel>

Band :	LTE Band 7	Temperature :	21~24°C						
Test Mode :	15MHz QPSK RB Size 1 Offset 0	Relative Humidity :	44~48%						
Test Engineer :	Eric Shih	Polarization :	Horizontal						
Remark :	Spurious emissions within 30-10th harmonic were found more than 20dB below limit line.								
Frequency (MHz)	EIRP (dBm)	Limit (dBm)	Over Limit (dB)	SPA Reading (dBm)	S.G. Power (dBm)	TX Cable loss (dB)	TX Antenna Gain (dBi)	Polarization (H/V)	Result
5002	-32.95	-25	-7.95	-50.84	-36.5	6.82	10.37	H	Pass
7500	-32.71	-25	-7.71	-60.54	-35.7	9.27	12.26	H	Pass
10002	-37.27	-25	-12.27	-65.92	-41.6	8.55	12.88	H	Pass

Band :	LTE Band 7	Temperature :	21~24°C						
Test Mode :	15MHz QPSK RB Size 1 Offset 0	Relative Humidity :	44~48%						
Test Engineer :	Eric Shih	Polarization :	Vertical						
Remark :	Spurious emissions within 30-10th harmonic were found more than 20dB below limit line.								
Frequency (MHz)	EIRP (dBm)	Limit (dBm)	Over Limit (dB)	SPA Reading (dBm)	S.G. Power (dBm)	TX Cable loss (dB)	TX Antenna Gain (dBi)	Polarization (H/V)	Result
5002	-25.25	-25	-0.25	-42.3	-28.8	6.82	10.37	V	Pass
7500	-38.51	-25	-13.51	-66.3	-41.5	9.27	12.26	V	Pass
10002	-36.57	-25	-11.57	-65.01	-40.9	8.55	12.88	V	Pass



<Middle Channel>

Band :	LTE Band 7	Temperature :	21~24°C						
Test Mode :	15MHz QPSK RB Size 1 Offset 0	Relative Humidity :	44~48%						
Test Engineer :	Eric Shih	Polarization :	Horizontal						
Remark :	Spurious emissions within 30-10th harmonic were found more than 20dB below limit line.								
Frequency (MHz)	EIRP (dBm)	Limit (dBm)	Over Limit (dB)	SPA Reading (dBm)	S.G. Power (dBm)	TX Cable loss (dB)	TX Antenna Gain (dBi)	Polarization (H/V)	Result
5058	-33.41	-25	-8.41	-51.85	-36.9	6.86	10.35	H	Pass
7584	-30.41	-25	-5.41	-57.52	-33.3	9.34	12.23	H	Pass
10110	-36.00	-25	-11.00	-64.82	-40.1	8.64	12.74	H	Pass

Band :	LTE Band 7	Temperature :	21~24°C						
Test Mode :	15MHz QPSK RB Size 1 Offset 0	Relative Humidity :	44~48%						
Test Engineer :	Eric Shih	Polarization :	Vertical						
Remark :	Spurious emissions within 30-10th harmonic were found more than 20dB below limit line.								
Frequency (MHz)	EIRP (dBm)	Limit (dBm)	Over Limit (dB)	SPA Reading (dBm)	S.G. Power (dBm)	TX Cable loss (dB)	TX Antenna Gain (dBi)	Polarization (H/V)	Result
5058	-29.31	-25	-4.31	-47.5	-32.8	6.86	10.35	V	Pass
7584	-35.21	-25	-10.21	-62.37	-38.1	9.34	12.23	V	Pass
10110	-38.00	-25	-13.00	-66.09	-42.1	8.64	12.74	V	Pass



<High Channel>

Band :	LTE Band 7	Temperature :	21~24°C						
Test Mode :	15MHz QPSK RB Size 1 Offset 0	Relative Humidity :	44~48%						
Test Engineer :	Eric Shih	Polarization :	Horizontal						
Remark :	Spurious emissions within 30-10th harmonic were found more than 20dB below limit line.								
Frequency (MHz)	EIRP (dBm)	Limit (dBm)	Over Limit (dB)	SPA Reading (dBm)	S.G. Power (dBm)	TX Cable loss (dB)	TX Antenna Gain (dBi)	Polarization (H/V)	Result
5112	-30.56	-25	-5.56	-49.14	-34.1	6.87	10.41	H	Pass
7668	-32.35	-25	-7.35	-58.85	-35.3	9.35	12.30	H	Pass
10224	-38.31	-25	-13.31	-67.33	-42.5	8.63	12.82	H	Pass

Band :	LTE Band 7	Temperature :	21~24°C						
Test Mode :	15MHz QPSK RB Size 1 Offset 0	Relative Humidity :	44~48%						
Test Engineer :	Eric Shih	Polarization :	Vertical						
Remark :	Spurious emissions within 30-10th harmonic were found more than 20dB below limit line.								
Frequency (MHz)	EIRP (dBm)	Limit (dBm)	Over Limit (dB)	SPA Reading (dBm)	S.G. Power (dBm)	TX Cable loss (dB)	TX Antenna Gain (dBi)	Polarization (H/V)	Result
5112	-25.46	-25	-0.46	-43.14	-29	6.87	10.41	V	Pass
7668	-37.35	-25	-12.35	-63.5	-40.3	9.35	12.30	V	Pass
10224	-40.71	-25	-15.71	-68.9	-44.9	8.63	12.82	V	Pass



<Low Channel>

Band :	LTE Band 7	Temperature :	21~24°C						
Test Mode :	10MHz QPSK RB Size 1 Offset 0	Relative Humidity :	44~48%						
Test Engineer :	Eric Shih	Polarization :	Horizontal						
Remark :	Spurious emissions within 30-10th harmonic were found more than 20dB below limit line.								
Frequency (MHz)	EIRP (dBm)	Limit (dBm)	Over Limit (dB)	SPA Reading (dBm)	S.G. Power (dBm)	TX Cable loss (dB)	TX Antenna Gain (dBi)	Polarization (H/V)	Result
5000	-32.76	-25	-7.76	-50.79	-36.3	6.81	10.35	H	Pass
7500	-33.42	-25	-8.42	-60.9	-36.4	9.26	12.24	H	Pass
10002	-38.31	-25	-13.31	-67.25	-42.6	8.54	12.83	H	Pass

Band :	LTE Band 7	Temperature :	21~24°C						
Test Mode :	10MHz QPSK RB Size 1 Offset 0	Relative Humidity :	44~48%						
Test Engineer :	Eric Shih	Polarization :	Vertical						
Remark :	Spurious emissions within 30-10th harmonic were found more than 20dB below limit line.								
Frequency (MHz)	EIRP (dBm)	Limit (dBm)	Over Limit (dB)	SPA Reading (dBm)	S.G. Power (dBm)	TX Cable loss (dB)	TX Antenna Gain (dBi)	Polarization (H/V)	Result
5001	-25.56	-25	-0.56	-42.76	-29.1	6.81	10.35	V	Pass
7500	-35.22	-25	-10.22	-62.48	-38.2	9.26	12.24	V	Pass
10000	-37.21	-25	-12.21	-65.1	-41.5	8.54	12.83	V	Pass



<Middle Channel>

Band :	LTE Band 7	Temperature :	21~24°C						
Test Mode :	10MHz QPSK RB Size 1 Offset 0	Relative Humidity :	44~48%						
Test Engineer :	Eric Shih	Polarization :	Horizontal						
Remark :	Spurious emissions within 30-10th harmonic were found more than 20dB below limit line.								
Frequency (MHz)	EIRP (dBm)	Limit (dBm)	Over Limit (dB)	SPA Reading (dBm)	S.G. Power (dBm)	TX Cable loss (dB)	TX Antenna Gain (dBi)	Polarization (H/V)	Result
5058	-30.81	-25	-5.81	-49.41	-34.3	6.86	10.35	H	Pass
7590	-31.61	-25	-6.61	-58.7	-34.5	9.34	12.23	H	Pass
10122	-37.40	-25	-12.40	-66.29	-41.5	8.64	12.74	H	Pass

Band :	LTE Band 7	Temperature :	21~24°C						
Test Mode :	10MHz QPSK RB Size 1 Offset 0	Relative Humidity :	44~48%						
Test Engineer :	Eric Shih	Polarization :	Vertical						
Remark :	Spurious emissions within 30-10th harmonic were found more than 20dB below limit line.								
Frequency (MHz)	EIRP (dBm)	Limit (dBm)	Over Limit (dB)	SPA Reading (dBm)	S.G. Power (dBm)	TX Cable loss (dB)	TX Antenna Gain (dBi)	Polarization (H/V)	Result
5058	-28.01	-25	-3.01	-46.39	-31.5	6.86	10.35	V	Pass
7590	-37.01	-25	-12.01	-63.8	-39.9	9.34	12.23	V	Pass
10122	-38.50	-25	-13.50	-66.81	-42.6	8.64	12.74	V	Pass



<High Channel>

Band :	LTE Band 7					Temperature :	21~24°C		
Test Mode :	10MHz QPSK RB Size 1 Offset 0					Relative Humidity :	44~48%		
Test Engineer :	Eric Shih					Polarization :	Horizontal		
Remark :	Spurious emissions within 30-10th harmonic were found more than 20dB below limit line.								
Frequency (MHz)	EIRP (dBm)	Limit (dBm)	Over Limit (dB)	SPA Reading (dBm)	S.G. Power (dBm)	TX Cable loss (dB)	TX Antenna Gain (dBi)	Polarization (H/V)	Result
5118	-34.06	-25	-9.06	-52.4	-37.6	6.88	10.42	H	Pass
7680	-32.86	-25	-7.86	-59.08	-35.8	9.37	12.31	H	Pass
10240	-40.11	-25	-15.11	-69.56	-44.3	8.64	12.83	H	Pass

Band :	LTE Band 7					Temperature :	21~24°C		
Test Mode :	10MHz QPSK RB Size 1 Offset 0					Relative Humidity :	44~48%		
Test Engineer :	Eric Shih					Polarization :	Vertical		
Remark :	Spurious emissions within 30-10th harmonic were found more than 20dB below limit line.								
Frequency (MHz)	EIRP (dBm)	Limit (dBm)	Over Limit (dB)	SPA Reading (dBm)	S.G. Power (dBm)	TX Cable loss (dB)	TX Antenna Gain (dBi)	Polarization (H/V)	Result
5118	-25.76	-25	-0.76	-43.51	-29.3	6.88	10.42	V	Pass
7680	-35.66	-25	-10.66	-61.72	-38.6	9.37	12.31	V	Pass
10240	-41.01	-25	-16.01	-69.24	-45.2	8.64	12.83	V	Pass



<Low Channel>

Band :	LTE Band 7	Temperature :	21~24°C						
Test Mode :	5MHz QPSK RB Size 1 Offset 0	Relative Humidity :	44~48%						
Test Engineer :	Eric Shih	Polarization :	Horizontal						
Remark :	Spurious emissions within 30-10th harmonic were found more than 20dB below limit line.								
Frequency (MHz)	EIRP (dBm)	Limit (dBm)	Over Limit (dB)	SPA Reading (dBm)	S.G. Power (dBm)	TX Cable loss (dB)	TX Antenna Gain (dBi)	Polarization (H/V)	Result
4998	-33.14	-25	-8.14	-51.09	-36.7	6.78	10.34	H	Pass
7500	-30.46	-25	-5.46	-58.28	-33.5	9.22	12.26	H	Pass
10002	-36.46	-25	-11.46	-65.34	-40.8	8.51	12.85	H	Pass

Band :	LTE Band 7	Temperature :	21~24°C						
Test Mode :	5MHz QPSK RB Size 1 Offset 0	Relative Humidity :	44~48%						
Test Engineer :	Eric Shih	Polarization :	Vertical						
Remark :	Spurious emissions within 30-10th harmonic were found more than 20dB below limit line.								
Frequency (MHz)	EIRP (dBm)	Limit (dBm)	Over Limit (dB)	SPA Reading (dBm)	S.G. Power (dBm)	TX Cable loss (dB)	TX Antenna Gain (dBi)	Polarization (H/V)	Result
5000	-25.34	-25	-0.34	-42.53	-28.9	6.78	10.34	V	Pass
7500	-36.56	-25	-11.56	-64.05	-39.6	9.22	12.26	V	Pass
10002	-36.76	-25	-11.76	-64.63	-41.1	8.51	12.85	V	Pass



<Middle Channel>

Band :	LTE Band 7					Temperature :	21~24°C		
Test Mode :	5MHz QPSK RB Size 1 Offset 0					Relative Humidity :	44~48%		
Test Engineer :	Eric Shih					Polarization :	Horizontal		
Remark :	Spurious emissions within 30-10th harmonic were found more than 20dB below limit line.								
Frequency (MHz)	EIRP (dBm)	Limit (dBm)	Over Limit (dB)	SPA Reading (dBm)	S.G. Power (dBm)	TX Cable loss (dB)	TX Antenna Gain (dBi)	Polarization (H/V)	Result
5064	-32.61	-25	-7.61	-50.82	-36.1	6.86	10.35	H	Pass
7596	-33.31	-25	-8.31	-60.03	-36.2	9.34	12.23	H	Pass
10128	-36.10	-25	-11.10	-65.17	-40.2	8.64	12.74	H	Pass

Band :	LTE Band 7					Temperature :	21~24°C		
Test Mode :	5MHz QPSK RB Size 1 Offset 0					Relative Humidity :	44~48%		
Test Engineer :	Eric Shih					Polarization :	Vertical		
Remark :	Spurious emissions within 30-10th harmonic were found more than 20dB below limit line.								
Frequency (MHz)	EIRP (dBm)	Limit (dBm)	Over Limit (dB)	SPA Reading (dBm)	S.G. Power (dBm)	TX Cable loss (dB)	TX Antenna Gain (dBi)	Polarization (H/V)	Result
5064	-27.81	-25	-2.81	-46.36	-31.3	6.86	10.35	V	Pass
7596	-37.61	-25	-12.61	-64.47	-40.5	9.34	12.23	V	Pass
10128	-39.10	-25	-14.10	-67.05	-43.2	8.64	12.74	V	Pass



<High Channel>

Band :	LTE Band 7	Temperature :	21~24°C						
Test Mode :	5MHz QPSK RB Size 1 Offset 0	Relative Humidity :	44~48%						
Test Engineer :	Eric Shih	Polarization :	Horizontal						
Remark :	Spurious emissions within 30-10th harmonic were found more than 20dB below limit line.								
Frequency (MHz)	EIRP (dBm)	Limit (dBm)	Over Limit (dB)	SPA Reading (dBm)	S.G. Power (dBm)	TX Cable loss (dB)	TX Antenna Gain (dBi)	Polarization (H/V)	Result
5130	-30.77	-25	-5.77	-49.43	-34.3	6.9	10.43	H	Pass
7698	-30.87	-25	-5.87	-56.82	-33.8	9.39	12.32	H	Pass
10260	-37.96	-25	-12.96	-67.15	-42.1	8.71	12.85	H	Pass

Band :	LTE Band 7	Temperature :	21~24°C						
Test Mode :	5MHz QPSK RB Size 1 Offset 0	Relative Humidity :	44~48%						
Test Engineer :	Eric Shih	Polarization :	Vertical						
Remark :	Spurious emissions within 30-10th harmonic were found more than 20dB below limit line.								
Frequency (MHz)	EIRP (dBm)	Limit (dBm)	Over Limit (dB)	SPA Reading (dBm)	S.G. Power (dBm)	TX Cable loss (dB)	TX Antenna Gain (dBi)	Polarization (H/V)	Result
5130	-28.57	-25	-3.57	-47.38	-32.1	6.9	10.43	V	Pass
7698	-35.27	-25	-10.27	-61.25	-38.2	9.39	12.32	V	Pass
10260	-40.16	-25	-15.16	-68.33	-44.3	8.71	12.85	V	Pass

3.7 Frequency Stability Measurement

3.7.1 Description of Frequency Stability Measurement

The frequency stability shall be measured by variation of ambient temperature and variation of primary supply voltage to ensure that the fundamental emission stays within the authorized frequency block. The frequency stability of the transmitter shall be maintained within $\pm 0.00025\%$ ($\pm 2.5\text{ppm}$) of the center frequency.

3.7.2 Measuring Instruments

The measuring equipment is listed in the section 4 of this test report.

3.7.3 Test Procedures for Temperature Variation

1. The EUT was set up in the thermal chamber and connected with the system simulator.
2. With power OFF, the temperature was decreased to -30°C and the EUT was stabilized before testing. Power was applied and the maximum change in frequency was recorded within one minute.
3. With power OFF, the temperature was raised in 10°C step up to 50°C . The EUT was stabilized at each step for at least half an hour. Power was applied and the maximum frequency change was recorded within one minute.

3.7.4 Test Procedures for Voltage Variation

1. The EUT was placed in a temperature chamber at $25\pm 5^{\circ}\text{C}$ and connected with the system simulator.
2. The power supply voltage to the EUT was varied from 85% to 115% of the nominal value measured at the input to the EUT.
3. The variation in frequency was measured for the worst case.

3.7.5 Test Setup

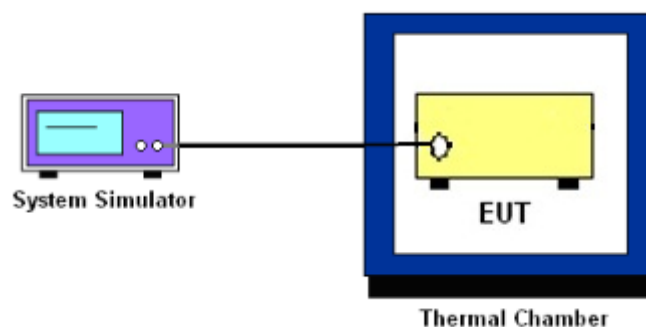



3.7.6 Test Result of Temperature Variation (FCC)

Band :	LTE Band 7 (QPSK)	Limit (ppm) :	2.5
Temperature (°C)	BW 10MHz		Result
	Deviation (ppm)		
50	0.0010		PASS
40	0.0001		
30	0.0115		
20(Ref.)	0.0000		
10	0.0108		
0	0.0102		
-10	0.0013		
-20	0.0106		
-30	0.0100		

3.7.7 Test Result of Voltage Variation (FCC)

Band	Bandwidth	Voltage (Volt)	Deviation (ppm)	Limit (ppm)	Result
LTE Band 7	10M	240.00	0.0014	2.5	PASS
		Normal	0.0113		
		100.00	0.0110		

Remark:

1. Normal Voltage = 230.00V.
2. The manufacturer declared that the EUT could work properly between voltage 100.00V ~ 240.00V.



4 List of Measuring Equipment

Instrument	Manufacturer	Model No.	Serial No.	Characteristics	Calibration Date	Test Date	Due Date	Remark
Spectrum Analyzer	Rohde & Schwarz	FSP40	100057	9kHz~40GHz	Oct. 23, 2013	Jun. 05, 2014~ Jun. 06, 2014	Oct. 22, 2014	Conducted (TH02-HY)
Thermal Chamber	Ten Billion	TTH-D3SP	TBN-930701	N/A	Jul. 19, 2013	Jun. 05, 2014~ Jun. 06, 2014	Jul. 18, 2014	Conducted (TH02-HY)
LTE Base Station	Anritsu	MT8820C	6201026480	30MHz~2.7GHz SISO	Jan. 07, 2014	Jun. 05, 2014~ Jun. 06, 2014	Jan. 06, 2015	Conducted (TH02-HY)
Spectrum Analyzer	Rohde & Schwarz	FSV30	101749	10Hz ~ 30GHz	Feb. 10, 2014	May 19, 2014	Feb. 09, 2015	Radiation (03CH07-HY)
Bilog Antenna	Schaffner	CBL6111C	2726	30MHz ~ 1GHz	Oct. 10, 2013	May 19, 2014	Oct. 09, 2014	Radiation (03CH07-HY)
Double Ridge Horn Antenna	ESCO	3117	75962	1GHz~18GHz	Aug. 22, 2013	May 19, 2014	Aug. 21, 2014	Radiation (03CH07-HY)
Preamplifier	COM-POWER	PA-103A	161241	10 MHz ~ 1000MHz	Mar. 17, 2014	May 19, 2014	Mar. 16, 2015	Radiation (03CH07-HY)
Preamplifier	Agilent	8449B	3008A02362	1 GHz~26.5 GHz	Nov. 29, 2013	May 19, 2014	Nov. 28, 2014	Radiation (03CH07-HY)
Turn Table	ChainTek	ChainTek 3000	N/A	0 ~ 360 degree	N/A	May 19, 2014	N/A	Radiation (03CH07-HY)
Antenna Mast	ChainTek	M-400-0	114/8000604	N/A	N/A	May 19, 2014	N/A	Radiation (03CH07-HY)
SHF-EHF Horn Antenna	SCHWARZBECK	BBHA 9170	BBHA91702 51	15GHz- 40GHz	Oct. 03, 2013	May 19, 2014	Oct. 02, 2014	Radiation (03CH07-HY)



5 Uncertainty of Evaluation

Uncertainty of Radiated Emission Measurement (30 MHz ~ 1000 MHz)

Measuring Uncertainty for a Level of Confidence of 95% ($U = 2Uc(y)$)	4.50
---	------