

# FCC RF Test Report

APPLICANT : Green Packet Berhad, Taiwan  
EQUIPMENT : Portable WiMAX WiFi Router  
BRAND NAME : Green Packet  
MODEL NAME : MF-250  
FCC ID : W9V-MF250-GP  
STANDARD : 47 CFR Part 2, 27(M)  
CLASSIFICATION : Licensed Non-Broadcast Station Transmitter (TNB)  
TX FREQUENCY RANGE : 2496 MHz ~ 2690 MHz  
Rx FREQUENCY RANGE : 2496 MHz ~ 2690 MHz  
MAX. EIRP POWER : 0.23 W (QPSK, BW 5MHz)  
0.23 W (QPSK, BW 10MHz)  
0.24 W (16QAM, BW 5MHz)  
0.22 W (16QAM, BW 10MHz)  
EMISSION DESIGNATOR : 4M45G7D (QPSK, BW 5MHz)  
9M13G7D (QPSK, BW 10MHz)  
4M47W7D (16QAM, BW 5MHz)  
9M13W7D (16QAM, BW 10MHz)

The product was received on Oct. 06, 2010 and completely tested on Nov. 25, 2010. We, SPORTON INTERNATIONAL INC., would like to declare that the tested sample has been evaluated in accordance with the procedures given in ANSI C63.4-2003 and 47 CFR FCC Part 27 Subpart M and shown compliance with the applicable technical standards.

The test results in this report apply exclusively to the tested model / sample. Without written approval of SPORTON INTERNATIONAL INC., the test report shall not be reproduced except in full.

Reviewed by:



Anderson Chiu / Deputy Manager



## SPORTON INTERNATIONAL INC.

No. 52, Hwa Ya 1<sup>st</sup> Rd., Hwa Ya Technology Park, Kwei-Shan Hsiang, Tao Yuan Hsien, Taiwan, R.O.C.

SPORTON INTERNATIONAL INC.

TEL : 886-3-327-3456

FAX : 886-3-328-4978

FCC ID : W9V-MF250-GP

Page Number : 1 of 51

Report Issued Date : Feb. 01, 2011

Report Version : Rev. 01



# TABLE OF CONTENTS

**REVISION HISTORY..... 3**

**SUMMARY OF TEST RESULT ..... 4**

**1 GENERAL DESCRIPTION ..... 5**

    1.1 Applicant ..... 5

    1.2 Manufacturer ..... 5

    1.3 Feature of Equipment Under Test ..... 6

    1.4 Testing Site ..... 7

    1.5 Applied Standards ..... 7

    1.6 Ancillary Equipment List ..... 7

**2 TEST CONFIGURATION OF EQUIPMENT UNDER TEST ..... 8**

    2.1 Test Mode ..... 8

    2.2 Connection Diagram of Test System ..... 9

**3 TEST RESULT ..... 10**

    3.1 Maximum Output Power, Band Edge, and Effective Isotropic Radiated Power Measurement ..... 10

    3.2 Emission Bandwidth ..... 19

    3.3 Conducted Spurious Emission Measurement ..... 24

    3.4 Radiated Emissions Measurement ..... 37

    3.5 Frequency Stability Measurement ..... 47

**4 LIST OF MEASURING EQUIPMENTS..... 50**

**5 UNCERTAINTY OF EVALUATION ..... 51**

**APPENDIX A. PHOTOGRAPHS OF EUT**

**APPENDIX B. SETUP PHOTOGRAPHS**



### REVISION HISTORY

REPORT NO.	VERSION	DESCRIPTION	ISSUED DATE
FW000616	Rev. 01	Initial issue of report	Feb. 01, 2011



### SUMMARY OF TEST RESULT

Report Section	FCC Rule	Description	Limit	Result	Remark
3.1	§2.1033 §2.1046 §27.50	Maximum Output Power	< 2 Watts	PASS	-
3.1	§2.1033 §2.1046 §27.50	Band Edge Emissions	< 5.5MHz: -13 dBm ≥5.5MHz: -25 dBm	PASS	-
3.1	§27.50	Equivalent Isotropic Radiated Power	< 2 Watts	PASS	-
3.2	§2.1049 §27.53	Emissions Bandwidth	N/A	PASS	-
3.3	§2.1051 §27.53	Conducted Spurious Emissions	< 55+10log <sub>10</sub> (P[Watts])	PASS	-
3.4	§2.1053 §27.53	Field Strength of Spurious Radiation	< 55+10log <sub>10</sub> (P[Watts])	PASS	Under limit 9.35 dB at 7779.00 MHz
3.5	§2.1055 §27.54	Frequency Stability for Temperature & Voltage	2.5 ppm	PASS	-



# **1 General Description**

## **1.1 Applicant**

**Green Packet Berhad, Taiwan**

6F., No. 21, Lane 583, Rueiguang Rd., Neihu District, Taipei City, Taiwan (R.O.C.)

## **1.2 Manufacturer**

**Green Packet Berhad, Taiwan**

1. 6F., No. 21, Lane 583, Rueiguang Rd., Neihu District, Taipei City, Taiwan (R.O.C.)
2. Suite 21213, No. 498, Guoshoujing Rd., Pudong New Area, Shanghai, 201203, China

### 1.3 Feature of Equipment Under Test

Product Feature & Specification	
Equipment	Portable WiMAX WiFi Router
Brand Name	Green Packet
Model Name	MF-250
FCC ID	W9V-MF250-GP
Tx Frequency	2496 MHz ~ 2690 MHz
Rx Frequency	2496 MHz ~ 2690 MHz
Channel Bandwidth	5MHz / 10MHz
Maximum Output Power to Antenna	<b>Main Antenna :</b> 23.73 dBm (QPSK, BW 5MHz) 23.64 dBm (QPSK, BW 10MHz) 23.67 dBm (16QAM, BW 5MHz) 23.59 dBm (16QAM, BW 10MHz) <b>Aux. Antenna :</b> 23.84 dBm (QPSK, BW 5MHz) 23.76 dBm (QPSK, BW 10MHz) 23.82 dBm (16QAM, BW 5MHz) 23.74 dBm (16QAM, BW 10MHz)
Maximum EIRP	0.23 W (23.58 dBm) (QPSK, BW 5MHz) 0.23 W (23.54 dBm) (QPSK, BW 10MHz) 0.24 W (23.76 dBm) (16QAM, BW 5MHz) 0.22 W (23.47 dBm) (16QAM, BW 10MHz)
Antenna Type	Monopole Antenna
Type of Modulation	Uplink : OFDMA (QPSK / 16QAM)
Type of Emission	4M45G7D (QPSK, BW 5MHz) 9M13G7D (QPSK, BW 10MHz) 4M47W7D (16QAM, BW 5MHz) 9M13W7D (16QAM, BW 10MHz)
EUT Stage	Production Unit

**Remark:**

1. For other wireless features of this EUT, the test report will be issued separately.
2. This test report recorded only product characteristics and test results of Licensed Non-Broadcast Station Transmitter (TNB).
3. The above EUT's information was declared by manufacturer. Please refer to the specifications or user's manual for more detailed description.

## 1.4 Testing Site

<b>Test Site</b>	SPORTON INTERNATIONAL INC.		
<b>Test Site Location</b>	No. 52, Hwa Ya 1 <sup>st</sup> Rd., Hwa Ya Technology Park, Kwei-Shan Hsiang, Tao Yuan Hsien, Taiwan, R.O.C. TEL: +886-3-327-3456 FAX: +886-3-328-4978		
<b>Test Site No.</b>	<b>Sporton Site No.</b>		<b>FCC / IC Registration No.</b>
	TH02-HY	03CH07-HY	722060/4086B-1

## 1.5 Applied Standards

According to the specifications of the manufacturer, the EUT must comply with the requirements of the following standards:

- 47 CFR Part 2, 27(M)
- ANSI C63.4-2003
- ANSI TIA-603-C-2004

**Remark:**

1. All test items were verified and recorded according to the standards and without any deviation during the test.
2. This EUT has also been tested and complied with the requirements of FCC Part 15, Subpart B (DoC), recorded in a separate test report.

## 1.6 Ancillary Equipment List

Item	Equipment	Trade Name	Model No.	FCC ID	Data Cable	Power Cord
1.	Notebook	DELL	Vostro 1510	FCC DoC	N/A	AC I/P: Unshielded, 1.2 m DC O/P: Shielded, 1.8 m

## 2 Test Configuration of Equipment Under Test

### 2.1 Test Mode

Preliminary tests were performed in different data rate to find the worst radiated emission. The data rate shown in the table below is the worst-case rate with respect to the specific test item. Investigation has been done on all the possible configurations for searching the worst cases. The following table is a list of the test modes shown in this test report. The spurious emission measurements were carried out in semi-anechoic chamber with 3-meter test range.

Test Modes		
Band	Radiated TCs	Conducted TCs
802.16e (Modulation : OFDMA)	<ul style="list-style-type: none"> <li>■ QPSK, BW 5MHz Link</li> <li>■ QPSK, BW 10MHz Link</li> <li>■ 16QAM, BW 5MHz Link</li> <li>■ 16QAM, BW 10MHz Link</li> </ul>	<ul style="list-style-type: none"> <li>■ QPSK, BW 5MHz Link</li> <li>■ QPSK, BW 10MHz Link</li> <li>■ 16QAM, BW 5MHz Link</li> <li>■ 16QAM, BW 10MHz Link</li> </ul>

**Note:** The maximum average power levels are on zone type, PUSC and coding rate, 1/2 mode for QPSK, BW 5MHz, QPSK, BW 10MHz, 16QAM, BW 5MHz, and 16QAM, BW 10MHz Link ; only these modes were used for all tests.

The conducted power tables are as follows:

Zone Type	Modulation	Coding Rate	Channel	Main Antenna			Aux. Antenna		
				Peak Power	Average Power	PAR	Peak Power	Average Power	PAR
PUSC	QPSK (BW 5MHz)	1/2	Low	31.37	23.37	8.00	31.27	23.46	7.81
			Middle	31.11	23.73	7.38	31.26	23.84	7.42
			High	30.30	22.93	7.37	30.59	23.03	7.56
		3/4	Low	31.40	23.57	7.83	31.22	23.58	7.64
			Middle	31.11	23.69	7.42	31.22	23.83	7.39
			High	30.28	23.07	7.21	30.55	23.05	7.50
	16QAM (BW 5MHz)	1/2	Low	31.35	23.55	7.80	31.08	23.53	7.55
			Middle	31.05	23.67	7.38	31.19	23.82	7.37
			High	30.23	23.05	7.18	30.51	23.06	7.45
		3/4	Low	31.19	23.42	7.77	31.06	23.57	7.49
			Middle	31.10	23.65	7.45	31.13	23.80	7.33
			High	30.17	23.10	7.07	30.50	23.11	7.39
	QPSK (BW 10MHz)	1/2	Low	31.08	23.38	7.70	30.99	23.45	7.54
			Middle	31.01	23.63	7.38	31.11	23.76	7.35
			High	30.25	23.64	6.61	30.44	23.05	7.39
		3/4	Low	31.12	23.42	7.70	31.04	23.48	7.56
			Middle	30.95	23.59	7.36	31.11	23.75	7.36
			High	30.27	23.61	6.66	30.43	23.03	7.40
	16QAM (BW 10MHz)	1/2	Low	31.16	23.44	7.72	30.87	23.39	7.48
			Middle	30.90	23.58	7.32	31.07	23.74	7.33
			High	30.25	23.59	6.66	30.43	23.06	7.37
		3/4	Low	31.30	23.49	7.81	31.14	23.55	7.59
			Middle	31.06	23.55	7.51	31.21	23.72	7.49
			High	30.30	23.59	6.71	30.55	23.10	7.45

**Note:** PAR = Peak to Average Ratio



## 2.2 Connection Diagram of Test System

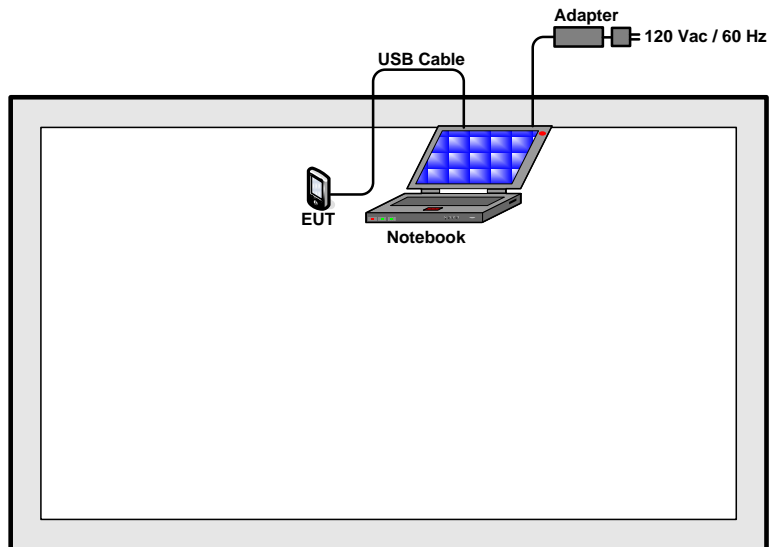

### 3 Test Result

#### 3.1 Maximum Output Power, Band Edge, and Effective Isotropic Radiated Power Measurement

##### 3.1.1 Limit

For mobile and other user stations, mobile stations are limited to 2.0 watts EIRP and all user stations are limited to 2.0 watts transmitter output power. The power of any emission outside of the authorized operating frequency ranges must be attenuated below the transmitting power ( $p$ ) by a factor of mobile digital stations, the attenuation factor shall be not less than  $43 + 10 \log (p)$  dB at the channel edge and  $55 + 10 \log (p)$  dB at 5.5 MHz from the channel edges.

##### 3.1.2 Measuring Instruments

See list of measuring instruments of this test report.

##### 3.1.3 Test Procedures

###### For Conducted Power and Band Edge Measurement:

The RF output of the transmitter was connected to the input of the spectrum analyzer through sufficient attenuation.

###### For Effective Isotropic Radiated Power Measurement:

1. The EUT was placed on an non-conductive rotating platform with 0.8 meter height in a semi-anechoic chamber. The radiated emission at the fundamental frequency was measured at 3 m.
2. During the measurement, the EUT was enforced in maximum power. The highest emission was recorded from analyzer power level (LVL) from the 360 degrees rotation of the turntable and the test antenna raised and lowered over a range from 1 to 4 meters in both horizontally and vertically polarized orientations.
3. Effective Isotropic Radiated Power (EIRP) was measured by substitution method according to TIA/EIA-603-C. The EUT was replaced by dipole antenna (substitution antenna) at same location, and then a known power from S.G. was applied into the dipole antenna through a Tx cable, and then recorded the maximum Analyzer reading through raised and lowered the test antenna. The correction factor (in dB) = S.G. - Tx Cable loss + Substitution antenna gain - Analyzer reading. Then the EUT's EIRP was calculated with the correction factor,  $EIRP = LVL + \text{Correction factor}$ .

### 3.1.4 Test Setup

<Conducted Power and Band Edge Measurement>

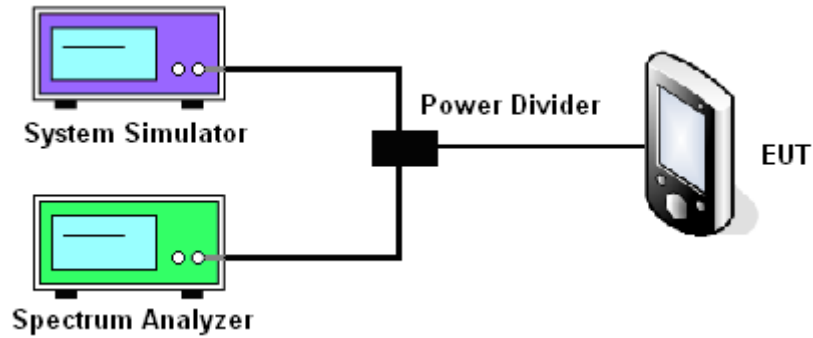

<Effective Isotropic Radiated Power Measurement>

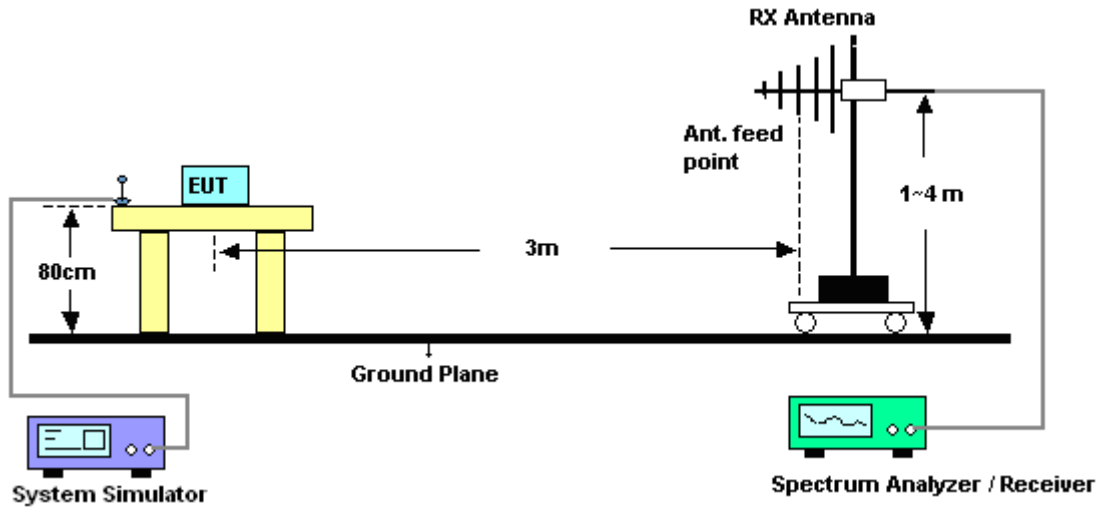



3.1.5 Test Result of Maximum Output Power

Channel	Modulation Type	Zone Type	Coding Rate	5MHz Bandwidth			10MHz Bandwidth		
				Peak Power	Average Power	PAR	Peak Power	Average Power	PAR
Low	QPSK	BAMC	1/2	31.37	23.37	8.00	31.08	23.38	7.70
Middle	QPSK	BAMC	1/2	31.11	23.73	7.38	31.01	23.63	7.38
High	QPSK	BAMC	1/2	30.30	22.93	7.37	30.25	23.64	6.61

Note: PAR = Peak to Average Ratio

Channel	Modulation Type	Zone Type	Coding Rate	5MHz Bandwidth			10MHz Bandwidth		
				Peak Power	Average Power	PAR	Peak Power	Average Power	PAR
Low	16QAM	BAMC	1/2	31.35	23.55	7.80	31.16	23.44	7.72
Middle	16QAM	BAMC	1/2	31.05	23.67	7.38	30.90	23.58	7.32
High	16QAM	BAMC	1/2	30.23	23.05	7.18	30.25	23.59	6.66

Note: PAR = Peak to Average Ratio



### 3.1.6 Test Result of Band Edge Measurement

<b>Band :</b>	802.16e	<b>Power Stage :</b>	High
<b>Test Mode :</b>	QPSK, BW 5MHz		

#### Band Edge Plot on Low Channel

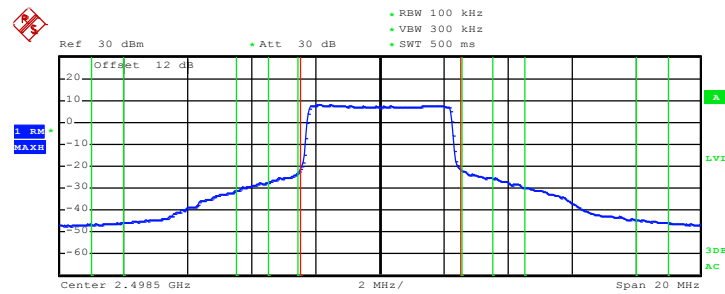

<b>Tx Channel</b>	Bandwidth	5 MHz	<b>USER (PART27-5)</b>	Power	23.52 dBm
<b>Adjacent Channel</b>	Bandwidth	50 kHz	Lower	-25.51 dBm	
	Spacing	2.525 MHz	Upper	-25.20 dBm	
<b>Alternate Channel</b>	Bandwidth	1 MHz	Lower	-19.21 dBm	
	Spacing	4 MHz	Upper	-17.62 dBm	
<b>2nd Alternate Channel</b>	Bandwidth	1 MHz	Lower	-36.63 dBm	
	Spacing	8.5 MHz	Upper	-35.54 dBm	

Bandedge limit: -13dBm

Bandedge limit: -13dBm

Bandedge limit: -25dBm

Date: 20.NOV.2010 13:44:57

#### Band Edge Plot on High Channel

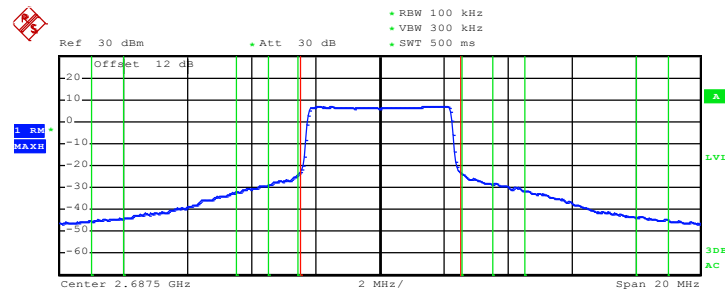

<b>Tx Channel</b>	Bandwidth	5 MHz	<b>USER (PART27-5)</b>	Power	22.68 dBm
<b>Adjacent Channel</b>	Bandwidth	50 kHz	Lower	-26.99 dBm	
	Spacing	2.525 MHz	Upper	-26.81 dBm	
<b>Alternate Channel</b>	Bandwidth	1 MHz	Lower	-20.81 dBm	
	Spacing	4 MHz	Upper	-19.97 dBm	
<b>2nd Alternate Channel</b>	Bandwidth	1 MHz	Lower	-35.10 dBm	
	Spacing	8.5 MHz	Upper	-34.69 dBm	

Bandedge limit: -13dBm

Bandedge limit: -13dBm

Bandedge limit: -25dBm

Date: 20.NOV.2010 13:59:17



<b>Band :</b>	802.16e	<b>Power Stage :</b>	High
<b>Test Mode :</b>	QPSK, BW 10MHz		

**Edge Plot on Low Channel**

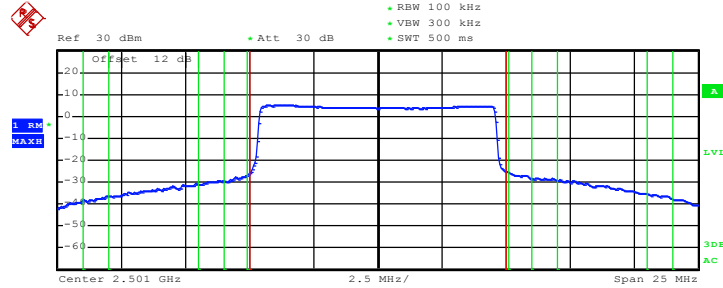

<b>Tx Channel</b>	Bandwidth 10 MHz	<b>USER (PART27-10)</b>	Power 23.64 dBm	
<b>Adjacent Channel</b>	Bandwidth 100 kHz	Lower	-26.68 dBm	Bandedge limit: -13dBm
	Spacing 5.05 MHz	Upper	-25.93 dBm	
<b>Alternate Channel</b>	Bandwidth 1 MHz	Lower	-20.40 dBm	Bandedge limit: -13dBm
	Spacing 6.5 MHz	Upper	-18.98 dBm	
<b>2nd Alternate Channel</b>	Bandwidth 1 MHz	Lower	-28.07 dBm	Bandedge limit: -25dBm
	Spacing 11 MHz	Upper	-26.65 dBm	

Date: 20.NOV.2010 14:07:23

**Band Edge Plot on High Channel**

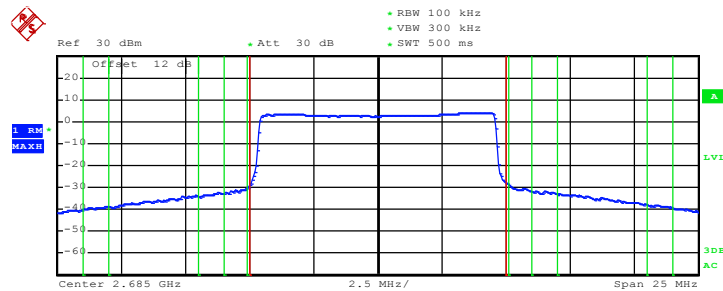

<b>Tx Channel</b>	Bandwidth 10 MHz	<b>USER (PART27-10)</b>	Power 22.45 dBm	
<b>Adjacent Channel</b>	Bandwidth 100 kHz	Lower	-30.03 dBm	Bandedge limit: -13dBm
	Spacing 5.05 MHz	Upper	-28.65 dBm	
<b>Alternate Channel</b>	Bandwidth 1 MHz	Lower	-23.49 dBm	Bandedge limit: -13dBm
	Spacing 6.5 MHz	Upper	-22.58 dBm	
<b>2nd Alternate Channel</b>	Bandwidth 1 MHz	Lower	-29.70 dBm	Bandedge limit: -25dBm
	Spacing 11 MHz	Upper	-28.92 dBm	

Date: 20.NOV.2010 14:03:43



<b>Band :</b>	802.16e	<b>Power Stage :</b>	High
<b>Test Mode :</b>	16QAM, BW 5MHz		

**Band Edge Plot on Low Channel**

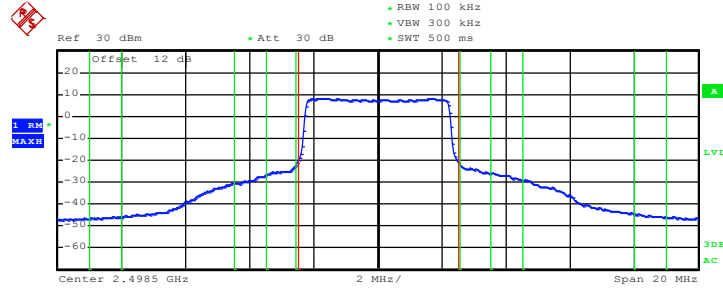

<b>Tx Channel</b>	Bandwidth 5 MHz	<b>USER (PART27-5)</b>	Power 23.67 dBm
<b>Adjacent Channel</b>	Bandwidth 50 kHz	Lower	-24.60 dBm
	Spacing 2.525 MHz	Upper	-24.52 dBm
<b>Alternate Channel</b>	Bandwidth 1 MHz	Lower	-19.27 dBm
	Spacing 4 MHz	Upper	-17.60 dBm
<b>2nd Alternate Channel</b>	Bandwidth 1 MHz	Lower	-36.61 dBm
	Spacing 8.5 MHz	Upper	-35.74 dBm

Bandedge limit: -13dBm  
 Bandedge limit: -13dBm  
 Bandedge limit: -25dBm

Date: 20.NOV.2010 13:47:19

**Band Edge Plot on High Channel**

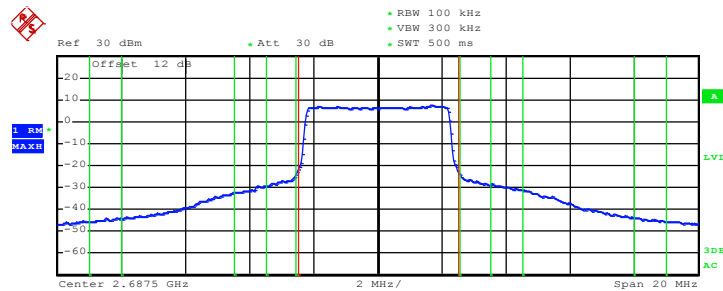

<b>Tx Channel</b>	Bandwidth 5 MHz	<b>USER (PART27-5)</b>	Power 22.63 dBm
<b>Adjacent Channel</b>	Bandwidth 50 kHz	Lower	-26.57 dBm
	Spacing 2.525 MHz	Upper	-26.20 dBm
<b>Alternate Channel</b>	Bandwidth 1 MHz	Lower	-21.26 dBm
	Spacing 4 MHz	Upper	-20.24 dBm
<b>2nd Alternate Channel</b>	Bandwidth 1 MHz	Lower	-35.20 dBm
	Spacing 8.5 MHz	Upper	-35.11 dBm

Bandedge limit: -13dBm  
 Bandedge limit: -13dBm  
 Bandedge limit: -25dBm

Date: 20.NOV.2010 13:58:38



<b>Band :</b>	802.16e	<b>Power Stage :</b>	High
<b>Test Mode :</b>	16QAM, BW 10MHz		

**Band Edge Plot on Low Channel**

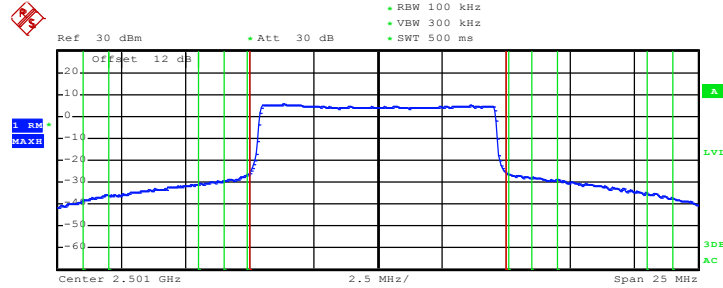

<b>Tx Channel</b>	Bandwidth 10 MHz	<b>USER (PART27-10)</b>	Power 23.79 dBm	
<b>Adjacent Channel</b>	Bandwidth 100 kHz	Lower	-26.50 dBm	Bandedge limit: -13dBm
	Spacing 5.05 MHz	Upper	-26.58 dBm	
<b>Alternate Channel</b>	Bandwidth 1 MHz	Lower	-20.43 dBm	Bandedge limit: -13dBm
	Spacing 6.5 MHz	Upper	-18.95 dBm	
<b>2nd Alternate Channel</b>	Bandwidth 1 MHz	Lower	-27.40 dBm	Bandedge limit: -25dBm
	Spacing 11 MHz	Upper	-26.46 dBm	

Date: 20.NOV.2010 14:08:37

**Band Edge Plot on High Channel**

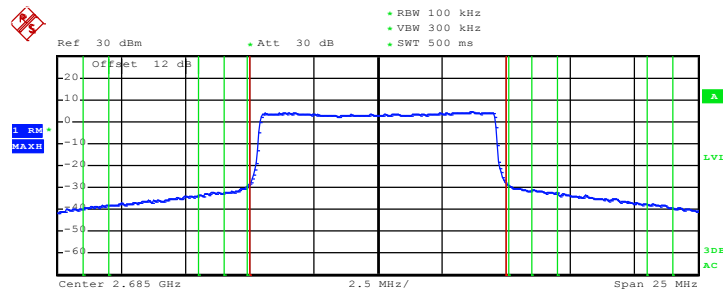

<b>Tx Channel</b>	Bandwidth 10 MHz	<b>USER (PART27-10)</b>	Power 22.71 dBm	
<b>Adjacent Channel</b>	Bandwidth 100 kHz	Lower	-29.17 dBm	Bandedge limit: -13dBm
	Spacing 5.05 MHz	Upper	-29.16 dBm	
<b>Alternate Channel</b>	Bandwidth 1 MHz	Lower	-23.20 dBm	Bandedge limit: -13dBm
	Spacing 6.5 MHz	Upper	-22.37 dBm	
<b>2nd Alternate Channel</b>	Bandwidth 1 MHz	Lower	-29.11 dBm	Bandedge limit: -25dBm
	Spacing 11 MHz	Upper	-28.67 dBm	

Date: 20.NOV.2010 14:04:30



3.1.7 Test Result of Effective Isotropic Radiated Power

802.16e (QPSK, BW 5MHz) Radiated Power (EIRP)				
Horizontal Polarization				
Channel	LVL (dBm)	Correction Factor (dB)	EIRP (dBm)	EIRP (W)
Low	-20.76	43.85	23.09	0.20
Middle	-21.65	44.06	22.41	0.17
High	-20.68	44.26	23.58	0.23
Vertical Polarization				
Channel	LVL (dBm)	Correction Factor (dB)	EIRP (dBm)	EIRP (W)
Low	-26.04	45.55	19.51	0.09
Middle	-27.97	46.72	18.75	0.07
High	-27.34	45.48	18.14	0.07

802.16e (QPSK, BW 10MHz) Radiated Power (EIRP)				
Horizontal Polarization				
Channel	LVL (dBm)	Correction Factor (dB)	EIRP (dBm)	EIRP (W)
Low	-20.31	43.85	23.54	0.23
Middle	-21.56	44.06	22.50	0.18
High	-21.35	44.26	22.91	0.20
Vertical Polarization				
Channel	LVL (dBm)	Correction Factor (dB)	EIRP (dBm)	EIRP (W)
Low	-26.23	45.55	19.32	0.09
Middle	-27.77	46.72	18.95	0.08
High	-28.09	45.48	17.39	0.05



802.16e (16QAM, BW 5MHz) Radiated Power (EIRP)				
Horizontal Polarization				
Channel	LVL (dBm)	Correction Factor (dB)	EIRP (dBm)	EIRP (W)
Low	-20.72	43.85	23.13	0.21
Middle	-21.58	44.06	22.48	0.18
High	-20.50	44.26	23.76	0.24
Vertical Polarization				
Channel	LVL (dBm)	Correction Factor (dB)	EIRP (dBm)	EIRP (W)
Low	-25.94	45.55	19.61	0.09
Middle	-27.71	46.72	19.01	0.08
High	-27.29	45.48	18.19	0.07

802.16e (16QAM, BW 10MHz) Radiated Power (EIRP)				
Horizontal Polarization				
Channel	LVL (dBm)	Correction Factor (dB)	EIRP (dBm)	EIRP (W)
Low	-20.38	43.85	23.47	0.22
Middle	-21.61	44.06	22.45	0.18
High	-21.28	44.26	22.98	0.20
Vertical Polarization				
Channel	LVL (dBm)	Correction Factor (dB)	EIRP (dBm)	EIRP (W)
Low	-26.20	45.55	19.35	0.09
Middle	-27.75	46.72	18.97	0.08
High	-28.02	45.48	17.46	0.06

## 3.2 Emission Bandwidth

### 3.2.1 Description of Emission Bandwidth Measurement

The emission bandwidth is defined as the width of the signal between two points, located at the 2 sides of the carrier frequency, outside of which all emissions are attenuated at least 26 dB below the transmitter power. The designated emission bandwidth using a resolution bandwidth of at least 1% of the emission bandwidth of the fundamental emission and a video bandwidth is more than resolution bandwidth.

### 3.2.2 Measuring Instruments

See list of measuring instruments of this test report.

### 3.2.3 Test Procedures

1. The EUT was connected to Spectrum Analyzer and System Simulator via power divider.
2. The 99% and 26 dB occupied bandwidth (BW) of the middle channel for the highest RF powers were measured.

### 3.2.4 Test Setup

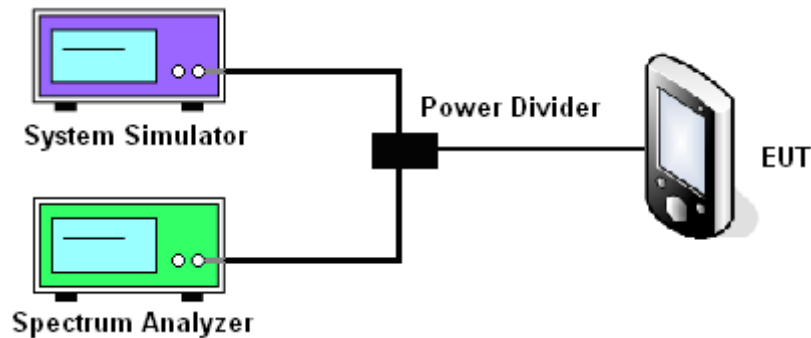

### 3.2.5 Test Result of Emission Bandwidth

<b>Band :</b>	802.16e	<b>Power Stage :</b>	High
<b>Test Mode :</b>	QPSK, BW 5MHz		

#### 99% Occupied Bandwidth Plot on Middle Channel

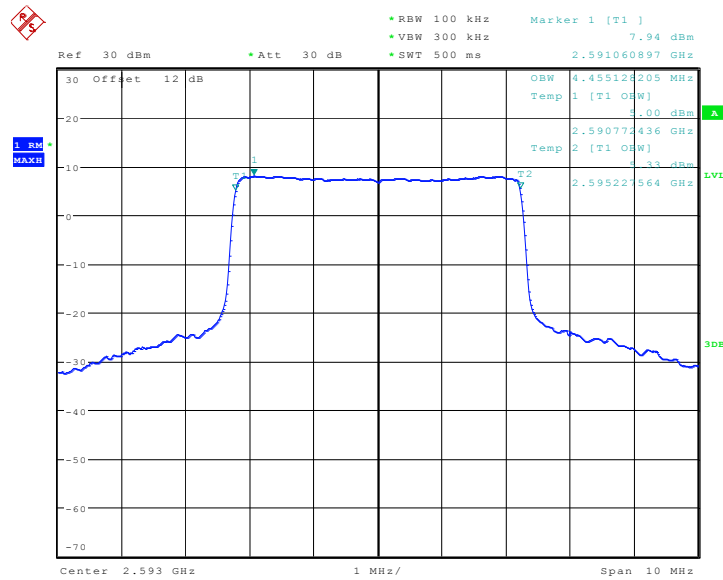

Date: 23.NOV.2010 17:57:16

#### 26dB Bandwidth Plot on Middle Channel

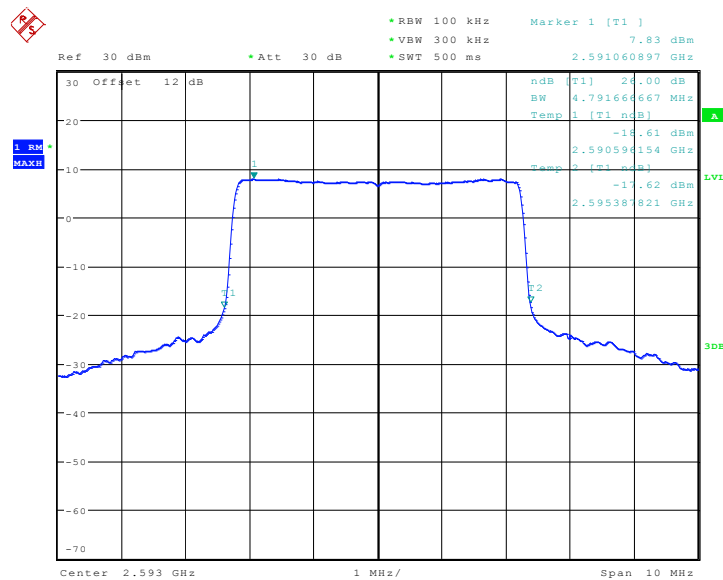

Date: 23.NOV.2010 17:58:04



<b>Band :</b>	802.16e	<b>Power Stage :</b>	High
<b>Test Mode :</b>	QPSK, BW 10MHz		

**99% Occupied Bandwidth Plot on Middle Channel**

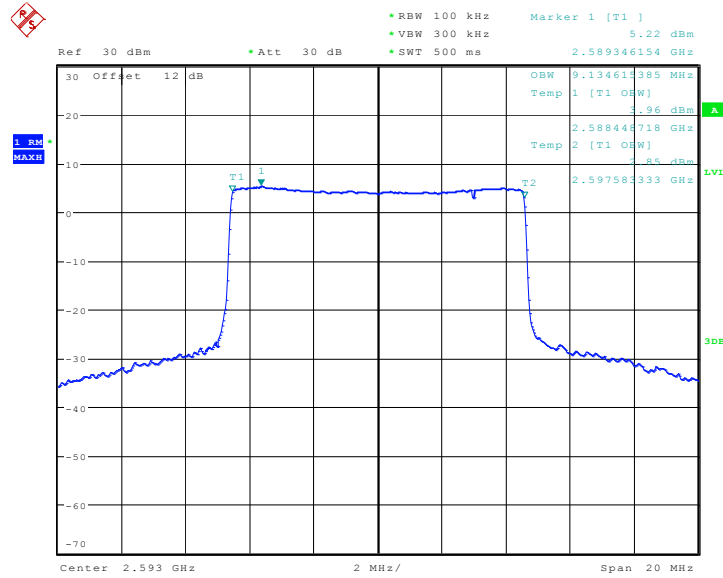

Date: 23.NOV.2010 17:50:42

**26dB Bandwidth Plot on Middle Channel**

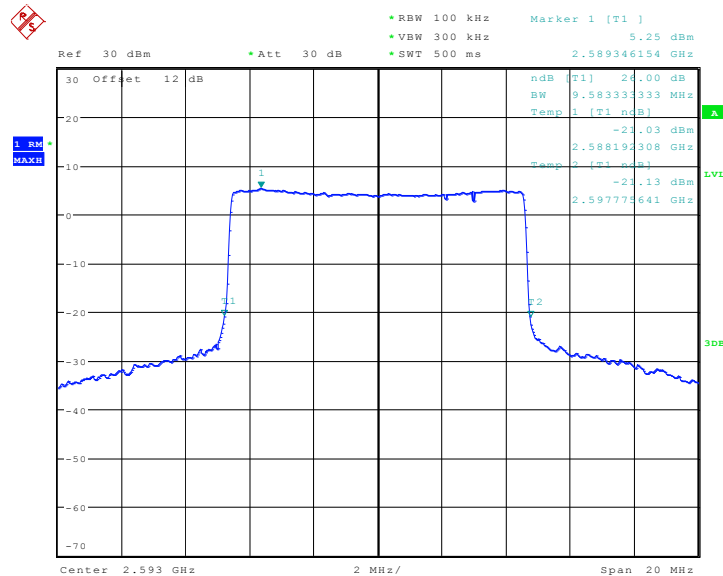

Date: 23.NOV.2010 18:01:10



<b>Band :</b>	802.16e	<b>Power Stage :</b>	High
<b>Test Mode :</b>	16QAM, BW 5MHz		

**99% Occupied Bandwidth Plot on Middle Channel**

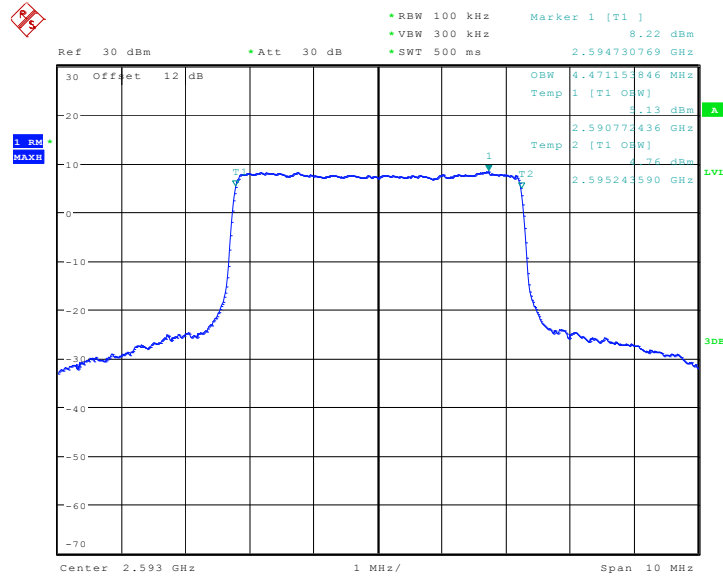

Date: 23.NOV.2010 17:53:11

**26dB Bandwidth Plot on Middle Channel**

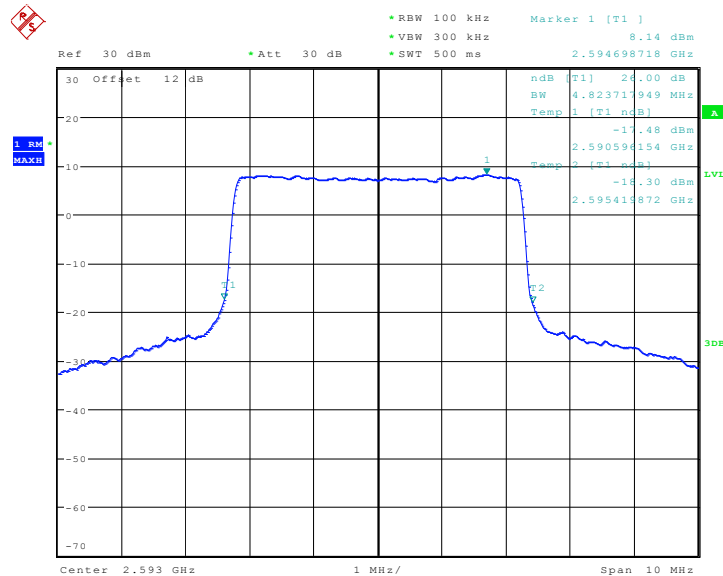

Date: 23.NOV.2010 17:58:52



<b>Band :</b>	802.16e	<b>Power Stage :</b>	High
<b>Test Mode :</b>	16QAM, BW 10MHz		

99% Occupied Bandwidth Plot on Middle Channel

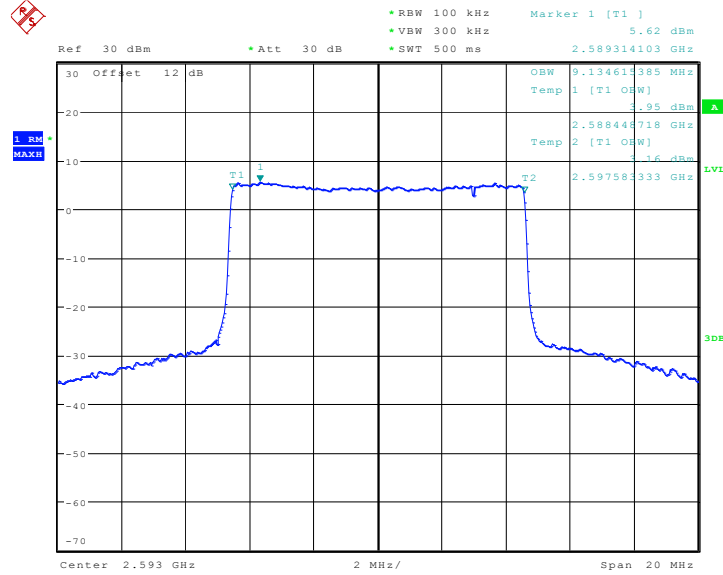

Date: 23.NOV.2010 17:52:30

26dB Bandwidth Plot on Middle Channel

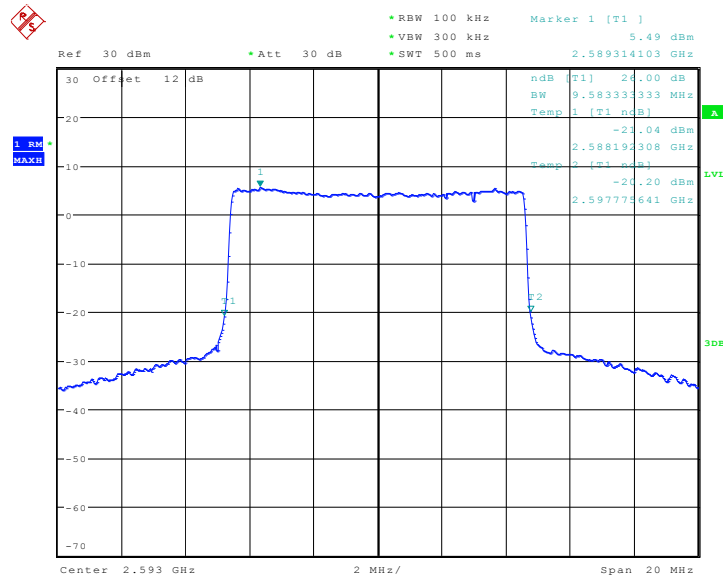

Date: 23.NOV.2010 18:00:24

### 3.3 Conducted Spurious Emission Measurement

#### 3.3.1 Description of Conducted Spurious Emission Measurement

The power of any emission outside of the authorized operating frequency ranges must be lower than the transmitter power (P) by a factor of mobile digital stations, the attenuation factor shall be not less than  $43 + 10 \log (P)$  dB at the channel edge and  $55 + 10 \log (P)$  dB at 5.5 MHz from the channel edges. It is measured by means of a calibrated spectrum analyzer and scanned from 30 MHz up to a frequency including its 10<sup>th</sup> harmonic.

#### 3.3.2 Measuring Instruments

See list of measuring instruments of this test report.

#### 3.3.3 Test Procedures

1. The EUT was connected to spectrum analyzer and System Simulator via power divider.
2. The conducted spurious emission for the whole frequency range was taken.

#### 3.3.4 Test Setup

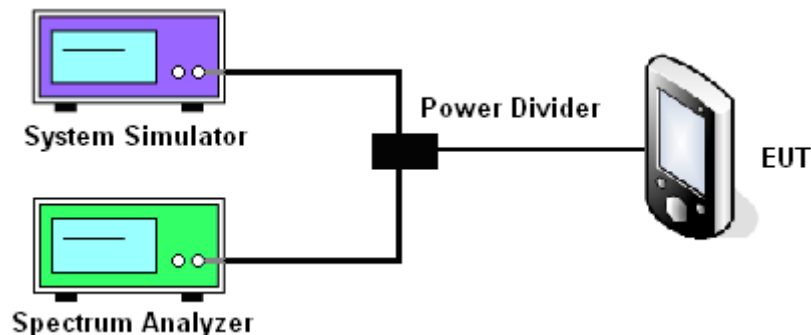





### 3.3.5 Test Plots of Spurious Emission

<b>Band :</b>	802.16e	<b>Power Stage :</b>	High
<b>Test Mode :</b>	QPSK, BW 5MHz	<b>Channel :</b>	Low

Conducted Spurious Emission Plot between 30MHz ~ 1GHz

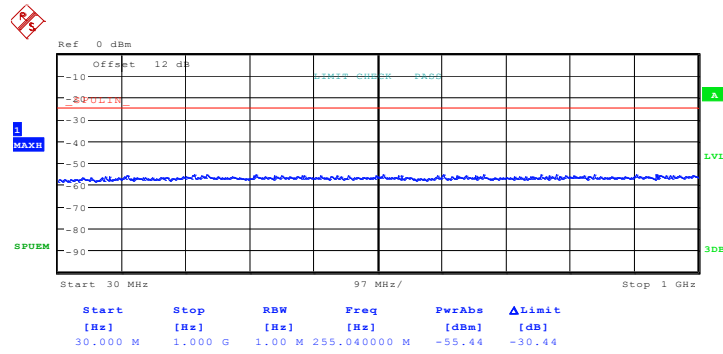

Date: 23.NOV.2010 18:25:04

Conducted Spurious Emission Plot between 1 GHz ~ 27GHz

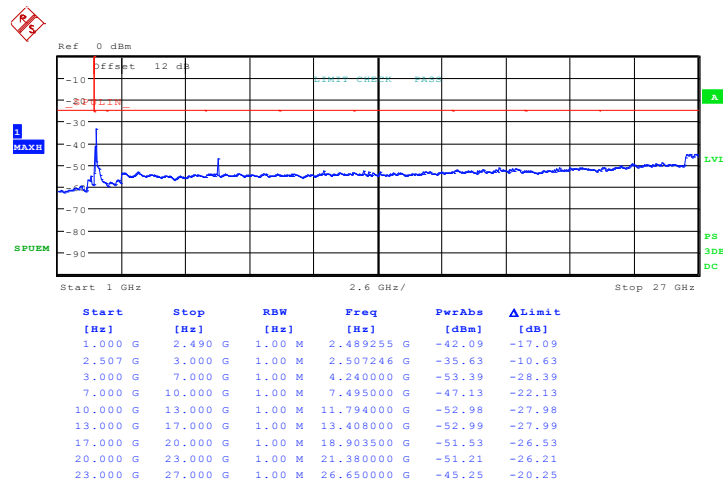

Date: 25.NOV.2010 03:57:30



<b>Band :</b>	802.16e	<b>Power Stage :</b>	High
<b>Test Mode :</b>	QPSK, BW 5MHz	<b>Channel :</b>	Middle

**Conducted Spurious Emission Plot between 30MHz ~ 1GHz**

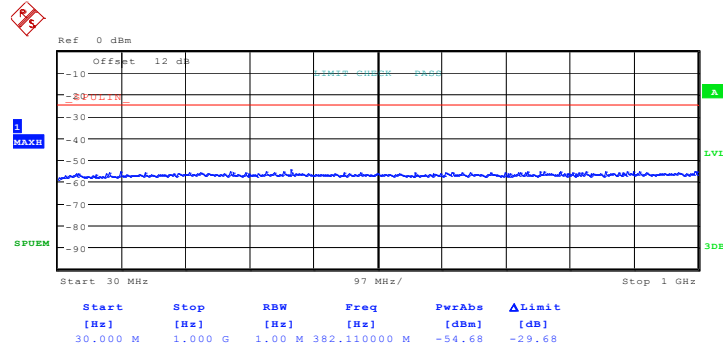

Date: 23.NOV.2010 18:24:01

**Conducted Spurious Emission Plot between 1 GHz ~ 27GHz**

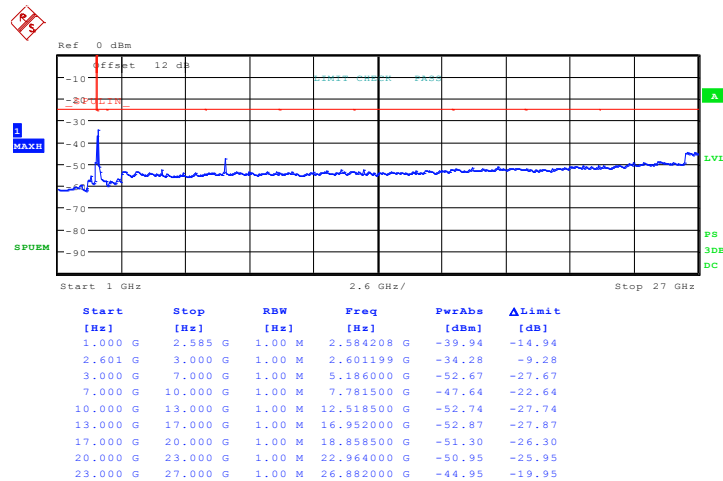

Date: 25.NOV.2010 04:07:47



<b>Band :</b>	802.16e	<b>Power Stage :</b>	High
<b>Test Mode :</b>	QPSK, BW 5MHz	<b>Channel :</b>	High

**Conducted Spurious Emission Plot between 30MHz ~ 1GHz**

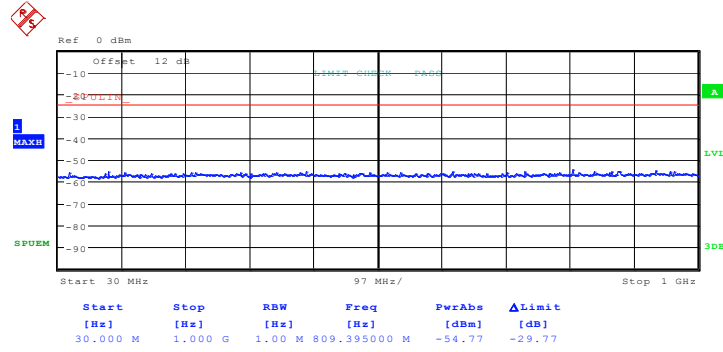

Date: 23.NOV.2010 18:23:22

**Conducted Spurious Emission Plot between 1 GHz ~ 27GHz**

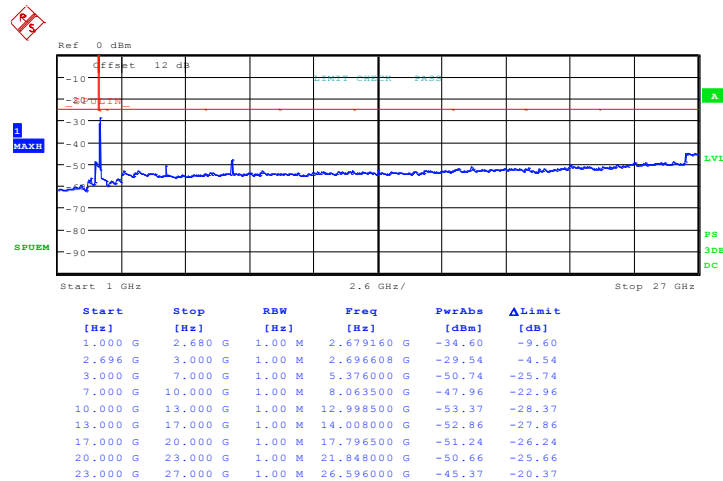

Date: 25.NOV.2010 03:44:04



<b>Band :</b>	802.16e	<b>Power Stage :</b>	High
<b>Test Mode :</b>	QPSK, BW 10MHz	<b>Channel :</b>	Low

**Conducted Spurious Emission Plot between 30MHz ~ 1GHz**

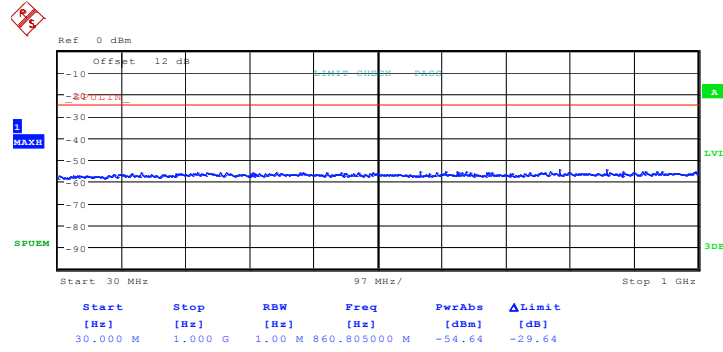

Date: 23.NOV.2010 18:21:07

**Conducted Spurious Emission Plot between 1 GHz ~ 27GHz**

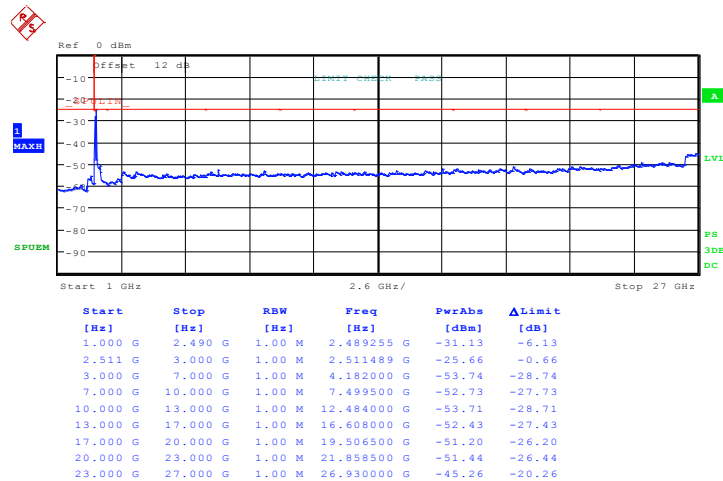

Date: 25.NOV.2010 03:28:03



<b>Band :</b>	802.16e	<b>Power Stage :</b>	High
<b>Test Mode :</b>	QPSK, BW 10MHz	<b>Channel :</b>	Middle

**Conducted Spurious Emission Plot between 30MHz ~ 1GHz**

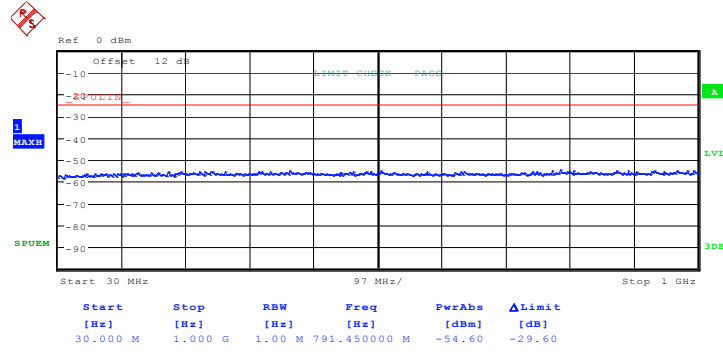

Date: 23.NOV.2010 18:19:35

**Conducted Spurious Emission Plot between 1 GHz ~ 27GHz**

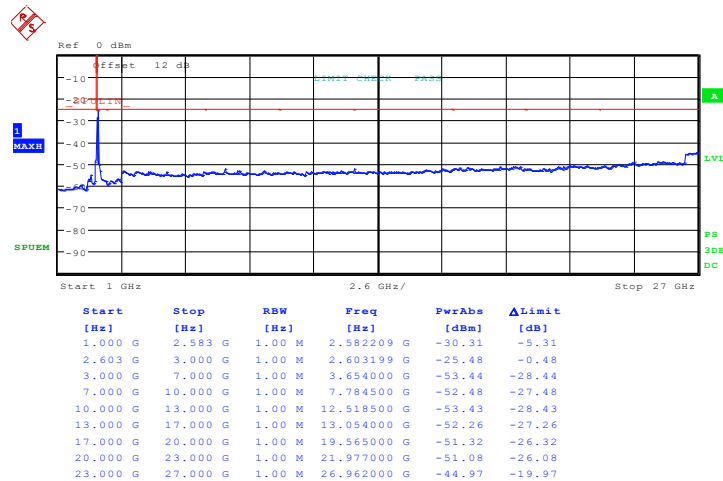

Date: 25.NOV.2010 03:34:39



<b>Band :</b>	802.16e	<b>Power Stage :</b>	High
<b>Test Mode :</b>	QPSK, BW 10MHz	<b>Channel :</b>	High

**Conducted Spurious Emission Plot between 30MHz ~ 1GHz**

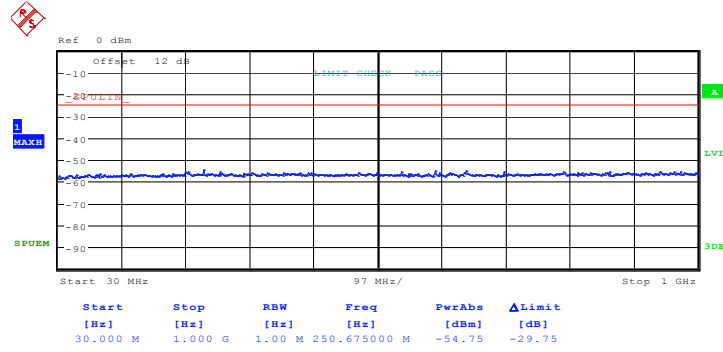

Date: 23.NOV.2010 18:21:48

**Conducted Spurious Emission Plot between 1 GHz ~ 27GHz**

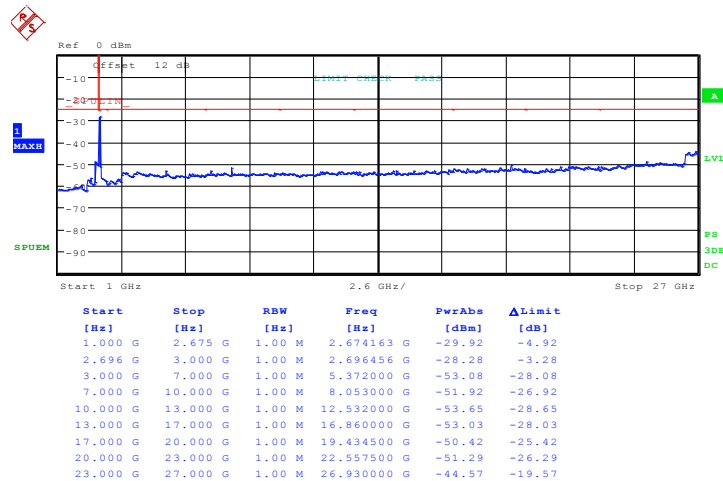

Date: 25.NOV.2010 04:04:10



<b>Band :</b>	802.16e	<b>Power Stage :</b>	High
<b>Test Mode :</b>	16QAM, BW 5MHz	<b>Channel :</b>	Low

**Conducted Spurious Emission Plot between 30MHz ~ 1GHz**

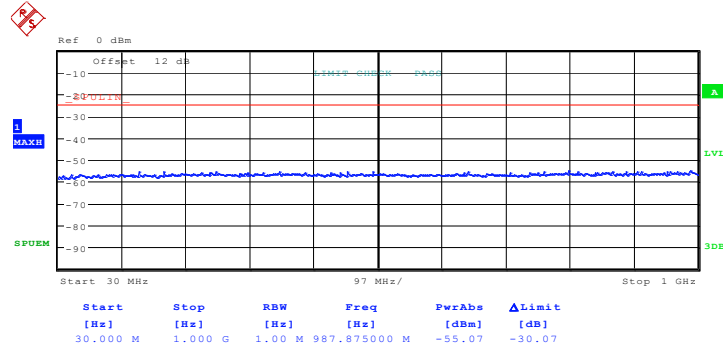

Date: 23.NOV.2010 18:24:45

**Conducted Spurious Emission Plot between 1 GHz ~ 27GHz**

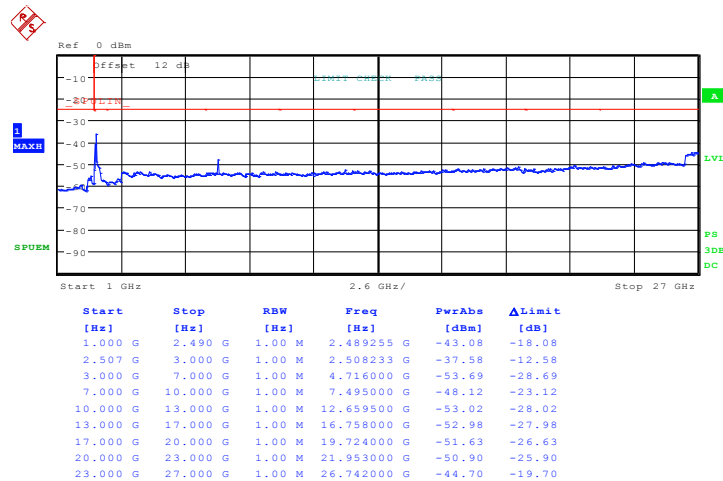

Date: 25.NOV.2010 03:55:13



<b>Band :</b>	802.16e	<b>Power Stage :</b>	High
<b>Test Mode :</b>	16QAM, BW 5MHz	<b>Channel :</b>	Middle

**Conducted Spurious Emission Plot between 30MHz ~ 1GHz**

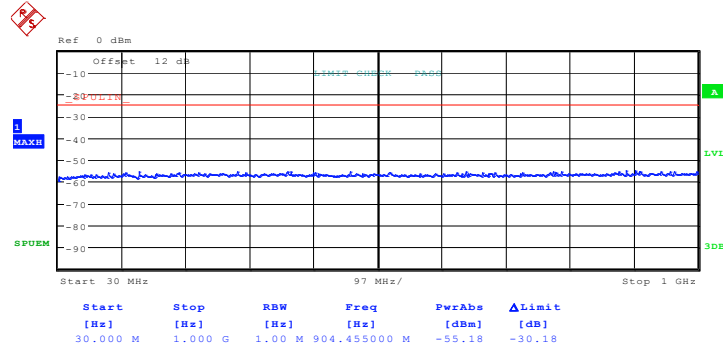

Date: 23.NOV.2010 18:24:20

**Conducted Spurious Emission Plot between 1 GHz ~ 27GHz**

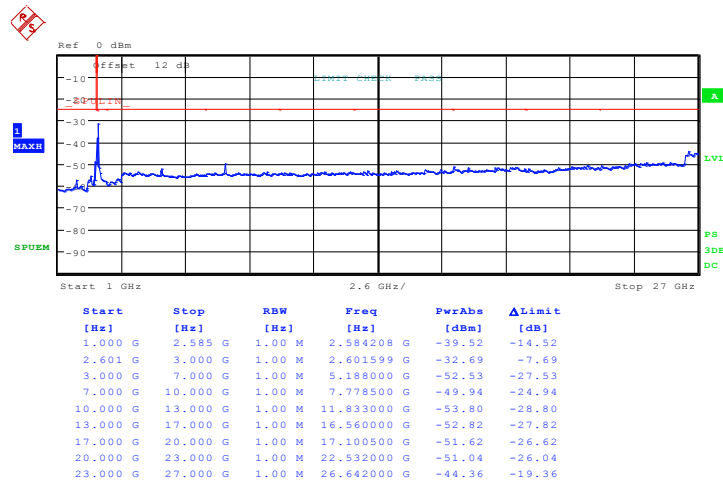

Date: 25.NOV.2010 03:49:20





<b>Band :</b>	802.16e	<b>Power Stage :</b>	High
<b>Test Mode :</b>	16QAM, BW 5MHz	<b>Channel :</b>	High

**Conducted Spurious Emission Plot between 30MHz ~ 1GHz**

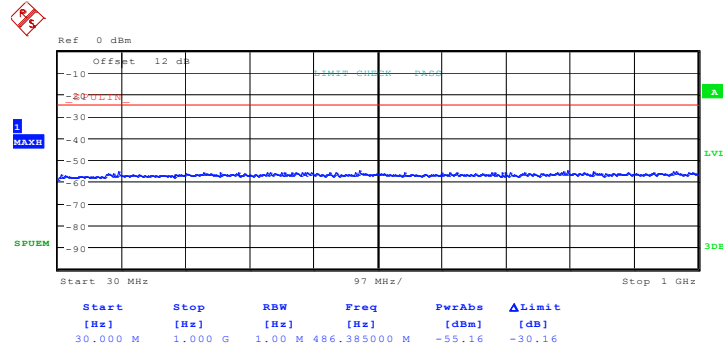

Date: 23.NOV.2010 18:22:44

**Conducted Spurious Emission Plot between 1 GHz ~ 27GHz**

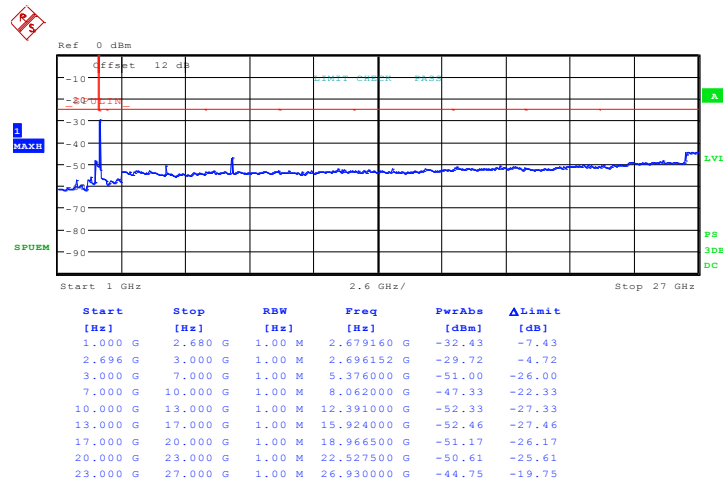

Date: 25.NOV.2010 03:43:08



<b>Band :</b>	802.16e	<b>Power Stage :</b>	High
<b>Test Mode :</b>	16QAM, BW 10MHz	<b>Channel :</b>	Low

**Conducted Spurious Emission Plot between 30MHz ~ 1GHz**

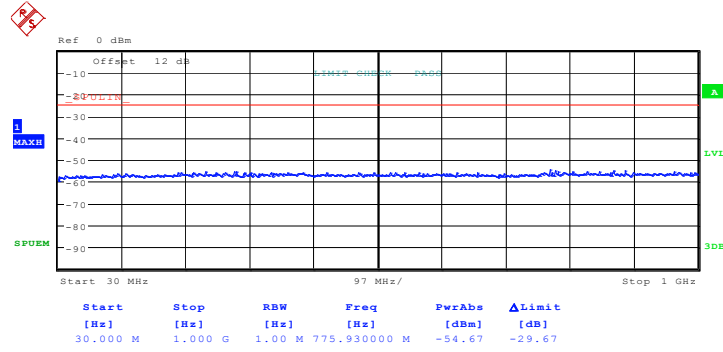

Date: 23.NOV.2010 18:20:39

**Conducted Spurious Emission Plot between 1 GHz ~ 27GHz**

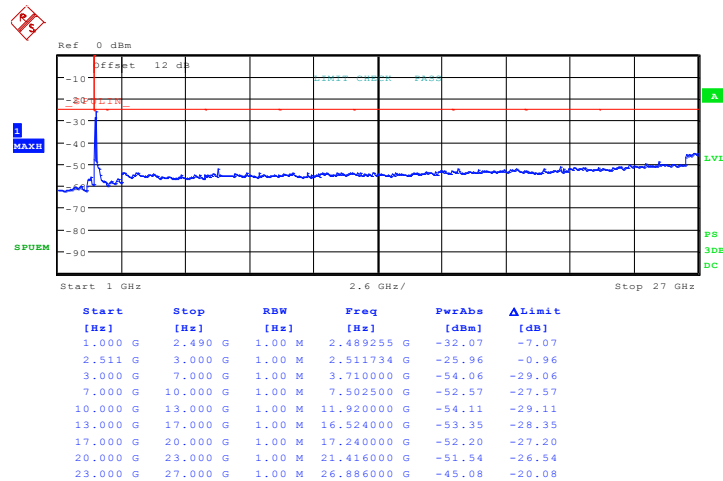

Date: 25.NOV.2010 03:28:38



<b>Band :</b>	802.16e	<b>Power Stage :</b>	High
<b>Test Mode :</b>	16QAM, BW 10MHz	<b>Channel :</b>	Middle

**Conducted Spurious Emission Plot between 30MHz ~ 1GHz**

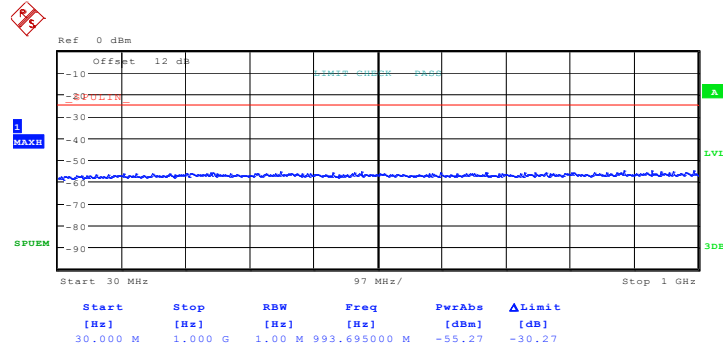

Date: 23.NOV.2010 18:20:04

**Conducted Spurious Emission Plot between 1 GHz ~ 27GHz**

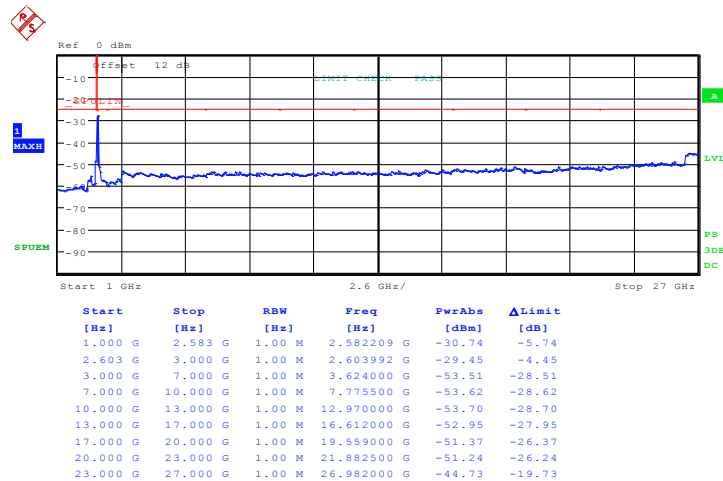

Date: 25.NOV.2010 03:32:15



<b>Band :</b>	802.16e	<b>Power Stage :</b>	High
<b>Test Mode :</b>	16QAM, BW 10MHz	<b>Channel :</b>	High

**Conducted Spurious Emission Plot between 30MHz ~ 1GHz**

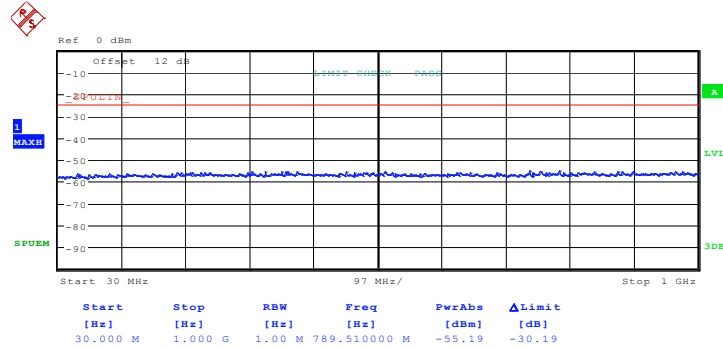

Date: 23.NOV.2010 18:22:10

**Conducted Spurious Emission Plot between 1 GHz ~ 27GHz**

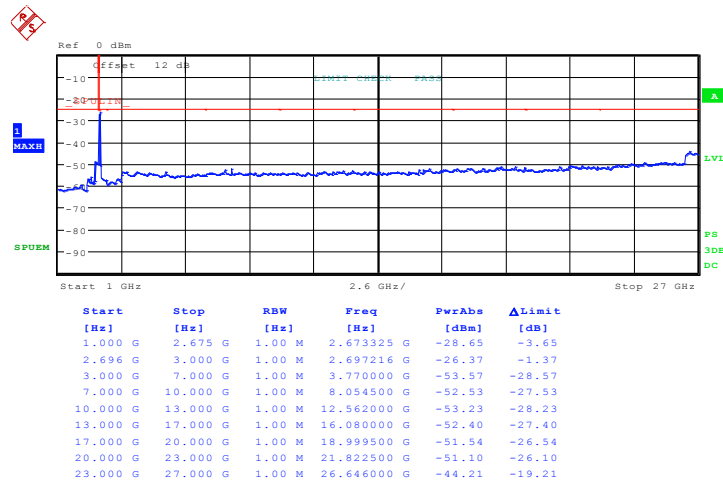

Date: 25.NOV.2010 04:03:08



## **3.4 Radiated Emissions Measurement**

### **3.4.1 Description of Radiated Emissions Measurement**

The power of any emission outside of the authorized operating frequency ranges must be lower than the transmitter power (P) by a factor of mobile digital stations, the attenuation factor shall be not less than  $43 + 10 \log (P)$  dB at the channel edge and  $55 + 10 \log (P)$  dB at 5.5 MHz from the channel edges. It is measured by means of a calibrated spectrum analyzer and scanned from 30 MHz up to a frequency including its 10<sup>th</sup> harmonic.

### **3.4.2 Measuring Instruments**

See list of measuring instruments of this test report.

### **3.4.3 Test Procedures**

1. The EUT was placed on a rotatable wooden table with 0.8 meter about ground.
2. The EUT was set 3 meters from the receiving antenna, which was mounted on the antenna tower.
3. The table was rotated 360 degrees to determine the position of the highest spurious emission.
4. The height of the receiving antenna is varied between one meter and four meters to search the maximum spurious emission for both horizontal and vertical polarizations.
5. Make the measurement with the spectrum analyzer's RBW = 1MHz, VBW = 1MHz, Sweep = 500ms, Taking the record of maximum spurious emission.
6. A horn antenna was substituted in place of the EUT and was driven by a signal generator.
7. Tune the output power of signal generator to the same emission level with EUT maximum spurious emission.
8. Taking the record of output power at antenna port.
9. Repeat step 7 to step 8 for another polarization.
10. Emission level (dBm) = output power + substitution Gain.

### 3.4.4 Test Setup

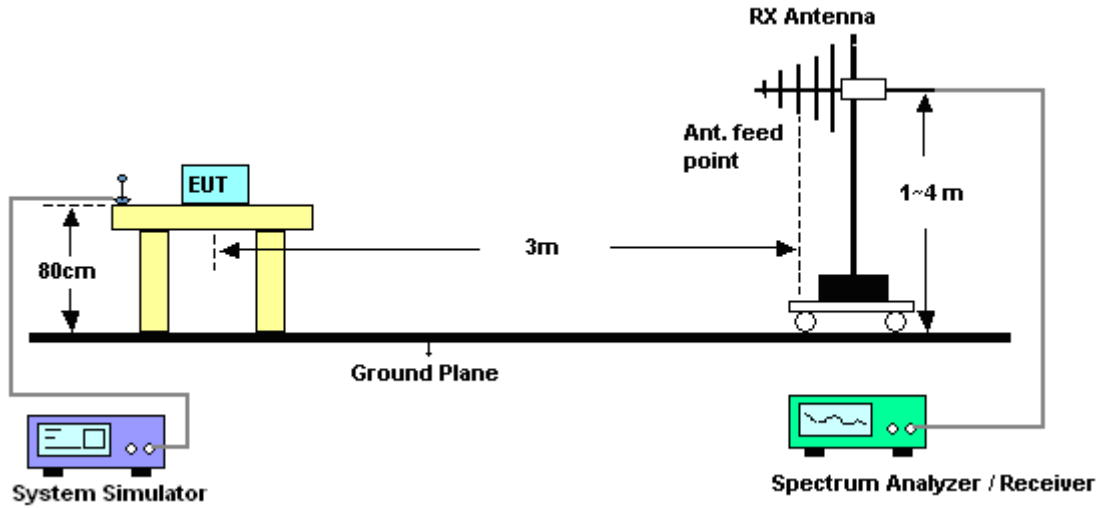



3.4.5 Test Result of Radiated Emissions

<b>Band :</b>	802.16e	<b>Temperature :</b>	22~24°C
<b>Test Mode :</b>	QPSK, BW 5MHz, Middle Ch (2593MHz)	<b>Relative Humidity :</b>	50~53%
<b>Test Engineer :</b>	Cona Huang	<b>Polarization :</b>	Horizontal
<b>Remark :</b>	Spurious emissions within 30-1000MHz were found more than 20dB below limit line.		

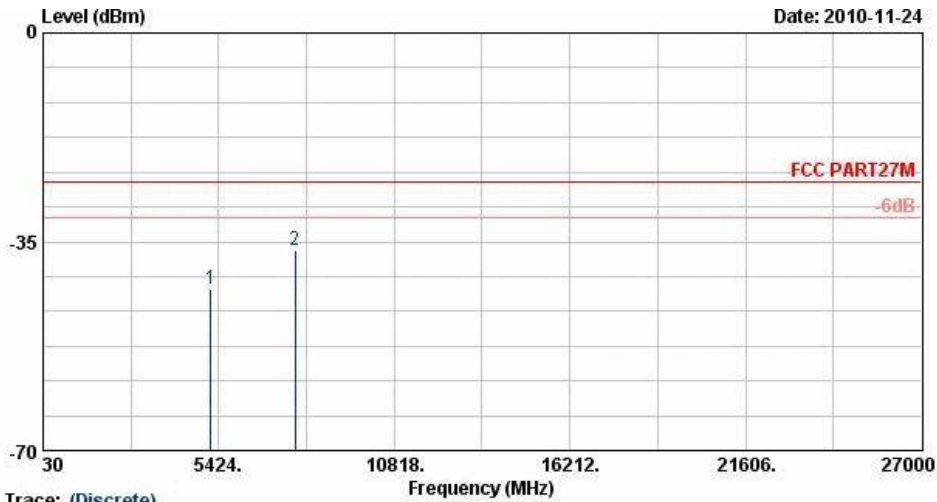

Trace: (Discrete)  
 Site : 03CH07-HY  
 Condition : FCC PART27M HF-ETRP(060306) HORIZONTAL  
 Power : From System

Frequency ( MHz )	EIRP ( dBm )	Limit ( dBm )	Over Limit ( dB )	SPA Reading ( dBm )	S.G. Power ( dBm )	TX Cable loss ( dB )	TX Antenna Gain ( dBi )	Polarization ( H/V )	Result
5186.00	-42.81	-25.00	-17.81	-61.89	-46.35	6.91	10.45	H	Pass
7779.00	-36.32	-25.00	-11.32	-62.58	-39.29	9.35	12.32	H	Pass



<b>Band :</b>	802.16e	<b>Temperature :</b>	22~24°C
<b>Test Mode :</b>	QPSK, BW 5MHz, Middle Ch (2593MHz)	<b>Relative Humidity :</b>	50~53%
<b>Test Engineer :</b>	Cona Huang	<b>Polarization :</b>	Vertical
<b>Remark :</b>	Spurious emissions within 30-1000MHz were found more than 20dB below limit line.		

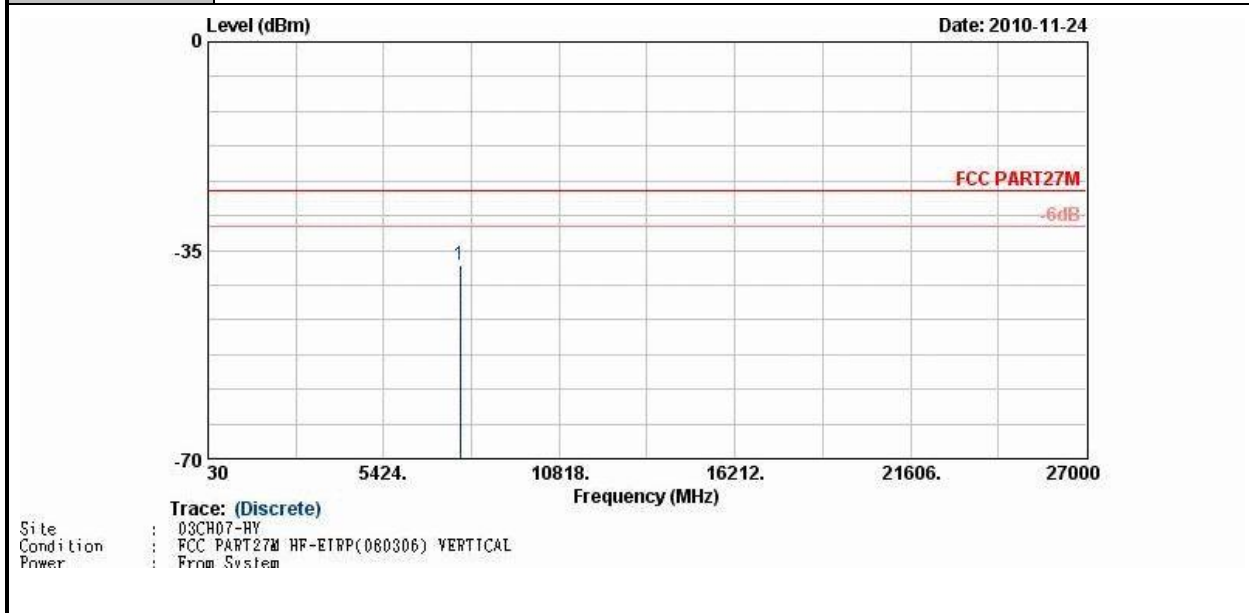

Frequency ( MHz )	EIRP ( dBm )	Limit ( dBm )	Over Limit ( dB )	SPA Reading ( dBm )	S.G. Power ( dBm )	TX Cable loss ( dB )	TX Antenna Gain ( dBi )	Polarization ( H/V )	Result
7779.00	-37.38	-25.00	-12.38	-63.64	-40.35	9.35	12.32	V	Pass





<b>Band :</b>	802.16e	<b>Temperature :</b>	22~24°C
<b>Test Mode :</b>	QPSK, BW 10MHz, Middle Ch (2593MHz)	<b>Relative Humidity :</b>	50~53%
<b>Test Engineer :</b>	Cona Huang	<b>Polarization :</b>	Horizontal
<b>Remark :</b>	Spurious emissions within 30-1000MHz were found more than 20dB below limit line.		

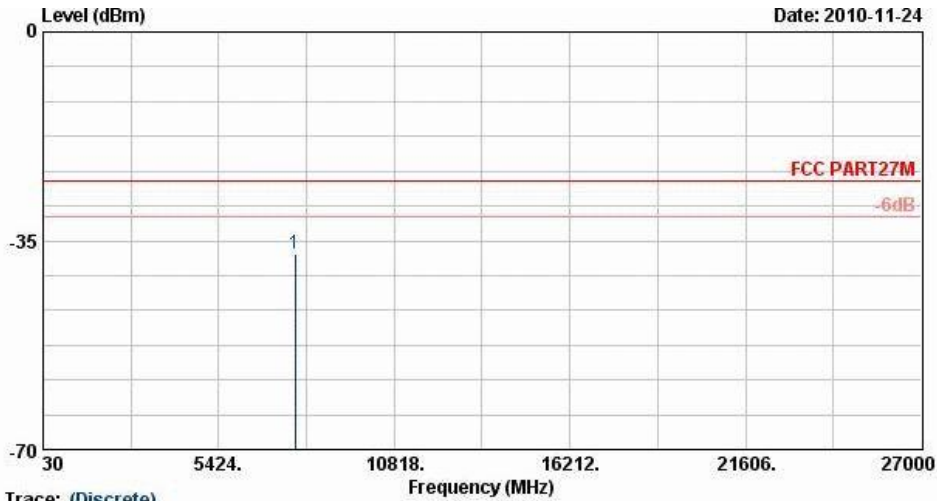

Trace: (Discrete)  
 Site : 03CH07-HY  
 Condition : FCC PART27M HF-ETRP(060306) HORIZONTAL  
 Power : From System

Frequency ( MHz )	EIRP ( dBm )	Limit ( dBm )	Over Limit ( dB )	SPA Reading ( dBm )	S.G. Power ( dBm )	TX Cable loss ( dB )	TX Antenna Gain ( dBi )	Polarization ( H/V )	Result
7779.00	-37.09	-25.00	-12.09	-63.35	-40.06	9.35	12.32	H	Pass



<b>Band :</b>	802.16e	<b>Temperature :</b>	22~24°C
<b>Test Mode :</b>	QPSK, BW 10MHz, Middle Ch (2593MHz)	<b>Relative Humidity :</b>	50~53%
<b>Test Engineer :</b>	Cona Huang	<b>Polarization :</b>	Vertical
<b>Remark :</b>	Spurious emissions within 30-1000MHz were found more than 20dB below limit line.		

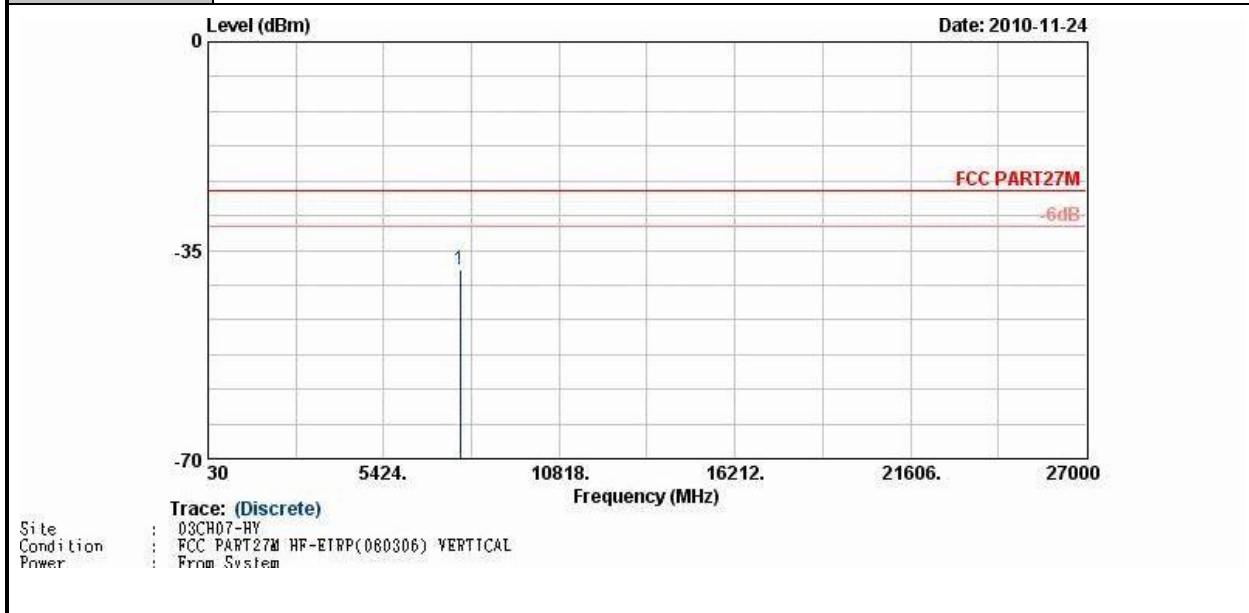

Frequency ( MHz )	EIRP ( dBm )	Limit ( dBm )	Over Limit ( dB )	SPA Reading ( dBm )	S.G. Power ( dBm )	TX Cable loss ( dB )	TX Antenna Gain ( dBi )	Polarization ( H/V )	Result
7779.00	-38.38	-25.00	-13.38	-64.64	-41.35	9.35	12.32	V	Pass



<b>Band :</b>	802.16e	<b>Temperature :</b>	22~24°C
<b>Test Mode :</b>	16QAM, BW 5MHz, Middle Ch (2593MHz)	<b>Relative Humidity :</b>	50~53%
<b>Test Engineer :</b>	Cona Huang	<b>Polarization :</b>	Horizontal
<b>Remark :</b>	Spurious emissions within 30-1000MHz were found more than 20dB below limit line.		

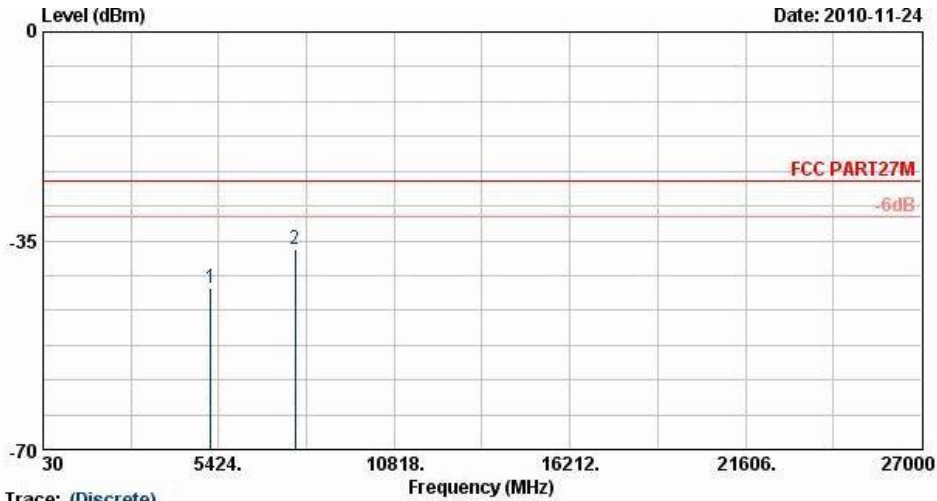

Trace: (Discrete)  
 Site : 03CH07-HY  
 Condition : FCC PART27M HF-ETRP(060306) HORIZONTAL  
 Power : From System

Frequency ( MHz )	EIRP ( dBm )	Limit ( dBm )	Over Limit ( dB )	SPA Reading ( dBm )	S.G. Power ( dBm )	TX Cable loss ( dB )	TX Antenna Gain ( dBi )	Polarization ( H/V )	Result
5186.00	-43.06	-25.00	-18.06	-62.14	-46.60	6.91	10.45	H	Pass
7779.00	-36.45	-25.00	-11.45	-62.71	-39.42	9.35	12.32	H	Pass



<b>Band :</b>	802.16e	<b>Temperature :</b>	22~24°C
<b>Test Mode :</b>	16QAM, BW 5MHz, Middle Ch (2593MHz)	<b>Relative Humidity :</b>	50~53%
<b>Test Engineer :</b>	Cona Huang	<b>Polarization :</b>	Vertical
<b>Remark :</b>	Spurious emissions within 30-1000MHz were found more than 20dB below limit line.		

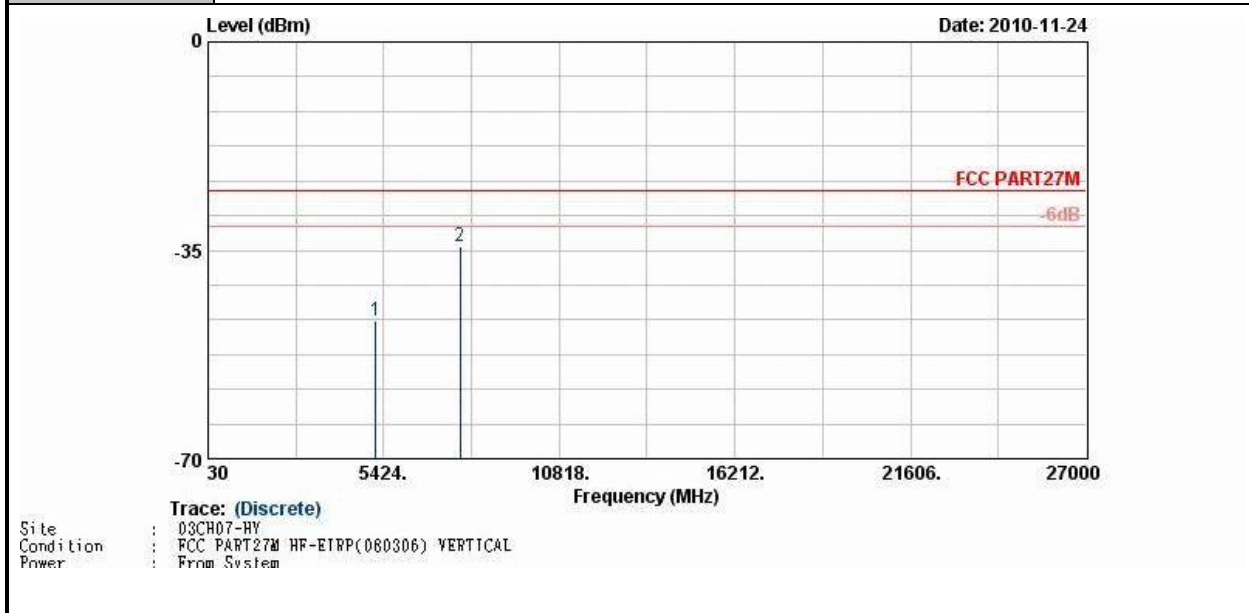

Frequency ( MHz )	EIRP ( dBm )	Limit ( dBm )	Over Limit ( dB )	SPA Reading ( dBm )	S.G. Power ( dBm )	TX Cable loss ( dB )	TX Antenna Gain ( dBi )	Polarization ( H/V )	Result
5186.00	-46.79	-25.00	-21.79	-65.87	-50.33	6.91	10.45	V	Pass
7779.00	-34.35	-25.00	-9.35	-60.61	-37.32	9.35	12.32	V	Pass



<b>Band :</b>	802.16e	<b>Temperature :</b>	22~24°C
<b>Test Mode :</b>	16QAM, BW 10MHz, Middle Ch (2593MHz)	<b>Relative Humidity :</b>	50~53%
<b>Test Engineer :</b>	Cona Huang	<b>Polarization :</b>	Horizontal
<b>Remark :</b>	Spurious emissions within 30-1000MHz were found more than 20dB below limit line.		

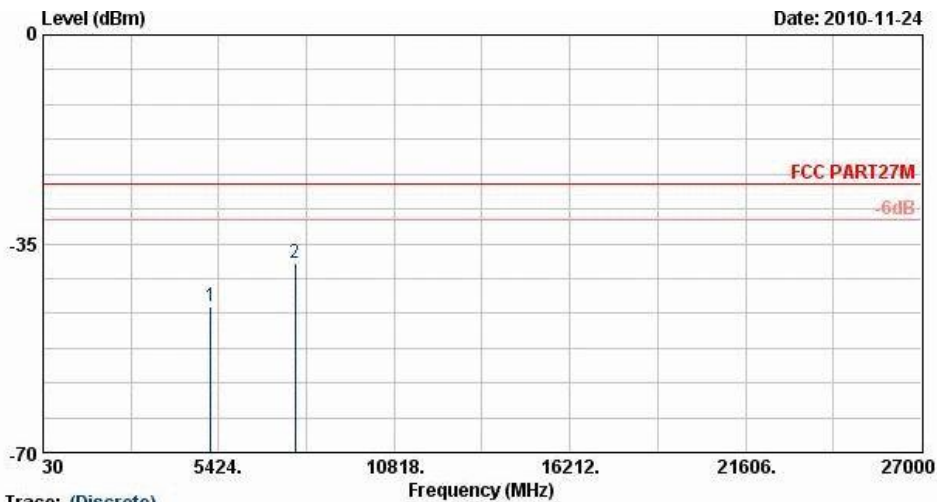

Site : 03CH07-HY  
 Condition : FCC PART27M HF-ETRP(060306) HORIZONTAL  
 Power : From System

Frequency ( MHz )	EIRP ( dBm )	Limit ( dBm )	Over Limit ( dB )	SPA Reading ( dBm )	S.G. Power ( dBm )	TX Cable loss ( dB )	TX Antenna Gain ( dBi )	Polarization ( H/V )	Result
5186.00	-45.66	-25.00	-20.66	-64.74	-49.20	6.91	10.45	H	Pass
7779.00	-38.27	-25.00	-13.27	-64.53	-41.24	9.35	12.32	H	Pass



<b>Band :</b>	802.16e	<b>Temperature :</b>	22~24°C
<b>Test Mode :</b>	16QAM, BW 10MHz, Middle Ch (2593MHz)	<b>Relative Humidity :</b>	50~53%
<b>Test Engineer :</b>	Cona Huang	<b>Polarization :</b>	Vertical
<b>Remark :</b>	Spurious emissions within 30-1000MHz were found more than 20dB below limit line.		

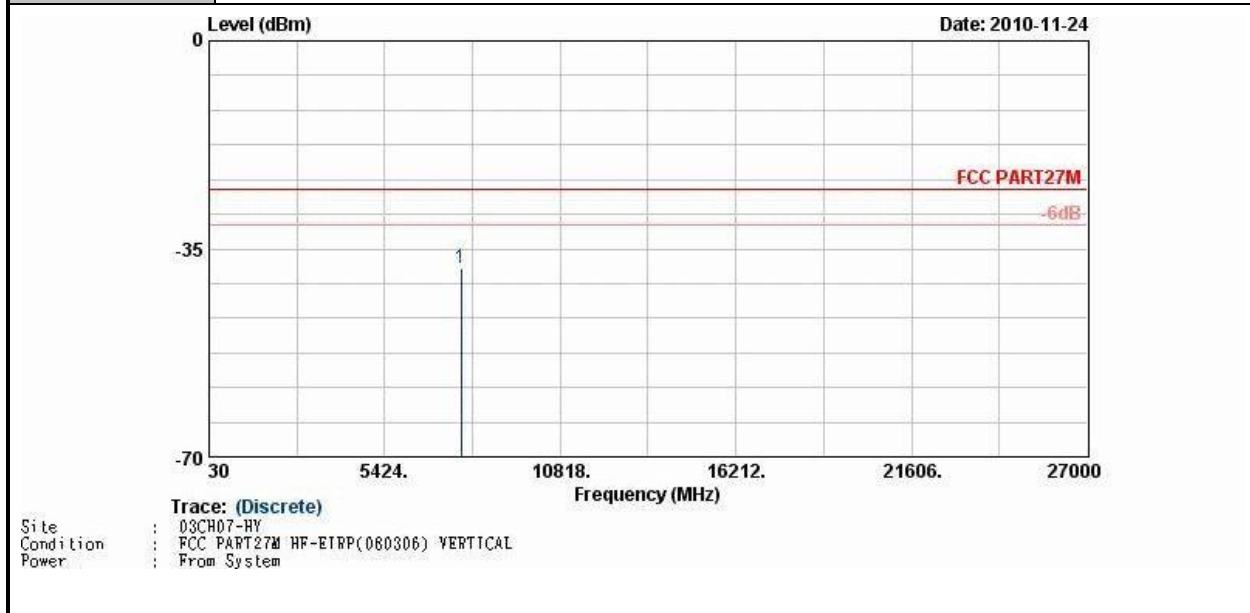

Frequency (MHz)	EIRP (dBm)	Limit (dBm)	Over Limit (dB)	SPA Reading (dBm)	S.G. Power (dBm)	TX Cable loss (dB)	TX Antenna Gain (dBi)	Polarization (H/V)	Result
7779.00	-38.32	-25.00	-13.32	-64.58	-41.29	9.35	12.32	V	Pass

## 3.5 Frequency Stability Measurement

### 3.5.1 Description of Frequency Stability Measurement

The frequency stability shall be sufficient to ensure that the fundamental emissions stay within the authorized frequency band. For equipment authorization purposes, this is a reporting requirement only.

### 3.5.2 Measuring Instruments

See list of measuring instruments of this test report.

### 3.5.3 Test Procedures for Temperature Variation

1. The EUT was set up in the thermal chamber and connected with the System Simulator.
2. With power OFF, the temperature was decreased to  $-30^{\circ}\text{C}$  and the EUT was stabilized for three hours. Power was applied and the maximum change in frequency was recorded within one minute.
3. With power OFF, the temperature was raised in  $10^{\circ}\text{C}$  step up to  $50^{\circ}\text{C}$ . The EUT was stabilized at each step for at least half an hour. Power was applied and the maximum frequency change was recorded within one minute.
4. If the EUT can not be turned on at  $-30^{\circ}\text{C}$ , the testing lowest temperature will be raised in  $10^{\circ}\text{C}$  step until the EUT can be turned on.

### 3.5.4 Test Procedures for Voltage Variation

1. The EUT was placed in a temperature chamber at  $25\pm 5^{\circ}\text{C}$  and connected with the System Simulator.
2. The power supply voltage to the EUT was varied from BEP to 115% of the nominal value measured at the input to the EUT.
3. The variation in frequency was measured for the worst case.

### 3.5.5 Test Setup

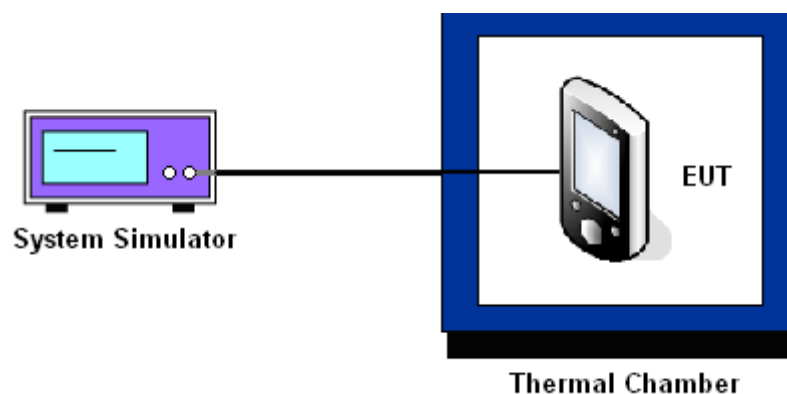

3.5.6 Test Result of Temperature Variation

<b>Band :</b>	802.16e	<b>Channel :</b>	Middle (2593MHz)
<b>Limit (ppm) :</b>	2.5		

Temperature (°C)	QPSK, BW 5MHz		QPSK, BW 10MHz		Result
	Freq. Dev. (Hz)	Deviation (ppm)	Freq. Dev. (Hz)	Deviation (ppm)	
-30	N/A	N/A	N/A	N/A	PASS
-20	N/A	N/A	N/A	N/A	
-10	N/A	N/A	N/A	N/A	
0	-29.36	-0.011	37.01	0.014	
10	-31.55	-0.012	-26.66	-0.010	
20	30.02	0.012	17.42	0.007	
30	-18.64	-0.007	23.89	0.009	
40	-21.67	-0.008	-31.97	-0.012	
50	N/A	N/A	N/A	N/A	

**Note:**

1. The EUT stops transmitting at temperatures -10°C, -20°C, -30°C, and 50°C.
2. The manufacturer declared that the EUT could work properly between temperatures 0°C~40°C.

<b>Band :</b>	802.16e	<b>Channel :</b>	Middle (2593MHz)
<b>Limit (ppm) :</b>	2.5		

Temperature (°C)	16QAM, BW 5MHz		16QAM, BW 10MHz		Result
	Freq. Dev. (Hz)	Deviation (ppm)	Freq. Dev. (Hz)	Deviation (ppm)	
-30	N/A	N/A	N/A	N/A	PASS
-20	N/A	N/A	N/A	N/A	
-10	N/A	N/A	N/A	N/A	
0	-33.19	-0.013	-28.77	-0.011	
10	19.82	0.008	-26.57	-0.010	
20	-25.46	-0.010	-28.13	-0.011	
30	-25.44	-0.010	-30.22	-0.012	
40	-36.48	-0.014	31.82	0.012	
50	N/A	N/A	N/A	N/A	

**Note:**

1. The EUT stops transmitting at temperatures -10°C, -20°C, -30°C, and 50°C.
2. The manufacturer declared that the EUT could work properly between temperatures 0°C~40°C.





3.5.7 Test Result of Voltage Variation

Band & Channel	Mode	Voltage (Volt)	Freq. Dev. (Hz)	Deviation (ppm)	Result
802.16e Middle (2593MHz)	QPSK, BW 5MHz	AC 120	-30.75	-0.012	PASS
		102	-28.07	-0.011	
		138	31.86	0.012	
	QPSK, BW 10MHz	AC 120	-38.01	-0.015	PASS
		102	27.55	0.011	
		138	-26.42	-0.010	
	16QAM, BW 5MHz	AC 120	-29.31	-0.011	PASS
		102	-29.48	-0.011	
		138	36.49	0.014	
	16QAM, BW 10MHz	AC 120	-27.01	-0.010	PASS
		102	-28.55	-0.011	
		138	-37.45	-0.014	

Note: Normal Voltage = AC 120V.



## 4 List of Measuring Equipments

Instrument	Manufacturer	Model No.	Serial No.	Characteristics	Calibration Date	Due Date	Remark
Spectrum Analyzer	R&S	FSP30	101329	9kHz~30GHz	Apr. 26, 2010	Apr. 25, 2011	Conducted (TH02-HY)
Thermal Chamber	Ten Billion	TTH-D35P	TBN-930701	N/A	Jul. 30,2010	Jul. 29, 2011	Conducted (TH02-HY)
Bilog Antenna	SCHAFFNER	CBL6111C	2726	30MHz ~ 1GHz	Oct. 31, 2010	Oct. 30, 2011	Radiation (03CH07-HY)
Spectrum Analyzer	R&S	FSP	101067	9KHz ~ 30GHz	Dec. 04, 2009	Dec. 03, 2010	Radiation (03CH07-HY)
Double Ridge Horn Antenna	ESCO	3117	00075962	1GHz ~ 18GHz	Aug. 19, 2010	Aug. 18, 2011	Radiation (03CH07-HY)
SHF-EHF Horn Antenna	SCHWARZBECK	BBHA 9170	BBHA917025 1	15GHz- 40GHz	Oct. 18, 2010	Oct. 17, 2011	Radiation (03CH07-HY)
Pre Amplifier	Agilent	8449B	3008A02362	1GHz~ 26.5GHz	Dec.09,2009	Dec. 08, 2010	Radiation (03CH07-HY)
Pre Amplifier	COM-POWER	PA-103A	161241	10-1000MHz.32dB. GAIN	Mar. 27, 2010	Mar. 26, 2011	Radiation (03CH07-HY)
Loop Antenna	R&S	HFH2-Z2	860004/001	9 kHz~30 MHz	Jul. 29, 2010	Jul. 28, 2011	Radiation (03CH07-HY)
WiMAX Base Station (System Simulator)	Agilent	E6651A	N/A	N/A	N/A	N/A	-

## 5 Uncertainty of Evaluation

### Uncertainty of Radiated Emission Measurement (30 MHz ~ 1000 MHz)

Contribution	Uncertainty of $X_i$		$u(X_i)$
	dB	Probability Distribution	
Receiver Reading	0.41	Normal (k=2)	0.21
Antenna Factor Calibration	0.83	Normal (k=2)	0.42
Cable Loss Calibration	0.25	Normal (k=2)	0.13
Pre-Amplifier Gain Calibration	0.27	Normal (k=2)	0.14
RCV/SPA Specification	2.50	Rectangular	0.72
Antenna Factor Interpolation for Frequency	1.00	Rectangular	0.29
Site Imperfection	1.43	Rectangular	0.83
Mismatch	+0.39 / -0.41	U-Shape	0.28
<b>Combined Standard Uncertainty <math>U_c(y)</math></b>	<b>1.27</b>		
<b>Measuring Uncertainty for a Level of Confidence of 95% (<math>U = 2U_c(y)</math>)</b>	<b>2.54</b>		

### Uncertainty of Radiated Emission Measurement (1 GHz ~ 40 GHz)

Contribution	Uncertainty of $X_i$		$u(X_i)$	$C_i$	$C_i * u(X_i)$
	dB	Probability Distribution			
Receiver Reading	$\pm 0.10$	Normal (k=2)	0.10	1	0.10
Antenna Factor Calibration	$\pm 1.70$	Normal (k=2)	0.85	1	0.85
Cable Loss Calibration	$\pm 0.50$	Normal (k=2)	0.25	1	0.25
Receiver Correction	$\pm 2.00$	Rectangular	1.15	1	1.15
Antenna Factor Directional	$\pm 1.50$	Rectangular	0.87	1	0.87
Site Imperfection	$\pm 2.80$	Triangular	1.14	1	1.14
Mismatch Receiver VSWR $\Gamma_1 = 0.197$ Antenna VSWR $\Gamma_2 = 0.194$ Uncertainty = $20\text{Log}(1-\Gamma_1*\Gamma_2)$	+0.34 / -0.35	U-Shape	0.244	1	0.244
<b>Combined Standard Uncertainty <math>U_c(y)</math></b>	<b>2.36</b>				
<b>Measuring Uncertainty for a Level of Confidence of 95% (<math>U = 2U_c(y)</math>)</b>	<b>4.72</b>				



## **Appendix A. Photographs of EUT**

Please refer to Sporton report number EP000616 as below.