



FCC SAR Test Report

APPLICANT : Green Packet Berhad, Taiwan
EQUIPMENT : Portable WiMAX WiFi Router
BRAND NAME : Green Packet
MODEL NAME : MF-250
FCC ID : W9V-MF250-GP
STANDARD : FCC 47 CFR Part 2 (2.1093)
IEEE C95.1-1999
IEEE 1528-2003
FCC OET Bulletin 65 Supplement C (Edition 01-01)

The product was received on Oct. 06, 2010 and completely tested on Nov. 22, 2010. We, SPORTON INTERNATIONAL INC., would like to declare that the tested sample has been evaluated in accordance with the procedures and shown the compliance with the applicable technical standards.

The test results in this report apply exclusively to the tested model / sample. Without written approval of SPORTON INTERNATIONAL INC., the test report shall not be reproduced except in full.

Reviewed by:

Roy Wu / Manager



Testing Laboratory
1190

SPORTON INTERNATIONAL INC.

No. 52, Hwa Ya 1st Rd., Hwa Ya Technology Park, Kwei-Shan Hsiang, Tao Yuan Hsien, Taiwan, R.O.C.



Table of Contents

Revision History..... 3
1. Statement of Compliance 4
2. Administration Data 5
2.1 Testing Laboratory 5
2.2 Applicant..... 5
2.3 Manufacturer 5
2.4 Application Details 5
3. General Information 6
3.1 Description of Device Under Test (DUT)..... 6
3.2 Product Photos 6
3.3 Applied Standards 6
3.4 Device Category and SAR Limits 6
3.5 Test Conditions 7
3.5.1 Ambient Condition 7
3.5.2 Test Configuration..... 7
4. Specific Absorption Rate (SAR).....13
4.1 Introduction13
4.2 SAR Definition13
5. SAR Measurement System.....14
5.1 E-Field Probe.....15
5.1.1 E-Field Probe Specification15
5.1.2 E-Field Probe Calibration.....16
5.2 Data Acquisition Electronics (DAE).....16
5.3 Robot.....16
5.4 Measurement Server17
5.5 Phantom18
5.6 Device Holder19
5.7 Data Storage and Evaluation.....21
5.7.1 Data Storage21
5.7.2 Data Evaluation21
5.8 Test Equipment List23
6. Tissue Simulating Liquids24
7. Uncertainty Assessment26
8. SAR Measurement Evaluation29
8.1 Purpose of System Performance check29
8.2 System Setup29
8.3 Validation Results30
9. DUT Testing Position31
10. Measurement Procedures32
10.1 Spatial Peak SAR Evaluation32
10.2 Scan Procedures33
10.3 SAR Averaged Methods33
11. SAR Test Results34
11.1 Conducted Power (Unit: dBm)34
11.2 Scaling Factor Deriving35
11.3 Test Records for Body SAR Test37
11.4 Linearity Response Check.....38
11.5 Compare with Different Scan Resolution40
12. References.....41

- Appendix A. Plots of System Performance Check
Appendix B. Plots of SAR Measurement
Appendix C. DASY Calibration Certificate
Appendix D. Product Photos
Appendix E. Test Setup Photos
Appendix F. Plots of Duty Cycle



Revision History

REPORT NO.	VERSION	DESCRIPTION	ISSUED DATE
FA000616B	Rev. 01	Initial issue of report	Feb. 01, 2011



1. Statement of Compliance

The maximum results of Specific Absorption Rate (SAR) found during testing for **Green Packet Berhad, Taiwan Portable WiMAX WiFi Router Green Packet MF-250** are as follows (with expanded uncertainty 21.4 % for 300 MHz to 3 GHz, and 25.6% for 3 GHz to 6 GHz).

Mode	Position	Measured SAR _{1g} (W/kg)	Scaled SAR _{1g} (W/kg)
WiMAX	Body (1 cm Gap)	0.844	0.920

This device is in compliance with Specific Absorption Rate (SAR) for general population/uncontrolled exposure limits (1.6 W/kg) specified in FCC 47 CFR part 2 (2.1093) and ANSI/IEEE C95.1-1999, and had been tested in accordance with the measurement methods and procedures specified in IEEE 1528-2003 and FCC OET Bulletin 65 Supplement C (Edition 01-01).



2. Administration Data

2.1 Testing Laboratory

Test Site	SPORTON INTERNATIONAL INC.
Test Site Location	No. 52, Hwa Ya 1 st Rd., Hwa Ya Technology Park, Kwei-Shan Hsiang, Tao Yuan Hsien, Taiwan, R.O.C. TEL: +886-3-327-3456 FAX: +886-3-328-4978

2.2 Applicant

Company Name	Green Packet Berhad, Taiwan
Address	6F., No. 21, Lane 583, Rueiguang Rd., Neihu District, Taipei City, Taiwan (R.O.C.)

2.3 Manufacturer

Company Name	Green Packet Berhad, Taiwan
Address	1. 6F., No. 21, Lane 583, Rueiguang Rd., Neihu District, Taipei City, Taiwan (R.O.C.) 2. Suite 21213, No. 498, Guoshoujing Rd., Pudong New Area, Shanghai, 201203, China

2.4 Application Details

Date of Receipt of Application	Oct. 06, 2010
Date of Start during the Test	Nov. 20, 2010
Date of End during the Test	Nov. 22, 2010



3. General Information

3.1 Description of Device Under Test (DUT)

Product Feature & Specification	
DUT Type	Portable WiMAX WiFi Router
Brand Name	Green Packet
Model Name	MF-250
FCC ID	W9V-MF250-GP
Tx Frequency	2496 MHz ~ 2690 MHz
Rx Frequency	2496 MHz ~ 2690 MHz
Maximum Output Power to Antenna	23.84 dBm
Antenna Type	Monopole Antenna
Type of Modulation	Uplink : OFDMA (QPSK / 16QAM) Downlink : OFDMA (QPSK / 16QAM / 64QAM)
DUT Stage	Production Unit

Remark: The above DUT's information was declared by manufacturer. Please refer to the specifications or user's manual for more detailed description.

3.2 Product Photos

Please refer to Appendix D.

3.3 Applied Standards

The Specific Absorption Rate (SAR) testing specification, method and procedure for this device is in accordance with the following standards:

- FCC 47 CFR Part 2 (2.1093)
- IEEE C95.1-1999
- IEEE 1528-2003
- FCC OET Bulletin 65 Supplement C (Edition 01-01)
- FCC KDB 615223 D01 v01
- FCC KDB 648474 D01 v01r05
- 2010 TCB Workshop RF Exposure Procedures-Review

3.4 Device Category and SAR Limits

This device belongs to portable device category because its radiating structure is allowed to be used within 20 centimeters of the body of the user. Limit for General Population/Uncontrolled exposure should be applied for this device, it is 1.6 W/kg as averaged over any 1 gram of tissue.



3.5 Test Conditions

3.5.1 Ambient Condition

Ambient Temperature	20 to 24 °C
Humidity	< 60 %

3.5.2 Test Configuration

The test device is a 2.6 GHz WiMAX transceiver. It provides one completed transmitter and two receivers. This Portable WiMAX WiFi Router has two built-in antennas and it supports Tx antenna diversity function. Only one transmitting antenna of WiMAX can be used at the same time.

The device only transmits by PUSC zone type. The other zone types, AMC, and FUSC, are not available on this device. The maximum DL:UL (downlink-to-uplink) symbol ratio is determined according to the PUSC requirements. The system transmits an odd number of symbols using DL-PUSC, consisting of even multiples of traffic and control symbols, plus one symbol for the preamble. The device transmits in multiples of three symbols using UL-PUSC. The OFDMA symbol time allows up to 48 downlink and uplink symbols to be transmitted in each 5 ms frame. The system transmits on 5 ms frames using 5 MHz and 10 MHz channels. TTG and RTG are also included in each frame as DL/UL transmission gaps; therefore, the system can only allow 47 or less symbols per frame. The maximum DL:UL symbol ratio allowed for this device and determined according to these PUSC parameters is 29:18.

For PUSC zone type, the 10 MHz channel bandwidth uses 1024 sub-carriers and 35 sub-channels, with 184 spare/safeguard sub-carriers and 840 available for transmission, consisting of 560 data and 280 pilot sub-carriers. The 5 MHz channel bandwidth uses 512 sub-carriers and 17 sub-channels, with 104 spare/safeguard sub-carriers and 408 available for transmission, consisting 272 data and 136 pilot sub-carriers.

Control signals are transmitted in the first 3 symbols of each uplink burst. The rest of the uplink sub-frame contains normal traffic data bursts. The first 3 symbols are also used for ranging, which is shared with other users. During normal operation, the control symbols are transmitted at reduced power and the traffic symbols may transmit at maximum power. For SAR testing purposes, the configuration of control symbols is dependent on the test software and test equipment setup. The uplink allows a maximum of 15 traffic and 3 control symbols, 18 total, per frame. These conditions are applicable to both 5 and 10 MHz channel configurations used by this device.



The 802.16e/WiMAX device and system operating parameters is as below.

Description	Parameter		Comment
FCC ID	W9V-MF250-GP		Identify all related FCC ID
Radio Service	Part 27 Subpart M		Rule parts
Transmit Frequency Range (MHz)	5MHz BW : 2498.5 MHz to 2687.5 MHz 10MHz BW : 2501.0 MHz to 2685.0 MHz		System parameter
System/Channel Bandwidth (MHz)	5 MHz	10 MHz	System parameter
System Profile	Release 1.0(Revision 1.7.1 2008) Band Class 3 Radio Profile 3A		Defined by WiMAX Forum
Modulation Schemes	QPSK, 16QAM		Identify all applicable UL modulations
Sampling Factor	28/25		System parameter
Sampling Frequency (MHz)	5.6 MHz	11.2 MHz	(F _s)
Sample Time (ns)	178 ns	89 ns	(1/F _s)
FFT Size (N _{FFT})	512	1024	(N _{FFT})
Sub-Carrier Spacing (kHz)	10.94 kHz		(Δ f)
Useful Symbol Time (μs)	91.43 μs		(T _b =1/Δ f)
Guard Time (μs)	11.43 μs		(T _g =T _b /cp); cp = cyclic prefix
OFDMA Symbol Time (μs)	102.867 μs		(T _s =T _b +T _g)
Frame Size (ms)	5 ms		System parameter
TTG + RTG (μs or number of symbols)	165.8 μs		Idle time, system parameter
Number of DL OFDMA Symbols per Frame	Max: 29		Identify the allowed & maximum symbols, including both traffic & control symbols
Number of UL OFDMA Symbols per Frame	Max: 18		
DL:UL Symbol Ratios	Max 29:18		For determining UL duty factor
Power Class (dBm)	Power Class 2, 24.0 dBm		Identify power class and tolerance
Wave1 / Wave2	Wave2: Two antennas for Tx/Rx diversity. Main Ant and Aux Ant cannot transmit simultaneously		Describe antenna diversity info and MIMO requirements separately
UL Zone Types (FUSC, PUSC, OFUSC, OPUSC, AMC, TUSC1, TUSC2)	PUSC only		Describe separately the symbol and sub-carrier/sub-channel structures applicable to each zone type
Maximum Number of UL Sub-Carriers	Null Sub-Carriers=104 Pilot Sub-Carriers=136 Data Sub-Carrier=272	Null Sub-Carriers=184 Pilot Sub-Carriers=280 Data Sub-Carriers=560	Identify the allowed and tested / to be tested parameters; include separate explanations on the types of control symbols and how the power levels are determined
Measured UL Burst Maximum Average Conducted Power	23.84 dBm	23.76 dBm	
UL Control Symbol Configuration	3 PUSC symbols (used for ranging, CQICH and ACK/NACK)		
UL Control Symbol Maximum Conducted Average Power	73.88 mW	35.88 mW	
UL Burst Peak-to-Average (Conducted) Power Ratio (PAPR)	PAPR is between 6.61 ~ 8.00 dB A Anritus wideband power meter was used to measure this item. Average, peak and PAPR are measured simultaneously. The test records please refer to section 11.1 of this report.		Identify the expected range and measured/tested PAR; explain separately the methods used / to be used to address SAR probe calibration and measurement error issues
Frame Averaged UL Transmission Duty Factor (%)	Duty cycle was measured by a spectrum. The measured duty cycle is 31.5 %. Theoretical duty cycle is 15 x 102.857 μs / 5000 μs = 30.86 %. cf = 1/(duty cycle) = 3.24. This cf was used for SAR evaluation.		Show calculations separately and explain how the applicable CF (<i>crest factor</i>) used / to be use in the SAR measurements is derived and how the control symbols are accounted for



Time Vector Plots and Duty Cycle

The plot below shows the waveform characteristics of the signal used in the SAR measurement. The pulse duration corresponds to a DL:UL symbol ratio of 29:18 and control symbols are not active.

The plots of time vector and calculation of duty cycle can be referred to appendix E. The plot A is used to get the frame length of test signal and the plot B is used to get the time of UL data symbols. Since there was no energy in the control symbols, the effective power is only across 15 data symbols. The calculation of duty cycle is as below:

Duty Cycle = 15 data symbols UL time / Frame Length x 100 %

Summary table is shown as below.

Zone Type	Modulation	Coding Rate	Duty Cycle (%)	Crest Factor (%)
PUSC	16QAM (5M)	1/2	31.5	3.17
PUSC	16QAM (10M)	1/2	31.5	3.17
PUSC	16QAM (5M)	3/4	31.5	3.17
PUSC	16QAM (10M)	3/4	31.5	3.17
PUSC	QPSK (5M)	1/2	31.5	3.17
PUSC	QPSK (10M)	1/2	31.5	3.17
PUSC	QPSK (5M)	3/4	31.5	3.17
PUSC	QPSK (10M)	3/4	31.5	3.17

Note: Crest Factor = 1 / Duty Cycle.

Test Software Details

The DUT use the MTK FT-TOOL program installed on a host laptop computer to configure the DUT into the engineering mode. In engineering mode, the transmitter parameters for frequency, BW, modulation, antenna, and transmitting maximum power can be set and keep transmitting WiMAX signal. This enables the DUT to transmit at maximum power with a constant duty factor according to the maximum DL:UL symbol ratio 29:18, using a specific modulation, zone type, sub-channel configuration and other operating requirements. Therefore, there is no control channel transmission in uplink signal. SAR measurement were taken in this configuration with the DUT transmitting using the 29:18 ratio, but since there was no energy in the control symbols, the effective power is only across 15 data symbols. The test software for this device serves only one purpose, to configure the DUT into engineering mode during the SAR measurements.

The steps for test software setup are as below

1. Select "Disconnect"
2. Select "Conn. Instrmt."
3. Select "Simple Test Mode"

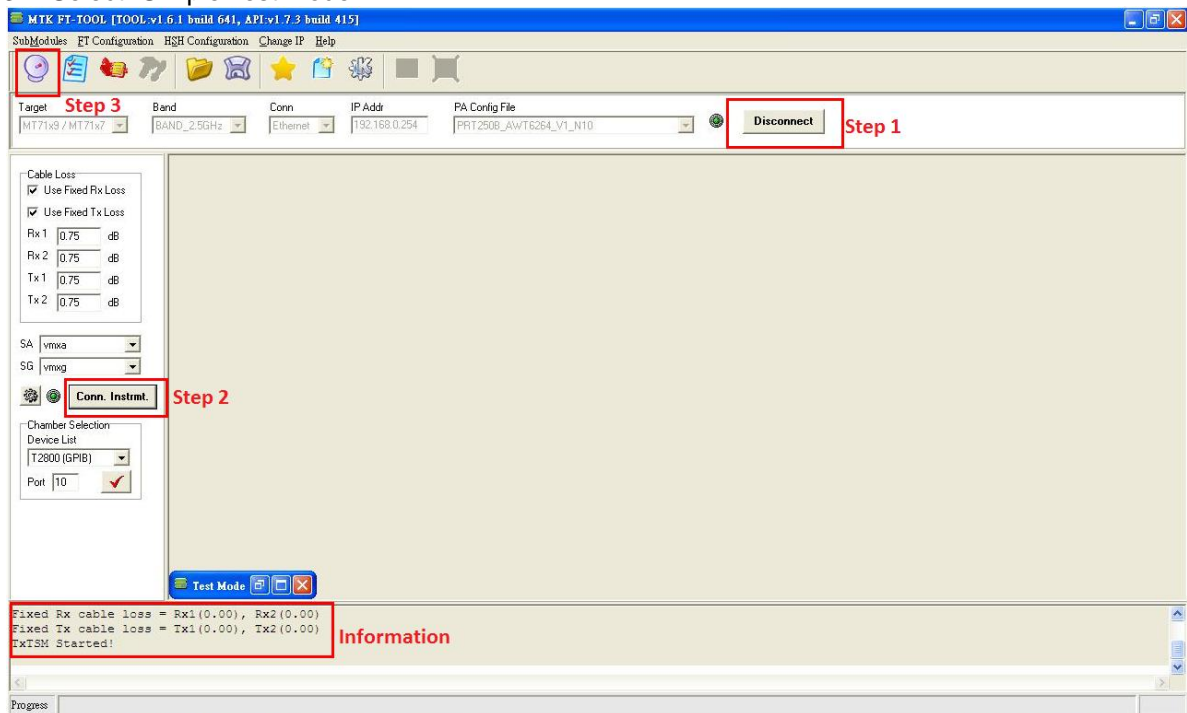

4. Set the transmitting frequency
5. Set the channel bandwidth
6. Set the modulation and coding rate
7. Set the transmitting antenna (Tx_Path1 = Main Antenna, Tx_Path0 = Aux Antenna)
8. Set the maximum transmitting power
9. Available the maximum power parameter
10. Select the "Start Tx" to transmit WiMAX signal

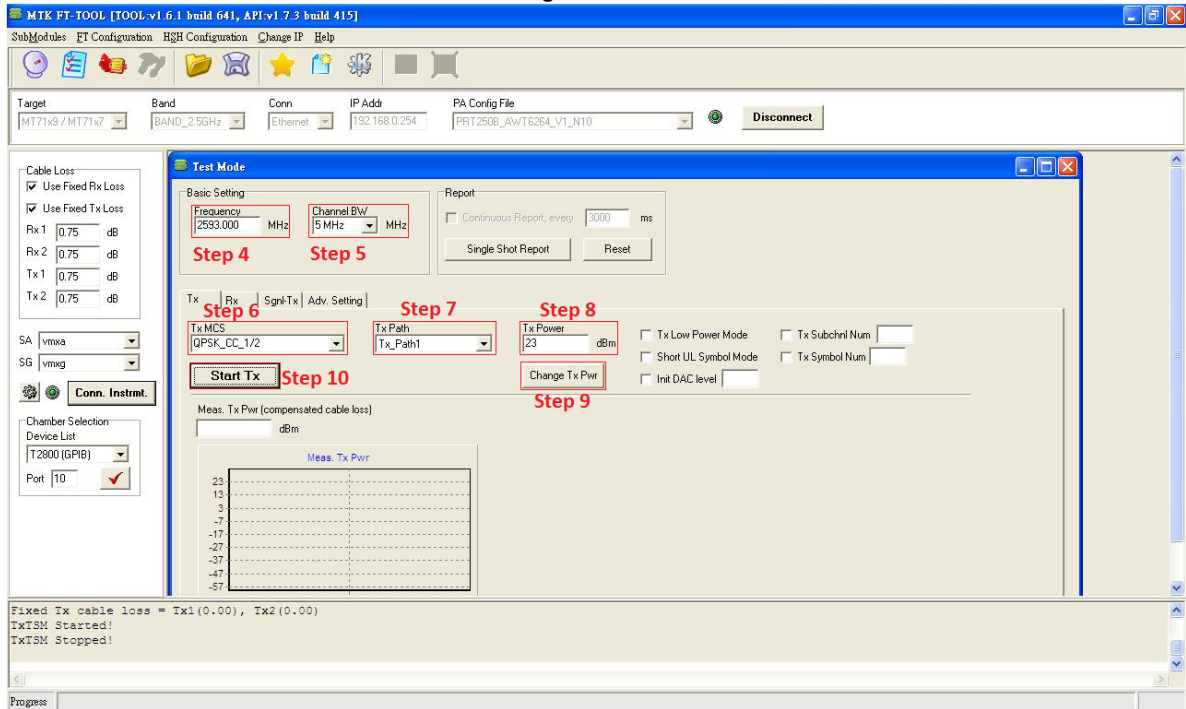

The WiMAX non-TCB testing guidance inquiry has been approved under KDB inquiry 324377.



Position	WiMAX (Main Antenna)	802.11b/g	Max. SAR Summation
Front Face	0.725	0.144	0.869
Rear Face	0.323	0.083	0.406
Right Side	0.202	0	0.202
Left Side	0.203	0.076	0.279
Top Side	0.501	0	0.501
Bottom Side	0	0.132	0.132

Position	WiMAX (Aux. Antenna)	802.11b/g	Max. SAR Summation
Front Face	0.920	0.144	1.064
Rear Face	0.198	0.083	0.281
Right Side	0.894	0	0.894
Left Side	0	0.076	0.076
Top Side	0	0	0
Bottom Side	0	0.132	0.132

Note: The maximum SAR summation is calculated based on the same configuration and test position.

According KDB 648474, the simultaneous transmission SAR was not required, because the all SAR summations are less than 1.6 W/kg.

4. Specific Absorption Rate (SAR)

4.1 Introduction

SAR is related to the rate at which energy is absorbed per unit mass in an object exposed to a radio field. The SAR distribution in a biological body is complicated and is usually carried out by experimental techniques or numerical modeling. The standard recommends limits for two tiers of groups, occupational/controlled and general population/uncontrolled, based on a person's awareness and ability to exercise control over his or her exposure. In general, occupational/controlled exposure limits are higher than the limits for general population/uncontrolled.

4.2 SAR Definition

The SAR definition is the time derivative (rate) of the incremental energy (dW) absorbed by (dissipated in) an incremental mass (dm) contained in a volume element (dv) of a given density (ρ). The equation description is as below:

$$\text{SAR} = \frac{d}{dt} \left(\frac{dW}{dm} \right) = \frac{d}{dt} \left(\frac{dW}{\rho dv} \right)$$

SAR is expressed in units of Watts per kilogram (W/kg)

SAR measurement can be either related to the temperature elevation in tissue by

$$\text{SAR} = C \left(\frac{\delta T}{\delta t} \right)$$

Where: C is the specific heat capacity, δT is the temperature rise and δt is the exposure duration, or related to the electrical field in the tissue by

$$\text{SAR} = \frac{\sigma |E|^2}{\rho}$$

Where: σ is the conductivity of the tissue, ρ is the mass density of the tissue and E is the RMS electrical field strength.

However for evaluating SAR of low power transmitter, electrical field measurement is typically applied.

5. SAR Measurement System

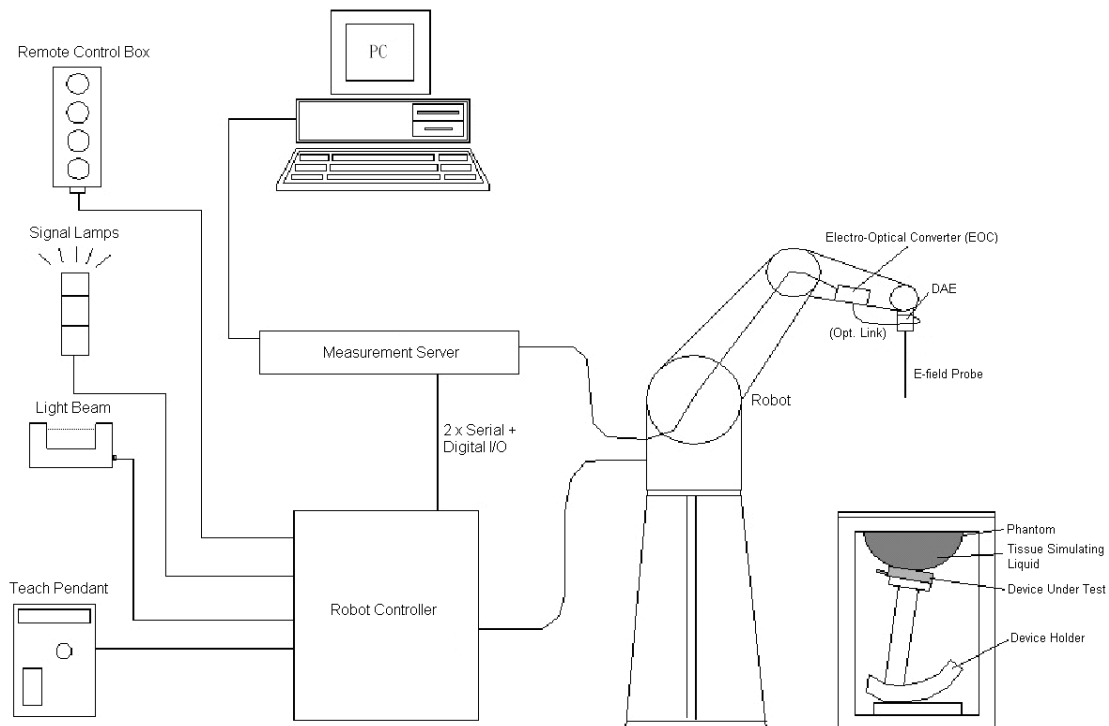

Fig 5.1 SPEAG DASY4 or DASY5 System Configurations

The DASY4 or DASY5 system for performance compliance tests is illustrated above graphically. This system consists of the following items:

- A standard high precision 6-axis robot with controller, a teach pendant and software
- A data acquisition electronic (DAE) attached to the robot arm extension
- A dosimetric probe equipped with an optical surface detector system
- The electro-optical converter (ECO) performs the conversion between optical and electrical signals
- A measurement server performs the time critical tasks such as signal filtering, control of the robot operation and fast movement interrupts.
- A probe alignment unit which improves the accuracy of the probe positioning
- A computer operating Windows XP
- DASY4 or DASY5 software
- Remote control with teach pendant and additional circuitry for robot safety such as warning lamps, etc.
- The SAM twin phantom
- A device holder
- Tissue simulating liquid
- Dipole for evaluating the proper functioning of the system

Some of the components are described in details in the following sub-sections.

5.1 E-Field Probe

The SAR measurement is conducted with the dosimetric probe (manufactured by SPEAG). The probe is specially designed and calibrated for use in liquid with high permittivity. The dosimetric probe has special calibration in liquid at different frequency. This probe has a built in optical surface detection system to prevent from collision with phantom.

5.1.1 E-Field Probe Specification

<ET3DV6>

Construction	Symmetrical design with triangular core Built-in optical fiber for surface detection system. Built-in shielding against static charges. PEEK enclosure material (resistant to organic solvents, e.g., DGBE)
Frequency	10 MHz to 3 GHz; Linearity: ± 0.2 dB
Directivity	± 0.2 dB in HSL (rotation around probe axis) ± 0.4 dB in HSL (rotation normal to probe axis)
Dynamic Range	5 μ W/g to 100 mW/g; Linearity: ± 0.2 dB
Dimensions	Overall length: 330 mm (Tip: 16 mm) Tip diameter: 6.8 mm (Body: 12 mm) Distance from probe tip to dipole centers: 2.7 mm



Fig 5.2 Photo of ET3DV6

<EX3DV4 Probe>

Construction	Symmetrical design with triangular core Built-in shielding against static charges PEEK enclosure material (resistant to organic solvents, e.g., DGBE)
Frequency	10 MHz to 6 GHz; Linearity: ± 0.2 dB
Directivity	± 0.3 dB in HSL (rotation around probe axis) ± 0.5 dB in tissue material (rotation normal to probe axis)
Dynamic Range	10 μ W/g to 100 mW/g; Linearity: ± 0.2 dB (noise: typically < 1 μ W/g)
Dimensions	Overall length: 330 mm (Tip: 20 mm) Tip diameter: 2.5 mm (Body: 12 mm) Typical distance from probe tip to dipole centers: 1 mm



Fig 5.3 Photo of EX3DV4

5.1.2 E-Field Probe Calibration

Each probe needs to be calibrated according to a dosimetric assessment procedure with accuracy better than $\pm 10\%$. The spherical isotropy shall be evaluated and within ± 0.25 dB. The sensitivity parameters (NormX, NormY, and NormZ), the diode compression parameter (DCP) and the conversion factor (ConvF) of the probe are tested. The calibration data can be referred to appendix C of this report.

5.2 Data Acquisition Electronics (DAE)

The data acquisition electronics (DAE) consists of a highly sensitive electrometer-grade preamplifier with auto-zeroing, a channel and gain-switching multiplexer, a fast 16 bit AD-converter and a command decoder and control logic unit. Transmission to the measurement server is accomplished through an optical downlink for data and status information as well as an optical uplink for commands and the clock. The input impedance of the DAE is 200 MOhm; the inputs are symmetrical and floating. Common mode rejection is above 80 dB.



Fig 5.4 Photo of DAE

5.3 Robot

The SPEAG DASY system uses the high precision robots (DASY4: RX90BL; DASY5: TX90XL) type from Stäubli SA (France). For the 6-axis controller system, the robot controller version (DASY4: CS7MB; DASY5: CS8c) from Stäubli is used. The Stäubli robot series have many features that are important for our application:

- High precision (repeatability ± 0.035 mm)
- High reliability (industrial design)
- Jerk-free straight movements
- Low ELF interference (the closed metallic construction shields against motor control fields)



Fig 5.5 Photo of DASY4



Fig 5.6 Photo of DASY5

5.4 Measurement Server

The measurement server is based on a PC/104 CPU board with CPU (DASY4: 166 MHz, Intel Pentium; DASY5: 400 MHz, Intel Celeron), chipdisk (DASY4: 32 MB; DASY5: 128 MB), RAM (DASY4: 64 MB, DASY5: 128 MB). The necessary circuits for communication with the DAE electronic box, as well as the 16 bit AD converter system for optical detection and digital I/O interface are contained on the DASY I/O board, which is directly connected to the PC/104 bus of the CPU board.

The measurement server performs all the real-time data evaluation for field measurements and surface detection, controls robot movements and handles safety operations.



Fig 5.7 Photo of Server for DASY4



Fig 5.8 Photo of Server for DASY5

5.5 Phantom

<SAM Twin Phantom>

Shell Thickness	2 ± 0.2 mm; Center ear point: 6 ± 0.2 mm
Filling Volume	Approx. 25 liters
Dimensions	Length: 1000 mm; Width: 500 mm; Height: adjustable feet
Measurement Areas	Left Hand, Right Hand, Flat Phantom



Fig 5.9 Photo of SAM Phantom

The bottom plate contains three pair of bolts for locking the device holder. The device holder positions are adjusted to the standard measurement positions in the three sections. A white cover is provided to tap the phantom during off-periods to prevent water evaporation and changes in the liquid parameters. On the phantom top, three reference markers are provided to identify the phantom position with respect to the robot.

<ELI4 Phantom>

Shell Thickness	2 ± 0.2 mm (sagging: <1%)
Filling Volume	Approx. 30 liters
Dimensions	Major ellipse axis: 600 mm Minor axis: 400 mm

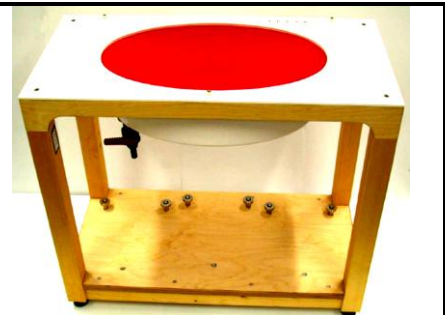

Fig 5.10 Photo of ELI4 Phantom

The ELI4 phantom is intended for compliance testing of handheld and body-mounted wireless devices in the frequency range of 30 MHz to 6 GHz. ELI4 is fully compatible with standard and all known tissue simulating liquids.

5.6 Device Holder

<Device Holder for SAM Twin Phantom>

The SAR in the phantom is approximately inversely proportional to the square of the distance between the source and the liquid surface. For a source at 5 mm distance, a positioning uncertainty of ± 0.5 mm would produce a SAR uncertainty of ± 20 %. Accurate device positioning is therefore crucial for accurate and repeatable measurements. The positions in which the devices must be measured are defined by the standards.

The DASY device holder is designed to cope with different positions given in the standard. It has two scales for the device rotation (with respect to the body axis) and the device inclination (with respect to the line between the ear reference points). The rotation center for both scales is the ear reference point (EPR). Thus the device needs no repositioning when changing the angles.

The DASY device holder is constructed of low-loss POM material having the following dielectric parameters: relative permittivity $\epsilon = 3$ and loss tangent $\delta = 0.02$. The amount of dielectric material has been reduced in the closest vicinity of the device, since measurements have suggested that the influence of the clamp on the test results could thus be lowered.



Fig 5.11 Device Holder

<Laptop Extension Kit>

The extension is lightweight and made of POM, acrylic glass and foam. It fits easily on the upper part of the mounting device in place of the phone positioned. The extension is fully compatible with the SAM Twin and ELI phantoms.

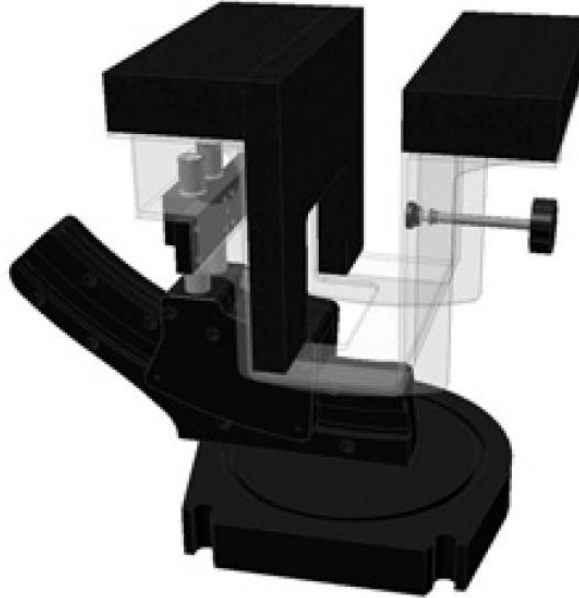

Fig 5.12 Laptop Extension Kit



5.7 Data Storage and Evaluation

5.7.1 Data Storage

The DASY software stores the assessed data from the data acquisition electronics as raw data (in microvolt readings from the probe sensors), together with all the necessary software parameters for the data evaluation (probe calibration data, liquid parameters and device frequency and modulation data) in measurement files. The post-processing software evaluates the desired unit and format for output each time the data is visualized or exported. This allows verification of the complete software setup even after the measurement and allows correction of erroneous parameter settings. For example, if a measurement has been performed with an incorrect crest factor parameter in the device setup, the parameter can be corrected afterwards and the data can be reevaluated.

The measured data can be visualized or exported in different units or formats, depending on the selected probe type (e.g., [V/m], [A/m], [mW/g]). Some of these units are not available in certain situations or give meaningless results, e.g., a SAR-output in a non-lose media, will always be zero. Raw data can also be exported to perform the evaluation with other software packages.

5.7.2 Data Evaluation

The DASY post-processing software (SEMCAD) automatically executes the following procedures to calculate the field units from the microvolt readings at the probe connector. The parameters used in the evaluation are stored in the configuration modules of the software :

Probe parameters :	- Sensitivity	Norm _i , a ₁₀ , a ₁₁ , a ₁₂
	- Conversion factor	ConvF _i
	- Diode compression point	dcp _i
Device parameters :	- Frequency	f
	- Crest factor	cf
Media parameters :	- Conductivity	σ
	- Density	ρ

These parameters must be set correctly in the software. They can be found in the component documents or they can be imported into the software from the configuration files issued for the DASY components. In the direct measuring mode of the multi-meter option, the parameters of the actual system setup are used. In the scan visualization and export modes, the parameters stored in the corresponding document files are used.

The first step of the evaluation is a linearization of the filtered input signal to account for the compression characteristics of the detector diode. The compensation depends on the input signal, the diode type and the DC-transmission factor from the diode to the evaluation electronics. If the exciting field is pulsed, the crest factor of the signal must be known to correctly compensate for peak power.

The formula for each channel can be given as :

$$V_i = U_i + U_i^2 \cdot \frac{cf}{dcp_i}$$

with V_i = compensated signal of channel i, (i = x, y, z)
 U_i = input signal of channel i, (i = x, y, z)
 cf = crest factor of exciting field (DASY parameter)
 dcp_i = diode compression point (DASY parameter)

From the compensated input signals, the primary field data for each channel can be evaluated :

$$\text{E-field Probes : } E_i = \sqrt{\frac{V_i}{\text{Norm}_i \cdot \text{ConvF}}}$$

$$\text{H-field Probes : } H_i = \sqrt{V_i} \cdot \frac{a_{i0} + a_{i1}f + a_{i2}f^2}{f}$$

with V_i = compensated signal of channel i, (i = x, y, z)
 Norm_i = sensor sensitivity of channel i, (i = x, y, z), $\mu\text{V}/(\text{V/m})^2$ for E-field Probes
 ConvF = sensitivity enhancement in solution
 a_{ij} = sensor sensitivity factors for H-field probes
 f = carrier frequency [GHz]
 E_i = electric field strength of channel i in V/m
 H_i = magnetic field strength of channel i in A/m

The RSS value of the field components gives the total field strength (Hermitian magnitude) :

$$E_{\text{tot}} = \sqrt{E_x^2 + E_y^2 + E_z^2}$$

The primary field data are used to calculate the derived field units.

$$\text{SAR} = E_{\text{tot}}^2 \cdot \frac{\sigma}{\rho \cdot 1000}$$

with SAR = local specific absorption rate in mW/g
 E_{tot} = total field strength in V/m
 σ = conductivity in [mho/m] or [Siemens/m]
 ρ = equivalent tissue density in g/cm^3

Note that the density is set to 1, to account for actual head tissue density rather than the density of the tissue simulating liquid.



5.8 Test Equipment List

Manufacturer	Name of Equipment	Type/Model	Serial Number	Calibration	
				Last Cal.	Due Date
SPEAG	Dosimetric E-Field Probe	ET3DV6	1787	May 18, 2010	May 17, 2011
SPEAG	Dosimetric E-Field Probe	ET3DV6	1788	Sep. 21, 2010	Sep. 20, 2011
SPEAG	Dosimetric E-Field Probe	EX3DV4	3731	Sep. 20, 2010	Sep. 19, 2011
SPEAG	750MHz System Validation Kit	D750V3	1012	Jun. 11, 2010	Jun. 10, 2012
SPEAG	835MHz System Validation Kit	D835V2	499	Mar. 22, 2010	Mar. 21, 2012
SPEAG	900MHz System Validation Kit	D900V2	190	Jul. 21, 2009	Jul. 20, 2011
SPEAG	1800MHz System Validation Kit	D1800V2	2d076	Jul. 20, 2009	Jul. 19, 2011
SPEAG	1900MHz System Validation Kit	D1900V2	5d041	Mar. 23, 2010	Mar. 22, 2012
SPEAG	2000MHz System Validation Kit	D2000V2	1010	Sep. 22, 2010	Sep. 21, 2012
SPEAG	2300MHz System Validation Kit	D2300V2	1006	Sep. 24, 2009	Sep. 23, 2011
SPEAG	2450MHz System Validation Kit	D2450V2	736	Jul. 20, 2009	Jul. 19, 2011
SPEAG	2600MHz System Validation Kit	D2600V2	1008	Sep. 24, 2009	Sep. 23, 2011
SPEAG	3500MHz System Validation Kit	D3500V2	1014	Sep. 17, 2009	Sep. 16, 2011
SPEAG	5GHz System Validation Kit	D5GHzV2	1006	Jan. 21, 2010	Jan. 20, 2012
SPEAG	Data Acquisition Electronics	DAE3	577	Aug. 18, 2010	Aug. 17, 2011
SPEAG	Data Acquisition Electronics	DAE4	778	Oct. 22, 2010	Oct. 21, 2011
SPEAG	Device Holder	N/A	N/A	NCR	NCR
SPEAG	SAM Phantom	QD 000 P40 C	TP-1303	NCR	NCR
SPEAG	SAM Phantom	QD 000 P40 C	TP-1383	NCR	NCR
SPEAG	SAM Phantom	QD 000 P40 C	TP-1446	NCR	NCR
SPEAG	SAM Phantom	QD 000 P40 C	TP-1478	NCR	NCR
SPEAG	ELI4 Phantom	QD 0VA 001 BB	1026	NCR	NCR
SPEAG	ELI4 Phantom	QD 0VA 001 BA	1029	NCR	NCR
Agilent	PNA Series Network Analyzer	E8358A	US40260131	May 06, 2010	May 05, 2011
Agilent	Wireless Communication Test Set	E5515C	MY48360820	Jan. 12, 2010	Jan. 11, 2012
Agilent	Wireless Communication Test Set	E5515C	GB46311322	Feb. 16, 2009	Feb. 15, 2011
R&S	Universal Radio Communication Tester	CMU200	117995	Mar. 19, 2009	Mar. 18, 2011
Agilent	Dielectric Probe Kit	85070D	US01440205	NCR	NCR
Agilent	Dual Directional Coupler	778D	50422	NCR	NCR
AR	Power Amplifier	5S1G4M2	0328767	NCR	NCR
R&S	Spectrum Analyzer	FSP7	101131	Mar. 05, 2010	Mar. 04, 2011

Table 5.1 Test Equipment List

Note: The calibration certificate of DASY can be referred to appendix C of this report.

6. Tissue Simulating Liquids

For the measurement of the field distribution inside the SAM phantom with DASY, the phantom must be filled with around 25 liters of homogeneous body tissue simulating liquid. For head SAR testing, the liquid height from the ear reference point (ERP) of the phantom to the liquid top surface is larger than 15 cm, which is shown in Fig. 6.1. For body SAR testing, the liquid height from the center of the flat phantom to the liquid top surface is larger than 15 cm, which is shown in Fig. 6.2.

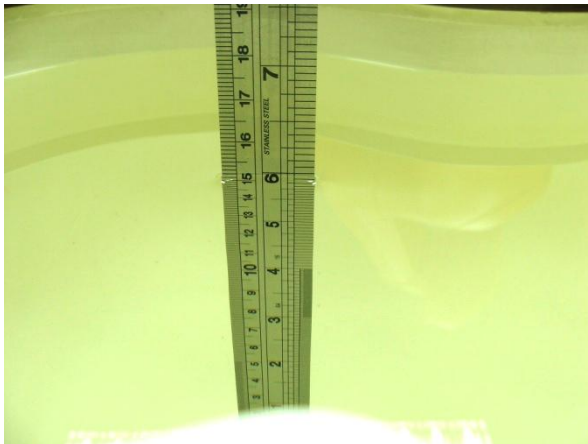

Fig 6.1 Photo of Liquid Height for Head SAR



Fig 6.2 Photo of Liquid Height for Body SAR

The following table gives the targets for tissue simulating liquid.

Frequency (MHz)	Liquid Type	Conductivity (σ)	$\pm 5\%$ Range	Permittivity (ϵ_r)	$\pm 5\%$ Range
2496	Head	1.85	1.76 ~ 1.94	39.14	37.18 ~ 41.10
2593	Head	1.96	1.86 ~ 2.06	39.02	37.07 ~ 40.97
2600	Head	1.96	1.86 ~ 2.06	39.01	37.06 ~ 40.96
2690	Head	2.06	1.96 ~ 2.16	38.89	36.95 ~ 40.83
2496	Body	2.02	1.92 ~ 2.12	52.64	50.01 ~ 55.27
2593	Body	2.15	2.04 ~ 2.26	52.52	49.89 ~ 55.15
2600	Body	2.16	2.05 ~ 2.27	52.51	49.88 ~ 55.14
2690	Body	2.29	2.18 ~ 2.40	52.39	49.77 ~ 55.01

Table 6.1 Targets of Tissue Simulating Liquid

The dielectric parameters of the liquids were verified prior to the SAR evaluation using an Agilent 85070D Dielectric Probe Kit and an Agilent Network Analyzer.



The following table shows the measuring results for simulating liquid.

Band	Liquid Type	Temperature (°C)	Frequency (MHz)	Conductivity (σ)	Permittivity (ϵ_r)	Measurement Date
2600	Body	21.2	2498.5	2.097	51.31	Nov. 20, 2010
			2501.0	2.099	51.31	
			2593.0	2.200	51.11	
			2685.0	2.253	50.86	
			2687.5	2.256	50.86	
2600	Body	21.0	2498.5	2.054	54.01	Nov. 22, 2010
			2501.0	2.057	54.01	
			2593.0	2.157	53.81	
			2685.0	2.208	53.56	
			2687.5	2.212	53.56	

Table 6.2 Measuring Results for Simulating Liquid

7. Uncertainty Assessment

The component of uncertainty may generally be categorized according to the methods used to evaluate them. The evaluation of uncertainty by the statistical analysis of a series of observations is termed a Type A evaluation of uncertainty. The evaluation of uncertainty by means other than the statistical analysis of a series of observation is termed a Type B evaluation of uncertainty. Each component of uncertainty, however evaluated, is represented by an estimated standard deviation, termed standard uncertainty, which is determined by the positive square root of the estimated variance.

A Type A evaluation of standard uncertainty may be based on any valid statistical method for treating data. This includes calculating the standard deviation of the mean of a series of independent observations; using the method of least squares to fit a curve to the data in order to estimate the parameter of the curve and their standard deviations; or carrying out an analysis of variance in order to identify and quantify random effects in certain kinds of measurement.

A type B evaluation of standard uncertainty is typically based on scientific judgment using all of the relevant information available. These may include previous measurement data, experience and knowledge of the behavior and properties of relevant materials and instruments, manufacture’s specification, data provided in calibration reports and uncertainties assigned to reference data taken from handbooks. Broadly speaking, the uncertainty is either obtained from an outdoor source or obtained from an assumed distribution, such as the normal distribution, rectangular or triangular distributions indicated in Table 7.1

Uncertainty Distributions	Normal	Rectangular	Triangular	U-Shape
Multi-plying Factor ^(a)	1/k ^(b)	1/√3	1/√6	1/√2

(a) standard uncertainty is determined as the product of the multiplying factor and the estimated range of variations in the measured quantity

(b) κ is the coverage factor

Table 7.1 Standard Uncertainty for Assumed Distribution

The combined standard uncertainty of the measurement result represents the estimated standard deviation of the result. It is obtained by combining the individual standard uncertainties of both Type A and Type B evaluation using the usual “root-sum-squares” (RSS) methods of combining standard deviations by taking the positive square root of the estimated variances.

Expanded uncertainty is a measure of uncertainty that defines an interval about the measurement result within which the measured value is confidently believed to lie. It is obtained by multiplying the combined standard uncertainty by a coverage factor. Typically, the coverage factor ranges from 2 to 3. Using a coverage factor allows the true value of a measured quantity to be specified with a defined probability within the specified uncertainty range. For purpose of this document, a coverage factor two is used, which corresponds to confidence interval of about 95 %. The DASY uncertainty Budget is showed in Table 7.2 and Table 7.3.



Error Description	Uncertainty Value (±%)	Probability Distribution	Divisor	Ci (1g)	Standard Uncertainty (1g)
Measurement System					
Probe Calibration	5.5	Normal	1	1	± 5.5 %
Axial Isotropy	4.7	Rectangular	√3	0.7	± 1.9 %
Hemispherical Isotropy	9.6	Rectangular	√3	0.7	± 3.9 %
Boundary Effects	1.0	Rectangular	√3	1	± 0.6 %
Linearity	4.7	Rectangular	√3	1	± 2.7 %
System Detection Limits	1.0	Rectangular	√3	1	± 0.6 %
Readout Electronics	0.3	Normal	1	1	± 0.3 %
Response Time	0.8	Rectangular	√3	1	± 0.5 %
Integration Time	2.6	Rectangular	√3	1	± 1.5 %
RF Ambient Noise	3.0	Rectangular	√3	1	± 1.7 %
RF Ambient Reflections	3.0	Rectangular	√3	1	± 1.7 %
Probe Positioner	0.4	Rectangular	√3	1	± 0.2 %
Probe Positioning	2.9	Rectangular	√3	1	± 1.7 %
Max. SAR Eval.	1.0	Rectangular	√3	1	± 0.6 %
Test Sample Related					
Device Positioning	2.9	Normal	1	1	± 2.9 %
Device Holder	3.6	Normal	1	1	± 3.6 %
Power Drift	5.0	Rectangular	√3	1	± 2.9 %
Phantom and Setup					
Phantom Uncertainty	4.0	Rectangular	√3	1	± 2.3 %
Liquid Conductivity (Target)	5.0	Rectangular	√3	0.64	± 1.8 %
Liquid Conductivity (Meas.)	2.5	Normal	1	0.64	± 1.6 %
Liquid Permittivity (Target)	5.0	Rectangular	√3	0.6	± 1.7 %
Liquid Permittivity (Meas.)	2.5	Normal	1	0.6	± 1.5 %
Combined Standard Uncertainty					± 10.7 %
Coverage Factor for 95 %					K = 2
Expanded Uncertainty					± 21.4 %

Table 7.2 Uncertainty Budget of DASY for frequency range 300 MHz to 3 GHz



Error Description	Uncertainty Value (±%)	Probability Distribution	Divisor	Ci (1g)	Standard Uncertainty (1g)
Measurement System					
Probe Calibration	6.55	Normal	1	1	± 6.55 %
Axial Isotropy	4.7	Rectangular	√3	0.7	± 1.9 %
Hemispherical Isotropy	9.6	Rectangular	√3	0.7	± 3.9 %
Boundary Effects	2.0	Rectangular	√3	1	± 1.2 %
Linearity	4.7	Rectangular	√3	1	± 2.7 %
System Detection Limits	1.0	Rectangular	√3	1	± 0.6 %
Readout Electronics	0.3	Normal	1	1	± 0.3 %
Response Time	0.8	Rectangular	√3	1	± 0.5 %
Integration Time	2.6	Rectangular	√3	1	± 1.5 %
RF Ambient Noise	3.0	Rectangular	√3	1	± 1.7 %
RF Ambient Reflections	3.0	Rectangular	√3	1	± 1.7 %
Probe Positioner	0.8	Rectangular	√3	1	± 0.5 %
Probe Positioning	9.9	Rectangular	√3	1	± 5.7 %
Max. SAR Eval.	4.0	Rectangular	√3	1	± 2.3 %
Test Sample Related					
Device Positioning	2.9	Normal	1	1	± 2.9 %
Device Holder	3.6	Normal	1	1	± 3.6 %
Power Drift	5.0	Rectangular	√3	1	± 2.9 %
Phantom and Setup					
Phantom Uncertainty	4.0	Rectangular	√3	1	± 2.3 %
Liquid Conductivity (Target)	5.0	Rectangular	√3	0.43	± 1.8 %
Liquid Conductivity (Meas.)	2.5	Normal	1	0.43	± 1.6 %
Liquid Permittivity (Target)	5.0	Rectangular	√3	0.49	± 1.7 %
Liquid Permittivity (Meas.)	2.5	Normal	1	0.49	± 1.5 %
Combined Standard Uncertainty					± 12.8 %
Coverage Factor for 95 %					K = 2
Expanded Uncertainty					± 25.6 %

Table 7.3 Uncertainty Budget of DASY for frequency range 3 GHz to 6 GHz

8. SAR Measurement Evaluation

Each DASY system is equipped with one or more system validation kits. These units, together with the predefined measurement procedures within the DASY software, enable the user to conduct the system performance check and system validation. System validation kit includes a dipole, tripod holder to fix it underneath the flat phantom and a corresponding distance holder.

8.1 Purpose of System Performance check

The system performance check verifies that the system operates within its specifications. System and operator errors can be detected and corrected. It is recommended that the system performance check be performed prior to any usage of the system in order to guarantee reproducible results. The system performance check uses normal SAR measurements in a simplified setup with a well characterized source. This setup was selected to give a high sensitivity to all parameters that might fail or vary over time. The system check does not intend to replace the calibration of the components, but indicates situations where the system uncertainty is exceeded due to drift or failure.

8.2 System Setup

In the simplified setup for system evaluation, the DUT is replaced by a calibrated dipole and the power source is replaced by a continuous wave that comes from a signal generator. The calibrated dipole must be placed beneath the flat phantom section of the SAM twin phantom with the correct distance holder. The distance holder should touch the phantom surface with a light pressure at the reference marking and be oriented parallel to the long side of the phantom. The equipment setup is shown below:

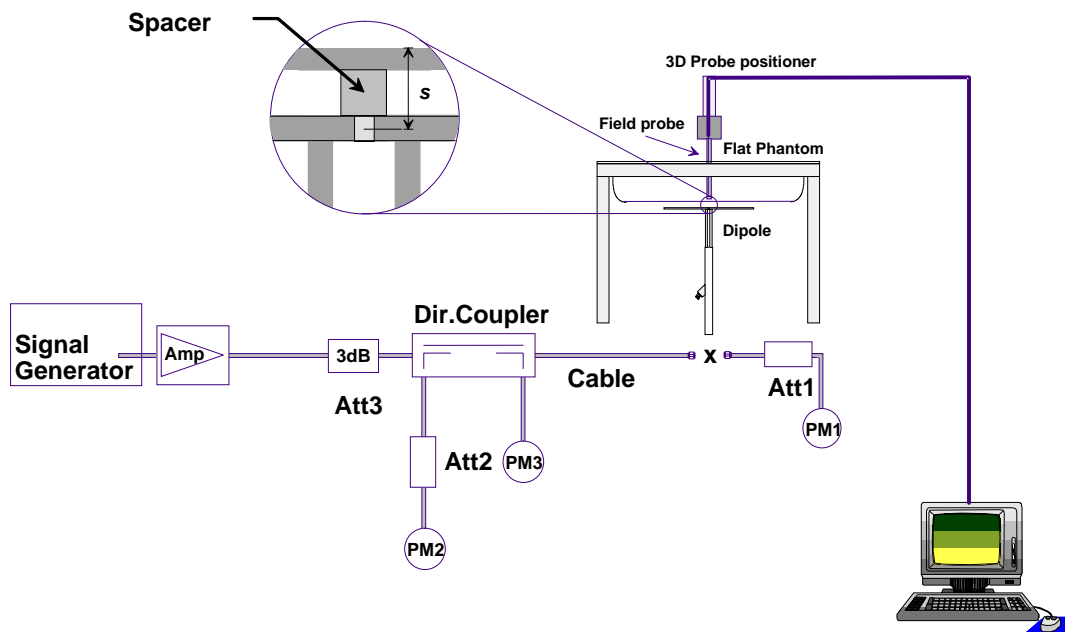

Fig 8.1 System Setup for System Evaluation

1. Signal Generator
2. Amplifier
3. Directional Coupler
4. Power Meter
5. Calibrated Dipole

The output power on dipole port must be calibrated to 20 dBm (100 mW) before dipole is connected.

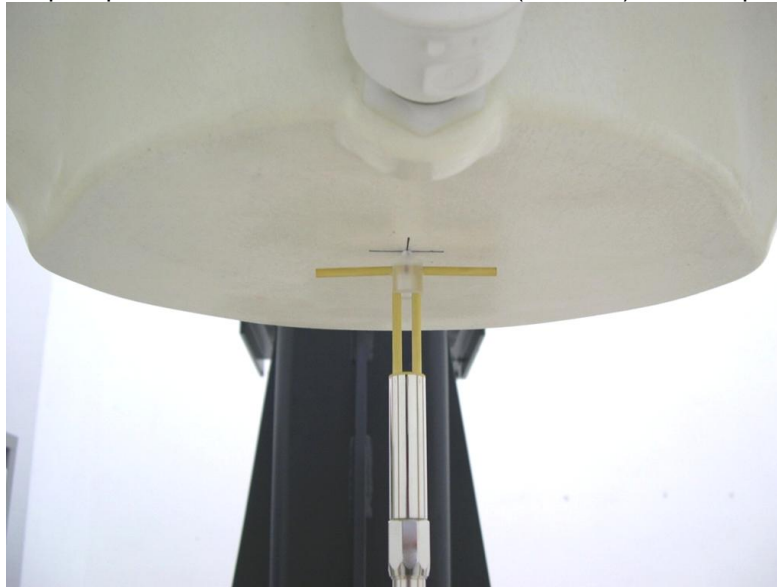

Fig 8.2 Photo of Dipole Setup

8.3 Validation Results

Comparing to the original SAR value provided by SPEAG, the validation data should be within its specification of 10 %. Table 8.1 shows the target SAR and measured SAR after normalized to 1W input power. The table below indicates the system performance check can meet the variation criterion and the plots can be referred to Appendix A of this report.

Measurement Date	Frequency (MHz)	Targeted SAR _{1g} (W/kg)	Measured SAR _{1g} (W/kg)	Deviation (%)
Nov. 20, 2010	2600	57.90	59.40	2.59
Nov. 22, 2010	2600	57.90	58.80	1.55

Table 8.1 Target and Measurement SAR after Normalized



9. DUT Testing Position

This DUT was tested in six different positions. They are front face of the DUT with phantom 1.0 cm gap, rear face of the DUT with phantom 1.0 cm gap, right side of the DUT with phantom 1.0 cm gap, left side of the DUT with phantom 1.0 cm gap, top side of the DUT with phantom 1.0 cm gap, and bottom side of the DUT with phantom 1.0 cm gap. Please refer to Appendix E for the test setup photos.



10. Measurement Procedures

The measurement procedures are as follows:

- (a) Use engineering software to transmit RF power continuously (continuous Tx) in the highest power channel
- (b) Measure output power through RF cable and power meter
- (c) Place the DUT in the positions described in the last section
- (d) Set scan area, grid size and other setting on the DASY software
- (e) Taking data for the middle channel on each testing position
- (f) Find out the largest SAR result on these testing positions
- (g) Measure SAR results for other channels in worst SAR testing position if the SAR of highest power channel is larger than 0.8 W/kg

According to the test standard, the recommended procedure for assessing the peak spatial-average SAR value consists of the following steps:

- (a) Power reference measurement
- (b) Area scan
- (c) Zoom scan
- (d) Power drift measurement

10.1 Spatial Peak SAR Evaluation

The procedure for spatial peak SAR evaluation has been implemented according to the test standard. It can be conducted for 1g and 10g, as well as for user-specific masses. The DASY software includes all numerical procedures necessary to evaluate the spatial peak SAR value.

The base for the evaluation is a "cube" measurement. The measured volume must include the 1g and 10g cubes with the highest averaged SAR values. For that purpose, the center of the measured volume is aligned to the interpolated peak SAR value of a previously performed area scan.

The entire evaluation of the spatial peak values is performed within the post-processing engine (SEMCAD). The system always gives the maximum values for the 1g and 10g cubes. The algorithm to find the cube with highest averaged SAR is divided into the following stages:

- (a) Extraction of the measured data (grid and values) from the Zoom Scan
- (b) Calculation of the SAR value at every measurement point based on all stored data (A/D values and measurement parameters)
- (c) Generation of a high-resolution mesh within the measured volume
- (d) Interpolation of all measured values from the measurement grid to the high-resolution grid
- (e) Extrapolation of the entire 3-D field distribution to the phantom surface over the distance from sensor to surface
- (f) Calculation of the averaged SAR within masses of 1g and 10g



10.2 Scan Procedures

First Area Scan is used to locate the approximate location(s) of the local peak SAR value(s). The measurement grid within an Area Scan is defined by the grid extent, grid step size and grid offset. Next, in order to determine the EM field distribution in a three-dimensional spatial extension, Zoom Scan is required. The Zoom Scan measures 5x5x7 points with step size 8, 8 and 5 mm for 300 MHz to 3 GHz, and 8x8x8 points with step size 4.3, 4.3 and 3 mm for 3 GHz to 6 GHz. The Zoom Scan is performed around the highest E-field value to determine the averaged SAR-distribution over 10 g.

10.3 SAR Averaged Methods

In DASy, the interpolation and extrapolation are both based on the modified Quadratic Shepard's method. The interpolation scheme combines a least-square fitted function method and a weighted average method which are the two basic types of computational interpolation and approximation.

Extrapolation routines are used to obtain SAR values between the lowest measurement points and the inner phantom surface. The extrapolation distance is determined by the surface detection distance and the probe sensor offset. The uncertainty increases with the extrapolation distance. To keep the uncertainty within 1% for the 1 g and 10 g cubes, the extrapolation distance should not be larger than 5 mm.



11. SAR Test Results

11.1 Conducted Power (Unit: dBm)

Zone Type	Modulation	Coding Rate	Frequency	Main Antenna			Aux. Antenna		
				Peak Power	Average Power	PAPR	Peak Power	Average Power	PAPR
PUSC	QPSK (BW 5MHz)	1/2	2498.5	31.37	23.37	8.00	31.27	23.46	7.81
			2593.0	31.11	23.73	7.38	31.26	23.84	7.42
			2687.5	30.30	22.93	7.37	30.59	23.03	7.56
		3/4	2498.5	31.40	23.57	7.83	31.22	23.58	7.64
			2593.0	31.11	23.69	7.42	31.22	23.83	7.39
			2687.5	30.28	23.07	7.21	30.55	23.05	7.50
	16QAM (BW 5MHz)	1/2	2498.5	31.35	23.55	7.80	31.08	23.53	7.55
			2593.0	31.05	23.67	7.38	31.19	23.82	7.37
			2687.5	30.23	23.05	7.18	30.51	23.06	7.45
		3/4	2498.5	31.19	23.42	7.77	31.06	23.57	7.49
			2593.0	31.10	23.65	7.45	31.13	23.80	7.33
			2687.5	30.17	23.10	7.07	30.50	23.11	7.39
	QPSK (BW 10MHz)	1/2	2501.0	31.08	23.38	7.70	30.99	23.45	7.54
			2593.0	31.01	23.63	7.38	31.11	23.76	7.35
			2685.0	30.25	23.64	6.61	30.44	23.05	7.39
		3/4	2501.0	31.12	23.42	7.70	31.04	23.48	7.56
			2593.0	30.95	23.59	7.36	31.11	23.75	7.36
			2685.0	30.27	23.61	6.66	30.43	23.03	7.40
	16QAM (BW 10MHz)	1/2	2501.0	31.16	23.44	7.72	30.87	23.39	7.48
			2593.0	30.90	23.58	7.32	31.07	23.74	7.33
			2685.0	30.25	23.59	6.66	30.43	23.06	7.37
		3/4	2501.0	31.30	23.49	7.81	31.14	23.55	7.59
			2593.0	31.06	23.55	7.51	31.21	23.72	7.49
			2685.0	30.30	23.59	6.71	30.55	23.10	7.45

Note: PAPR = Peak to Average Ratio



11.2 Scaling Factor Deriving

The testing was done at DL:UL symbol ratio, 29:18 as this is the maximum achievable ratio for the product. The 18 indicates the number of uplink symbols. Inside the uplink, 15 of the symbols are used for data, and 3 of the symbols are used for sending control information to the network. During the testing, the control symbols contained no information, so did not contribute to the total energy transmitted. To compensate for the maximum energy which may presented in the 3 control symbols, following scheme is used for the up scaling.

<Scaling Factor for 5MHz BW>

This device is power class 2 device and the maximum power tolerance is 24.0dBm.

The maximum rated output power of 5M BW is 24.0 dBm (251.19 mW).

Maximum power in 5M control traffic is 73.88 mW (5/17 of 251.19 mW).

$$\text{Scaling Factor} = (3 * 73.88 + 15 * 251.19) / (15 * \text{max. measured power of the channel tested})$$

$$= 3989.49 / (15 * \text{max. measured power of the channel tested})$$

For Main Antenna

Zone Type	Modulation	Coding Rate	Frequency (MHz)	Average Power for Aux. Antenna		Scaling Factor
				(dBm)	(mW)	
PUSC	QPSK (BW 5MHz)	1/2	2498.5	23.37	217.27	1.22
			2593.0	23.73	236.05	1.13
			2687.5	22.93	196.34	1.35
		3/4	2498.5	23.57	227.51	1.17
			2593.0	23.69	233.88	1.14
			2687.5	23.07	202.77	1.31
	16QAM (BW 5MHz)	1/2	2498.5	23.55	226.46	1.17
			2593.0	23.67	232.81	1.14
			2687.5	23.05	201.84	1.32
		3/4	2498.5	23.42	219.79	1.21
			2593.0	23.65	231.74	1.15
			2687.5	23.10	204.17	1.30

For Aux. Antenna

Zone Type	Modulation	Coding Rate	Frequency (MHz)	Average Power for Main Antenna		Scaling Factor
				(dBm)	(mW)	
PUSC	QPSK (BW 5MHz)	1/2	2498.5	23.46	221.82	1.20
			2593.0	23.84	242.10	1.10
			2687.5	23.03	200.91	1.32
		3/4	2498.5	23.58	228.03	1.17
			2593.0	23.83	241.55	1.10
			2687.5	23.05	201.84	1.32
	16QAM (BW 5MHz)	1/2	2498.5	23.53	225.42	1.18
			2593.0	23.82	240.99	1.10
			2687.5	23.06	202.30	1.31
		3/4	2498.5	23.57	227.51	1.17
			2593.0	23.80	239.88	1.11
			2687.5	23.11	204.64	1.30

<Scaling Factor for 10MHz BW>

This device is power class 2 device and the maximum power tolerance is 24.0dBm.

The maximum rated output power of 5M BW is 24.0 dBm (251.19 mW).

Maximum power in 10M control traffic is 35.88 mW (5/35 of 251.19 mW).

$$\text{Scaling Factor} = (3 * 35.88 + 15 * 251.19) / (15 * \text{max. measured power of the channel tested})$$

$$= 3875.49 / (15 * \text{max. measured power of the channel tested})$$

For Main Antenna

Zone Type	Modulation	Coding Rate	Frequency (MHz)	Average Power for Aux. Antenna		Scaling Factor
				(dBm)	(mW)	
PUSC	QPSK (BW 10MHz)	1/2	2501.0	23.38	217.77	1.19
			2593.0	23.63	230.67	1.12
			2685.0	23.64	231.21	1.12
		3/4	2501.0	23.42	219.79	1.18
			2593.0	23.59	228.56	1.13
			2685.0	23.61	229.61	1.13
	16QAM (BW 10MHz)	1/2	2501.0	23.44	220.80	1.17
			2593.0	23.58	228.03	1.13
			2685.0	23.59	228.56	1.13
		3/4	2501.0	23.49	223.36	1.16
			2593.0	23.55	226.46	1.14
			2685.0	23.59	228.56	1.13

For Aux. Antenna

Zone Type	Modulation	Coding Rate	Frequency (MHz)	Average Power for Main Antenna		Scaling Factor
				(dBm)	(mW)	
PUSC	QPSK (BW 10MHz)	1/2	2501.0	23.45	221.31	1.17
			2593.0	23.76	237.68	1.09
			2685.0	23.05	201.84	1.28
		3/4	2501.0	23.48	222.84	1.16
			2593.0	23.75	237.14	1.09
			2685.0	23.03	200.91	1.29
	16QAM (BW 10MHz)	1/2	2501.0	23.39	218.27	1.18
			2593.0	23.74	236.59	1.09
			2685.0	23.06	202.30	1.28
		3/4	2501.0	23.55	226.46	1.14
			2593.0	23.72	235.50	1.10
			2685.0	23.10	204.17	1.27

<Scaling Up SAR>

Calculating used follow scheme for scale up SAR.

$$\text{Scaled SAR} = \text{Measured SAR} * \text{Scaling Factor}$$



11.3 Test Records for Body SAR Test

Plot No.	Modulation	Coding Rate	BW (MHz)	Frequency (MHz)	Test Position	Separation Distance (cm)	Ant.	SAR _{1g} (W/kg)	Scaling Factor	Scaling SAR
#10	QPSK	1/2	5M	2593.0	Front Face	1	Main	0.598	1.13	0.676
#11	QPSK	1/2	5M	2593.0	Rear Face	1	Main	0.286	1.13	0.323
#12	QPSK	1/2	5M	2593.0	Right Side	1	Main	0.164	1.13	0.185
#13	QPSK	1/2	5M	2593.0	Left Side	1	Main	0.180	1.13	0.203
#14	QPSK	1/2	5M	2593.0	Top Side	1	Main	0.410	1.13	0.463
#01	QPSK	1/2	5M	2593.0	Front Face	1	Aux	0.820	1.10	0.902
#02	QPSK	1/2	5M	2593.0	Rear Face	1	Aux	0.177	1.10	0.195
#03	QPSK	1/2	5M	2593.0	Right Side	1	Aux	0.789	1.10	0.868
#07	QPSK	1/2	5M	2498.5	Front Face	1	Aux	0.221	1.20	0.265
#08	QPSK	1/2	5M	2687.5	Front Face	1	Aux	0.691	1.32	0.912
#09	16QAM	1/2	5M	2593.0	Front Face	1	Aux	0.830	1.10	0.913
#28	QPSK	1/2	10M	2685.0	Front Face	1	Main	0.647	1.12	0.725
#29	QPSK	1/2	10M	2685.0	Rear Face	1	Main	0.271	1.12	0.304
#30	QPSK	1/2	10M	2685.0	Right Side	1	Main	0.180	1.12	0.202
#31	QPSK	1/2	10M	2685.0	Left Side	1	Main	0.167	1.12	0.187
#32	QPSK	1/2	10M	2685.0	Top Side	1	Main	0.447	1.12	0.501
#19	QPSK	1/2	10M	2593.0	Front Face	1	Aux	0.844	1.09	0.920
#20	QPSK	1/2	10M	2593.0	Rear Face	1	Aux	0.182	1.09	0.198
#21	QPSK	1/2	10M	2593.0	Right Side	1	Aux	0.820	1.09	0.894
#25	QPSK	1/2	10M	2501.0	Front Face	1	Aux	0.298	1.17	0.349
#26	QPSK	1/2	10M	2685.0	Front Face	1	Aux	0.666	1.28	0.852
#27	16QAM	1/2	10M	2593.0	Front Face	1	Aux	0.819	1.09	0.893

Remark:

1. The WiMAX SAR test reduction is referred 2010 TCB Workshop RF Exposure Procedures-Review.
 - a. Use the lowest coding rate for each modulation when the same rated maximum output applies to all coding rates in a modulation
 - b. Test higher coding rates only if the rated maximum output is higher
 - c. Use the scaled SAR to determine test reduction (< 0.8 W/kg etc.)
 - d. For each channel bandwidth, if 16QAM maximum output power is <= 1/4 dB higher than QPSK and QPSK SAR is < 0.8 W/kg, 16QAM SAR is not needed
 - e. QPSK SAR is between 0.8 and 1.2 W/kg, test 16QAM using the highest SAR channel in QPSK
2. According to October 2010 TCB Workshop RF Exposure Procedures Update, the Main Ant SAR for hotspot mode only Front Face, Rear Face, Right Side, Left Side, and Top Side are needed due to the antenna location is within 2.5 cm from the edge.
3. According to October 2010 TCB Workshop RF Exposure Procedures Update, the Aux Ant SAR for hotspot mode only Front Face, Rear Face, and Right Side are needed due to the antenna location is within 2.5 cm from the edge.
4. The DASY4 system was used for WiMAX body SAR testing.

Test Engineer : Andy He and Robert Liu

11.4 Linearity Response Check

<Setup and Calculation Procedure>

Set up the DUT in the position of the worst SAR, i.e. Front Face of DUT, and keep the separation distance as 1.0 cm. The channel of maximum SAR for each Modulation/Bandwidth is chosen for single point peak SAR testing. Set the software to configure the device to transmit at specified power and check by Anritus wideband power meter. Using the same setup as complete 1g SAR and move probe to peak SAR location, then run multi-meter job and record the SAR value.

The reference line is based on the SAR at the power of 12.5 mW, and the proportional SARs of its multiples of 12.5 mW. The measured SAR at different multiple power of 12.5 mW is also plotted. The deviation is the difference between the reference line and the measured SAR.

The example for QPSK 1/2, BW 5M, 2687.5MHz is as below:

Base value = SAR measured at power of 12.5 mW = 0.057

2nd point (25 mW) = SAR value of 0.057 * (25 / 12.5) = 0.114

3rd point (50 mW) = SAR value of 0.057 * (50 / 12.5) = 0.228

4th point (100 mW) = SAR value of 0.057 * (100 / 12.5) = 0.456

5th point (200 mW) = SAR value of 0.057 * (200 / 12.5) = 0.912

<For QPSK, 1/2, BW 5M, Ch1, Front Face of the DUT, WiMAX Aux Antenna, Configuration #01>

Average Power (mW)	12.5	25.0	50.0	100.0	200
Single Point SAR (W/kg)	0.057	0.117	0.232	0.466	0.92
Reference Line (W/kg)	0.057	0.114	0.228	0.456	0.912
Deviation (%)	0.00%	2.63%	1.75%	2.19%	0.88%

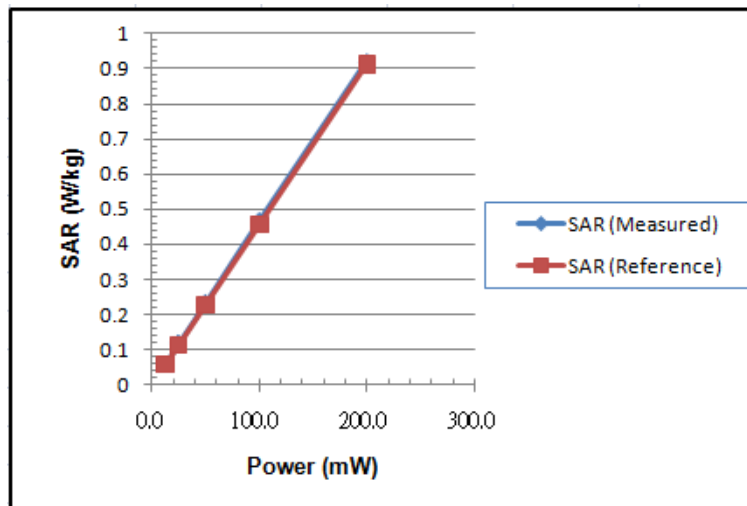

<For 16QAM, 1/2, BW 5M, Ch1, Front Face of the DUT, WiMAX Aux Antenna, Configuration #09>

Average Power (mW)	12.5	25.0	50.0	100.0	200
Single Point SAR (W/kg)	0.057	0.12	0.235	0.467	0.931
Reference Line (W/kg)	0.057	0.114	0.228	0.456	0.912
Deviation (%)	0.00%	5.26%	3.07%	2.41%	2.08%

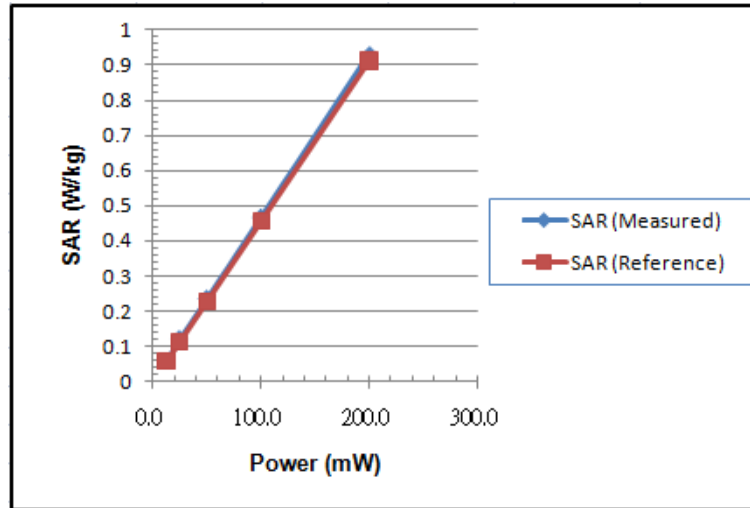

<For QPSK, 1/2, BW 10M, Ch1, Front Face of the DUT, WiMAX Aux Antenna, Configuration #19>

Average Power (mW)	12.5	25.0	50.0	100.0	200
Single Point SAR (W/kg)	0.059	0.12	0.242	0.484	0.964
Reference Line (W/kg)	0.059	0.118	0.236	0.472	0.944
Deviation (%)	0.00%	1.69%	2.54%	2.54%	2.12%

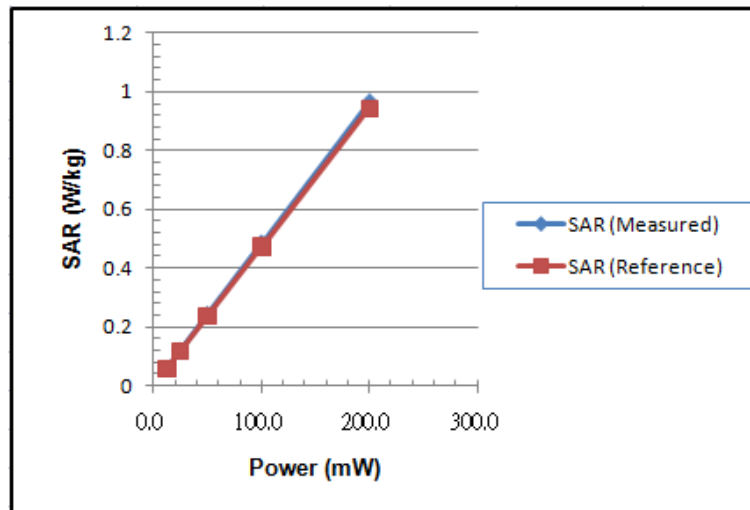

<For 16QAM, 1/2, BW 10M, Ch1, Front Face of the DUT, WiMAX Aux Antenna, Configuration #27>

Average Power (mW)	12.5	25.0	50.0	100.0	200
Single Point SAR (W/kg)	0.056	0.117	0.231	0.453	0.903
Reference Line (W/kg)	0.056	0.112	0.224	0.448	0.896
Deviation (%)	0.00%	4.46%	3.13%	1.12%	0.78%

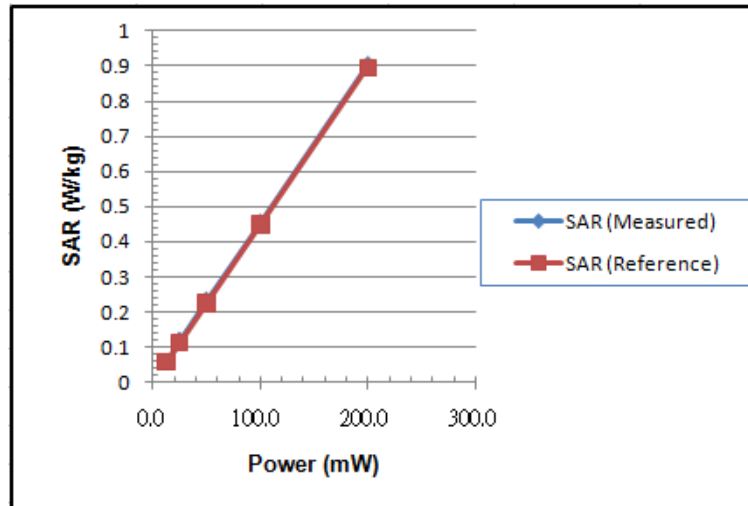

<Conclusion>

From the above test results, the SAR probe can measure SAR correctly under high PAPR of OFDM/OFDMA, and the pretest SAR is not underestimated.

11.5 Compare with Different Scan Resolution

Retest the maximum raw 1g SAR with the same DUT setting on the different scan resolution. The test results are shown as below.

Scan Resolution (mm)	Measured SAR_{1g} (W/kg)
5.0	0.844
2.5	0.88

<Conclusion>

From the above test results, the different scan resolution has no significant change.



12. References

- [1] FCC 47 CFR Part 2 "Frequency Allocations and Radio Treaty Matters; General Rules and Regulations"
- [2] IEEE Std. C95.1-1999, "IEEE Standard for Safety Levels with Respect to Human Exposure to Radio Frequency Electromagnetic Fields, 3 kHz to 300 GHz", 1999
- [3] IEEE Std. 1528-2003, "Recommended Practice for Determining the Peak Spatial-Average Specific Absorption Rate (SAR) in the Human Head from Wireless Communications Devices: Measurement Techniques", December 2003
- [4] FCC OET Bulletin 65 (Edition 97-01) Supplement C (Edition 01-01), "Evaluating Compliance with FCC Guidelines for Human Exposure to Radiofrequency Electromagnetic Fields", June 2001
- [5] SPEAG DASY System Handbook
- [6] FCC KDB 248227 D01 v01r02, "SAR Measurement Procedures for 802.11 a/b/g Transmitters", May 2007
- [7] FCC KDB 447498 D01 v04, "Mobile and Portable Device RF Exposure Procedures and Equipment Authorization Policies", November 2009
- [8] FCC KDB 447498 D02 v02, "SAR Measurement Procedures for USB Dongle Transmitters", November 2009
- [9] FCC KDB 616217 D01 v01r01, "SAR Evaluation Considerations for Laptop Computers with Antennas Built-in on Display Screens", November 2009
- [10] FCC KDB 616217 D03 v01, "SAR Evaluation Considerations for Laptop/Notebook/Netbook and Tablet Computers", November 2009
- [11] FCC KDB 648474 D01 v01r05, "SAR Evaluation Considerations for Handsets with Multiple Transmitters and Antennas", September 2008
- [12] FCC KDB 941225 D01 v02, "SAR Measurement Procedures for 3G Devices – CDMA 2000 / Ev-Do / WCDMA / HSDPA / HSPA", October 2007
- [13] FCC KDB 941225 D03 v01, "Recommended SAR Test Reduction Procedures for GSM / GPRS / EDGE", December 2008



Appendix A. Plots of System Performance Check

The plots are shown as follows.



Appendix B. Plots of SAR Measurement

The plots are shown as follows.



Appendix C. DASYS Calibration Certificate

The DASYS calibration certificates are shown as follows.