

# FCC RF Test Report

**APPLICANT** : Green Packet Berhad, Taiwan  
**EQUIPMENT** : Portable WiMAX WiFi Router  
**BRAND NAME** : Green Packet  
**MODEL NAME** : MF-250  
**FCC ID** : W9V-MF250-GP  
**STANDARD** : FCC Part 15 Subpart C §15.247  
**CLASSIFICATION** : Digital Transmission System (DTS)

The product was received on Oct. 06, 2010 and completely tested on Nov. 24, 2010 . We, SPORTON INTERNATIONAL INC., would like to declare that the tested sample has been evaluated in accordance with the procedures given in ANSI C63.4-2003 and shown the compliance with the applicable technical standards.

The test results in this report apply exclusively to the tested model / sample. Without written approval of SPORTON INTERNATIONAL INC., the test report shall not be reproduced except in full.

Reviewed by:



Anderson Chiu / Deputy Manager



## **SPORTON INTERNATIONAL INC.**

**No. 52, Hwa Ya 1<sup>st</sup> Rd., Hwa Ya Technology Park, Kwei-Shan Hsiang, Tao Yuan Hsien, Taiwan, R.O.C.**



# TABLE OF CONTENTS

**REVISION HISTORY ..... 3**

**SUMMARY OF TEST RESULT ..... 4**

**1 GENERAL DESCRIPTION ..... 5**

    1.1 Applicant ..... 5

    1.2 Manufacturer ..... 5

    1.3 Feature of Equipment Under Test ..... 5

    1.4 Testing Site ..... 6

    1.5 Applied Standards ..... 6

    1.6 Ancillary Equipment List ..... 6

**2 TEST CONFIGURATION OF EQUIPMENT UNDER TEST ..... 7**

    2.1 RF Power ..... 7

    2.2 Test Mode ..... 8

    2.3 Connection Diagram of Test System ..... 9

    2.4 RF Utility ..... 9

**3 TEST RESULT ..... 10**

    3.1 6dB Bandwidth Measurement ..... 10

    3.2 Output Power Measurement ..... 15

    3.3 Band Edges Measurement ..... 17

    3.4 Spurious Emission Measurement ..... 23

    3.5 Power Spectral Density Measurement ..... 30

    3.6 AC Conducted Emission Measurement ..... 35

    3.7 Radiated Emission Measurement ..... 39

    3.8 Antenna Requirements ..... 54

**4 LIST OF MEASURING EQUIPMENT ..... 55**

**5 UNCERTAINTY OF EVALUATION ..... 56**

**APPENDIX A. PHOTOGRAPHS OF EUT**

**APPENDIX B. SETUP PHOTOGRAPHS**



## SUMMARY OF TEST RESULT

Report Section	FCC Rule	IC Rule	Description	Limit	Result	Remark
3.1	15.247(a)(2)	A8.2(a)	6dB Bandwidth	$\geq 0.5\text{MHz}$	Pass	-
3.2	15.247(b)	A8.4	Power Output	$\leq 30\text{dBm}$	Pass	-
3.3	15.247(d)	A8.5	Frequency Band Edges	$\leq 20\text{dBc}$	Pass	-
3.4	15.247(d)	A8.5	Spurious Emission	$< 20\text{ dBc}$	Pass	-
3.5	15.247(e)	A8.2(b)	Power Spectral Density	$\leq 8\text{dBm}$	Pass	-
3.6	15.207	Gen 7.2.2	AC Conducted Emission	15.207(a)	Pass	Under limit 17.4 dB at 0.198 MHz
3.7	15.247(d)	A8.5	Transmitter Radiated Emission	15.209(a) & 15.247(d)	Pass	Under limit 11.33 dB at 40.26 MHz
3.8	15.203 & 15.247(b)	A8.4	Antenna Requirement	N/A	Pass	-

# 1 General Description

## 1.1 Applicant

**Green Packet Berhad, Taiwan**

6F., No. 21, Lane 583, Rueiguang Rd., Neihu District, Taipei City, Taiwan (R.O.C.)

## 1.2 Manufacturer

**Green Packet Berhad, Taiwan**

1. 6F., No. 21, Lane 583, Rueiguang Rd., Neihu District, Taipei City, Taiwan (R.O.C.)
2. Suite 21213, No. 498, Guoshoujing Rd., Pudong New Area, Shanghai, 201203, China

## 1.3 Feature of Equipment Under Test

Product Feature & Specification	
<b>Equipment</b>	Portable WiMAX WiFi Router
<b>Brand Name</b>	Green Packet
<b>Model Name</b>	MF-250
<b>FCC ID</b>	W9V-MF250-GP
<b>Tx/Rx Frequency Range</b>	2400 MHz ~ 2483.5 MHz
<b>Number of Channels</b>	11
<b>Carrier Frequency of Each Channel</b>	$2412+(n-1)*5$ MHz; n=1~11
<b>Channel Spacing</b>	5 MHz
<b>Maximum Output Power to Antenna</b>	802.11b : 15.60 dBm (0.036 W) 802.11g : 14.90 dBm (0.031 W)
<b>Antenna Type</b>	Chip Antenna with gain 2 dBi
<b>Type of Modulation</b>	802.11b : DSSS (BPSK / QPSK / CCK) 802.11g : OFDM (BPSK / QPSK / 16QAM / 64QAM)
<b>EUT Stage</b>	Production Unit

**Remark:**

1. For other wireless features of this EUT, test report will be issued separately.
2. This test report recorded only product characteristics and test results of Digital Transmission System (DTS).
3. The above EUT's information was declared by manufacturer. Please refer to the specifications or user's manual for more detailed description.

## 1.4 Testing Site

<b>Test Site</b>	SPORTON INTERNATIONAL INC.		
<b>Test Site Location</b>	No. 52, Hwa Ya 1 <sup>st</sup> Rd., Hwa Ya Technology Park, Kwei-Shan Hsiang, Tao Yuan Hsien, Taiwan, R.O.C. TEL: +886-3-3273456 / FAX: +886-3-3284978		
<b>Test Site No.</b>	<b>Sporton Site No.</b>		<b>FCC/IC Registration No.</b>
	CO05-HY	03CH07-HY	722060/4086B-1

## 1.5 Applied Standards

According to the specifications of the manufacturer, the EUT must comply with the requirements of the following standards:

- ♦ FCC Part 15 Subpart C §15.247
- ♦ FCC KDB Publication No. 558074 (Measurement Guidelines of DTS)
- ♦ ANSI C63.4-2003
- ♦ IC RSS-210 Issue 7

### Remark:

1. All test items were verified and recorded according to the standards and without any deviation during the test.
2. This EUT has also been tested and complied with the requirements of FCC Part 15, Subpart B (DoC), recorded in a separate test report.

## 1.6 Ancillary Equipment List

Item	Equipment	Trade Name	Model Name	FCC ID	Data Cable	Power Cord
1.	System Simulator	Agilent	E6651A	N/A	N/A	Unshielded, 1.8 m
2.	Notebook	DELL	Vostro 1510	FCC DoC	N/A	AC I/P: Unshielded, 1.2 m DC O/P: Shielded, 1.8 m
3.	Notebook	DELL	Vostro 3400	FCC DoC	N/A	AC I/P: Unshielded, 1.2 m DC O/P: Shielded, 1.8 m
4.	LCD Monitor	Lenovo	6135-AB1	FCC DoC	Shielded, 1.6 m	Unshielded, 1.8 m
5.	iPod	Apple	A1285	FCC DoC	Shielded, 1.0 m	N/A

## 2 Test Configuration of Equipment Under Test

### 2.1 RF Power

Preliminary tests were performed in different data rate and recorded the RF power output in the following table:

Channel	Frequency	2.4GHz 802.11b RF Power (dBm)			
		At DSSS Data Rate			
		1 Mbps	2 Mbps	5.5 Mbps	11 Mbps
CH 01	2412 MHz	15.38	-	-	15.32
CH 06	2437 MHz	15.56	15.55	15.52	15.60
CH 11	2462 MHz	14.79	-	-	14.96

Channel	Frequency	2.4GHz 802.11g RF Power (dBm)							
		At OFDM Data Rate							
		6 Mbps	9 Mbps	12 Mbps	18 Mbps	24 Mbps	36 Mbps	48 Mbps	54 Mbps
CH 01	2412 MHz	13.52	-	-	-	-	-	-	14.54
CH 06	2437 MHz	14.00	13.58	14.44	13.61	14.81	13.80	14.08	14.90
CH 11	2462 MHz	13.23	-	-	-	-	-	-	13.85

**Remark:**

1. The data rates of WLAN 802.11b/g were set in 11Mbps for 802.11b and 54Mbps for 802.11g, for all the test cases due to the highest RF output power.
2. The EUT is programmed to transmit signals continuously for all testing.

## 2.2 Test Mode

The EUT has been associated with peripherals pursuant to ANSI C63.4-2003 and configuration operated in a manner tended to maximize its emission characteristics in a typical application. Frequency range investigated: conducted emission (150 kHz to 30 MHz), radiated emission (30 MHz to the 10th harmonic of the highest fundamental frequency or to 40 GHz, whichever is lower). Pre-scanned tests were conducted to determine the final configuration from all possible combinations. The following tables are showing the test modes as the worst cases and recorded in this report.

<b>Test Cases</b>		
<b>Test Item</b>	<b>802.11b</b>	<b>802.11g</b>
<b>Conducted TCs</b>	Mode 1 : 802.11b CH01_2412 MHz Mode 2 : 802.11b CH06_2437 MHz Mode 3 : 802.11b CH11_2462 MHz	Mode 4 : 802.11g CH01_2412 MHz Mode 5 : 802.11g CH06_2437 MHz Mode 6 : 802.11g CH11_2462 MHz
<b>Radiated TCs</b>	Mode 1 : 802.11b CH01_2412 MHz Mode 2 : 802.11b CH06_2437 MHz Mode 3 : 802.11b CH11_2462 MHz	Mode 4 : 802.11g CH01_2412 MHz Mode 5 : 802.11g CH06_2437 MHz Mode 6 : 802.11g CH11_2462 MHz
<b>AC Conducted Emission</b>	Mode 1 : WiMAX Idle + WLAN Link + USB Cable (Charging from Notebook)	



## 2.3 Connection Diagram of Test System

### <WLAN Tx Mode>

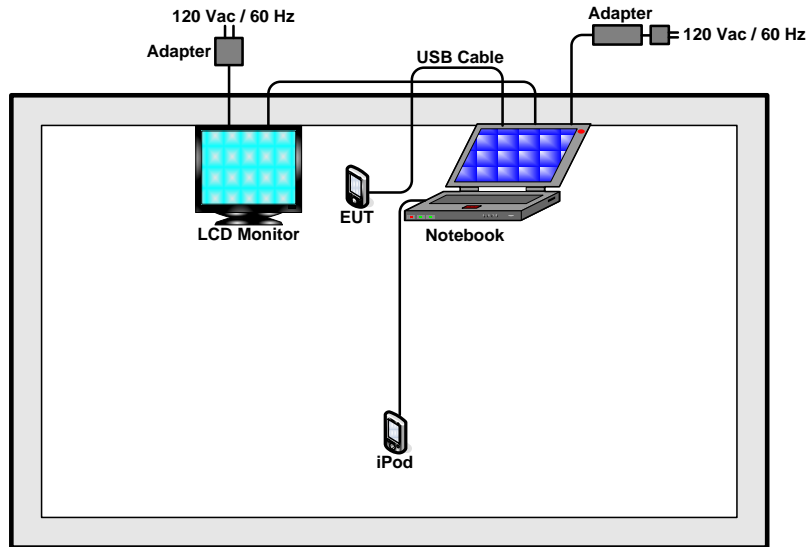

### <AC Conducted Emission Mode>

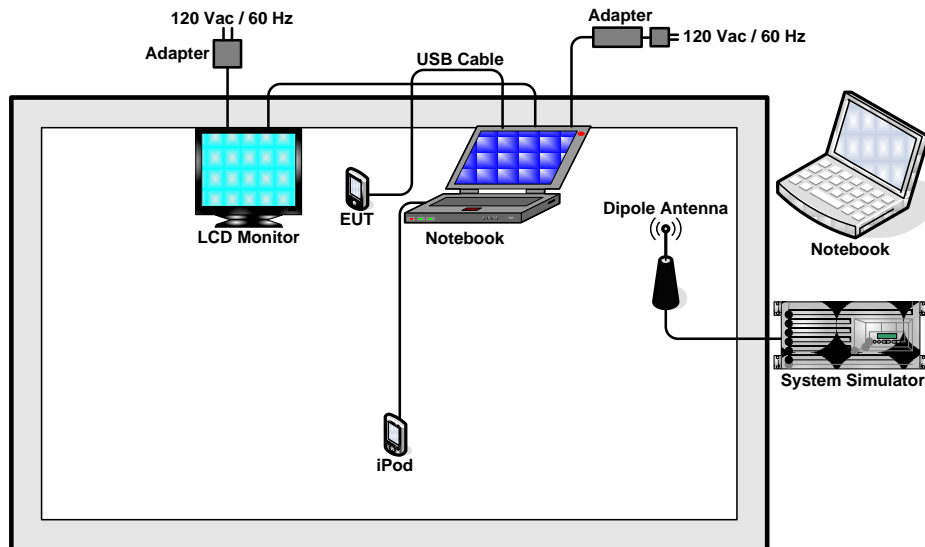

## 2.4 RF Utility

The programmed RF utility, "shttpd.exe" is installed in notebook to provide channel selection, power level, data rate and the application type. RF Utility can send transmitting signal for all testing. The RF output power selection is for the setting of RF output power expected by the customer and is going to be fixed on the firmware of the final end product.

### 3 Test Result

#### 3.1 6dB Bandwidth Measurement

##### 3.1.1 Limit of 6dB Bandwidth

The minimum 6 dB bandwidth shall be at least 500 kHz.

##### 3.1.2 Measuring Instruments

See list of measuring instruments of this test report.

##### 3.1.3 Test Procedures

1. The testing follows FCC KDB Publication No. 558074 (Measurement Guidelines of DTS).
2. The RF output of EUT was connected to the spectrum analyzer by a low loss cable.
3. Make the measurement with the spectrum analyzer's resolution bandwidth (RBW) = 100 kHz.  
In order to make an accurate measurement, set the span greater than RBW. The 6 dB bandwidth must be greater than 500 kHz.
4. The marker-delta reading at this point is the 6 dB bandwidth of the emission.

##### 3.1.4 Test Setup

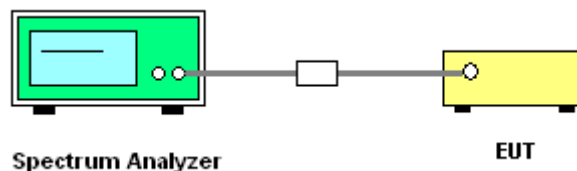

3.1.5 Test Result of 6dB Bandwidth

Test Mode :	Mode 1, 2, 3	Temperature :	24~26°C
Test Engineer :	Lancelot Chen	Relative Humidity :	48~51%

Channel	Frequency (MHz)	802.11b 6dB Bandwidth (MHz)	6dB Bandwidth Min. Limit (MHz)	Pass/Fail
01	2412	9.52	0.5	Pass
06	2437	9.52	0.5	Pass
11	2462	9.07	0.5	Pass

Mode 1 : 6 dB Bandwidth Plot on 802.11b Channel 01

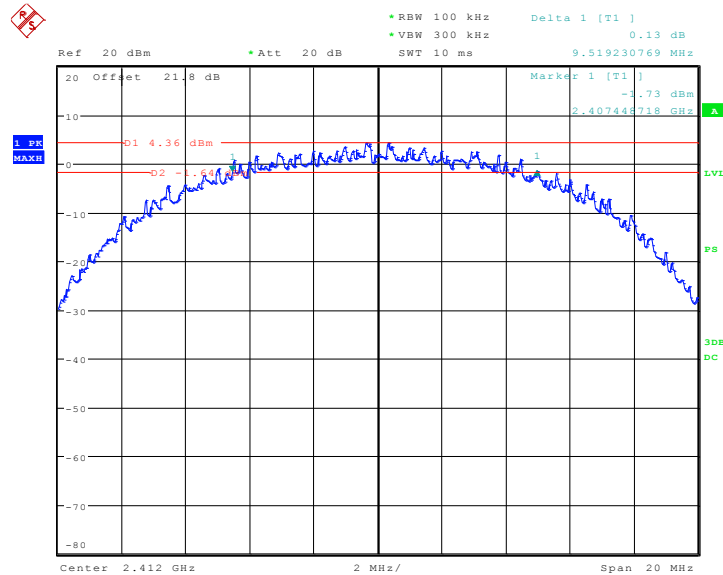

Date: 22.NOV.2010 08:50:06





Test Mode :	Mode 4, 5, 6	Temperature :	24~26°C
Test Engineer :	Lancelot Chen	Relative Humidity :	48~51%

Channel	Frequency (MHz)	802.11g 6dB Bandwidth (MHz)	6dB Bandwidth Min. Limit (MHz)	Pass/Fail
01	2412	16.41	0.5	Pass
06	2437	16.41	0.5	Pass
11	2462	16.41	0.5	Pass

Mode 4 : 6 dB Bandwidth Plot on 802.11g Channel 01

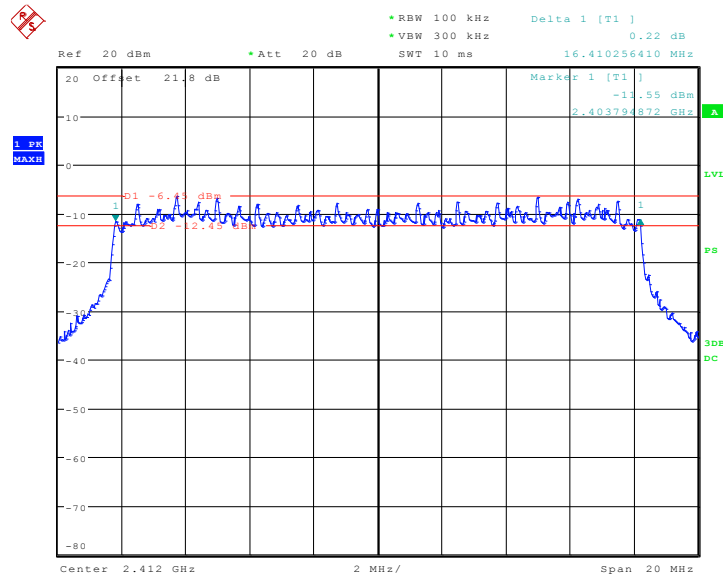

Date: 22.NOV.2010 09:01:34



## 3.2 Output Power Measurement

### 3.2.1 Limit of Output Power

For systems using digital modulation in the 2400-2483.5MHz, the limit for peak output power is 30dBm. If transmitting antenna of directional gain greater than 6dBi are used the peak output power from the intentional radiator shall be reduced below the above stated value by the amount in dB that the directional gain of the antenna exceeds 6 dBi. In case of point-to-point operation, the limit has to be reduced by 1dB for every 3dB that the directional gain of the antenna exceeds 6dBi.

### 3.2.2 Measuring Instruments

See list of measuring instruments of this test report.

### 3.2.3 Test Procedures

1. The testing follows FCC KDB Publication No. 558074 (Measurement Guidelines of DTS).
2. The RF output of EUT was connected to the power meter by a low loss cable.
3. Measure the power by power meter.

### 3.2.4 Test Setup

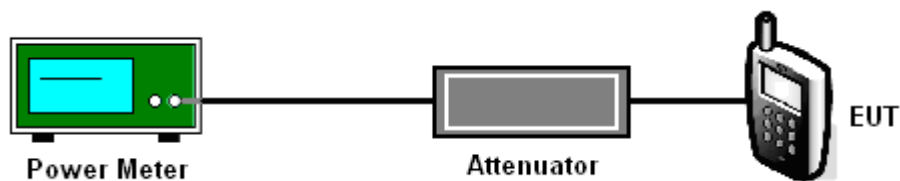



3.2.5 Test Result of Output Power

Test Mode :	Mode 1, 2, 3	Temperature :	24~26°C
Test Engineer :	Lancelot Chen	Relative Humidity :	48~51%

Channel	Frequency (MHz)	802.11b Measured Output Power (dBm)	Max. Limits (dBm)	Pass/Fail
01	2412	15.32	30	Pass
06	2437	15.60	30	Pass
11	2462	14.96	30	Pass

Test Mode :	Mode 4, 5, 6	Temperature :	24~26°C
Test Engineer :	Lancelot Chen	Relative Humidity :	48~51%

Channel	Frequency (MHz)	802.11g Measured Output Power (dBm)	Max. Limits (dBm)	Pass/Fail
01	2412	14.54	30	Pass
06	2437	14.90	30	Pass
11	2462	13.85	30	Pass





### **3.3 Band Edges Measurement**

#### **3.3.1 Limit of Band Edges**

In any 100 kHz bandwidth outside the intentional radiation frequency band, the radio frequency power shall be at least 20 dB below the highest level of the radiated power. If the output power of this device was measured by spectrum analyzer, the attenuation under this paragraph shall be 30 dB instead of 20 dB.

#### **3.3.2 Measuring Instruments**

See list of measuring instruments of this test report.

#### **3.3.3 Test Procedures**

1. The testing follows the guidelines in ANSI C63.4-2003 and FCC KDB Publication No. 558074 (Measurement Guidelines of DTS).
2. Conducted emission test: Set RBW = 100 kHz, Video bandwidth (VBW)  $\geq$  RBW. Band edge emissions must be at least 20 dB down from the highest emission level within the authorized band as measured with a 100 kHz RBW. Note: If the device complies with the use of power option 2 the attenuation under this paragraph shall be 30 dB instead of 20 dB.
3. Radiated emission test: Apply to band edge emissions that fall in the restricted bands listed in FCC Section 15.205. The maximum permitted average field strength is listed in FCC Section 15.209. A pre-amp is necessary for this measurement. For measurements above 1 GHz, set RBW = 1MHz, VBW = 10 Hz, Sweep=Auto. If the emission is pulsed, modify the unit for continuous operation; use the settings shown above, then correct the reading by subtracting the peak-average correction factor, derived from the appropriate duty cycle calculation as in FCC Section 15.35(b) and (c).

### 3.3.4 Test Setup

#### <Radiated Band Edges>

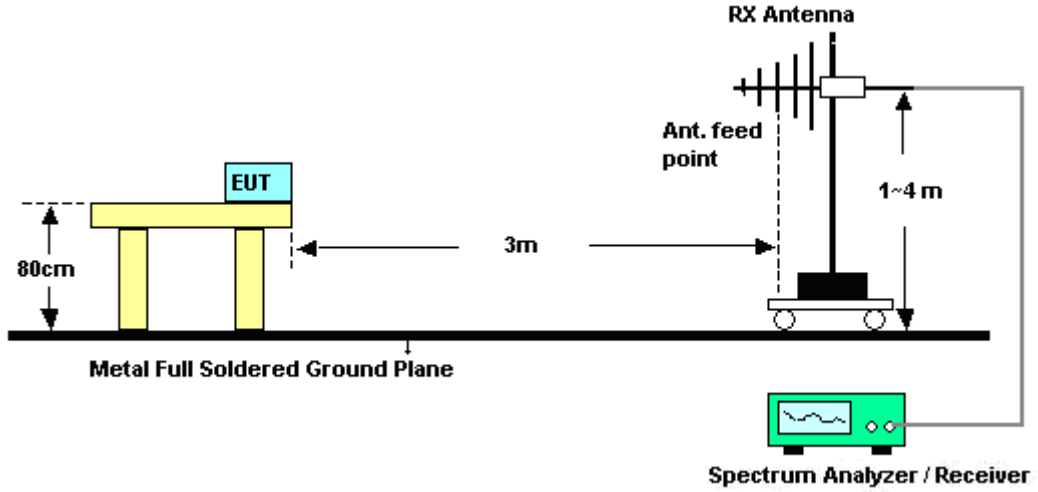

#### <Conducted Band Edges>

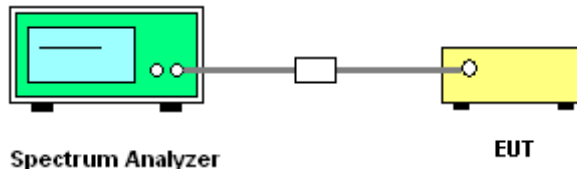



3.3.5 Test Result of Radiated Band Edges

Test Mode :	Mode 1	Temperature :	23.8~24.0°C
Test Band :	802.11b	Relative Humidity :	49~50%
Test Channel :	01	Test Engineer :	Ivan Jiang

ANTENNA POLARITY : HORIZONTAL										
Frequency ( MHz )	Level ( dBuV/m )	Over Limit ( dB )	Limit Line ( dBuV/m )	Read Level ( dBuV )	Antenna Factor ( dB )	Cable Loss ( dB )	Preamp Factor ( dB )	Ant Pos ( cm )	Table Pos ( deg )	Remark
2371.94	46.38	-27.62	74.00	41.76	32.16	5.99	33.53	144	14	Peak
2371.94	33.65	-20.35	54.00	29.03	32.16	5.99	33.53	144	14	Average

ANTENNA POLARITY : VERTICAL										
Frequency ( MHz )	Level ( dBuV/m )	Over Limit ( dB )	Limit Line ( dBuV/m )	Read Level ( dBuV )	Antenna Factor ( dB )	Cable Loss ( dB )	Preamp Factor ( dB )	Ant Pos ( cm )	Table Pos ( deg )	Remark
2358.26	46.40	-27.60	74.00	41.80	32.13	5.99	33.52	171	290	Peak
2358.26	33.65	-20.35	54.00	29.05	32.13	5.99	33.52	171	290	Average

Test Mode :	Mode 3	Temperature :	23.8~24.0°C
Test Band :	802.11b	Relative Humidity :	49~50%
Test Channel :	11	Test Engineer :	Ivan Jiang

ANTENNA POLARITY : HORIZONTAL										
Frequency ( MHz )	Level ( dBuV/m )	Over Limit ( dB )	Limit Line ( dBuV/m )	Read Level ( dBuV )	Antenna Factor ( dB )	Cable Loss ( dB )	Preamp Factor ( dB )	Ant Pos ( cm )	Table Pos ( deg )	Remark
2484.42	45.98	-28.02	74.00	41.08	32.28	6.18	33.56	117	9	Peak
2484.42	33.12	-20.88	54.00	28.22	32.28	6.18	33.56	117	9	Average

ANTENNA POLARITY : VERTICAL										
Frequency ( MHz )	Level ( dBuV/m )	Over Limit ( dB )	Limit Line ( dBuV/m )	Read Level ( dBuV )	Antenna Factor ( dB )	Cable Loss ( dB )	Preamp Factor ( dB )	Ant Pos ( cm )	Table Pos ( deg )	Remark
2491.45	45.42	-28.58	74.00	40.51	32.30	6.18	33.57	100	293	Peak
2491.45	33.14	-20.86	54.00	28.23	32.30	6.18	33.57	100	293	Average



Test Mode :	Mode 4	Temperature :	23.8~24.0°C
Test Band :	802.11g	Relative Humidity :	49~50%
Test Channel :	01	Test Engineer :	Ivan Jiang

ANTENNA POLARITY : HORIZONTAL										
Frequency ( MHz )	Level ( dBuV/m )	Over Limit ( dB )	Limit Line ( dBuV/m )	Read Level ( dBuV )	Antenna Factor ( dB )	Cable Loss ( dB )	Preamp Factor ( dB )	Ant Pos ( cm )	Table Pos ( deg )	Remark
2336.98	46.23	-27.77	74.00	41.69	32.11	5.95	33.52	102	232	Peak
2336.98	33.56	-20.44	54.00	29.02	32.11	5.95	33.52	102	232	Average

ANTENNA POLARITY : VERTICAL										
Frequency ( MHz )	Level ( dBuV/m )	Over Limit ( dB )	Limit Line ( dBuV/m )	Read Level ( dBuV )	Antenna Factor ( dB )	Cable Loss ( dB )	Preamp Factor ( dB )	Ant Pos ( cm )	Table Pos ( deg )	Remark
2374.41	46.61	-27.39	74.00	41.99	32.16	5.99	33.53	170	291	Peak
2374.41	33.63	-20.37	54.00	29.01	32.16	5.99	33.53	170	291	Average

Test Mode :	Mode 6	Temperature :	23.8~24.0°C
Test Band :	802.11g	Relative Humidity :	49~50%
Test Channel :	11	Test Engineer :	Ivan Jiang

ANTENNA POLARITY : HORIZONTAL										
Frequency ( MHz )	Level ( dBuV/m )	Over Limit ( dB )	Limit Line ( dBuV/m )	Read Level ( dBuV )	Antenna Factor ( dB )	Cable Loss ( dB )	Preamp Factor ( dB )	Ant Pos ( cm )	Table Pos ( deg )	Remark
2485.18	45.76	-28.24	74.00	40.86	32.28	6.18	33.56	112	12	Peak
2485.18	33.12	-20.88	54.00	28.22	32.28	6.18	33.56	112	12	Average

ANTENNA POLARITY : VERTICAL										
Frequency ( MHz )	Level ( dBuV/m )	Over Limit ( dB )	Limit Line ( dBuV/m )	Read Level ( dBuV )	Antenna Factor ( dB )	Cable Loss ( dB )	Preamp Factor ( dB )	Ant Pos ( cm )	Table Pos ( deg )	Remark
2486.70	45.73	-28.27	74.00	40.83	32.28	6.18	33.56	100	292	Peak
2486.70	33.13	-20.87	54.00	28.23	32.28	6.18	33.56	100	292	Average



### 3.3.6 Test Plots of Conducted Band Edges

Test Mode :	Mode 1 and 3	Temperature :	24~26°C
Test Band :	802.11b	Relative Humidity :	48~51%
Test Channel :	01 and 11	Test Engineer :	Lancelot Chen

Low Band Edge Plot on 802.11b Channel 01

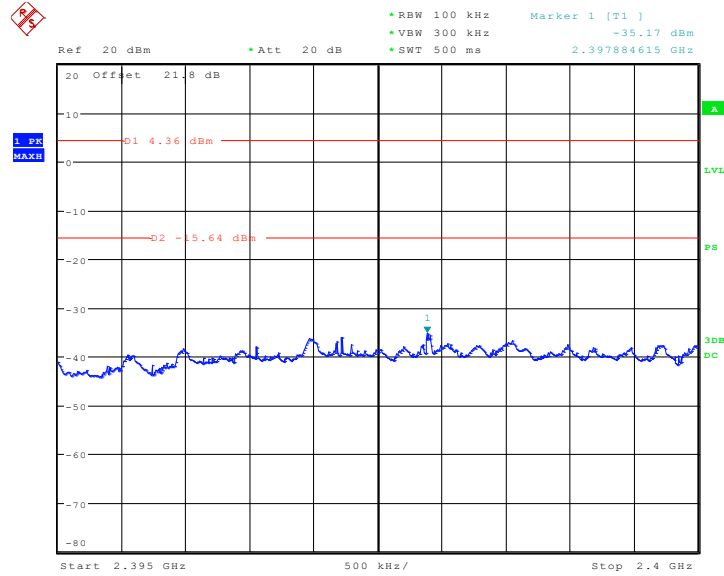

Date: 22.NOV.2010 10:32:57

High Band Edge Plot on 802.11b Channel 11

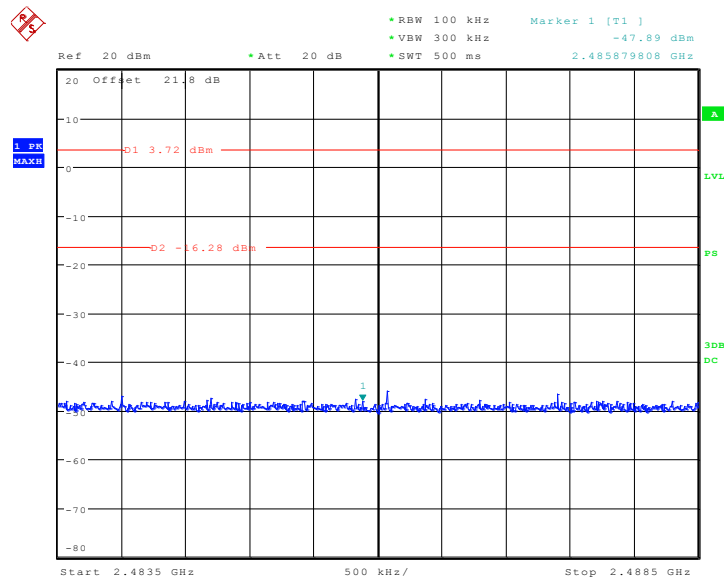

Date: 22.NOV.2010 11:48:38



Test Mode :	Mode 4 and 6	Temperature :	24~26°C
Test Band :	802.11g	Relative Humidity :	48~51%
Test Channel :	01 and 11	Test Engineer :	Lancelot Chen

Low Band Edge Plot on 802.11g Channel 01

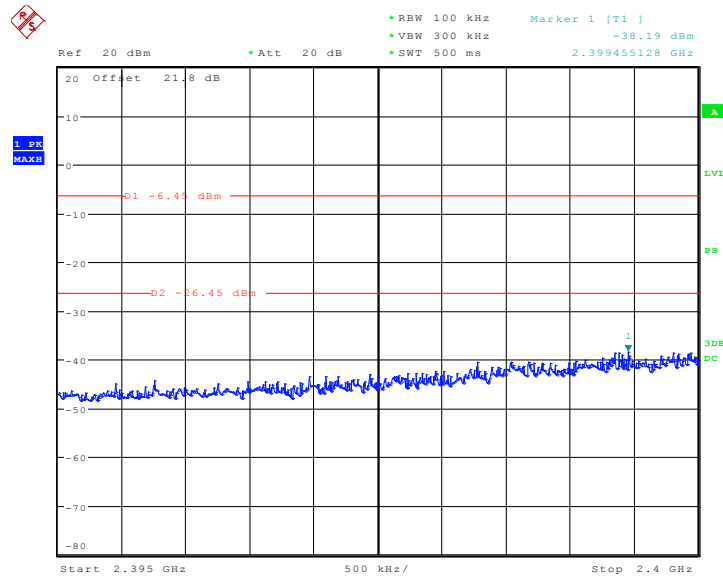

Date: 22.NOV.2010 10:23:49

High Band Edge Plot on 802.11g Channel 11

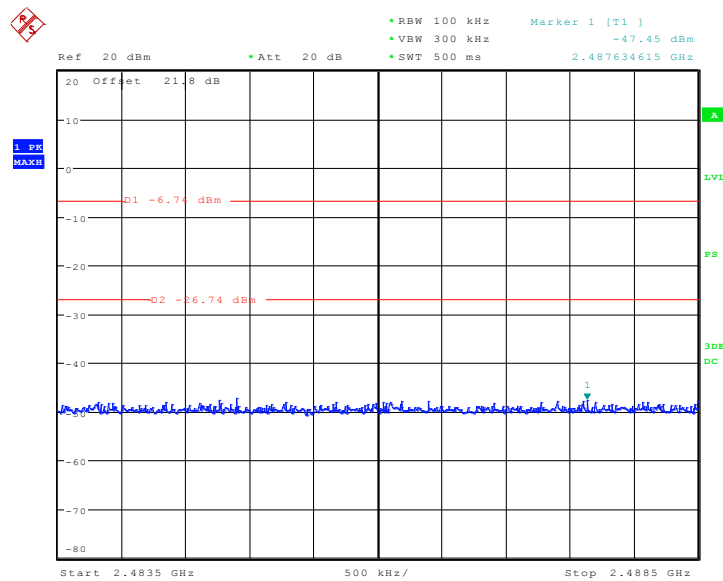

Date: 22.NOV.2010 10:27:49

## 3.4 Spurious Emission Measurement

### 3.4.1 Limit of Spurious Emission Measurement

All harmonics/spurs must be at least 20 dB down from the highest emission level within the authorized band.

### 3.4.2 Measuring Instruments

See list of measuring instruments of this test report.

### 3.4.3 Test Procedure

1. The transmitter output was connected to the spectrum analyzer via a low lose cable.
2. Set RBW = 100 kHz, Video bandwidth (VBW)  $\geq$  RBW, scan up through 10th harmonic. All harmonics/spurs must be at least 20 dB down from the highest emission level within the authorized band as measured with a 100 kHz RBW.

### 3.4.4 Test Setup

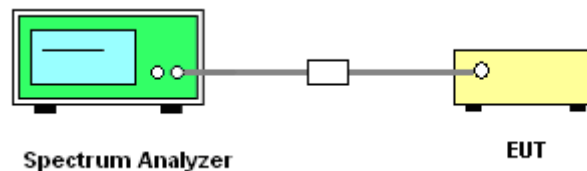

### 3.4.5 Test Plots of Spurious Emission

Test Mode :	Mode 1	Temperature :	24~26°C
Test Band :	802.11b	Relative Humidity :	48~51%
Test Channel :	01	Test Engineer :	Lancelot Chen

Conducted Spurious Emission Plot between 30kHz ~ 3 GHz

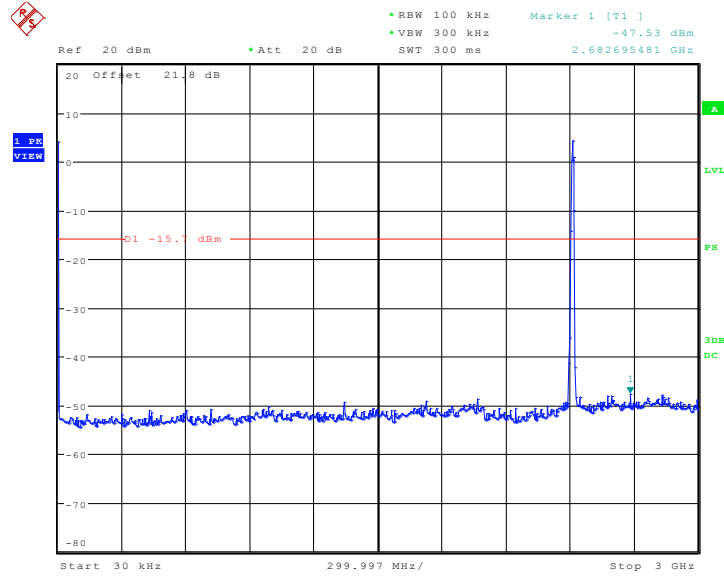

Date: 22.NOV.2010 07:28:02

Conducted Spurious Emission Plot between 1 GHz ~ 25 GHz

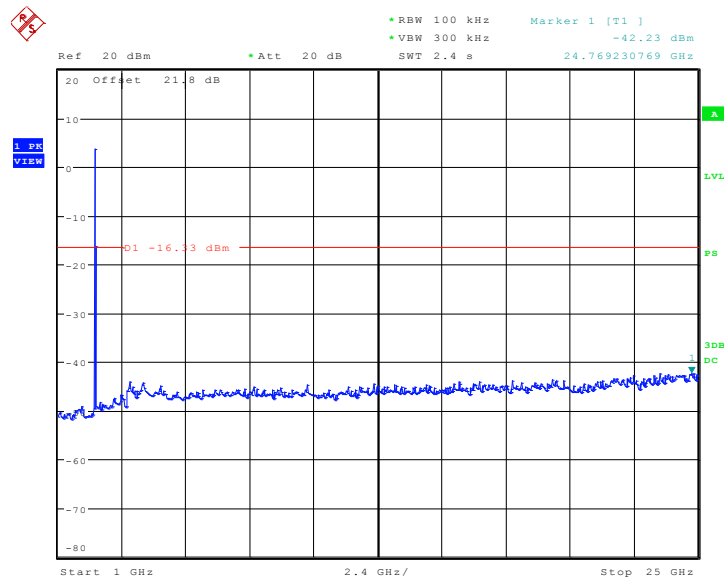

Date: 22.NOV.2010 07:28:55





Test Mode :	Mode 2	Temperature :	24~26°C
Test Band :	802.11b	Relative Humidity :	48~51%
Test Channel :	06	Test Engineer :	Lancelot Chen

Conducted Spurious Emission Plot between 30kHz ~ 3 GHz

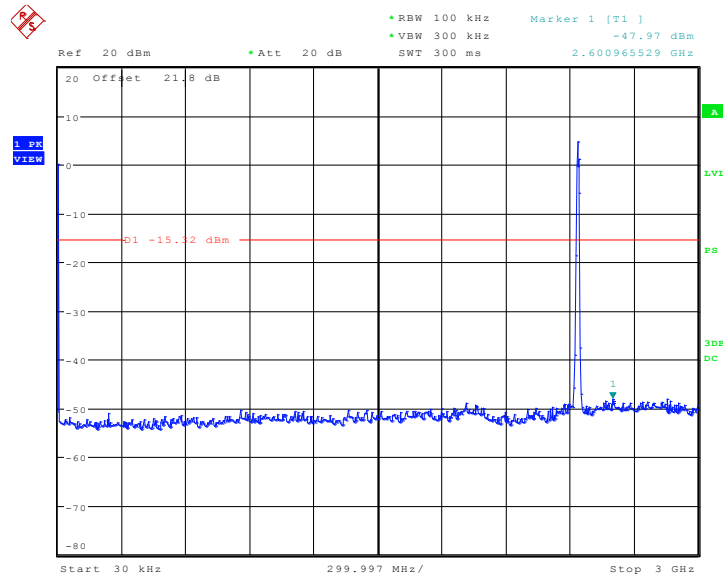

Date: 22.NOV.2010 07:32:35

Conducted Spurious Emission Plot between 1 GHz ~ 25 GHz

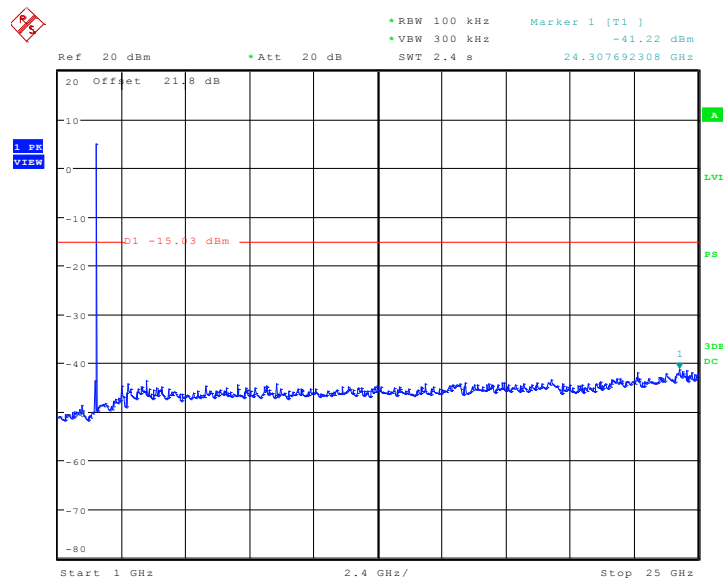

Date: 22.NOV.2010 07:30:02



Test Mode :	Mode 3	Temperature :	24~26°C
Test Band :	802.11b	Relative Humidity :	48~51%
Test Channel :	11	Test Engineer :	Lancelot Chen

Conducted Spurious Emission Plot between 30kHz ~ 3 GHz

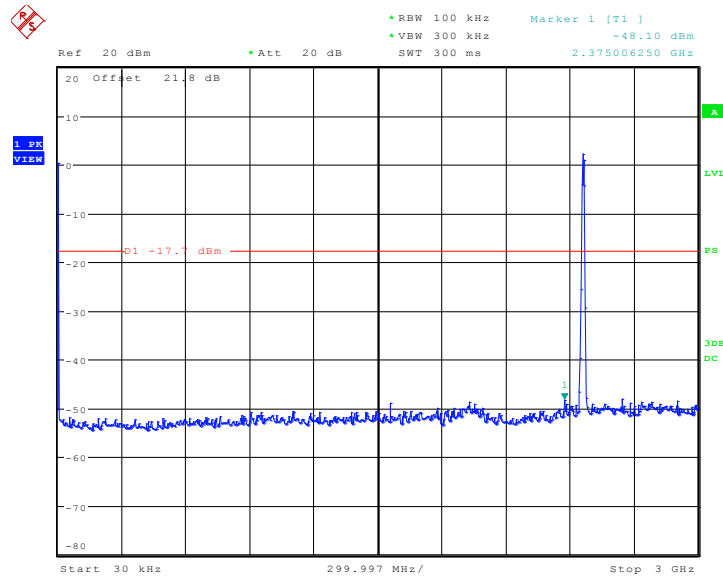

Date: 22.NOV.2010 07:31:40

Conducted Spurious Emission Plot between 1 GHz ~ 25 GHz

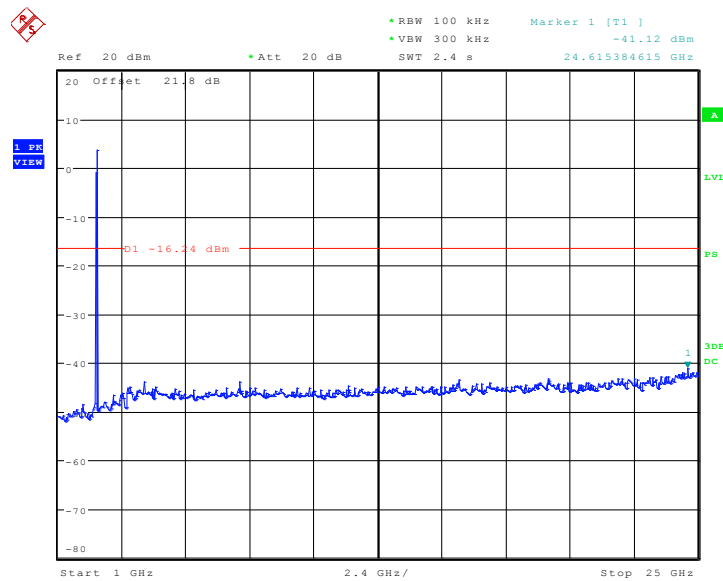

Date: 22.NOV.2010 12:29:58



Test Mode :	Mode 4	Temperature :	24~26°C
Test Band :	802.11g	Relative Humidity :	48~51%
Test Channel :	01	Test Engineer :	Lancelot Chen

Conducted Spurious Emission Plot between 30kHz ~ 3 GHz

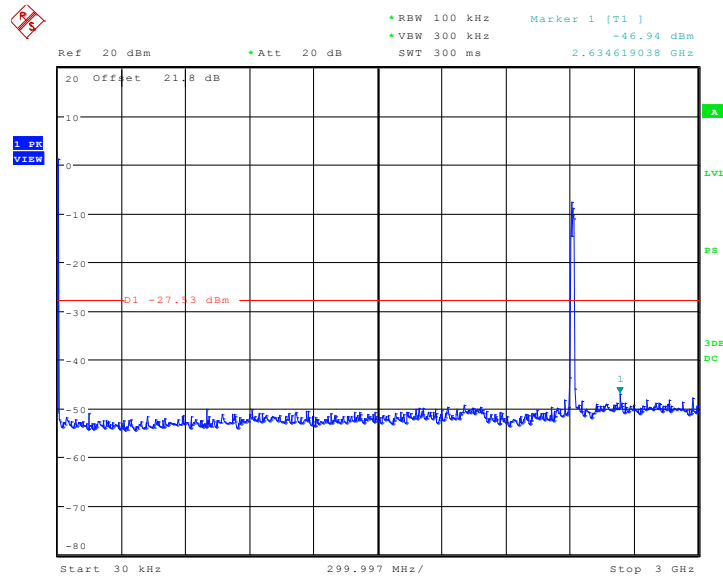

Date: 22.NOV.2010 07:35:59

Conducted Spurious Emission Plot between 1 GHz ~ 25 GHz

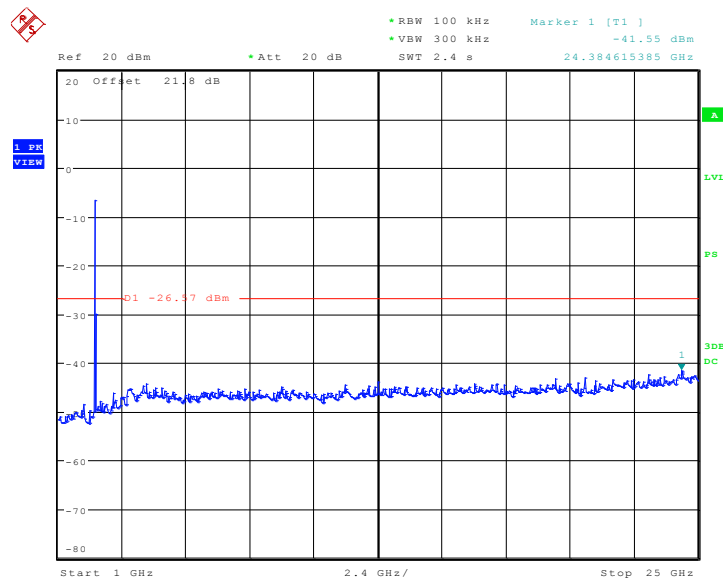

Date: 22.NOV.2010 07:36:34



Test Mode :	Mode 5	Temperature :	24~26°C
Test Band :	802.11g	Relative Humidity :	48~51%
Test Channel :	06	Test Engineer :	Lancelot Chen

Conducted Spurious Emission Plot between 30kHz ~ 3 GHz

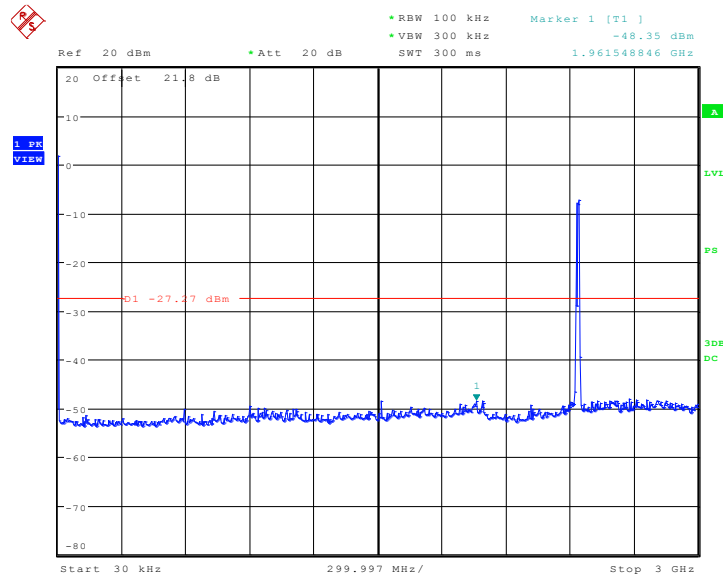

Date: 22.NOV.2010 07:35:19

Conducted Spurious Emission Plot between 1 GHz ~ 25 GHz

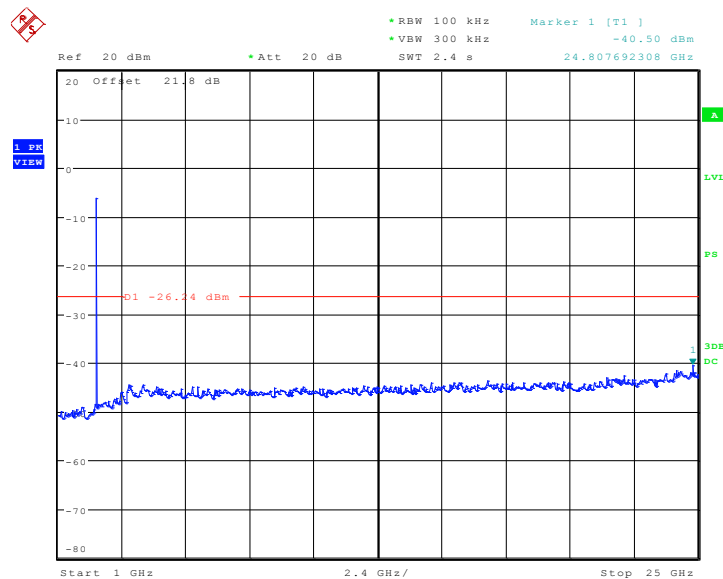

Date: 22.NOV.2010 07:37:56



Test Mode :	Mode 6	Temperature :	24~26°C
Test Band :	802.11g	Relative Humidity :	48~51%
Test Channel :	11	Test Engineer :	Lancelot Chen

Conducted Spurious Emission Plot between 30kHz ~ 3 GHz

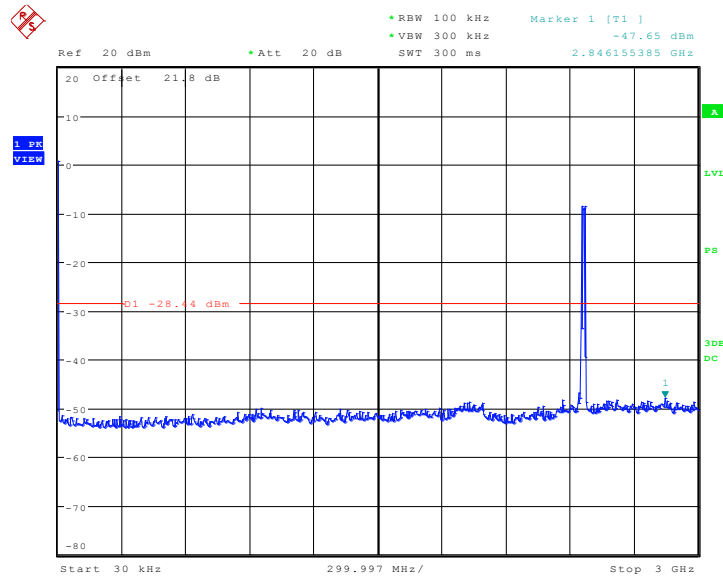

Date: 22.NOV.2010 07:34:21

Conducted Spurious Emission Plot between 1 GHz ~ 25 GHz

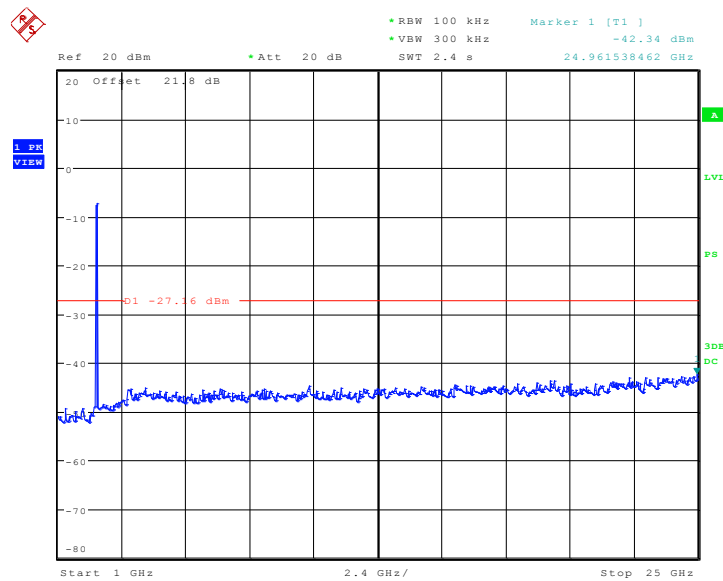

Date: 22.NOV.2010 07:38:27

## 3.5 Power Spectral Density Measurement

### 3.5.1 Limit of Power Spectral Density

The peak power spectral density shall not be greater than 8dBm in any 3kHz band at any time interval of continuous transmission.

### 3.5.2 Measuring Instruments

See list of measuring instruments of this test report.

### 3.5.3 Test Procedures

1. The test follows FCC KDB Publication No. 558074 (Measurement Guidelines of DTS).
2. The RF output of EUT was connected to the spectrum analyzer by a low loss cable.
3. Take the measured data from spectrum analyzer.

### 3.5.4 Test Setup

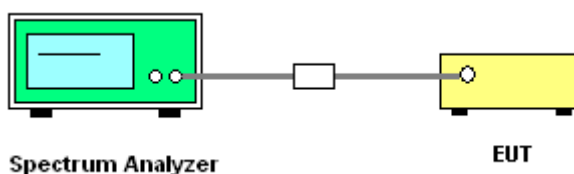



3.5.5 Test Result of Power Spectral Density

Test Mode :	Mode 1, 2, 3	Temperature :	24~26°C
Test Engineer :	Lancelot Chen	Relative Humidity :	48~51%

Channel	Frequency (MHz)	802.11b Measured PSD (dBm)	Max. Limits (dBm)	Pass/Fail
01	2412	3.86	8	Pass
06	2437	4.50	8	Pass
11	2462	3.68	8	Pass

Mode 1 : PSD Plot on 802.11b Channel 01

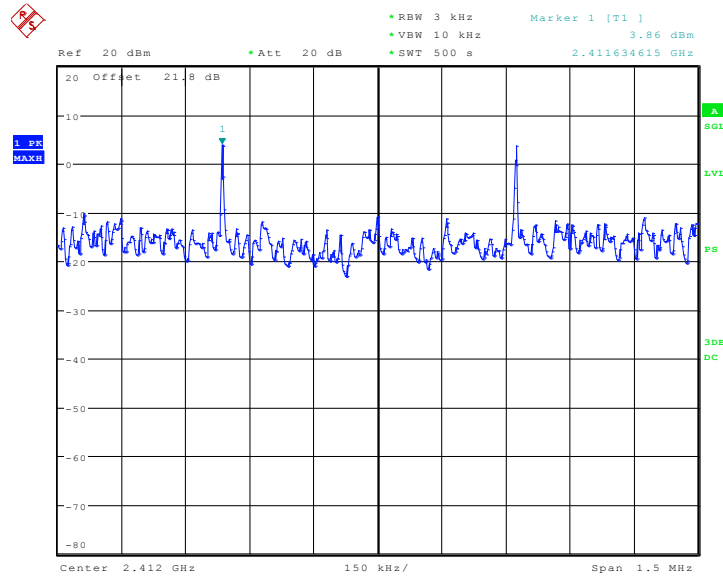

Date: 22.NOV.2010 04:57:20



Mode 2 : PSD Plot on 802.11b Channel 06

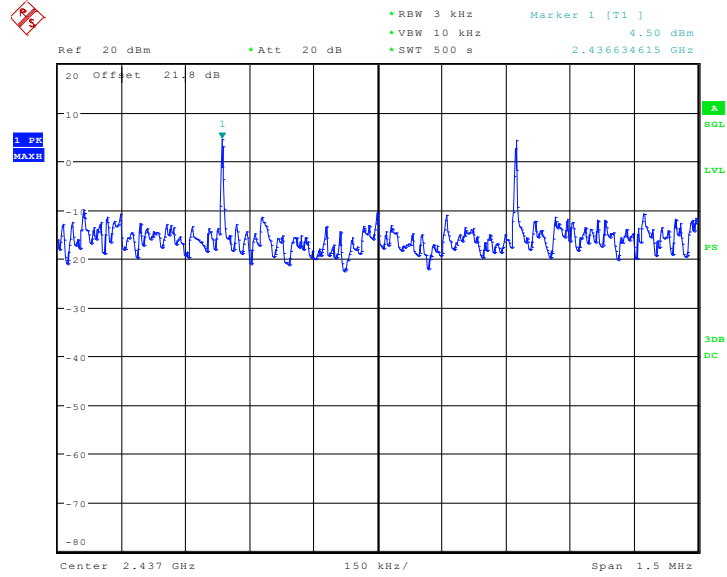

Date: 22.NOV.2010 05:07:25

Mode 3 : PSD Plot on 802.11b Channel 11

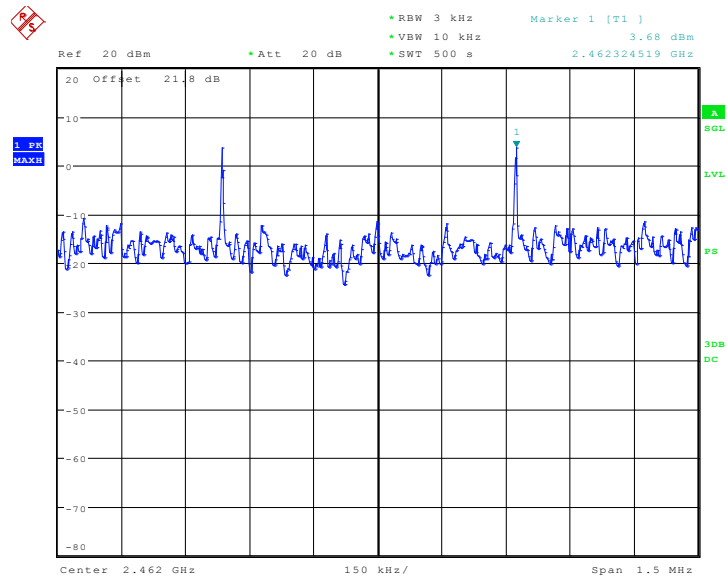

Date: 22.NOV.2010 05:16:56





Test Mode :	Mode 4, 5, 6	Temperature :	24~26°C
Test Engineer :	Lancelot Chen	Relative Humidity :	48~51%

Channel	Frequency (MHz)	802.11g Measured PSD (dBm)	Max. Limits (dBm)	Pass/Fail
01	2412	-22.30	8	Pass
06	2437	-22.06	8	Pass
11	2462	-22.99	8	Pass

Mode 4 : PSD Plot on 802.11g Channel 01

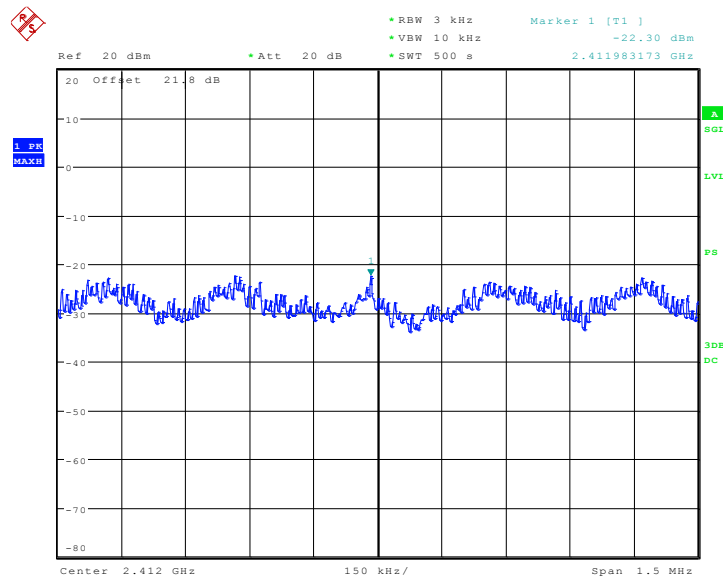

Date: 22.NOV.2010 06:35:43



Mode 5 : PSD Plot on 802.11g Channel 06

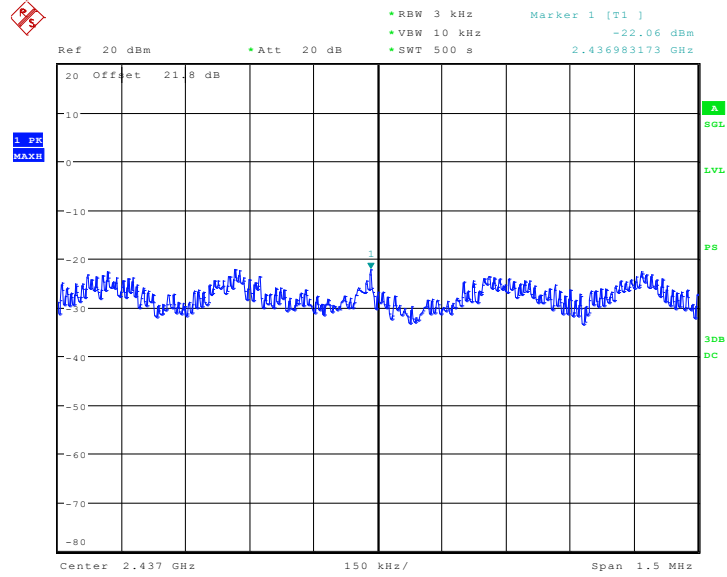

Date: 22.NOV.2010 05:51:43

Mode 6 : PSD Plot on 802.11g Channel 11

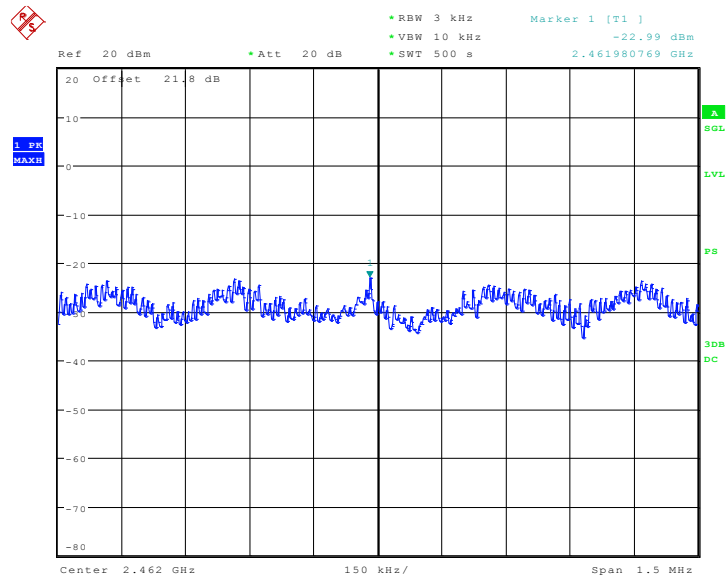

Date: 22.NOV.2010 05:42:15

## 3.6 AC Conducted Emission Measurement

### 3.6.1 Limit of AC Conducted Emission

For equipment that is designed to be connected to the public utility (AC) power line, the radio frequency voltage that is conducted back onto the AC power line on any frequency or frequencies within the band 150 kHz to 30 MHz shall not exceed the limits in the following table.

Frequency of Emission (MHz)	Conducted Limit (dBuV)	
	Quasi-Peak	Average
0.15-0.5	66 to 56*	56 to 46*
0.5-5	56	46
5-30	60	50

\*Decreases with the logarithm of the frequency.

### 3.6.2 Measuring Instruments

See list of measuring instruments of this test report.

### 3.6.3 Test Procedures

1. The testing follows the guidelines in ANSI C63.4-2003.
2. The EUT was placed 0.4 meter from the conducting wall of the shielding room, and it was kept at least 80 centimeters from any other grounded conducting surface.
3. Connect EUT to the power mains through a line impedance stabilization network (LISN).
4. All the support units are connecting to the other LISN.
5. The LISN provides 50 ohm coupling impedance for the measuring instrument.
6. The FCC states that a 50 ohm, 50 microhenry LISN should be used.
7. Both sides of AC line were checked for maximum conducted interference.
8. The frequency range from 150 kHz to 30 MHz was searched.
9. Set the test-receiver system to Peak Detect Function and specified bandwidth with Maximum Hold Mode.

### 3.6.4 Test Setup

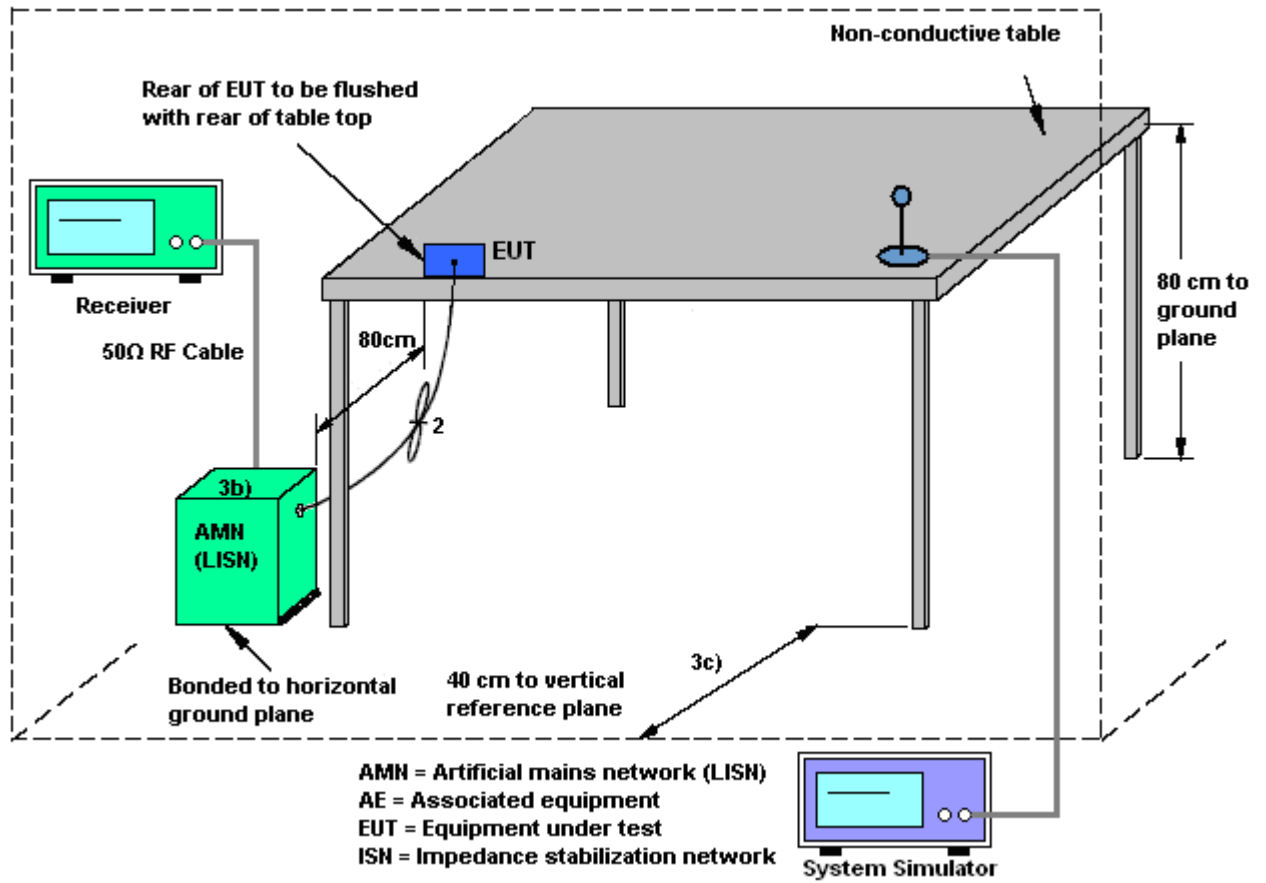

### 3.6.5 Test Result of AC Conducted Emission

Test Mode :	Mode 1	Temperature :	20~22°C
Test Engineer :	Hayden Wu	Relative Humidity :	51~53%
Test Voltage :	120Vac / 60Hz	Phase :	Line
Function Type :	WiMAX Idle + WLAN Link + USB Cable (Charging from Notebook)		
Remark :	All emissions not reported here are more than 10 dB below the prescribed limit.		

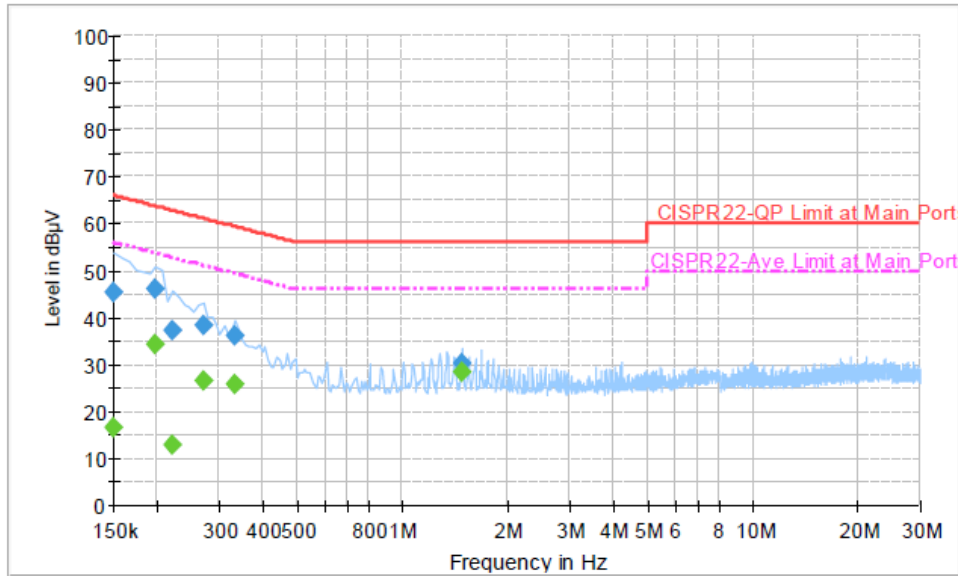

#### Final Result 1

Frequency (MHz)	QuasiPeak (dBµV)	Filter	Line	Corr. (dB)	Margin (dB)	Limit (dBµV)
0.150000	45.3	Off	L1	19.4	20.7	66.0
0.198000	46.3	Off	L1	19.3	17.4	63.7
0.222000	37.2	Off	L1	19.3	25.5	62.7
0.270000	38.5	Off	L1	19.3	22.6	61.1
0.334000	36.1	Off	L1	19.3	23.3	59.4
1.478000	30.2	Off	L1	19.4	25.8	56.0

#### Final Result 2

Frequency (MHz)	Average (dBµV)	Filter	Line	Corr. (dB)	Margin (dB)	Limit (dBµV)
0.150000	16.6	Off	L1	19.4	39.4	56.0
0.198000	34.3	Off	L1	19.3	19.4	53.7
0.222000	12.8	Off	L1	19.3	39.9	52.7
0.270000	26.7	Off	L1	19.3	24.4	51.1
0.334000	25.7	Off	L1	19.3	23.7	49.4
1.478000	28.4	Off	L1	19.4	17.6	46.0



Test Mode :	Mode 1	Temperature :	20~22°C
Test Engineer :	Hayden Wu	Relative Humidity :	51~53%
Test Voltage :	120Vac / 60Hz	Phase :	Neutral
Function Type :	WiMAX Idle + WLAN Link + USB Cable (Charging from Notebook)		
Remark :	All emissions not reported here are more than 10 dB below the prescribed limit.		

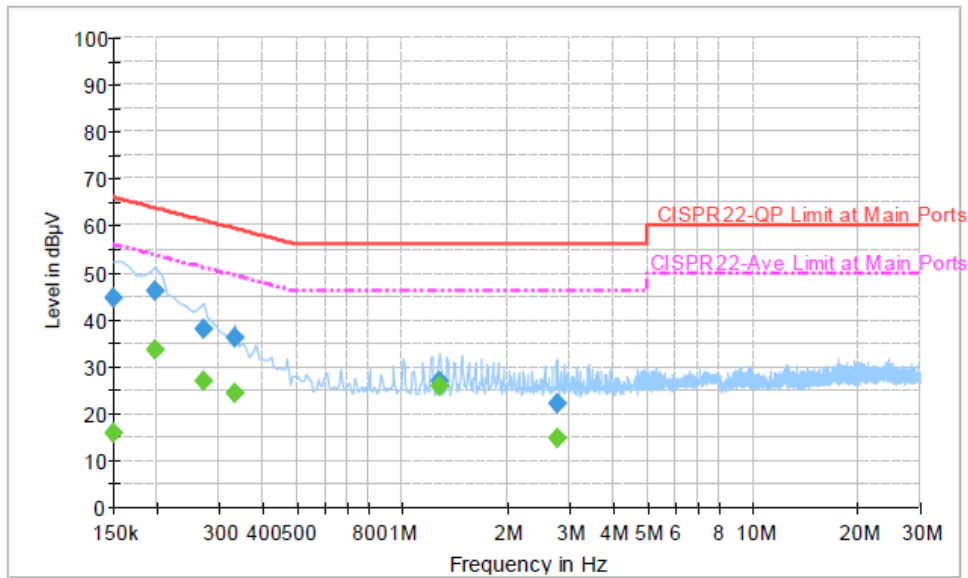

**Final Result 1**

Frequency (MHz)	QuasiPeak (dBµV)	Filter	Line	Corr. (dB)	Margin (dB)	Limit (dBµV)
0.150000	44.8	Off	N	19.4	21.2	66.0
0.198000	46.3	Off	N	19.3	17.4	63.7
0.270000	38.2	Off	N	19.3	22.9	61.1
0.334000	36.1	Off	N	19.3	23.3	59.4
1.278000	27.0	Off	N	19.5	29.0	56.0
2.758000	22.2	Off	N	19.5	33.8	56.0

**Final Result 2**

Frequency (MHz)	Average (dBµV)	Filter	Line	Corr. (dB)	Margin (dB)	Limit (dBµV)
0.150000	15.8	Off	N	19.4	40.2	56.0
0.198000	33.6	Off	N	19.3	20.1	53.7
0.270000	27.0	Off	N	19.3	24.1	51.1
0.334000	24.4	Off	N	19.3	25.0	49.4
1.278000	25.8	Off	N	19.5	20.2	46.0
2.758000	14.9	Off	N	19.5	31.1	46.0

### 3.7 Radiated Emission Measurement

#### 3.7.1 Limit of Radiated Emission

In any 100 kHz bandwidth outside the intentional radiator frequency band, all harmonics/spurious must be at least 20 dB below the highest emission level within the authorized band. If the output power of this device was measured by spectrum analyzer, the attenuation under this paragraph shall be 30 dB instead of 20 dB. In addition, radiated emissions which fall in the restricted bands must also comply with the FCC section 15.209 limits as below.

Frequency (MHz)	Field Strength (microvolts/meter)	Measurement Distance (meters)
0.009 – 0.490	2400/F(kHz)	300
0.490 – 1.705	24000/F(kHz)	30
1.705 – 30.0	30	30
30 – 88	100	3
88 – 216	150	3
216 - 960	200	3
Above 960	500	3

#### 3.7.2 Measuring Instruments

See list of measuring instruments of this test report.

#### 3.7.3 Test Procedures

1. The testing follows the guidelines in FCC KDB Publication No. 558074 (Measurement Guidelines of DTS).
2. Use the following spectrum analyzer settings:
  - (1) Span = wide enough to fully capture the emission being measured; RBW = 1 MHz for  $f \geq 1$  GHz, 100 kHz for  $f < 1$  GHz; VBW  $\geq$  RBW; Sweep = auto; Detector function = peak; Trace = max hold.
  - (2) Above 18 GHz shall be extrapolated to the specified distance using an extrapolation factor of 20 dB/decade from 3m to 1m.  
 Distance extrapolation factor =  $20 \log(\text{specific distance [3m]} / \text{test distance [1m]})$  (dB)
3. Follow the guidelines in ANSI C63.4-2003 with respect to maximizing the emission by rotating the EUT, measuring the emission for three EUT orthogonal planes, and adjusting the measurement antenna height and polarization. A pre-amp and a high pass filter are used for this test in order to get the good signal level.

### 3.7.4 Test Setup

For radiated emissions below 30MHz

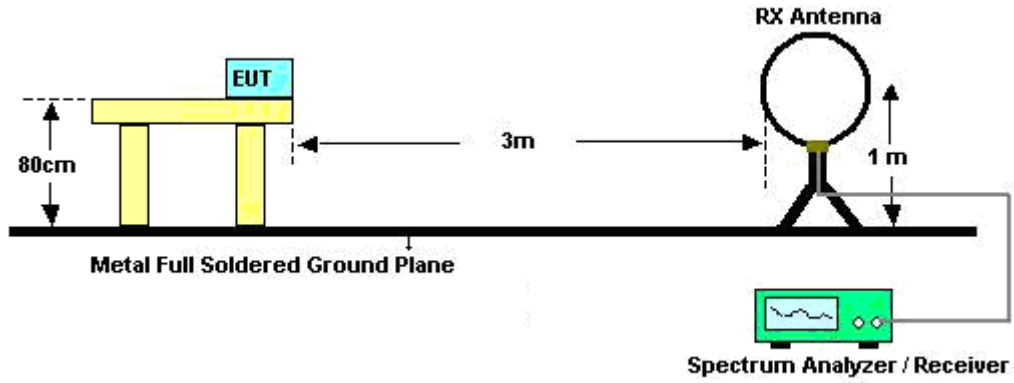

For radiated emissions above 30MHz

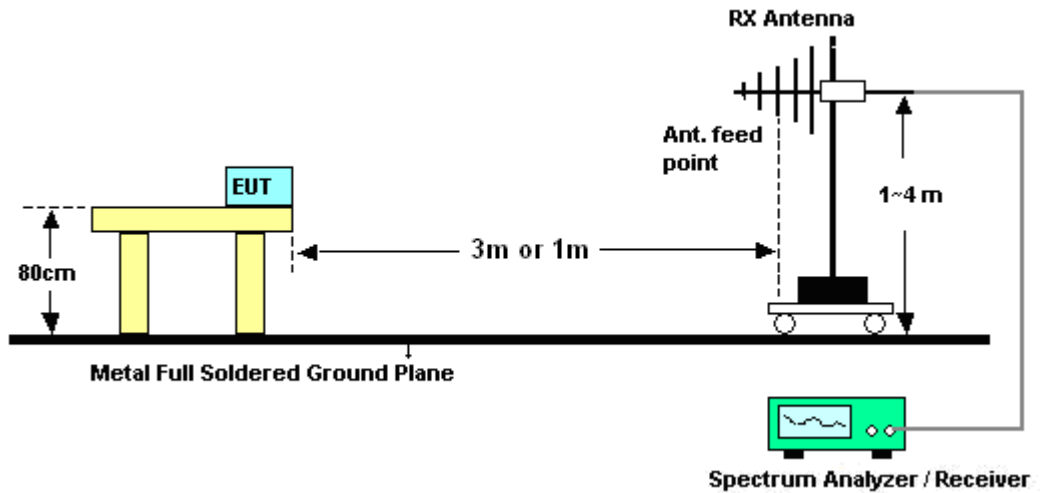





3.7.5 Test Results of Radiated Emissions (9 kHz ~ 30 MHz)

Test Engineer :	Ivan Jiang	Temperature :	23.8~24.0°C	
		Relative Humidity :	49~50%	
Frequency (MHz)	Level (dBuV)	Over Limit (dB)	Limit Line (dBuV)	Remark
-	-	-	-	See Note

Note:

The amplitude of spurious emissions that are attenuated by more than 20dB below the permissible value has no need to be reported.

Distance extrapolation factor =  $40 \log(\text{specific distance} / \text{test distance})$  (dB);

Limit line = specific limits (dBuV) + distance extrapolation factor.



3.7.6 Test Result of Radiated Emission (30 MHz ~ 10<sup>th</sup> Harmonic)

Test Mode :	Mode 1	Temperature :	23.8~24.0°C
Test Channel :	01	Relative Humidity :	49~50%
Test Engineer :	Ivan Jiang	Polarization :	Horizontal
Remark :	2412 MHz is Fundamental Signals which can be ignored.		

Frequency ( MHz )	Level ( dBuV/m )	Over Limit ( dB )	Limit Line ( dBuV/m )	Read Level ( dBuV )	Antenna Factor ( dB )	Cable Loss ( dB )	Preamp Factor ( dB )	Ant Pos ( cm )	Table Pos ( deg )	Remark
173.10	24.13	-19.37	43.50	44.88	9.53	1.24	31.52	-	-	Peak
242.49	27.61	-18.39	46.00	45.38	12.12	1.53	31.42	-	-	Peak
298.65	31.41	-14.59	46.00	47.54	13.44	1.76	31.33	100	44	Peak
400.10	22.37	-23.63	46.00	34.83	16.58	2.14	31.18	-	-	Peak
481.30	27.11	-18.89	46.00	37.88	17.91	2.38	31.06	-	-	Peak
872.60	25.68	-20.32	46.00	29.79	23.31	3.30	30.72	-	-	Peak
2371.94	46.38	-27.62	74.00	41.76	32.16	5.99	33.53	144	14	Peak
2371.94	33.65	-20.35	54.00	29.03	32.16	5.99	33.53	144	14	Average
2412.00	78.43	-	-	73.70	32.20	6.07	33.54	144	14	Peak
2412.00	58.12	-	-	53.39	32.20	6.07	33.54	144	14	Average
2484.00	33.13	-20.87	54.00	28.23	32.28	6.18	33.56	144	14	Average
2484.00	45.86	-28.14	74.00	40.96	32.28	6.18	33.56	144	14	Peak



<b>Test Mode :</b>	Mode 1	<b>Temperature :</b>	23.8~24.0°C
<b>Test Channel :</b>	01	<b>Relative Humidity :</b>	49~50%
<b>Test Engineer :</b>	Ivan Jiang	<b>Polarization :</b>	Vertical
<b>Remark :</b>	2412 MHz is Fundamental Signals which can be ignored.		

Frequency ( MHz )	Level ( dBuV/m )	Over Limit ( dB )	Limit Line ( dBuV/m )	Read Level ( dBuV )	Antenna Factor ( dB )	Cable Loss ( dB )	Preamp Factor ( dB )	Ant Pos ( cm )	Table Pos ( deg )	Remark
40.53	26.16	-13.84	40.00	44.54	12.50	0.63	31.51	105	129	Peak
71.85	21.20	-18.80	40.00	45.45	6.46	0.84	31.55	-	-	Peak
279.21	21.72	-24.28	46.00	38.30	13.13	1.64	31.35	-	-	Peak
453.30	19.24	-26.76	46.00	30.58	17.44	2.31	31.09	-	-	Peak
576.50	21.60	-24.40	46.00	30.53	19.40	2.62	30.95	-	-	Peak
811.00	25.08	-20.92	46.00	30.01	22.59	3.17	30.69	-	-	Peak
2358.26	46.40	-27.60	74.00	41.80	32.13	5.99	33.52	171	290	Peak
2358.26	33.65	-20.35	54.00	29.05	32.13	5.99	33.52	171	290	Average
2412.00	77.00	-	-	72.27	32.20	6.07	33.54	171	290	Peak
2412.00	57.23	-	-	52.50	32.20	6.07	33.54	171	290	Average
2492.00	33.13	-20.87	54.00	28.22	32.30	6.18	33.57	171	290	Average
2492.00	45.04	-28.96	74.00	40.13	32.30	6.18	33.57	171	290	Peak



<b>Test Mode :</b>	Mode 2	<b>Temperature :</b>	23.8~24.0°C
<b>Test Channel :</b>	06	<b>Relative Humidity :</b>	49~50%
<b>Test Engineer :</b>	Ivan Jiang	<b>Polarization :</b>	Horizontal
<b>Remark :</b>	2437 MHz is Fundamental Signals which can be ignored.		

Frequency ( MHz )	Level ( dBuV/m )	Over Limit ( dB )	Limit Line ( dBuV/m )	Read Level ( dBuV )	Antenna Factor ( dB )	Cable Loss ( dB )	Preamp Factor ( dB )	Ant Pos ( cm )	Table Pos ( deg )	Remark
173.10	20.92	-22.58	43.50	41.67	9.53	1.24	31.52	-	-	Peak
242.49	27.14	-18.86	46.00	44.91	12.12	1.53	31.42	-	-	Peak
281.37	30.48	-15.52	46.00	47.02	13.17	1.64	31.35	100	87	Peak
399.40	24.39	-21.61	46.00	36.87	16.56	2.14	31.18	-	-	Peak
598.20	21.62	-24.38	46.00	30.12	19.74	2.68	30.92	-	-	Peak
813.80	27.30	-18.70	46.00	32.18	22.63	3.18	30.69	-	-	Peak
2374.00	45.54	-28.46	74.00	40.92	32.16	5.99	33.53	144	14	Peak
2374.00	33.63	-20.37	54.00	29.01	32.16	5.99	33.53	144	14	Average
2437.00	78.70	-	-	73.90	32.24	6.11	33.55	144	14	Peak
2437.00	58.16	-	-	53.36	32.24	6.11	33.55	144	14	Average
2484.00	45.62	-28.38	74.00	40.72	32.28	6.18	33.56	144	14	Peak
2484.00	33.12	-20.88	54.00	28.22	32.28	6.18	33.56	144	14	Average



<b>Test Mode :</b>	Mode 2	<b>Temperature :</b>	23.8~24.0°C
<b>Test Channel :</b>	06	<b>Relative Humidity :</b>	49~50%
<b>Test Engineer :</b>	Ivan Jiang	<b>Polarization :</b>	Vertical
<b>Remark :</b>	2437 MHz is Fundamental Signals which can be ignored.		

Frequency ( MHz )	Level ( dBuV/m )	Over Limit ( dB )	Limit Line ( dBuV/m )	Read Level ( dBuV )	Antenna Factor ( dB )	Cable Loss ( dB )	Preamp Factor ( dB )	Ant Pos ( cm )	Table Pos ( deg )	Remark
40.26	27.86	-12.14	40.00	46.24	12.50	0.63	31.51	100	216	Peak
72.93	21.16	-18.84	40.00	45.32	6.54	0.85	31.55	-	-	Peak
172.02	23.88	-19.62	43.50	44.52	9.65	1.23	31.52	-	-	Peak
562.50	21.01	-24.99	46.00	30.20	19.19	2.59	30.97	-	-	Peak
694.10	25.92	-20.08	46.00	33.00	20.82	2.93	30.83	-	-	Peak
845.30	27.01	-18.99	46.00	31.48	23.00	3.26	30.73	-	-	Peak
2382.00	46.67	-27.33	74.00	42.01	32.16	6.03	33.53	168	291	Peak
2382.00	33.66	-20.34	54.00	29.00	32.16	6.03	33.53	168	291	Average
2437.00	55.73	-	-	50.93	32.24	6.11	33.55	168	291	Average
2437.00	74.95	-	-	70.15	32.24	6.11	33.55	168	291	Peak
2500.00	45.01	-28.99	74.00	40.10	32.30	6.18	33.57	168	291	Peak
2500.00	33.12	-20.88	54.00	28.21	32.30	6.18	33.57	168	291	Average



<b>Test Mode :</b>	Mode 3	<b>Temperature :</b>	23.8~24.0°C
<b>Test Channel :</b>	11	<b>Relative Humidity :</b>	49~50%
<b>Test Engineer :</b>	Ivan Jiang	<b>Polarization :</b>	Horizontal
<b>Remark :</b>	2462 MHz is Fundamental Signals which can be ignored.		

Frequency ( MHz )	Level ( dBuV/m )	Over Limit ( dB )	Limit Line ( dBuV/m )	Read Level ( dBuV )	Antenna Factor ( dB )	Cable Loss ( dB )	Preamp Factor ( dB )	Ant Pos ( cm )	Table Pos ( deg )	Remark
42.69	22.44	-17.56	40.00	41.71	11.59	0.64	31.50	-	-	Peak
213.33	27.31	-16.19	43.50	47.34	10.06	1.38	31.47	-	-	Peak
285.69	33.54	-12.46	46.00	49.96	13.24	1.67	31.33	112	165	Peak
397.30	27.28	-18.72	46.00	39.83	16.50	2.14	31.19	-	-	Peak
575.80	20.82	-25.18	46.00	29.75	19.40	2.62	30.95	-	-	Peak
864.20	25.55	-20.45	46.00	29.77	23.21	3.29	30.72	-	-	Peak
2374.00	45.86	-28.14	74.00	41.24	32.16	5.99	33.53	117	9	Peak
2374.00	33.64	-20.36	54.00	29.02	32.16	5.99	33.53	117	9	Average
2462.00	56.15	-	-	51.31	32.26	6.14	33.56	117	9	Average
2462.00	75.46	-	-	70.62	32.26	6.14	33.56	117	9	Peak
2484.42	45.98	-28.02	74.00	41.08	32.28	6.18	33.56	117	9	Peak
2484.42	33.12	-20.88	54.00	28.22	32.28	6.18	33.56	117	9	Average



<b>Test Mode :</b>	Mode 3	<b>Temperature :</b>	23.8~24.0°C
<b>Test Channel :</b>	11	<b>Relative Humidity :</b>	49~50%
<b>Test Engineer :</b>	Ivan Jiang	<b>Polarization :</b>	Vertical
<b>Remark :</b>	2462 MHz is Fundamental Signals which can be ignored.		

Frequency ( MHz )	Level ( dBuV/m )	Over Limit ( dB )	Limit Line ( dBuV/m )	Read Level ( dBuV )	Antenna Factor ( dB )	Cable Loss ( dB )	Preamp Factor ( dB )	Ant Pos ( cm )	Table Pos ( deg )	Remark
41.34	28.41	-11.59	40.00	47.25	12.04	0.63	31.51	100	258	Peak
74.01	22.20	-17.80	40.00	46.26	6.63	0.85	31.54	-	-	Peak
168.78	24.99	-18.51	43.50	45.45	9.83	1.23	31.52	-	-	Peak
399.40	21.03	-24.97	46.00	33.51	16.56	2.14	31.18	-	-	Peak
598.90	26.25	-19.75	46.00	34.75	19.74	2.68	30.92	-	-	Peak
696.90	26.51	-19.49	46.00	33.54	20.86	2.93	30.82	-	-	Peak
2390.00	45.48	-28.52	74.00	40.80	32.18	6.03	33.53	100	293	Peak
2390.00	33.72	-20.28	54.00	29.04	32.18	6.03	33.53	100	293	Average
2462.00	54.49	-	-	49.65	32.26	6.14	33.56	100	293	Average
2462.00	72.77	-	-	67.93	32.26	6.14	33.56	100	293	Peak
2491.45	45.42	-28.58	74.00	40.51	32.30	6.18	33.57	100	293	Peak
2491.45	33.14	-20.86	54.00	28.23	32.30	6.18	33.57	100	293	Average



<b>Test Mode :</b>	Mode 4	<b>Temperature :</b>	23.8~24.0°C
<b>Test Channel :</b>	01	<b>Relative Humidity :</b>	49~50%
<b>Test Engineer :</b>	Ivan Jiang	<b>Polarization :</b>	Horizontal
<b>Remark :</b>	2412 MHz is Fundamental Signals which can be ignored.		

Frequency ( MHz )	Level ( dBuV/m )	Over Limit ( dB )	Limit Line ( dBuV/m )	Read Level ( dBuV )	Antenna Factor ( dB )	Cable Loss ( dB )	Preamp Factor ( dB )	Ant Pos ( cm )	Table Pos ( deg )	Remark
172.29	23.06	-20.44	43.50	43.75	9.59	1.24	31.52	-	-	Peak
242.22	27.90	-18.10	46.00	45.67	12.12	1.53	31.42	-	-	Peak
280.02	33.41	-12.59	46.00	49.97	13.15	1.64	31.35	110	59	Peak
441.40	23.41	-22.59	46.00	35.00	17.25	2.28	31.12	-	-	Peak
794.20	27.38	-18.62	46.00	32.55	22.38	3.13	30.68	-	-	Peak
929.30	28.00	-18.00	46.00	31.21	24.00	3.41	30.62	-	-	Peak
2336.98	46.23	-27.77	74.00	41.69	32.11	5.95	33.52	102	232	Peak
2336.98	33.56	-20.44	54.00	29.02	32.11	5.95	33.52	102	232	Average
2412.00	68.36	-	-	63.63	32.20	6.07	33.54	102	232	Peak
2412.00	41.52	-	-	36.79	32.20	6.07	33.54	102	232	Average
2484.00	33.10	-20.90	54.00	28.20	32.28	6.18	33.56	102	232	Average
2484.00	44.86	-29.14	74.00	39.96	32.28	6.18	33.56	102	232	Peak





<b>Test Mode :</b>	Mode 4	<b>Temperature :</b>	23.8~24.0°C
<b>Test Channel :</b>	01	<b>Relative Humidity :</b>	49~50%
<b>Test Engineer :</b>	Ivan Jiang	<b>Polarization :</b>	Vertical
<b>Remark :</b>	2412 MHz is Fundamental Signals which can be ignored.		

Frequency ( MHz )	Level ( dBuV/m )	Over Limit ( dB )	Limit Line ( dBuV/m )	Read Level ( dBuV )	Antenna Factor ( dB )	Cable Loss ( dB )	Preamp Factor ( dB )	Ant Pos ( cm )	Table Pos ( deg )	Remark
40.26	28.33	-11.67	40.00	46.71	12.50	0.63	31.51	102	242	Peak
169.05	24.41	-19.09	43.50	44.87	9.83	1.23	31.52	-	-	Peak
297.30	23.25	-22.75	46.00	39.40	13.43	1.75	31.33	-	-	Peak
399.40	22.20	-23.80	46.00	34.68	16.56	2.14	31.18	-	-	Peak
699.70	26.05	-19.95	46.00	33.05	20.88	2.94	30.82	-	-	Peak
806.10	25.38	-20.62	46.00	30.37	22.54	3.16	30.69	-	-	Peak
2374.41	33.63	-20.37	54.00	29.01	32.16	5.99	33.53	170	291	Average
2374.41	46.61	-27.39	74.00	41.99	32.16	5.99	33.53	170	291	Peak
2412.00	67.50	-	-	62.77	32.20	6.07	33.54	170	291	Peak
2412.00	40.39	-	-	35.66	32.20	6.07	33.54	170	291	Average
2484.00	45.17	-28.83	74.00	40.27	32.28	6.18	33.56	170	291	Peak
2484.00	33.10	-20.90	54.00	28.20	32.28	6.18	33.56	170	291	Average



<b>Test Mode :</b>	Mode 5	<b>Temperature :</b>	23.8~24.0°C
<b>Test Channel :</b>	06	<b>Relative Humidity :</b>	49~50%
<b>Test Engineer :</b>	Ivan Jiang	<b>Polarization :</b>	Horizontal
<b>Remark :</b>	2437 MHz is Fundamental Signals which can be ignored.		

Frequency ( MHz )	Level ( dBuV/m )	Over Limit ( dB )	Limit Line ( dBuV/m )	Read Level ( dBuV )	Antenna Factor ( dB )	Cable Loss ( dB )	Preamp Factor ( dB )	Ant Pos ( cm )	Table Pos ( deg )	Remark
170.13	20.83	-22.67	43.50	41.35	9.77	1.23	31.52	-	-	Peak
241.14	27.32	-18.68	46.00	45.16	12.05	1.53	31.42	-	-	Peak
287.85	31.52	-14.48	46.00	47.90	13.27	1.68	31.33	100	144	Peak
512.10	20.29	-25.71	46.00	30.46	18.41	2.47	31.05	-	-	Peak
786.50	26.80	-19.20	46.00	32.11	22.26	3.12	30.69	-	-	Peak
895.70	28.25	-17.75	46.00	32.05	23.57	3.33	30.70	-	-	Peak
2382.00	46.15	-27.85	74.00	41.49	32.16	6.03	33.53	121	29	Peak
2382.00	33.66	-20.34	54.00	29.00	32.16	6.03	33.53	121	29	Average
2437.00	69.66	-	-	64.86	32.24	6.11	33.55	121	29	Peak
2437.00	40.92	-	-	36.12	32.24	6.11	33.55	121	29	Average
2484.00	45.98	-28.02	74.00	41.08	32.28	6.18	33.56	121	29	Peak
2484.00	33.11	-20.89	54.00	28.21	32.28	6.18	33.56	121	29	Average



<b>Test Mode :</b>	Mode 5	<b>Temperature :</b>	23.8~24.0°C
<b>Test Channel :</b>	06	<b>Relative Humidity :</b>	49~50%
<b>Test Engineer :</b>	Ivan Jiang	<b>Polarization :</b>	Vertical
<b>Remark :</b>	2437 MHz is Fundamental Signals which can be ignored.		

Frequency ( MHz )	Level ( dBuV/m )	Over Limit ( dB )	Limit Line ( dBuV/m )	Read Level ( dBuV )	Antenna Factor ( dB )	Cable Loss ( dB )	Preamp Factor ( dB )	Ant Pos ( cm )	Table Pos ( deg )	Remark
40.26	28.67	-11.33	40.00	47.05	12.50	0.63	31.51	122	263	Peak
171.21	23.55	-19.95	43.50	44.19	9.65	1.23	31.52	-	-	Peak
240.06	22.20	-23.80	46.00	40.11	11.98	1.53	31.42	-	-	Peak
489.70	25.17	-20.83	46.00	35.77	18.05	2.41	31.06	-	-	Peak
699.70	29.16	-16.84	46.00	36.16	20.88	2.94	30.82	-	-	Peak
892.20	28.78	-17.22	46.00	32.61	23.54	3.33	30.70	-	-	Peak
2316.00	45.88	-28.12	74.00	41.40	32.07	5.92	33.51	171	292	Peak
2316.00	33.49	-20.51	54.00	29.01	32.07	5.92	33.51	171	292	Average
2437.00	65.30	-	-	60.50	32.24	6.11	33.55	171	292	Peak
2437.00	40.38	-	-	35.58	32.24	6.11	33.55	171	292	Average
2484.00	44.88	-29.12	74.00	39.98	32.28	6.18	33.56	171	292	Peak
2484.00	33.10	-20.90	54.00	28.20	32.28	6.18	33.56	171	292	Average



<b>Test Mode :</b>	Mode 6	<b>Temperature :</b>	23.8~24.0°C
<b>Test Channel :</b>	11	<b>Relative Humidity :</b>	49~50%
<b>Test Engineer :</b>	Ivan Jiang	<b>Polarization :</b>	Horizontal
<b>Remark :</b>	2462 MHz is Fundamental Signals which can be ignored.		

Frequency ( MHz )	Level ( dBuV/m )	Over Limit ( dB )	Limit Line ( dBuV/m )	Read Level ( dBuV )	Antenna Factor ( dB )	Cable Loss ( dB )	Preamp Factor ( dB )	Ant Pos ( cm )	Table Pos ( deg )	Remark
43.77	22.11	-17.89	40.00	41.84	11.13	0.64	31.50	-	-	Peak
242.49	26.67	-19.33	46.00	44.44	12.12	1.53	31.42	-	-	Peak
276.78	29.71	-16.29	46.00	46.34	13.09	1.64	31.36	100	311	Peak
385.40	25.89	-20.11	46.00	38.90	16.11	2.11	31.23	-	-	Peak
621.30	21.66	-24.34	46.00	29.80	20.01	2.75	30.90	-	-	Peak
808.90	28.22	-17.78	46.00	33.18	22.57	3.16	30.69	-	-	Peak
2316.00	46.11	-27.89	74.00	41.63	32.07	5.92	33.51	112	12	Peak
2316.00	33.49	-20.51	54.00	29.01	32.07	5.92	33.51	112	12	Average
2462.00	41.32	-	-	36.48	32.26	6.14	33.56	112	12	Average
2462.00	69.39	-	-	64.55	32.26	6.14	33.56	112	12	Peak
2485.18	45.76	-28.24	74.00	40.86	32.28	6.18	33.56	112	12	Peak
2485.18	33.12	-20.88	54.00	28.22	32.28	6.18	33.56	112	12	Average



<b>Test Mode :</b>	Mode 6	<b>Temperature :</b>	23.8~24.0°C
<b>Test Channel :</b>	11	<b>Relative Humidity :</b>	49~50%
<b>Test Engineer :</b>	Ivan Jiang	<b>Polarization :</b>	Vertical
<b>Remark :</b>	2462 MHz is Fundamental Signals which can be ignored.		

Frequency ( MHz )	Level ( dBuV/m )	Over Limit ( dB )	Limit Line ( dBuV/m )	Read Level ( dBuV )	Antenna Factor ( dB )	Cable Loss ( dB )	Preamp Factor ( dB )	Ant Pos ( cm )	Table Pos ( deg )	Remark
76.98	25.49	-14.51	40.00	49.29	6.88	0.86	31.54	114	195	Peak
170.94	26.01	-17.49	43.50	46.59	9.71	1.23	31.52	-	-	Peak
277.05	24.03	-21.97	46.00	40.65	13.10	1.64	31.36	-	-	Peak
531.00	19.81	-26.19	46.00	29.63	18.69	2.51	31.02	-	-	Peak
724.20	26.14	-19.86	46.00	32.63	21.27	3.00	30.76	-	-	Peak
878.20	27.42	-18.58	46.00	31.45	23.37	3.31	30.71	-	-	Peak
2372.00	46.35	-27.65	74.00	41.73	32.16	5.99	33.53	100	292	Peak
2372.00	33.66	-20.34	54.00	29.04	32.16	5.99	33.53	100	292	Average
2462.00	39.98	-	-	35.14	32.26	6.14	33.56	100	292	Average
2462.00	64.67	-	-	59.83	32.26	6.14	33.56	100	292	Peak
2486.70	45.73	-28.27	74.00	40.83	32.28	6.18	33.56	100	292	Peak
2486.70	33.13	-20.87	54.00	28.23	32.28	6.18	33.56	100	292	Average



## **3.8 Antenna Requirements**

### **3.8.1 Standard Applicable**

If directional gain of transmitting antennas is greater than 6dBi, the power shall be reduced by the same level in dB comparing to gain minus 6dBi. For the fixed point-to-point operation, the power shall be reduced by one dB for every 3 dB that the directional gain of the antenna exceeds 6 dBi. The use of a permanently attached antenna or of an antenna that uses a unique coupling to the intentional radiator shall be considered sufficient to comply with the FCC rule.

### **3.8.2 Antenna Connected Construction**

The antennas type used in this product is Chip Antenna without connector and it is considered to meet antenna requirement.

### **3.8.3 Antenna Gain**

The antenna peak gain of EUT is less than 6 dBi. Therefore, it is not necessary to reduce maximum peak output power limit.

## 4 List of Measuring Equipment

Instrument	Manufacturer	Model No.	Serial No.	Characteristics	Calibration Date	Due Date	Remark
Spectrum Analyzer	R&S	FSP30	101329	9kHz~30GHz	Apr. 26, 2010	Apr. 25, 2011	Conducted (TH02-HY)
Power Meter	Anritsu	ML2495A	0932001	N/A	Sep. 13, 2010	Sep. 12, 2011	Conducted (TH02-HY)
Power Sensor	Anritsu	MA2411B	0846202	N/A	Sep. 14, 2010	Sep. 13, 2011	Conducted (TH02-HY)
EMI Test Receive	R&S	ESCS 30	100356	9KHz – 2.75GHz	Aug. 16, 2010	Aug. 15, 2011	Conduction (CO05-HY)
Two-LISN	R&S	ENV216	11-100081	9kHz~30MHz	Nov. 30, 2009	Nov. 29, 2010	Conduction (CO05-HY)
AC Power Source	APC	APC-1000W	N/A	N/A	N/A	N/A	Conduction (CO05-HY)
WiMAX Base Station (System Simulator)	Agilent	E6651A	N/A	N/A	N/A	N/A	Conduction (CO05-HY)
Bilog Antenna	SCHAFFNER	CBL6111C	2726	30MHz ~ 1GHz	Oct. 31, 2010	Oct. 30, 2011	Radiation (03CH07-HY)
Spectrum Analyzer	R&S	FSP	101067	9KHz ~ 30GHz	Dec. 04, 2009	Dec. 03, 2010	Radiation (03CH07-HY)
Double Ridge Horn Antenna	ESCO	3117	00075962	1GHz ~ 18GHz	Aug. 19, 2010	Aug. 18, 2011	Radiation (03CH07-HY)
SHF-EHF Horn Antenna	SCHWARZBECK	BBHA 9170	BBHA9170251	15GHz- 40GHz	Oct. 18, 2010	Oct. 17, 2011	Radiation (03CH07-HY)
Pre Amplifier	Agilent	8449B	3008A02362	1GHz~ 26.5GHz	Dec.09,2009	Dec. 08, 2010	Radiation (03CH07-HY)
Pre Amplifier	COM-POWER	PA-103A	161241	10-1000MHz.32 dB.GAIN	Mar. 27, 2010	Mar. 26, 2011	Radiation (03CH07-HY)
Loop Antenna	R&S	HFH2-Z2	860004/001	9 kHz~30 MHz	Jul. 29, 2010	Jul. 28, 2011	Radiation (03CH07-HY)

## 5 Uncertainty of Evaluation

### Uncertainty of Conducted Emission Measurement (150 kHz ~ 30 MHz)

Contribution	Uncertainty of $X_i$		$u(X_i)$
	dB	Probability Distribution	
Receiver Reading	0.10	Normal (k=2)	0.05
Cable Loss	0.10	Normal (k=2)	0.05
AMN Insertion Loss	2.50	Rectangular	0.63
Receiver Specification	1.50	Rectangular	0.43
Site Imperfection	1.39	Rectangular	0.80
Mismatch	+0.34 / -0.35	U-Shape	0.24
<b>Combined Standard Uncertainty <math>U_c(y)</math></b>	<b>1.13</b>		
<b>Measuring Uncertainty for a Level of Confidence of 95% (<math>U = 2U_c(y)</math>)</b>	<b>2.26</b>		

### Uncertainty of Radiated Emission Measurement (30 MHz ~ 1000 MHz)

Contribution	Uncertainty of $X_i$		$u(X_i)$
	dB	Probability Distribution	
Receiver Reading	0.41	Normal (k=2)	0.21
Antenna Factor Calibration	0.83	Normal (k=2)	0.42
Cable Loss Calibration	0.25	Normal (k=2)	0.13
Pre-Amplifier Gain Calibration	0.27	Normal (k=2)	0.14
RCV/SPA Specification	2.50	Rectangular	0.72
Antenna Factor Interpolation for Frequency	1.00	Rectangular	0.29
Site Imperfection	1.43	Rectangular	0.83
Mismatch	+0.39 / -0.41	U-Shape	0.28
<b>Combined Standard Uncertainty <math>U_c(y)</math></b>	<b>1.27</b>		
<b>Measuring Uncertainty for a Level of Confidence of 95% (<math>U = 2U_c(y)</math>)</b>	<b>2.54</b>		



**Uncertainty of Radiated Emission Measurement (1 GHz ~ 40 GHz)**

Contribution	Uncertainty of $X_i$		$u(X_i)$	$C_i$	$C_i * u(X_i)$
	dB	Probability Distribution			
Receiver Reading	±0.10	Normal (k=2)	0.10	1	0.10
Antenna Factor Calibration	±1.70	Normal (k=2)	0.85	1	0.85
Cable Loss Calibration	±0.50	Normal (k=2)	0.25	1	0.25
Receiver Correction	±2.00	Rectangular	1.15	1	1.15
Antenna Factor Directional	±1.50	Rectangular	0.87	1	0.87
Site Imperfection	±2.80	Triangular	1.14	1	1.14
Mismatch Receiver VSWR $\Gamma_1 = 0.197$ Antenna VSWR $\Gamma_2 = 0.194$ Uncertainty = $20\text{Log}(1-\Gamma_1*\Gamma_2)$	+0.34 / -0.35	U-Shape	0.244	1	0.244
<b>Combined Standard Uncertainty <math>U_c(y)</math></b>	<b>2.36</b>				
<b>Measuring Uncertainty for a Level of Confidence of 95% (<math>U = 2U_c(y)</math>)</b>	<b>4.72</b>				



## **Appendix A. Photographs of EUT**

Please refer to Sporton report number EP000616 as below.