

FCC RF Test Report

APPLICANT : Green Packet Berhad, Taiwan
EQUIPMENT : TDD-LTE Band 41 Indoor CPE
BRAND NAME : Green Packet
MODEL NAME : DT-235
FCC ID : W9V-DT235-GP
STANDARD : 47 CFR Part 2, 27
CLASSIFICATION : Licensed Non-Broadcast Station Transmitter (TNB)

The product was received on Jan. 24, 2014 and testing was completed on Mar. 12, 2014. We, SPORTON INTERNATIONAL INC., would like to declare that the tested sample has been evaluated in accordance with the procedures given in ANSI / TIA / EIA-603-C-2004 and shown to be compliant with the applicable technical standards.

The test results in this report apply exclusively to the tested model / sample. Without written approval of SPORTON INTERNATIONAL INC., the test report shall not be reproduced except in full.



Reviewed by: Joseph Lin / Supervisor

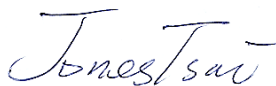

Approved by: Jones Tsai / Manager



SPORTON INTERNATIONAL INC.

No. 52, Hwa Ya 1st Rd., Hwa Ya Technology Park, Kwei-Shan Hsiang, Tao Yuan Hsien, Taiwan, R.O.C.



TABLE OF CONTENTS

REVISION HISTORY..... 3

SUMMARY OF TEST RESULT 4

1 GENERAL DESCRIPTION 5

 1.1 Applicant 5

 1.2 Manufacturer 5

 1.3 Feature of Equipment Under Test 5

 1.4 Product Specification of Equipment Under Test 5

 1.5 Modification of EUT 5

 1.6 Emission Designator 6

 1.7 Testing Site 6

 1.8 Applied Standards 7

2 TEST CONFIGURATION OF EQUIPMENT UNDER TEST 8

 2.1 Test Mode 8

 2.2 Connection Diagram of Test System 8

 2.3 Support Unit used in test configuration and system 9

 2.4 Measurement Results Explanation Example 9

3 TEST RESULT 10

 3.1 Conducted Output Power Measurement and EIRP Measurement 10

 3.2 Occupied Bandwidth 15

 3.3 Conducted Band Edge Measurement 40

 3.4 Conducted Spurious Emission Measurement 57

 3.5 Radiated Spurious Emission Measurement 82

 3.6 Frequency Stability Measurement 92

4 LIST OF MEASURING EQUIPMENT 94

5 UNCERTAINTY OF EVALUATION 95

APPENDIX A. SETUP PHOTOGRAPHS



REVISION HISTORY

REPORT NO.	VERSION	DESCRIPTION	ISSUED DATE
FG412441	Rev. 01	Initial issue of report	Mar. 28, 2014



SUMMARY OF TEST RESULT

Report Section	FCC Rule	IC Rule	Description	Limit	Result	Remark
3.1	§2.1046	RSS-199 (4.4)	Conducted Output Power	Reporting Only	PASS	-
	§27.50(h)(2)	RSS-199 (4.4)	Equivalent Isotropic Radiated Power	EIRP < 2Watt	PASS	-
3.2	§2.1049 §27.53(l)(4)	RSS-GEN(4.6.1) RSS-199 (4.2)	Occupied Bandwidth	Reporting Only	PASS	-
3.3	§2.1051 §27.53(l)(4)	RSS-GEN(4.9) RSS-199 (4.5)	Conducted Band Edge Measurement	< 43+10log10(P[Watts])	PASS	-
3.4	§2.1051 §27.53(l)(4)	RSS-GEN(4.9) RSS-199 (4.5)	Conducted Spurious Emission	< 55+10log10(P[Watts])	PASS	-
3.5	§2.1053 §27.53(l)(4)	RSS-GEN(4.9) RSS-199 (4.5)	Radiated Spurious Emission	< 55+10log10(P[Watts])	PASS	Under limit 0.16 dB at 8028.000 MHz
3.6	§2.1055 §27.54	RSS-GEN(4.7) RSS-199 (4.3)	Frequency Stability Temperature & Voltage	< 2.5 ppm	PASS	-

1 General Description

1.1 Applicant

Green Packet Berhad, Taiwan

6F., No. 21, Lane 583, Rueiguang Rd. Neihu District, Taipei City 11492, Taiwan

1.2 Manufacturer

Green Packet Berhad, Taiwan

6F., No. 21, Lane 583, Rueiguang Rd. Neihu District, Taipei City 11492, Taiwan

1.3 Feature of Equipment Under Test

Product Feature	
Equipment	TDD-LTE Band 41 Indoor CPE
Brand Name	Green Packet
Model Name	DT-235
FCC ID	W9V-DT235-GP
EUT supports Radios application	LTE/ WLAN 11b/g/n (HT20/HT40)
EUT Stage	Production Unit

Remark: The above EUT's information was declared by manufacturer. Please refer to the specifications or user's manual for more detailed description.

1.4 Product Specification of Equipment Under Test

Product Specification subjective to this standard	
Tx Frequency	2498.5 MHz ~ 2687.5 MHz
Rx Frequency	2498.5 MHz ~ 2687.5 MHz
Bandwidth	5MHz / 10MHz / 15MHz / 20MHz
Maximum Output Power to Antenna	22.68 dBm / 0.1854 W
Antenna Type	Directional Antenna
Antenna Gain	6.90 dBi
Type of Modulation	QPSK / 16QAM 64QAM(Downlink only)

1.5 Modification of EUT

No modifications are made to the EUT during all test items.



1.6 Emission Designator

FCC Rule	System	Type of Modulation	BW	Emission Designator	Frequency Tolerance (ppm)	Maximum EIRP (W)
Part 27	LTE Band 41	QPSK	5MHz	4M60G7D	-	0.90
Part 27	LTE Band 41	16QAM	5MHz	4M54D7W	-	0.86
Part 27	LTE Band 41	QPSK	10MHz	9M32G7D	0.0044 ppm	0.91
Part 27	LTE Band 41	16QAM	10MHz	9M36D7W	-	0.83
Part 27	LTE Band 41	QPSK	15MHz	13M7G7D	-	0.86
Part 27	LTE Band 41	16QAM	15MHz	13M7D7W	-	0.85
Part 27	LTE Band 41	QPSK	20MHz	18M6G7D	-	0.78
Part 27	LTE Band 41	16QAM	20MHz	18M6D7W	-	0.76

1.7 Testing Site

Test Site	SPORTON INTERNATIONAL INC.		
Test Site Location	No. 52, Hwa Ya 1 st Rd., Hwa Ya Technology Park, Kwei-Shan Hsiang, Tao Yuan Hsien, Taiwan, R.O.C. TEL: +886-3-327-3456 FAX: +886-3-328-4978		
Test Site No.	Sporton Site No.		FCC/IC Registration No.
	TH02-HY	03CH07-HY	TW1022/4086B-1



1.8 Applied Standards

According to the specifications of the manufacturer, the EUT must comply with the requirements of the following standards:

- ♦ 47 CFR Part 2, 27
- ♦ ANSI / TIA / EIA-603-C-2004
- ♦ FCC KDB 971168 D01 Power Meas. License Digital Systems v02r01
- ♦ FCC KDB 412172 D01 Determining ERP and ERIP v01

Remark:

1. All test items were verified and recorded according to the standards and without any deviation during the test.
2. This EUT has also been tested and complied with the requirements of FCC Part 15, Subpart B, recorded in a separate test report.

2 Test Configuration of Equipment Under Test

2.1 Test Mode

During all testing, EUT is in link mode with base station emulator at maximum power level. The spurious emission measurements were carried out in semi-anechoic chamber with 3-meter test range.

Frequency range investigated for radiated emission: 30MHz to 10th harmonic.

Test Modes			
Band	Radiated TCs	Conducted TCs	
LTE Band 41	BW 5MHz	<ul style="list-style-type: none"> ■ LTE (RB Size 1) Link 	<ul style="list-style-type: none"> ■ LTE (RB Size 1) Link ■ LTE (RB Size 12) Link ■ LTE (RB Size 25) Link
	BW 10MHz	<ul style="list-style-type: none"> ■ LTE (RB Size 1) Link 	<ul style="list-style-type: none"> ■ LTE (RB Size 1) Link ■ LTE (RB Size 25) Link ■ LTE (RB Size 50) Link
	BW 15MHz	<ul style="list-style-type: none"> ■ LTE (RB Size 1) Link 	<ul style="list-style-type: none"> ■ LTE (RB Size 1) Link ■ LTE (RB Size 36) Link ■ LTE (RB Size 75) Link
	BW 20MHz	<ul style="list-style-type: none"> ■ LTE (RB Size 1) Link 	<ul style="list-style-type: none"> ■ LTE (RB Size 1) Link ■ LTE (RB Size 50) Link ■ LTE (RB Size 100) Link

2.2 Connection Diagram of Test System

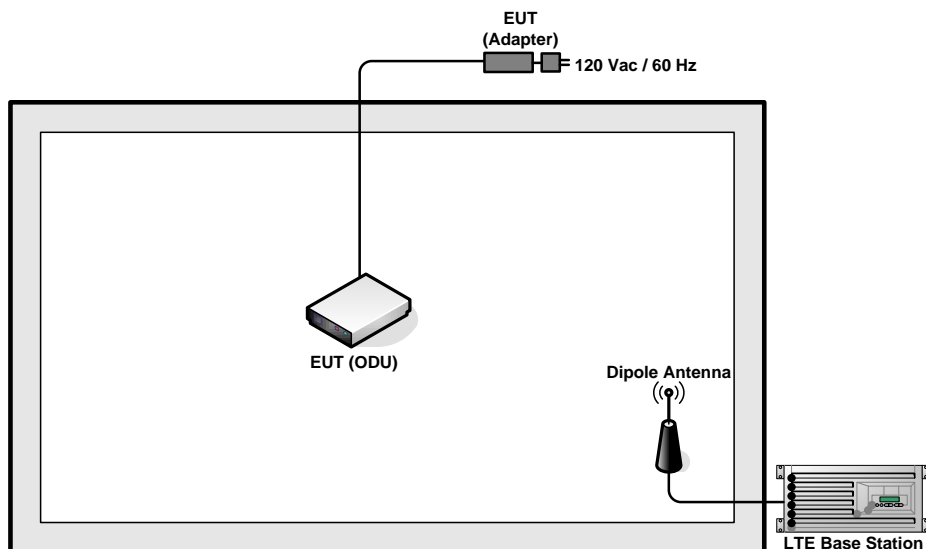



2.3 Support Unit used in test configuration and system

Item	Equipment	Trade Name	Model No.	FCC ID	Data Cable	Power Cord
1.	LTE Base Station	Anritsu	MT8820C	N/A	N/A	Unshielded, 1.8 m

2.4 Measurement Results Explanation Example

For all conducted test items:

The offset level is set in the spectrum analyzer to compensate the RF cable loss and attenuator factor between EUT conducted output port and spectrum analyzer. With the offset compensation, the spectrum analyzer reading level is exactly the EUT RF output level.

The spectrum analyzer offset is derived from RF cable loss and attenuator factor.

Offset = RF cable loss + attenuator factor.

Following shows an offset computation example with cable loss 4.2 dB and 10dB attenuator.

Example :

$$\begin{aligned} \text{Offset(dB)} &= \text{RF cable loss(dB)} + \text{attenuator factor(dB)}. \\ &= 4.2 + 10 = 14.2 \text{ (dB)} \end{aligned}$$

3 Test Result

3.1 Conducted Output Power Measurement and EIRP Measurement

3.1.1 Description of the Conducted Output Power Measurement and EIRP Measurement

A base station simulator was used to establish communication with the EUT. Its parameters were set to transmit the maximum power on the EUT. The measured power in the radio frequency on the transmitter output terminals shall be reported.

The EIRP of mobile transmitters must not exceed 2 Watts for LTE Band 41.

According to KDB 412172 D01 Power Approach,

$EIRP = P_T + G_T - L_C$, $ERP = EIRP - 2.15$, where

P_T = transmitter output power in dBm

G_T = gain of the transmitting antenna in dBi

L_C = signal attenuation in the connecting cable between the transmitter and antenna in dB

3.1.2 Measuring Instruments

The measuring equipment is listed in the section 4 of this test report.

3.1.3 Test Procedures

1. The transmitter output port was connected to base station.
2. Set EUT at maximum power through base station.
3. Select lowest, middle, and highest channels for each band and different modulation.
4. Measure and record the power level from the base station.

3.1.4 Test Setup





3.1.5 Test Result of Conducted Output Power

<LTE Band 41 Conducted Power>

BW [MHz]	Modulation	RB Size	RB Offset	Power (dBm) Low Ch. / Freq.	Power (dBm) Middle Ch. / Freq.	Power (dBm) High Ch. / Freq.
Channel				39752	40620	41488
Frequency (MHz)				2506.2	2593.0	2679.8
20	QPSK	1	0	21.12	21.30	22.01
20	QPSK	1	49	21.22	21.25	21.82
20	QPSK	1	99	21.13	21.12	21.63
20	QPSK	50	0	21.20	21.08	21.57
20	QPSK	50	24	21.16	21.05	21.61
20	QPSK	50	49	21.17	21.09	21.35
20	QPSK	100	0	21.16	21.06	21.46
20	16QAM	1	0	21.16	21.38	21.89
20	16QAM	1	49	21.12	21.37	21.78
20	16QAM	1	99	21.11	21.16	21.52
20	16QAM	50	0	21.03	21.13	21.41
20	16QAM	50	24	21.05	21.11	21.44
20	16QAM	50	49	21.02	21.05	21.37
20	16QAM	100	0	21.03	21.03	21.35
Channel				39727	40620	41513
Frequency (MHz)				2503.7	2593.0	2682.3
15	QPSK	1	0	21.61	21.79	22.47
15	QPSK	1	37	21.43	21.52	22.01
15	QPSK	1	74	21.79	21.49	22.06
15	QPSK	36	0	21.31	21.39	22.08
15	QPSK	36	18	21.30	21.34	21.99
15	QPSK	36	37	21.35	21.36	21.88
15	QPSK	75	0	21.23	21.27	21.91
15	16QAM	1	0	21.37	21.54	22.39
15	16QAM	1	37	21.34	21.24	22.06
15	16QAM	1	74	21.81	21.74	22.22
15	16QAM	36	0	21.18	21.37	21.95
15	16QAM	36	18	21.22	21.17	21.99
15	16QAM	36	37	21.28	21.18	21.77
15	16QAM	75	0	21.27	21.23	21.88



BW [MHz]	Modulation	RB Size	RB Offset	Power (dBm) Low Ch. / Freq.	Power (dBm) Middle Ch. / Freq.	Power (dBm) High Ch. / Freq.
Channel				39702	40620	41538
Frequency (MHz)				2501.2	2593.0	2684.8
10	QPSK	1	0	21.61	21.94	22.68
10	QPSK	1	24	21.53	21.66	22.33
10	QPSK	1	49	21.77	21.74	22.14
10	QPSK	25	0	21.52	21.59	22.25
10	QPSK	25	12	21.55	21.54	22.17
10	QPSK	25	24	21.57	21.49	22.11
10	QPSK	50	0	21.48	21.56	22.12
10	16QAM	1	0	21.45	21.77	22.09
10	16QAM	1	24	21.53	21.60	22.06
10	16QAM	1	49	21.62	22.05	22.30
10	16QAM	25	0	21.49	21.55	22.27
10	16QAM	25	12	21.46	21.51	22.14
10	16QAM	25	24	21.54	21.44	22.05
10	16QAM	50	0	21.43	21.55	22.10
Channel				39677	40620	41563
Frequency (MHz)				2498.7	2593.0	2687.3
5	QPSK	1	0	22.02	21.61	22.27
5	QPSK	1	12	22.19	21.70	22.42
5	QPSK	1	24	21.73	21.35	21.99
5	QPSK	12	0	22.49	22.01	22.57
5	QPSK	12	6	22.42	21.86	22.62
5	QPSK	12	11	22.42	21.97	22.49
5	QPSK	25	0	22.36	21.81	22.43
5	16QAM	1	0	22.15	21.29	22.11
5	16QAM	1	12	22.29	21.56	22.35
5	16QAM	1	24	22.05	21.52	22.04
5	16QAM	12	0	22.43	21.79	22.47
5	16QAM	12	6	22.33	21.93	22.40
5	16QAM	12	11	22.34	21.83	22.37
5	16QAM	25	0	22.34	21.84	22.25

Note: maximum average power for LTE.

3.1.6 Test Result of Conducted Output Power and EIRP

PCS Band ($G_T - L_C = 6.90$ dB)						
Modes	LTE Band 41 (QPSK, BW=5M)			LTE Band 41 (16QAM, BW=5M)		
Channel	39677 (Low)	40620 (Mid)	41563 (High)	39677 (Low)	40620 (Mid)	41563 (High)
Frequency (MHz)	2498.7	2593.0	2687.3	2498.7	2593.0	2687.3
Conducted Power P_T (dBm)	22.49	22.01	22.62	22.43	21.93	22.47
Conducted Power P_T (Watts)	0.18	0.16	0.18	0.17	0.16	0.18
EIRP(dBm)	29.39	28.91	29.52	29.33	28.83	29.37
EIRP(Watts)	0.87	0.78	0.90	0.86	0.76	0.86

PCS Band ($G_T - L_C = 6.90$ dB)						
Modes	LTE Band 41 (QPSK, BW=10M)			LTE Band 41 (16QAM, BW=10M)		
Channel	39702 (Low)	40620 (Mid)	41538 (High)	39702 (Low)	40620 (Mid)	41538 (High)
Frequency (MHz)	2501.2	2593.0	2684.8	2501.2	2593.0	2684.8
Conducted Power P_T (dBm)	21.77	21.94	22.68	21.62	22.05	22.30
Conducted Power P_T (Watts)	0.15	0.16	0.19	0.15	0.16	0.17
EIRP(dBm)	28.67	28.84	29.58	28.52	28.95	29.20
EIRP(Watts)	0.74	0.77	0.91	0.71	0.79	0.83



PCS Band (G _T - L _C = 6.90 dB)						
Modes	LTE Band 41 (QPSK, BW=15M)			LTE Band 41 (16QAM, BW=15M)		
Channel	39727 (Low)	40620 (Mid)	41513 (High)	39727 (Low)	40620 (Mid)	41513 (High)
Frequency (MHz)	2503.7	2593.0	2682.3	2503.7	2593.0	2682.3
Conducted Power P _T (dBm)	21.79	21.79	22.47	21.81	21.74	22.39
Conducted Power P _T (Watts)	0.15	0.15	0.18	0.15	0.15	0.17
EIRP(dBm)	28.69	28.69	29.37	28.71	28.64	29.29
EIRP(Watts)	0.74	0.74	0.86	0.74	0.73	0.85

PCS Band (G _T - L _C = 6.90 dB)						
Modes	LTE Band 41 (QPSK, BW=20M)			LTE Band 41 (16QAM, BW=20M)		
Channel	39752 (Low)	40620 (Mid)	41488 (High)	39752 (Low)	40620 (Mid)	41488 (High)
Frequency (MHz)	2506.2	2593.0	2679.8	2506.2	2593.0	2679.8
Conducted Power P _T (dBm)	21.22	21.30	22.01	21.16	21.38	21.89
Conducted Power P _T (Watts)	0.13	0.13	0.16	0.13	0.14	0.15
EIRP(dBm)	28.12	28.20	28.91	28.06	28.28	28.79
EIRP(Watts)	0.65	0.66	0.78	0.64	0.67	0.76

3.2 Occupied Bandwidth

3.2.1 Description of Occupied Bandwidth Measurement

The occupied bandwidth is the width of a frequency band such that, below the lower and above the upper frequency limits, the mean powers emitted are each equal to a specified percentage 0.5% of the total mean transmitted power.

The 26dB occupied bandwidth is the width of a frequency band such that, below the lower and above the upper frequency limits, the mean powers emitted are each equal 26 dB.

The 26 dB emission bandwidth is defined as the frequency range between two points, one above and one below the carrier frequency, at which the spectral density of the emission is attenuated 26 dB below the maximum in-band spectral density of the modulated signal. Spectral density (power per unit bandwidth) is to be measured with a detector of resolution bandwidth equal to approximately 1.0% of the emission bandwidth.

3.2.2 Measuring Instruments

The measuring equipment is listed in the section 4 of this test report.

3.2.3 Test Procedures

1. The EUT was connected to Spectrum Analyzer and Base Station via power divider.
2. The 26dB and 99% occupied bandwidth (BW) of the middle channel for the highest RF powers with full RB sizes were measured.
- 3.

3.2.4 Test Setup

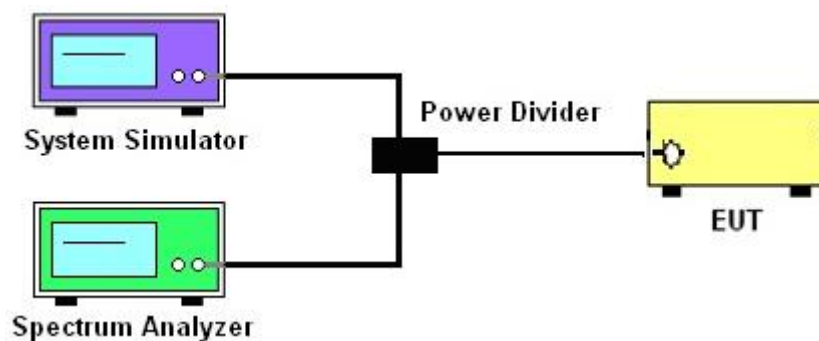



3.2.5 Test Result (Plots) of Occupied Bandwidth

Band :	LTE Band 41	BW / Mod. :	5MHz / QPSK
--------	-------------	-------------	-------------

99% Occupied Bandwidth Plot on Channel 39677

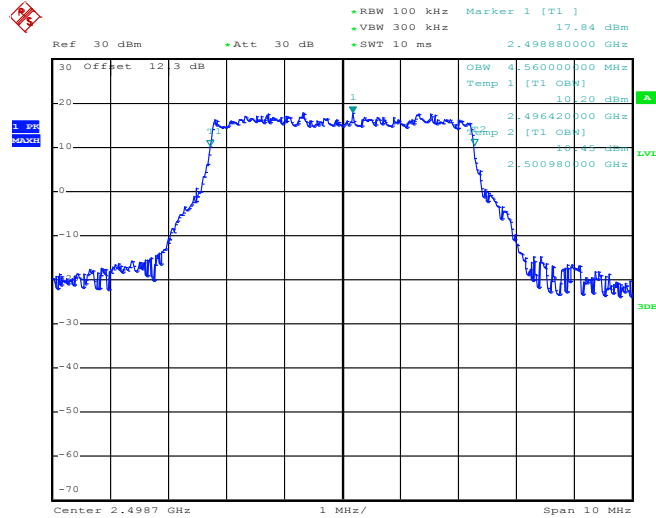

Date: 10.MAR.2014 16:36:19

26dB Bandwidth Plot on Channel 39677

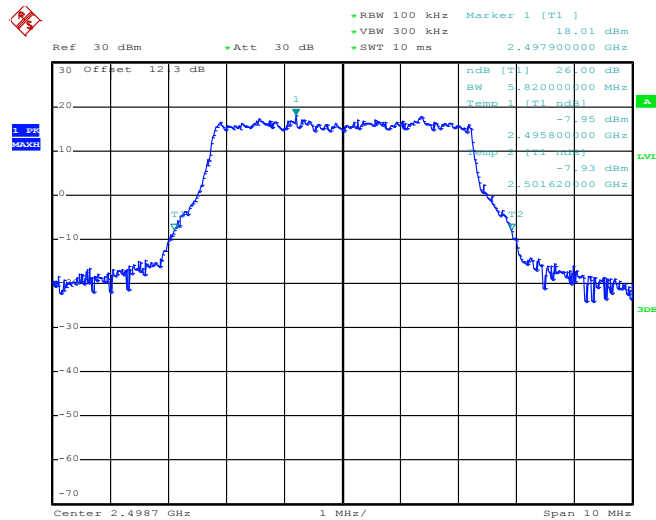

Date: 10.MAR.2014 16:30:25



Band :	LTE Band 41	BW / Mod. :	5MHz / 16QAM
--------	-------------	-------------	--------------

99% Occupied Bandwidth Plot on Channel 39677

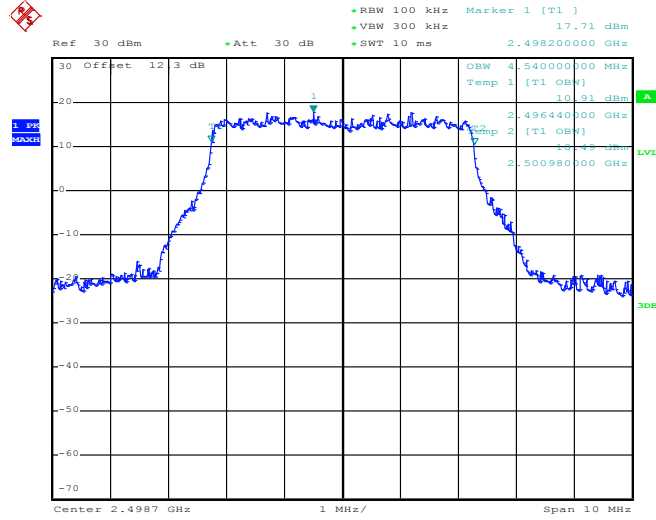

Date: 10.MAR.2014 16:36:51

26dB Bandwidth Plot on Channel 39677

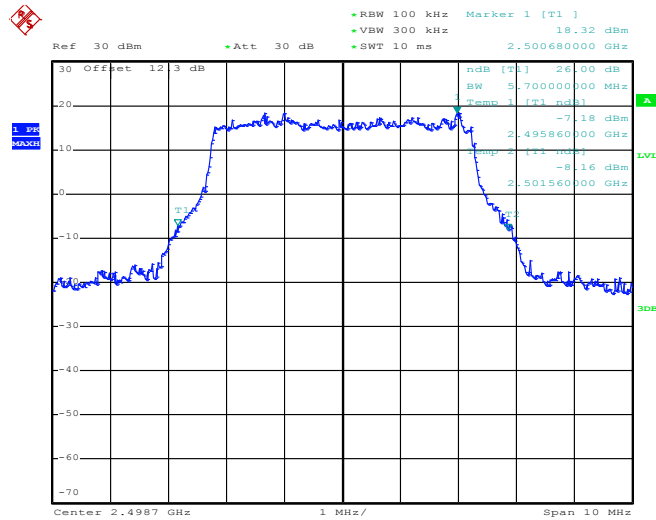

Date: 10.MAR.2014 16:30:51



Band :	LTE Band 41	BW / Mod. :	5MHz / QPSK
--------	-------------	-------------	-------------

99% Occupied Bandwidth Plot on Channel 40620

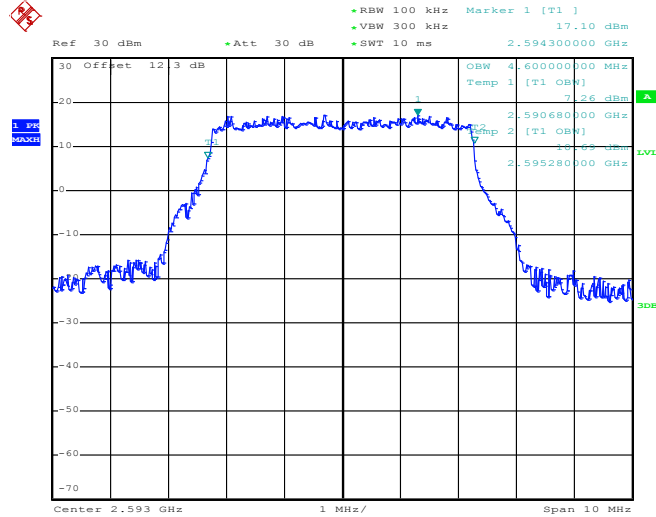

Date: 10.MAR.2014 16:37:53

26dB Bandwidth Plot on Channel 40620

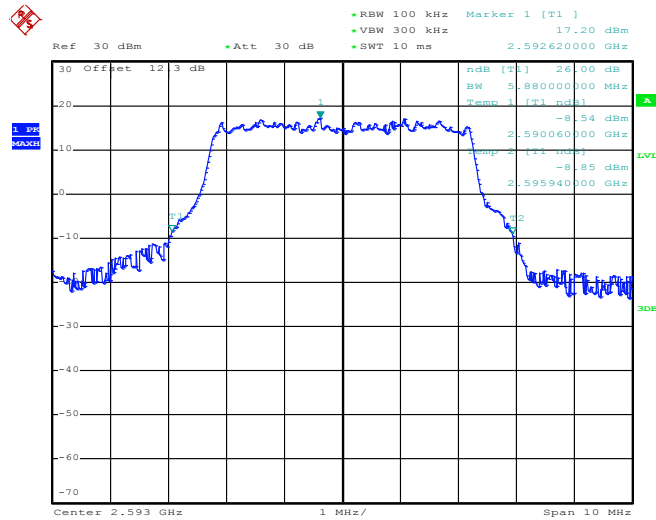

Date: 10.MAR.2014 16:00:12



Band :	LTE Band 41	BW / Mod. :	5MHz / 16QAM
---------------	-------------	--------------------	--------------

99% Occupied Bandwidth Plot on Channel 40620

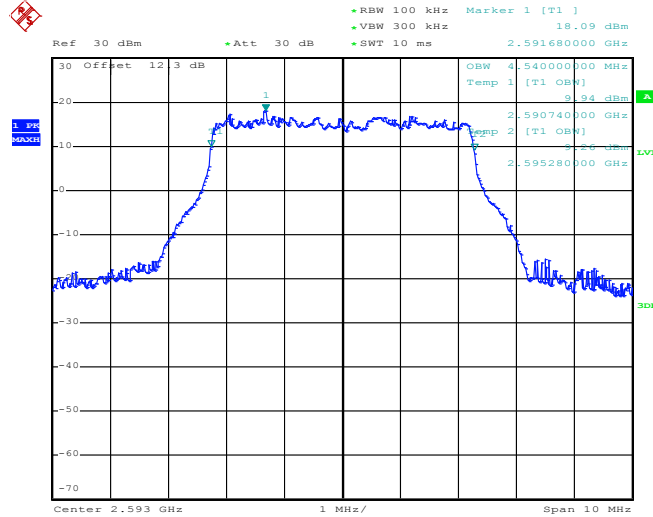

Date: 10.MAR.2014 16:37:32

26dB Bandwidth Plot on Channel 40620

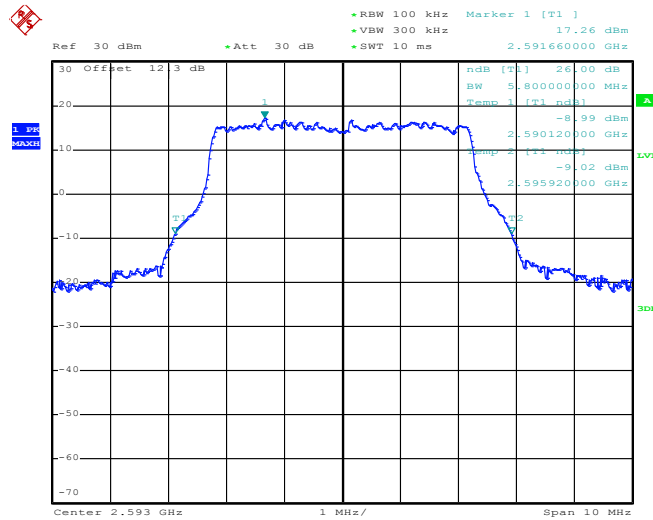

Date: 10.MAR.2014 16:01:01



Band :	LTE Band 41	BW / Mod. :	5MHz / QPSK
---------------	-------------	--------------------	-------------

99% Occupied Bandwidth Plot on Channel 41563

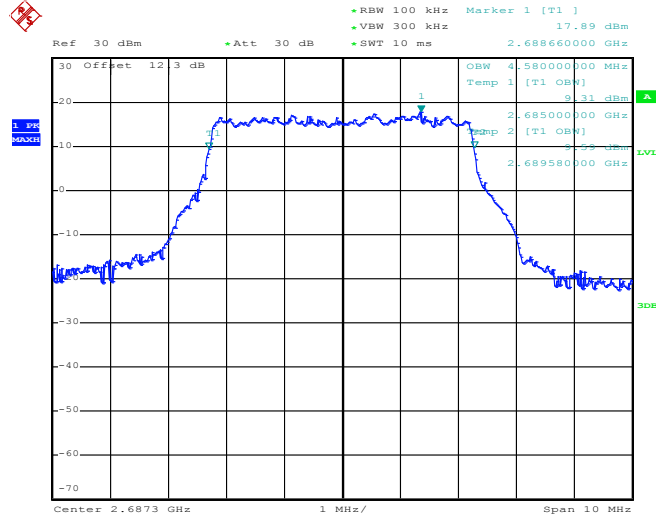

Date: 10.MAR.2014 16:33:03

26dB Bandwidth Plot on Channel 41563

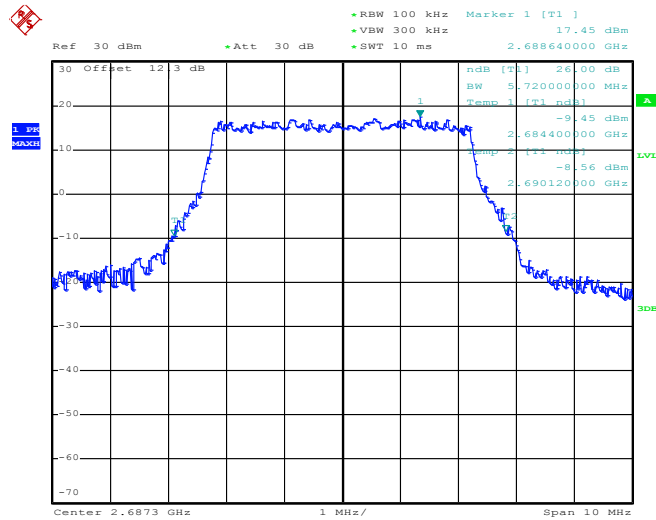

Date: 10.MAR.2014 16:32:26



Band :	LTE Band 41	BW / Mod. :	5MHz / 16QAM
--------	-------------	-------------	--------------

99% Occupied Bandwidth Plot on Channel 41563

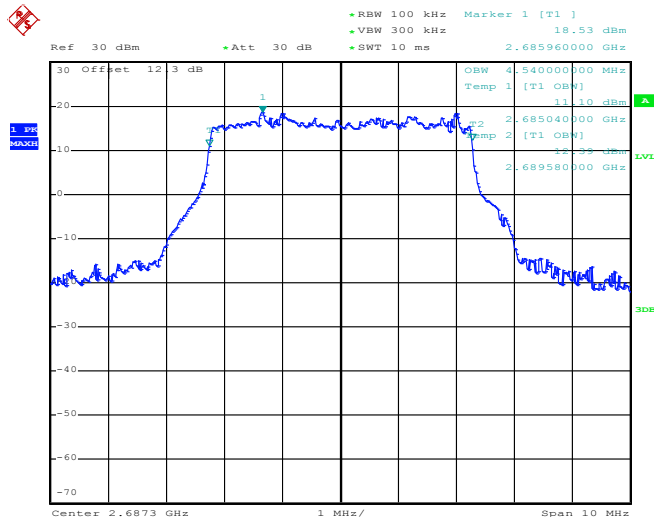

Date: 10.MAR.2014 16:33:34

26dB Bandwidth Plot on Channel 41563

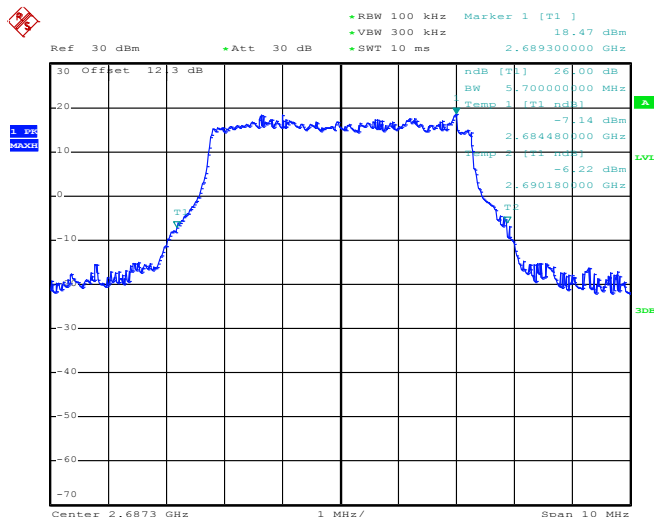

Date: 10.MAR.2014 16:31:35



Band :	LTE Band 41	BW / Mod. :	10MHz / QPSK
--------	-------------	-------------	--------------

99% Occupied Bandwidth Plot on Channel 39702

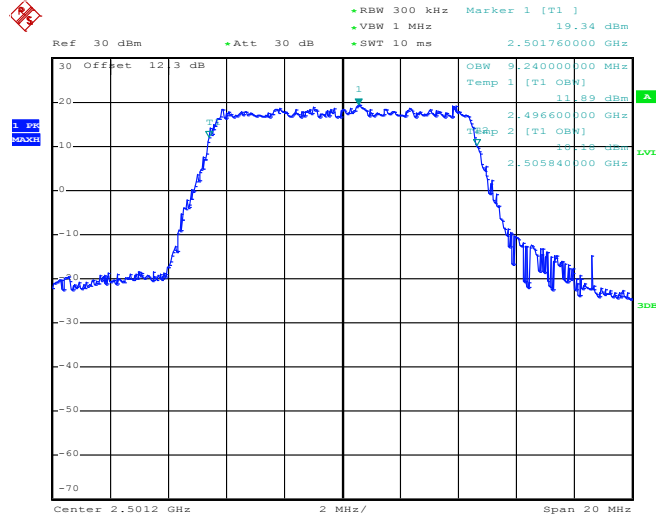

Date: 10.MAR.2014 15:51:13

26dB Bandwidth Plot on Channel 39702

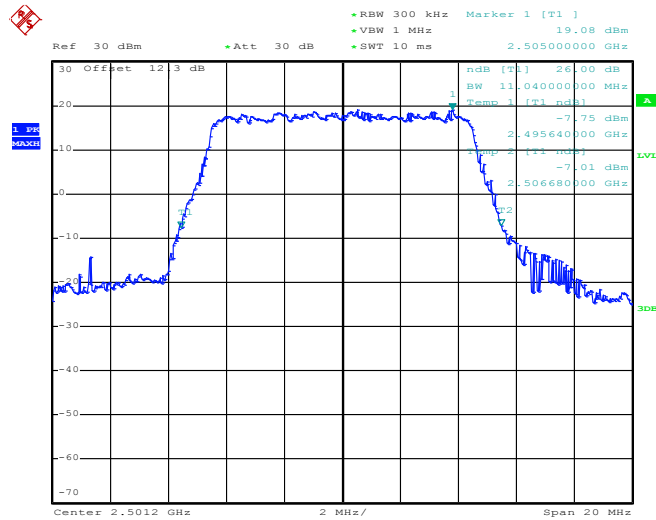

Date: 10.MAR.2014 15:52:57



Band :	LTE Band 41	BW / Mod. :	10MHz / 16QAM
--------	-------------	-------------	---------------

99% Occupied Bandwidth Plot on Channel 39702

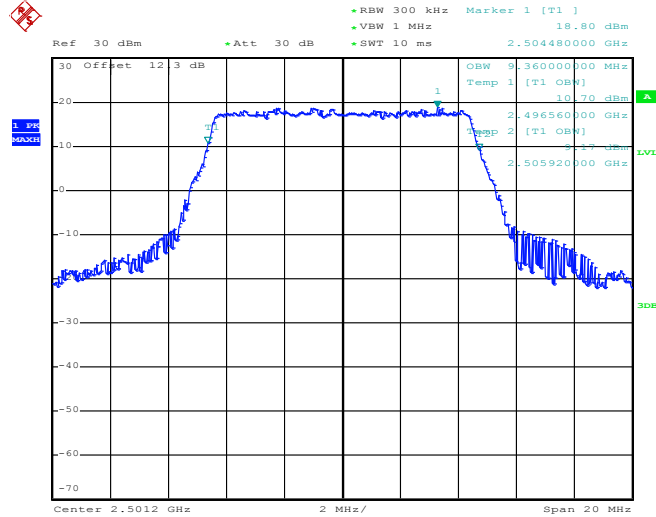

Date: 10.MAR.2014 15:51:38

26dB Bandwidth Plot on Channel 39702

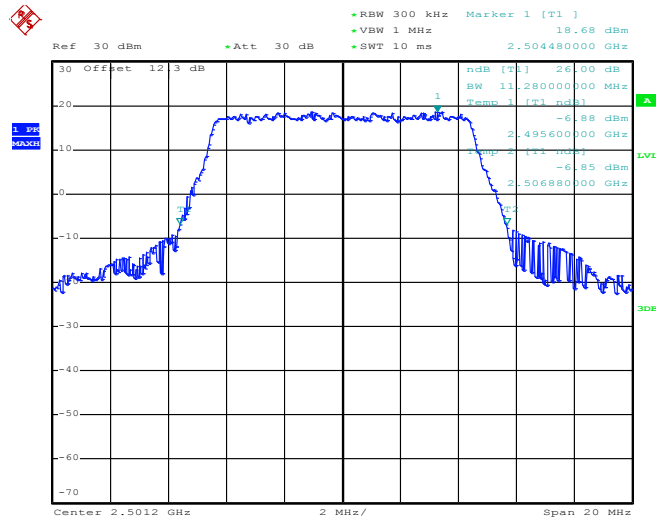

Date: 10.MAR.2014 15:51:56



Band :	LTE Band 41	BW / Mod. :	10MHz / QPSK
--------	-------------	-------------	--------------

99% Occupied Bandwidth Plot on Channel 40620

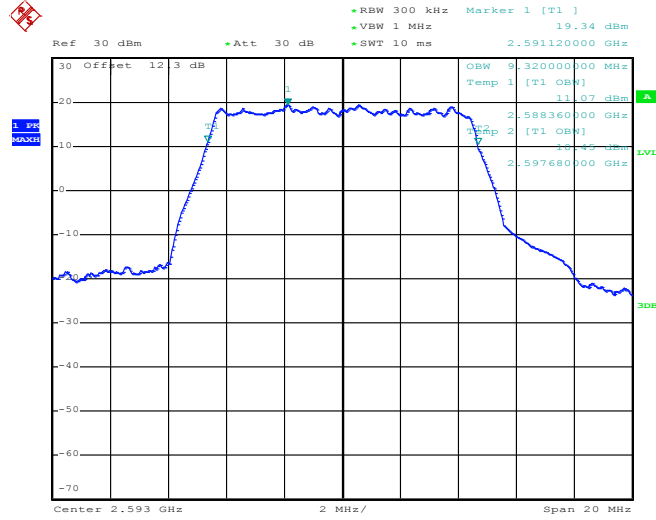

Date: 10.MAR.2014 15:49:35

26dB Bandwidth Plot on Channel 40620

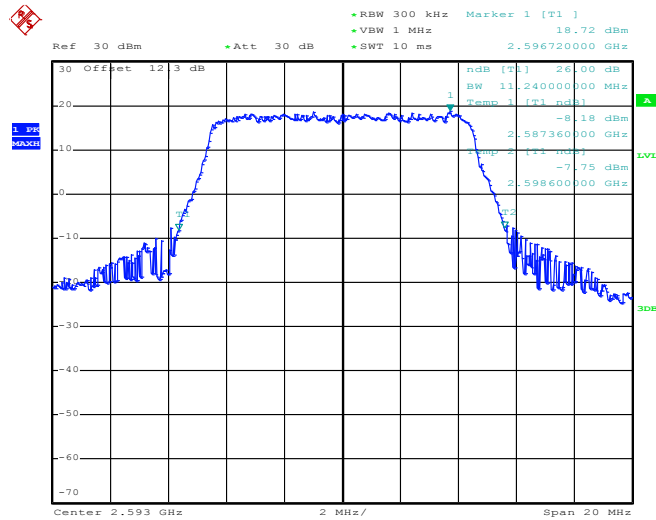

Date: 10.MAR.2014 15:54:42



Band :	LTE Band 41	BW / Mod. :	10MHz / 16QAM
---------------	-------------	--------------------	---------------

99% Occupied Bandwidth Plot on Channel 40620

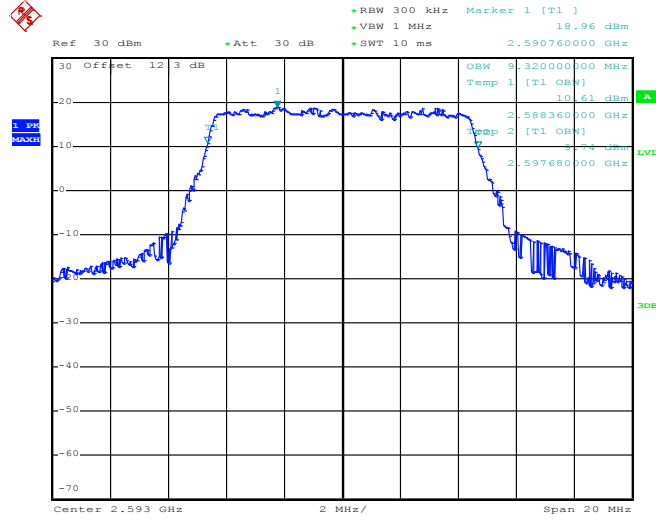

Date: 10.MAR.2014 15:49:55

26dB Bandwidth Plot on Channel 40620

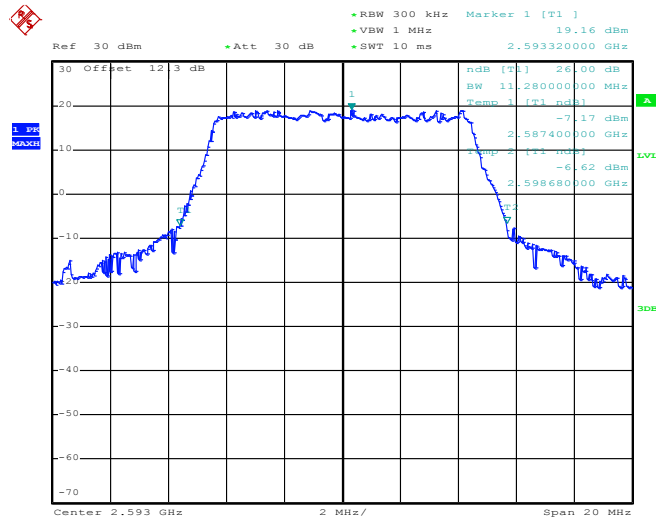

Date: 10.MAR.2014 15:54:23



Band :	LTE Band 41	BW / Mod. :	10MHz / QPSK
--------	-------------	-------------	--------------

99% Occupied Bandwidth Plot on Channel 41538

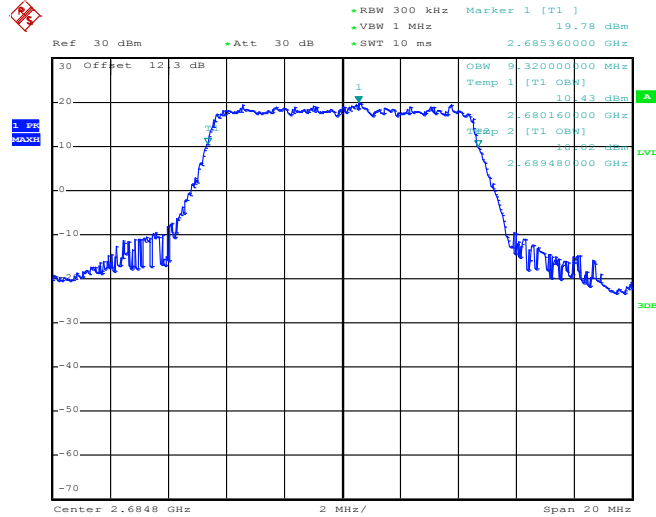

Date: 10.MAR.2014 15:50:46

26dB Bandwidth Plot on Channel 41538

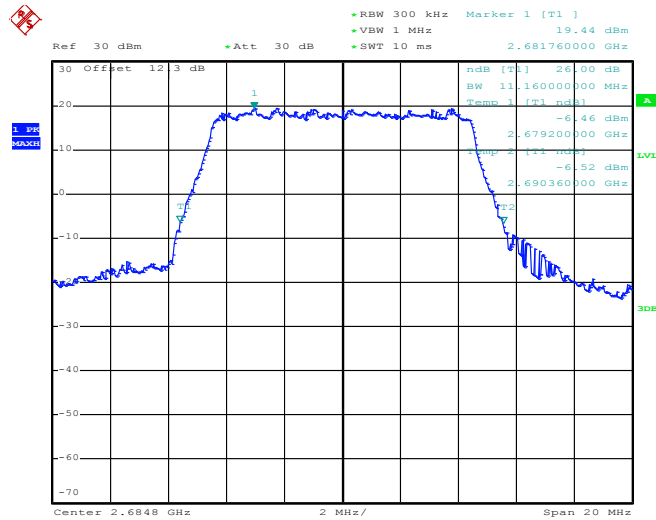

Date: 10.MAR.2014 15:53:33



Band :	LTE Band 41	BW / Mod. :	10MHz / 16QAM
---------------	-------------	--------------------	---------------

99% Occupied Bandwidth Plot on Channel 41538

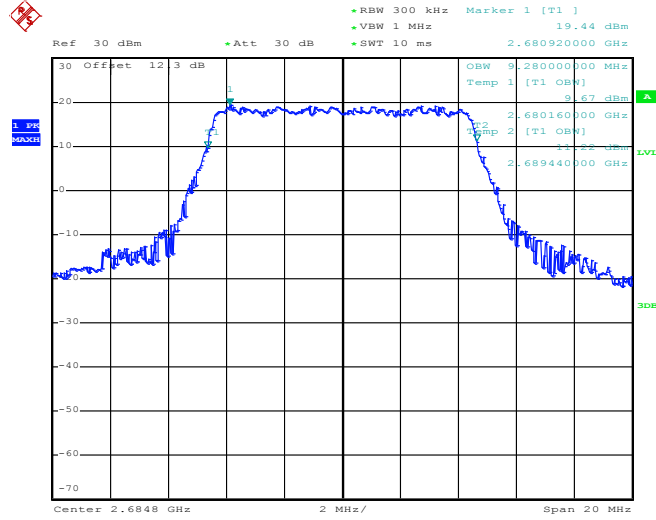

Date: 10.MAR.2014 15:50:26

26dB Bandwidth Plot on Channel 41538

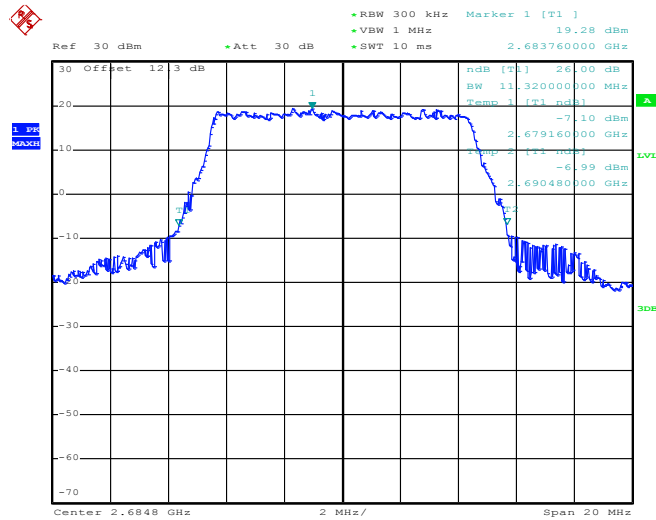

Date: 10.MAR.2014 15:53:51



Band :	LTE Band 41	BW / Mod. :	15MHz / QPSK
---------------	-------------	--------------------	--------------

99% Occupied Bandwidth Plot on Channel 39727

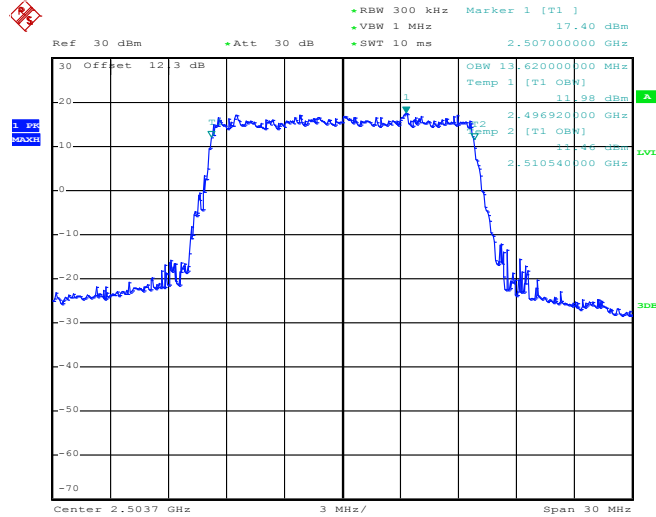

Date: 10.MAR.2014 16:47:36

26dB Bandwidth Plot on Channel 39727

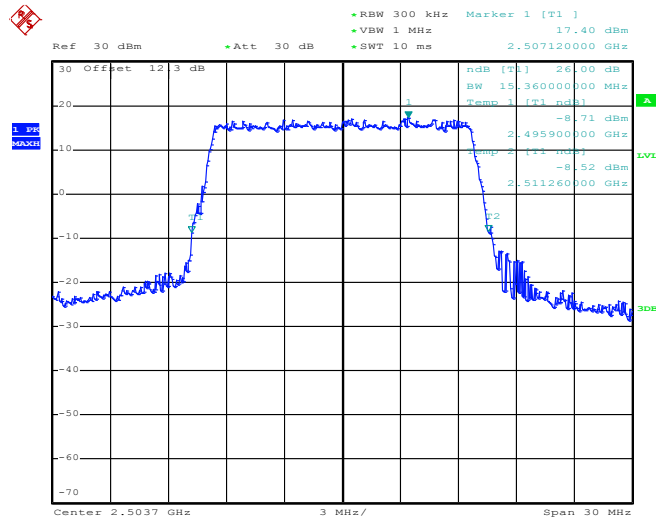

Date: 10.MAR.2014 16:50:17



Band :	LTE Band 41	BW / Mod. :	15MHz / 16QAM
---------------	-------------	--------------------	---------------

99% Occupied Bandwidth Plot on Channel 39727

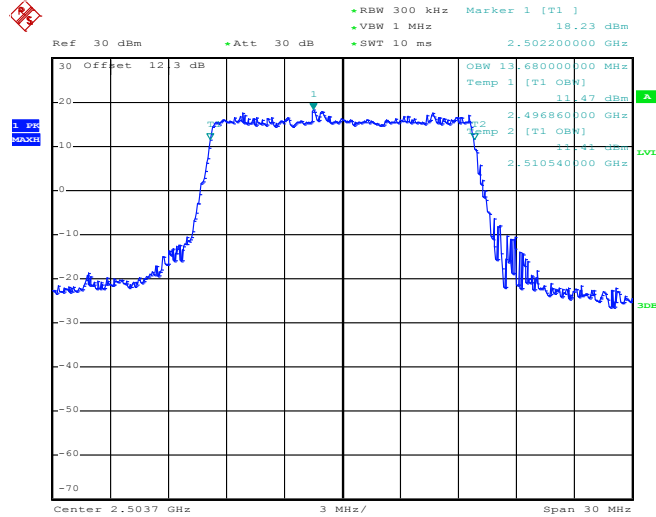

Date: 10.MAR.2014 16:44:14

26dB Bandwidth Plot on Channel 39727

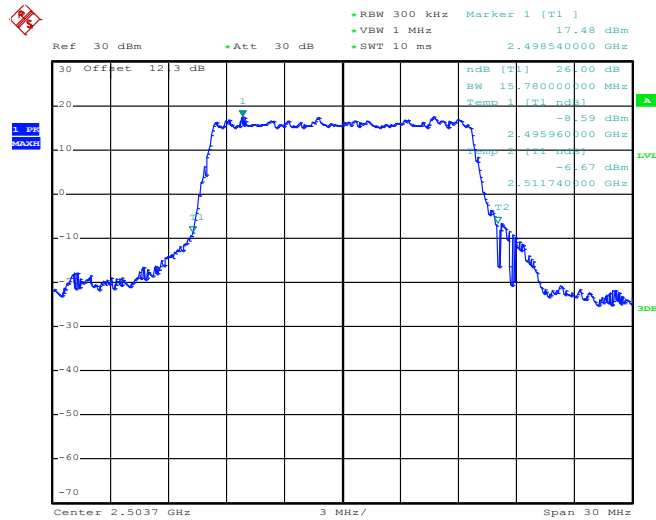

Date: 10.MAR.2014 16:51:18



Band :	LTE Band 41	BW / Mod. :	15MHz / QPSK
---------------	-------------	--------------------	--------------

99% Occupied Bandwidth Plot on Channel 40620

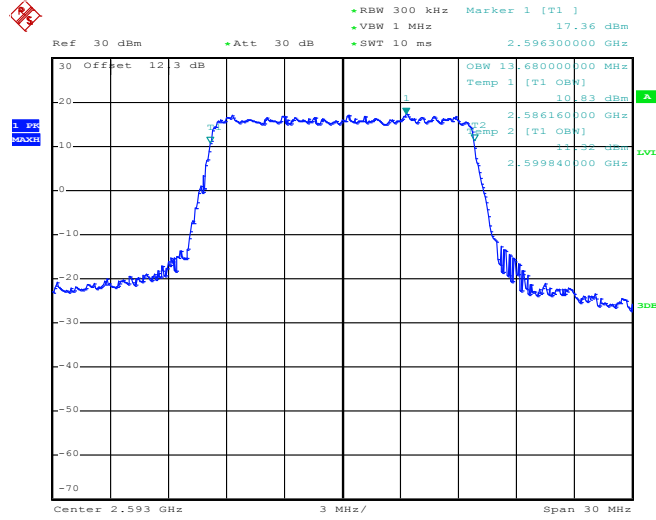

Date: 10.MAR.2014 16:41:43

26dB Bandwidth Plot on Channel 40620

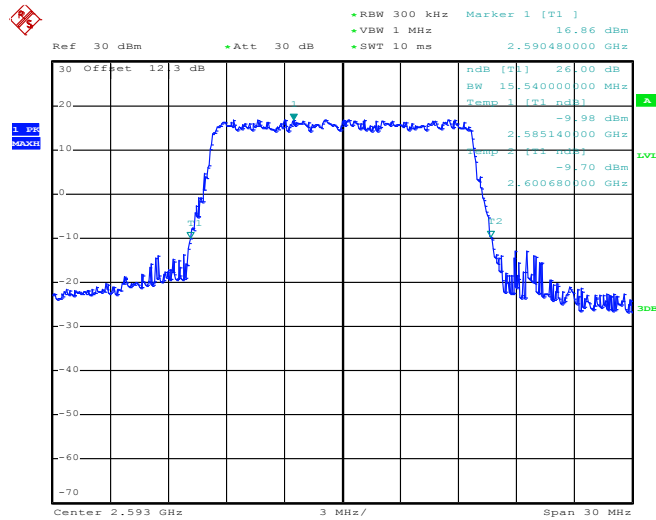

Date: 10.MAR.2014 16:52:17



Band :	LTE Band 41	BW / Mod. :	15MHz / 16QAM
---------------	-------------	--------------------	---------------

99% Occupied Bandwidth Plot on Channel 40620

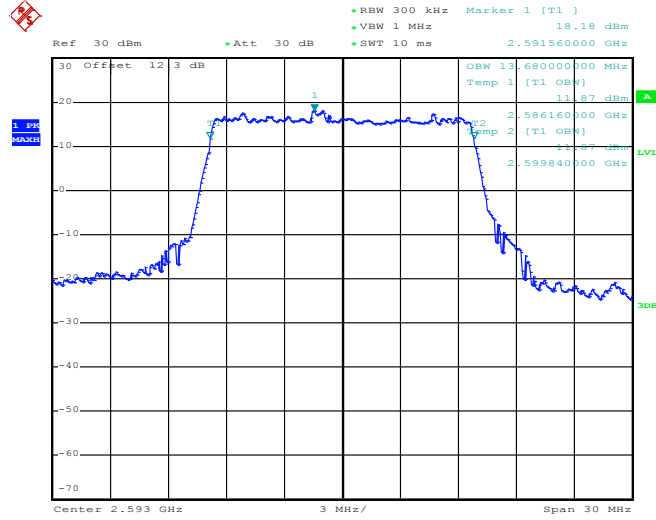

Date: 10.MAR.2014 16:42:43

26dB Bandwidth Plot on Channel 40620

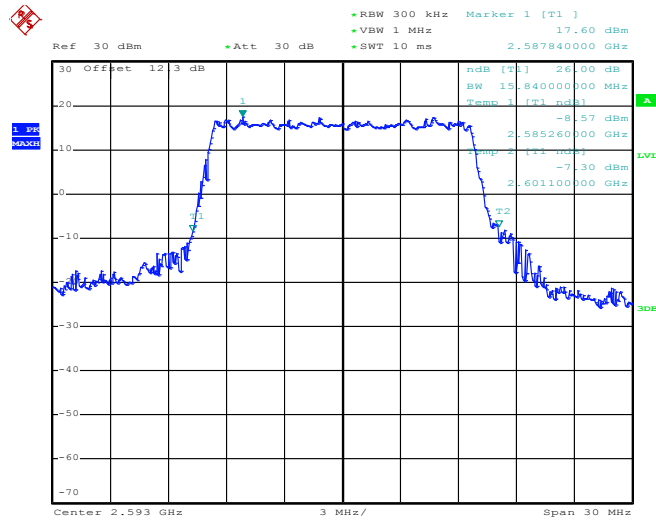

Date: 10.MAR.2014 16:52:01



Band :	LTE Band 41	BW / Mod. :	15MHz / QPSK
--------	-------------	-------------	--------------

99% Occupied Bandwidth Plot on Channel 41513

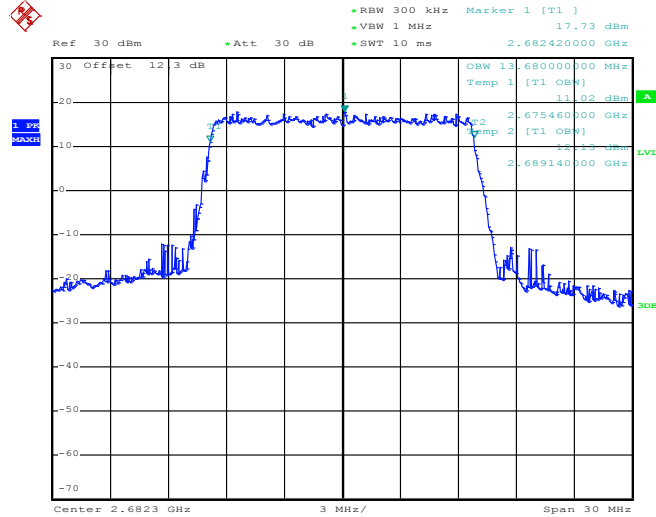

Date: 10.MAR.2014 16:48:15

26dB Bandwidth Plot on Channel 41513

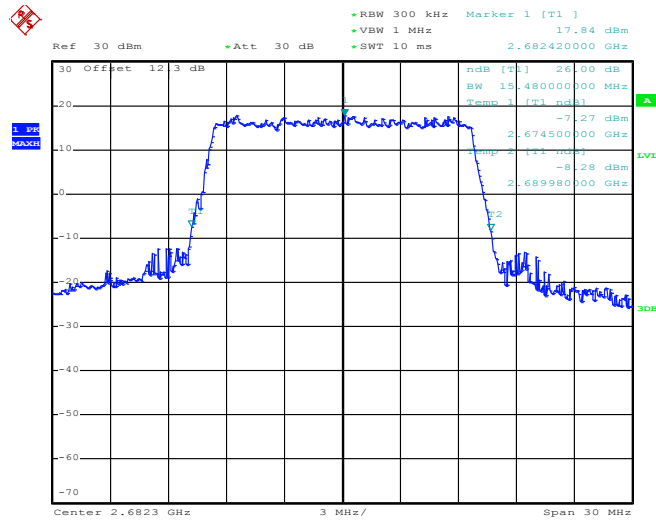

Date: 10.MAR.2014 16:49:49



Band :	LTE Band 41	BW / Mod. :	15MHz / 16QAM
---------------	-------------	--------------------	---------------

99% Occupied Bandwidth Plot on Channel 41513

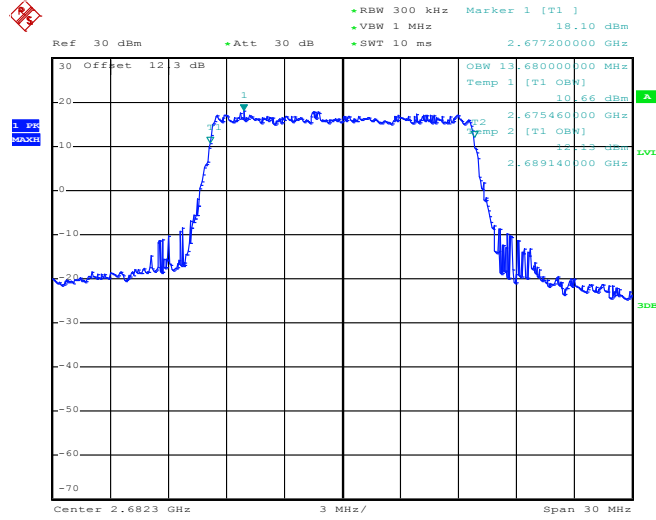

Date: 10.MAR.2014 16:48:32

26dB Bandwidth Plot on Channel 41513

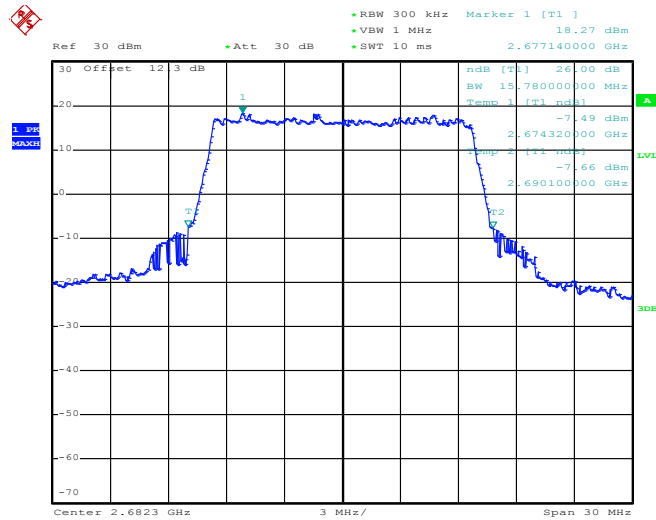

Date: 10.MAR.2014 16:49:31



Band :	LTE Band 41	BW / Mod. :	20MHz / QPSK
--------	-------------	-------------	--------------

99% Occupied Bandwidth Plot on Channel 39752

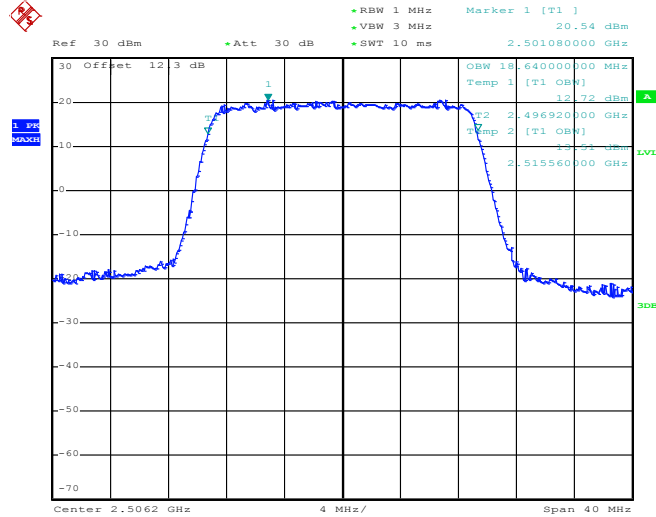

Date: 10.MAR.2014 16:58:00

26dB Bandwidth Plot on Channel 39752

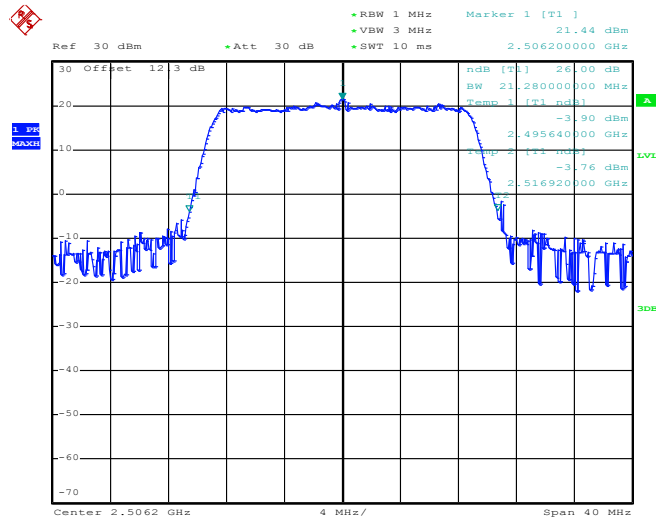

Date: 10.MAR.2014 17:06:51



Band :	LTE Band 41	BW / Mod. :	20MHz / 16QAM
---------------	-------------	--------------------	---------------

99% Occupied Bandwidth Plot on Channel 39752

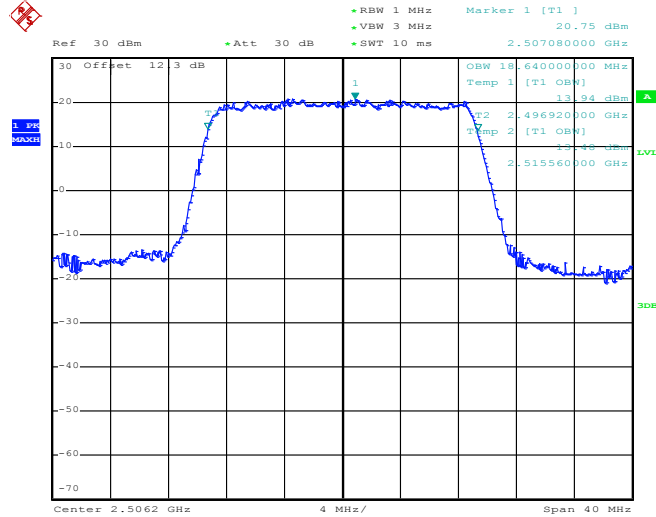

Date: 10.MAR.2014 16:57:41

26dB Bandwidth Plot on Channel 39752

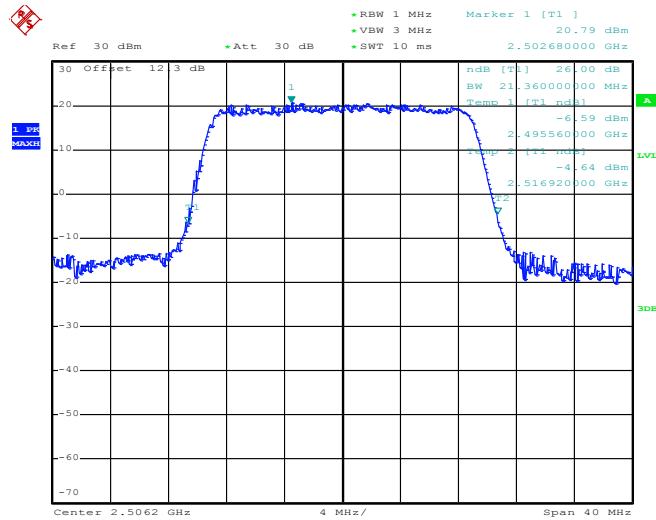

Date: 10.MAR.2014 17:07:06



Band :	LTE Band 41	BW / Mod. :	20MHz / QPSK
--------	-------------	-------------	--------------

99% Occupied Bandwidth Plot on Channel 40620

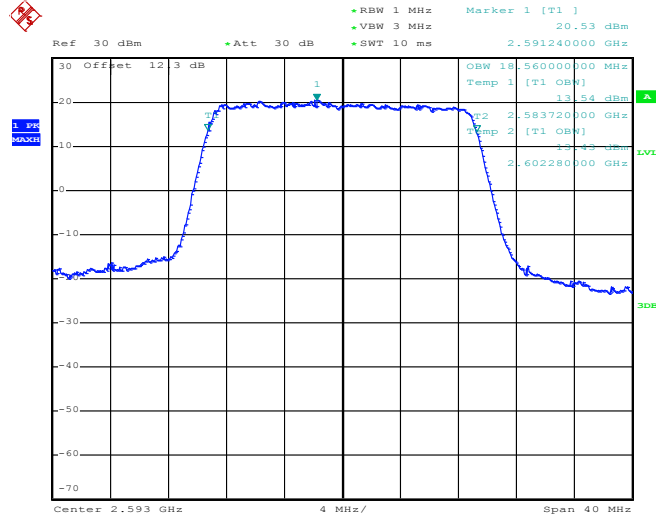

Date: 10.MAR.2014 16:56:11

26dB Bandwidth Plot on Channel 40620

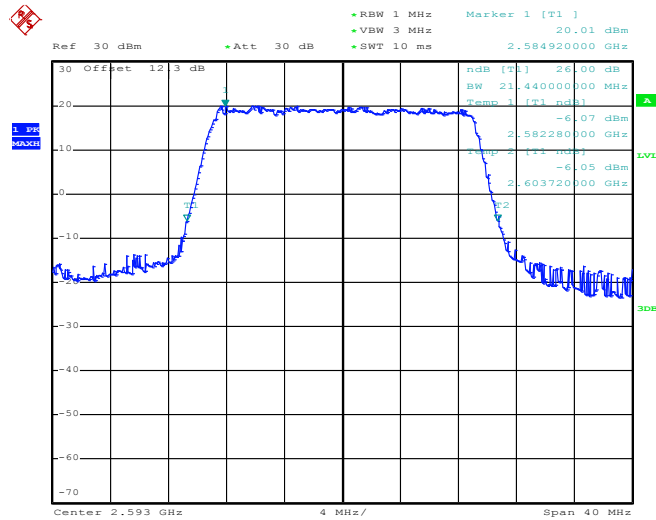

Date: 10.MAR.2014 17:08:23



Band :	LTE Band 41	BW / Mod. :	20MHz / 16QAM
---------------	-------------	--------------------	---------------

99% Occupied Bandwidth Plot on Channel 40620

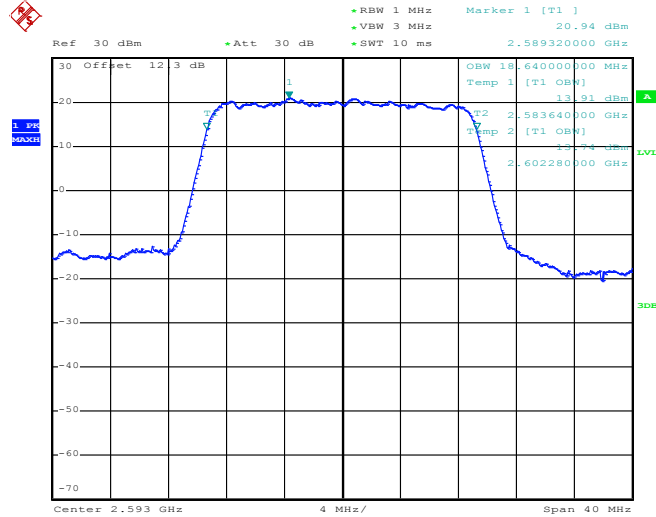

Date: 10.MAR.2014 16:57:10

26dB Bandwidth Plot on Channel 40620

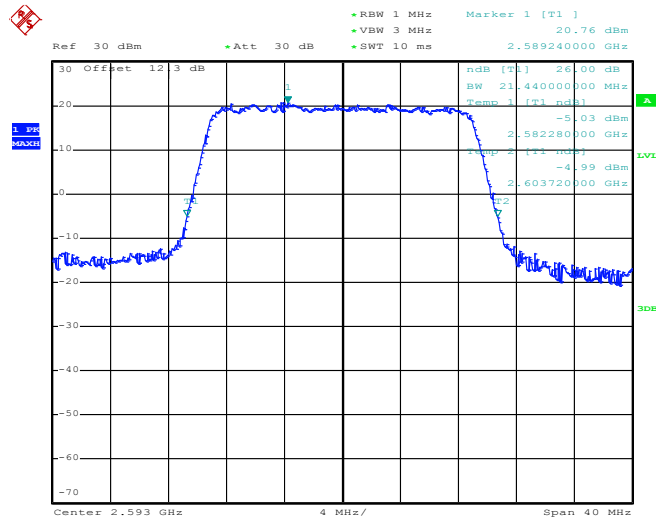

Date: 10.MAR.2014 17:08:07



Band :	LTE Band 41	BW / Mod. :	20MHz / QPSK
---------------	-------------	--------------------	--------------

99% Occupied Bandwidth Plot on Channel 41488

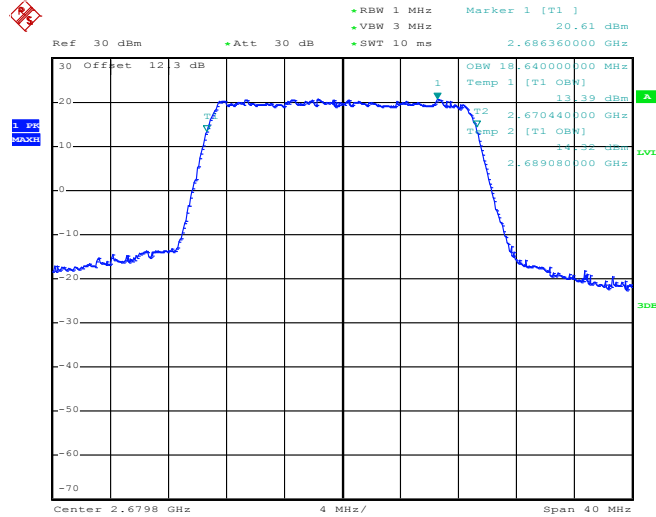

Date: 10.MAR.2014 16:58:34

26dB Bandwidth Plot on Channel 41488

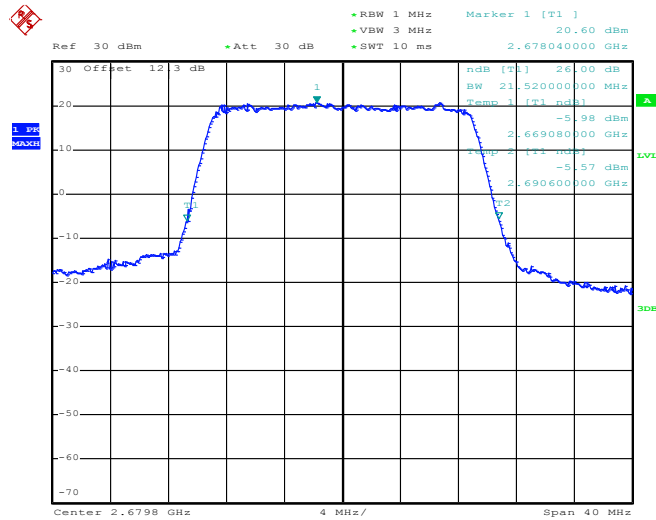

Date: 10.MAR.2014 17:00:09



Band :	LTE Band 41	BW / Mod. :	20MHz / 16QAM
--------	-------------	-------------	---------------

99% Occupied Bandwidth Plot on Channel 41488

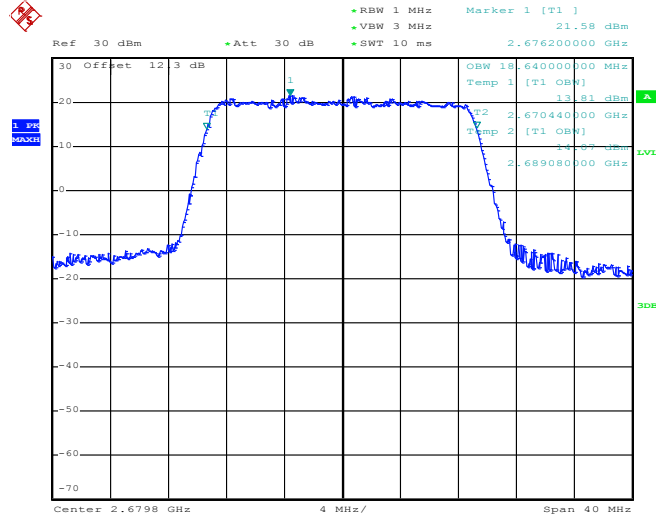

Date: 10.MAR.2014 16:58:49

26dB Bandwidth Plot on Channel 41488

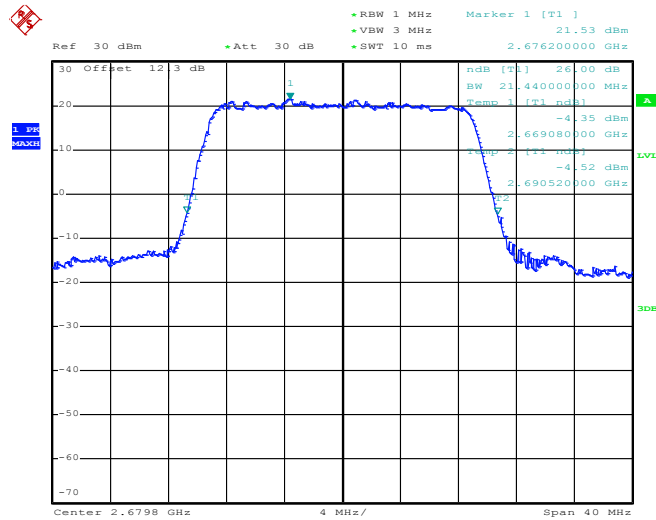

Date: 10.MAR.2014 16:59:15

3.3 Conducted Band Edge Measurement

3.3.1 Description of Conducted Band Edge Measurement

27.53(l)(4)

The emissions be operated in the 2496-2690 MHz band, the attenuation factor of transmitter Power (P) shall be not less than $43 + 10 \log (P)$ dB at the channel edge.

3.3.2 Measuring Instruments

The measuring equipment is listed in the section 4 of this test report.

3.3.3 Test Procedures

1. The EUT was connected to Spectrum Analyzer and Base Station via power divider.
2. The band edges of low and high channels for the highest RF powers were measured. Setting $RBW \geq 1\%$ EBW, and measuring bandwidth = 1MHz.
3. The RF fundamental frequency should be excluded against the limit line in the operating frequency band.
4. The limit line is derived from $43 + 10\log(P)$ dB below the transmitter power P(Watts)
 $= P(W) - [43 + 10\log(P)]$ (dB)
 $= [30 + 10\log(P)]$ (dBm) - $[43 + 10\log(P)]$ (dB)
 $= -13$ dBm.

3.3.4 Test Setup

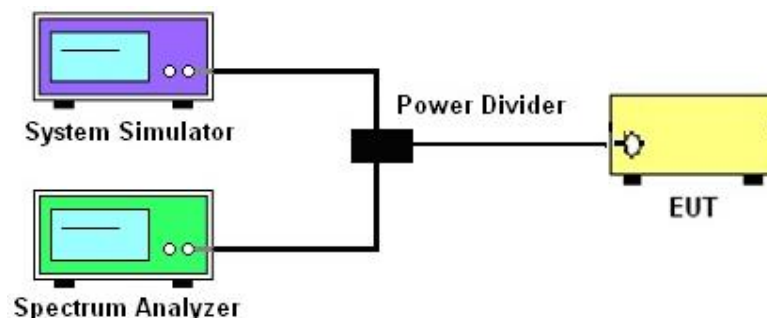



3.3.5 Test Result (Plots) of Conducted Band Edge

Band :	LTE Band 41	Band Width :	5MHz / QPSK
--------	-------------	--------------	-------------

Lower Band Edge Plot for QPSK-RB Size 1, RB Offset 0

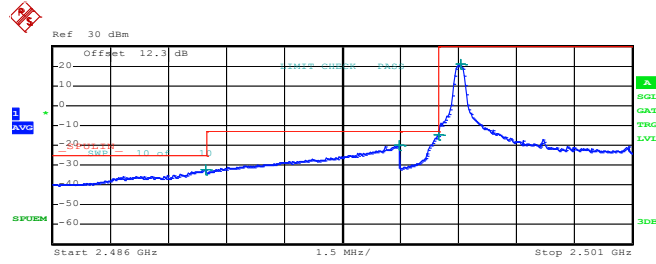

Date: 11.MAR.2014 08:23:39

Lower Band Edge Plot for QPSK-RB Size 25, RB Offset 0

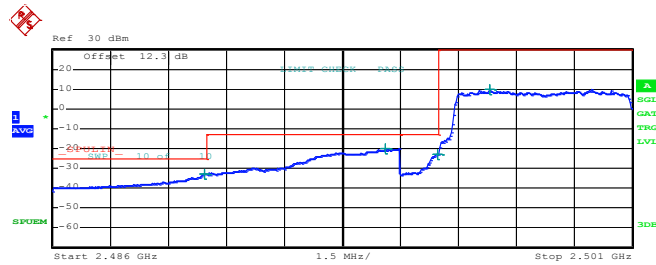

Date: 11.MAR.2014 08:18:38



Higher Band Edge Plot for QPSK-RB Size 1, RB Offset 24

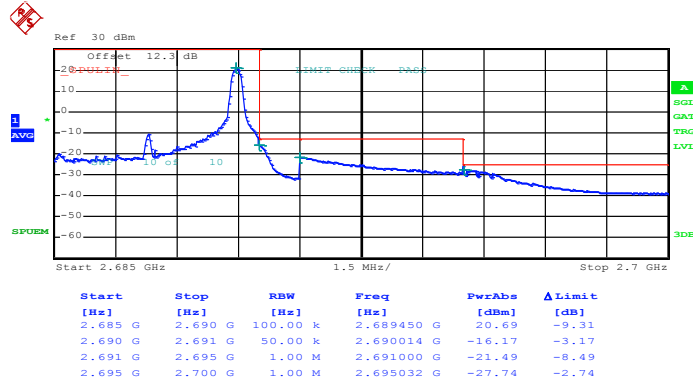

Date: 11.MAR.2014 08:28:18

Higher Band Edge Plot for QPSK-RB Size 25, RB Offset 0

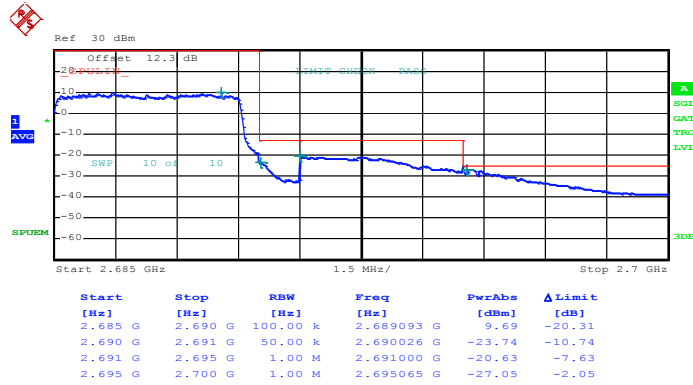

Date: 11.MAR.2014 08:33:30



Band :	LTE Band 5	Band Width :	5MHz / 16QAM
---------------	------------	---------------------	--------------

Lower Band Edge Plot for 16QAM -RB Size 1, RB Offset 0

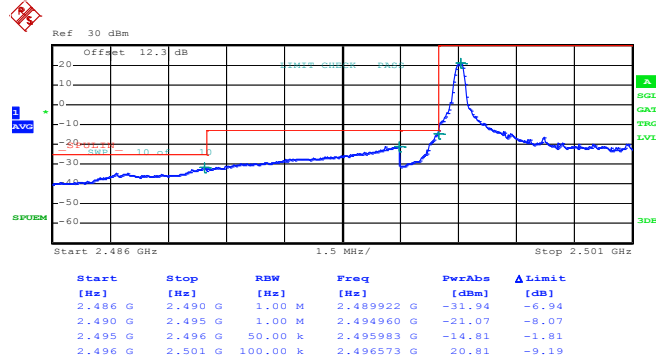

Date: 11.MAR.2014 08:22:04

Lower Band Edge Plot for 16QAM -RB Size 25, RB Offset 0

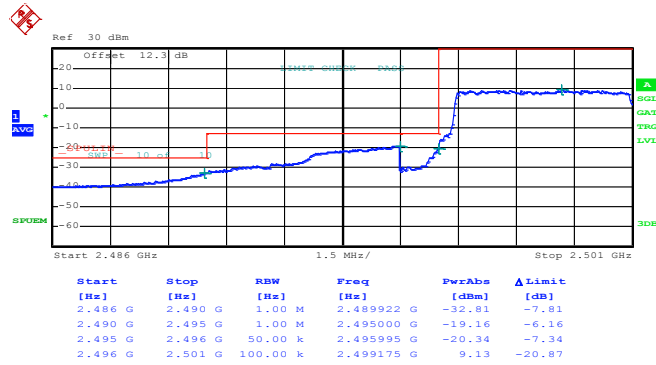

Date: 11.MAR.2014 08:20:22



Higher Band Edge Plot for 16QAM -RB Size 1, RB Offset 24

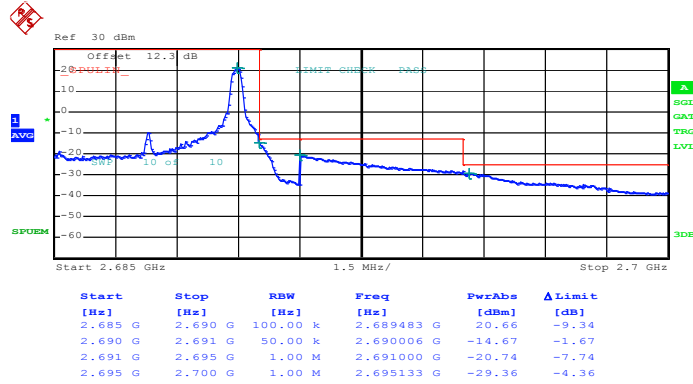

Date: 11.MAR.2014 08:30:04

Higher Band Edge Plot for 16QAM -RB Size 25, RB Offset 0

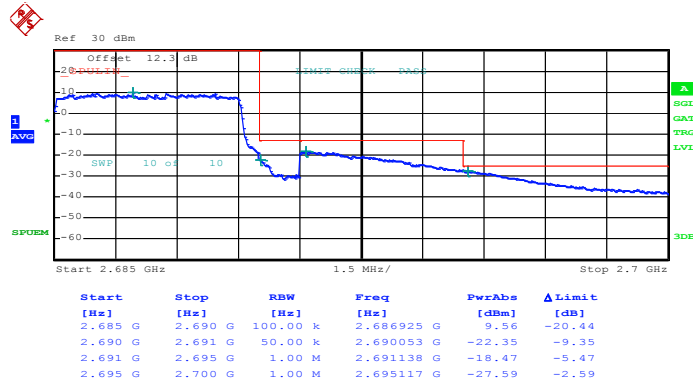

Date: 11.MAR.2014 08:31:50



Band :	LTE Band 41	Band Width	10MHz / QPSK
---------------	-------------	-------------------	--------------

Lower Band Edge Plot for QPSK-RB Size 1, RB Offset 0

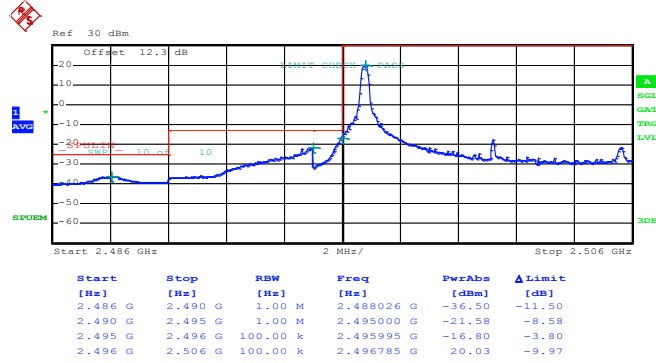

Date: 11.MAR.2014 09:06:45

Lower Band Edge Plot for QPSK-RB Size 50, RB Offset 0

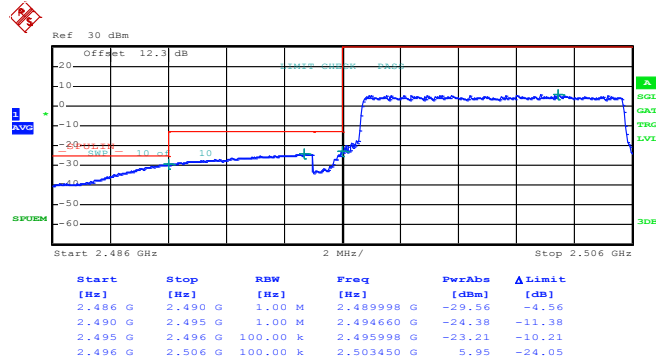

Date: 11.MAR.2014 09:12:51



Higher Band Edge Plot for QPSK-RB Size 1, RB Offset 49

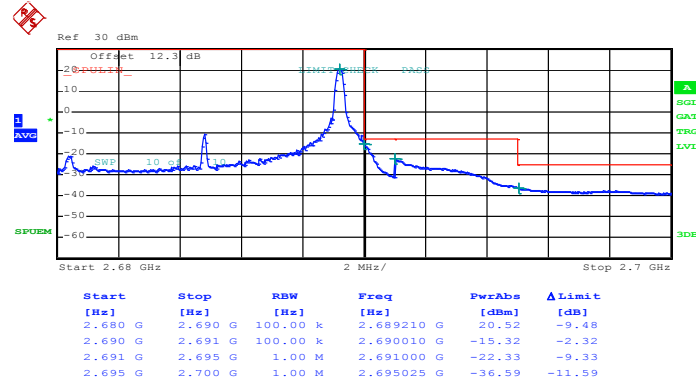

Date: 11.MAR.2014 08:53:36

Higher Band Edge Plot for QPSK-RB Size 50, RB Offset 0

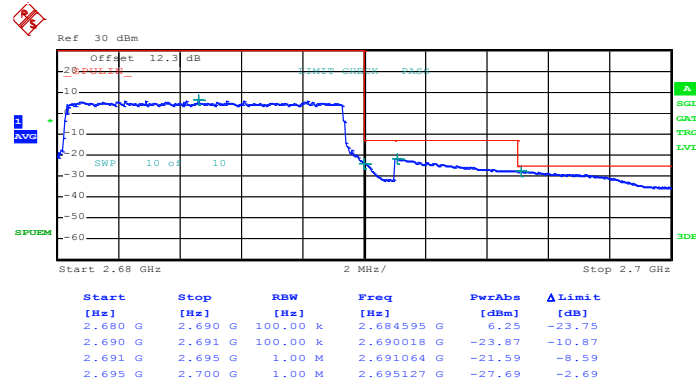

Date: 11.MAR.2014 08:38:08



Band :	LTE Band 41	Band Width	10MHz / 16QAM
---------------	-------------	-------------------	---------------

Lower Band Edge Plot for 16QAM-RB Size 1, RB Offset 0

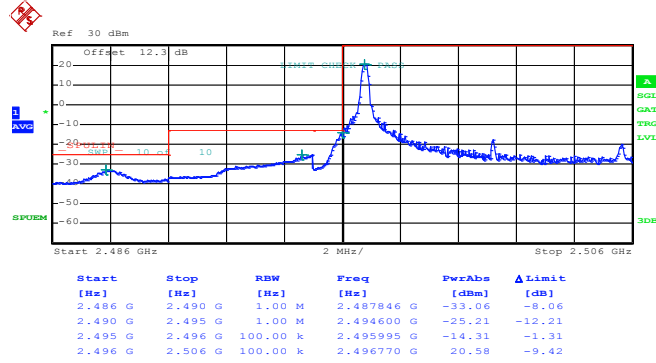

Date: 11.MAR.2014 09:08:28

Lower Band Edge Plot for 16QAM-RB Size 50, RB Offset 0

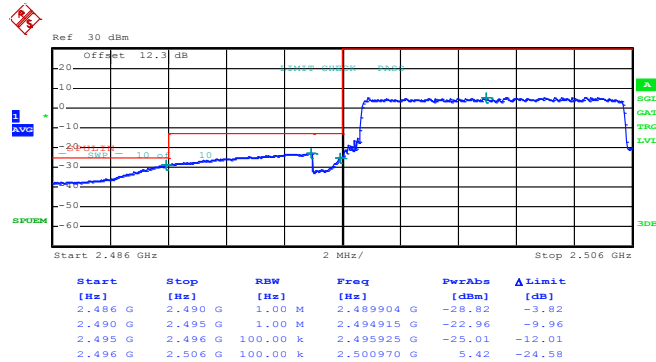

Date: 11.MAR.2014 09:11:20



Higher Band Edge Plot for 16QAM-RB Size 1, RB Offset 49

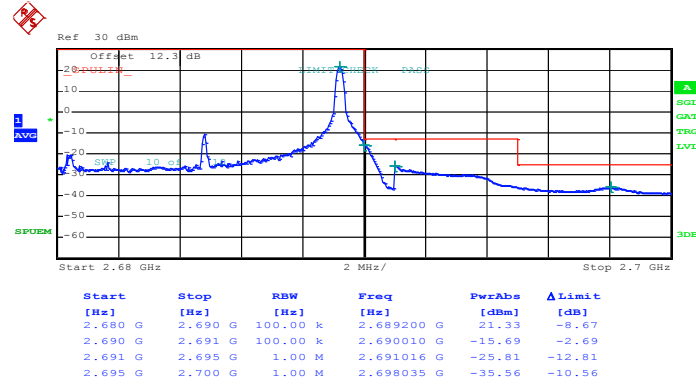

Date: 11.MAR.2014 08:52:04

Higher Band Edge Plot for 16QAM-RB Size 50, RB Offset 0

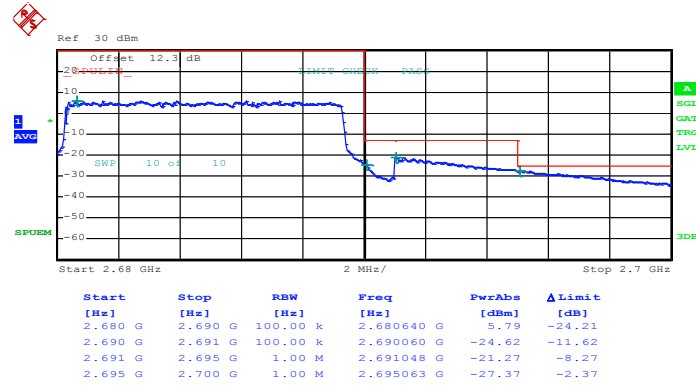

Date: 11.MAR.2014 08:39:43



Band :	LTE Band 41	Band Width :	15MHz / QPSK
---------------	-------------	---------------------	--------------

Lower Band Edge Plot for QPSK-RB Size 1, RB Offset 0

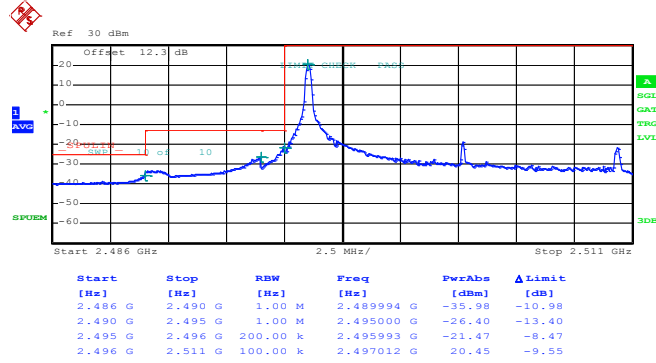

Date: 11.MAR.2014 09:23:21

Lower Band Edge Plot for QPSK-RB Size 75, RB Offset 0

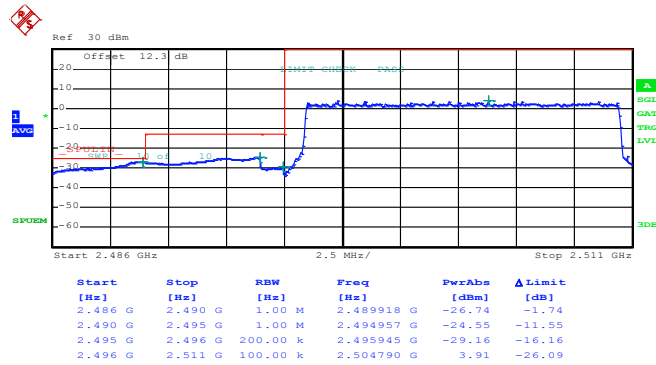

Date: 11.MAR.2014 09:16:19



Higher Band Edge Plot for QPSK-RB Size 1, RB Offset 74

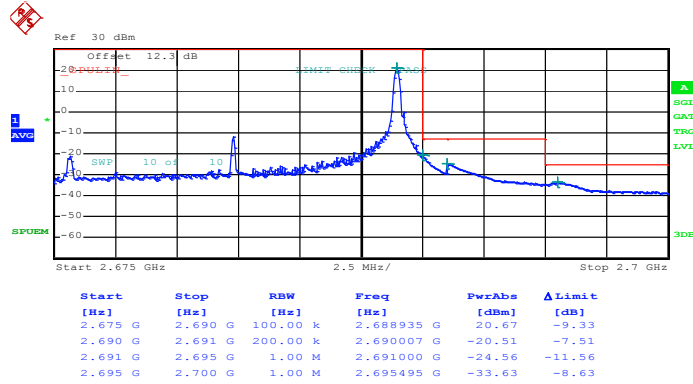

Date: 11.MAR.2014 09:27:10

Higher Band Edge Plot for QPSK-RB Size 75, RB Offset 0

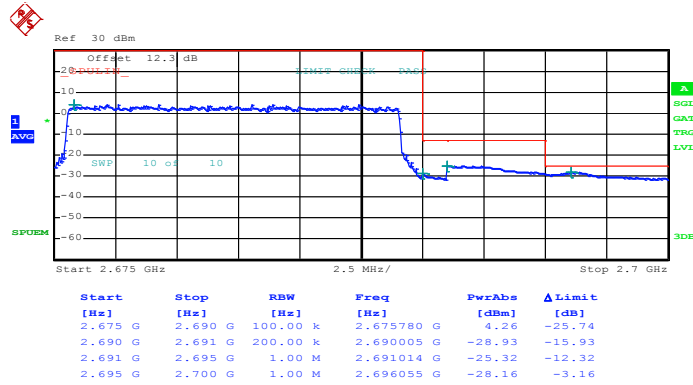

Date: 11.MAR.2014 09:32:27



Band :	LTE Band 41	Band Width :	15MHz / 16QAM
---------------	-------------	---------------------	---------------

Lower Band Edge Plot for 16QAM-RB Size 1, RB Offset 0

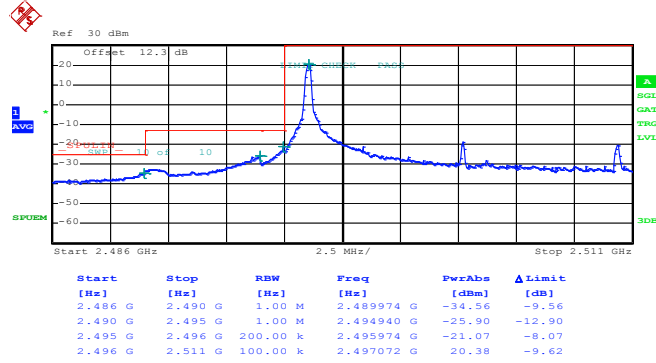

Date: 11.MAR.2014 09:21:48

Lower Band Edge Plot for 16QAM-RB Size 75, RB Offset 0

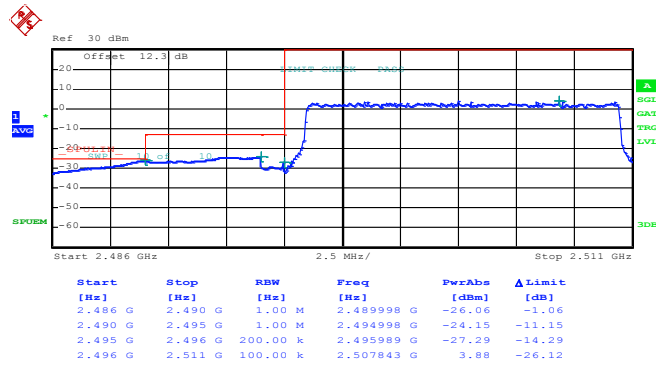

Date: 11.MAR.2014 09:18:16



Higher Band Edge Plot for 16QAM-RB Size 1, RB Offset 74

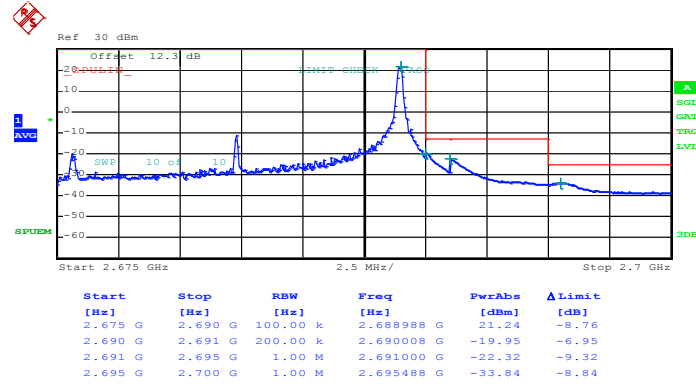

Date: 11.MAR.2014 09:28:49

Higher Band Edge Plot for 16QAM-RB Size 75, RB Offset 0

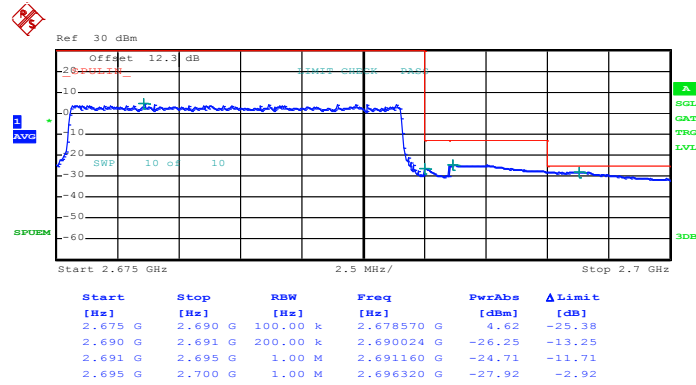

Date: 11.MAR.2014 09:30:51



Band :	LTE Band 41	Band Width	20MHz / QPSK
---------------	-------------	-------------------	--------------

Lower Band Edge Plot for QPSK-RB Size 1, RB Offset 0

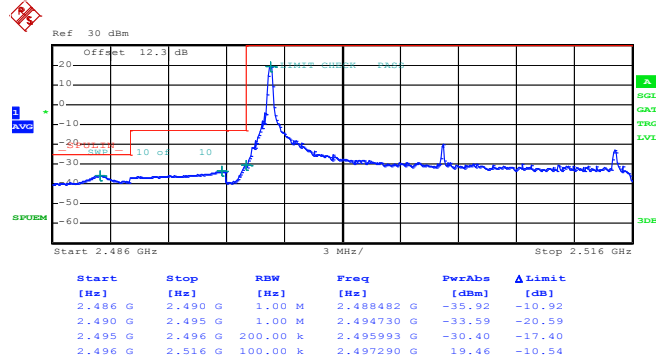

Date: 11.MAR.2014 10:00:29

Lower Band Edge Plot for QPSK-RB Size 100, RB Offset 0

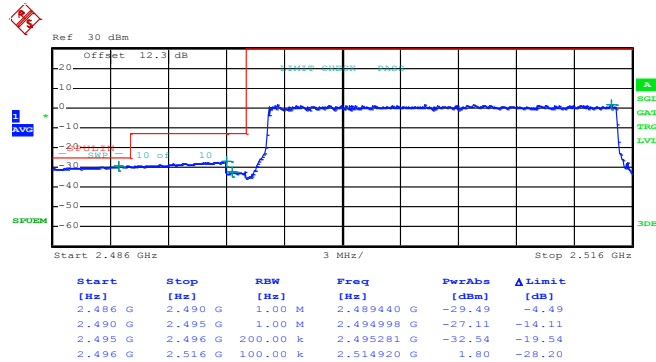

Date: 11.MAR.2014 10:07:00



Higher Band Edge Plot for QPSK-RB Size 1, RB Offset 99

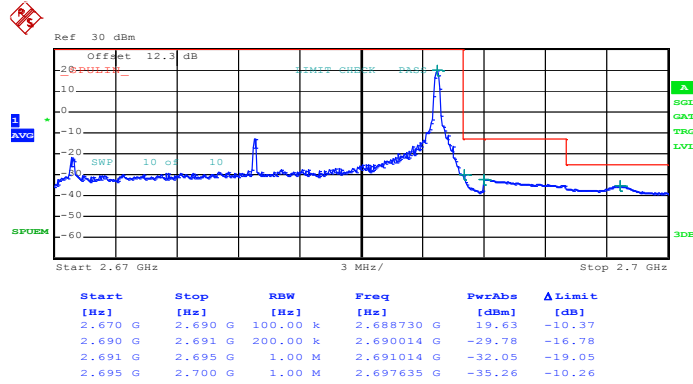

Date: 11.MAR.2014 09:40:47

Higher Band Edge Plot for QPSK-RB Size 100, RB Offset 0

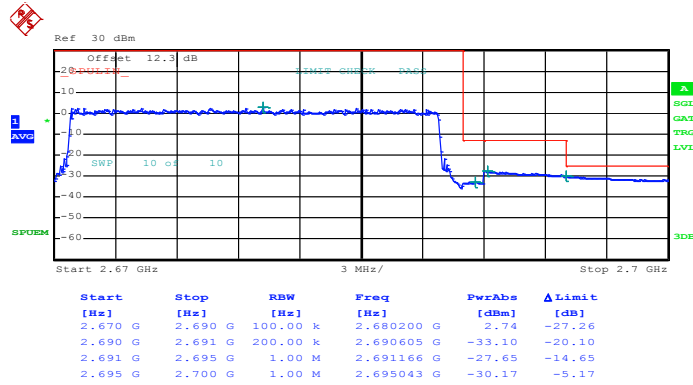

Date: 11.MAR.2014 09:35:15



Band :	LTE Band 41	Band Width	20MHz / 16QAM
---------------	-------------	-------------------	---------------

Lower Band Edge Plot for 16QAM-RB Size 1, RB Offset 0

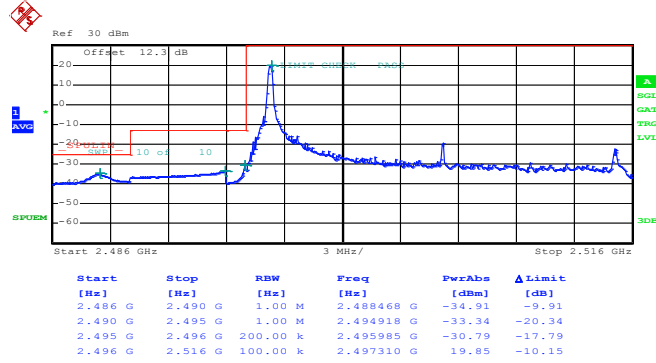

Date: 11.MAR.2014 10:03:02

Lower Band Edge Plot for 16QAM-RB Size 100, RB Offset 0

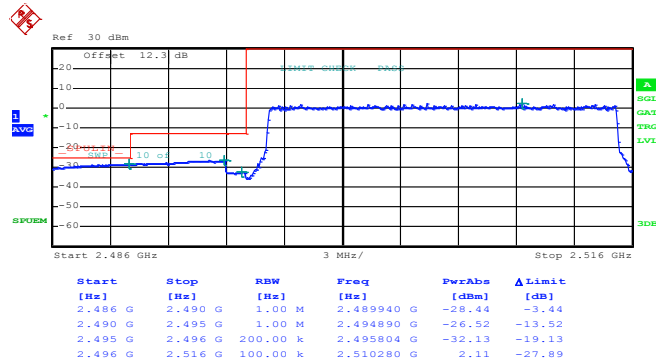

Date: 11.MAR.2014 10:05:08



Higher Band Edge Plot for 16QAM-RB Size 1, RB Offset 99

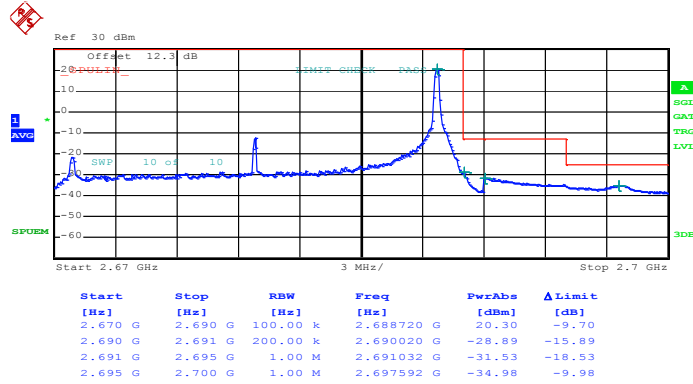

Date: 11.MAR.2014 09:38:55

Higher Band Edge Plot for 16QAM-RB Size 100, RB Offset 0

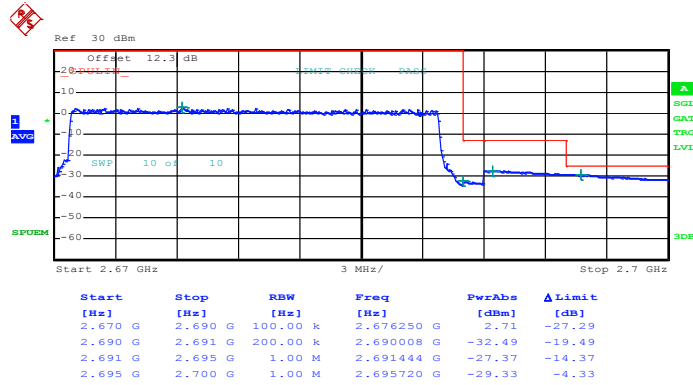

Date: 11.MAR.2014 09:36:55

3.4 Conducted Spurious Emission Measurement

3.4.1 Description of Conducted Emission Measurement

The power of any emission outside of the authorized operating frequency ranges must be lower than the transmitter power (P) by a factor of at least $55 + 10 \log (P)$ dB.

It is measured by means of a calibrated spectrum analyzer and scanned from 9 kHz up to a frequency including its 10th harmonic.

3.4.2 Measuring Instruments

The measuring equipment is listed in the section 4 of this test report.

3.4.3 Test Procedures

1. The EUT was connected to spectrum analyzer and base station via power divider.
2. The RF output of EUT was connected to the spectrum analyzer by RF cable and attenuator. The path loss was compensated to the results for each measurement.
3. The middle channel for the highest RF power within the transmitting frequency was measured.
4. The conducted spurious emission for the whole frequency range was taken.
5. Make the measurement with the spectrum analyzer's RBW = 1MHz, VBW = 3MHz, taking the record of maximum spurious emission.
6. The RF fundamental frequency should be excluded against the limit line in the operating frequency band.
7. The limit line is derived from $55 + 10\log(P)$ dB below the transmitter power P(Watts)
 - = $P(W) - [55 + 10\log(P)]$ (dB)
 - = $[30 + 10\log(P)]$ (dBm) - $[55 + 10\log(P)]$ (dB)
 - = -25dBm.

3.4.4 Test Setup

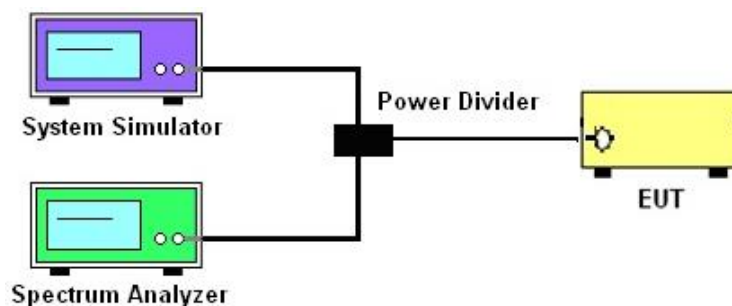



3.4.5 Test Result (Plots) of Conducted Emission

Band :	LTE Band 41	Channel :	CH39677 (Low)
Band Width	5MHz		

QPSK (RB Size 1, RB Offset 0)

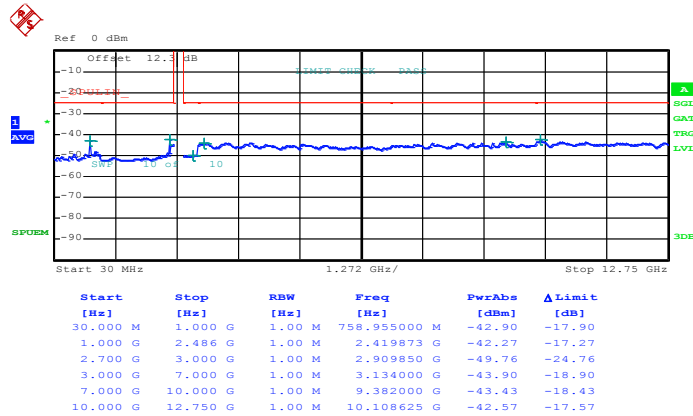

Date: 11.MAR.2014 10:40:26



16QAM (RB Size 1, RB Offset 0)

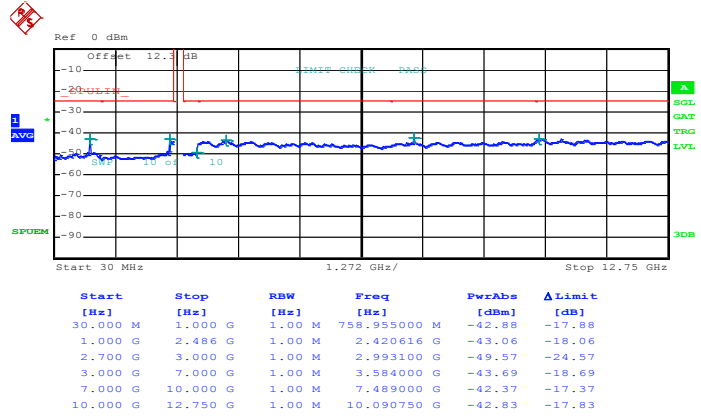

Date: 11.MAR.2014 10:39:19



Band :	LTE Band 41	Channel :	CH40620 (Middle)
Band Width	5MHz		

QPSK (RB Size 1, RB Offset 0)

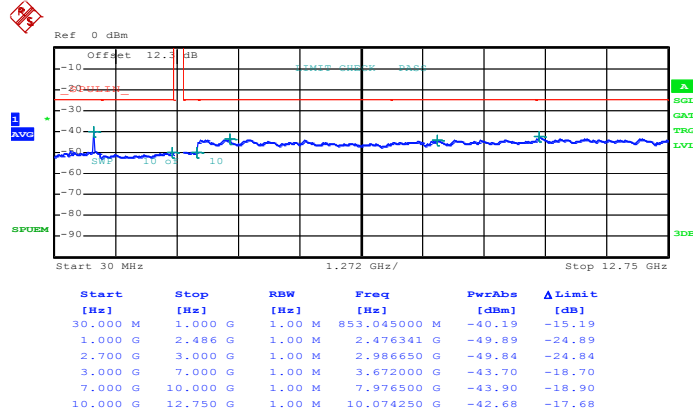

Date: 11.MAR.2014 10:35:18



16QAM (RB Size 1, RB Offset 0)

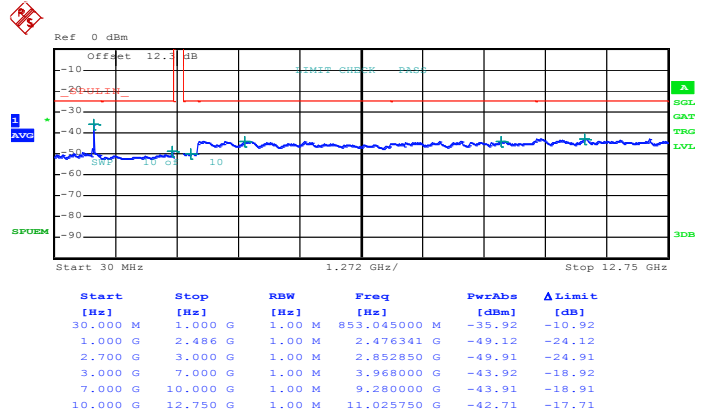

Date: 11.MAR.2014 10:36:43



Band :	LTE Band 41	Channel :	CH41563 (High)
Band Width	5MHz		

QPSK (RB Size 1, RB Offset 0)

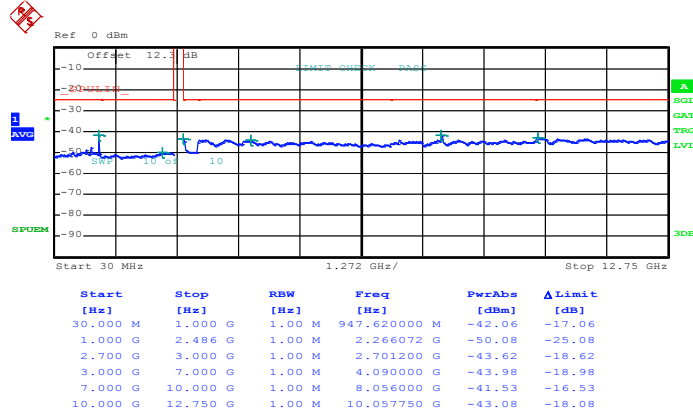

Date: 11.MAR.2014 10:41:47



16QAM (RB Size 1, RB Offset 0)

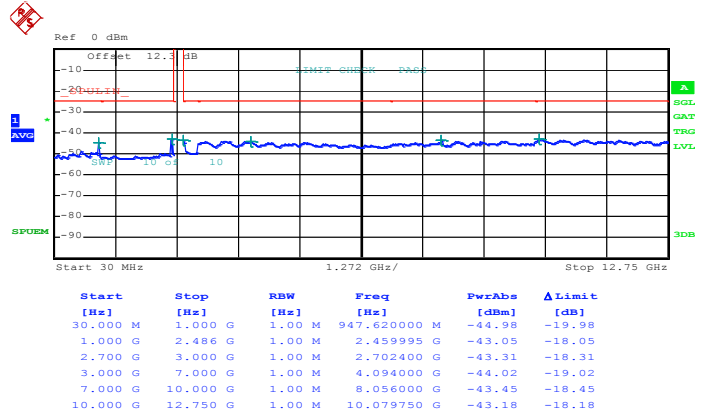

Date: 11.MAR.2014 10:42:58



Band :	LTE Band 41	Channel :	CH39702 (Low)
Band Width	10MHz		

QPSK (RB Size 1, RB Offset 0)

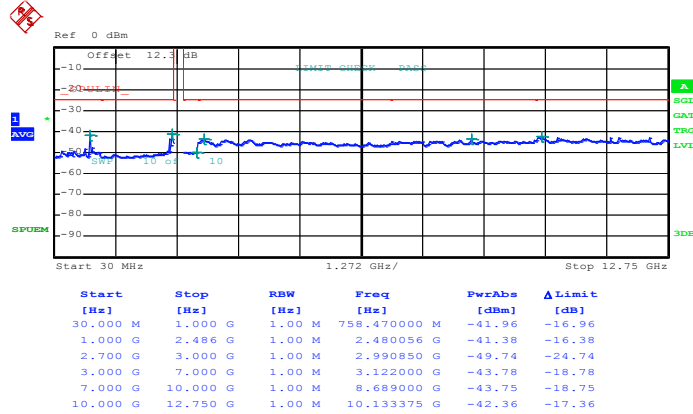

Date: 11.MAR.2014 10:27:45



16QAM (RB Size 1, RB Offset 0)

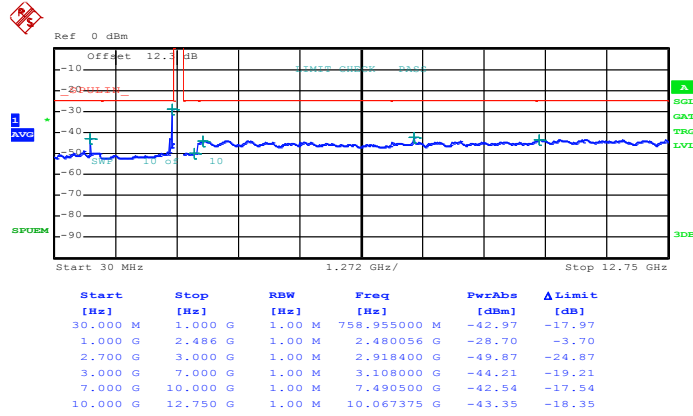

Date: 11.MAR.2014 10:28:47



Band :	LTE Band 41	Channel :	CH40620 (Middle)
Band Width	10MHz		

QPSK (RB Size 1, RB Offset 0)

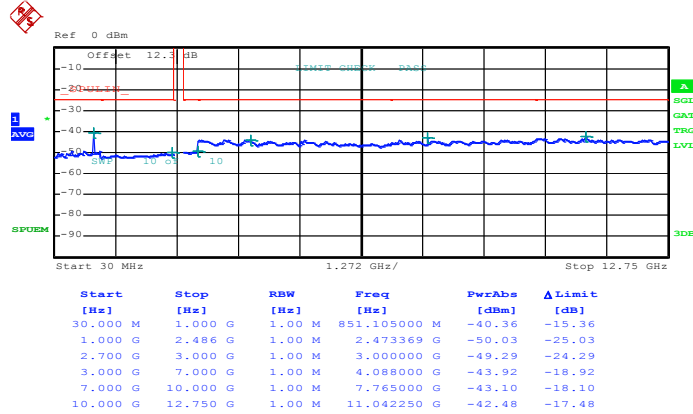

Date: 11.MAR.2014 10:32:32



16QAM (RB Size 1, RB Offset 0)

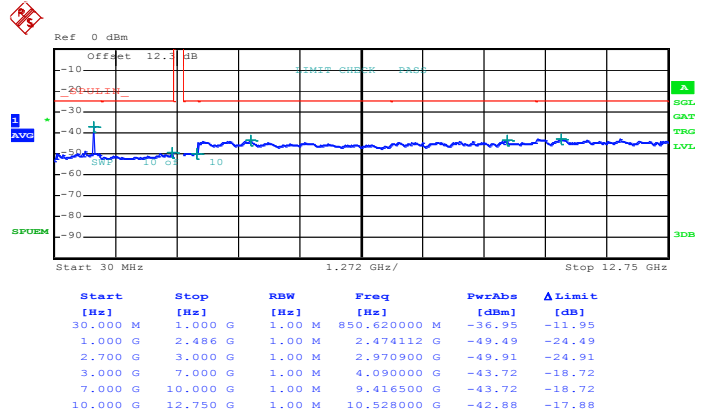

Date: 11.MAR.2014 10:33:42



Band :	LTE Band 41	Channel :	CH41538 (High)
Band Width	10MHz		

QPSK (RB Size 1, RB Offset 0)

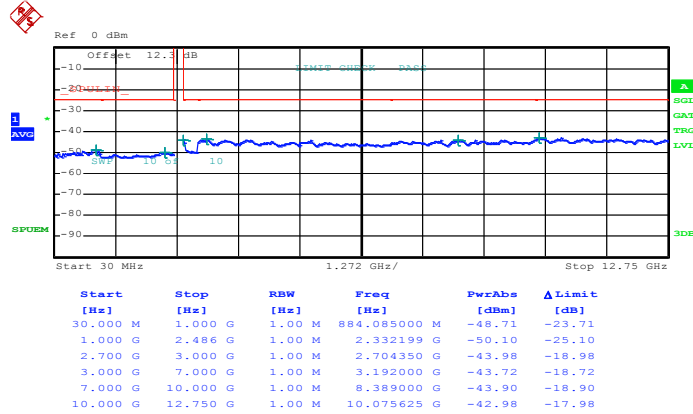

Date: 11.MAR.2014 10:31:21



16QAM (RB Size 1, RB Offset 0)

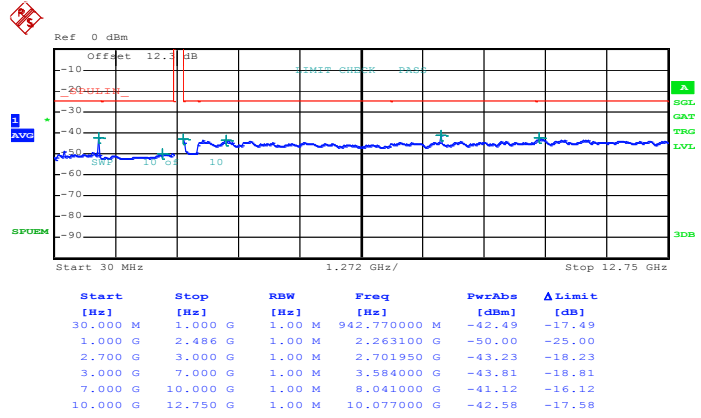

Date: 11.MAR.2014 10:30:11



Band :	LTE Band 41	Channel :	CH39727 (Low)
Band Width	15MHz		

QPSK (RB Size 1, RB Offset 0)

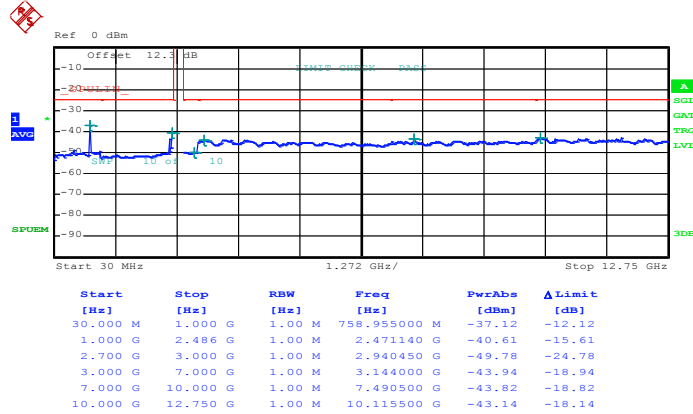

Date: 11.MAR.2014 10:24:32



16QAM (RB Size 50, RB Offset 0)

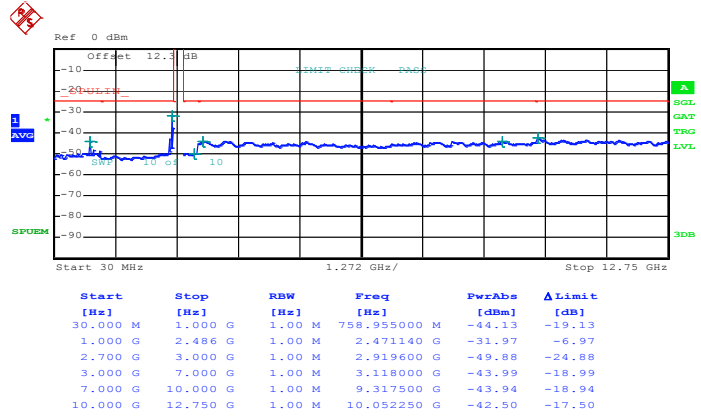

Date: 11.MAR.2014 10:25:44



Band :	LTE Band 41	Channel :	CH40620 (Middle)
Band Width	15MHz		

QPSK (RB Size 1, RB Offset 0)

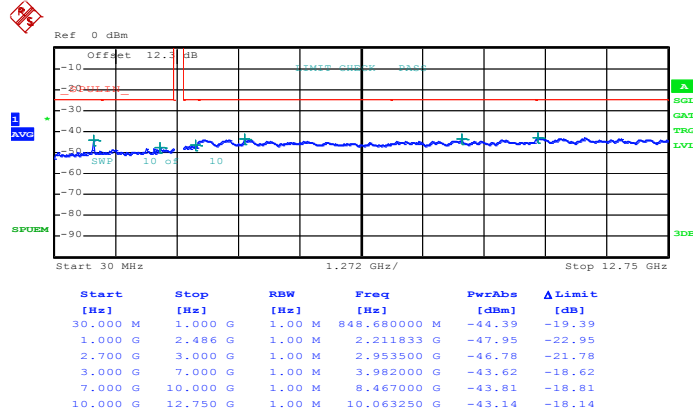

Date: 11.MAR.2014 10:18:33



16QAM (RB Size 1, RB Offset 0)

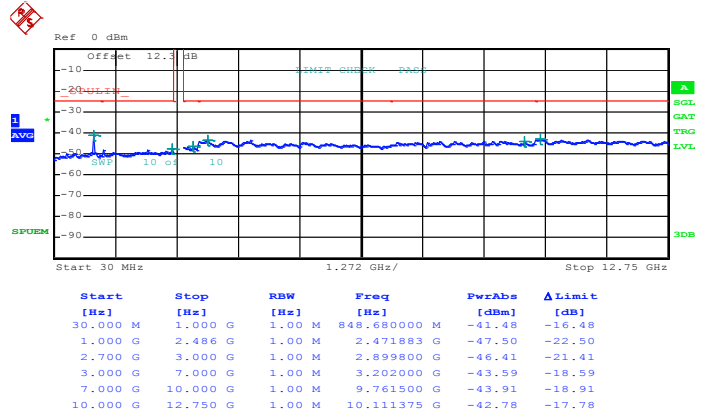

Date: 11.MAR.2014 10:19:22



Band :	LTE Band 41	Channel :	CH41513 (High)
Band Width	15MHz		

QPSK (RB Size 1, RB Offset 0)

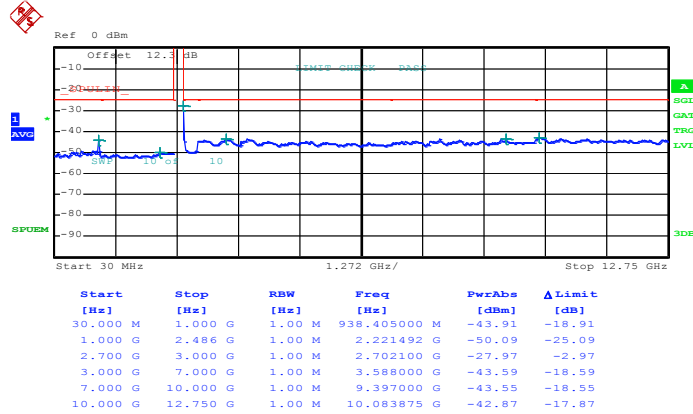

Date: 11.MAR.2014 10:22:33



16QAM (RB Size 1, RB Offset 0)

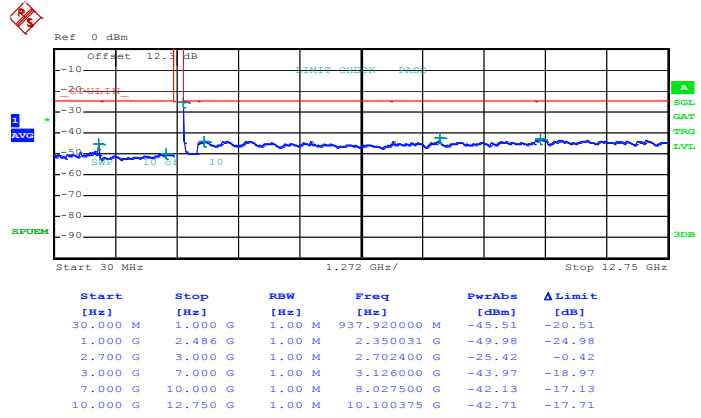

Date: 11.MAR.2014 10:21:14



Band :	LTE Band 41	Channel :	CH39752 (Low)
Band Width	20MHz		

QPSK (RB Size 1, RB Offset 0)

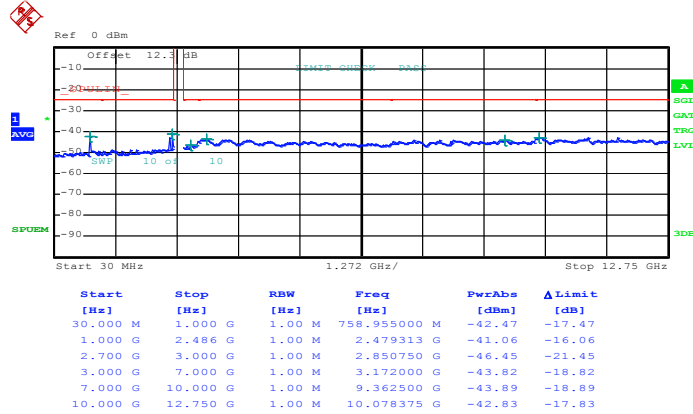

Date: 11.MAR.2014 10:12:03



16QAM (RB Size 1, RB Offset 0)

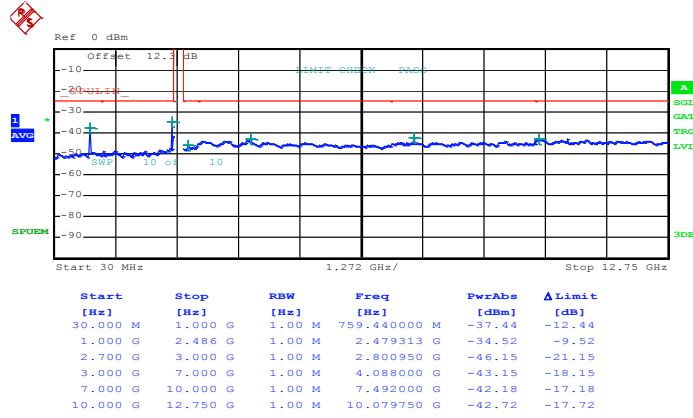

Date: 11.MAR.2014 10:12:48



Band :	LTE Band 41	Channel :	CH40620 (Middle)
Band Width	20MHz		

QPSK (RB Size 1, RB Offset 0)

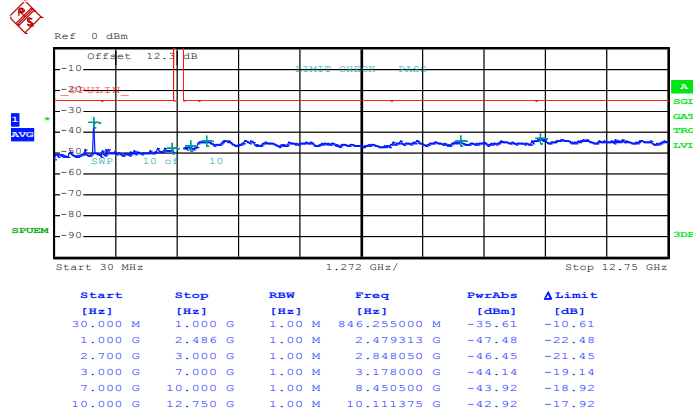

Date: 11.MAR.2014 10:16:03



16QAM (RB Size 1, RB Offset 0)

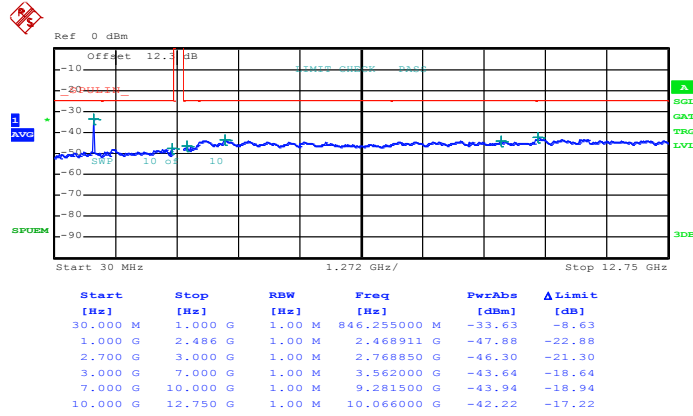

Date: 11.MAR.2014 10:17:11



Band :	LTE Band 41	Channel :	CH41488 (High)
Band Width	20MHz		

QPSK (RB Size 1, RB Offset 0)

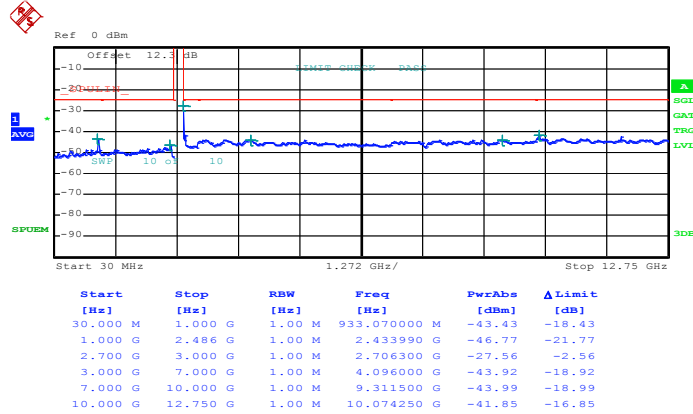

Date: 11.MAR.2014 10:14:41



16QAM (RB Size 1, RB Offset 0)

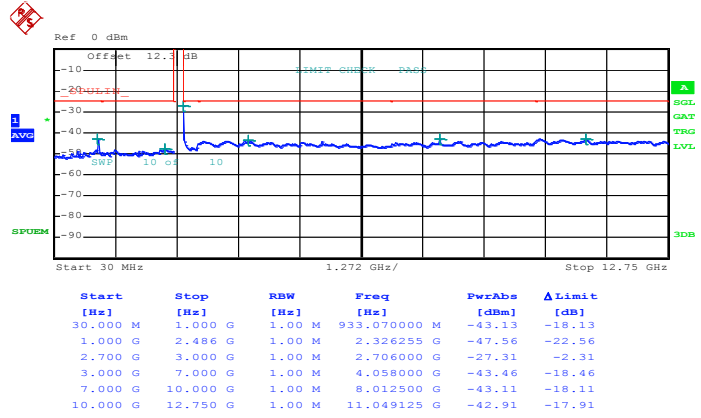

Date: 11.MAR.2014 10:13:49



3.5 Radiated Spurious Emission Measurement

3.5.1 Description of Radiated Spurious Emission

The radiated spurious emission was measured by substitution method according to ANSI / TIA / EIA-603-C-2004. The power of any emission outside of the authorized operating frequency ranges must be attenuated below the transmitter power (P) by a factor of at least $55 + 10 \log (P)$ dB.

The spectrum is scanned from 30 MHz up to a frequency including its 10th harmonic.

3.5.2 Measuring Instruments

The measuring equipment is listed in the section 4 of this test report.

3.5.3 Test Procedures

1. The EUT was placed on a rotatable wooden table with 0.8 meter above ground.
2. The EUT was set 3 meters from the receiving antenna, which was mounted on the antenna tower.
3. The table was rotated 360 degrees to determine the position of the highest spurious emission.
4. The height of the receiving antenna is varied between one meter and four meters to search the maximum spurious emission for both horizontal and vertical polarizations.
5. Make the measurement with the spectrum analyzer's RBW = 1MHz, VBW = 3MHz, taking the record of maximum spurious emission.
6. A horn antenna was substituted in place of the EUT and was driven by a signal generator.
7. Tune the output power of signal generator to the same emission level with EUT maximum spurious emission.
8. Taking the record of output power at antenna port.
9. Repeat step 7 to step 8 for another polarization.
10. The RF fundamental frequency should be excluded against the limit line in the operating frequency band.

$$\begin{aligned} &\text{The limit line is derived from } 55 + 10\log(P)\text{dB below the transmitter power } P(\text{Watts}) \\ &= P(\text{W}) - [55 + 10\log(P)] \text{ (dB)} \\ &= [30 + 10\log(P)] \text{ (dBm)} - [55 + 10\log(P)] \text{ (dB)} \\ &= -25\text{dBm}. \end{aligned}$$

11. $\text{EIRP (dBm)} = \text{S.G. Power} - \text{Tx Cable Loss} + \text{Tx Antenna Gain}$
12. $\text{ERP (dBm)} = \text{EIRP} - 2.15$

3.5.4 Test Setup

For radiated emissions from 30MHz to 1GHz

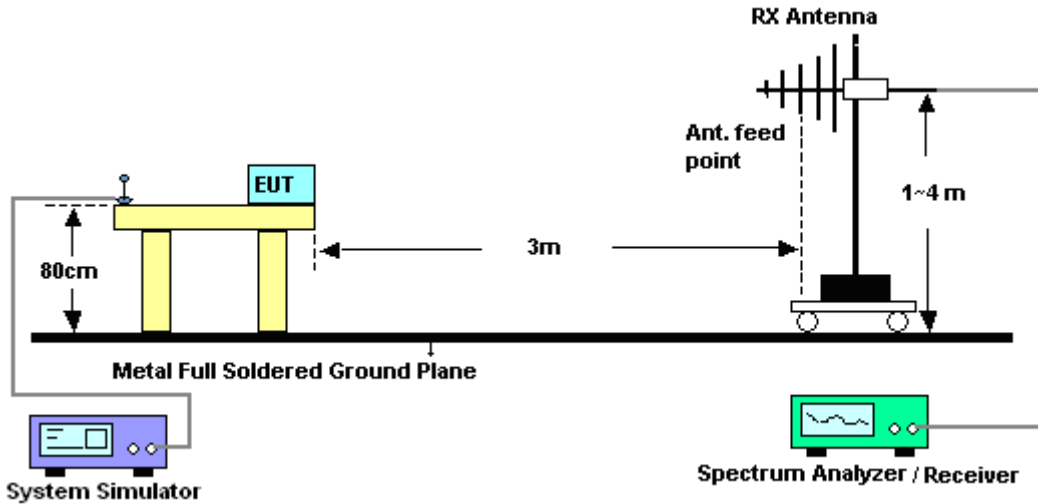

For radiated emissions above 1GHz

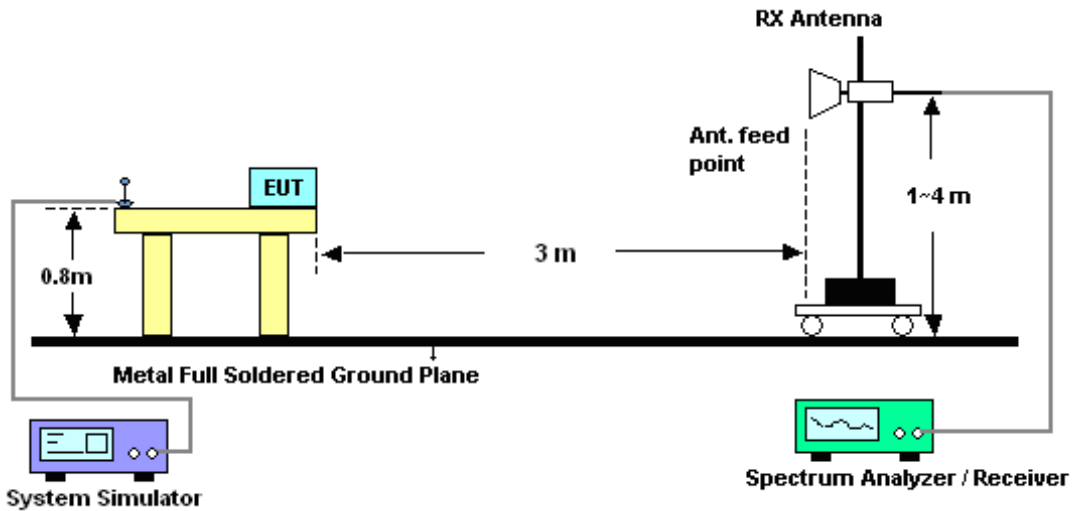

3.5.5 Test Results of Radiated Emissions (9 kHz ~ 30 MHz)

The low frequency, which started from 9 kHz to 30MHz, was pre-scanned and the result which was 20dB lower than the limit line per was not reported.



3.5.6 Test Result of Field Strength of Spurious Radiated

Band :	LTE Band 41	Temperature :	20~22°C
Test Mode :	5MHz QPSK RB Size 12 Offset 6	Relative Humidity :	51~55%
Test Engineer :	Ken Wu	Polarization :	Horizontal
Remark :	Spurious emissions within 30-10th harmonic were found more than 20dB below limit line.		

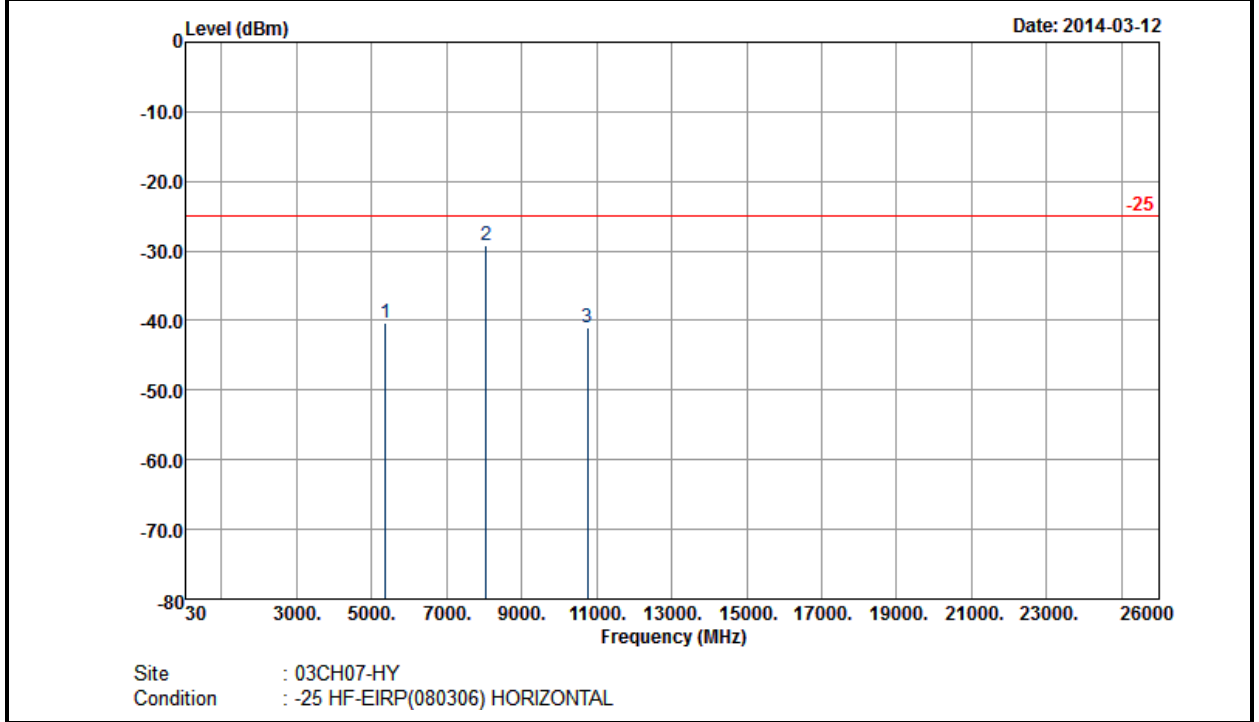

Frequency (MHz)	EIRP (dBm)	Limit (dBm)	Over Limit (dB)	SPA Reading (dBm)	S.G. Power (dBm)	TX Cable loss (dB)	TX Antenna Gain (dBi)	Polarization (H/V)	Result
5375	-40.29	-25	-15.29	-60.32	-43.8	6.98	10.49	H	Pass
8060	-29.15	-25	-4.15	-52.95	-30.1	9.43	10.38	H	Pass
10750	-41.01	-25	-16.01	-70.16	-45.1	8.79	12.88	H	Pass



Band :	LTE Band 41	Temperature :	20~22°C
Test Mode :	5MHz QPSK RB Size 12 Offset 6	Relative Humidity :	51~55%
Test Engineer :	Ken Wu	Polarization :	Vertical
Remark :	Spurious emissions within 30-10th harmonic were found more than 20dB below limit line.		

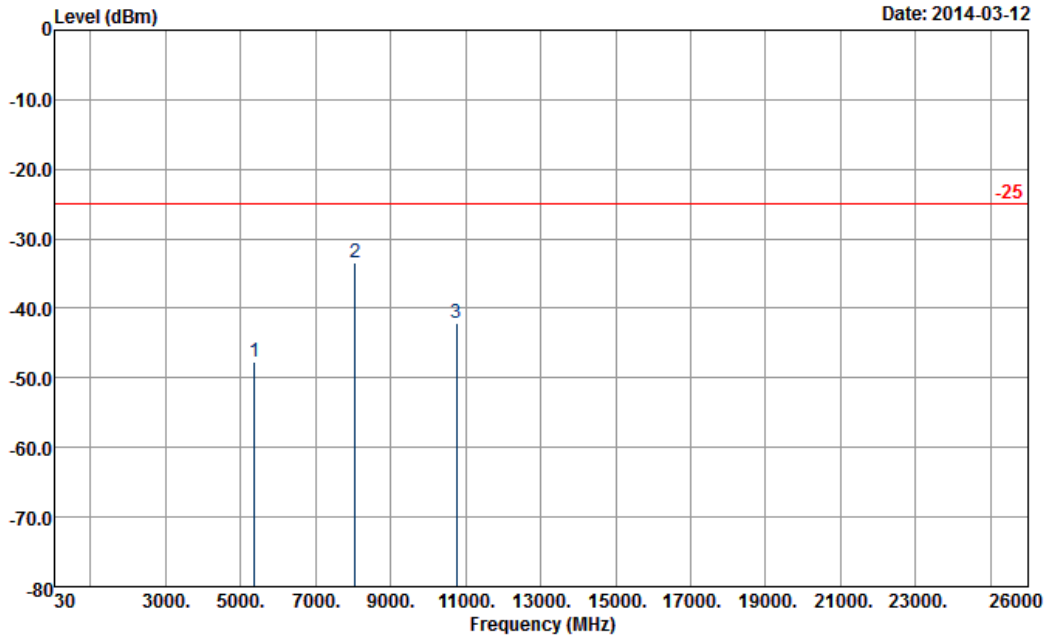

Site : 03CH07-HY
 Condition : -25 HF-EIRP(080306) VERTICAL

Frequency (MHz)	EIRP (dBm)	Limit (dBm)	Over Limit (dB)	SPA Reading (dBm)	S.G. Power (dBm)	TX Cable loss (dB)	TX Antenna Gain (dBi)	Polarization (H/V)	Result
5375	-47.69	-25	-22.69	-67.5	-51.2	6.98	10.49	V	Pass
8060	-33.45	-25	-8.45	-57.27	-34.4	9.43	10.38	V	Pass
10750	-42.01	-25	-17.01	-70.75	-46.1	8.79	12.88	V	Pass



Band :	LTE Band 41	Temperature :	20~22°C
Test Mode :	10MHz QPSK RB Size 1 Offset 0	Relative Humidity :	51~55%
Test Engineer :	Ken Wu	Polarization :	Horizontal
Remark :	Spurious emissions within 30-10th harmonic were found more than 20dB below limit line.		

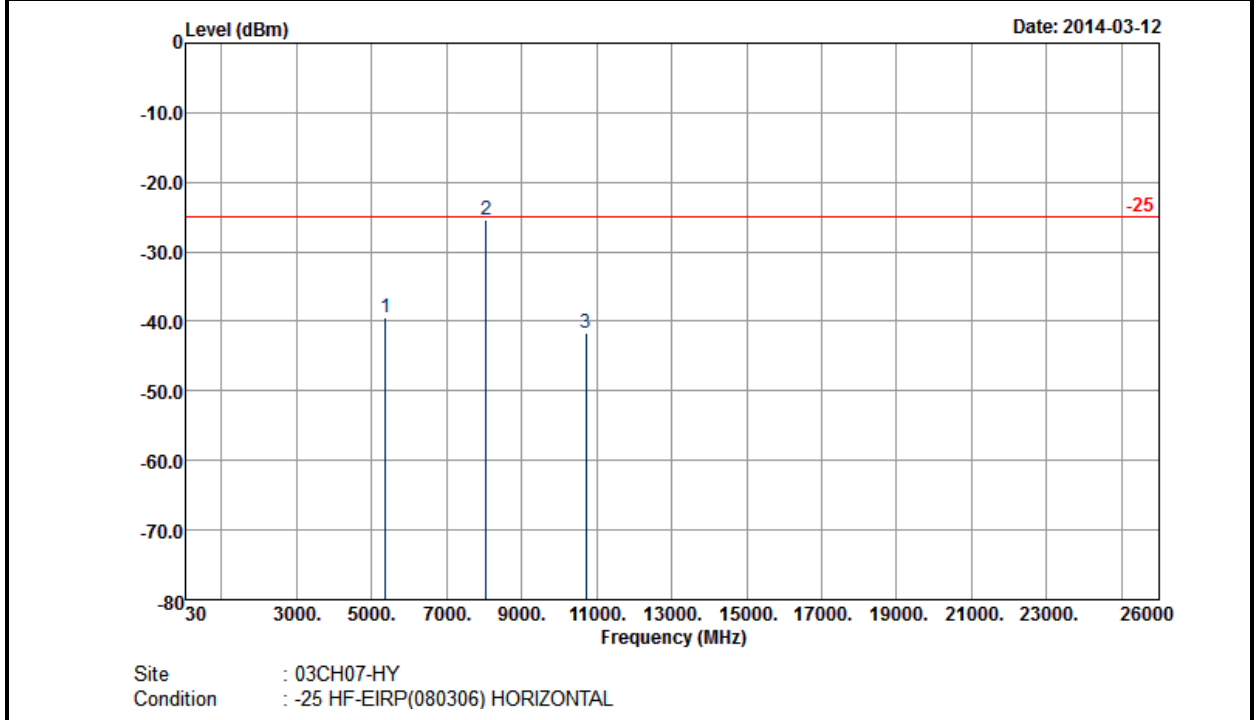

Frequency (MHz)	EIRP (dBm)	Limit (dBm)	Over Limit (dB)	SPA Reading (dBm)	S.G. Power (dBm)	TX Cable loss (dB)	TX Antenna Gain (dBi)	Polarization (H/V)	Result
5360	-39.39	-25	-14.39	-59.05	-42.9	6.97	10.48	H	Pass
8040	-25.36	-25	-0.36	-48.4	-26.3	9.42	10.36	H	Pass
10720	-41.70	-25	-16.70	-70.9	-45.8	8.76	12.86	H	Pass



Band :	LTE Band 41	Temperature :	20~22°C
Test Mode :	10MHz QPSK RB Size 1 Offset 0	Relative Humidity :	51~55%
Test Engineer :	Ken Wu	Polarization :	Vertical
Remark :	Spurious emissions within 30-10th harmonic were found more than 20dB below limit line.		

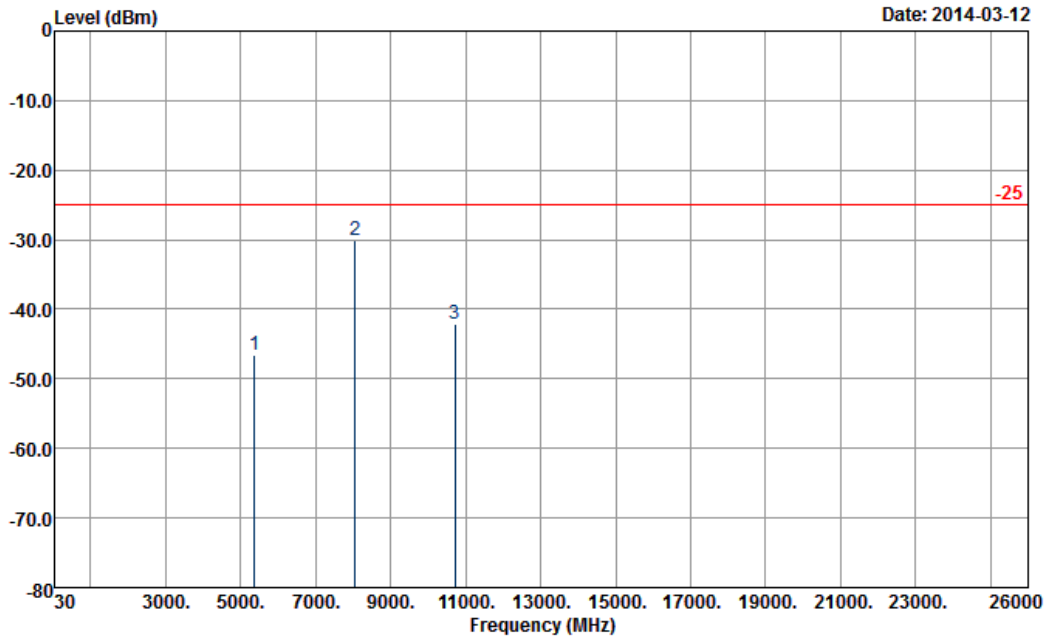

Site : 03CH07-HY
 Condition : -25 HF-EIRP(080306) VERTICAL

Frequency (MHz)	EIRP (dBm)	Limit (dBm)	Over Limit (dB)	SPA Reading (dBm)	S.G. Power (dBm)	TX Cable loss (dB)	TX Antenna Gain (dBi)	Polarization (H/V)	Result
5360	-46.49	-25	-21.49	-65.7	-50	6.97	10.48	V	Pass
8040	-30.16	-25	-5.16	-54.29	-31.1	9.42	10.36	V	Pass
10720	-42.10	-25	-17.10	-70.81	-46.2	8.76	12.86	V	Pass



Band :	LTE Band 41	Temperature :	20~22°C
Test Mode :	15MHz QPSK RB Size 1 Offset 0	Relative Humidity :	51~55%
Test Engineer :	Ken Wu	Polarization :	Horizontal
Remark :	Spurious emissions within 30-10th harmonic were found more than 20dB below limit line.		

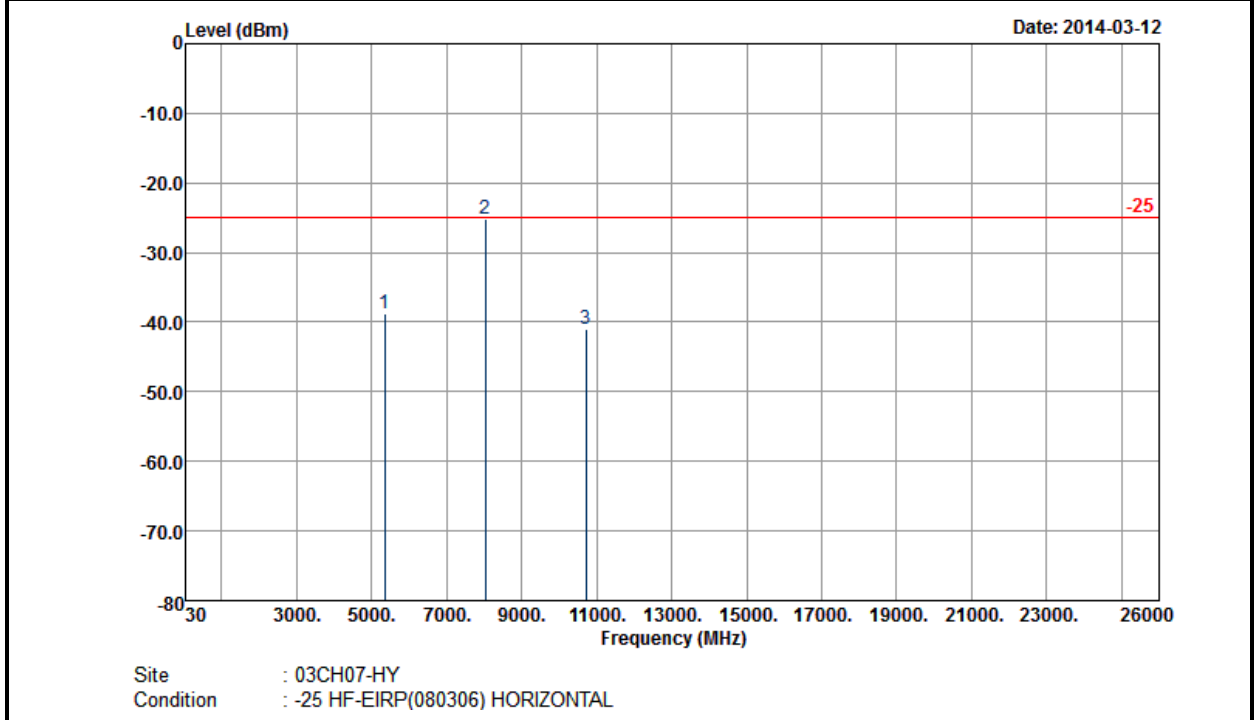

Frequency (MHz)	EIRP (dBm)	Limit (dBm)	Over Limit (dB)	SPA Reading (dBm)	S.G. Power (dBm)	TX Cable loss (dB)	TX Antenna Gain (dBi)	Polarization (H/V)	Result
5355	-38.69	-25	-13.69	-58.29	-42.2	6.96	10.47	H	Pass
8028	-25.16	-25	-0.16	-47.87	-26.1	9.41	10.35	H	Pass
10715	-41.10	-25	-16.10	-70.75	-45.2	8.75	12.85	H	Pass



Band :	LTE Band 41	Temperature :	20~22°C
Test Mode :	15MHz QPSK RB Size 1 Offset 0	Relative Humidity :	51~55%
Test Engineer :	Ken Wu	Polarization :	Vertical
Remark :	Spurious emissions within 30-10th harmonic were found more than 20dB below limit line.		

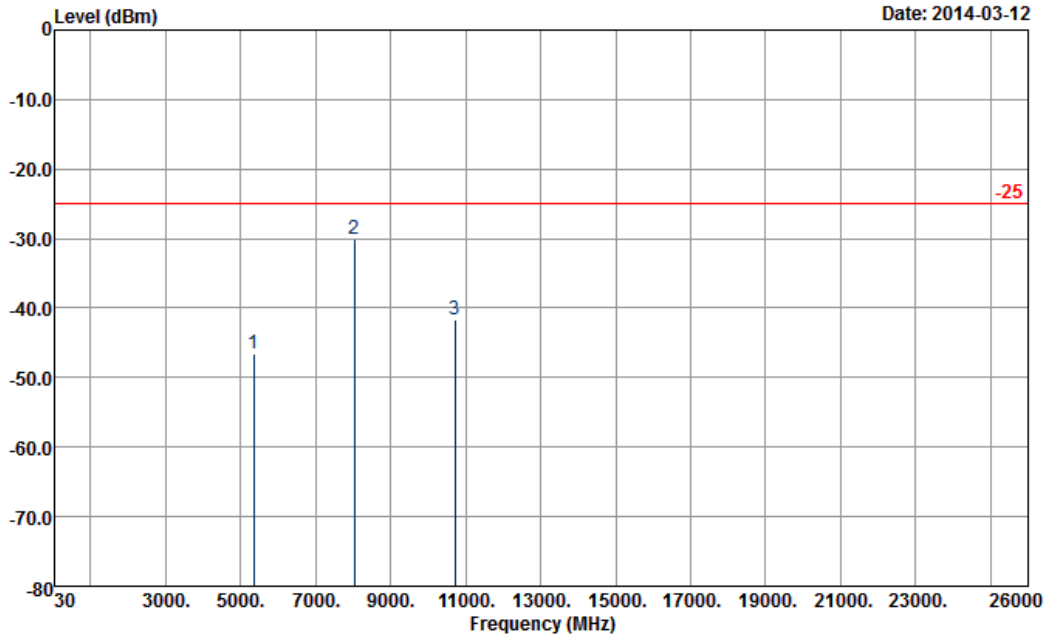

Site : 03CH07-HY
 Condition : -25 HF-EIRP(080306) VERTICAL

Frequency (MHz)	EIRP (dBm)	Limit (dBm)	Over Limit (dB)	SPA Reading (dBm)	S.G. Power (dBm)	TX Cable loss (dB)	TX Antenna Gain (dBi)	Polarization (H/V)	Result
5355	-46.59	-25	-21.59	-66.01	-50.1	6.96	10.47	V	Pass
8028	-30.16	-25	-5.16	-54.34	-31.1	9.41	10.35	V	Pass
10715	-41.60	-25	-16.60	-70.4	-45.7	8.75	12.85	V	Pass



Band :	LTE Band 41	Temperature :	20~22°C
Test Mode :	20MHz QPSK RB Size 1 Offset 0	Relative Humidity :	51~55%
Test Engineer :	Ken Wu	Polarization :	Horizontal
Remark :	Spurious emissions within 30-10th harmonic were found more than 20dB below limit line.		

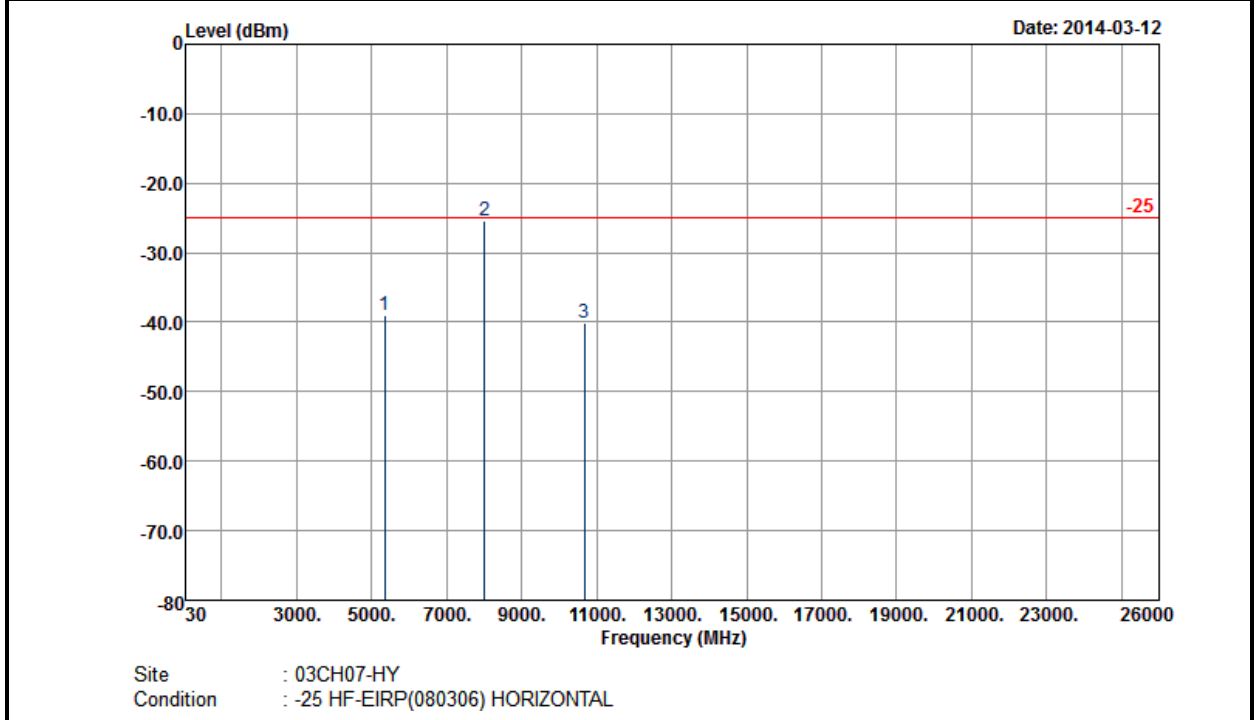

Frequency (MHz)	EIRP (dBm)	Limit (dBm)	Over Limit (dB)	SPA Reading (dBm)	S.G. Power (dBm)	TX Cable loss (dB)	TX Antenna Gain (dBi)	Polarization (H/V)	Result
5340	-38.99	-25	-13.99	-58.65	-42.5	6.95	10.46	H	Pass
8012	-25.44	-25	-0.44	-48.14	-26.4	9.39	10.35	H	Pass
10680	-40.01	-25	-15.01	-69.15	-44.1	8.74	12.83	H	Pass



Band :	LTE Band 41	Temperature :	20~22°C
Test Mode :	20MHz QPSK RB Size 1 Offset 0	Relative Humidity :	51~55%
Test Engineer :	Ken Wu	Polarization :	Vertical
Remark :	Spurious emissions within 30-10th harmonic were found more than 20dB below limit line.		

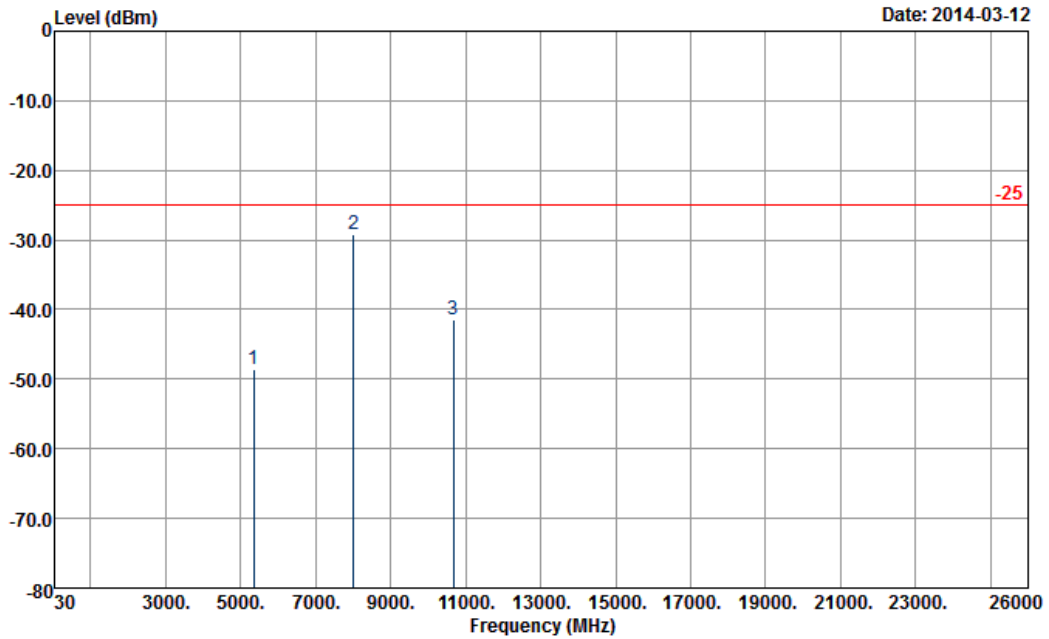

Site : 03CH07-HY
 Condition : -25 HF-EIRP(080306) VERTICAL

Frequency (MHz)	EIRP (dBm)	Limit (dBm)	Over Limit (dB)	SPA Reading (dBm)	S.G. Power (dBm)	TX Cable loss (dB)	TX Antenna Gain (dBi)	Polarization (H/V)	Result
5340	-48.69	-25	-23.69	-68.69	-52.2	6.95	10.46	V	Pass
8012	-29.24	-25	-4.24	-53.5	-30.2	9.39	10.35	V	Pass
10680	-41.41	-25	-16.41	-70	-45.5	8.74	12.83	V	Pass

3.6 Frequency Stability Measurement

3.6.1 Description of Frequency Stability Measurement

The frequency stability shall be measured by variation of ambient temperature and variation of primary supply voltage to ensure that the fundamental emission stays within the authorized frequency block. The frequency stability of the transmitter shall be maintained within $\pm 0.00025\%$ ($\pm 2.5\text{ppm}$) of the center frequency.

3.6.2 Measuring Instruments

The measuring equipment is listed in the section 4 of this test report.

3.6.3 Test Procedures for Temperature Variation

1. The EUT was set up in the thermal chamber and connected with the base station.
2. With power OFF, the temperature was decreased to -30°C and the EUT was stabilized before testing. Power was applied and the maximum change in frequency was recorded within one minute.
3. With power OFF, the temperature was raised in 10°C step up to 50°C . The EUT was stabilized at each step for at least half an hour. Power was applied and the maximum frequency change was recorded within one minute.

3.6.4 Test Procedures for Voltage Variation

1. The EUT was placed in a temperature chamber at $25\pm 5^{\circ}\text{C}$ and connected with the base station.
2. The power supply voltage to the EUT was varied from 85% to 115% of the nominal value measured at the input to the EUT.
3. The variation in frequency was measured for the worst case.

3.6.5 Test Setup

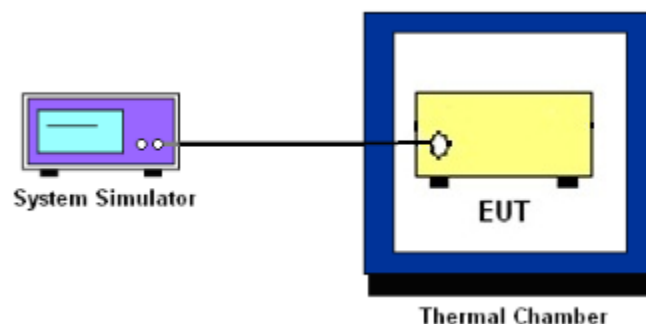

3.6.6 Test Result of Temperature Variation

Band :	LTE Band 41 (QPSK)	Limit (ppm) :	2.5
Temperature (°C)	BW 10MHz		Result
	Deviation (ppm)		
50	0.0044		PASS
40	0.0041		
30	0.0034		
20	0.0037		
10	0.0040		
0	0.0044		
-10	0.0034		
-20	0.0030		
-30	0.0038		

3.6.7 Test Result of Voltage Variation

Band	Bandwidth	Voltage (Volt)	Deviation (ppm)	Limit (ppm)	Result
LTE Band 41	10M	138.00	0.0033	2.5	PASS
		Normal	0.0029		
		102.00	0.0041		

Remark:

1. Normal Voltage = 120.00V.
2. The manufacturer declared that the EUT could work properly between voltage 102.00V ~ 138.00V.



4 List of Measuring Equipment

Instrument	Manufacturer	Model No.	Serial No.	Characteristics	Calibration Date	Test Date	Due Date	Remark
LTE Base Station	Anritsu	MT8820C	6201026480	30MHz~2.7GHz SISO (FDD Band 1~26)	Jan. 07, 2014	Mar. 10, 2014 ~ Mar. 11, 2014	Jan. 06, 2015	Conducted (TH02-HY)
Spectrum Analyzer	Rohde & Schwarz	FSP40	100055	9kHz~40GHz	Jun. 07, 2013	Mar. 10, 2014 ~ Mar. 11, 2014	Jun. 06, 2014	Conducted (TH02-HY)
Thermal Chamber	Ten Billion	TTH-D3SP	TBN-930701	N/A	Jul. 19, 2013	Mar. 10, 2014 ~ Mar. 11, 2014	Jul. 18, 2014	Conducted (TH02-HY)
Spectrum Analyzer	Rohde & Schwarz	FSP30	101067	9KHz ~ 30GHz	Nov. 20, 2013	Mar. 12, 2014	Nov. 19, 2014	Radiation (03CH07-HY)
Bilog Antenna	Schaffner	CBL6111C	2726	30MHz ~ 1GHz	Oct. 10, 2013	Mar. 12, 2014	Oct. 09, 2014	Radiation (03CH07-HY)
Double Ridge Horn Antenna	ESCO	3117	75962	1GHz~18GHz	Aug. 22, 2013	Mar. 12, 2014	Aug. 21, 2014	Radiation (03CH07-HY)
Preamplifier	SONOMA	310N	187231	9kHz~1GHz	May 15, 2013	Mar. 12, 2014	May 14, 2014	Radiation (03CH07-HY)
Preamplifier	Agilent	8449B	3008A02362	1 GHz~26.5 GHz	Nov. 29, 2013	Mar. 12, 2014	Nov. 28, 2014	Radiation (03CH07-HY)
Turn Table	ChainTek	ChainTek 3000	N/A	0 ~ 360 degree	N/A	Mar. 12, 2014	N/A	Radiation (03CH07-HY)
Antenna Mast	ChainTek	M-400-0	114/800060 4/L	N/A	N/A	Mar. 12, 2014	N/A	Radiation (03CH07-HY)
SHF-EHF Horn Antenna	SCHWARZBEC K	BBHA 9170	BBHA91702 51	15GHz- 40GHz	Oct. 03, 2013	Mar. 12, 2014	Oct. 02, 2014	Radiation (03CH07-HY)



5 Uncertainty of Evaluation

Uncertainty of Radiated Emission Measurement (30 MHz ~ 1000 MHz)

Measuring Uncertainty for a Level of Confidence of 95% ($U = 2Uc(y)$)	4.50
---	------