

FCC RF Test Report

APPLICANT : Green Packet Berhad, Taiwan
EQUIPMENT : TDD-LTE Band 41 Indoor CPE
BRAND NAME : Green Packet
MODEL NAME : DT-235
FCC ID : W9V-DT235-GP
STANDARD : FCC Part 15 Subpart C §15.247
CLASSIFICATION : (DTS) Digital Transmission System

The product was received on Jan. 24, 2014 and testing was completed on Feb. 21, 2014. We, SPORTON INTERNATIONAL INC., would like to declare that the tested sample has been evaluated in accordance with the procedures and shown to be compliant with the applicable technical standards.

The test results in this report apply exclusively to the tested model / sample. Without written approval of SPORTON INTERNATIONAL INC., the test report shall not be reproduced except in full.



Reviewed by: Joseph Lin / Supervisor



Approved by: Jones Tsai / Manager



SPORTON INTERNATIONAL INC.

No. 52, Hwa Ya 1st Rd., Hwa Ya Technology Park, Kwei-Shan Hsiang, Tao Yuan Hsien, Taiwan, R.O.C.

SPORTON INTERNATIONAL INC.

TEL : 886-3-327-3456

FAX : 886-3-328-4978

FCC ID : W9V-DT235-GP

Page Number : 1 of 77

Report Issued Date : Mar. 28, 2014

Report Version : Rev. 01



TABLE OF CONTENTS

REVISION HISTORY 3

SUMMARY OF TEST RESULT 4

1 GENERAL DESCRIPTION 5

 1.1 Applicant 5

 1.2 Manufacturer 5

 1.3 Feature of Equipment Under Test 5

 1.4 Product Specification of Equipment Under Test 6

 1.5 Modification of EUT 6

 1.6 Testing Site 7

 1.7 Applied Standards 7

2 TEST CONFIGURATION OF EQUIPMENT UNDER TEST 8

 2.1 Carrier Frequency and Channel 8

 2.2 Pre-Scanned RF Power 9

 2.3 Test Mode 11

 2.4 Connection Diagram of Test System 12

 2.5 Support Unit used in test configuration and system 13

 2.6 EUT Operation Test Setup 13

 2.7 Measurement Results Explanation Example 13

3 TEST RESULT 14

 3.1 6dB Bandwidth Measurement 14

 3.2 Peak Output Power Measurement 17

 3.3 Power Spectral Density Measurement 20

 3.4 Conducted Band Edges and Spurious Emission Measurement 23

 3.5 Radiated Band Edges and Spurious Emission Measurement 48

 3.6 AC Conducted Emission Measurement 70

 3.7 Antenna Requirements 74

4 LIST OF MEASURING EQUIPMENT 76

5 UNCERTAINTY OF EVALUATION 77

APPENDIX A. SETUP PHOTOGRAPHS



SUMMARY OF TEST RESULT

Report Section	FCC Rule	IC Rule	Description	Limit	Result	Remark
3.1	15.247(a)(2)	RSS-210 A8.2(a)	6dB Bandwidth	$\geq 0.5\text{MHz}$	Pass	-
3.2	15.247(b)	RSS-210 A8.4	Power Output Measurement	$\leq 30\text{dBm}$	Pass	-
3.3	15.247(e)	RSS-210 A8.2(b)	Power Spectral Density	$\leq 8\text{dBm}/3\text{kHz}$	Pass	-
3.4	15.247(d)	RSS-210 A8.5	Conducted Band Edges	$\leq 20\text{dBc}$	Pass	-
			Conducted Spurious Emission		Pass	-
3.5	15.247(d)	RSS-210 A8.5	Radiated Band Edges and Radiated Spurious Emission	15.209(a) & 15.247(d)	Pass	Under limit 0.40 dB at 2390.000 MHz
3.6	15.207	RSS-Gen 7.2.4	AC Conducted Emission	15.207(a)	Pass	Under limit 14.30 dB at 0.182 MHz
3.7	15.203 & 15.247(b)	RSS-210 A8.4	Antenna Requirement	N/A	Pass	-

1 General Description

1.1 Applicant

Green Packet Berhad, Taiwan

6F, No. 21, Lane 583, Rueiguang Rd. Neihu District, Taipei City 11492, Taiwan

1.2 Manufacturer

Green Packet Berhad, Taiwan

6F, No. 21, Lane 583, Rueiguang Rd. Neihu District, Taipei City 11492, Taiwan

1.3 Feature of Equipment Under Test

Product Feature	
Equipment	TDD-LTE Band 41 Indoor CPE
Brand Name	Green Packet
Model Name	DT-235
FCC ID	W9V-DT235-GP
EUT supports Radios application	LTE WLAN 11 b/g/n HT20/HT40
HW	miniPCI e, LTE module: WLTCS-101_V02 main: WLTXFSR-100GN_V00
SW	01.01.02.018
EUT Stage	Production Unit

Remark: The above EUT's information was declared by manufacturer. Please refer to the specifications or user's manual for more detailed description.

1.4 Product Specification of Equipment Under Test

Product Specification subjective to this standard																
Tx/Rx Channel Frequency Range	802.11b/g/n : 2412 MHz ~ 2462 MHz															
Maximum Output Power to antenna	<p><Ant. 1> 802.11b : 15.62 dBm (0.0365 W) 802.11g : 20.05 dBm (0.1012 W) SISO <Ant. 1> 802.11n HT20 : 19.46 dBm (0.0883 W) 802.11n HT40 : 19.54 dBm (0.0899 W) <Ant. 2> 802.11b : 15.65 dBm (0.0367 W) 802.11g : 20.18 dBm (0.1042 W) SISO <Ant. 2> 802.11n HT20 : 19.32 dBm (0.0855 W) 802.11n HT40 : 18.99 dBm (0.0793 W) MIMO <Ant. 1+2> 802.11n HT20 : 22.94 dBm (0.1968 W) 802.11n HT40 : 22.25 dBm (0.1679 W)</p>															
Antenna Type	<p><Ant. 1> 802.11b/g/n : PCB Antenna with gain 1.03 dBi <Ant. 2> 802.11b/g/n : PCB Antenna with gain 2.61 dBi</p>															
Type of Modulation	802.11b : DSSS (DBPSK / DQPSK / CCK) 802.11g/n : OFDM (BPSK / QPSK / 16QAM / 64QAM)															
Antenna Function for Transmitter	<table border="1"> <thead> <tr> <th></th> <th>Chain Port 0 Ant. 1</th> <th>Chain Port 1 Ant. 2</th> </tr> </thead> <tbody> <tr> <td>802.11 b</td> <td>V</td> <td>V</td> </tr> <tr> <td>802.11 g</td> <td>V</td> <td>V</td> </tr> <tr> <td>802.11 n SISO</td> <td>V</td> <td>V</td> </tr> <tr> <td>802.11 n MIMO</td> <td>V</td> <td>V</td> </tr> </tbody> </table>		Chain Port 0 Ant. 1	Chain Port 1 Ant. 2	802.11 b	V	V	802.11 g	V	V	802.11 n SISO	V	V	802.11 n MIMO	V	V
	Chain Port 0 Ant. 1	Chain Port 1 Ant. 2														
802.11 b	V	V														
802.11 g	V	V														
802.11 n SISO	V	V														
802.11 n MIMO	V	V														

1.5 Modification of EUT

No modifications are made to the EUT during all test items.

1.6 Testing Site

Test Site	SPORTON INTERNATIONAL INC.			
Test Site Location	No. 52, Hwa Ya 1 st Rd., Hwa Ya Technology Park, Kwei-Shan Hsiang, Tao Yuan Hsien, Taiwan, R.O.C. TEL: +886-3-3273456 / FAX: +886-3-3284978			
Test Site No.	Sporton Site No.			FCC/IC Registration No.
	TH02-HY	CO05-HY	03CH07-HY	722060/4086B-1

Note: The test site complies with ANSI C63.4 2003 requirement.

1.7 Applied Standards

According to the specifications of the manufacturer, the EUT must comply with the requirements of the following standards:

- ♦ FCC Part 15 Subpart C §15.247
- ♦ FCC KDB Publication No. 558074 D01 DTS Meas. Guidance v03r01
- ♦ FCC KDB 662911 D01 Multiple Transmitter Output v02r01.
- ♦ ANSI C63.4-2003

Remark:

1. All test items were verified and recorded according to the standards and without any deviation during the test.
2. This EUT has also been tested and complied with the requirements of FCC Part 15, Subpart B, recorded in a separate test report.

2 Test Configuration of Equipment Under Test

The EUT has been associated with peripherals and configuration operated in a manner tended to maximize its emission characteristics in a typical application. Frequency range investigated: conducted emission (150 kHz to 30 MHz) and radiated emission (9 kHz to the 10th harmonic of the highest fundamental frequency or to 40 GHz, whichever is lower). For radiated measurement, pre-scanned in three orthogonal panels, X, Y, Z. The worst cases (Z plane) were recorded in this report.

The final configuration from all the combinations and the worst-case data rates were investigated by measuring the maximum power across all the data rates and modulation modes under section 2.2.

Based on the worst configuration found above, the RF power setting is set individually to meet FCC compliance limit for the final conducted and radiated tests shown in section 2.3.

2.1 Carrier Frequency and Channel

Frequency Band	Channel	Freq. (MHz)	Channel	Freq. (MHz)
2400-2483.5 MHz	1	2412	7	2442
	2	2417	8	2447
	3	2422	9	2452
	4	2427	10	2457
	5	2432	11	2462
	6	2437		

2.2 Pre-Scanned RF Power

Preliminary tests were performed in different data rate and data rate associated with the highest power were chosen for full test shown in the following tables.

<Ant. 1>

802.11b				
Data Rate (MHz)	1M bps	2M bps	5.5M bps	11M bps
Peak Power (dBm)	15.62	15.59	14.89	15.54

802.11g								
Data Rate (MHz)	6M bps	9M bps	12M bps	18M bps	24M bps	36M bps	48M bps	54M bps
Peak Power (dBm)	20.05	18.99	19.97	19.28	19.82	19.42	20.04	20.00

SISO <Ant. 1>

2.4GHz 802.11n HT20								
Data Rate (MHz)	MCS0	MCS1	MCS2	MCS3	MCS4	MCS5	MCS6	MCS7
Peak Power (dBm)	19.46	19.36	19.43	19.44	19.31	19.22	19.40	19.45

2.4GHz 802.11n HT40								
Data Rate (MHz)	MCS0	MCS1	MCS2	MCS3	MCS4	MCS5	MCS6	MCS7
Peak Power (dBm)	19.54	19.42	19.29	19.49	19.43	19.50	19.41	19.45

<Ant. 2>

802.11b				
Data Rate (MHz)	1M bps	2M bps	5.5M bps	11M bps
Peak Power (dBm)	15.65	15.64	14.87	15.60

802.11g								
Data Rate (MHz)	6M bps	9M bps	12M bps	18M bps	24M bps	36M bps	48M bps	54M bps
Peak Power (dBm)	20.18	19.77	19.95	19.02	19.60	19.24	20.05	20.17

SISO <Ant. 2>

2.4GHz 802.11n HT20								
Data Rate (MHz)	MCS0	MCS1	MCS2	MCS3	MCS4	MCS5	MCS6	MCS7
Peak Power (dBm)	19.32	18.68	19.23	19.03	18.52	18.71	19.22	19.00

2.4GHz 802.11n HT40								
Data Rate (MHz)	MCS0	MCS1	MCS2	MCS3	MCS4	MCS5	MCS6	MCS7
Peak Power (dBm)	18.99	18.09	18.86	18.59	18.75	18.84	18.94	18.61

MIMO <Ant. 1+2>

2.4GHz 802.11n HT20								
Data Rate (MHz)	MCS0	MCS1	MCS2	MCS3	MCS4	MCS5	MCS6	MCS7
Peak Power (dBm)	22.94	22.48	22.55	22.52	22.46	22.21	22.83	22.45
Data Rate (MHz)	MCS8	MCS9	MCS10	MCS11	MCS12	MCS13	MCS14	MCS15
Peak Power (dBm)	22.31	22.30	22.18	22.46	22.76	22.62	22.70	22.76

2.4GHz 802.11n HT40								
Data Rate (MHz)	MCS0	MCS1	MCS2	MCS3	MCS4	MCS5	MCS6	MCS7
Peak Power (dBm)	22.25	22.17	22.20	22.23	22.23	22.22	22.12	21.69
Data Rate (MHz)	MCS8	MCS9	MCS10	MCS11	MCS12	MCS13	MCS14	MCS15
Peak Power (dBm)	21.36	21.39	21.18	21.73	22.12	21.72	21.73	21.99

Note: MIMO Ant. 1+2 is a calculated result from sum of the power MIMO Ant. 1 and MIMO Ant. 2.



2.3 Test Mode

Final results of test modes, data rates and test channels are shown as following table.

<2.4GHz>

Test Cases				
	Test Items	Mode	Data Rate	Test Channel
Conducted TCs	6dB BW Power Spectral Density	802.11b	1 Mbps	1/6/11
		802.11g	6 Mbps	1/6/11
		802.11n HT20	6.5 Mbps	1/6/11
		802.11n HT40	13.5 Mbps	3/6/9
	Output Power	802.11b	1 Mbps	1/6/11
		802.11g	6 Mbps	1/6/11
		802.11n HT20	6.5 Mbps	1/6/11
		802.11n HT40	13.5 Mbps	3/6/9
	Conducted Band Edge	802.11b	1 Mbps	1/11
		802.11g	6 Mbps	1/11
		802.11n HT20	6.5 Mbps	1/11
		802.11n HT40	13.5 Mbps	3/9
	Conducted Spurious Emission	802.11b	1 Mbps	1/6/11
		802.11g	6 Mbps	1/6/11
		802.11n HT20	6.5 Mbps	1/6/11
		802.11n HT40	13.5 Mbps	3/6/9
Radiated TCs	Radiated Band Edge	802.11b	1 Mbps	1/11
		802.11g	6 Mbps	1/11
		802.11n HT20	6.5 Mbps	1/11
		802.11n HT40	13.5 Mbps	3/9
	Radiated Spurious Emission	802.11b	1 Mbps	1/6/11
		802.11g	6 Mbps	1/6/11
		802.11n HT20	6.5 Mbps	1/6/11
		802.11n HT40	13.5 Mbps	3/6/9
AC Conducted Emission	Mode 1 : LTE Band 41 Idle + WLAN Link + RJ-45 Link + VOIP + Adapter			

2.4 Connection Diagram of Test System

<WLAN Tx Mode>

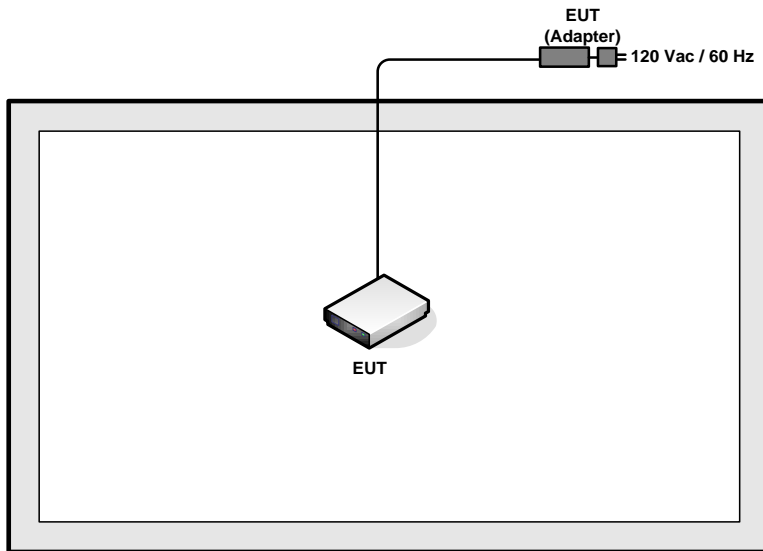

< AC Conducted Emission Mode >

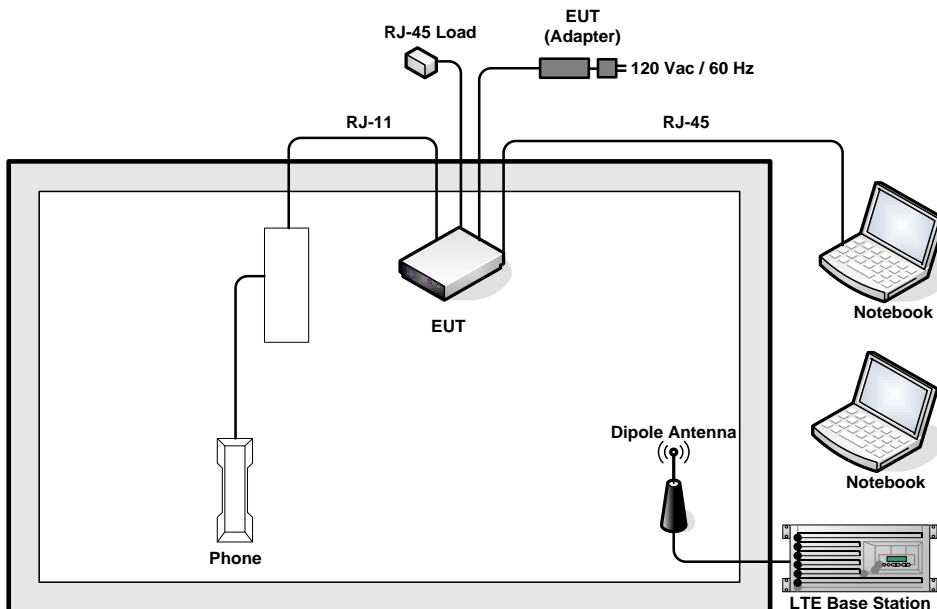

2.5 Support Unit used in test configuration and system

Item	Equipment	Trade Name	Model Name	FCC ID	Data Cable	Power Cord
1.	Telephone	SAMPO	HT-B907WL	N/A	N/A	Unshielded, 1.8 m
2.	Notebook	Lenovo	TP00034A	FCC DoC	Unshielded, 1m	AC I/P: Unshielded, 1.2 m DC O/P: Shielded, 1.8 m
3.	System Simulator	Anritsu	MT8820C	N/A	N/A	Unshielded, 1.8 m
4.	Notebook	DELL	Latitude E6320	FCC DoC	N/A	AC I/P: Unshielded, 1.2 m DC O/P: Shielded, 1.8 m

2.6 EUT Operation Test Setup

For WLAN function, programmed RF utility, “QA tool” installed in the notebook make the EUT provides functions like channel selection and power level for continuous transmitting and receiving signals.

2.7 Measurement Results Explanation Example

For all conducted test items:

The offset level is set in the spectrum analyzer to compensate the RF cable loss and attenuator factor between EUT conducted output port and spectrum analyzer. With the offset compensation, the spectrum analyzer reading level is exactly the EUT RF output level.

Example:

The spectrum analyzer offset is derived from RF cable loss and attenuator factor.

Offset = RF cable loss + attenuator factor.

Following shows an offset computation example with cable loss 4.2 dB and 10dB attenuator.

$$\begin{aligned}
 \text{Offset(dB)} &= \text{RF cable loss(dB)} + \text{attenuator factor(dB)}. \\
 &= 4.2 + 10 = 14.2 \text{ (dB)}
 \end{aligned}$$

3 Test Result

3.1 6dB Bandwidth Measurement

3.1.1 Limit of 6dB Bandwidth

The minimum 6 dB bandwidth shall be at least 500 kHz.

3.1.2 Measuring Instruments

The measuring equipment is listed in the section 4 of this test report.

3.1.3 Test Procedures

1. The testing follows FCC KDB Publication No. 558074 DTS D01 Meas. Guidance v03r01.
2. The RF output of EUT was connected to the spectrum analyzer by RF cable and attenuator. The path loss was compensated to the results for each measurement.
3. Set to the maximum power setting and enable the EUT transmit continuously.
4. Make the measurement with the spectrum analyzer's resolution bandwidth (RBW) = 100 kHz. Set the Video bandwidth (VBW) = 300 kHz. In order to make an accurate measurement. The 6 dB bandwidth must be greater than 500 kHz.
5. Measure and record the results in the test report.

3.1.4 Test Setup

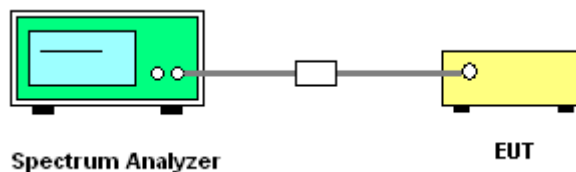



3.1.5 Test Result of 6dB Occupied Bandwidth

Test Band :	2.4GHz	Temperature :	21~25°C
Test Engineer :	Bill Kuo	Relative Humidity :	51~54%

Mod.	Data Rate	N _{TX}	Channel	Freq. (MHz)	6dB Bandwidth (MHz)		6dB Bandwidth Min. Limit (MHz)	Pass/Fail
					Ant. 1	Ant. 2		
11b	1Mbps	1	1	2412	-	10.16	0.5	Pass
11b	1Mbps	1	6	2437		11.04	0.5	Pass
11b	1Mbps	1	11	2462		11.08	0.5	Pass
11g	6Mbps	1	1	2412		16.52	0.5	Pass
11g	6Mbps	1	6	2437		16.48	0.5	Pass
11g	6Mbps	1	11	2462		16.44	0.5	Pass
HT20	MCS0	1	1	2412	17.56	-	0.5	Pass
HT20	MCS0	1	6	2437	17.56		0.5	Pass
HT20	MCS0	1	11	2462	17.56		0.5	Pass
HT40	MCS0	1	3	2422	36.40		0.5	Pass
HT40	MCS0	1	6	2437	36.40		0.5	Pass
HT40	MCS0	1	9	2452	36.32		0.5	Pass
HT20	MCS0	2	1	2412	17.52	17.60	0.5	Pass
HT20	MCS0	2	6	2437	17.56	17.32	0.5	Pass
HT20	MCS0	2	11	2462	17.56	17.32	0.5	Pass
HT40	MCS0	2	3	2422	36.40	36.32	0.5	Pass
HT40	MCS0	2	6	2437	36.32	36.32	0.5	Pass
HT40	MCS0	2	9	2452	36.32	36.32	0.5	Pass

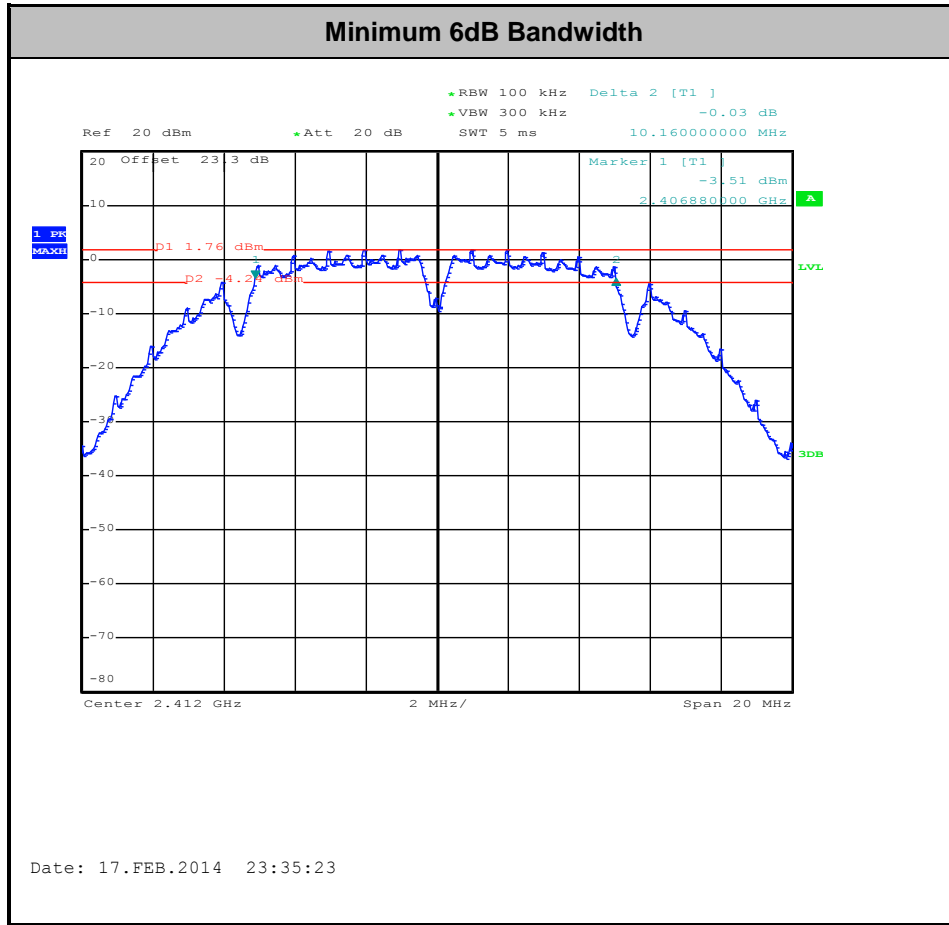

Note: The occupied channel bandwidth is maintained within the band of operation for all of the modulations.

3.2 Peak Output Power Measurement

3.2.1 Limit of Peak Output Power

For systems using digital modulation in the 2400-2483.5MHz, the limit for peak output power is 30dBm. If transmitting antenna with directional gain greater than 6dBi is used, the peak output power from the intentional radiator shall be reduced below the above stated value by the amount in dB that the directional gain of the antenna exceeds 6 dBi. In case of point-to-point operation, the limit has to be reduced by 1dB for every 3dB that the directional gain of the antenna exceeds 6dBi.

3.2.2 Measuring Instruments

The measuring equipment is listed in the section 4 of this test report.

3.2.3 Test Procedures

1. The testing follows the Measurement Procedure of FCC KDB No. 558074 DTS D01 Meas. Guidance v03r01.
2. The RF output of EUT was connected to the power meter by RF cable and attenuator. The path loss was compensated to the results for each measurement.
3. Set to the maximum power setting and enable the EUT transmit continuously.
4. Measure the conducted output power and record the results in the test report.
5. For MIMO mode, calculation method follows FCC KDB 662911 D01 Multiple Transmitter Output v02r01.

3.2.4 Test Setup

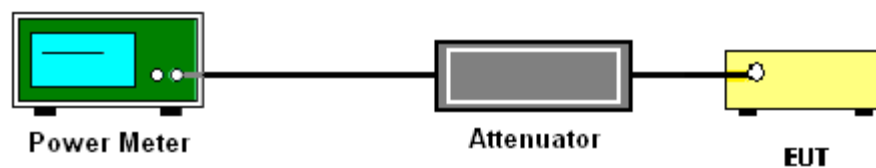



3.2.5 Test Result of Peak Output Power

Test Band :	2.4GHz	Temperature :	21~25°C
Test Engineer :	Bill Kuo	Relative Humidity :	51~54%

Mod.	Data Rate	N _{TX}	CH.	Freq. (MHz)	Peak Conducted Power (dBm)			Max. Limit (dBm)		DG (dBi)		Pass/Fail
					Ant. 1	Ant. 2	SUM	Ant. 1	Ant. 2	Ant. 1	Ant. 2	
11b	1Mbps	1	1	2412	15.55	15.16		30.00	30.00	1.03	2.61	Pass
11b	1Mbps	1	6	2437	15.62	15.04		30.00	30.00	1.03	2.61	Pass
11b	1Mbps	1	11	2462	15.35	15.65		30.00	30.00	1.03	2.61	Pass
11g	6Mbps	1	1	2412	19.76	20.15		30.00	30.00	1.03	2.61	Pass
11g	6Mbps	1	6	2437	20.05	20.08		30.00	30.00	1.03	2.61	Pass
11g	6Mbps	1	11	2462	19.97	20.18		30.00	30.00	1.03	2.61	Pass
HT20	MCS0	1	1	2412	18.97	17.97		30.00	30.00	1.03	2.61	Pass
HT20	MCS0	1	6	2437	19.46	19.32		30.00	30.00	1.03	2.61	Pass
HT20	MCS0	1	11	2462	19.26	18.39		30.00	30.00	1.03	2.61	Pass
HT40	MCS0	1	3	2422	19.27	17.91		30.00	30.00	1.03	2.61	Pass
HT40	MCS0	1	6	2437	19.54	18.99		30.00	30.00	1.03	2.61	Pass
HT40	MCS0	1	9	2452	19.45	16.89		30.00	30.00	1.03	2.61	Pass
HT20	MCS0	2	1	2412	19.76	18.62	22.24	30.00		4.87		Pass
HT20	MCS0	2	6	2437	20.56	19.01	22.86	30.00		4.87		Pass
HT20	MCS0	2	11	2462	20.60	19.14	22.94	30.00		4.87		Pass
HT40	MCS0	2	3	2422	19.32	17.85	21.66	30.00		4.87		Pass
HT40	MCS0	2	6	2437	20.02	18.30	22.25	30.00		4.87		Pass
HT40	MCS0	2	9	2452	18.81	16.82	20.94	30.00		4.87		Pass

Note: Measured power (dBm) has offset with cable loss.



3.2.6 Test Result of Average output Power (Reporting Only)

Test Band :	2.4GHz	Temperature :	21~25°C
Test Engineer :	Bill Kuo	Relative Humidity :	51~54%

Mod.	Data Rate	N _{TX}	Channel	Freq. (MHz)	Duty Factor (dB)		Average Conducted Power (dBm)		
					Ant. 1	Ant. 2	Ant. 1	Ant. 2	Sum Power
11b	1Mbps	1	1	2412	0.00	0.00	13.04	12.74	
11b	1Mbps	1	6	2437	0.00	0.00	13.05	12.63	
11b	1Mbps	1	11	2462	0.00	0.00	12.79	13.22	
11g	6Mbps	1	1	2412	0.00	0.00	11.04	10.72	
11g	6Mbps	1	6	2437	0.00	0.00	11.29	10.62	
11g	6Mbps	1	11	2462	0.00	0.00	11.13	10.78	
HT20	MCS0	1	1	2412	0.00	0.00	10.81	9.06	
HT20	MCS0	1	6	2437	0.00	0.00	11.10	9.50	
HT20	MCS0	1	11	2462	0.00	0.00	11.01	9.43	
HT40	MCS0	1	3	2422	0.00	0.00	10.60	8.69	
HT40	MCS0	1	6	2437	0.00	0.00	11.17	9.39	
HT40	MCS0	1	9	2452	0.00	0.00	10.21	7.21	
HT20	MCS0	2	1	2412	0.00	0.00	11.67	9.98	
HT20	MCS0	2	6	2437	0.00	0.00	12.01	9.52	13.95
HT20	MCS0	2	11	2462	0.00	0.00	12.10	9.54	14.02
HT40	MCS0	2	3	2422	0.00	0.00	10.84	8.71	12.91
HT40	MCS0	2	6	2437	0.00	0.00	11.81	9.40	13.78
HT40	MCS0	2	9	2452	0.00	0.00	10.22	7.26	12.00

Note: Measured power (dBm) has offset with cable loss and duty factor.

3.3 Power Spectral Density Measurement

3.3.1 Limit of Power Spectral Density

The peak power spectral density shall not be greater than 8dBm in any 3kHz band at any time interval of continuous transmission.

3.3.2 Measuring Instruments

The measuring equipment is listed in the section 4 of this test report.

3.3.3 Test Procedures

1. The testing follows Measurement Procedure 10.2 Method PKPSD of FCC KDB Publication No. 558074 D01 DTS Meas. Guidance v03r01
2. The RF output of EUT was connected to the spectrum analyzer by RF cable and attenuator. The path loss was compensated to the results for each measurement.
3. Set to the maximum power setting and enable the EUT transmit continuously.
4. Make the measurement with the spectrum analyzer's resolution bandwidth (RBW) = 3 kHz. Video bandwidth VBW = 10 kHz In order to make an accurate measurement, set the span to 1.5 times DTS Channel Bandwidth. (6dB BW)
5. Detector = peak, Sweep time = auto couple, Trace mode = max hold, Allow trace to fully stabilize. Use the peak marker function to determine the maximum power level.
6. Measure and record the results in the test report.
7. For MIMO mode, calculation method follows FCC KDB 662911 D01 Multiple Transmitter Output v02r01.

If measurements performed using method (2) plus $10 \log(N)$ exceeds the emission limit, the test should choose method (1) before declaring that the device fails the emission limit.

Method (1): Measure and sum the spectra across the outputs.

The total final Power Spectral Density is from a device with 2 transmitter outputs. The spectrum measurements of the individual outputs are all performed with the same span and number of points, the spectrum value in the first spectral bin of output 1 is summed with that in the first spectral bin of output 2 to obtain the value for the first frequency bin of the summed spectrum.

Method (2): Measure and add $10 \log(N)$ dB, where N is the number of outputs. (N=2)

3.3.4 Test Setup

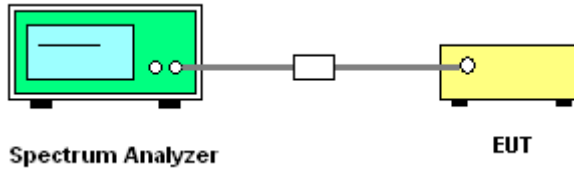

3.3.5 Test Result of Power Spectral Density

Test Band :	2.4GHz	Temperature :	21~25°C
Test Engineer :	Bill Kuo	Relative Humidity :	51~54%

Mod.	Data Rate	N _{TX}	CH.	Freq. (MHz)	Peak Power Density (dBm/3kHz)			Max. Limit (dBm/3kHz)		DG (dBi)		Pass/Fail
					Ant. 1	Ant. 2	Worst +10log(2)	Ant. 1	Ant. 2	Ant. 1	Ant. 2	
11b	1Mbps	1	1	2412		-16.55		8.00	8.00	1.03	2.61	Pass
11b	1Mbps	1	6	2437		-16.68		8.00	8.00	1.03	2.61	Pass
11b	1Mbps	1	11	2462		-16.35		8.00	8.00	1.03	2.61	Pass
11g	6Mbps	1	1	2412		-17.45		8.00	8.00	1.03	2.61	Pass
11g	6Mbps	1	6	2437		-15.04		8.00	8.00	1.03	2.61	Pass
11g	6Mbps	1	11	2462		-17.55		8.00	8.00	1.03	2.61	Pass
HT20	MCS0	1	1	2412	-12.41			8.00	8.00	1.03	2.61	Pass
HT20	MCS0	1	6	2437	-11.12			8.00	8.00	1.03	2.61	Pass
HT20	MCS0	1	11	2462	-11.83			8.00	8.00	1.03	2.61	Pass
HT40	MCS0	1	3	2422	-13.29			8.00	8.00	1.03	2.61	Pass
HT40	MCS0	1	6	2437	-14.01			8.00	8.00	1.03	2.61	Pass
HT40	MCS0	1	9	2452	-14.09			8.00	8.00	1.03	2.61	Pass
HT20	MCS0	2	1	2412	-10.28	-17.11	-7.27	8.00	8.00	4.87	4.87	Pass
HT20	MCS0	2	6	2437	-11.47	-17.60	-8.46	8.00	8.00	4.87	4.87	Pass
HT20	MCS0	2	11	2462	-10.64	-18.66	-7.63	8.00	8.00	4.87	4.87	Pass
HT40	MCS0	2	3	2422	-11.15	-20.13	-8.14	8.00	8.00	4.87	4.87	Pass
HT40	MCS0	2	6	2437	-12.13	-20.43	-9.12	8.00	8.00	4.87	4.87	Pass
HT40	MCS0	2	9	2452	-11.92	-19.74	-8.91	8.00	8.00	4.87	4.87	Pass

Note: Measured power density (dBm) has offset with cable loss.

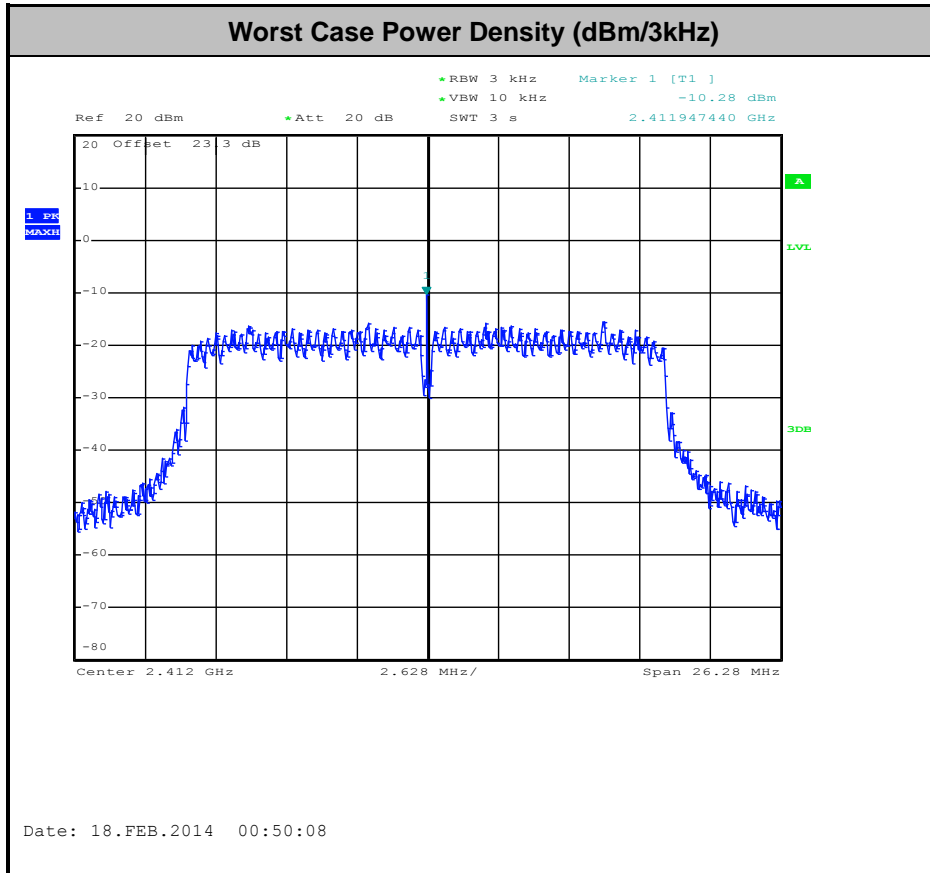

3.4 Conducted Band Edges and Spurious Emission Measurement

3.4.1 Limit of Conducted Band Edges and Spurious Emission Measurement

In any 100 kHz bandwidth outside of the authorized frequency band, the emissions which fall in the non-restricted bands shall be attenuated at least 20 dB / 30dB relative to the maximum PSD level in 100 kHz by RF conducted measurement and radiated emissions which fall in the restricted bands, as defined in Section 15.205(a), must also comply with the radiated emission limits specified in Section 15.209(a).

3.4.2 Measuring Instruments

The measuring equipment is listed in the section 4 of this test report.

3.4.3 Test Procedures

1. The testing follows FCC KDB Publication No. 558074 D01 DTS Meas. Guidance v03r01.
2. The RF output of EUT was connected to the spectrum analyzer by RF cable and attenuator. The path loss was compensated to the results for each measurement.
3. Set to the maximum power setting and enable the EUT transmit continuously.
4. Set RBW = 100 kHz, VBW=300 kHz, Peak Detector. Unwanted Emissions measured in any 100 kHz bandwidth outside of the authorized frequency band shall be attenuated by at least 20 dB relative to the maximum in-band peak PSD level in 100 kHz when maximum peak conducted output power procedure is used. If the transmitter complies with the conducted power limits based on the use of RMS averaging over a time interval, the attenuation required under this paragraph shall be 30 dB instead of 20 dB per 15.247(d).
5. Measure and record the results in the test report.
6. The RF fundamental frequency should be excluded against the limit line in the operating frequency band.

3.4.4 Test Setup





3.4.5 Test Result of Conducted Band Edges and Spurious Emission

Number of TX = 1, Ant. 1 (Measured)

Number of TX :	1	Ant. :	1
Test Mode :	802.11n HT20	Temperature :	21~25°C
Test Band :	2.4GHz Low	Relative Humidity :	51~54%
Test Channel :	01	Test Engineer :	Bill Kuo

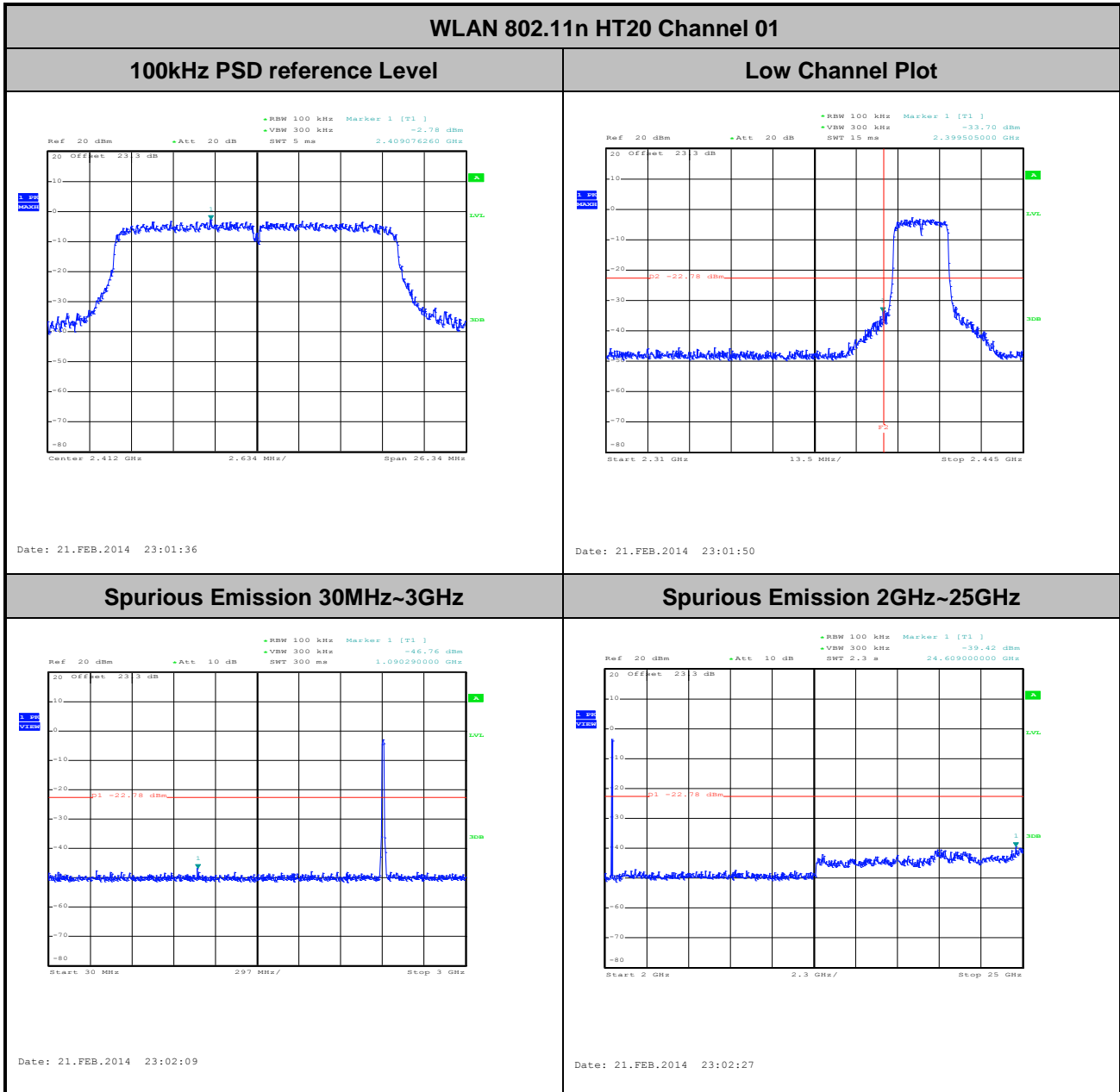



Number of TX :	1	Ant. :	1
Test Mode :	802.11n HT20	Temperature :	21~25°C
Test Band :	2.4GHz Mid	Relative Humidity :	51~54%
Test Channel :	06	Test Engineer :	Bill Kuo

WLAN 802.11n HT20 Channel 06

100kHz PSD reference Level

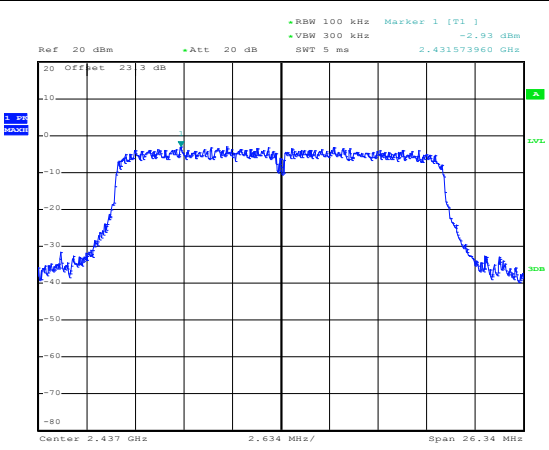

Date: 21.FEB.2014 23:04:33

Spurious Emission 30MHz~3GHz

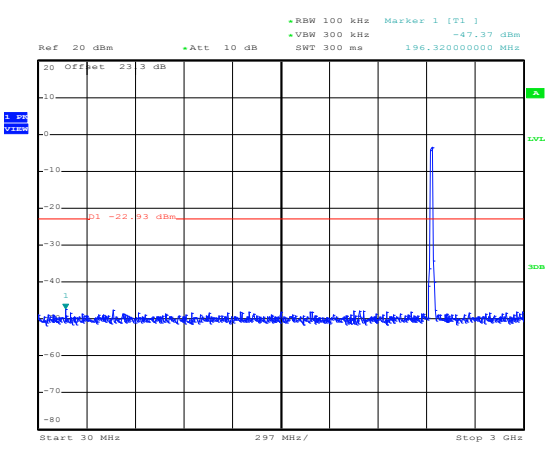

Date: 21.FEB.2014 23:04:53

Spurious Emission 2GHz~25GHz

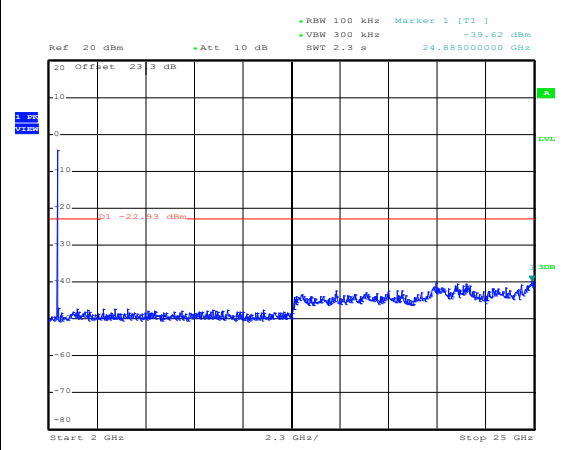

Date: 21.FEB.2014 23:05:11



Number of TX :	1	Ant. :	1
Test Mode :	802.11n HT20	Temperature :	21~25°C
Test Band :	2.4GHz High	Relative Humidity :	51~54%
Test Channel :	11	Test Engineer :	Bill Kuo

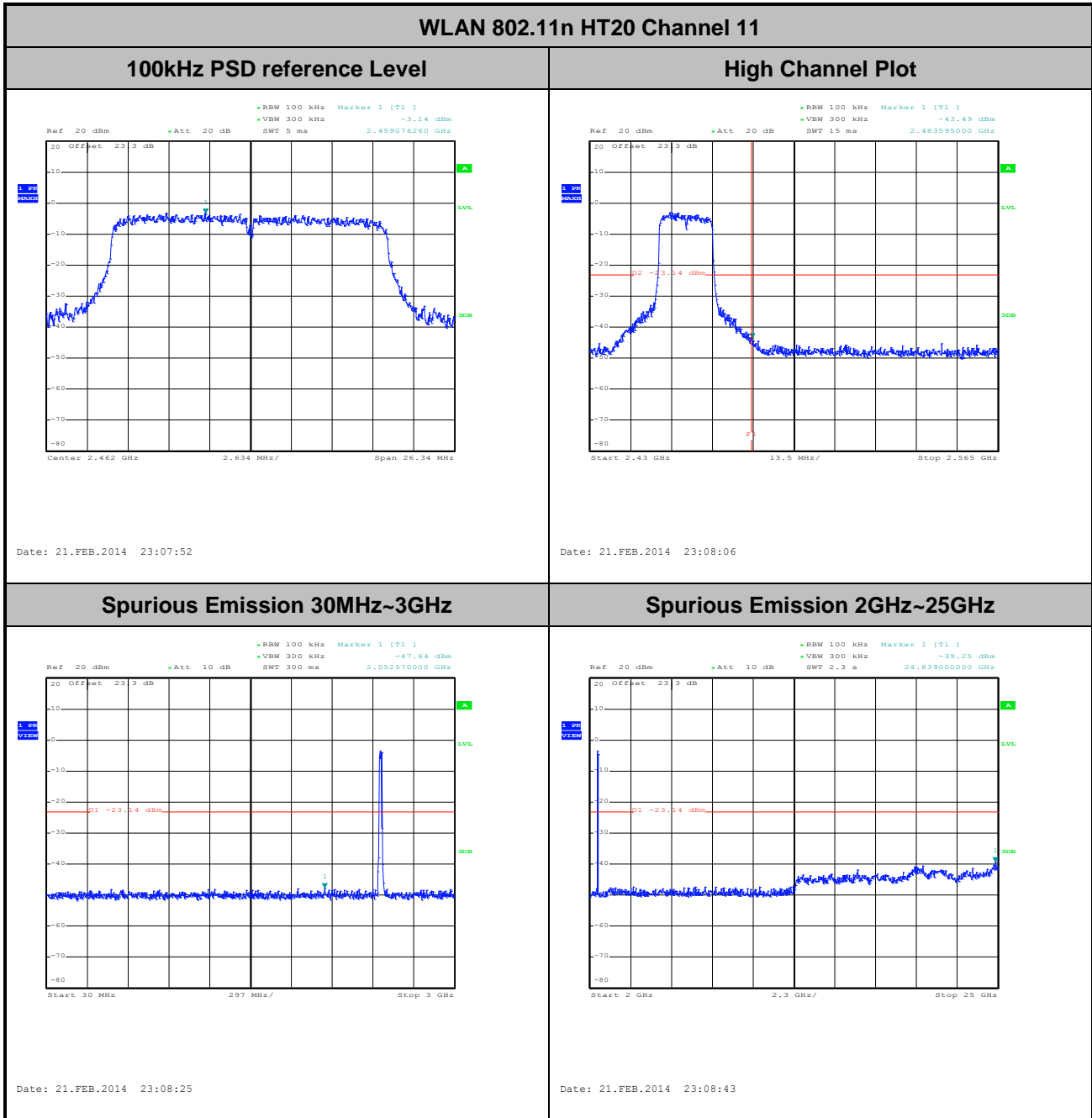



Number of TX :	1	Ant. :	1
Test Mode :	802.11n HT40	Temperature :	21~25°C
Test Band :	2.4GHz Low	Relative Humidity :	51~54%
Test Channel :	03	Test Engineer :	Bill Kuo

WLAN 802.11n HT40 Channel 03

100kHz PSD reference Level

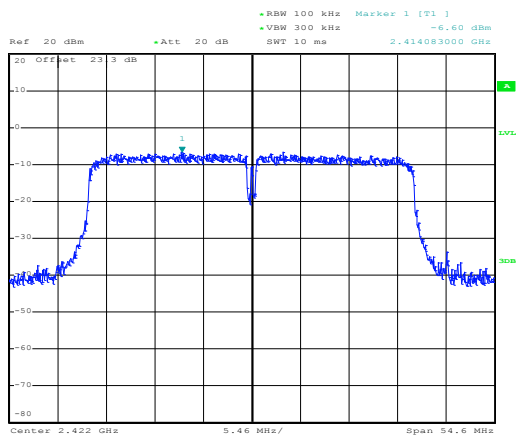

Date: 21.FEB.2014 23:18:18

Low Channel Plot

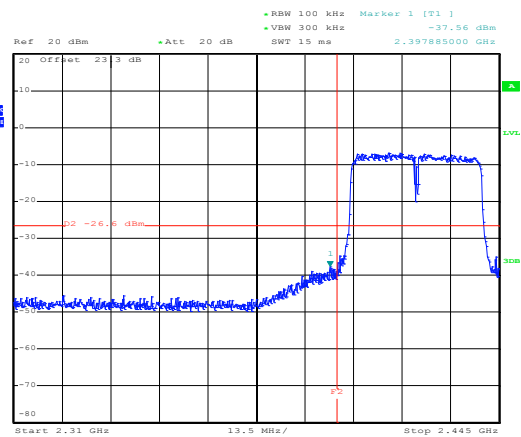

Date: 21.FEB.2014 23:22:05

Spurious Emission 30MHz~3GHz

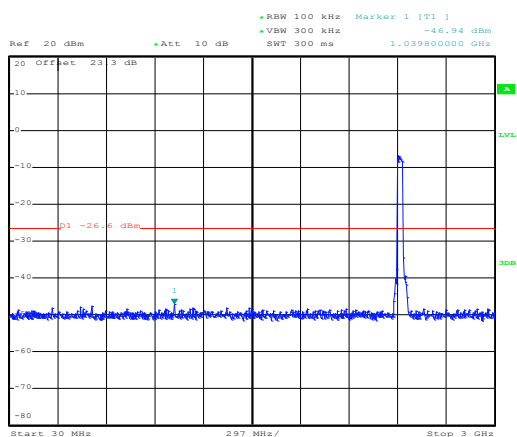

Date: 21.FEB.2014 23:18:51

Spurious Emission 2GHz~25GHz

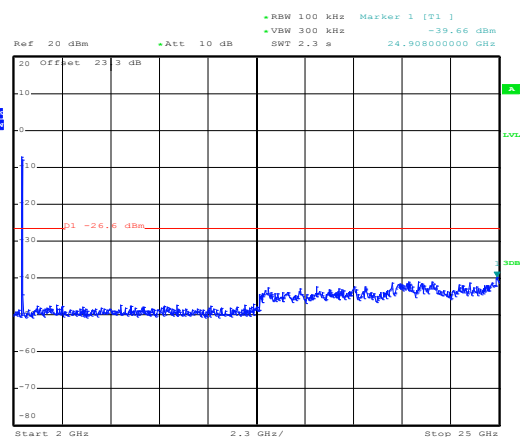

Date: 21.FEB.2014 23:19:10



Number of TX :	1	Ant. :	1
Test Mode :	802.11n HT40	Temperature :	21~25°C
Test Band :	2.4GHz Mid	Relative Humidity :	51~54%
Test Channel :	06	Test Engineer :	Bill Kuo

WLAN 802.11n HT40 Channel 06

100kHz PSD reference Level

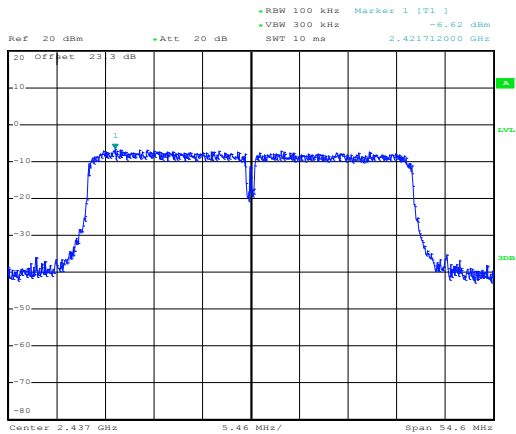

Date: 21.FEB.2014 23:14:50

Spurious Emission 30MHz~3GHz

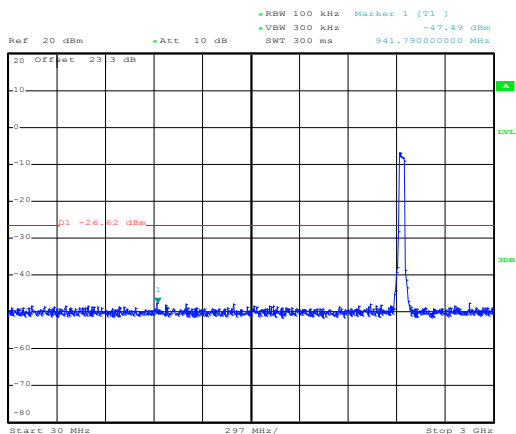

Date: 21.FEB.2014 23:15:10

Spurious Emission 2GHz~25GHz

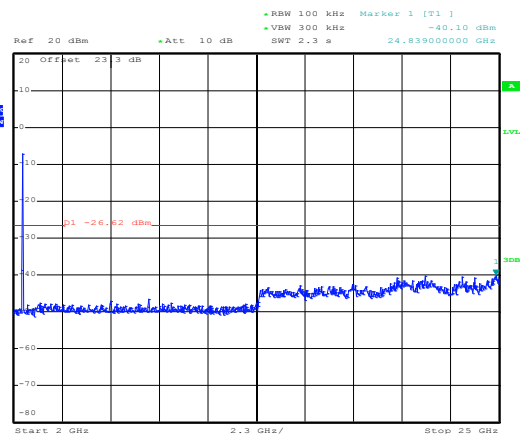

Date: 21.FEB.2014 23:15:28



Number of TX :	1	Ant. :	1
Test Mode :	802.11n HT40	Temperature :	21~25°C
Test Band :	2.4GHz High	Relative Humidity :	51~54%
Test Channel :	09	Test Engineer :	Bill Kuo

WLAN 802.11n HT40 Channel 09

100kHz PSD reference Level

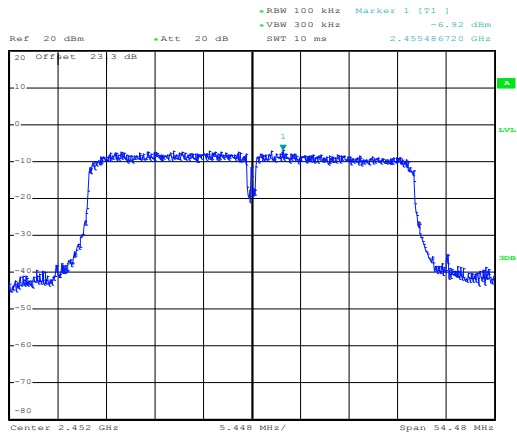

Date: 21.FEB.2014 23:23:47

High Channel Plot

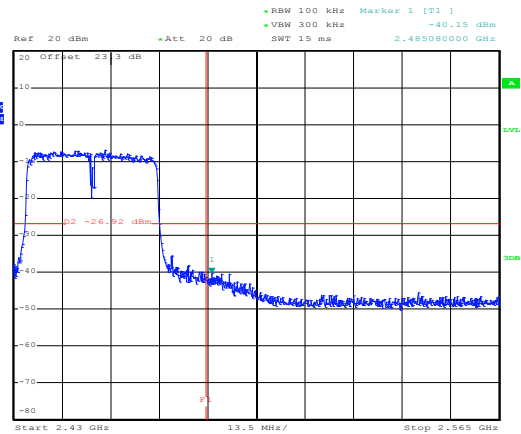

Date: 21.FEB.2014 23:24:01

Spurious Emission 30MHz~3GHz

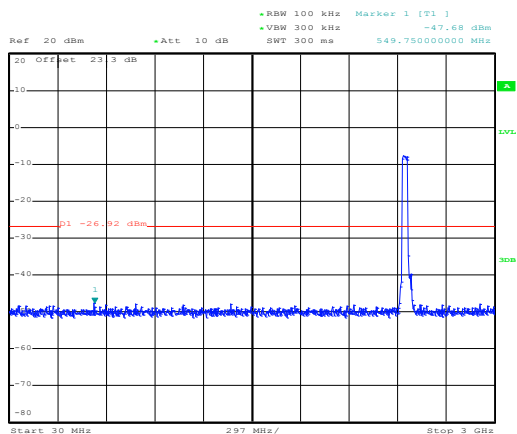

Date: 21.FEB.2014 23:24:20

Spurious Emission 2GHz~25GHz

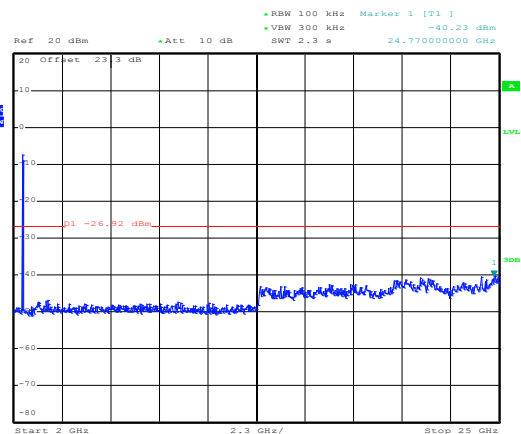

Date: 21.FEB.2014 23:24:39



Number of TX = 1, Ant. 2 (Measured)

Number of TX :	1	Ant. :	2
Test Mode :	802.11b	Temperature :	21~25°C
Test Band :	2.4GHz Low	Relative Humidity :	51~54%
Test Channel :	01	Test Engineer :	Bill Kuo

WLAN 802.11b Channel 01

100kHz PSD reference Level

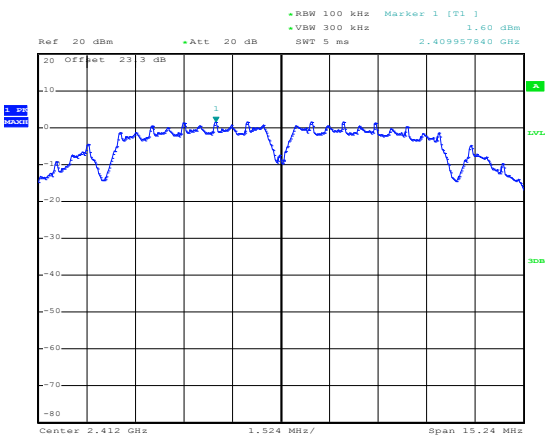

Date: 17.FEB.2014 23:35:52

Low Channel Plot

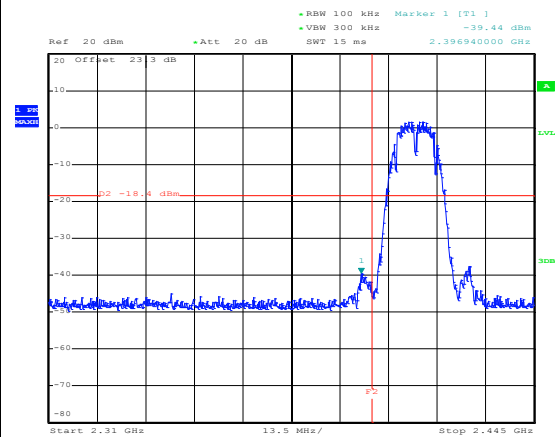

Date: 17.FEB.2014 23:36:06

Spurious Emission 30MHz~3GHz

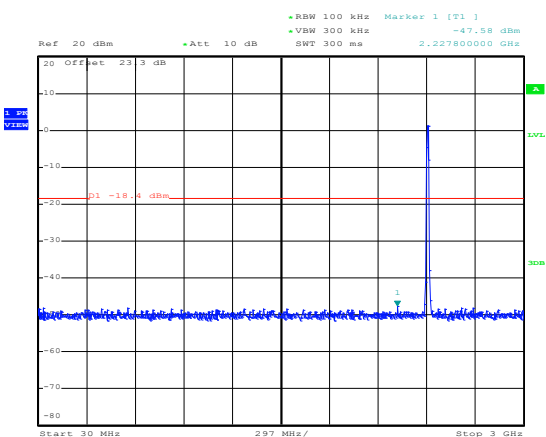

Date: 17.FEB.2014 23:36:25

Spurious Emission 2GHz~25GHz

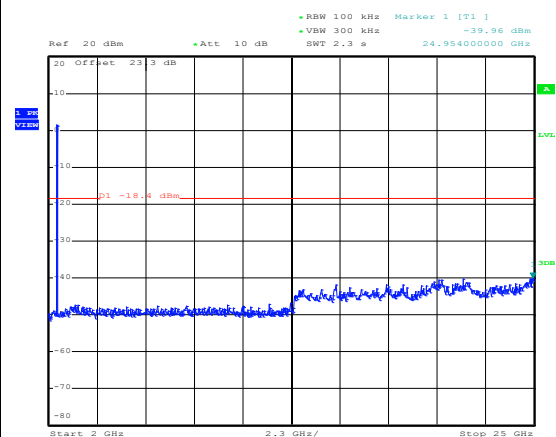

Date: 17.FEB.2014 23:36:43



Number of TX :	1	Ant. :	2
Test Mode :	802.11b	Temperature :	21~25°C
Test Band :	2.4GHz Mid	Relative Humidity :	51~54%
Test Channel :	06	Test Engineer :	Bill Kuo

WLAN 802.11b Channel 06

100kHz PSD reference Level

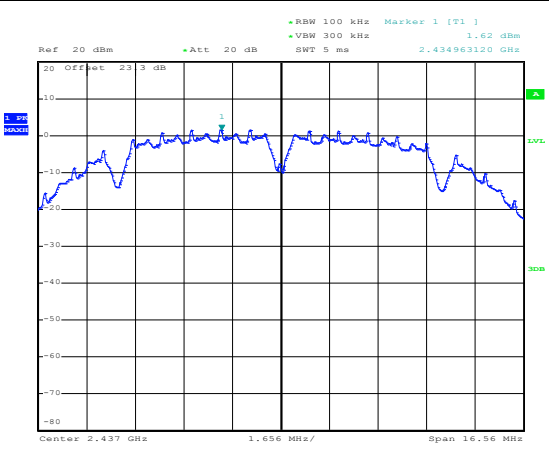

Date: 17.FEB.2014 23:39:27

Spurious Emission 30MHz~3GHz

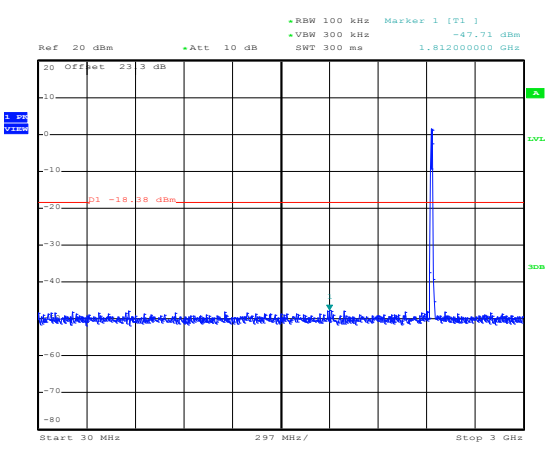

Date: 17.FEB.2014 23:39:46

Spurious Emission 2GHz~25GHz

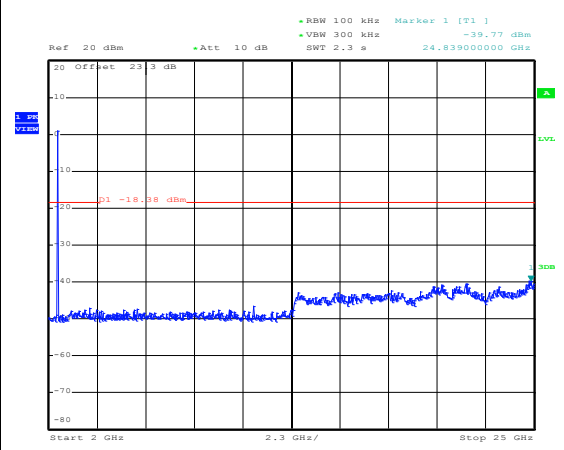

Date: 17.FEB.2014 23:40:05



Number of TX :	1	Ant. :	2
Test Mode :	802.11b	Temperature :	21~25°C
Test Band :	2.4GHz High	Relative Humidity :	51~54%
Test Channel :	11	Test Engineer :	Bill Kuo

WLAN 802.11b Channel 11

100kHz PSD reference Level

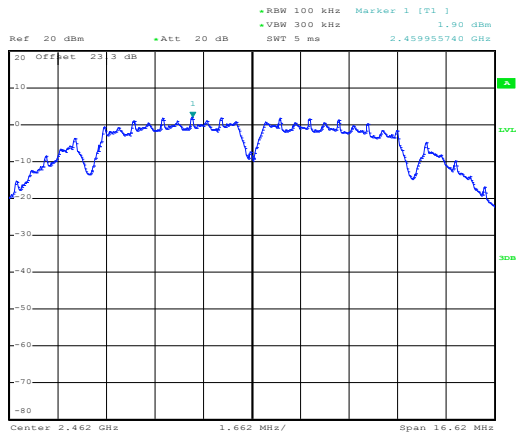

Date: 17.FEB.2014 23:41:48

High Channel Plot

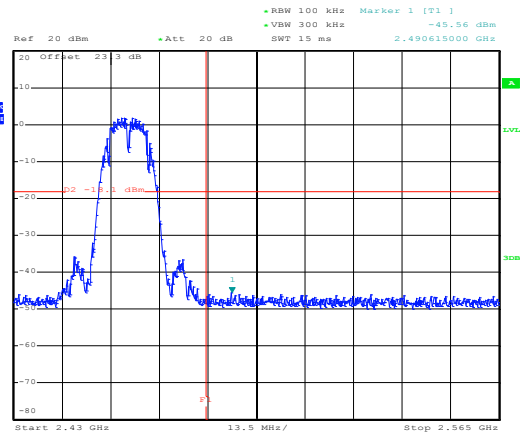

Date: 17.FEB.2014 23:42:01

Spurious Emission 30MHz~3GHz

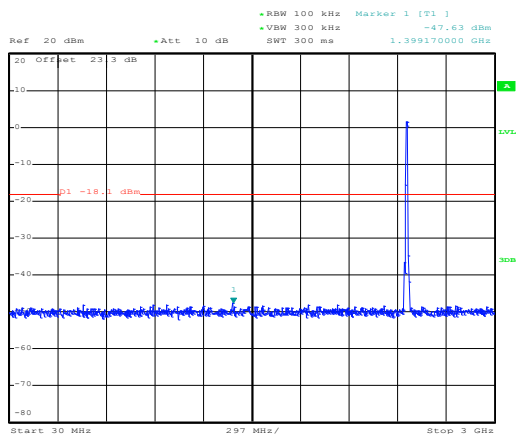

Date: 17.FEB.2014 23:42:21

Spurious Emission 2GHz~25GHz

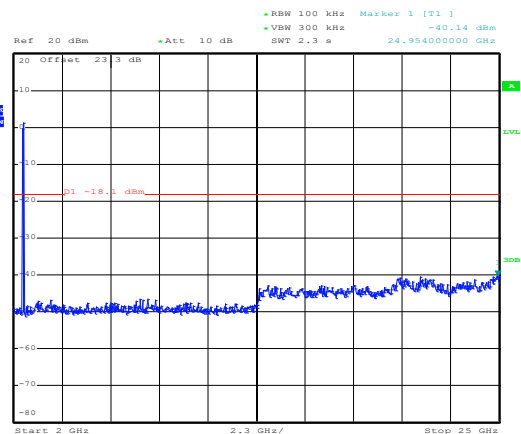

Date: 17.FEB.2014 23:42:39



Number of TX :	1	Ant. :	2
Test Mode :	802.11g	Temperature :	21~25°C
Test Band :	2.4GHz Low	Relative Humidity :	51~54%
Test Channel :	01	Test Engineer :	Bill Kuo

WLAN 802.11g Channel 01

100kHz PSD reference Level

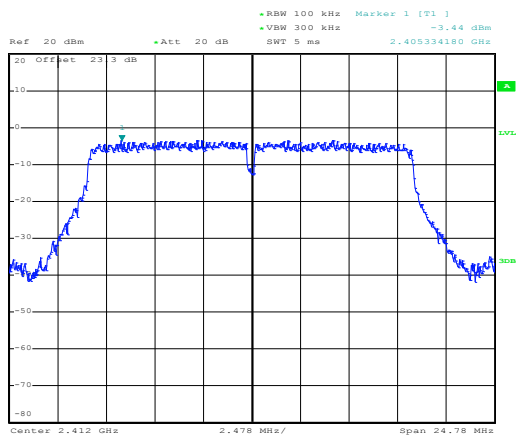

Date: 17.FEB.2014 23:55:15

Low Channel Plot

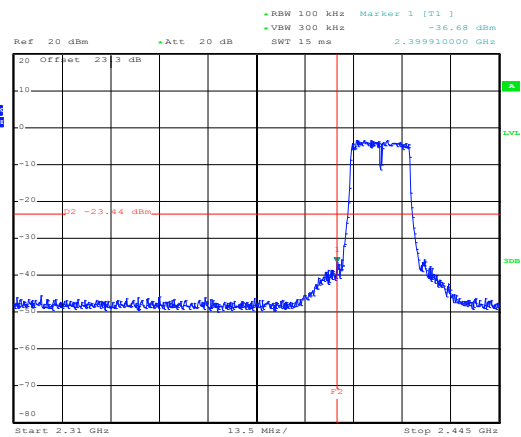

Date: 17.FEB.2014 23:55:29

Spurious Emission 30MHz~3GHz

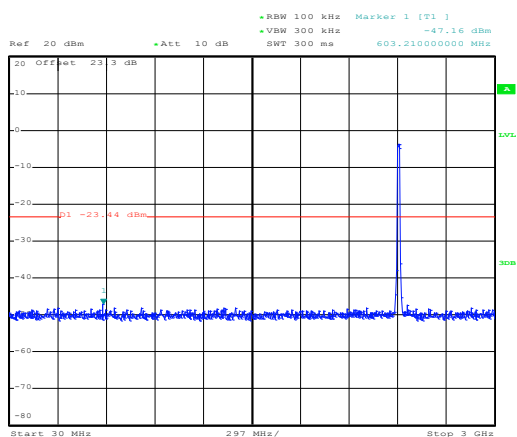

Date: 17.FEB.2014 23:55:48

Spurious Emission 2GHz~25GHz

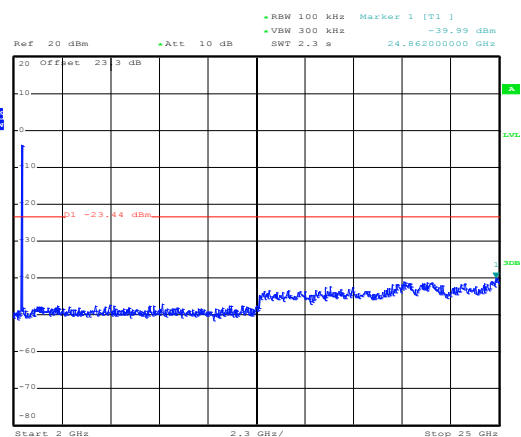

Date: 17.FEB.2014 23:56:07



Number of TX :	1	Ant. :	2
Test Mode :	802.11g	Temperature :	21~25°C
Test Band :	2.4GHz Mid	Relative Humidity :	51~54%
Test Channel :	06	Test Engineer :	Bill Kuo

WLAN 802.11g Channel 06

100kHz PSD reference Level

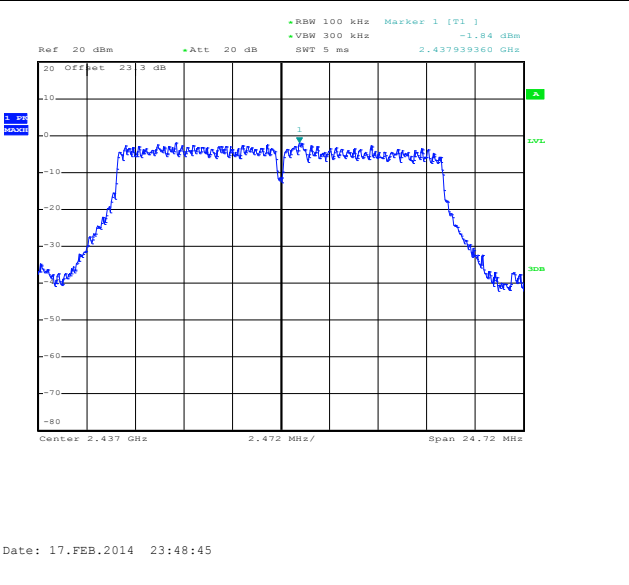

Spurious Emission 30MHz~3GHz

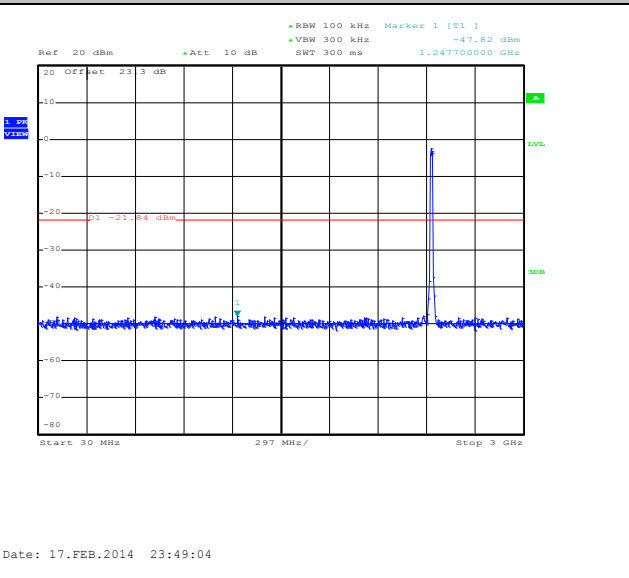

Spurious Emission 2GHz~25GHz

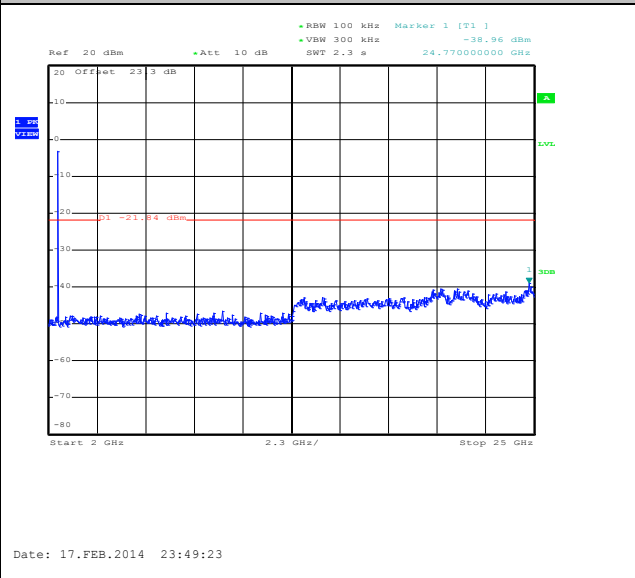



Number of TX :	1	Ant. :	2
Test Mode :	802.11g	Temperature :	21~25°C
Test Band :	2.4GHz High	Relative Humidity :	51~54%
Test Channel :	11	Test Engineer :	Bill Kuo

WLAN 802.11g Channel 11

100kHz PSD reference Level

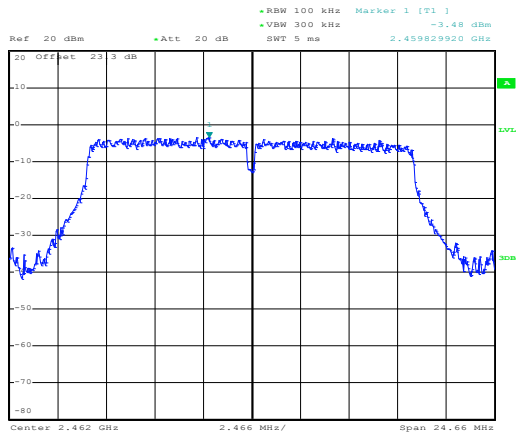

Date: 17.FEB.2014 23:45:45

High Channel Plot

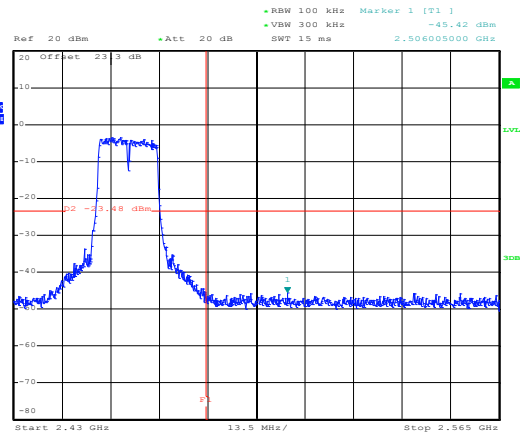

Date: 17.FEB.2014 23:45:58

Spurious Emission 30MHz~3GHz

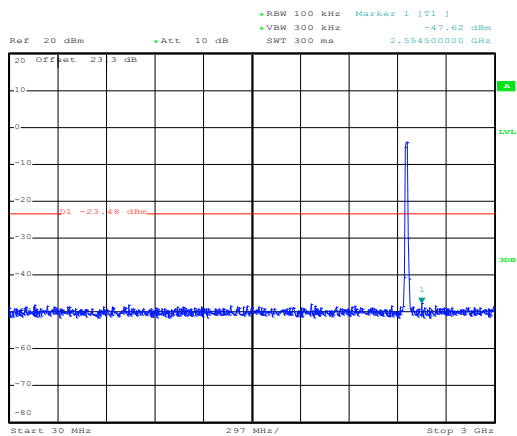

Date: 17.FEB.2014 23:46:17

Spurious Emission 2GHz~25GHz

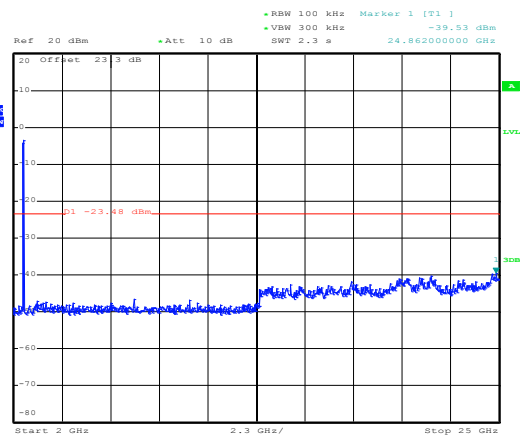

Date: 17.FEB.2014 23:46:36



Number of TX = 2, Ant. 1 (Measured)

Number of TX :	2	Ant. :	1
Test Mode :	802.11n HT20	Temperature :	21~25°C
Test Band :	2.4GHz Low	Relative Humidity :	51~54%
Test Channel :	01	Test Engineer :	Bill Kuo

WLAN 802.11n HT20 Channel 01

100kHz PSD reference Level

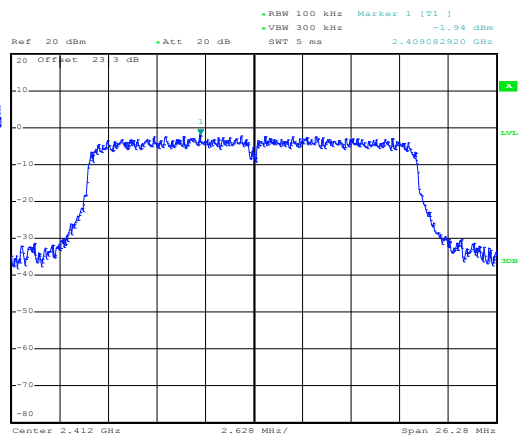

Date: 18.FEB.2014 00:50:17

Low Channel Plot

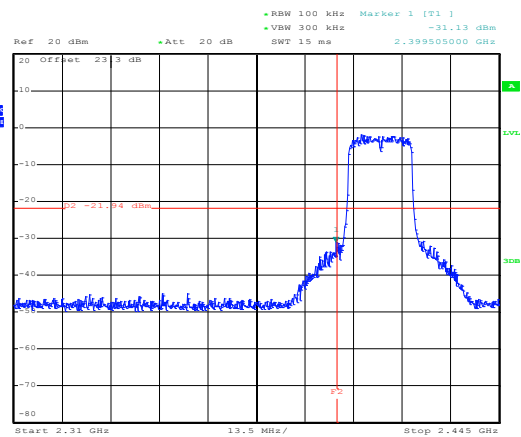

Date: 18.FEB.2014 00:50:30

Spurious Emission 30MHz~3GHz

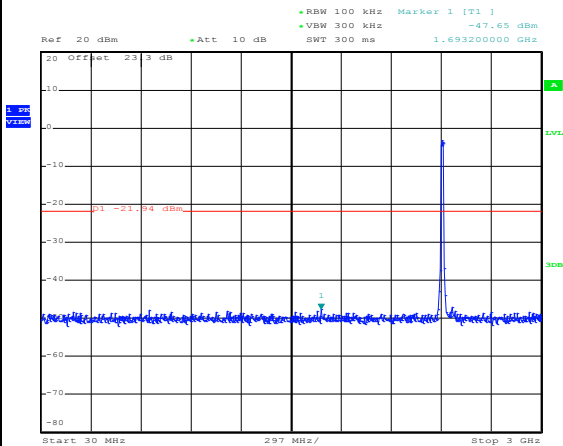

Date: 18.FEB.2014 02:10:26

Spurious Emission 2GHz~25GHz

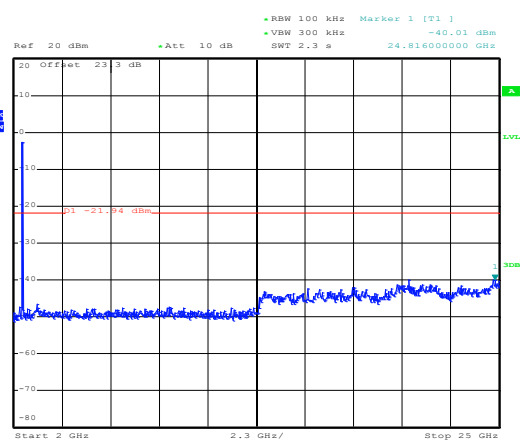

Date: 18.FEB.2014 02:10:46



Number of TX :	2	Ant. :	1
Test Mode :	802.11n HT20	Temperature :	21~25°C
Test Band :	2.4GHz Mid	Relative Humidity :	51~54%
Test Channel :	06	Test Engineer :	Bill Kuo

WLAN 802.11n HT20 Channel 06

100kHz PSD reference Level

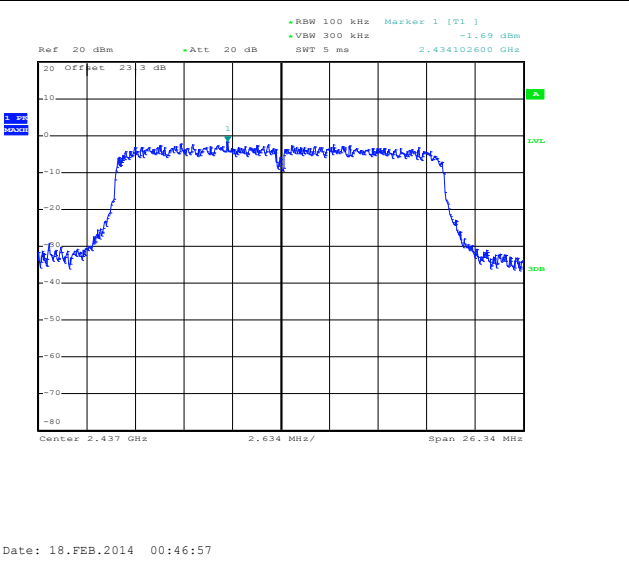

Spurious Emission 30MHz~3GHz

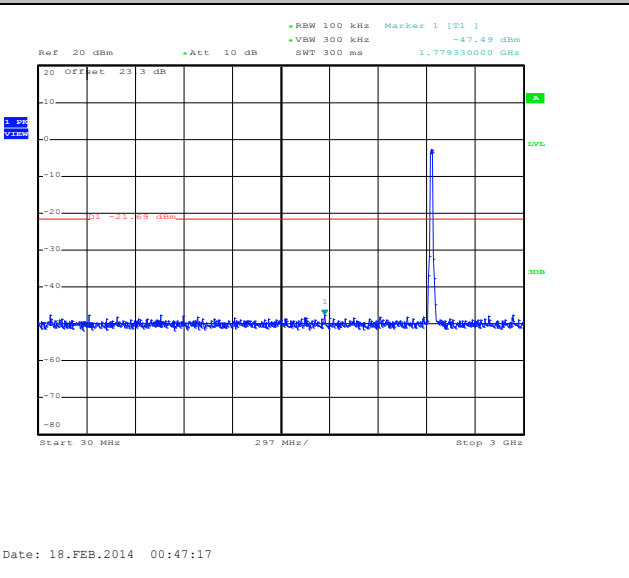

Spurious Emission 2GHz~25GHz

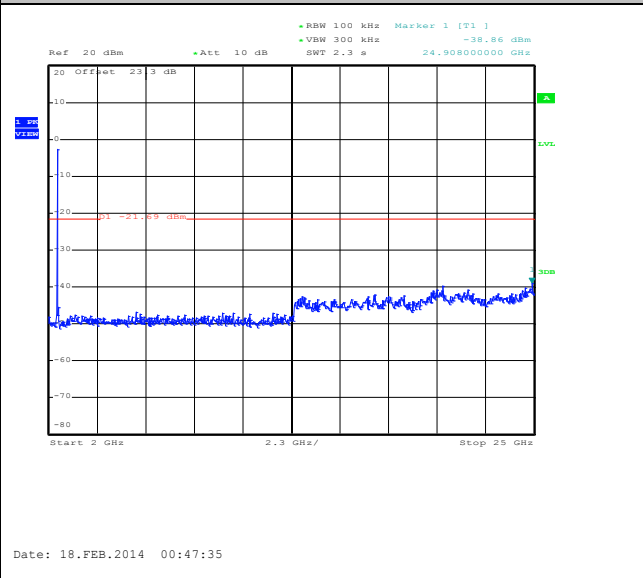



Number of TX :	2	Ant. :	1
Test Mode :	802.11n HT20	Temperature :	21~25°C
Test Band :	2.4GHz High	Relative Humidity :	51~54%
Test Channel :	11	Test Engineer :	Bill Kuo

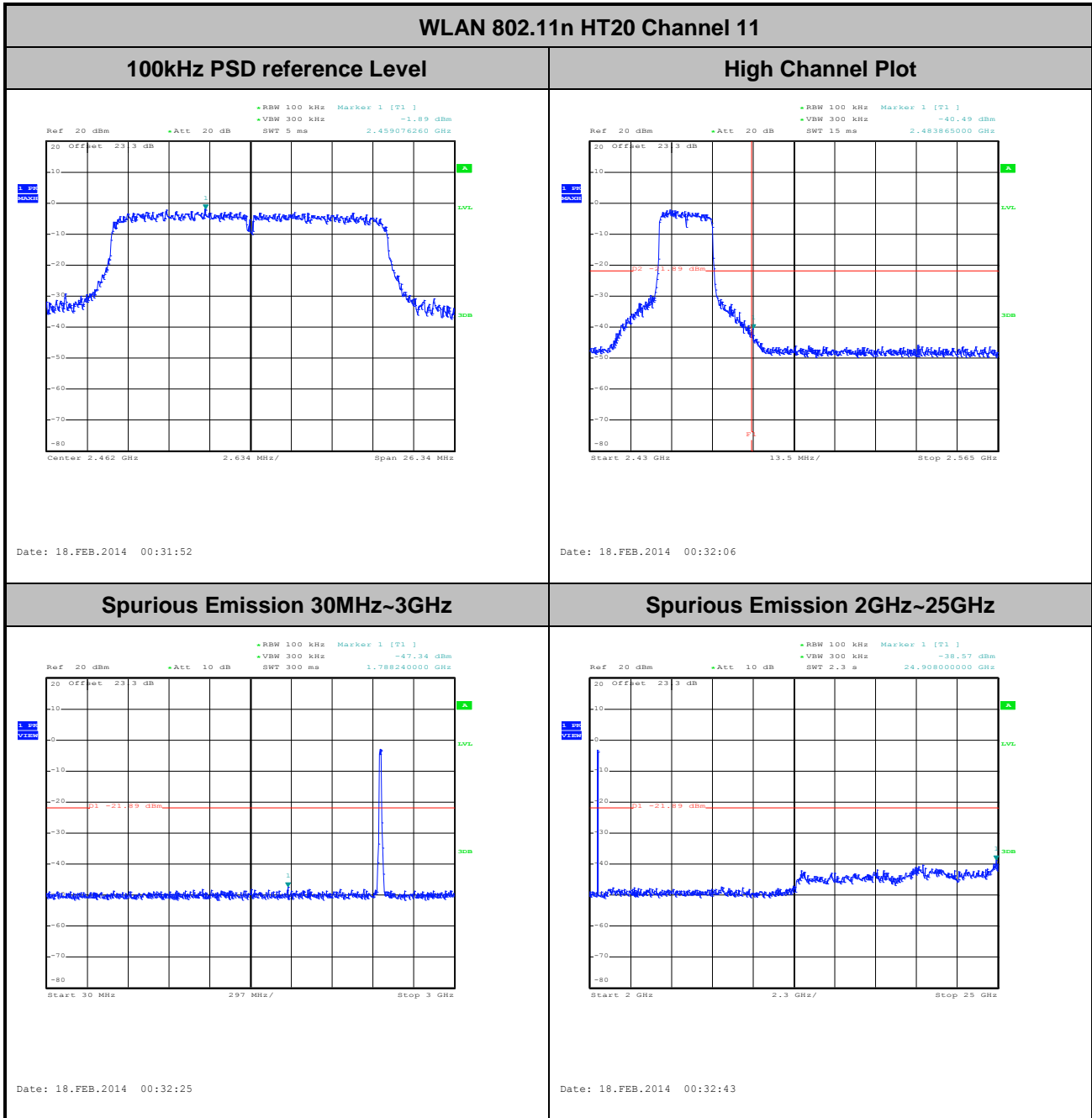



Number of TX :	2	Ant. :	1
Test Mode :	802.11n HT40	Temperature :	21~25°C
Test Band :	2.4GHz Low	Relative Humidity :	51~54%
Test Channel :	03	Test Engineer :	Bill Kuo

WLAN 802.11n HT40 Channel 03

100kHz PSD reference Level

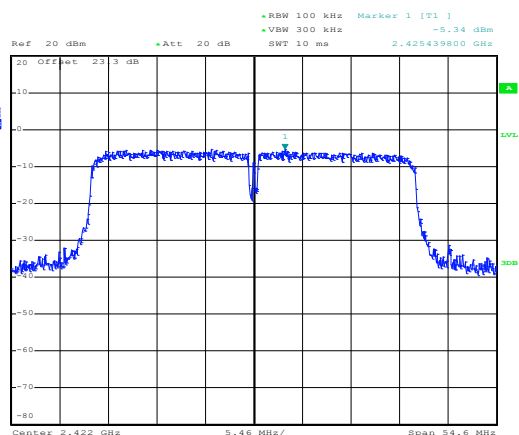

Date: 18.FEB.2014 01:47:28

Low Channel Plot

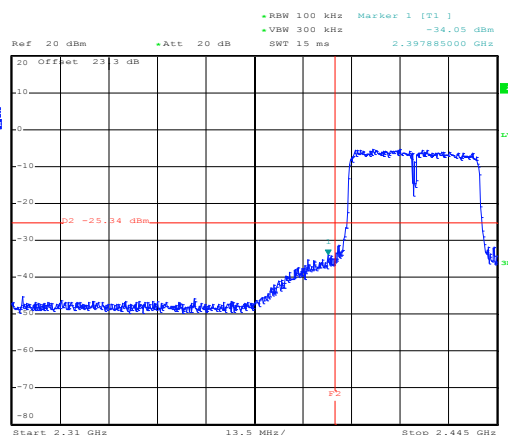

Date: 18.FEB.2014 01:47:41

Spurious Emission 30MHz~3GHz

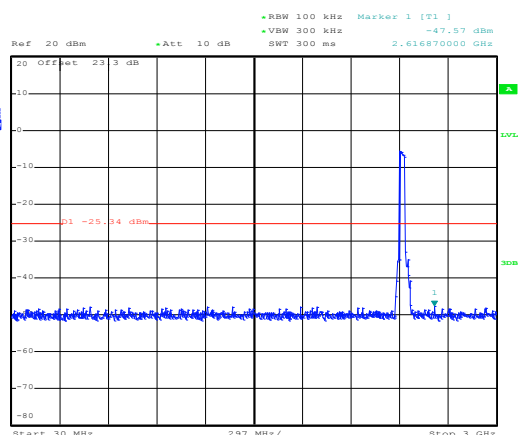

Date: 18.FEB.2014 01:48:00

Spurious Emission 2GHz~25GHz

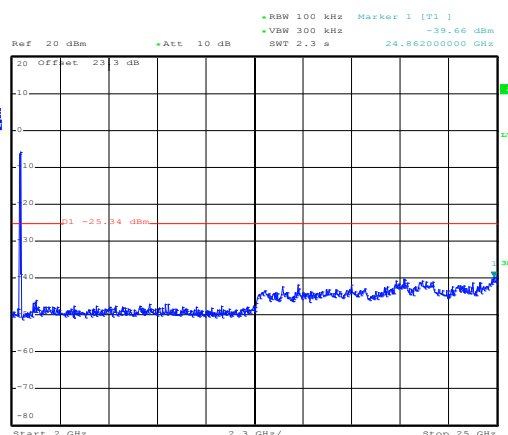

Date: 18.FEB.2014 01:48:19



Number of TX :	2	Ant. :	1
Test Mode :	802.11n HT40	Temperature :	21~25°C
Test Band :	2.4GHz Mid	Relative Humidity :	51~54%
Test Channel :	06	Test Engineer :	Bill Kuo

WLAN 802.11n HT40 Channel 06

100kHz PSD reference Level

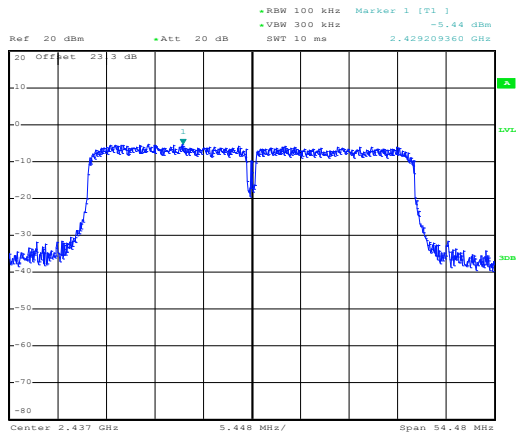

Date: 18.FEB.2014 01:36:10

Spurious Emission 30MHz~3GHz

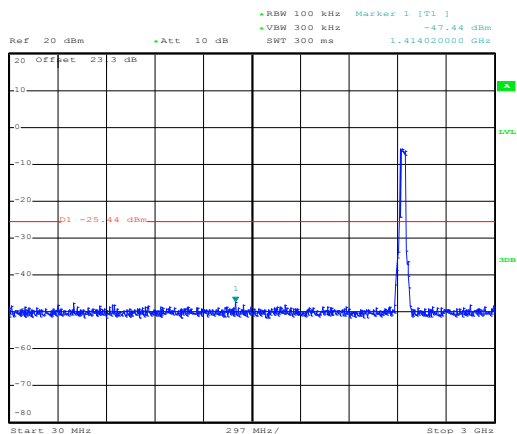

Date: 18.FEB.2014 01:36:29

Spurious Emission 2GHz~25GHz

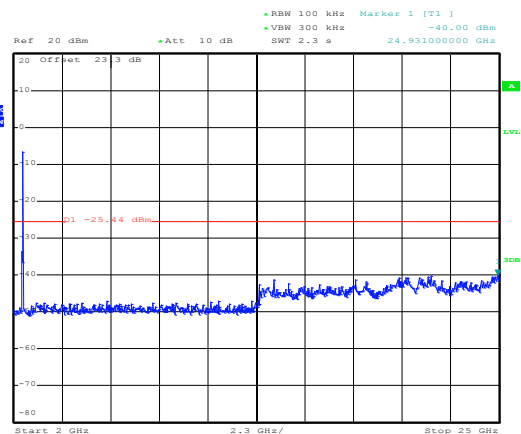

Date: 18.FEB.2014 01:36:48



Number of TX :	2	Ant. :	1
Test Mode :	802.11n HT40	Temperature :	21~25°C
Test Band :	2.4GHz High	Relative Humidity :	51~54%
Test Channel :	09	Test Engineer :	Bill Kuo

WLAN 802.11n HT40 Channel 09

100kHz PSD reference Level

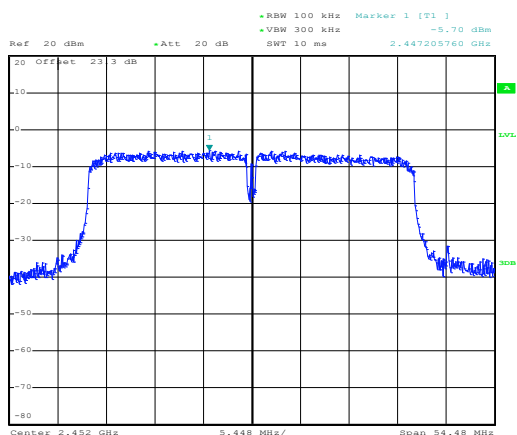

Date: 18.FEB.2014 01:26:47

High Channel Plot

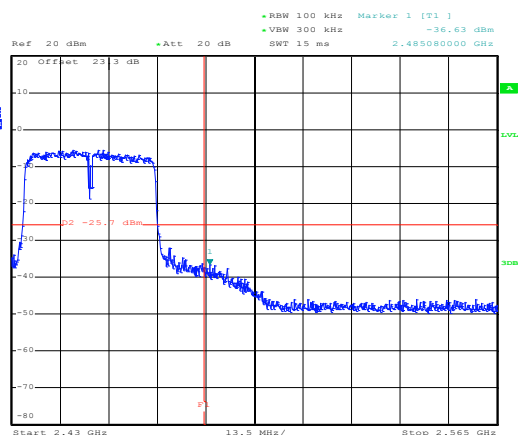

Date: 18.FEB.2014 01:27:00

Spurious Emission 30MHz~3GHz

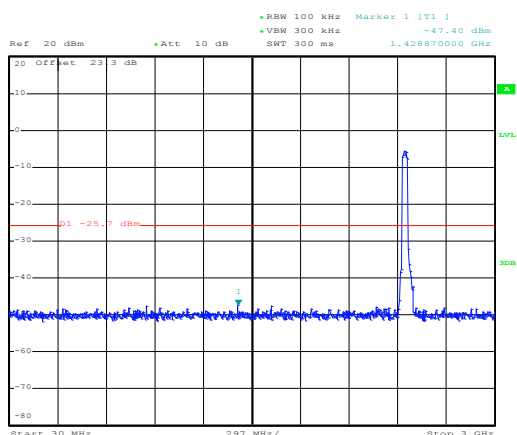

Date: 18.FEB.2014 01:27:19

Spurious Emission 2GHz~25GHz

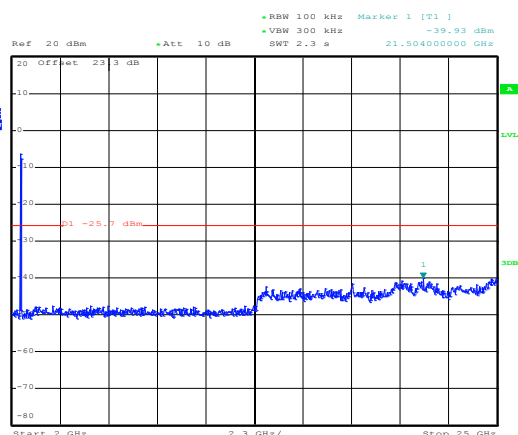

Date: 18.FEB.2014 01:27:38



Number of TX = 2, Ant. 2 (Measured)

Number of TX :	2	Ant. :	2
Test Mode :	802.11n HT20	Temperature :	21~25°C
Test Band :	2.4GHz Low	Relative Humidity :	51~54%
Test Channel :	01	Test Engineer :	Bill Kuo

WLAN 802.11n HT20 Channel 01

100kHz PSD reference Level

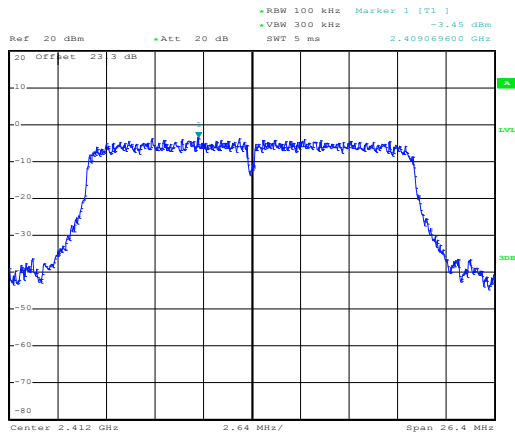

Date: 18.FEB.2014 00:56:30

Low Channel Plot

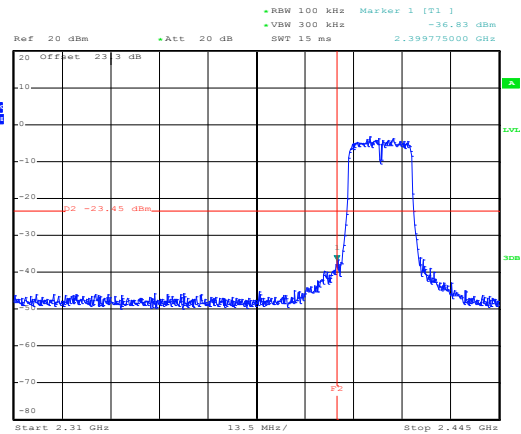

Date: 18.FEB.2014 00:56:44

Spurious Emission 30MHz~3GHz

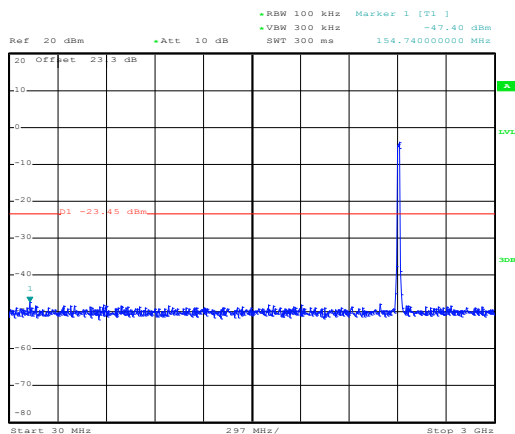

Date: 18.FEB.2014 00:57:03

Spurious Emission 2GHz~25GHz

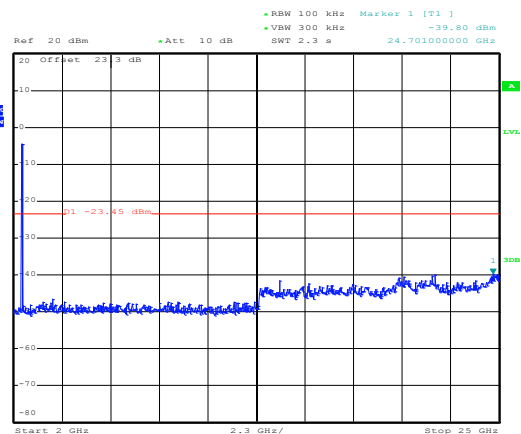

Date: 18.FEB.2014 00:57:22



Number of TX :	2	Ant. :	2
Test Mode :	802.11n HT20	Temperature :	21~25°C
Test Band :	2.4GHz Mid	Relative Humidity :	51~54%
Test Channel :	06	Test Engineer :	Bill Kuo

WLAN 802.11n HT20 Channel 06

100kHz PSD reference Level

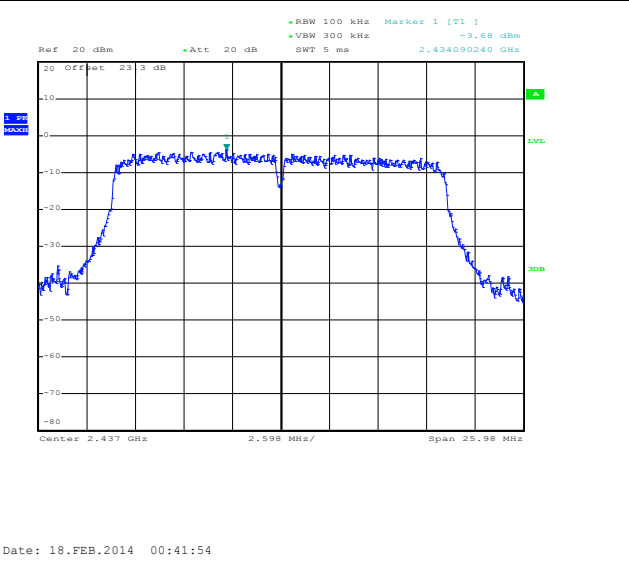

Spurious Emission 30MHz~3GHz

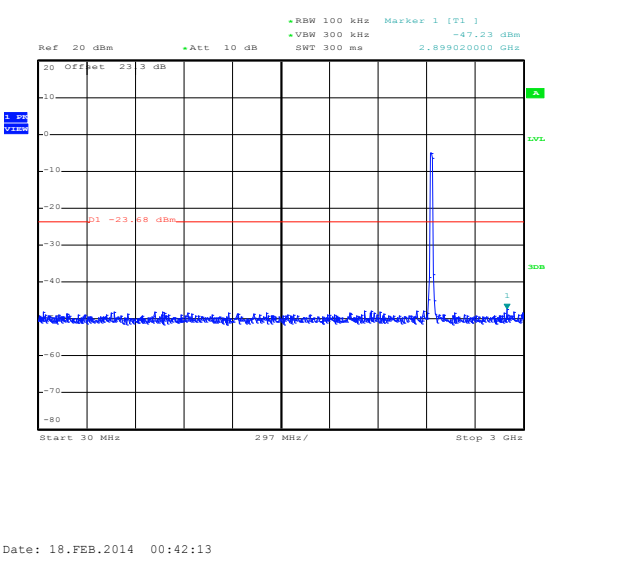

Spurious Emission 2GHz~25GHz

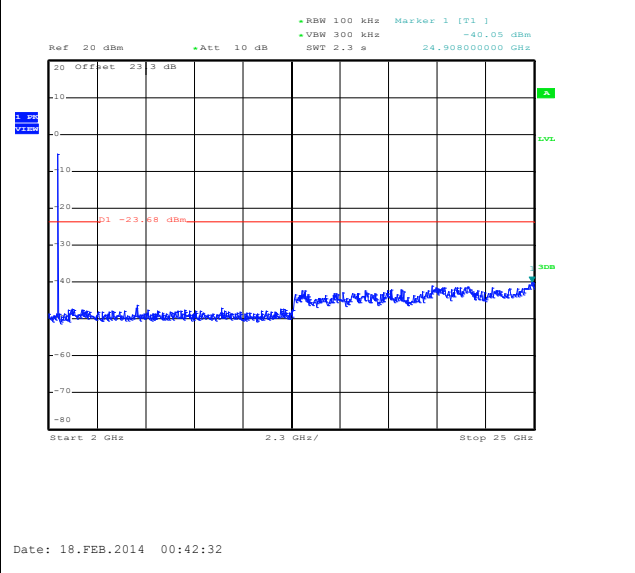



Number of TX :	2	Ant. :	2
Test Mode :	802.11n HT20	Temperature :	21~25°C
Test Band :	2.4GHz High	Relative Humidity :	51~54%
Test Channel :	11	Test Engineer :	Bill Kuo

WLAN 802.11n HT20 Channel 11

100kHz PSD reference Level

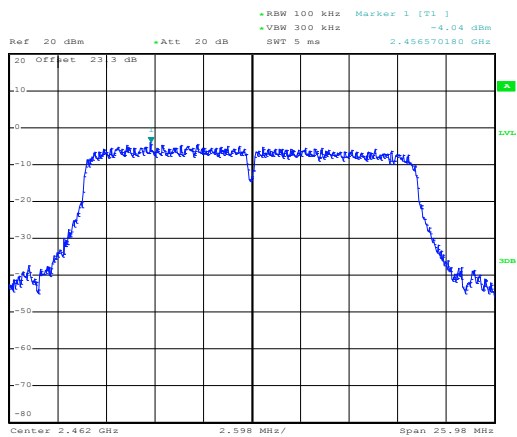

Date: 18.FEB.2014 00:28:22

High Channel Plot

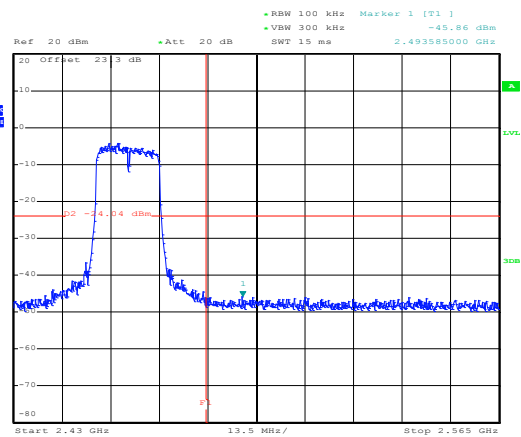

Date: 18.FEB.2014 00:28:36

Spurious Emission 30MHz~3GHz

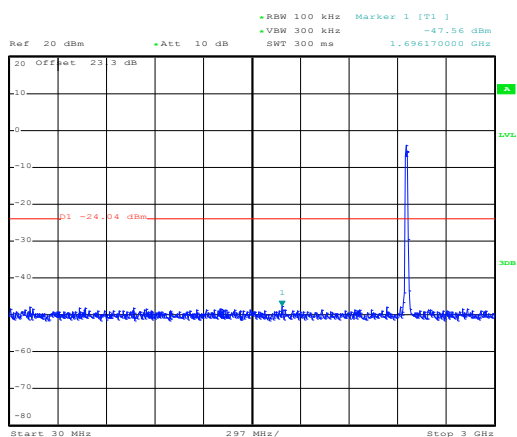

Date: 18.FEB.2014 00:28:55

Spurious Emission 2GHz~25GHz

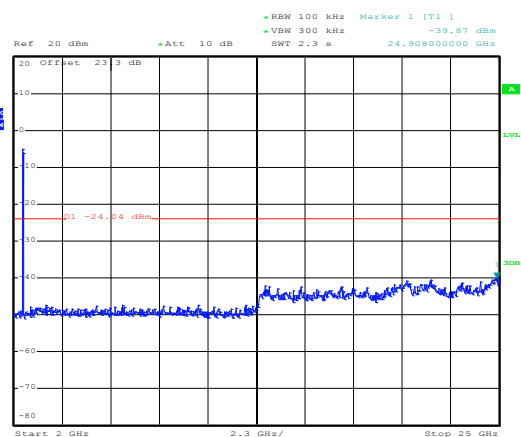

Date: 18.FEB.2014 00:29:13



Number of TX :	2	Ant. :	2
Test Mode :	802.11n HT40	Temperature :	21~25°C
Test Band :	2.4GHz Low	Relative Humidity :	51~54%
Test Channel :	03	Test Engineer :	Bill Kuo

WLAN 802.11n HT40 Channel 03

100kHz PSD reference Level

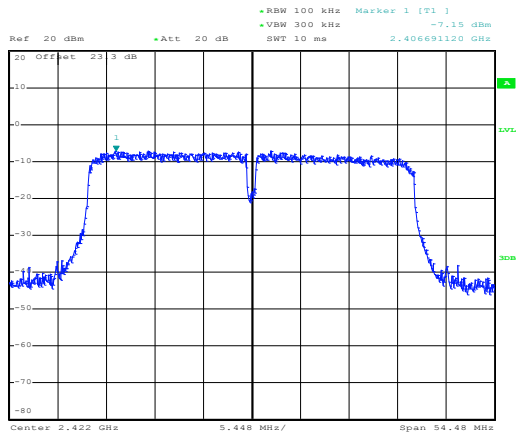

Date: 18.FEB.2014 01:43:35

Low Channel Plot

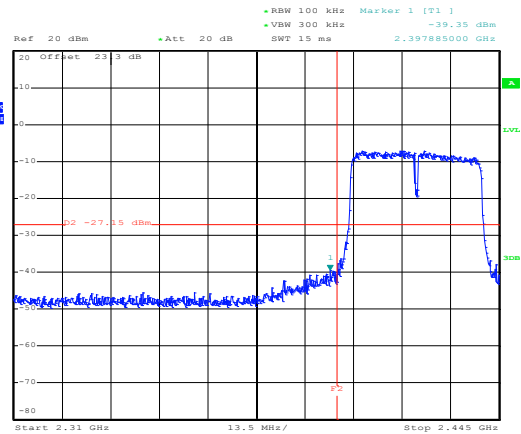

Date: 18.FEB.2014 01:43:48

Spurious Emission 30MHz~3GHz

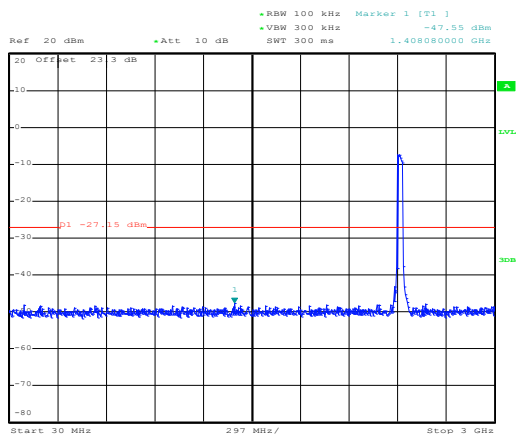

Date: 18.FEB.2014 01:44:07

Spurious Emission 2GHz~25GHz

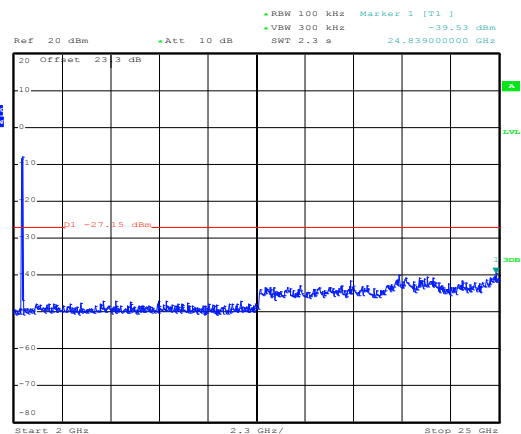

Date: 18.FEB.2014 01:44:26



Number of TX :	2	Ant. :	2
Test Mode :	802.11n HT40	Temperature :	21~25°C
Test Band :	2.4GHz Mid	Relative Humidity :	51~54%
Test Channel :	06	Test Engineer :	Bill Kuo

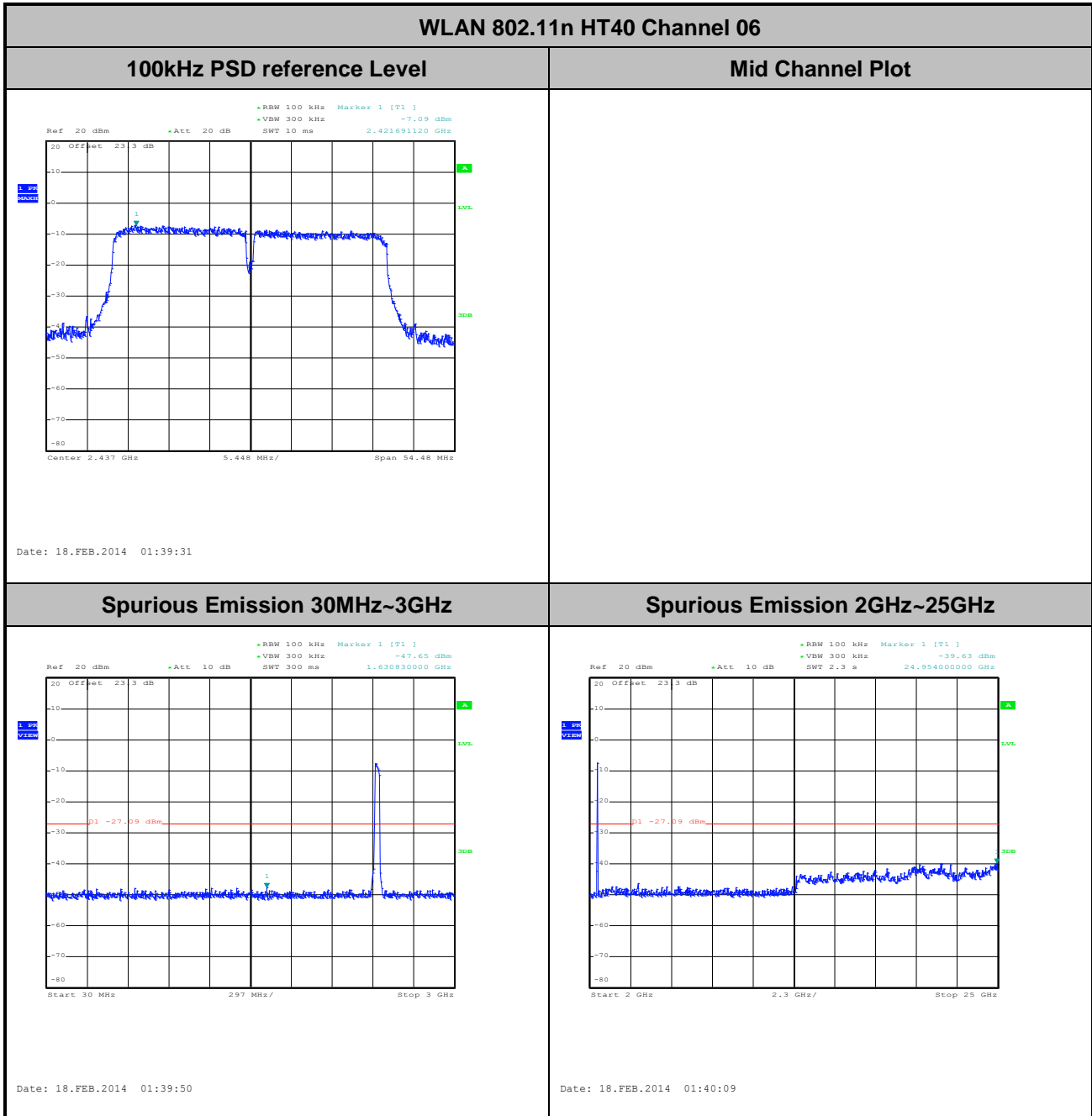



Number of TX :	2	Ant. :	2
Test Mode :	802.11n HT40	Temperature :	21~25°C
Test Band :	2.4GHz High	Relative Humidity :	51~54%
Test Channel :	09	Test Engineer :	Bill Kuo

WLAN 802.11n HT40 Channel 09

100kHz PSD reference Level

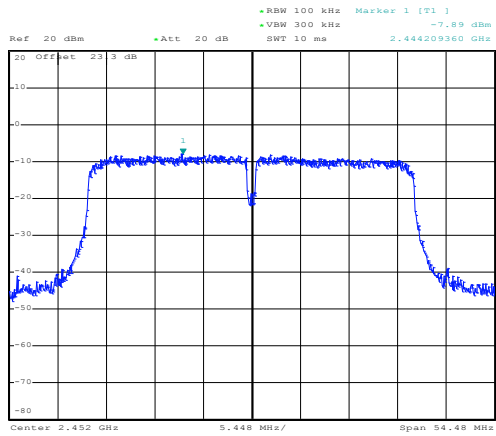

Date: 18.FEB.2014 01:19:37

High Channel Plot

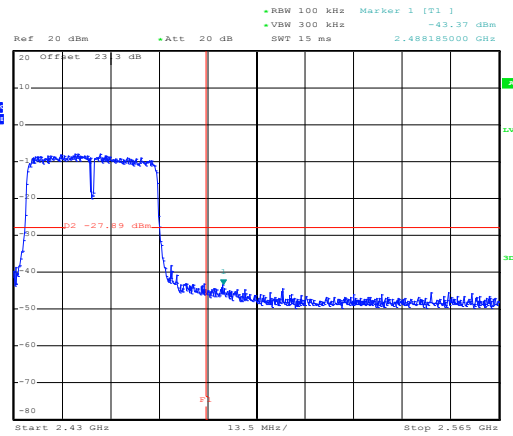

Date: 18.FEB.2014 01:19:51

Spurious Emission 30MHz~3GHz

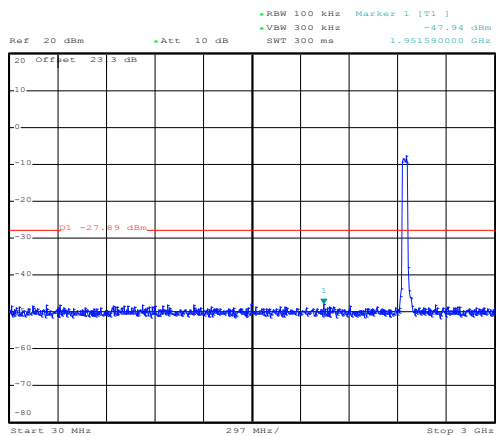

Date: 18.FEB.2014 01:20:10

Spurious Emission 2GHz~25GHz

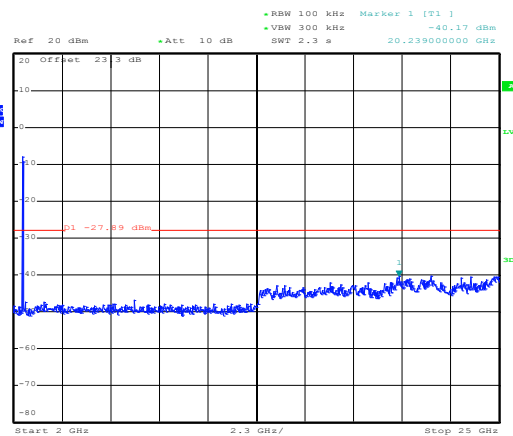

Date: 18.FEB.2014 01:20:28



3.5 Radiated Band Edges and Spurious Emission Measurement

3.5.1 Limit of Radiated band edge and Spurious Emission Measurement

In any 100 kHz bandwidth outside the intentional radiator frequency band, all harmonics/spurious must be at least 20 dB below the highest emission level within the authorized band. If the output power of this device was measured by spectrum analyzer, the attenuation under this paragraph shall be 30 dB instead of 20 dB. In addition, radiated emissions which fall in the restricted bands must also comply with the FCC section 15.209 limits as below.

Frequency (MHz)	Field Strength (microvolts/meter)	Measurement Distance (meters)
0.009 – 0.490	2400/F(kHz)	300
0.490 – 1.705	24000/F(kHz)	30
1.705 – 30.0	30	30
30 – 88	100	3
88 – 216	150	3
216 - 960	200	3
Above 960	500	3

3.5.2 Measuring Instruments

The measuring equipment is listed in the section 4 of this test report.



3.5.3 Test Procedure

1. The testing follows FCC KDB Publication No. 558074 D01 DTS Meas. Guidance v03r01.
2. The EUT was arranged to its worst case and then tune the antenna tower (from 1 m to 4 m) and turntable (from 0 degree to 360 degrees) to find the maximum reading. A pre-amp and a high pass filter are used for the test in order to get better signal level.
3. The EUT was placed on a turntable with 0.8 meter above ground.
4. The EUT was set 3 meters from the interference receiving antenna, which was mounted on the top of a variable height antenna tower.
5. Corrected Reading: Antenna Factor + Cable Loss + Read Level - Preamp Factor = Level
6. For measurement below 1GHz, If the emission level of the EUT measured by the peak detector is 3 dB lower than the applicable limit, the peak emission level will be reported. Otherwise, the emission measurement will be repeated using the quasi-peak detector and reported.
7. Use the following spectrum analyzer settings:
 - (1) Span shall wide enough to fully capture the emission being measured;
 - (2) Set RBW=100 kHz for $f < 1$ GHz; $VBW \geq RBW$; Sweep = auto; Detector function = peak; Trace = max hold;
 - (3) Set RBW = 1 MHz, VBW= 3MHz for $f \geq 1$ GHz for peak measurement.
 For average measurement:
 - $VBW = 10$ Hz, when duty cycle is no less than 98 percent.
 - $VBW \geq 1/T$, when duty cycle is less than 98 percent where T is the minimum transmission duration over which the transmitter is on and is transmitting at its maximum power control level for the tested mode of operation.

Antenna	Band	Duty Cycle(%)	T(us)	1/T(kHz)	VBW Setting
1	802.11b	100	-	-	10Hz
1	802.11g	100	-	-	
1	2.4GHz 802.11n HT20	100	-	-	
1	2.4GHz 802.11n HT40	100	-	-	
1+2	2.4GHz 802.11n HT20 for Ant 1	100	-	-	
1+2	2.4GHz 802.11n HT40 for Ant 2	100	-	-	

3.5.4 Test Setup

For radiated emissions below 30MHz

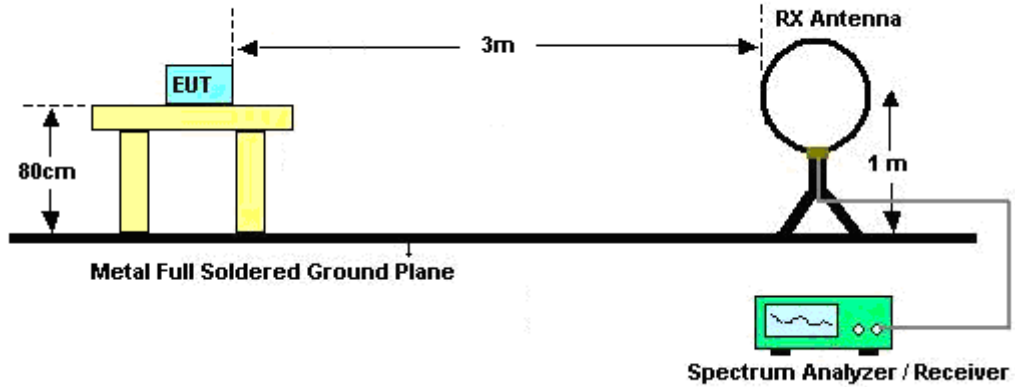

For radiated emissions from 30MHz to 1GHz

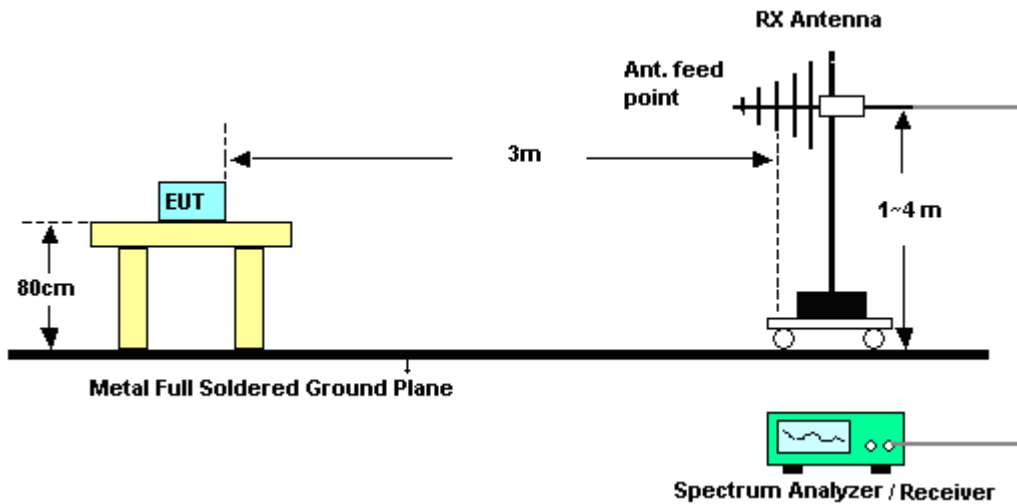

For radiated emissions above 1GHz

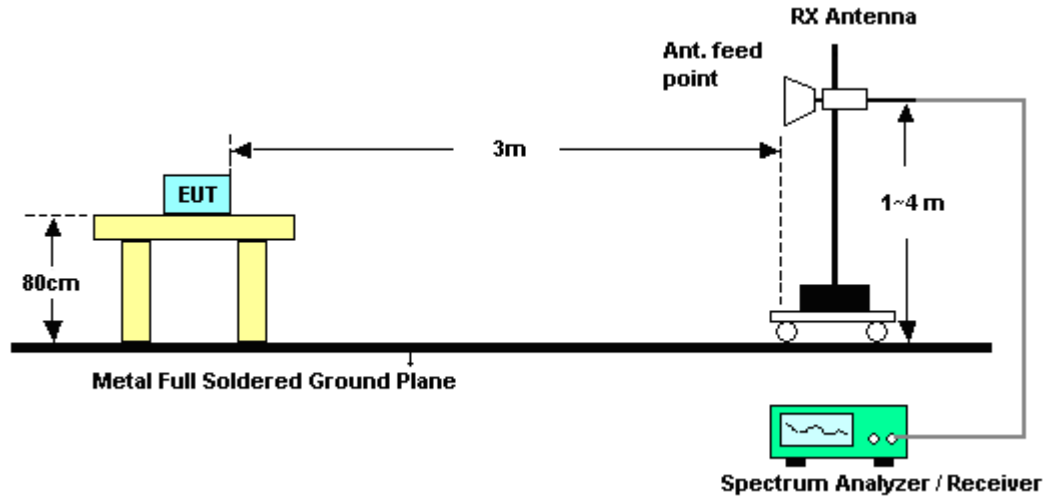

3.5.5 Test Results of Radiated Emissions (9kHz ~ 30MHz)

The low frequency, which started from 9 kHz to 30MHz, was pre-scanned and the result which was 20dB lower than the limit line per 15.31(o) was not reported.



3.5.6 Test Result of Radiated Spurious at Band Edges

<Ant. 2>

Test Mode :	802.11b	Temperature :	21~23°C
Test Band :	Low	Relative Humidity :	46~48%
Test Channel :	01	Test Engineer :	Stan Hsieh

ANTENNA POLARITY : HORIZONTAL										
Frequency (MHz)	Level (dBμV/m)	Over Limit (dB)	Limit Line (dBμV/m)	Read Level (dBμV)	Antenna Factor (dB)	Cable Loss (dB)	Preamp Factor (dB)	Ant Pos (cm)	Table Pos (deg)	Remark
2379.84	56.91	-17.09	74	52.02	32.28	6.88	34.27	101	346	Peak
2389.02	43.53	-10.47	54	38.59	32.3	6.91	34.27	101	346	Average

ANTENNA POLARITY : VERTICAL										
Frequency (MHz)	Level (dBμV/m)	Over Limit (dB)	Limit Line (dBμV/m)	Read Level (dBμV)	Antenna Factor (dB)	Cable Loss (dB)	Preamp Factor (dB)	Ant Pos (cm)	Table Pos (deg)	Remark
2325.84	56.64	-17.36	74	51.83	32.23	6.8	34.22	150	303	Peak
2374.17	42.38	-11.62	54	37.49	32.28	6.88	34.27	150	303	Average

Test Mode :	802.11b	Temperature :	21~23°C
Test Band :	High	Relative Humidity :	46~48%
Test Channel :	11	Test Engineer :	Stan Hsieh

ANTENNA POLARITY : HORIZONTAL										
Frequency (MHz)	Level (dBμV/m)	Over Limit (dB)	Limit Line (dBμV/m)	Read Level (dBμV)	Antenna Factor (dB)	Cable Loss (dB)	Preamp Factor (dB)	Ant Pos (cm)	Table Pos (deg)	Remark
2484.37	57.94	-16.06	74	52.93	32.38	7.06	34.43	102	348	Peak
2483.5	43.49	-10.51	54	38.48	32.38	7.06	34.43	102	348	Average

ANTENNA POLARITY : VERTICAL										
Frequency (MHz)	Level (dBμV/m)	Over Limit (dB)	Limit Line (dBμV/m)	Read Level (dBμV)	Antenna Factor (dB)	Cable Loss (dB)	Preamp Factor (dB)	Ant Pos (cm)	Table Pos (deg)	Remark
2496.16	56.73	-17.27	74	51.75	32.4	7.06	34.48	131	103	Peak
2483.68	42.59	-11.41	54	37.58	32.38	7.06	34.43	131	103	Average



Test Mode :	802.11g	Temperature :	21~23°C
Test Band :	Low	Relative Humidity :	46~48%
Test Channel :	01	Test Engineer :	Stan Hsieh

ANTENNA POLARITY : HORIZONTAL										
Frequency (MHz)	Level (dBμV/m)	Over Limit (dB)	Limit Line (dBμV/m)	Read Level (dBμV)	Antenna Factor (dB)	Cable Loss (dB)	Preamp Factor (dB)	Ant Pos (cm)	Table Pos (deg)	Remark
2390.01	66.21	-7.79	74	61.3	32.3	6.91	34.3	118	337	Peak
2390	47.75	-6.25	54	42.84	32.3	6.91	34.3	118	337	Average

ANTENNA POLARITY : VERTICAL										
Frequency (MHz)	Level (dBμV/m)	Over Limit (dB)	Limit Line (dBμV/m)	Read Level (dBμV)	Antenna Factor (dB)	Cable Loss (dB)	Preamp Factor (dB)	Ant Pos (cm)	Table Pos (deg)	Remark
2390.01	57.99	-16.01	74	53.08	32.3	6.91	34.3	164	310	Peak
2390	43.42	-10.58	54	38.51	32.3	6.91	34.3	164	310	Average

Test Mode :	802.11g	Temperature :	21~23°C
Test Band :	High	Relative Humidity :	46~48%
Test Channel :	11	Test Engineer :	Stan Hsieh

ANTENNA POLARITY : HORIZONTAL										
Frequency (MHz)	Level (dBμV/m)	Over Limit (dB)	Limit Line (dBμV/m)	Read Level (dBμV)	Antenna Factor (dB)	Cable Loss (dB)	Preamp Factor (dB)	Ant Pos (cm)	Table Pos (deg)	Remark
2483.77	67.58	-6.42	74	62.57	32.38	7.06	34.43	142	333	Peak
2483.5	47.82	-6.18	54	42.81	32.38	7.06	34.43	142	333	Average

ANTENNA POLARITY : VERTICAL										
Frequency (MHz)	Level (dBμV/m)	Over Limit (dB)	Limit Line (dBμV/m)	Read Level (dBμV)	Antenna Factor (dB)	Cable Loss (dB)	Preamp Factor (dB)	Ant Pos (cm)	Table Pos (deg)	Remark
2483.89	61.92	-12.08	74	56.91	32.38	7.06	34.43	100	309	Peak
2483.5	44.4	-9.6	54	39.39	32.38	7.06	34.43	100	309	Average



MIMO <Ant. 1 + 2>

Test Mode :	802.11n HT20	Temperature :	21~23°C
Test Band :	Low	Relative Humidity :	46~48%
Test Channel :	01	Test Engineer :	Stan Hsieh

ANTENNA POLARITY : HORIZONTAL										
Frequency (MHz)	Level (dBμV/m)	Over Limit (dB)	Limit Line (dBμV/m)	Read Level (dBμV)	Antenna Factor (dB)	Cable Loss (dB)	Preamp Factor (dB)	Ant Pos (cm)	Table Pos (deg)	Remark
2390	73.6	-0.4	74	68.69	32.3	6.91	34.3	181	359	Peak
2390	50.59	-3.41	54	45.68	32.3	6.91	34.3	181	359	Average

ANTENNA POLARITY : VERTICAL										
Frequency (MHz)	Level (dBμV/m)	Over Limit (dB)	Limit Line (dBμV/m)	Read Level (dBμV)	Antenna Factor (dB)	Cable Loss (dB)	Preamp Factor (dB)	Ant Pos (cm)	Table Pos (deg)	Remark
2389.47	64.34	-9.66	74	59.4	32.3	6.91	34.27	126	304	Peak
2390	45.3	-8.7	54	40.39	32.3	6.91	34.3	126	304	Average

Test Mode :	802.11n HT20	Temperature :	21~23°C
Test Band :	High	Relative Humidity :	46~48%
Test Channel :	11	Test Engineer :	Stan Hsieh

ANTENNA POLARITY : HORIZONTAL										
Frequency (MHz)	Level (dBμV/m)	Over Limit (dB)	Limit Line (dBμV/m)	Read Level (dBμV)	Antenna Factor (dB)	Cable Loss (dB)	Preamp Factor (dB)	Ant Pos (cm)	Table Pos (deg)	Remark
2483.59	71.3	-2.7	74	66.29	32.38	7.06	34.43	178	5	Peak
2483.5	51.26	-2.74	54	46.25	32.38	7.06	34.43	178	5	Average

ANTENNA POLARITY : VERTICAL										
Frequency (MHz)	Level (dBμV/m)	Over Limit (dB)	Limit Line (dBμV/m)	Read Level (dBμV)	Antenna Factor (dB)	Cable Loss (dB)	Preamp Factor (dB)	Ant Pos (cm)	Table Pos (deg)	Remark
2483.56	67.06	-6.94	74	62.05	32.38	7.06	34.43	100	307	Peak
2483.5	47.41	-6.59	54	42.4	32.38	7.06	34.43	100	307	Average



Test Mode :	802.11n HT40	Temperature :	21~23°C
Test Band :	Low	Relative Humidity :	46~48%
Test Channel :	03	Test Engineer :	Stan Hsieh

ANTENNA POLARITY : HORIZONTAL										
Frequency (MHz)	Level (dBμV/m)	Over Limit (dB)	Limit Line (dBμV/m)	Read Level (dBμV)	Antenna Factor (dB)	Cable Loss (dB)	Preamp Factor (dB)	Ant Pos (cm)	Table Pos (deg)	Remark
2386.14	68.99	-5.01	74	64.05	32.3	6.91	34.27	154	355	Peak
2383.26	52.47	-1.53	54	47.55	32.28	6.91	34.27	154	355	Average
2483.98	56.31	-17.69	74	51.3	32.38	7.06	34.43	154	355	Peak
2483.92	42.33	-11.67	54	37.32	32.38	7.06	34.43	154	355	Average

ANTENNA POLARITY : VERTICAL										
Frequency (MHz)	Level (dBμV/m)	Over Limit (dB)	Limit Line (dBμV/m)	Read Level (dBμV)	Antenna Factor (dB)	Cable Loss (dB)	Preamp Factor (dB)	Ant Pos (cm)	Table Pos (deg)	Remark
2388.93	64.98	-9.02	74	60.04	32.3	6.91	34.27	102	303	Peak
2386.59	48.05	-5.95	54	43.11	32.3	6.91	34.27	102	303	Average
2490.94	56.7	-17.3	74	51.67	32.4	7.06	34.43	102	303	Peak
2483.62	42.46	-11.54	54	37.45	32.38	7.06	34.43	102	303	Average



Test Mode :	802.11n HT40	Temperature :	21~23°C
Test Band :	High	Relative Humidity :	46~48%
Test Channel :	09	Test Engineer :	Stan Hsieh

ANTENNA POLARITY : HORIZONTAL										
Frequency (MHz)	Level (dBμV/m)	Over Limit (dB)	Limit Line (dBμV/m)	Read Level (dBμV)	Antenna Factor (dB)	Cable Loss (dB)	Preamp Factor (dB)	Ant Pos (cm)	Table Pos (deg)	Remark
2331.69	56.77	-17.23	74	51.96	32.23	6.8	34.22	179	343	Peak
2359.14	42.25	-11.75	54	37.36	32.26	6.88	34.25	179	343	Average
2483.56	70.02	-3.98	74	65.01	32.38	7.06	34.43	179	343	Peak
2483.5	52.8	-1.2	54	47.79	32.38	7.06	34.43	179	343	Average

ANTENNA POLARITY : VERTICAL										
Frequency (MHz)	Level (dBμV/m)	Over Limit (dB)	Limit Line (dBμV/m)	Read Level (dBμV)	Antenna Factor (dB)	Cable Loss (dB)	Preamp Factor (dB)	Ant Pos (cm)	Table Pos (deg)	Remark
2330.43	56.91	-17.09	74	52.1	32.23	6.8	34.22	125	306	Peak
2352.12	42.28	-11.72	54	37.43	32.26	6.84	34.25	125	306	Average
2488.03	65.89	-8.11	74	60.86	32.4	7.06	34.43	125	306	Peak
2484.37	47.89	-6.11	54	42.88	32.38	7.06	34.43	125	306	Average

3.5.7 Test Result of Radiated Spurious Emission (30MHz ~ 10th Harmonic)

Note: Pre-scanned all test modes and only choose the worst case mode recorded in the test report for radiated spurious emission below 1GHz.

<Ant. 2>

Test Mode :	802.11b	Temperature :	21~23°C
Test Channel :	01	Relative Humidity :	46~48%
Test Engineer :	Stan Hsieh	Polarization :	Horizontal
Remark :	1. 2410 MHz is fundamental signal which can be ignored. 2. Average measurement was not performed if peak level went lower than the average limit.		

Frequency (MHz)	Level (dBμV/m)	Over Limit (dB)	Limit Line (dBμV/m)	Read Level (dBμV)	Antenna Factor (dB)	Cable Loss (dB)	Preamp Factor (dB)	Ant Pos (cm)	Table Pos (deg)	Remark
2410	102.94	-	-	97.98	32.31	6.95	34.3	101	346	Average
2410	107.08	-	-	102.12	32.31	6.95	34.3	101	346	Peak
4824	41.8	-32.2	74	57.99	33.97	8.77	58.93	100	0	Peak

Test Mode :	802.11b	Temperature :	21~23°C
Test Channel :	01	Relative Humidity :	46~48%
Test Engineer :	Stan Hsieh	Polarization :	Vertical
Remark :	1. 2410 MHz is fundamental signal which can be ignored. 2. Average measurement was not performed if peak level went lower than the average limit.		

Frequency (MHz)	Level (dBμV/m)	Over Limit (dB)	Limit Line (dBμV/m)	Read Level (dBμV)	Antenna Factor (dB)	Cable Loss (dB)	Preamp Factor (dB)	Ant Pos (cm)	Table Pos (deg)	Remark
2410	95.08	-	-	90.12	32.31	6.95	34.3	150	303	Average
2410	99.25	-	-	94.29	32.31	6.95	34.3	150	303	Peak
4824	40.3	-33.7	74	56.49	33.97	8.77	58.93	100	0	Peak



Test Mode :	802.11b	Temperature :	21~23°C
Test Channel :	06	Relative Humidity :	46~48%
Test Engineer :	Stan Hsieh	Polarization :	Horizontal
Remark :	1. 2438 MHz is fundamental signal which can be ignored. 2. Average measurement was not performed if peak level went lower than the average limit.		

Frequency (MHz)	Level (dBμV/m)	Over Limit (dB)	Limit Line (dBμV/m)	Read Level (dBμV)	Antenna Factor (dB)	Cable Loss (dB)	Preamp Factor (dB)	Ant Pos (cm)	Table Pos (deg)	Remark
2438	103.93	-	-	98.94	32.35	6.99	34.35	102	346	Average
2438	108.21	-	-	103.22	32.35	6.99	34.35	102	346	Peak
4875	42.23	-31.77	74	58.29	33.95	8.82	58.83	100	0	Peak
7311	42.26	-31.74	74	53.54	35.54	10.91	57.73	100	0	Peak

Test Mode :	802.11b	Temperature :	21~23°C
Test Channel :	06	Relative Humidity :	46~48%
Test Engineer :	Stan Hsieh	Polarization :	Vertical
Remark :	1. 2438 MHz is fundamental signal which can be ignored. 2. Average measurement was not performed if peak level went lower than the average limit.		

Frequency (MHz)	Level (dBμV/m)	Over Limit (dB)	Limit Line (dBμV/m)	Read Level (dBμV)	Antenna Factor (dB)	Cable Loss (dB)	Preamp Factor (dB)	Ant Pos (cm)	Table Pos (deg)	Remark
2438	96.17	-	-	91.18	32.35	6.99	34.35	171	301	Average
2438	100.38	-	-	95.39	32.35	6.99	34.35	171	301	Peak
4875	40.41	-33.59	74	56.47	33.95	8.82	58.83	100	0	Peak
7311	41.79	-32.21	74	53.07	35.54	10.91	57.73	100	0	Peak



Test Mode :	802.11b	Temperature :	21~23°C
Test Channel :	11	Relative Humidity :	46~48%
Test Engineer :	Stan Hsieh	Polarization :	Horizontal
Remark :	1. 2462 MHz is fundamental signal which can be ignored. 2. Average measurement was not performed if peak level went lower than the average limit.		

Frequency (MHz)	Level (dBμV/m)	Over Limit (dB)	Limit Line (dBμV/m)	Read Level (dBμV)	Antenna Factor (dB)	Cable Loss (dB)	Preamp Factor (dB)	Ant Pos (cm)	Table Pos (deg)	Remark
2462	103.25	-	-	98.25	32.37	7.02	34.39	102	348	Average
2462	106.85	-	-	101.85	32.37	7.02	34.39	102	348	Peak
4923	40.81	-33.19	74	56.74	33.93	8.87	58.73	100	0	Peak
7386	41.89	-32.11	74	53.18	35.52	10.99	57.8	100	0	Peak

Test Mode :	802.11b	Temperature :	21~23°C
Test Channel :	11	Relative Humidity :	46~48%
Test Engineer :	Stan Hsieh	Polarization :	Vertical
Remark :	1. 2462 MHz is fundamental signal which can be ignored. 2. Average measurement was not performed if peak level went lower than the average limit.		

Frequency (MHz)	Level (dBμV/m)	Over Limit (dB)	Limit Line (dBμV/m)	Read Level (dBμV)	Antenna Factor (dB)	Cable Loss (dB)	Preamp Factor (dB)	Ant Pos (cm)	Table Pos (deg)	Remark
2462	94.45	-	-	89.45	32.37	7.02	34.39	131	103	Average
2462	98.76	-	-	93.76	32.37	7.02	34.39	131	103	Peak
4923	39.47	-34.53	74	55.4	33.93	8.87	58.73	100	0	Peak
7386	42.32	-31.68	74	53.61	35.52	10.99	57.8	100	0	Peak



Test Mode :	802.11g	Temperature :	21~23°C
Test Channel :	01	Relative Humidity :	46~48%
Test Engineer :	Stan Hsieh	Polarization :	Horizontal
Remark :	1. 2412 MHz is fundamental signal which can be ignored. 2. Average measurement was not performed if peak level went lower than the average limit.		

Frequency (MHz)	Level (dBμV/m)	Over Limit (dB)	Limit Line (dBμV/m)	Read Level (dBμV)	Antenna Factor (dB)	Cable Loss (dB)	Preamp Factor (dB)	Ant Pos (cm)	Table Pos (deg)	Remark
2412	98.67	-	-	93.71	32.31	6.95	34.3	118	337	Average
2412	108.4	-	-	103.44	32.31	6.95	34.3	118	337	Peak
4824	39.54	-34.46	74	55.73	33.97	8.77	58.93	100	0	Peak

Test Mode :	802.11g	Temperature :	21~23°C
Test Channel :	01	Relative Humidity :	46~48%
Test Engineer :	Stan Hsieh	Polarization :	Vertical
Remark :	1. 2412 MHz is fundamental signal which can be ignored. 2. Average measurement was not performed if peak level went lower than the average limit.		

Frequency (MHz)	Level (dBμV/m)	Over Limit (dB)	Limit Line (dBμV/m)	Read Level (dBμV)	Antenna Factor (dB)	Cable Loss (dB)	Preamp Factor (dB)	Ant Pos (cm)	Table Pos (deg)	Remark
2412	90.63	-	-	85.67	32.31	6.95	34.3	164	310	Average
2412	100.56	-	-	95.6	32.31	6.95	34.3	164	310	Peak
4824	39.58	-34.42	74	55.77	33.97	8.77	58.93	100	0	Peak



Test Mode :	802.11g	Temperature :	21~23°C
Test Channel :	06	Relative Humidity :	46~48%
Test Engineer :	Stan Hsieh	Polarization :	Horizontal
Remark :	1. 2438 MHz is fundamental signal which can be ignored. 2. Average measurement was not performed if peak level went lower than the average limit.		

Frequency (MHz)	Level (dBμV/m)	Over Limit (dB)	Limit Line (dBμV/m)	Read Level (dBμV)	Antenna Factor (dB)	Cable Loss (dB)	Preamp Factor (dB)	Ant Pos (cm)	Table Pos (deg)	Remark
2438	99.76	-	-	94.77	32.35	6.99	34.35	117	338	Average
2438	109.34	-	-	104.35	32.35	6.99	34.35	117	338	Peak
4875	39.47	-34.53	74	55.53	33.95	8.82	58.83	100	0	Peak
7311	41.76	-32.24	74	53.04	35.54	10.91	57.73	100	0	Peak

Test Mode :	802.11g	Temperature :	21~23°C
Test Channel :	06	Relative Humidity :	46~48%
Test Engineer :	Stan Hsieh	Polarization :	Vertical
Remark :	1. 2436 MHz is fundamental signal which can be ignored. 2. Average measurement was not performed if peak level went lower than the average limit.		

Frequency (MHz)	Level (dBμV/m)	Over Limit (dB)	Limit Line (dBμV/m)	Read Level (dBμV)	Antenna Factor (dB)	Cable Loss (dB)	Preamp Factor (dB)	Ant Pos (cm)	Table Pos (deg)	Remark
2436	90.32	-	-	85.35	32.33	6.99	34.35	101	309	Average
2436	99.94	-	-	94.97	32.33	6.99	34.35	101	309	Peak
4875	39.71	-34.29	74	55.77	33.95	8.82	58.83	100	0	Peak
7311	42.72	-31.28	74	54	35.54	10.91	57.73	100	0	Peak



Test Mode :	802.11g	Temperature :	21~23°C
Test Channel :	11	Relative Humidity :	46~48%
Test Engineer :	Stan Hsieh	Polarization :	Horizontal
Remark :	1. 2461 MHz is fundamental signal which can be ignored. 2. Average measurement was not performed if peak level went lower than the average limit.		

Frequency (MHz)	Level (dBμV/m)	Over Limit (dB)	Limit Line (dBμV/m)	Read Level (dBμV)	Antenna Factor (dB)	Cable Loss (dB)	Preamp Factor (dB)	Ant Pos (cm)	Table Pos (deg)	Remark
2461	97.61	-	-	92.61	32.37	7.02	34.39	142	333	Average
2461	107.54	-	-	102.54	32.37	7.02	34.39	142	333	Peak
4923	40.87	-33.13	74	56.8	33.93	8.87	58.73	100	0	Peak
7386	41.8	-32.2	74	53.09	35.52	10.99	57.8	100	0	Peak

Test Mode :	802.11g	Temperature :	21~23°C
Test Channel :	11	Relative Humidity :	46~48%
Test Engineer :	Stan Hsieh	Polarization :	Vertical
Remark :	1. 2461 MHz is fundamental signal which can be ignored. 2. Average measurement was not performed if peak level went lower than the average limit.		

Frequency (MHz)	Level (dBμV/m)	Over Limit (dB)	Limit Line (dBμV/m)	Read Level (dBμV)	Antenna Factor (dB)	Cable Loss (dB)	Preamp Factor (dB)	Ant Pos (cm)	Table Pos (deg)	Remark
2461	90.49	-	-	85.49	32.37	7.02	34.39	100	309	Average
2461	100.34	-	-	95.34	32.37	7.02	34.39	100	309	Peak
4923	40.34	-33.66	74	56.27	33.93	8.87	58.73	100	0	Peak
7386	41.75	-32.25	74	53.04	35.52	10.99	57.8	100	0	Peak



MIMO <Ant. 1+2>

Test Mode :	802.11n HT20	Temperature :	21~23°C
Test Channel :	01	Relative Humidity :	46~48%
Test Engineer :	Stan Hsieh	Polarization :	Horizontal
Remark :	1. 2411 MHz is fundamental signal which can be ignored. 2. Average measurement was not performed if peak level went lower than the average limit.		

Frequency (MHz)	Level (dBμV/m)	Over Limit (dB)	Limit Line (dBμV/m)	Read Level (dBμV)	Antenna Factor (dB)	Cable Loss (dB)	Preamp Factor (dB)	Ant Pos (cm)	Table Pos (deg)	Remark
42.96	13.36	-26.64	40	32.02	11.9	0.64	31.2	-	-	Peak
88.86	24.13	-19.37	43.5	45.72	8.58	0.93	31.1	-	-	Peak
285.15	29.42	-16.58	46	45.81	12.95	1.66	31	114	55	Peak
309.1	29.31	-16.69	46	45.23	13.29	1.79	31	-	-	Peak
519.8	26.3	-19.7	46	36.39	18.1	2.49	30.68	-	-	Peak
700.4	24.6	-21.4	46	31.46	20.6	2.94	30.4	-	-	Peak
2411	101.18	-	-	96.22	32.31	6.95	34.3	181	359	Average
2411	110.63	-	-	105.67	32.31	6.95	34.3	181	359	Peak
4824	40.52	-33.48	74	56.71	33.97	8.77	58.93	100	0	Peak



Test Mode :	802.11n HT20	Temperature :	21~23°C
Test Channel :	01	Relative Humidity :	46~48%
Test Engineer :	Stan Hsieh	Polarization :	Vertical
Remark :	1. 2412 MHz is fundamental signal which can be ignored. 2. Average measurement was not performed if peak level went lower than the average limit.		

Frequency (MHz)	Level (dBμV/m)	Over Limit (dB)	Limit Line (dBμV/m)	Read Level (dBμV)	Antenna Factor (dB)	Cable Loss (dB)	Preamp Factor (dB)	Ant Pos (cm)	Table Pos (deg)	Remark
31.35	24.81	-15.19	40	37.41	18.28	0.54	31.42	156	221	Peak
76.44	22.68	-17.32	40	46.15	6.87	0.86	31.2	-	-	Peak
171.21	13.08	-30.42	43.5	33.39	9.54	1.23	31.08	-	-	Peak
309.1	25.09	-20.91	46	41.01	13.29	1.79	31	-	-	Peak
489	23.11	-22.89	46	33.54	17.87	2.41	30.71	-	-	Peak
700.4	26.98	-19.02	46	33.84	20.6	2.94	30.4	-	-	Peak
2412	92.69	-	-	87.73	32.31	6.95	34.3	126	304	Average
2412	102.8	-	-	97.84	32.31	6.95	34.3	126	304	Peak
4824	39.75	-34.25	74	55.94	33.97	8.77	58.93	100	0	Peak



Test Mode :	802.11n HT20	Temperature :	21~23°C
Test Channel :	06	Relative Humidity :	46~48%
Test Engineer :	Stan Hsieh	Polarization :	Horizontal
Remark :	1. 2436 MHz is fundamental signal which can be ignored. 2. Average measurement was not performed if peak level went lower than the average limit.		

Frequency (MHz)	Level (dBμV/m)	Over Limit (dB)	Limit Line (dBμV/m)	Read Level (dBμV)	Antenna Factor (dB)	Cable Loss (dB)	Preamp Factor (dB)	Ant Pos (cm)	Table Pos (deg)	Remark
2436	102.02	-	-	97.05	32.33	6.99	34.35	180	331	Average
2436	111.56	-	-	106.59	32.33	6.99	34.35	180	331	Peak
4874	39.67	-34.33	74	55.73	33.95	8.82	58.83	100	0	Peak
7311	43.14	-30.86	74	54.42	35.54	10.91	57.73	100	0	Peak

Test Mode :	802.11n HT20	Temperature :	21~23°C
Test Channel :	06	Relative Humidity :	46~48%
Test Engineer :	Stan Hsieh	Polarization :	Vertical
Remark :	1. 2438 MHz is fundamental signal which can be ignored. 2. Average measurement was not performed if peak level went lower than the average limit.		

Frequency (MHz)	Level (dBμV/m)	Over Limit (dB)	Limit Line (dBμV/m)	Read Level (dBμV)	Antenna Factor (dB)	Cable Loss (dB)	Preamp Factor (dB)	Ant Pos (cm)	Table Pos (deg)	Remark
2438	93.4	-	-	88.41	32.35	6.99	34.35	125	306	Average
2438	102.9	-	-	97.91	32.35	6.99	34.35	125	306	Peak
4875	39.37	-34.63	74	55.43	33.95	8.82	58.83	100	0	Peak
7311	42.63	-31.37	74	53.91	35.54	10.91	57.73	100	0	Peak



Test Mode :	802.11n HT20	Temperature :	21~23°C
Test Channel :	11	Relative Humidity :	46~48%
Test Engineer :	Stan Hsieh	Polarization :	Horizontal
Remark :	1. 2461 MHz is fundamental signal which can be ignored. 2. Average measurement was not performed if peak level went lower than the average limit.		

Frequency (MHz)	Level (dBμV/m)	Over Limit (dB)	Limit Line (dBμV/m)	Read Level (dBμV)	Antenna Factor (dB)	Cable Loss (dB)	Preamp Factor (dB)	Ant Pos (cm)	Table Pos (deg)	Remark
2461	101.75	-	-	96.75	32.37	7.02	34.39	178	5	Average
2461	111.64	-	-	106.64	32.37	7.02	34.39	178	5	Peak
4923	41.35	-32.65	74	57.28	33.93	8.87	58.73	100	0	Peak
7386	41.69	-32.31	74	52.98	35.52	10.99	57.8	100	0	Peak

Test Mode :	802.11n HT20	Temperature :	21~23°C
Test Channel :	11	Relative Humidity :	46~48%
Test Engineer :	Stan Hsieh	Polarization :	Vertical
Remark :	1. 2461 MHz is fundamental signal which can be ignored. 2. Average measurement was not performed if peak level went lower than the average limit.		

Frequency (MHz)	Level (dBμV/m)	Over Limit (dB)	Limit Line (dBμV/m)	Read Level (dBμV)	Antenna Factor (dB)	Cable Loss (dB)	Preamp Factor (dB)	Ant Pos (cm)	Table Pos (deg)	Remark
2461	92.39	-	-	87.39	32.37	7.02	34.39	100	307	Average
2461	102.41	-	-	97.41	32.37	7.02	34.39	100	307	Peak
4923	40.66	-33.34	74	56.59	33.93	8.87	58.73	100	0	Peak
7386	42.7	-31.3	74	53.99	35.52	10.99	57.8	100	0	Peak



Test Mode :	802.11n HT40	Temperature :	21~23°C
Test Channel :	01	Relative Humidity :	46~48%
Test Engineer :	Stan Hsieh	Polarization :	Horizontal
Remark :	1. 2421 MHz is fundamental signal which can be ignored. 2. Average measurement was not performed if peak level went lower than the average limit.		

Frequency (MHz)	Level (dBμV/m)	Over Limit (dB)	Limit Line (dBμV/m)	Read Level (dBμV)	Antenna Factor (dB)	Cable Loss (dB)	Preamp Factor (dB)	Ant Pos (cm)	Table Pos (deg)	Remark
2421	96.21	-	-	91.28	32.33	6.95	34.35	154	355	Average
2421	106.14	-	-	101.21	32.33	6.95	34.35	154	355	Peak
4845	40.6	-33.4	74	56.73	33.96	8.8	58.89	100	0	Peak
7266	41.34	-32.66	74	52.63	35.54	10.86	57.69	100	0	Peak

Test Mode :	802.11n HT40	Temperature :	21~23°C
Test Channel :	01	Relative Humidity :	46~48%
Test Engineer :	Stan Hsieh	Polarization :	Vertical
Remark :	1. 2424 MHz is fundamental signal which can be ignored. 2. Average measurement was not performed if peak level went lower than the average limit.		

Frequency (MHz)	Level (dBμV/m)	Over Limit (dB)	Limit Line (dBμV/m)	Read Level (dBμV)	Antenna Factor (dB)	Cable Loss (dB)	Preamp Factor (dB)	Ant Pos (cm)	Table Pos (deg)	Remark
2424	89.89	-	-	84.96	32.33	6.95	34.35	102	303	Average
2424	99.63	-	-	94.7	32.33	6.95	34.35	102	303	Peak
4845	40.71	-33.29	74	56.84	33.96	8.8	58.89	100	0	Peak
7266	41.48	-32.52	74	52.77	35.54	10.86	57.69	100	0	Peak



Test Mode :	802.11n HT40	Temperature :	21~23°C
Test Channel :	06	Relative Humidity :	46~48%
Test Engineer :	Stan Hsieh	Polarization :	Horizontal
Remark :	1. 2436 MHz is fundamental signal which can be ignored. 2. Average measurement was not performed if peak level went lower than the average limit.		

Frequency (MHz)	Level (dBμV/m)	Over Limit (dB)	Limit Line (dBμV/m)	Read Level (dBμV)	Antenna Factor (dB)	Cable Loss (dB)	Preamp Factor (dB)	Ant Pos (cm)	Table Pos (deg)	Remark
2436	99.12	-	-	94.15	32.33	6.99	34.35	179	334	Average
2436	108.75	-	-	103.78	32.33	6.99	34.35	179	334	Peak
4875	39.59	-34.41	74	55.65	33.95	8.82	58.83	100	0	Peak
7311	42.62	-31.38	74	53.9	35.54	10.91	57.73	100	0	Peak

Test Mode :	802.11n HT40	Temperature :	21~23°C
Test Channel :	06	Relative Humidity :	46~48%
Test Engineer :	Stan Hsieh	Polarization :	Vertical
Remark :	1. 2435 MHz is fundamental signal which can be ignored. 2. Average measurement was not performed if peak level went lower than the average limit.		

Frequency (MHz)	Level (dBμV/m)	Over Limit (dB)	Limit Line (dBμV/m)	Read Level (dBμV)	Antenna Factor (dB)	Cable Loss (dB)	Preamp Factor (dB)	Ant Pos (cm)	Table Pos (deg)	Remark
2435	90.2	-	-	85.23	32.33	6.99	34.35	103	305	Average
2435	100.13	-	-	95.16	32.33	6.99	34.35	103	305	Peak
4875	39.03	-34.97	74	55.09	33.95	8.82	58.83	100	0	Peak
7311	42.92	-31.08	74	54.2	35.54	10.91	57.73	100	0	Peak



Test Mode :	802.11n HT40	Temperature :	21~23°C
Test Channel :	09	Relative Humidity :	46~48%
Test Engineer :	Stan Hsieh	Polarization :	Horizontal
Remark :	1. 2454 MHz is fundamental signal which can be ignored. 2. Average measurement was not performed if peak level went lower than the average limit.		

Frequency (MHz)	Level (dBμV/m)	Over Limit (dB)	Limit Line (dBμV/m)	Read Level (dBμV)	Antenna Factor (dB)	Cable Loss (dB)	Preamp Factor (dB)	Ant Pos (cm)	Table Pos (deg)	Remark
2454	97.68	-	-	92.68	32.37	7.02	34.39	179	343	Average
2454	107.8	-	-	102.8	32.37	7.02	34.39	179	343	Peak
4905	40.52	-33.48	74	56.48	33.93	8.87	58.76	100	0	Peak
7356	43.14	-30.86	74	54.42	35.53	10.96	57.77	100	0	Peak

Test Mode :	802.11n HT40	Temperature :	21~23°C
Test Channel :	11	Relative Humidity :	46~48%
Test Engineer :	Stan Hsieh	Polarization :	Vertical
Remark :	1. 2451 MHz is fundamental signal which can be ignored. 2. Average measurement was not performed if peak level went lower than the average limit.		

Frequency (MHz)	Level (dBμV/m)	Over Limit (dB)	Limit Line (dBμV/m)	Read Level (dBμV)	Antenna Factor (dB)	Cable Loss (dB)	Preamp Factor (dB)	Ant Pos (cm)	Table Pos (deg)	Remark
2451	87.53	-	-	82.58	32.35	6.99	34.39	125	306	Average
2451	97.6	-	-	92.65	32.35	6.99	34.39	125	306	Peak
4905	40.14	-33.86	74	56.1	33.93	8.87	58.76	100	0	Peak
7356	42.81	-31.19	74	54.09	35.53	10.96	57.77	100	0	Peak

3.6 AC Conducted Emission Measurement

3.6.1 Limit of AC Conducted Emission

For equipment that is designed to be connected to the public utility (AC) power line, the radio frequency voltage that is conducted back onto the AC power line on any frequency or frequencies within the band 150 kHz to 30 MHz shall not exceed the limits in the following table.

Frequency of Emission (MHz)	Conducted Limit (dB μ V)	
	Quasi-Peak	Average
0.15-0.5	66 to 56*	56 to 46*
0.5-5	56	46
5-30	60	50

*Decreases with the logarithm of the frequency.

3.6.2 Measuring Instruments

The measuring equipment is listed in the section 4 of this test report.

3.6.3 Test Procedures

1. The EUT was placed 0.4 meter from the conducting wall of the shielding room, and it was kept at least 80 centimeters from any other grounded conducting surface.
2. Connect EUT to the power mains through a line impedance stabilization network (LISN).
3. All the support units are connecting to the other LISN.
4. The LISN provides 50 ohm coupling impedance for the measuring instrument.
5. The FCC states that a 50 ohm, 50 microhenry LISN should be used.
6. Both sides of AC line were checked for maximum conducted interference.
7. The frequency range from 150 kHz to 30 MHz was searched.
8. Set the test-receiver system to Peak Detect Function and specified bandwidth with Maximum Hold Mode.

3.6.4 Test Setup

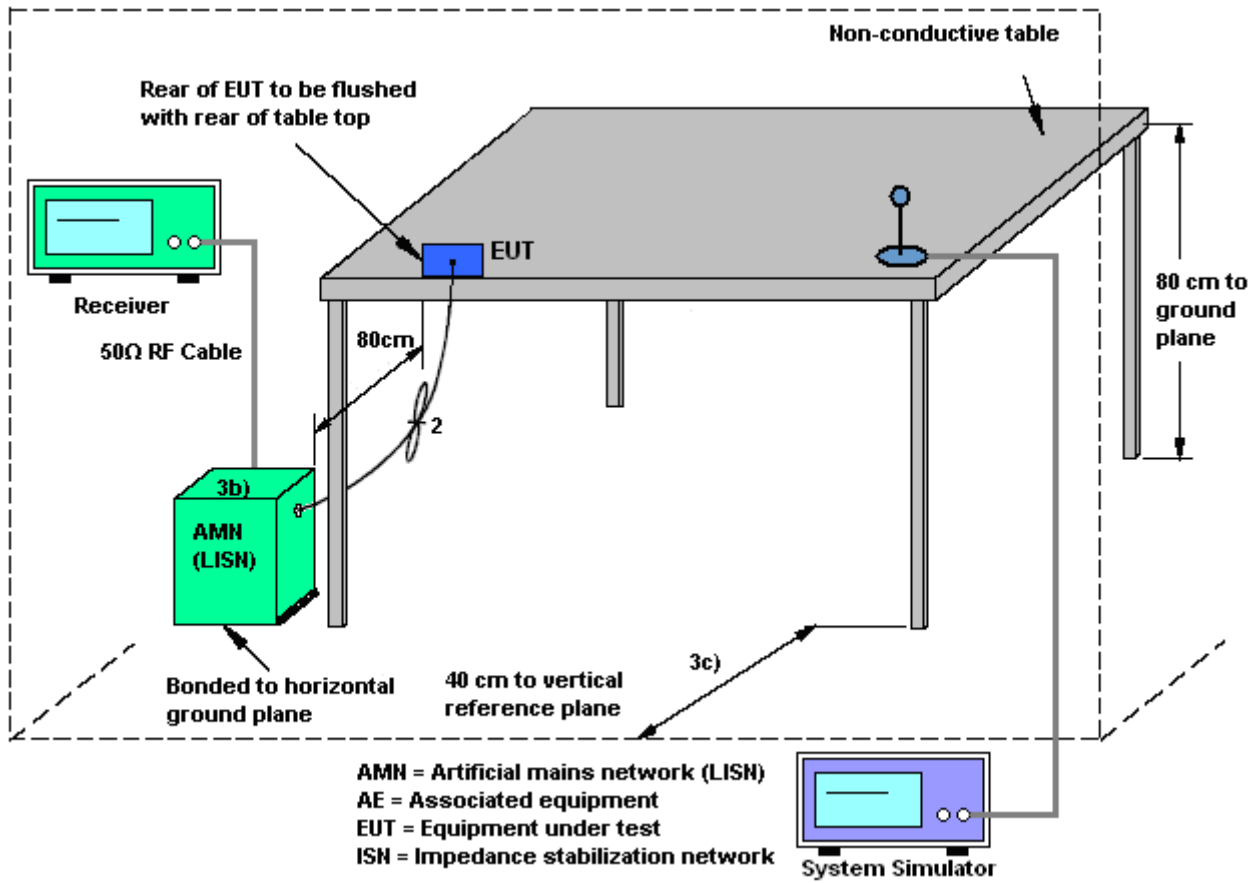

3.6.5 Test Result of AC Conducted Emission

Test Mode :	Mode 1	Temperature :	20~22°C
Test Engineer :	Cosmo Xu	Relative Humidity :	45~47%
Test Voltage :	120Vac / 60Hz	Phase :	Line
Function Type :	LTE Band 41 Idle + WLAN Link + RJ-45 Link + VOIP + Adapter		

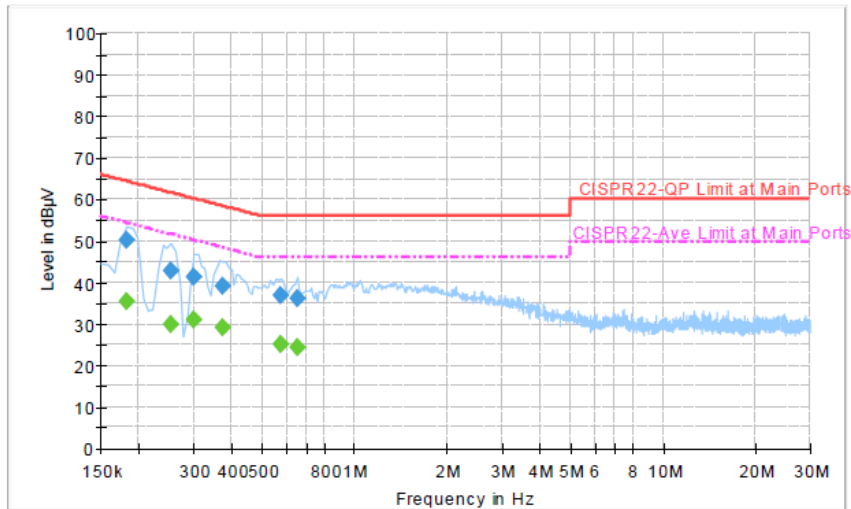

Final Result : QuasiPeak

Frequency (MHz)	QuasiPeak (dBµV)	Filter	Line	Corr. (dB)	Margin (dB)	Limit (dBµV)
0.182000	50.1	Off	L1	19.4	14.3	64.4
0.254000	42.6	Off	L1	19.6	19.0	61.6
0.302000	41.5	Off	L1	19.5	18.7	60.2
0.374000	38.9	Off	L1	19.6	19.5	58.4
0.574000	36.8	Off	L1	19.6	19.2	56.0
0.654000	36.1	Off	L1	19.6	19.9	56.0

Final Result : Average

Frequency (MHz)	Average (dBµV)	Filter	Line	Corr. (dB)	Margin (dB)	Limit (dBµV)
0.182000	35.6	Off	L1	19.4	18.8	54.4
0.254000	29.9	Off	L1	19.6	21.7	51.6
0.302000	31.0	Off	L1	19.5	19.2	50.2
0.374000	29.3	Off	L1	19.6	19.1	48.4
0.574000	25.0	Off	L1	19.6	21.0	46.0
0.654000	24.5	Off	L1	19.6	21.5	46.0



Test Mode :	Mode 1	Temperature :	20~22°C
Test Engineer :	Cosmo Xu	Relative Humidity :	45~47%
Test Voltage :	120Vac / 60Hz	Phase :	Neutral
Function Type :	LTE Band 41 Idle + WLAN Link + RJ-45 Link + VOIP + Adapter		

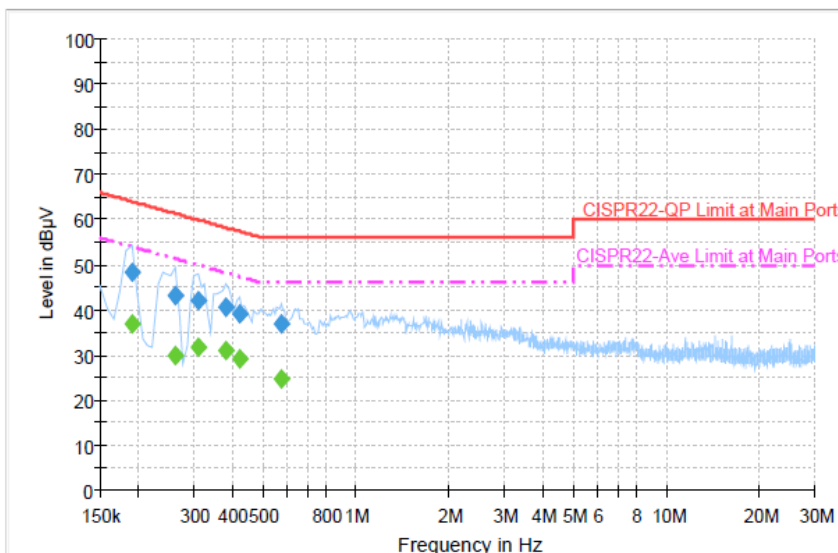

Final Result : QuasiPeak

Frequency (MHz)	QuasiPeak (dBµV)	Filter	Line	Corr. (dB)	Margin (dB)	Limit (dBµV)
0.190000	48.5	Off	N	19.4	15.5	64.0
0.262000	43.0	Off	N	19.6	18.4	61.4
0.310000	42.2	Off	N	19.5	17.8	60.0
0.382000	40.7	Off	N	19.6	17.5	58.2
0.422000	39.2	Off	N	19.6	18.2	57.4
0.574000	36.8	Off	N	19.6	19.2	56.0

Final Result : Average

Frequency (MHz)	Average (dBµV)	Filter	Line	Corr. (dB)	Margin (dB)	Limit (dBµV)
0.190000	37.0	Off	N	19.4	17.0	54.0
0.262000	30.0	Off	N	19.6	21.4	51.4
0.310000	31.9	Off	N	19.5	18.1	50.0
0.382000	30.8	Off	N	19.6	17.4	48.2
0.422000	29.0	Off	N	19.6	18.4	47.4
0.574000	24.6	Off	N	19.6	21.4	46.0

3.7 Antenna Requirements

3.7.1 Standard Applicable

If directional gain of transmitting Antennas is greater than 6dBi, the power shall be reduced by the same level in dB comparing to gain minus 6dBi. For the fixed point-to-point operation, the power shall be reduced by one dB for every 3 dB that the directional gain of the Antenna exceeds 6 dBi. The use of a permanently attached Antenna or of an Antenna that uses a unique coupling to the intentional radiator shall be considered sufficient to comply with the FCC rule.

3.7.2 Antenna Anti-Replacement Construction

An embedded-in antenna design is used.

3.7.3 Antenna Gain

FCC KDB 662911 D01 Multiple Transmitter Output v02r01.

For CDD transmissions, directional gain is calculated as

$$DirectionalGain = 10 \cdot \log \left[\frac{\sum_{j=1}^{N_{SS}} \left\{ \sum_{k=1}^{N_{ANT}} g_{j,k} \right\}^2}{N_{ANT}} \right]$$

where

Each antenna is driven by no more than one spatial stream;

N_{SS} = the number of independent spatial streams of data;

N_{ANT} = the total number of antennas

$g_{j,k} = 10^{G_k / 20}$ if the k th antenna is being fed by spatial stream j , or zero if it is not;

G_k is the gain in dBi of the k th antenna.



The EUT supports CDD mode.

The power and PSD limit should be modified if the directional gain of EUT is over 6 dBi,

The directional gain "DG" is calculated as following table.

			DG for Power (dBi)	DG for PSD (dBi)	Power Limit Reduction (dB)	PSD Limit Reduction (dB)
	Ant. 1 (dBi)	Ant. 2 (dBi)				
2.4 GHz	1.03	2.61	4.87	4.87	0.00	0.00

$$\text{Power Limit Reduction} = DG(\text{Power}) - 6\text{dBi}, (\text{min} = 0)$$

$$\text{PSD Limit Reduction} = DG(\text{PSD}) - 6\text{dBi}, (\text{min} = 0)$$



4 List of Measuring Equipment

Instrument	Manufacturer	Model No.	Serial No.	Characteristics	Calibration Date	Test Date	Due Date	Remark
Spectrum Analyzer	Rohde & Schwarz	FSP40	100055	9kHz~40GHz	Jun. 07, 2013	Feb. 17, 2014~ Feb. 21, 2014	Jun. 06, 2014	Conducted (TH02-HY)
Power Meter	Anritsu	ML2495A	1036004	300MHz~40GHz	Aug. 17, 2013	Feb. 17, 2014~ Feb. 21, 2014	Aug. 16, 2014	Conducted (TH02-HY)
Power Sensor	Anritsu	MA2411B	1027253	300MHz~40GHz	Aug. 17, 2013	Feb. 17, 2014~ Feb. 21, 2014	Aug. 16, 2014	Conducted (TH02-HY)
EMI Test Receiver	Rohde & Schwarz	ESCS 30	100356	9kHz ~ 2.75GHz	Nov. 15, 2013	Feb. 20, 2014	Nov. 14, 2014	Conduction (CO05-HY)
LISN (for auxiliary equipment)	Rohde & Schwarz	ENV216	100081	9kHz ~ 30MHz	Dec. 12, 2013	Feb. 20, 2014	Dec. 11, 2014	Conduction (CO05-HY)
LISN	Rohde & Schwarz	ENV216	100080	9kHz ~ 30MHz	Dec. 04, 2013	Feb. 20, 2014	Dec. 03, 2014	Conduction (CO05-HY)
AC Power Source	ChainTek	APC-1000W	N/A	N/A	N/A	Feb. 20, 2014	N/A	Conduction (CO05-HY)
EMI Test Receiver	Rohde & Schwarz	ESCI 7	100724	9 kHz~7 GHz	Sep. 06, 2013	Feb. 20, 2014~ Feb. 21, 2014	Sep. 05, 2014	Radiation (03CH07-HY)
Spectrum Analyzer	Rohde & Schwarz	FSP30	101067	9 kHz ~ 30 GHz	Nov. 20, 2013	Feb. 20, 2014~ Feb. 21, 2014	Nov. 19, 2014	Radiation (03CH07-HY)
Loop Antenna	Rohde & Schwarz	HFH2-Z2	860004/00 01	9 kHz~30 MHz	Jul. 03, 2012	Feb. 20, 2014~ Feb. 21, 2014	Jul. 03, 2014	Radiation (03CH07-HY)
Bilog Antenna	Schaffner	CBL6111C	2726	30 MHz ~ 1 GHz	Oct. 10, 2013	Feb. 20, 2014~ Feb. 21, 2014	Oct. 09, 2014	Radiation (03CH07-HY)
Double Ridge Horn Antenna	ESCO	3117	75962	1 GHz~18 GHz	Aug. 22, 2013	Feb. 20, 2014~ Feb. 21, 2014	Aug. 21, 2014	Radiation (03CH07-HY)
SHF-EHF Horn Antenna	SCHWARZBECK	BBHA 9170	BBHA9170 251	15 GHz- 40 GHz	Oct. 03, 2013	Feb. 20, 2014~ Feb. 21, 2014	Oct. 02, 2014	Radiation (03CH07-HY)
Preamplifier	COM-POWER	PA-103A	161241	30 MHz~1 GHz	Feb. 26, 2013	Feb. 20, 2014~ Feb. 21, 2014	Feb. 25, 2014	Radiation (03CH07-HY)
Preamplifier	Agilent	8449B	3008A023 62	1 GHz~26.5 GHz	Nov. 29, 2013	Feb. 20, 2014~ Feb. 21, 2014	Nov. 28, 2014	Radiation (03CH07-HY)
Preamplifier	MITEQ	AMF-7D-0010 1800-30-10P	159088	DC~18 G High Gain	Feb. 27, 2013	Feb. 20, 2014~ Feb. 21, 2014	Feb. 26, 2014	Radiation (03CH07-HY)
Turn Table	ChainTek	ChainTek 3000	N/A	0 ~ 360 degree	N/A	Feb. 20, 2014~ Feb. 21, 2014	N/A	Radiation (03CH07-HY)
Antenna Mast	ChainTek	ChainTek 3000	N/A	N/A	N/A	Feb. 20, 2014~ Feb. 21, 2014	N/A	Radiation (03CH07-HY)



5 Uncertainty of Evaluation

Uncertainty of Conducted Emission Measurement (150kHz ~ 30MHz)

Measuring Uncertainty for a Level of Confidence of 95% ($U = 2Uc(y)$)	2.26
---	------

Uncertainty of Radiated Emission Measurement (30 MHz ~ 1000 MHz)

Measuring Uncertainty for a Level of Confidence of 95% ($U = 2Uc(y)$)	4.50
---	------

