



EMC TEST REPORT

Applicant Green Packet Berhad, Taiwan
FCC ID W9V-DH725-GP
Product DH-725 LTE Cat. 6 Wi-Fi Router
Brand Greenpacket
Model DH-725
Report No. R1805A0242-E1V2
Issue Date July 25, 2018

TA Technology (Shanghai) Co., Ltd. tested the above equipment in accordance with the requirements in **FCC Code CFR47 Part15B (2017)/ ANSI C63.4 (2014)**. The test results show that the equipment tested is capable of demonstrating compliance with the requirements as documented in this report.

Wei Liu

Guangchang Fan

Performed by: Wei Liu/ Manager

Approved by: Guangchang Fan/ Director

TA Technology (Shanghai) Co., Ltd.

No.145, Jintang Rd, Tangzhen Industry Park, Pudong Shanghai, China

TEL: +86-021-50791141/2/3

FAX: +86-021-50791141/2/3-8000



Table of Contents

1	Test Laboratory.....	4
1.1	Notes of the Test Report.....	4
1.2	Test facility.....	4
1.3	Testing Location.....	5
2	General Description of Equipment under Test.....	6
2.1	Client Information.....	6
2.2	General information.....	6
2.3	Applied Standards.....	7
2.4	Test Mode.....	8
3	Test Case Results.....	9
3.1	Radiated Emission.....	9
3.2	Conducted Emission.....	15
4	Main Test Instrument.....	17
	ANNEX A: The EUT Appearance and Test Configuration.....	18
	A.1 EUT Appearance.....	18
	A.2 Test Setup.....	20



Summary of measurement results

Number	Test Case	Clause in FCC Rules	Conclusion
1	Radiated Emission	15.109, ANSI C63.4-2014	PASS
2	Conducted Emission	15.107, ANSI C63.4-2014	PASS
Test Date: June 9, 2018~ June 22, 2018			

1 Test Laboratory

1.1 Notes of the Test Report

This report shall not be reproduced in full or partial, without the written approval of **TA technology (shanghai) co., Ltd.** The results documented in this report apply only to the tested sample, under the conditions and modes of operation as described herein .Measurement Uncertainties were not taken into account and are published for informational purposes only. This report is written to support regulatory compliance of the applicable standards stated above.

1.2 Test facility

CNAS (accreditation number: L2264)

TA Technology (Shanghai) Co., Ltd. has obtained the accreditation of China National Accreditation Service for Conformity Assessment (CNAS).

FCC (Designation number: CN1179, Test Firm Registration Number: 446626)

TA Technology (Shanghai) Co., Ltd. has been listed on the US Federal Communications Commission list of test facilities recognized to perform electromagnetic emissions measurements.

IC (recognition number is 8510A)

TA Technology (Shanghai) Co., Ltd. has been listed by industry Canada to perform electromagnetic emission measurement.

VCCI (recognition number is C-4595, T-2154, R-4113, G-10766)

TA Technology (Shanghai) Co., Ltd. has been listed by industry Japan to perform electromagnetic emission measurement.

A2LA (Certificate Number: 3857.01)

TA Technology (Shanghai) Co., Ltd. has been listed by American Association for Laboratory Accreditation to perform electromagnetic emission measurement.



1.3 Testing Location

Company: TA Technology (Shanghai) Co., Ltd.
Address: No.145, Jintang Rd, Tangzhen Industry Park, Pudong Shanghai, China
City: Shanghai
Post code: 201201
Country: P. R. China
Contact: Xu Kai
Telephone: +86-021-50791141/2/3
Fax: +86-021-50791141/2/3-8000
Website: <http://www.ta-shanghai.com>
E-mail: xukai@ta-shanghai.com

2 General Description of Equipment under Test

2.1 Client Information

Applicant	Green Packet Berhad, Taiwan
Applicant address	6F, No.21, Lane 583, Rueiguang Rd. Neihu District, Taipei City 11492, Taiwan
Manufacturer	Green Packet Berhad, Taiwan
Manufacturer address	6F, No.21, Lane 583, Rueiguang Rd. Neihu District, Taipei City 11492, Taiwan

2.2 General information

EUT Description			
Device Type:	Movable Device		
Model Number:	DH-725		
IMEI:	351918068962628		
HW Version:	V2.1		
SW Version:	MG6_0.3.2.14_V1.0-IDU-GP		
Antenna Type:	Internal Antenna		
Frequency:		TX:	RX:
	LTE Band 41:	2496MHz~ 2690MHz	2496MHz~ 2690MHz
	LTE Band 43:	3600MHz~ 3800MHz	3600MHz~ 3800MHz
	WIFI 2.4G:	2400MHz ~ 2483.5MHz	2400MHz ~ 2483.5MHz
Modulation:	LTE: QPSK / 16QAM WLAN 802.11b: DSSS WLAN 802.11g/n: OFDM		
Test Mode:	Transfer Data mode		
EUT Accessory			
Adapter	Manufacturer: AQUIL STAR PRECISION INDUSTRIAL(SHENZHEN) CO.,LTD Model: ASSA65A-120100		
Auxiliary test equipment			
PC	PC Manufacturer: Dell Model: E5430 (SN : R98M9 A02)		
Note: The information of the EUT is declared by the manufacturer.			



2.3 Applied Standards

According to the specifications of the manufacturer, it must comply with the requirements of the following standards:

Test standards

FCC Code CFR47 Part15B (2017)

ANSI C63.4 (2014)

2.4 Test Mode

Test Mode	
Transfer Data mode:	Adapter + LAN cable + PC+ Idle,

During the test, EUT is connected to a PC via a LAN cable in the case of Transfer Data mode. The data is transferred from EUT to PC.

3 Test Case Results

3.1 Radiated Emission

Ambient condition

Temperature	Relative humidity	Pressure
24°C~26°C	45%~50%	102.5kPa

Methods of Measurement

The EUT is placed on a non-metallic table 0.8m above the horizontal metal reference ground plane. The distance between EUT and receive antenna should be 3 meters. During the test, the EUT was operating in its typical mode. The test method is according to ANSI C63.4-2014. Sweep the whole frequency band through the range from 30MHz to the 5th harmonic of the carrier. During the test, the height of receive antenna shall be moved from 1 to 4 meters, and the antenna shall be performed under horizontal and vertical polarization. The turn table shall be rotated from 0 to 360 degrees for detecting the maximum of radiated signal level.

The data of cable loss and antenna factor has been calibrated in full testing frequency range before the testing. During the test, the EUT is worked at maximum output power.

Set the spectrum analyzer in the following:

Below 1GHz:

RBW=100 kHz / VBW=300 kHz / Sweep=AUTO

Above 1GHz:

(a) PEAK: RBW=1MHz / VBW=3MHz/ Sweep=AUTO

(b) AVERAGE: RBW=1MHz / VBW=1Hz / Sweep=AUTO

The radiated emission was measured in the following position: EUT stand-up position (Z axis), lie-down position (X, Y axis). The worst emission was found in stand-up position (Z axis) and the worst case was recorded.

Test Setup

Below 1GHz

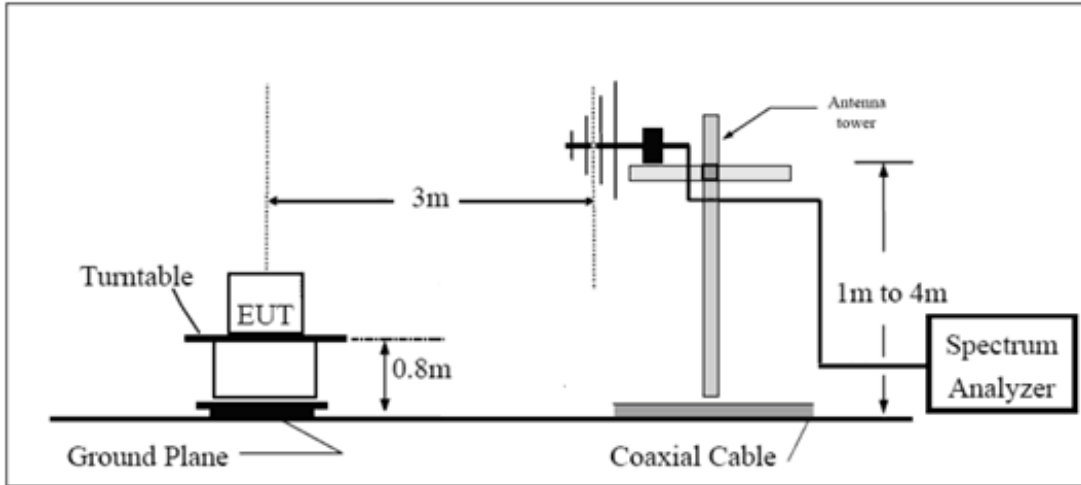

Above 1GHz

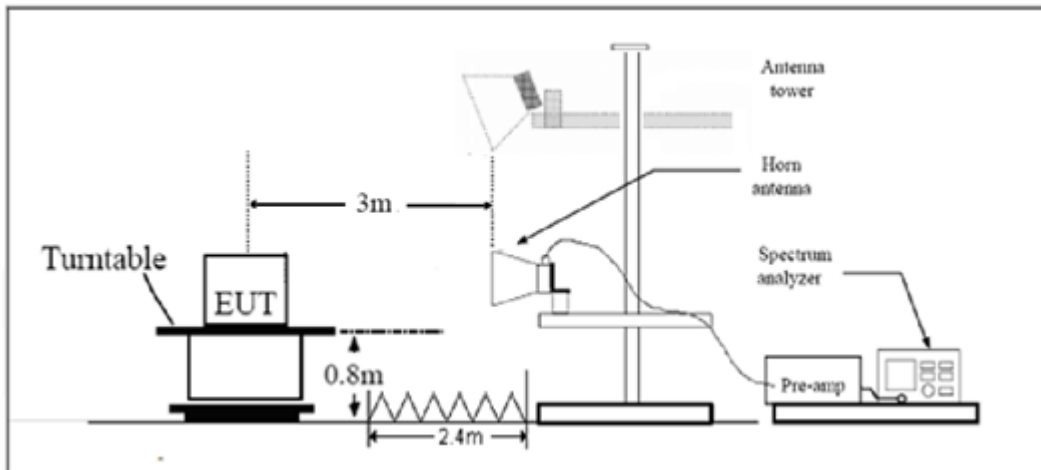

Note: Area side:2.4mX3.6m

Antenna Tower meets ANSI C63.4 requirements for measurements above 1 GHz by keeping the antenna aimed at the EUT during the antenna's ascent/ descent along the antenna mast.

Limits

Frequency (MHz)	Field Strength (dB μ V/m)	Detector
30 -88	40.0	Quasi-peak
88-216	43.5	Quasi-peak
216 – 960	46.0	Quasi-peak
960-1000	54.0	Quasi-peak
1000-5 th harmonic of the highest frequency or 40GHz, which is lower	54 74	Average Peak

Measurement Uncertainty

The assessed measurement uncertainty to ensure 95% confidence level for the normal distribution is with the coverage factor $k = 1.96$. $U = 3.704$ dB.

Test Results

The following graphs display the maximum values of horizontal and vertical by software.
 For above 1GHz, Blue trace uses the peak detection, Green trace uses the average detection.

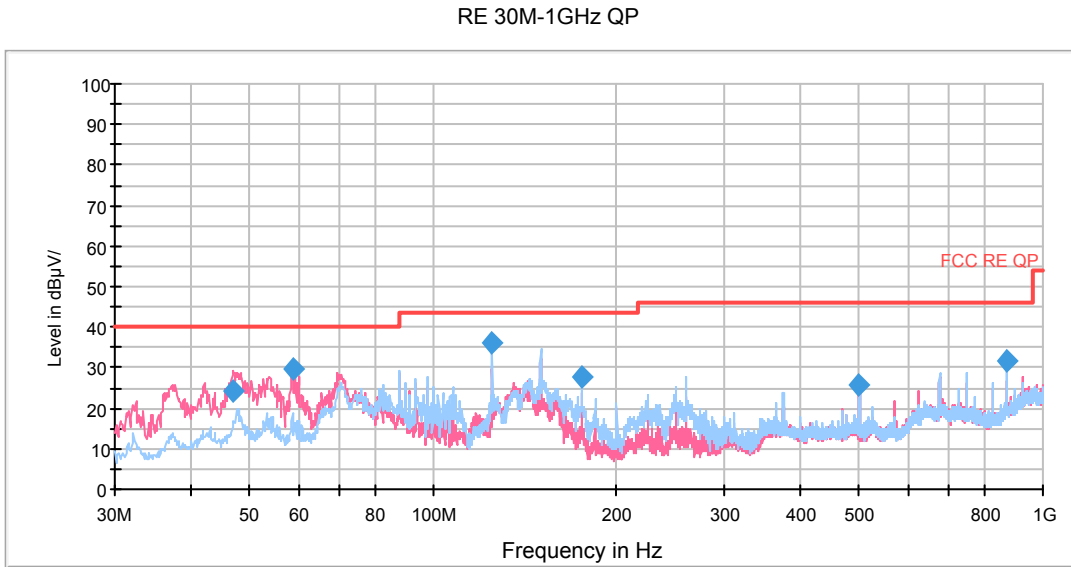

Radiated Emission from 30MHz to 1GHz

Frequency (MHz)	Quasi-Peak (dBuV/m)	Reading value (dBuV/m)	Height (cm)	Polarization	Azimuth (deg)	Correct Factor (dB)	Margin (dB)	Limit (dBuV/m)
46.970885	24.2	42.0	100.0	V	355.0	-17.8	15.8	40.0
58.709410	29.7	50.9	100.0	V	22.0	-21.2	10.3	40.0
124.986403	36.0	63.6	200.0	H	257.0	-27.6	7.5	43.5
175.017462	27.7	55.7	195.0	H	240.0	-28.0	15.8	43.5
499.996250	25.9	46.5	100.0	V	182.0	-20.6	20.1	46.0
875.044500	31.8	45.9	100.0	H	193.0	-14.1	14.2	46.0

- Remark:**
1. Quasi-Peak = Reading value + Correction factor
 2. Correction Factor = Antenna factor+ Insertion loss(cable loss+amplifier gain)
 3. Margin = Limit – Quasi-Peak

RE 1G-3GHz PK+AV

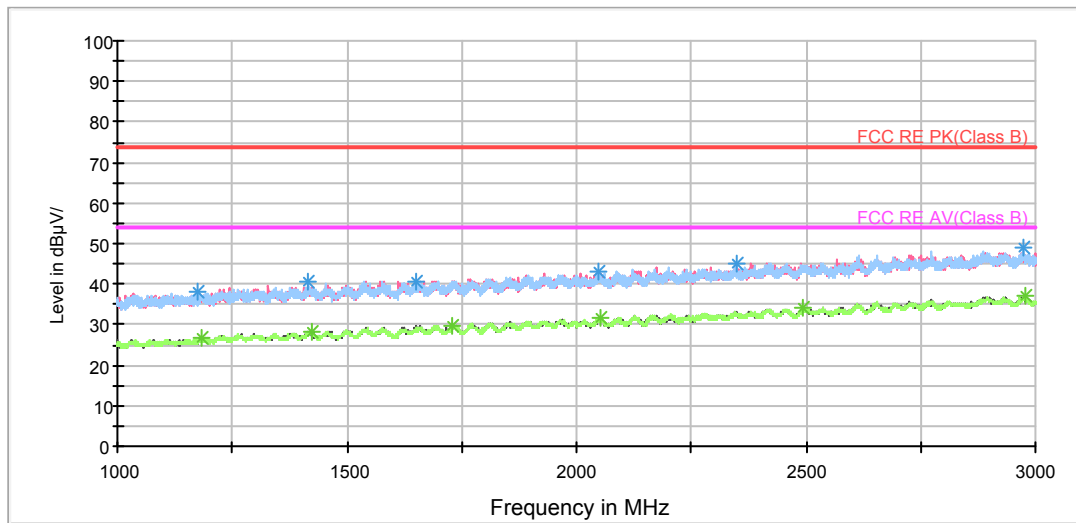

Radiated Emission from 1GHz to 3GHz

Frequency (MHz)	Peak (dBuV/m)	Reading value (dBuV/m)	Height (cm)	Polarization	Azimuth (deg)	Correct Factor (dB)	Margin (dB)	Limit (dBuV/m)
1175.250000	38.1	46.1	100.0	H	37.0	-8.0	35.9	74
1417.000000	40.4	47.4	100.0	H	112.0	-7.0	33.6	74
1651.500000	40.8	45.9	100.0	V	166.0	-5.1	33.2	74
2047.000000	42.9	46.1	200.0	H	344.0	-3.2	31.1	74
2349.250000	45.2	46.5	100.0	V	354.0	-1.3	28.8	74
2975.000000	49.0	46.8	200.0	H	264.0	2.2	25.0	74

Frequency (MHz)	Average (dBuV/m)	Reading value (dBuV/m)	Height (cm)	Polarization	Azimuth (deg)	Correct Factor (dB)	Margin (dB)	Limit (dBuV/m)
1185.500000	26.9	35.0	100.0	V	47.0	-8.1	27.1	54
1423.000000	28.1	35.0	100.0	H	66.0	-6.9	25.9	54
1730.750000	29.8	34.7	100.0	V	337.0	-4.9	24.2	54
2053.250000	31.5	34.7	200.0	V	0.0	-3.2	22.5	54
2492.750000	34.0	33.8	100.0	H	0.0	0.2	20.0	54
2976.500000	37.3	35.1	100.0	H	0.0	2.2	16.7	54

RE 3-18GHz PK+AV

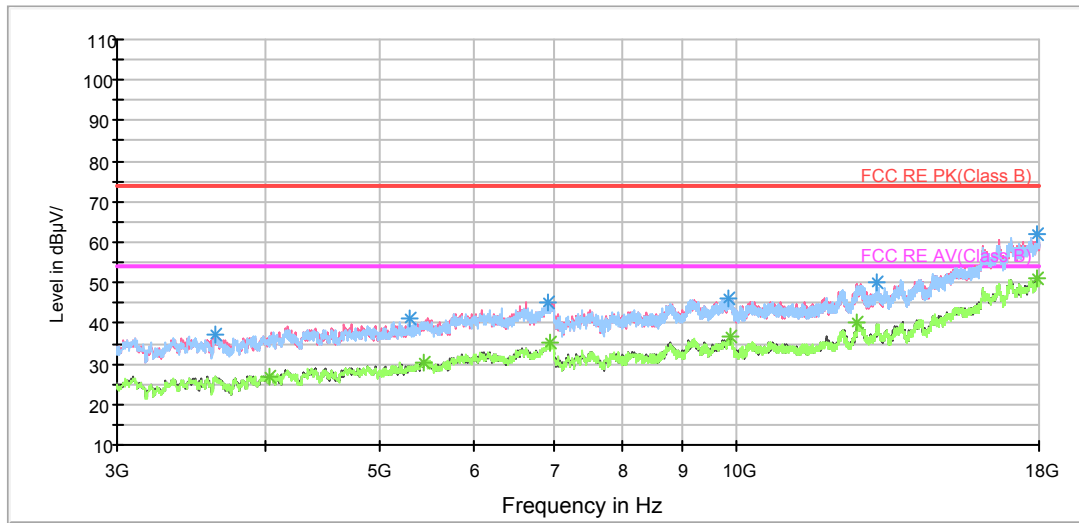

Radiated Emission from 3GHz to 18GHz

Frequency (MHz)	Peak (dBuV/m)	Reading value (dBuV/m)	Height (cm)	Polarization	Azimuth (deg)	Correct Factor (dB)	Margin (dB)	Limit (dBuV/m)
3631.875000	37.2	39.1	200.0	H	183.0	-1.9	36.8	74
5293.125000	41.0	38.7	100.0	H	107.0	2.3	33.0	74
6924.375000	45.4	39.2	100.0	V	107.0	6.2	28.6	74
9823.125000	46.3	36.4	100.0	H	172.0	9.9	27.7	74
13145.625000	50.2	35.9	100.0	H	183.0	14.3	23.8	74
17932.500000	61.8	36.5	100.0	V	185.0	25.3	12.2	74

Frequency (MHz)	Average (dBuV/m)	Reading value (dBuV/m)	Height (cm)	Polarization	Azimuth (deg)	Correct Factor (dB)	Margin (dB)	Limit (dBuV/m)
4038.750000	27.0	28.0	200.0	H	206.0	-1.0	27.0	54
5450.625000	30.5	27.7	100.0	V	271.0	2.8	23.5	54
6969.375000	35.0	28.7	200.0	V	0.0	6.3	19.0	54
9875.625000	36.6	26.3	200.0	V	177.0	10.3	17.4	54
12646.875000	40.0	25.7	100.0	V	325.0	14.3	14.0	54
17917.500000	51.3	25.6	100.0	V	293.0	25.7	2.7	54

3.2 Conducted Emission

Ambient condition

Temperature	Relative humidity	Pressure
24°C ~26°C	50%~55%	102.5kPa

Methods of Measurement

The EUT is placed on a non-metallic table of 80cm height above the horizontal metal reference ground plane. During the test, the EUT was operating in its typical mode. The test method is according to ANSI C63.4-2014. Connect the AC power line of the EUT to the L.I.S.N. Use EMI receiver to detect the average and Quasi-peak value. RBW is set to 9 kHz, VBW is set to 30kHz. The measurement result should include both L line and N line.

Test Setup

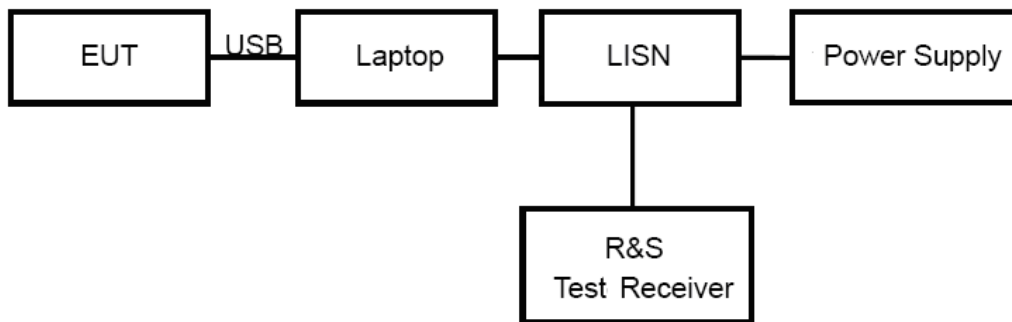

Note: Power Supply is AC Power source and it is used to change the voltage 120V/60Hz.

Limits

Frequency (MHz)	Conducted Limits(dBμV)	
	Quasi-peak	Average
0.15 - 0.5	66 to 56 *	56 to 46 *
0.5 - 5	56	46
5 - 30	60	50

*: Decreases with the logarithm of the frequency.

Measurement Uncertainty

The assessed measurement uncertainty to ensure 95% confidence level for the normal distribution is with the coverage factor $k = 1.96$. $U = 2.57$ dB.

Test Results

Following plots, Blue trace uses the peak detection; Green trace uses the average detection.

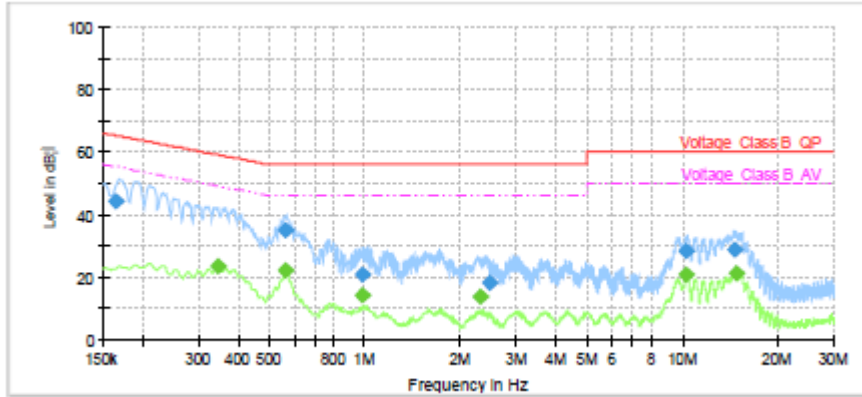

Frequency (MHz)	QuasiPeak (dB V)	Average (dB V)	Limit (dB V)	Margin (dB)	Meas. Time (ms)	Bandwidth (kHz)	Line	Filter	Corr. (dB)
0.163500	44.29	---	65.28	20.99	1000.0	9.000	L1	ON	19.1
0.345750	---	23.50	49.06	25.56	1000.0	9.000	L1	ON	19.2
0.564000	---	22.22	46.00	23.78	1000.0	9.000	L1	ON	19.3
0.564000	35.00	---	56.00	21.00	1000.0	9.000	L1	ON	19.3
0.984750	---	13.99	46.00	32.01	1000.0	9.000	L1	ON	19.2
0.984750	20.98	---	56.00	35.02	1000.0	9.000	L1	ON	19.2
2.305500	---	13.88	46.00	32.12	1000.0	9.000	L1	ON	19.0
2.474250	18.17	---	56.00	37.83	1000.0	9.000	L1	ON	19.0
10.295250	28.50	---	60.00	31.50	1000.0	9.000	L1	ON	19.4
10.315500	---	20.93	50.00	29.07	1000.0	9.000	L1	ON	19.4
14.637750	28.80	---	60.00	31.20	1000.0	9.000	L1	ON	19.5
14.723250	---	21.43	50.00	28.57	1000.0	9.000	L1	ON	19.5

L line

Conducted Emission from 150 KHz to 30 MHz

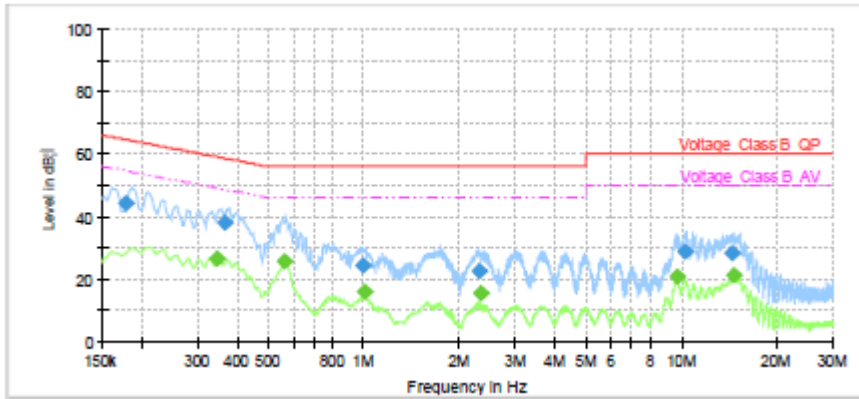

Frequency (MHz)	QuasiPeak (dB V)	Average (dB V)	Limit (dB V)	Margin (dB)	Meas. Time (ms)	Bandwidth (kHz)	Line	Filter	Corr. (dB)
0.177000	44.04	---	64.63	20.59	1000.0	9.000	N	ON	19.2
0.345750	---	26.48	49.06	22.59	1000.0	9.000	N	ON	19.2
0.366000	38.26	---	58.59	20.33	1000.0	9.000	N	ON	19.2
0.564000	---	25.88	46.00	20.12	1000.0	9.000	N	ON	19.3
0.991500	24.24	---	56.00	31.76	1000.0	9.000	N	ON	19.2
1.005000	---	16.03	46.00	29.97	1000.0	9.000	N	ON	19.2
2.314500	22.45	---	56.00	33.55	1000.0	9.000	N	ON	19.0
2.328000	---	15.30	46.00	30.71	1000.0	9.000	N	ON	19.0
9.658500	---	20.81	50.00	29.19	1000.0	9.000	N	ON	19.4
10.302000	28.95	---	60.00	31.05	1000.0	9.000	N	ON	19.4
14.514000	28.20	---	60.00	31.80	1000.0	9.000	N	ON	19.5
14.559000	---	21.04	50.00	28.96	1000.0	9.000	N	ON	19.5

N line

Conducted Emission from 150 KHz to 30 MHz

4 Main Test Instrument

Name	Manufacturer	Type	Serial Number	Last Cal.	Cal. Due Date
Signal Analyzer	R&S	FSV30	100815	2017-12-17	2018-12-16
EMI Test Receiver	R&S	ESCI	100948	2018-05-20	2019-05-19
Loop Antenna	SCHWARZBECK	FMZB1519	1519-047	2017-02-18	2019-02-17
Trilog Antenna	SCHWARZBECK	VULB 9163	9163-201	2017-11-18	2020-11-17
Horn Antenna	R&S	HF907	100126	2014-12-06	2019-12-05
Horn Antenna	ETS-Lindgren	3160-09	00102643	2015-01-30	2020-01-29
EMI Test Receiver	R&S	ESR	101667	2017-09-06	2018-09-05
LISN	R&S	ENV216	101171	2016-12-16	2019-12-15
Bore Sight Antenna mast	ETS	2171B	00058752	NA	NA
Test software	EMC32	R&S	V9.26.0	NA	NA

*****END OF REPORT *****

ANNEX A: The EUT Appearance and Test Configuration

A.1 EUT Appearance



a: EUT



b:Adapter
Picture 1 EUT

A.2 Test Setup

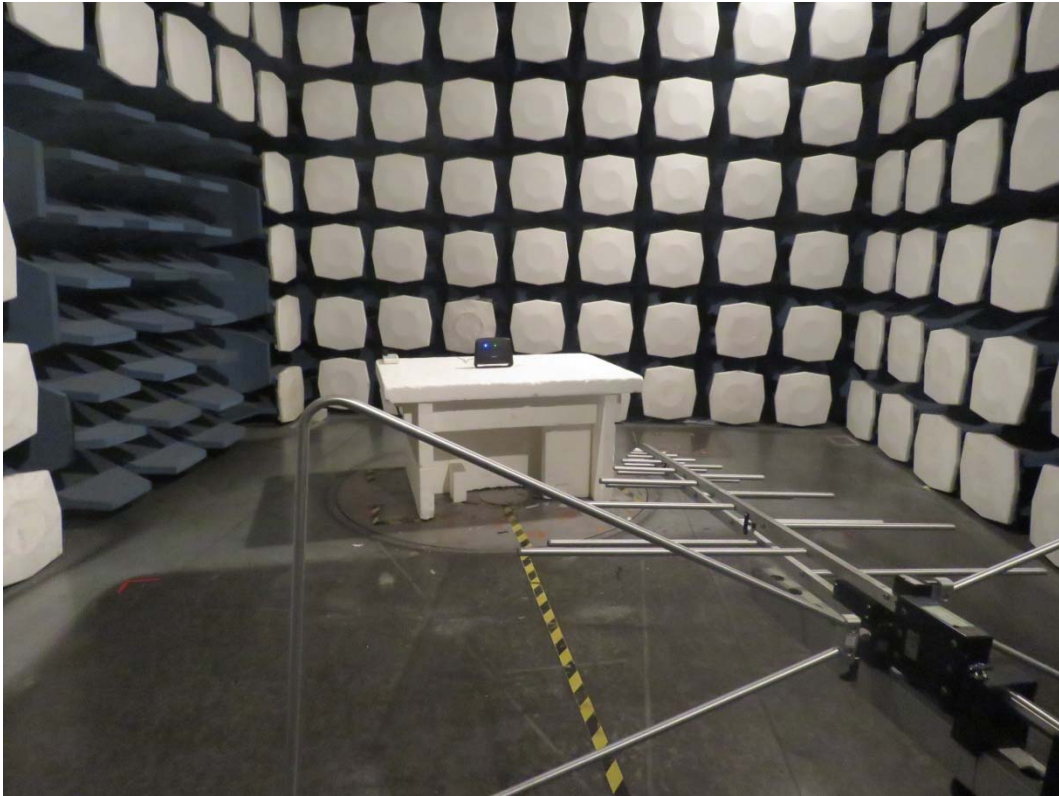

Below 1GHz

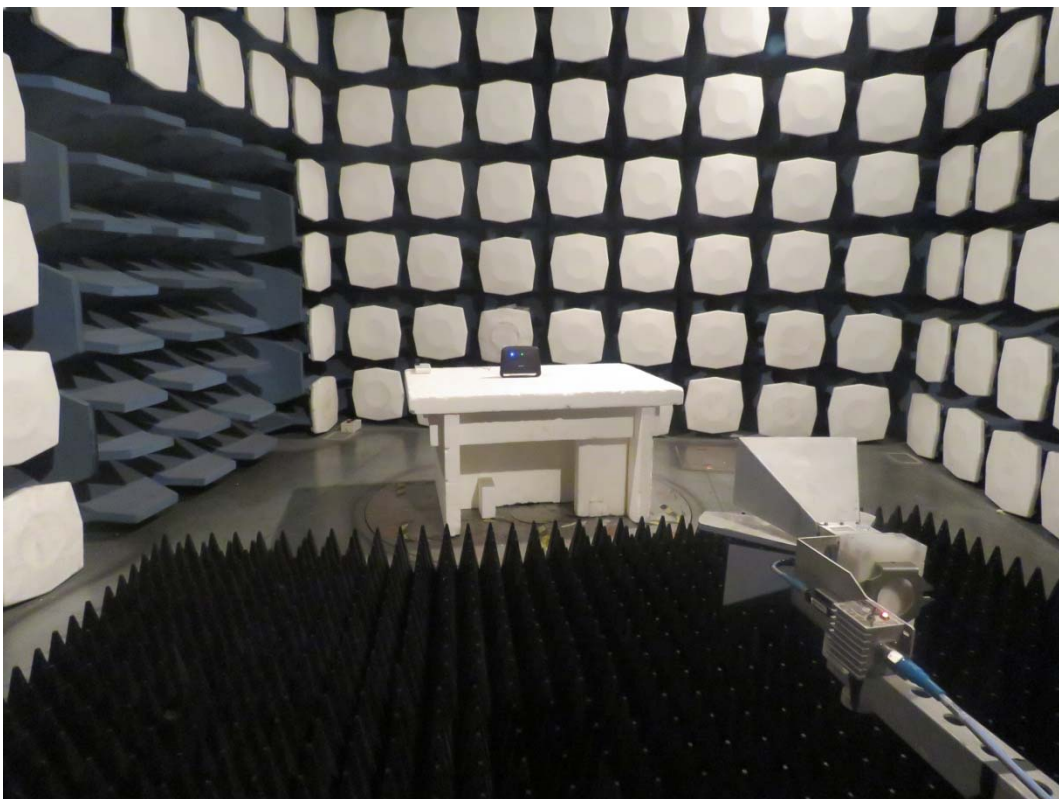

Above 1GHz

Picture 2 Radiated Emission Test Setup



Picture 3 Conducted Emission Test Setup