



**SAR Evaluation Report
for
FCC KDB Publication 616217 D04 SAR for laptop and
tablets v01r01 and 47CFR § 2.1093, RSS-102**

Report No.:SESF1410150

Client : Hisense Electric Co.,Ltd.
Product : Tablet PC
Model : F5281
FCC ID : W9HPADP0006
IC ID : 1068A-W9HPADP0006
Manufacturer/ supplier : Hisense Electric Co.,Ltd.
Test Date : November 05th,2014
Date of issue : November 07th,2014
Test Result : Compliance Not Compliance

Statement of Compliance:

The SAR values measured for the test sample are below the maximum recommended level of 1.6 W/kg averaged over any 1g tissue according to FCC KDBs and IEEE Std.1528-2013.

The test result only corresponds to the tested sample. It is not permitted to copy this report, in part or in full, without the permission of the test laboratory.

Total number of pages of this test report: 61 pages

The testing described in this report has been carried out to the best of our knowledge and ability, and our responsibility is limited to the exercise of reasonable care. This certification is not intended to believe the sellers from their legal and/or contractual obligations.

Test Engineer:

Leo Chen

Approved by:

Miro Chueh



Applicant Information

Client	:	Hisense Electric Co.,Ltd.
Address	:	No.218 Qianwangang Road, Economy & Technology Development Zone, Qingdao, China
Manufacturer	:	Hisense Electric Co.,Ltd.
Address	:	No.218 Qianwangang Road, Economy & Technology Development Zone, Qingdao, China
EUT	:	Tablet PC
Model No.	:	F5281
Standard Applied	:	FCC KDB Publication 616217 D04 SAR for laptop and tablets v01r01 and 47CFR § 2.1093, RSS-102
Laboratory	:	CERPASS TECHNOLOGY CORP. No.66, Tangzhuang Road, Suzhou Industrial Park, Jiangsu 215006, China.
SAR Test Result	:	Max. SAR measurement (1g) WLAN: 1.166W/kg Max. Simultaneous SAR (1g) WLAN+BT: 1.53 W/kg



Contents

1. General Information4

1.1. Executive Summary4

1.2. Description of Equipment under Test4

1.3. Channel List5

1.4. Antenna Location of the EUT and Feed Point translated onto this test device5

1.5. Simultaneous Transmission Configurations.....6

1.6. SAR Test Exclusions Applied6

1.7. Power Reduction for SAR6

1.8. Environment Condition.....6

1.9. Test Standards7

1.10. RF Exposure Limits.....7

2. The SAR Measurement Procedure8

2.1. System Performance Check8

2.2. Test Requirements 11

3. DASYS Measurement System 14

3.1. Uncertainty of Inter-/Extrapolation and Averaging 15

3.2. DASYS E-Field Probe 15

3.3. Data Acquisition Electronics (DAE) 16

3.4. Robot..... 16

3.5. Light Beam Unit 16

3.6. Measurement Server 17

3.7. SAM Phantom 17

3.8. Device Holder 18

3.9. Test Equipment List..... 19

3.10. Annual Internal Check of Impedance and Return Loss 20

4. Results 21

4.1. Summary of Test Results 21

4.2. Description for EUT test position 21

4.3. Conducted power (Averaged) 21

4.4. Estimated SAR for Bluetooth 22

4.5. SAR Test Results Summary..... 23

5. The Description of Test Procedure 24

5.1. General Notes: 24

5.2. Simultaneous Transmission Procedures 24

5.3. Simultaneous Transmission Analysis..... 25

5.4. Simultaneous Transmission Conclusion 25

6. Measurement Uncertainty 26

7. APPENDIX A. SAR System Verification Data..... 27

8. APPENDIX B. SAR measurement Data..... 28

8. APPENDIX C. EUT and Test Setup Photos 37

9. APPENDIX D. Probe Calibration Data 38

10. Appendix E. Dipole Calibration Data..... 49



1. General Information

1.1. Executive Summary

The EUT is a Tablet PC with operations in 2450MHz frequency ranges. It contains WIFI and BT functions for SAR testing. The measurement was conducted by CERPASS, carried out with the dosimetric assessment system under DASy5. And it conducts according to the IEEE Std. 1528-2013 and FCC KDBs for SAR evaluating compliance.

1.2. Description of Equipment under Test

Product Name	Tablet PC
Model No.	F5281
Software Version	F5281E1118B1V08
Channel Number	802.11b/g/n(20MHz): 11 802.11n(40MHz):7
Frequency Range	802.11b/g/n(20MHz): 2412~2462 MHz
Data Rate	802.11b: 1/2/5.5/11 Mbps 802.11g: 6/9/12/18/24/36/48/54 Mbps 802.11n: up to 150 Mbps
Tx Frequency	Wi-Fi :2412MHz to 2462MHz Bluetooth: 2402~2480MHz
Rx Frequency	Wi-Fi :2412MHz to 2462MHz Bluetooth: 2402~2480MHz
Type of Modulation	Wi-Fi: 802.11b: DSSS; 802.11g/n: OFDM
Antenna Type	FPCB
Peak Antenna Gain	3.3dBi
Device Category	Portable
RF Exposure Environment	General Population/ Uncontrolled
Max. Output Power(Average)	802.11b: 13.25dBm 802.11g: 12.37dBm 802.11n(20MHz): 10.87dBm



1.3. Channel List

802.11b/g/n(20MHz) Working Frequency of Each Channel							
Channel	Frequency	Channel	Frequency	Channel	Frequency	Channel	Frequency
01	2412MHz	02	2417MHz	03	2422MHz	04	2427MHz
05	2432MHz	06	2437MHz	07	2442MHz	08	2447MHz
09	2452MHz	10	2457MHz	11	2462MHz	N/A	N/A

802.11n(40MHz) Working Frequency of Each Channel							
Channel	Frequency	Channel	Frequency	Channel	Frequency	Channel	Frequency
03	2422MHz	04	2427MHz	05	2432MHz	06	2437MHz
07	2442MHz	08	2447MHz	09	2452MHz	N/A	N/A

1.4. Antenna Location of the EUT and Feed Point translated onto this test device

Rear of EUT

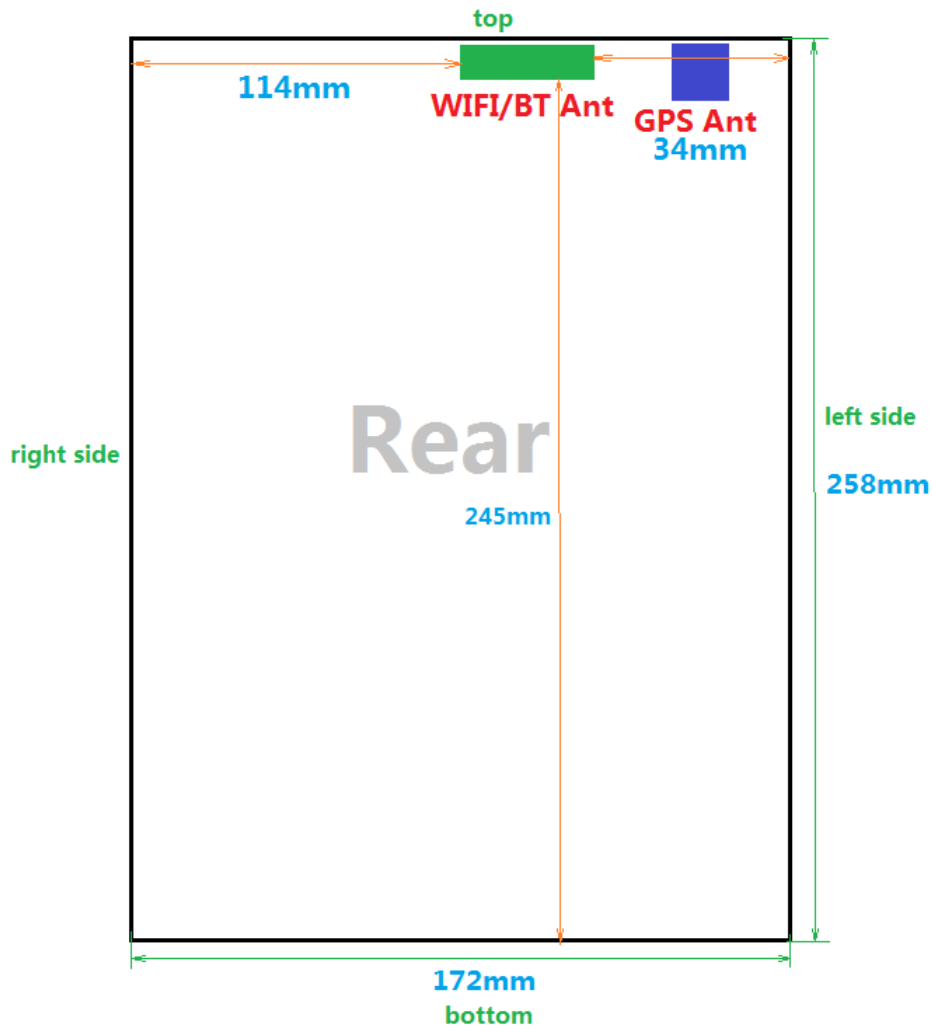



Antenna-to-user separation distances:	<p>WiFi/BT Antenna</p> <p>Tablet-Back face: 3mm from WiFi Antenna-to-user</p> <p>Tablet-Edges with the following configurations</p> <ul style="list-style-type: none"> ■ Left side: 34mm from WiFi Antenna-to-user ■ Top: 5mm from WiFi Antenna-to-user ■ Right side: 114mm from WiFi Antenna-to-user ■ Bottom: 245mm from WiFi Antenna-to-user
---------------------------------------	--

1.5. Simultaneous Transmission Configurations

Simultaneous Transmission Scenarios

No.	Simultaneous Transmit Configurations	FCC KDB 616217	Note
1	2.4GHz WIFI + 2.4GHz Bluetooth	Yes	

Note: According to FCC KDB Publication 447498 D01v05r02, transmitter are considered to be transmitting simultaneously when there is overlapping transmission, with the exception of transmissions during network hand-offs with maximum hand-off duration less than 30 seconds. This device contains multiple transmitters that may operate simultaneously, and therefore requires a simultaneously transmission analysis.

1.6. SAR Test Exclusions Applied

Wi-Fi/Bluetooth

Per FCC KDB 447498 D01v05r02, the SAR exclusion threshold for distances<50mm is defined by the following equation:

$$\frac{\text{Max Power of Channel (mW)}}{\text{Test Separation Dist (mm)}} * \sqrt{\text{Frequency(GHz)}} \leq 3.0$$

Based on the maximum conducted power of Bluetooth and the antenna to use separation distance, Bluetooth SAR is not required. Nevertheless, Bluetooth SAR was tested for conservative results.

$$[(8.73\text{mW}/5) * \sqrt{2.441}] = 2.73 < 3.0 \text{ for Body}$$

Note: 8.73mW comes from 9.41dBm of Max. Bluetooth Power.

1.7. Power Reduction for SAR

There is no power reduction used for any band/mode implemented in this device for SAR purposes.

1.8. Environment Condition

Item	Target	Measured
Ambient Temperature(°C)	18~25	21.5±2
Temperature of Simulant(°C)	20~22	21±2
Relative Humidity(%RH)	30~70	52



1.9. Test Standards

1. FCC KDB Publication 447498 D01 General RF Exposure Guidance v05r02
2. FCC KDB Publication 865664 D01 SAR Measurement 100 MHz to 6 GHz v01r03
3. FCC KDB Publication 616217 D04 SAR for laptop and tablets v01r01
4. FCC KDB Publication 248227 D01 SAR measurement for 802 11 a b g v01r02
5. RSS-102
6. IEEE Std.1528-2013

1.10. RF Exposure Limits

Human Exposure	Basic restrictions for electric, magnetic and electromagnetic fields. (Unit in mW/ or W/kg)
Spatial Peak SAR ¹ (Head and Body)	1.60
Spatial Average SAR ² (Whole Body)	0.08
Spatial Peak SAR ³ (Arms and Legs)	4.00

Notes:

1. The Spatial Peak value of the SAR averaged over any 1gram of tissue (defined as a tissue volume in the shape of a cube) and over the appropriate averaging time.
2. The Spatial Average value of the SAR averaged over the whole body.
3. The Spatial Peak value of the SAR averaged over any 1 gram of tissue (defined as a tissue volume in the shape of a cube) and over appropriate averaging time.



2. The SAR Measurement Procedure

2.1. System Performance Check

2.1.1 Purpose

1. To verify the simulating liquids are valid for testing.
2. To verify the performance of testing system is valid for testing.

2.1.2 Tissue Dielectric Parameters for Head and Body Phantoms

Target Frequency (MHz)	Head		Body	
	ϵ_r	σ (S/m)	ϵ_r	σ (S/m)
150	52.3	0.76	61.9	0.80
300	45.3	0.87	58.2	0.92
450	43.5	0.87	56.7	0.94
835	41.5	0.90	55.2	0.97
850	41.5	0.92	55.2	0.99
900	41.5	0.97	55.0	1.05
915	41.5	0.98	55.0	1.06
1450	40.5	1.20	54.0	1.30
1610	40.3	1.29	53.8	1.40
1800 – 2000	40.0	1.40	53.3	1.52
2450	39.2	1.80	52.7	1.95
3000	38.5	2.40	52.0	2.73
5800	35.3	5.27	48.2	6.00

(ϵ_r = relative permittivity, σ = conductivity and $\rho = 1000 \text{ kg/m}^3$)



2.1.3 Tissue Calibration Result

- The dielectric parameters of the liquids were verified prior to the SAR evaluation using DASY5 Dielectric Assessment Kit and Agilent Vector Network Analyzer E5071C.

Body Tissue Simulant Measurement (Test Date: 05-11-2014)								
Frequency [MHz]	Channel No.	Dielectric Parameters						Tissue Temp. [°C]
		Permittivity ϵ_r	Conductivity σ	Permittivity Target ϵ_r	Conductivity Target σ	Delta (ϵ_r)%	Delta (σ)%	
2450	N/A	52.68	1.94	52.70	1.95	-0.04	-0.51	21
2412	1	52.79	1.91	52.70	1.90	0.17	0.53	21
2437	6	52.71	1.93	52.70	1.93	0.02	0.01	21
2462	11	52.65	1.96	52.70	1.97	-0.09	-0.51	21

Note: 1) The delta (ϵ_r) and (σ) are within $\pm 5\%$, delta SAR value was not calculated in this report.

2) As per IEC 62209-2 Annex F, the SAR correction factor is given by:

$$\Delta SAR = c_\epsilon \Delta \epsilon_r + c_\sigma \Delta \sigma$$

For the 1g average SAR C_ϵ and C_σ are given by:

$$C_\epsilon = -7.854 \times 10^{-4} f^3 + 9.402 \times 10^{-3} f^2 - 2.742 \times 10^{-2} f - 0.2026; C_\sigma = 9.804 \times 10^{-3} f^3 - 8.661 \times 10^{-2} f^2 + 2.981 \times 10^{-2} f + 0.7829$$

Where f is the frequency in GHz.

- Refer to KDB 865664 D01 v01r03, The depth of body tissue-equivalent liquid in a phantom must be ≥ 15.0 cm with $\leq \pm 0.5$ cm variation for SAR measurements ≤ 3 GHz and ≥ 10.0 cm with $\leq \pm 0.5$ cm variation for measurements > 3 GHz.

2.1.4 System Performance Check Procedure

The DASY5 installation includes predefined files with recommended procedures for measurements and the system performance check. They are read-only document files and destined as fully defined but unmeasured masks, so the finished system performance check must be saved under a different name. The system performance check document requires the SAM Twin Phantom or ELI4 Phantom, so the phantom must be properly installed in your system. (User defined measurement procedures can be created by opening a new document or editing an existing document file). Before you start the system performance check, you need only to tell the system with which components (probe, medium, and device) you are performing the system performance check; the system will take care of all parameters.

- **The Power Reference Measurement and Power Drift Measurement** jobs are located at the beginning and end of the batch process. They measure the field drift at one single point in the liquid over the complete procedure. The indicated drift is mainly the variation of the Dipole output power. If it is too high (above ± 0.2 dB), the system performance check should be repeated;
- **The Surface Check** job tests the optical surface detection system of the DASY5 system by repeatedly detecting the surface with the optical and mechanical surface detector and comparing the results. The output gives the detecting heights of both systems, the difference between the two systems and the standard deviation of the detection repeatability. Air bubbles or refraction in the liquid due to separation of the sugar-water mixture gives poor repeatability (above ± 0.1 mm). In that case it is better to abort the system performance check and stir the liquid;



- **The Area Scan** job measures the SAR above the dipole on a plane parallel to the surface. It is used to locate the approximate location of the peak SAR. The proposed scan uses large grid spacing for faster measurement; due to the symmetric field, the peak detection is reliable;
- **The Zoom Scan** job measures the field in a volume around the peak SAR value assessed in the previous Area Scan job (for more information see the application note on SAR evaluation). If the system performance check gives reasonable results. The dipole input power(forward power) was 250mW, 1 g and 10 g spatial average SAR values normalized to 1W dipole input power give reference data for comparisons and it's equal to 10x(dipole forward power). The next sections analyze the expected uncertainties of these values, as well as additional checks for further information or troubleshooting.

2.1.5 System Performance Check Setup

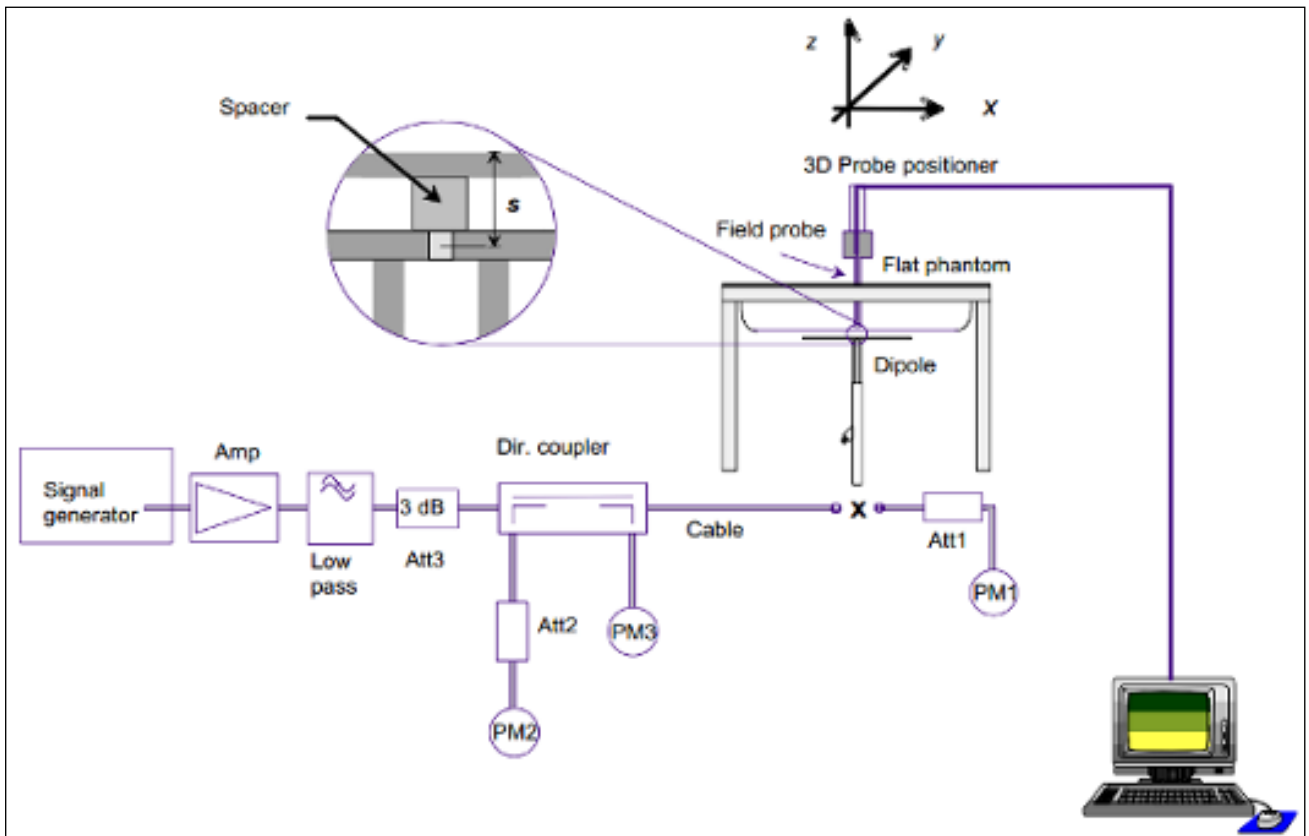

2.1.6 Validation Dipoles

The dipoles use is based on the IEEE Std.1528-2013 and FCC KDB 865664 D01 SAR Measurement 100 MHz to 6 GHz v01r03standard, and is complied with mechanical and electrical specifications in line with the requirements of both EN62209-1 and EN62209-2. The table below provides details for the mechanical and electrical specifications for the dipoles.

Frequency	L (mm)	h (mm)	d (mm)
2450MHz	53.5	30.4	3.6

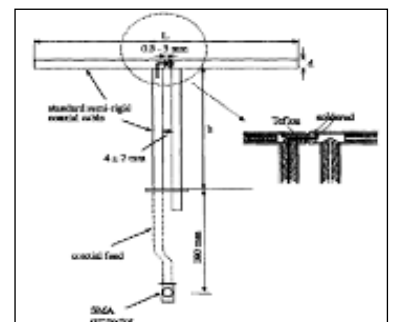



2.1.7 Result of System Performance Check: Valid Result

System Performance Check at 2450MHz for Body.				
Validation Dipole: D2450V2-SN 914				
Frequency [MHz]	Description	SAR [w/kg] 1g	SAR [w/kg] 10g	Tissue Temp. [°C]
2450 MHz	Reference result ± 10% window	51.5 46.35 to 56.65	23.9 21.51 to 26.29	N/A
	05-11-2014	51.2	23.4	21.0
Note: All SAR values are normalized to 1W forward power.				

2.2. Test Requirements

2.2.1 Test Procedures

Step 1 Setup a Connection

First, engineer should record the conducted power before the test. Then establish a call in handset at the maximum power level with a base station simulator via air interface, or make the EUT estimate by itself in testing band. Place the EUT to the specific test location. After the testing, must export SAR test data by SEMCAD. Then writing down the conducted power of the EUT into the report, also the SAR values tested.

Step 2 Power Reference Measurements

To measure the local E-field value at a fixed location which value will be taken as a reference value for calculating a possible power drift.

Step 3 Area Scan

The Area Scan is used as a fast scan in two dimensions to find the area of high field values, before doing a fine measurement around the hot spot. The sophisticated interpolation routines implemented in DASY software can find the maximum locations even in relatively coarse grids. When an Area Scan has measured all reachable points, it computes the field maximal found in the scanned area, within a range of the global maximum. The range (in dB) is specified in the standards for compliance testing. For example, a 2 dB range is required in IEEE Standard 1528 and IEC 62209 standards, whereby 3 dB is a requirement when compliance is assessed in accordance with the ARIB standard (Japan). If only one Zoom Scan follows the Area Scan, then only the absolute maximum will be taken as reference. For cases where multiple maximums are detected, the number of Zoom Scans has to be increased accordingly.



Area Scan Parameters extracted from KDB 865664 D01v01r01

	≤ 3 GHz	> 3 GHz
Maximum distance from closest measurement point (geometric center of probe sensors) to phantom surface	5 ± 1 mm	$\frac{1}{2} \cdot \delta \cdot \ln(2) \pm 0.5$ mm
Maximum probe angle from probe axis to phantom surface normal at the measurement location	30° ± 1°	20° ± 1°
Maximum area scan spatial resolution: Δx_{Area} , Δy_{Area}	≤ 2 GHz: ≤ 15 mm 2 – 3 GHz: ≤ 12 mm	3 – 4 GHz: ≤ 12 mm 4 – 6 GHz: ≤ 10 mm
	When the x or y dimension of the test device, in the measurement plane orientation, is smaller than the above, the measurement resolution must be ≤ the corresponding x or y dimension of the test device with at least one measurement point on the test device.	

Step 4 Zoom Scan

Zoom Scans are used to assess the peak spatial SAR values within a cubic averaging volume containing 1 g and 10 g of simulated tissue. The Zoom Scan measures points (refer to table below) within a cube whose base faces are centered on the maxima found in a preceding area scan job within the same procedure. When the measurement is done, the Zoom Scan evaluates the averaged SAR for 1 g and 10 g and displays these values next to the job’s label.

Zoom Scan Parameters extracted from KDB 865664 D01 v01r03

		≤ 3 GHz	> 3 GHz	
Maximum zoom scan spatial resolution: Δx_{Zoom} , Δy_{Zoom}		≤ 2 GHz: ≤ 8 mm 2 – 3 GHz: ≤ 5 mm*	3 – 4 GHz: ≤ 5 mm* 4 – 6 GHz: ≤ 4 mm*	
Maximum zoom scan spatial resolution, normal to phantom surface	uniform grid: $\Delta z_{Zoom}(n)$	≤ 5 mm	3 – 4 GHz: ≤ 4 mm 4 – 5 GHz: ≤ 3 mm 5 – 6 GHz: ≤ 2 mm	
	graded grid	$\Delta z_{Zoom}(1)$: between 1 st two points closest to phantom surface	≤ 4 mm	3 – 4 GHz: ≤ 3 mm 4 – 5 GHz: ≤ 2.5 mm 5 – 6 GHz: ≤ 2 mm
		$\Delta z_{Zoom}(n>1)$: between subsequent points	≤ 1.5 · $\Delta z_{Zoom}(n-1)$	
Minimum zoom scan volume	x, y, z	≥ 30 mm	3 – 4 GHz: ≥ 28 mm 4 – 5 GHz: ≥ 25 mm 5 – 6 GHz: ≥ 22 mm	
Note: δ is the penetration depth of a plane-wave at normal incidence to the tissue medium; see draft standard IEEE P1528-2011 for details. * When zoom scan is required and the <i>reported</i> SAR from the <i>area scan based 1-g SAR estimation</i> procedures of KDB 447498 is ≤ 1.4 W/kg, ≤ 8 mm, ≤ 7 mm and ≤ 5 mm zoom scan resolution may be applied, respectively, for 2 GHz to 3 GHz, 3 GHz to 4 GHz and 4 GHz to 6 GHz.				



Step 5 Power Drift Measurements

Repetition of the E-field measurement at the fixed location mentioned in Step 1 to make sure the two results differ by less than ± 0.2 dB.

2.2.2 Positions for Tablet & Laptop SAR testing

Per FCC KDB 616217 D04v01r01, the back surface and edges of the tablet mode should be tested for SAR compliance with the tablet touching the phantom and back surface for laptop mode. The SAR Exclusion Threshold in KDB 447498 D01v05r02 can be applied to determine SAR test exclusion for adjacent edge configurations. The closest distance from the antenna to an adjacent tablet edge is used to determine if SAR testing is required for the adjacent edges, with the adjacent edge positioned against the phantom and the edge containing the antenna positioned perpendicular to the phantom.

2.2.3 Test Channel Choose

Mode	GHz	Channel	Turbo Channel	“Default Test Channels”			
				§15.247		UNII	
				802.11b	802.11g		
802.11 b/g	2.412	1 [#]		√	∇		
	2.437	6	6	√	∇		
	2.462	11 [#]		√	∇		

- √ = “default test channels”
- * = possible 802.11a channels with maximum average output > the “default test channels”
- ∇ = possible 802.11g channels with maximum average output ¼ dB ≥ the “default test channels”
- # = when output power is reduced for channel 1 and/or 11 to meet restricted band requirements the highest output channels closest to each of these channels should be tested

1. Per KDB 248227 D01v01r02, SAR is not required for 802.11g/HT20 channels when the maximum average output power is less than 1/4 dB higher than that measured on the corresponding 802.11b channels.
2. SAR is not required for Channels 12 and 13, if the tune-up limit and the measured output power for these two channels are no greater than those for the default test channels.



3. DASY5 Measurement System

DASY5 Measurement System

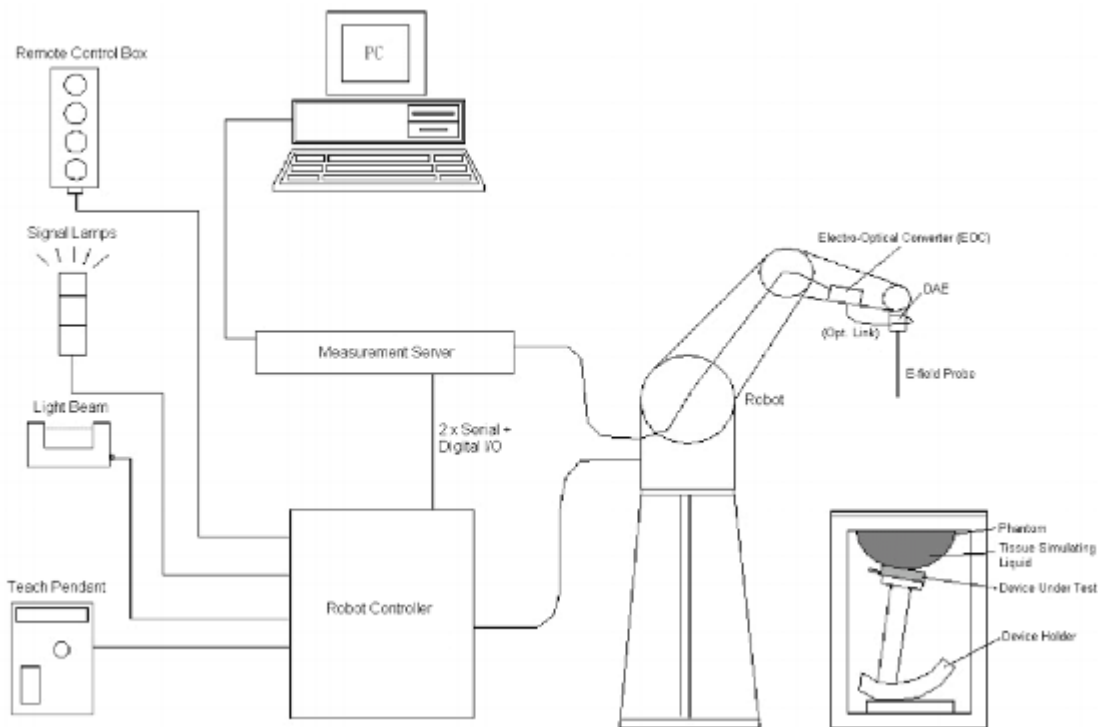

Figure 2.1 SPEAG DASY5 System Configurations

The DASY5 system for performance compliance tests is illustrated above graphically. This system consists of the following items:

- A standard high precision 6-axis robot with controller, a teach pendant and software
- A data acquisition electronic(DAE)attached to the robot arm extension
- A dosimetric probe equipped with an optical surface detector system
- The electro-optical converter(ECO)performs the conversion between optical and electrical signals
- A measurement server performs the time critical tasks such as signal filtering, control of the robot operation and fast movement interrupts.
- A probe alignment unit which improves the accuracy of the probe positioning
- A computer operating Windows 7
- DASY5 software
- Remote control with teach pendant additional circuitry for robot safety such as warning lamps, etc.
- The SAM twin phantom
- A device holder
- Tissue simulating liquid
- Dipole for evaluating the proper functioning of the system



3.1. Uncertainty of Inter-/Extrapolation and Averaging

In order to evaluate the uncertainty of the interpolation, extrapolation and averaged SAR calculation algorithms of the Postprocessor, DASY5 allows the generation of measurement grids which are artificially predefined by analytically based test functions. Therefore, the grids of area scans and zoom scans can be filled with uncertainty test data, according to the SAR benchmark functions of IEEE 1528. The three analytical functions shown in equations as below are used to describe the possible range of the expected SAR distributions for the tested handsets. The field gradients are covered by the spatially flat distribution f1, the spatially steep distribution f3 and f2 accounts for H-field cancellation on the phantom/tissue surface.

$$f_1(x, y, z) = Ae^{-\frac{z}{2a}} \cos^2 \left(\frac{\pi \sqrt{x'^2 + y'^2}}{2 \cdot 5a} \right)$$

$$f_2(x, y, z) = Ae^{-\frac{z}{a}} \frac{a^2}{a^2 + x'^2} \left(3 - e^{-\frac{2z}{a}} \right) \cos^2 \left(\frac{\pi y'}{2 \cdot 3a} \right)$$

$$f_3(x, y, z) = A \frac{a^2}{\frac{a^2}{4} + x'^2 + y'^2} \left(e^{-\frac{2z}{a}} + \frac{a^2}{2(a + 2z)^2} \right)$$

3.2. DASY5 E-Field Probe

The SAR measurement is conducted with the dosimetric probe manufactured by SPEAG. The probe is specially designed and calibrated for use in liquid with high permittivity. The dosimetric probe has special calibration in liquid at different frequency.

SPEAG conducts the probe calibration in compliance with international and national standards (e.g. IEEE 1528, EN 62209-1, IEC 62209, etc.) under ISO 17025. The calibration data are in Appendix D.

Model	EX3DV4	
Construction	Symmetrical design with triangular core Built-in shielding against static charges PEEK enclosure material (resistant to organic solvents, e.g., DGBE)	
Frequency	10 MHz to 6 GHz Linearity: ± 0.2 dB (30 MHz to 6 GHz)	
Directivity	± 0.3 dB in HSL (rotation around probe axis) ± 0.5 dB in tissue material (rotation normal to probe axis)	
Dynamic Range	10 µW/g to 100 mW/g Linearity: ± 0.2 dB (noise: typically < 1 µW/g)	
Dimensions	Overall length: 330 mm (Tip: 20 mm) Tip diameter: 2.5 mm (Body: 12 mm) Typical distance from probe tip to dipole centers: 1 mm	
Application	High precision dosimetric measurements in any exposure scenario (e.g., very strong gradient fields). Only probe which enables compliance testing for frequencies up to 6 GHz with precision of better 30%.	



3.3. Data Acquisition Electronics (DAE)

The data acquisition electronics (DAE) consists of a highly sensitive electrometer-grade preamplifier with auto-zeroing, a channel and gain-switching multiplexer, a fast 16 bit AD-converter and a command decoder and control logic unit.

Transmission to the measurement server is accomplished through an optical downlink for data and status information as well as an optical uplink for commands and the clock.

The input impedance of the DAE4 is 200M Ohm; the inputs are symmetrical and floating. Common mode rejection is above 80dB.

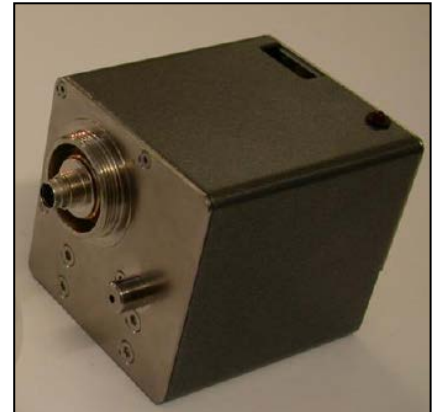

3.4. Robot

The DASY5 system uses the high precision robots TX90 XL type out of the newer series from Stäubli SA (France). For the 6-axis controller DASY5 system, the CS8C robot controller version from Stäubli is used.

The XL robot series have many features that are important for our application:

- High precision (repeatability 0.02 mm)
- High reliability (industrial design)
- Jerk-free straight movements
- Low ELF interference (the closed metallic construction shields against motor control fields)
- 6-axis controller



3.5. Light Beam Unit

The light beam switch allows automatic "tooling" of the probe. During the process, the actual position of the probe tip with respect to the robot arm is measured, as well as the probe length and the horizontal probe offset. The software then corrects all movements, such that the robot coordinates are valid for the probe tip.

The repeatability of this process is better than 0.1 mm. If a position has been taught with an aligned probe, the same position will be reached with another aligned probe within 0.1 mm, even if the other probe has different dimensions. During probe rotations, the probe tip will keep its actual position.





3.6. Measurement Server

The DASY5 measurement server is based on a PC/104 CPU board with a 400MHz intel ULV Celeron, 128MB chipdisk and 128MB RAM. The necessary circuits for communication with the DAE electronics box, as well as the 16 bit AD converter system for optical detection and digital I/O interface are contained on the DASY5 I/O board, which is directly connected to the PC/104 bus of the CPU board.



3.7. SAM Phantom

The SAM twin phantom is a fiberglass shell phantom with 2mm shell thickness (except the ear region where shell thickness increases to 6mm). It has three measurement areas:

- Left head
- Right head
- Flat phantom



The ELI4 Phantom also is a fiberglass shell phantom with 2mm shell thickness. It has 30 liters filling volume, and with a dimension of 600mm for major ellipse axis , 400mm for minor axis. It is intended for compliance testing of handheld and body-mounted wireless devices in frequency range of 30 MHz to 6GHz. ELI4 is fully compatible with standard and all known tissue simulating liquids.

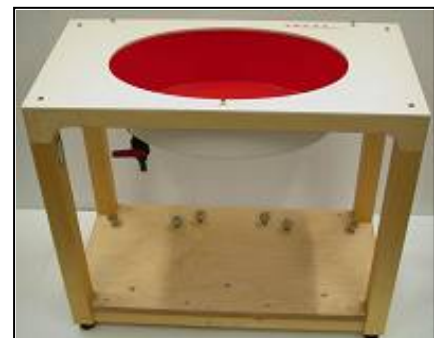

The bottom plate contains three pair of bolts for locking the device holder. The device holder positions are adjusted to the standard measurement positions in the three sections. A white cover is provided to tap the phantom during off-periods to prevent water evaporation and changes in the liquid parameters. On the phantom top, three reference markers are provided to identify the phantom position with respect to the robot.



3.8. Device Holder

➤ The DASY5 device holder is designed to cope with different positions given in the standard. It has two scales for the device rotation (with respect to the body axis) and the device inclination (with respect to the line between the ear reference points). The rotation center for both scales is the ear reference point (EPR). Thus the device needs no repositioning when changing the angles. The DASY5 device holder has been made out of low-loss POM material having the following dielectric parameters: relative permittivity $\epsilon_r = 3$ and loss tangent $\delta = 0.02$. The amount of dielectric material has been reduced in the closest vicinity of the device, since measurements have suggested that the influence of the clamp on the test results could thus be lowered.



➤ The laptop extension is lightweight and made of POM, acrylic glass and foam. It fits easily on upper part of the mounting device in place of the phone positioned. The extension is fully compatible with the SAM Twin and ELI phantoms.

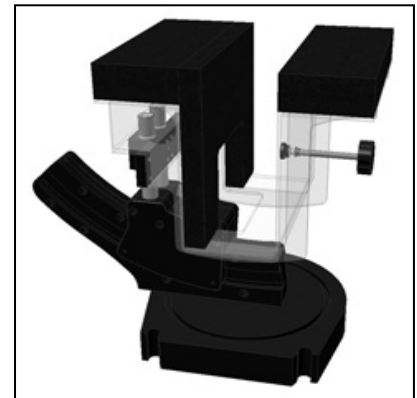



3.9. Test Equipment List

Instrument	Manufacturer	Model No.	Serial No.	Cali. Due Date
Stäubli Robot TX60L	Stäubli	TX60L	5P6VA1/A/01	only once
Robot Controller	Stäubli	CS8C	5P6VA1/C/01	only once
Dipole Validation Kits	Speag	D2450V2	914	2015.06.06
SAM ELI Phantom	Speag	SAM	1211	N/A
Device Holder	Speag	SD 000 H01 KA	N/A	N/A
Laptop Holder	Speag	SM LH1 001CD	N/A	N/A
Data Acquisition Electronic	Speag	DAE4	1379	2015.05.23
E-Field Probe	Speag	EX3DV4	3927	2015.05.19
SAR Software	Speag	DASY5	V5.2 Build 162	N/A
Power Amplifier	Mini-Circuit	ZVA-183W-S+	MN136701248	N/A
Directional Coupler	Agilent	772D	MY52180104	N/A
Universal Radio Communication Tester	R&S	CMU 200	108823	2015.01.08
Vector Network	Agilent	E5071C	MY4631693	2015.01.15
Signal Generator	R&S	SML	103287	2015.03.09
Power Meter	BONN	BLWA0830-160/100/40D	76659	2015.11.10
AUG Power Sensor	R&S	NRP-Z91	100384	2015.03.09



3.10. Annul Internal Check of Impedance and Return Loss

2450MHz Body calibrated impedance 52.051Ω; measured impedance: 50.948Ω (within 5Ω)

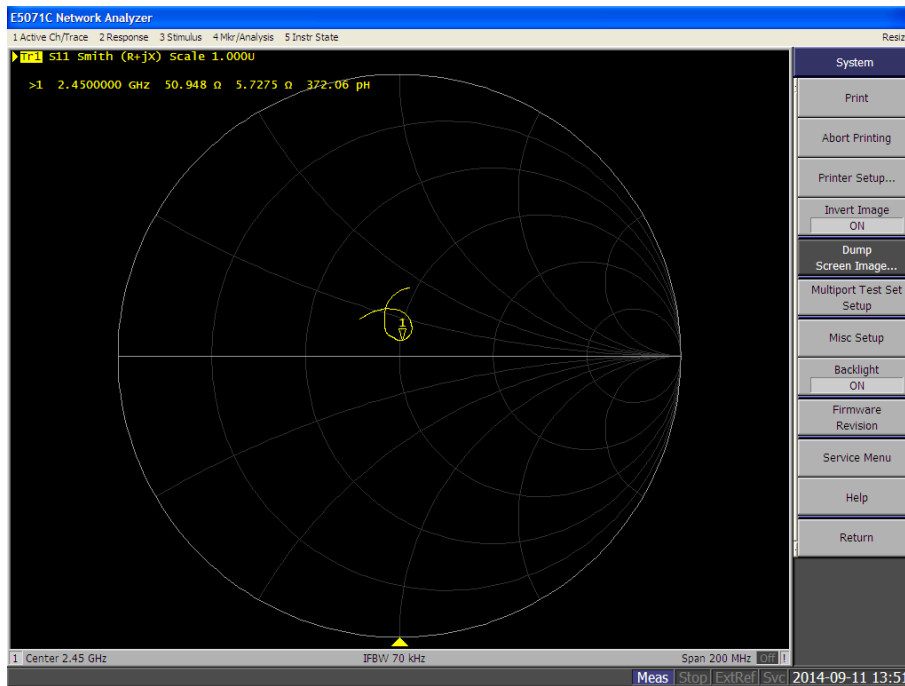

2450MHz Body calibrated return loss: -28.024 dB; Measured return loss: -26.968dB (within 20%)

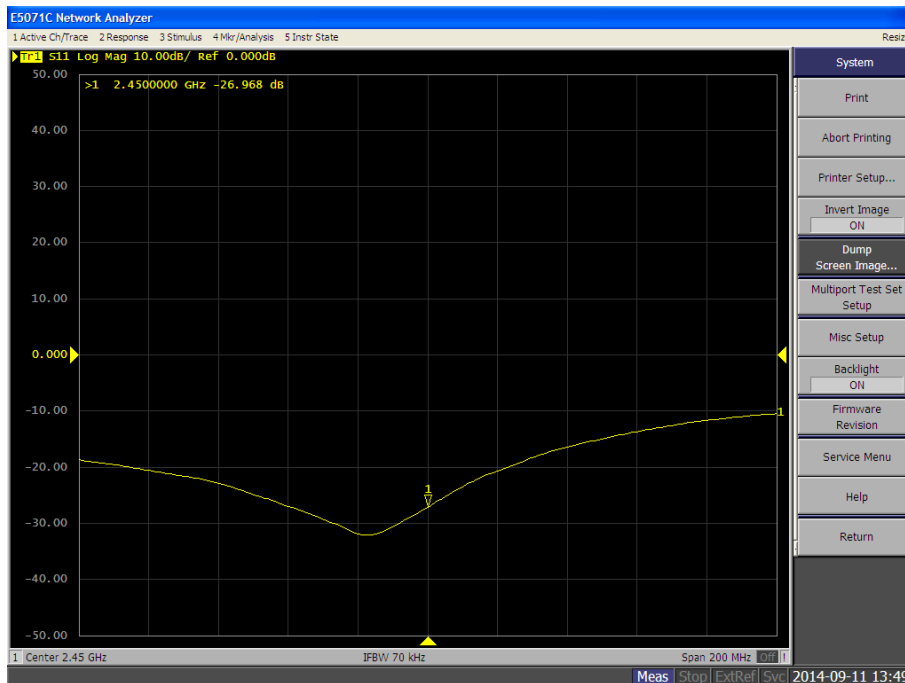



4. Results

4.1. Summary of Test Results

No deviations form the technical specification(s) were ascertained in the course of the tests performed	<input checked="" type="checkbox"/>
The deviations as specified in this chapter were ascertained in the course of the tests Performed.	<input type="checkbox"/>

4.2. Description for EUT test position

The following procedure had been used to prepare the EUT for the SAR test.

- The client supplied a special driver to program the EUT, allowing it to continually transmit the specified maximum power and change the channel frequency.
- The output power(dBm) we measured before SAR test in different channel
- Performing the highest output power channel first
- SAR test Tip edge and Bottom Flat mode.

4.3. Conducted power (Averaged)

WLAN Power

Test Mode	Channel No.	Frequency (MHz)	Average Power (dBm)	Max. Power (dBm)	Scaling Factor
802.11b	01	2412	13.22	13.5	1.07
	06	2437	13.25	13.5	1.06
	11	2462	13.15	13.5	1.08
802.11g	01	2412	12.31	12.5	1.04
	06	2437	12.37	12.5	1.03
	11	2462	12.29	12.5	1.05
802.11n (20MHz)	01	2412	10.77	11.0	1.05
	06	2437	10.87	11.0	1.03
	11	2462	10.71	11.0	1.07

Note 1: Justification for reduced test configurations for Wi-Fi channels Per KDB Publication 248227 D01v01r02 and KDB 447498 D01v05r02.

2: For 2.4 GHz, highest average RF output power channel for the lowest data rate for IEEE 802.11b were selected for SAR evaluation. Other IEEE 802.11 modes (including 802.11g/n) were not investigated since the average output powers over all channels and data rates were not more than 0.25 dB higher than the tested channel in the lowest data rate of IEEE 802.11b mode.

3: When the maximum extrapolated peak SAR of the zoom scan for the maximum output channel is <1.6 W/kg and the reported 1g averaged SAR is <0.8 W/kg, SAR testing on other channels is not required. Otherwise, the other default (or corresponding required) test channels were additionally tested using the lowest data rate.

4: The bolded channel above was firstly tested for SAR.



4.4. Estimated SAR for Bluetooth

This device contains transmitters that may operate simultaneously. Therefore simultaneous transmission analysis is required. Per FCC KDB 447498 D01v05r02, simultaneous transmission SAR test exclusion may be applied when the sum of the 1-g SAR for all the simultaneous transmitting antennas in a specific a physical test configuration is $\leq 1.6\text{W/kg}$. When standalone SAR is not required to be measured, per FCC KDB 447498 D01v05r02 4.3.2 2, the following equation must be used to estimate the standalone 1g SAR for simultaneous transmission assessment involving that transmitter.

$$\text{Estimated SAR} = \frac{\sqrt{f(\text{GHz})}}{7.5} * \frac{(\text{Max Power of channel, mW})}{\text{Min. Separation Distance, mm}}$$

Mode	Frequency	Maximum Allowed Power	Separation Distance (Body)	Estimated SAR (Body)
Bluetooth	[MHz]	[dBm]	[mm]	[W/kg]
	2441	9.41	5	0.364

**4.5. SAR Test Results Summary**

SAR Measurement									
Ambient Temperature (°C): 21.5 ± 2					Relative Humidity (%): 52				
Liquid Temperature (°C): 21.0 ± 2					Depth of Liquid (cm): >15				
Product: Tablet PC									
Tablet Mode SAR Configurations									
Test Mode: 802.11b									
Test Position Body (0mm gap)	Antenna Position	Frequency		Average Power (dBm)	Power Drift (<±0.2)	SAR 1g (W/kg)	Scaling Factor	Scaled SAR 1g (W/kg)	Limit (W/kg)
		Channel	MHz						
Bottom of Tablet	Fixed	1	2412	14.42	0.13	1.08	1.07	1.156	1.6
Bottom of Tablet	Fixed	6	2437	14.45	0.19	1.1	1.06	1.166	1.6
Bottom of Tablet*	Fixed	6	2437	14.45	0.19	1.09	1.06	1.155	1.6
Bottom of Tablet	Fixed	11	2462	14.35	0.17	1.01	1.08	1.091	1.6
Left side	Fixed	6	2437	14.45	0.01	0.000872	1.06	0.001	1.6
Top	Fixed	6	2437	14.45	0.12	0.049	1.06	0.052	1.6
Test Mode: 802.11g									
Bottom of Tablet	Fixed	6	2437	13.57	0.19	0.921	1.06	0.976	1.6
Test Mode: 802.11n(20MHz)									
Bottom of Tablet	Fixed	6	2437	12.07	0.10	0.745	1.06	0.79	1.6
Note1: when the 1-g SAR is ≤ 0.8 W/kg, testing for low and high channel is optional, refer to KDB 447498. 2: * - repeated at the highest SAR measurement according to the FCC KDB 865664.									



5. The Description of Test Procedure

5.1. General Notes:

1. Batteries are fully charged at the beginning of the SAR measurements.
2. The manufacturer has confirmed that the device(s) tested have the same physical, mechanical and thermal characteristics and are within operational tolerances expected for production units.
3. SAR results were scaled to the maximum allowed power to demonstrate compliance per FCC KDB Publication 447498 D01v05r02.
4. Per FCC KDB 616217 D04 Section 4.3, SAR tests are required for the back surface and edges of the tablet with the tablet touching the phantom. The SAR Exclusion Threshold in FCC KDB 447498 D01v05 was applied to determine SAR test exclusion for adjacent edge configurations. SAR tests were required for bottom and primary landscape for the BT/WLAN Antenna.

WLAN/BT Notes:

1. Justification for reduced test configurations for WIFI channels per KDB Publication 248227 D01v01r02 and April 2010 FCC/TCB Meeting Notes for 2.4 GHz WIFI: Highest average RF output power channel for the lowest data rate was selected for SAR evaluation in 802.11b. Other IEEE 802.11 modes (including 802.11g/n) were not investigated since the average output powers over all channels and data rates were not more than 0.25 dB higher than the tested channel in the lowest data rate of IEEE 802.11b mode.
2. WIFI transmission was verified using a spectrum analyzer.
3. When the maximum extrapolated peak SAR of the zoom scan for the maximum output channel is <1.6 W/kg and the reported 1g averaged SAR is <0.8 W/kg, SAR testing on other default channels is not required.

5.2. Simultaneous Transmission Procedures

This device contains transmitters that may operate simultaneously. Therefore simultaneous transmission analysis is required. Per FCC KDB 447498 D01v05r02, simultaneous transmission SAR test exclusion may be applied when the sum of the 1-g SAR for all the simultaneous transmitting antennas in a specific a physical test configuration is ≤ 1.6 W/kg.



5.3. Simultaneous Transmission Analysis

Simultaneous Transmission Scenario with Bluetooth (Body at 0mm)

Configuration	Mode	Max. Scaled SAR (W/kg)	Bluetooth SAR (W/kg)	Σ SAR (W/kg)
Bottom of Tablet	802.11b	1.166	0.364	1.53
Left side of Tablet	802.11b	0.001	0.364	0.37
Top of Tablet	802.11b	0.052	0.364	0.42
Right side of Tablet	802.11b	0.4	0.364	0.76
Bottom of Tablet	802.11b	0.4	0.364	0.76

Note 1: For configurations excluded per 447498 D01v05r02, an estimated SAR of 0.4 W/kg was used to determine simultaneous transmission SAR exclusion since the test separation distance was >50 mm.

5.4. Simultaneous Transmission Conclusion

The above numerical summed SAR results for all the worst-case simultaneous transmission conditions were below the SAR limit. Therefore, the above analysis is sufficient to determine that simultaneous transmission cases will not exceed the SAR limit and therefore no measured volumetric simultaneous SAR summation is required per FCC KDB Publication 447498 D01v05r02.



6. Measurement Uncertainty

DASY5 Uncertainty Budget								
according to IEEE 1528/2011 and IEC 62209-1/2011(0.3-3GHz)								
Error Description	Uncert. value	Prob. Dist.	Div.	(ci) 1g	(ci) 10g	Std.Unc. (1g)	Std. nc. (10g)	(vi) v _{eff}
Measurement System								
Probe Calibration	±6.0%	N	1	1	1	±6.0%	±6.0%	∞
Axial Isotropy	±4.7%	R	$\sqrt{3}$	0.7	0.7	±1.9%	±1.9%	∞
Hemispherical Isotropy	±9.6%	R	$\sqrt{3}$	0.7	0.7	±3.9%	±3.9%	∞
Boundary Effects	±1.0%	R	$\sqrt{3}$	1	1	±0.6%	±0.6%	∞
Linearity	±4.7%	R	$\sqrt{3}$	1	1	±2.7%	±2.7%	∞
System Detection Limits	±1.0%	R	$\sqrt{3}$	1	1	±0.6%	±0.6%	∞
Modulation Response	±2.4%	R	$\sqrt{3}$	1	1	±1.4%	±1.4%	∞
Readout Electronics	±0.3%	N	1	1	1	±0.3%	±0.3%	∞
Response Time	±0.8%	R	$\sqrt{3}$	1	1	±0.5%	±0.5%	∞
Integration Time	±2.6%	R	$\sqrt{3}$	1	1	±1.5%	±1.5%	∞
RF Ambient Noise	±3.0%	R	$\sqrt{3}$	1	1	±1.7%	±1.7%	∞
RF Ambient Reflections	±3.0%	R	$\sqrt{3}$	1	1	±1.7%	±1.7%	∞
Probe Positioner	±0.4%	R	$\sqrt{3}$	1	1	±0.2%	±0.2%	∞
Probe Positioning	±2.9%	R	$\sqrt{3}$	1	1	±1.7%	±1.7%	∞
Max.SAR Eval.	±2.0%	R	$\sqrt{3}$	1	1	±1.2%	±1.2%	∞
Test Sample Related								
Device Positioning	±2.9%	N	1	1	1	±2.9%	±2.9%	145
Device Holder	±3.6%	N	1	1	1	±3.6%	±3.6%	5
Power Drift	±5.0%	R	$\sqrt{3}$	1	1	±2.9%	±2.9%	∞
Power Scaling ^p	±0%	R	$\sqrt{3}$	0	0	±0%	±0%	∞
Phantom and Setup								
Phantom Uncertainty	±6.1%	R	$\sqrt{3}$	1	1	±3.5%	±3.5%	∞
SAR correction	±1.9%	R	$\sqrt{3}$	1	0.84	±1.1%	±0.9%	∞
Liquid Conductivity (mea.) ^{DAK}	±2.5%	R	$\sqrt{3}$	0.78	0.71	±1.1%	±1.0%	∞
Liquid Permittivity (mea.) ^{DAK}	±2.5%	R	$\sqrt{3}$	0.26	0.26	±0.3%	±0.4%	∞
Temp. unc. –Conductivity ^{BB}	±3.4%	R	$\sqrt{3}$	0.78	0.71	±1.5%	±1.4%	∞
Temp. unc. – Permittivity ^{BB}	±0.4%	R	$\sqrt{3}$	0.23	0.26	±0.1%	±0.1%	∞
Combined Std. Uncertainty						±11.2%	±11.1%	361
Expanded STD Uncertainty(k=2)						±22.3%	±22.2%	



7. APPENDIX A. SAR System Verification Data

Date/Time: 05/11/2014

Test Laboratory: CerpPASS Lab

SystemPerformanceCheck-D2450 Body

DUT: Dipole 2450 MHz D2450V2; Type: SA AAD 245 BB

Communication System: CW; Frequency: 2450 MHz

Medium parameters used: $f = 2450$ MHz; $\sigma = 1.94$ S/m; $\epsilon_r = 52.68$; $\rho = 1000$ kg/m³

Phantom section: Flat Section; Meas. Ambient Temp (celsius) -22°C; Input power-250mW

Measurement Standard: DASYS (IEEE/IEC/ANSI C63.19-2011)

DASY Configuration:

- Probe: EX3DV4 - SN3927; ConvF(7.63, 7.63, 7.63); Calibrated: 2014/5/23;
- Sensor-Surface: 4mm (Mechanical Surface Detection), $z = 1.0, 31.0$
- Electronics: DAE4 Sn1379; Calibrated: 2014/5/19
- Phantom: SAM (30deg probe tilt) with CRP v5.0; Type: QD000P40CD
- DASY52 52.8.8(1222); SEMCAD X 14.6.10(7331)

Configuration/SystemPerformanceCheck-D2450 Body/Area Scan (4x6x1): Measurement grid: $dx=15$ mm, $dy=15$ mm, Maximum value of SAR (measured) = 10.4 W/kg

Configuration/SystemPerformanceCheck-D2450 Body/Zoom Scan (7x7x7)/Cube 0:

Measurement grid: $dx=5$ mm, $dy=5$ mm, $dz=5$ mm, Reference Value = 89.29 V/m; Power Drift = 0.04 dB, Peak SAR (extrapolated) = 27.5 W/kg

SAR(1 g) = 12.8 W/kg; SAR(10 g) = 5.85 W/kg Maximum value of SAR (measured) = 14.7 W/kg

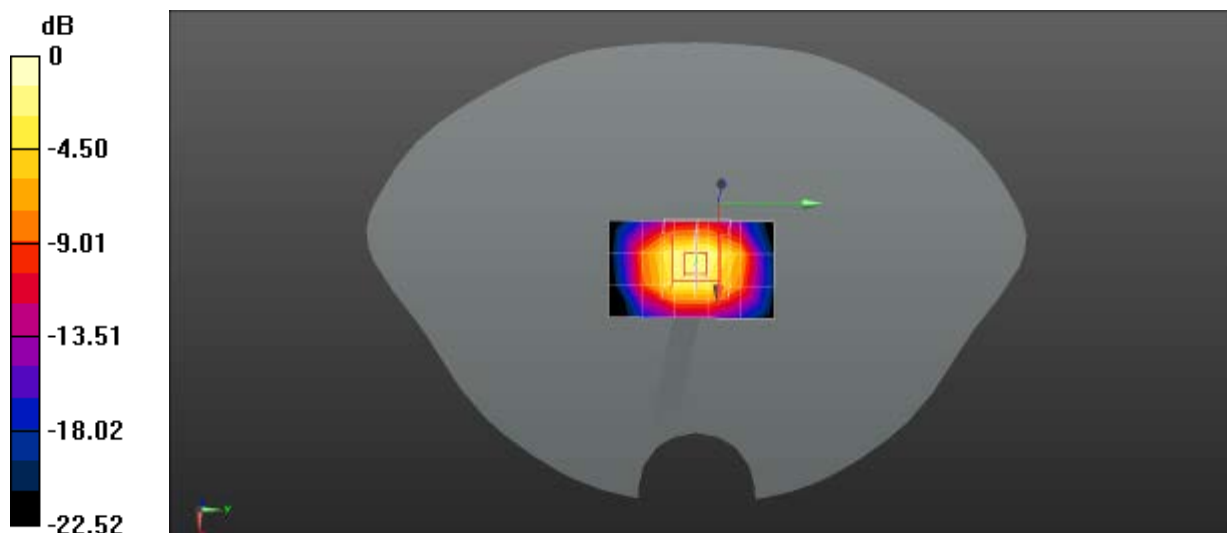

0 dB = 14.7 W/kg = 11.67 dBW/kg



8. APPENDIX B. SAR measurement Data

Date/Time: 05/11/2014

Test Laboratory: CerpPASS Lab

DUT: MID; Type: F5281

Procedure Name: 802.11b 2412MHz Low Body-Back

Communication System Band: 802.11b; Frequency: 2412 MHz; Duty Cycle: 1:1

Medium parameters used: $f = 2412$ MHz; $\sigma = 1.91$ S/m; $\epsilon_r = 52.79$; $\rho = 1000$ kg/m³

Phantom section: Flat Section; Tissue Temp (celsius) - 21°C

Measurement Standard: DASYS (IEEE/IEC/ANSI C63.19-2011)

DASY5 Configuration:

- Probe: EX3DV4 - SN3927; ConvF(7.63, 7.63, 7.63); Calibrated: 2014/5/23;
- Sensor-Surface: 4mm (Mechanical Surface Detection)
- Electronics: DAE4 Sn1379; Calibrated: 2014/5/19
- Phantom: SAM (30deg probe tilt) with CRP v5.0; Type: QD000P40CD
- Measurement SW: DASYS2, Version 52.8 (8);

Configuration/802.11b 2412MHz Low Body-Back/Area Scan (15x9x1): Measurement grid:

$dx=12$ mm, $dy=12$ mm, Maximum value of SAR (measured) = 1.04 W/kg

Configuration/802.11b 2412MHz Low Body-Back/Zoom Scan (5x5x7)/Cube 0: Measurement grid:

$dx=8$ mm, $dy=8$ mm, $dz=5$ mm, Reference Value = 7.147 V/m; Power Drift = 0.13 dB

Peak SAR (extrapolated) = 3.04 W/kg

SAR(1 g) = 1.08 W/kg; SAR(10 g) = 0.378 W/kg Maximum value of SAR (measured) = 1.23 W/kg

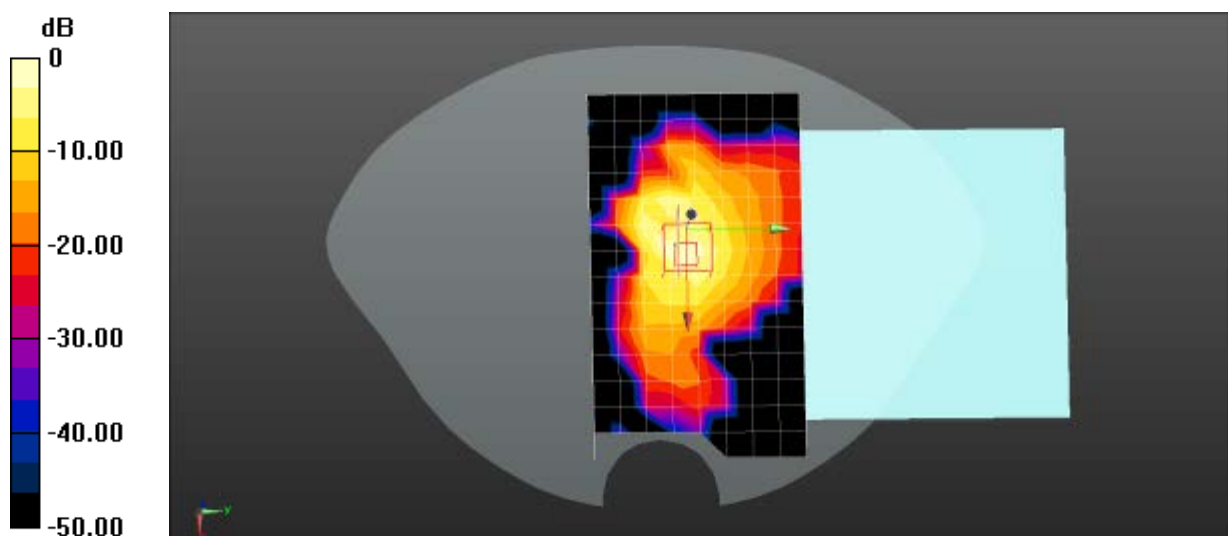

0 dB = 1.23 W/kg = 0.90 dBW/kg



Date/Time: 05/11/2014

Test Laboratory: CerpPASS Lab

DUT: Tablet PC; Type: F5281

Procedure Name: 802.11b 2437MHz Mid Body-Back

Communication System Band: 802.11b; Frequency: 2437 MHz; Duty Cycle: 1:1

Medium parameters used: $f = 2437$ MHz; $\sigma = 1.93$ S/m; $\epsilon_r = 52.71$; $\rho = 1000$ kg/m³

Phantom section: Flat Section; Tissue Temp (celsius) - 21°C

Measurement Standard: DASYS (IEEE/IEC/ANSI C63.19-2011)

DASY5 Configuration:

- Probe: EX3DV4 - SN3927; ConvF(7.63, 7.63, 7.63); Calibrated: 2014/5/23;
- Sensor-Surface: 4mm (Mechanical Surface Detection)
- Electronics: DAE4 Sn1379; Calibrated: 2014/5/19
- Phantom: SAM (30deg probe tilt) with CRP v5.0; Type: QD000P40CD
- Measurement SW: DASYS2, Version 52.8 (8);

Configuration/802.11b 2437MHz Mid Body-Back/Area Scan (15x9x1): Measurement grid:

$dx=12$ mm, $dy=12$ mm, Maximum value of SAR (measured) = 1.31 W/kg

Configuration/802.11b 2437MHz Mid Body-Back/Zoom Scan (5x5x7)/Cube 0: Measurement grid:

$dx=8$ mm, $dy=8$ mm, $dz=5$ mm, Reference Value = 6.497 V/m; Power Drift = 0.19 dB

Peak SAR (extrapolated) = 3.10 W/kg

SAR(1 g) = 1.1 W/kg; SAR(10 g) = 0.370 W/kg Maximum value of SAR (measured) = 1.40 W/kg

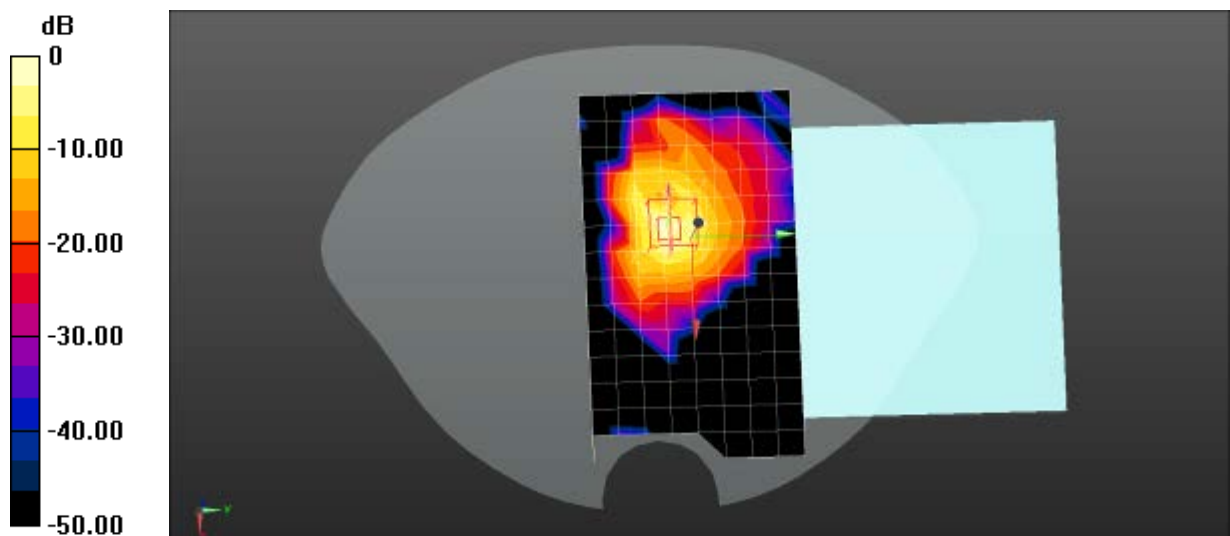

0 dB = 1.40 W/kg = 1.46 dBW/kg



Z-Axis Plot

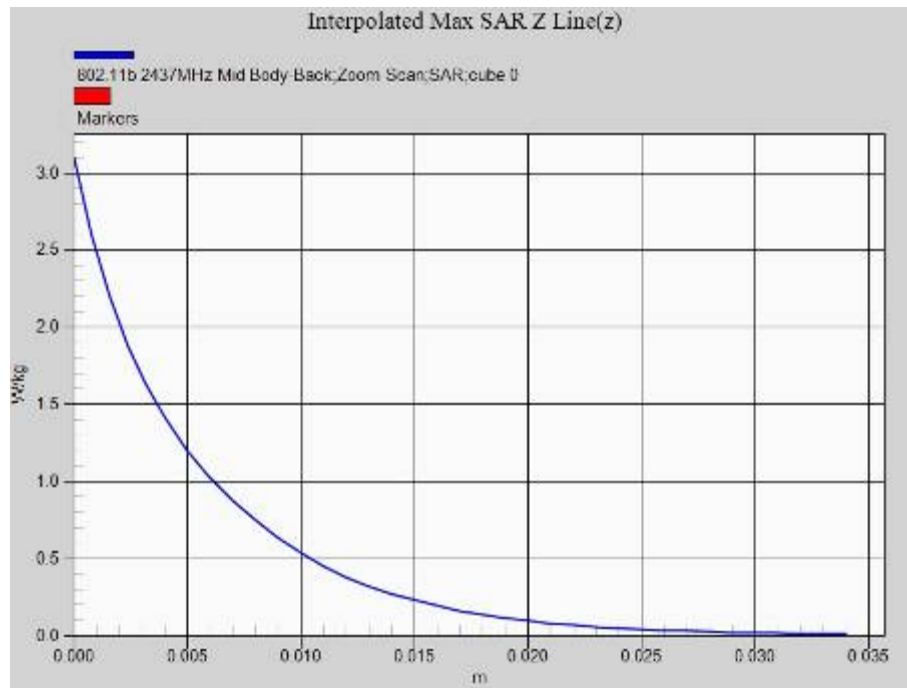



Date/Time: 05/11/2014

Test Laboratory: CerpPASS Lab

DUT: Tablet PC; Type: F5281

Procedure Name: 802.11b 2437MHz Mid Body-Back*

Communication System Band: 802.11b; Frequency: 2437 MHz; Duty Cycle: 1:1

Medium parameters used: $f = 2437$ MHz; $\sigma = 1.93$ S/m; $\epsilon_r = 52.71$; $\rho = 1000$ kg/m³

Phantom section: Flat Section; Tissue Temp (celsius) - 21 °C

Measurement Standard: DASYS (IEEE/IEC/ANSI C63.19-2011)

DASY5 Configuration:

- Probe: EX3DV4 - SN3927; ConvF(7.63, 7.63, 7.63); Calibrated: 2014/5/23;
- Sensor-Surface: 4mm (Mechanical Surface Detection)
- Electronics: DAE4 Sn1379; Calibrated: 2014/5/19
- Phantom: SAM (30deg probe tilt) with CRP v5.0; Type: QD000P40CD
- Measurement SW: DASYS2, Version 52.8 (8);

Configuration/802.11b 2437MHz Mid Body-Back/Area Scan (15x9x1): Measurement grid:

$dx=12$ mm, $dy=12$ mm, Maximum value of SAR (measured) = 1.30 W/kg

Configuration/802.11b 2437MHz Mid Body-Back/Zoom Scan (5x5x7)/Cube 0: Measurement grid:

$dx=8$ mm, $dy=8$ mm, $dz=5$ mm, Reference Value = 6.497 V/m; Power Drift = 0.19 dB

Peak SAR (extrapolated) = 3.08 W/kg

SAR(1 g) = 1.09 W/kg; SAR(10 g) = 0.368 W/kg Maximum value of SAR (measured) = 1.39 W/kg

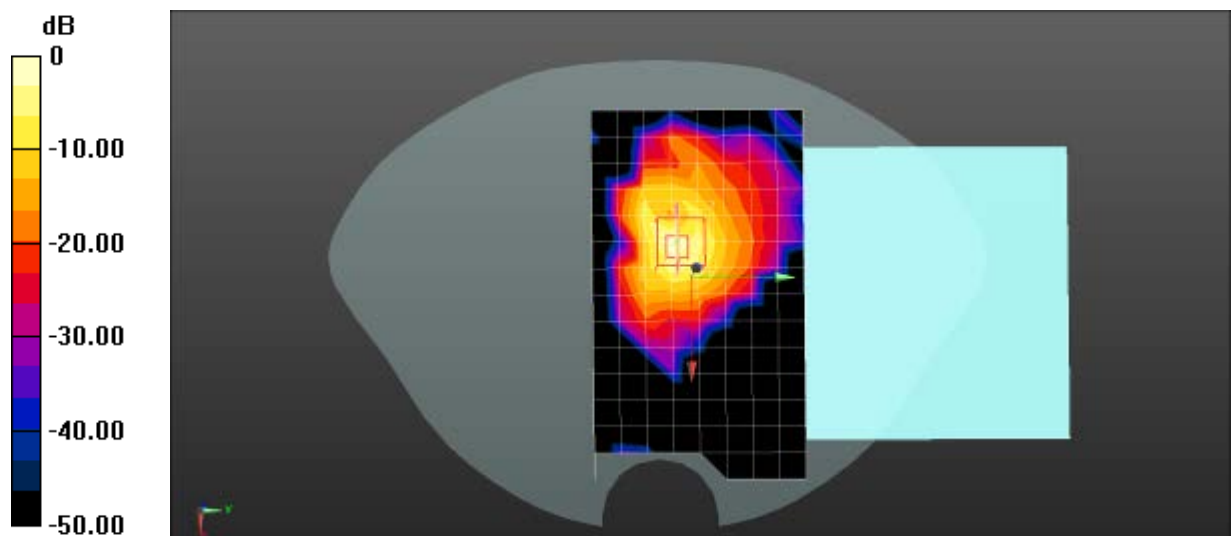

0 dB = 1.39 W/kg = 1.43 dBW/kg



Date/Time: 05/11/2014

Test Laboratory: CerpPASS Lab

DUT: Tablet PC; Type: F5281

Procedure Name: 802.11b 2462MHz Mid Body-Back

Communication System Band: 802.11b; Frequency: 2462 MHz; Duty Cycle: 1:1

Medium parameters used: $f = 2462$ MHz; $\sigma = 1.96$ S/m; $\epsilon_r = 52.65$; $\rho = 1000$ kg/m³

Phantom section: Flat Section; Tissue Temp (celsius) - 21 °C

Measurement Standard: DASYS (IEEE/IEC/ANSI C63.19-2011)

DASY5 Configuration:

- Probe: EX3DV4 - SN3927; ConvF(7.63, 7.63, 7.63); Calibrated: 2014/5/23;
- Sensor-Surface: 4mm (Mechanical Surface Detection)
- Electronics: DAE4 Sn1379; Calibrated: 2014/5/19
- Phantom: SAM (30deg probe tilt) with CRP v5.0; Type: QD000P40CD
- Measurement SW: DASYS2, Version 52.8 (8);

Configuration/802.11b 2462MHz Mid Body-Back/Area Scan (15x9x1): Measurement grid:

$dx=12$ mm, $dy=12$ mm, Maximum value of SAR (measured) = 0.995 W/kg

Configuration/802.11b 2462MHz Mid Body-Back/Zoom Scan (5x5x7)/Cube 0: Measurement grid:

$dx=8$ mm, $dy=8$ mm, $dz=5$ mm, Reference Value = 7.796 V/m; Power Drift = 0.17 dB

Peak SAR (extrapolated) = 3.50 W/kg

SAR(1 g) = 1.01 W/kg; SAR(10 g) = 0.319 W/kg Maximum value of SAR (measured) = 1.16 W/kg

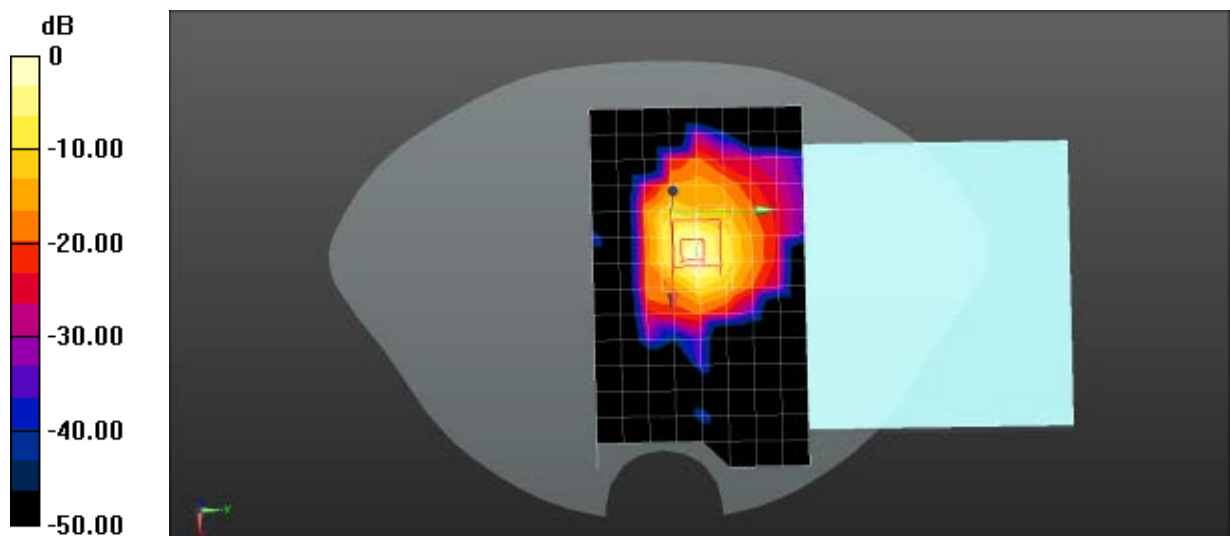

0 dB = 1.16 W/kg = 0.64 dBW/kg



Date/Time: 05/11/2014

Test Laboratory: CerpPASS Lab

DUT: Tablet PC; Type: F5281

Procedure Name: 802.11b 2437MHz Mid Body-Leftside

Communication System Band: 802.11b; Frequency: 2437 MHz; Duty Cycle: 1:1

Medium parameters used: $f = 2437$ MHz; $\sigma = 1.93$ S/m; $\epsilon_r = 52.71$; $\rho = 1000$ kg/m³

Phantom section: Flat Section; Tissue Temp (celsius) - 21°C

Measurement Standard: DASYS5 (IEEE/IEC/ANSI C63.19-2011)

DASY5 Configuration:

- Probe: EX3DV4 - SN3927; ConvF(7.63, 7.63, 7.63); Calibrated: 2014/5/23;
- Sensor-Surface: 4mm (Mechanical Surface Detection)
- Electronics: DAE4 Sn1379; Calibrated: 2014/5/19
- Phantom: SAM (30deg probe tilt) with CRP v5.0; Type: QD000P40CD
- Measurement SW: DASY52, Version 52.8 (8);

Configuration/802.11b 2437MHz Mid Body-Leftside/Area Scan (9x10x1): Measurement grid:

$dx=12$ mm, $dy=12$ mm, Maximum value of SAR (measured) = 0.00360 W/kg

Configuration/802.11b 2437MHz Mid Body-Leftside/Zoom Scan (5x5x7)/Cube 0: Measurement

grid: $dx=8$ mm, $dy=8$ mm, $dz=5$ mm, Reference Value = 0 V/m; Power Drift = 0.01 dB

Peak SAR (extrapolated) = 0.00455 W/kg

SAR(1 g) = 0.000872 W/kg; SAR(10 g) = 0.00013 W/kg Maximum value of SAR (measured) = 0.00408 W/kg

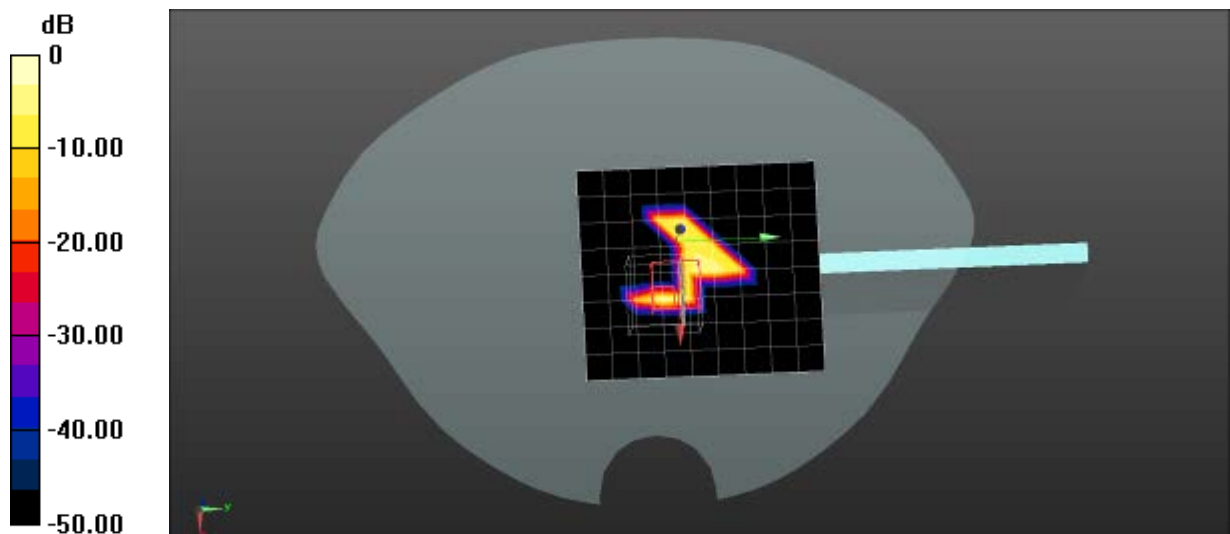

0 dB = 0.00408 W/kg = -23.89 dBW/kg



Date/Time: 05/11/2014

Test Laboratory: CerpPASS Lab

DUT: Tablet PC; Type: F5281

Procedure Name: 802.11b 2437MHz Mid Body-Top

Communication System Band: 802.11b; Frequency: 2437 MHz; Duty Cycle: 1:1

Medium parameters used: $f = 2437$ MHz; $\sigma = 1.93$ S/m; $\epsilon_r = 52.71$; $\rho = 1000$ kg/m³

Phantom section: Flat Section; Tissue Temp (celsius) - 21°C

Measurement Standard: DASYS (IEEE/IEC/ANSI C63.19-2011)

DASY5 Configuration:

- Probe: EX3DV4 - SN3927; ConvF(7.63, 7.63, 7.63); Calibrated: 2014/5/23;
- Sensor-Surface: 4mm (Mechanical Surface Detection)
- Electronics: DAE4 Sn1379; Calibrated: 2014/5/19
- Phantom: SAM (30deg probe tilt) with CRP v5.0; Type: QD000P40CD
- Measurement SW: DASYS2, Version 52.8 (8);

Configuration/802.11b 2437MHz Mid Body-Top/Area Scan (7x14x1): Measurement grid:

$dx=12$ mm, $dy=12$ mm, Maximum value of SAR (measured) = 0.0724 W/kg

Configuration/802.11b 2437MHz Mid Body-Top/Zoom Scan (5x5x7)/Cube 0: Measurement grid:

$dx=8$ mm, $dy=8$ mm, $dz=5$ mm, Reference Value = 3.223 V/m; Power Drift = 0.12 dB

Peak SAR (extrapolated) = 0.116 W/kg

SAR(1 g) = 0.049 W/kg; SAR(10 g) = 0.013 W/kg Maximum value of SAR (measured) = 0.0780 W/kg

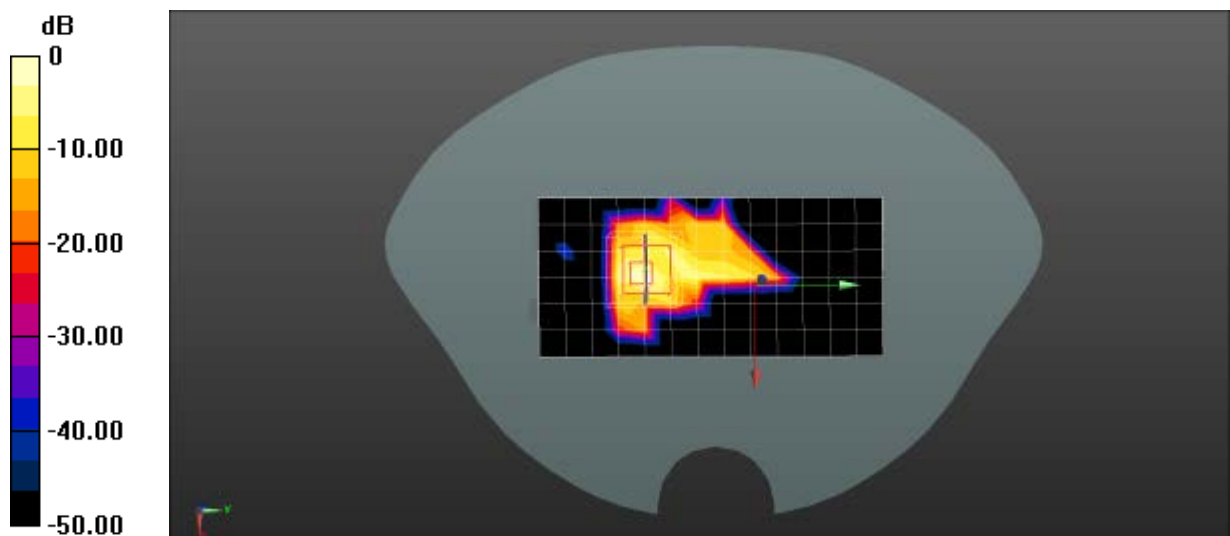

0 dB = 0.0780 W/kg = -11.08 dBW/kg



Date/Time: 05/11/2014

Test Laboratory: CerpPASS Lab

DUT: Tablet PC; Type: F5281

Procedure Name: 802.11g 2437MHz Mid Body-Back

Communication System Band: 802.11g; Frequency: 2437 MHz; Duty Cycle: 1:1

Medium parameters used: $f = 2437$ MHz; $\sigma = 1.93$ S/m; $\epsilon_r = 52.71$; $\rho = 1000$ kg/m³

Phantom section: Flat Section; Tissue Temp (celsius) - 21 °C

Measurement Standard: DASYS (IEEE/IEC/ANSI C63.19-2011)

DASY5 Configuration:

- Probe: EX3DV4 - SN3927; ConvF(7.63, 7.63, 7.63); Calibrated: 2014/5/23;
- Sensor-Surface: 4mm (Mechanical Surface Detection)
- Electronics: DAE4 Sn1379; Calibrated: 2014/5/19
- Phantom: SAM (30deg probe tilt) with CRP v5.0; Type: QD000P40CD
- Measurement SW: DASYS2, Version 52.8 (8);

Configuration/802.11g 2437MHz Mid Body-Back/Area Scan (15x9x1): Measurement grid:

$dx=12$ mm, $dy=12$ mm, Maximum value of SAR (measured) = 0.707 W/kg

Configuration/802.11g 2437MHz Mid Body-Back/Zoom Scan (5x5x7)/Cube 0: Measurement grid:

$dx=8$ mm, $dy=8$ mm, $dz=5$ mm, Reference Value = 5.278 V/m; Power Drift = 0.19 dB

Peak SAR (extrapolated) = 3.30 W/kg

SAR(1 g) = 0.921 W/kg; SAR(10 g) = 0.285 W/kg Maximum value of SAR (measured) = 1.05 W/kg

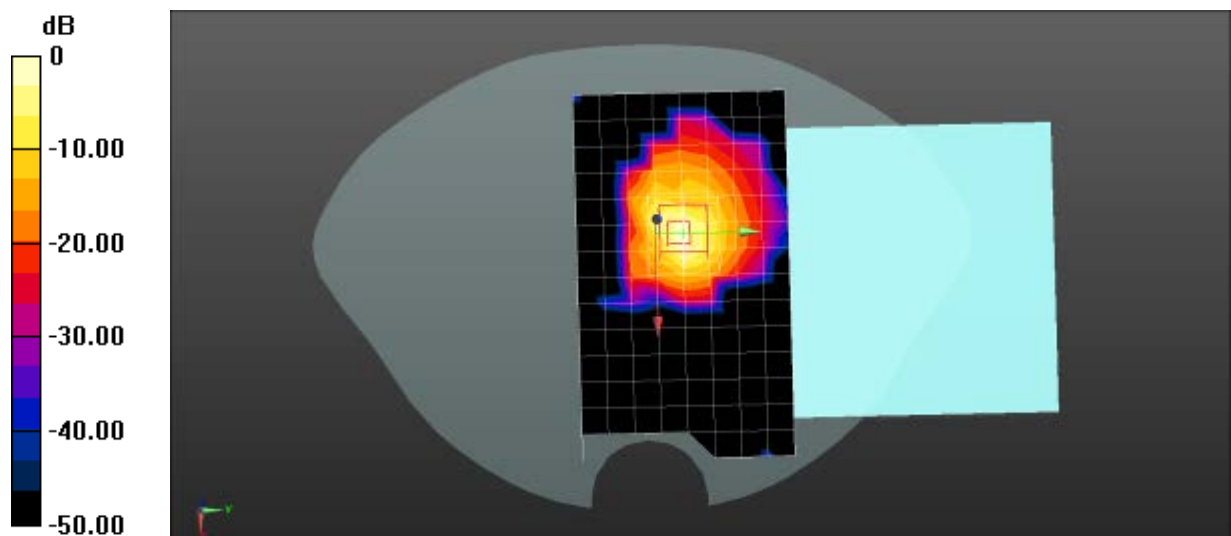

0 dB = 1.05 W/kg = 0.21 dBW/kg



Date/Time: 05/11/2014

Test Laboratory: CerpPASS Lab

DUT: Tablet PC; Type: F5281

Procedure Name: 802.11n(20MHz) 2437MHz Mid Body-Back

Communication System Band: 802.11n(20MHz); Frequency: 2437 MHz; Duty Cycle: 1:1

Medium parameters used: $f = 2437 \text{ MHz}$; $\sigma = 1.93 \text{ S/m}$; $\epsilon_r = 52.71$; $\rho = 1000 \text{ kg/m}^3$

Phantom section: Flat Section; Tissue Temp (celsius) - 21°C

Measurement Standard: DASYS (IEEE/IEC/ANSI C63.19-2011)

DASY5 Configuration:

- Probe: EX3DV4 - SN3927; ConvF(7.63, 7.63, 7.63); Calibrated: 2014/5/23;
- Sensor-Surface: 4mm (Mechanical Surface Detection)
- Electronics: DAE4 Sn1379; Calibrated: 2014/5/19
- Phantom: SAM (30deg probe tilt) with CRP v5.0; Type: QD000P40CD
- Measurement SW: DASYS2, Version 52.8 (8);

Configuration/802.11n(20MHz) 2437MHz Mid Body-Back/Area Scan (15x9x1): Measurement grid:

$dx=12\text{mm}$, $dy=12\text{mm}$, Maximum value of SAR (measured) = 0.553 W/kg

Configuration/802.11n(20MHz) 2437MHz Mid Body-Back/Zoom Scan (5x5x7)/Cube 0:

Measurement grid: $dx=8\text{mm}$, $dy=8\text{mm}$, $dz=5\text{mm}$, Reference Value = 4.234 V/m ; Power Drift = 0.10

dB, Peak SAR (extrapolated) = 2.62 W/kg

SAR(1 g) = 0.745 W/kg ; SAR(10 g) = 0.229 W/kg Maximum value of SAR (measured) = 0.792 W/kg

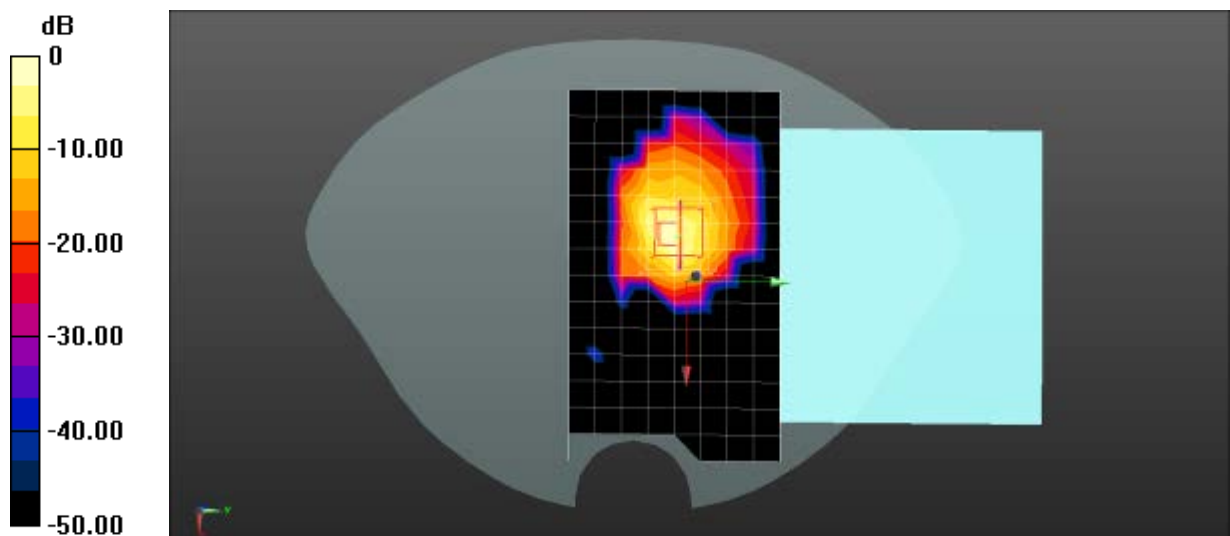

0 dB = 0.792 W/kg = -1.01 dBW/kg



8. APPENDIX C. EUT and Test Setup Photos

Note: To see another attachment



9. APPENDIX D. Probe Calibration Data

**Calibration Laboratory of
Schmid & Partner
Engineering AG**
Zeughausstrasse 43, 8004 Zurich, Switzerland



S Schweizerischer Kalibrierdienst
S Service suisse d'étalonnage
S Servizio svizzero di taratura
S Swiss Calibration Service

Accredited by the Swiss Accreditation Service (SAS)
The Swiss Accreditation Service is one of the signatories to the EA
Multilateral Agreement for the recognition of calibration certificates

Accreditation No.: **SCS 108**

Client **CerpPASS (Auden)**

Certificate No: **EX3-3927_May14**

CALIBRATION CERTIFICATE	
Object	EX3DV4 - SN:3927
Calibration procedure(s)	QA CAL-01.v9, QA CAL-12.v9, QA CAL-14.v4, QA CAL-23.v5, QA CAL-25.v6 Calibration procedure for dosimetric E-field probes
Calibration date:	May 23, 2014
This calibration certificate documents the traceability to national standards, which realize the physical units of measurements (SI). The measurements and the uncertainties with confidence probability are given on the following pages and are part of the certificate.	
All calibrations have been conducted in the closed laboratory facility: environment temperature (22 ± 3)°C and humidity < 70%.	
Calibration Equipment used (M&TE critical for calibration)	

Primary Standards	ID	Cal Date (Certificate No.)	Scheduled Calibration
Power meter E4419B	GB41293B74	03-Apr-14 (No. 217-01911)	Apr-15
Power sensor E4412A	MY41498087	03-Apr-14 (No. 217-01911)	Apr-15
Reference 3 dB Attenuator	SN: S5054 (3c)	03-Apr-14 (No. 217-01915)	Apr-15
Reference 20 dB Attenuator	SN: S5277 (20x)	03-Apr-14 (No. 217-01919)	Apr-15
Reference 30 dB Attenuator	SN: S5129 (30b)	03-Apr-14 (No. 217-01920)	Apr-15
Reference Probe ES3DV2	SN: 3013	30-Dec-13 (No. ES3-3013_Dec13)	Dec-14
DAE4	SN: 660	13-Dec-13 (No. DAE4-660 Dec13)	Dec-14
Secondary Standards	ID	Check Date (in house)	Scheduled Check
RF generator HP 8648C	US3642U01700	4-Aug-99 (in house check Apr-13)	In house check: Apr-16
Network Analyzer HP B753E	US37390585	19-Oct-01 (in house check Oct-13)	In house check: Oct-14

Calibrated by:	Name Claudio Leubler	Function Laboratory Technician	 Issued: May 23, 2014
Approved by:	Name Katja Pokovic	Function Technical Manager	
This calibration certificate shall not be reproduced except in full without written approval of the laboratory.			



**Calibration Laboratory of
Schmid & Partner
Engineering AG**
Zeughausstrasse 43, 8004 Zurich, Switzerland



S Schweizerischer Kalibrierdienst
C Service suisse d'étalonnage
S Servizio svizzero di taratura
S Swiss Calibration Service

Accredited by the Swiss Accreditation Service (SAS)
The Swiss Accreditation Service is one of the signatories to the EA
Multilateral Agreement for the recognition of calibration certificates

Accreditation No.: **SCS 108**

Glossary:

TSL	tissue simulating liquid
NORM _{x,y,z}	sensitivity in free space
ConvF	sensitivity in TSL / NORM _{x,y,z}
DCP	diode compression point
CF	crest factor (1/duty_cycle) of the RF signal
A, B, C, D	modulation dependent linearization parameters
Polarization φ	φ rotation around probe axis
Polarization θ	θ rotation around an axis that is in the plane normal to probe axis (at measurement center), i.e., $\theta = 0$ is normal to probe axis
Connector Angle	information used in DASY system to align probe sensor X to the robot coordinate system

Calibration is Performed According to the Following Standards:

- IEEE Std 1528-2013, "IEEE Recommended Practice for Determining the Peak Spatial-Averaged Specific Absorption Rate (SAR) in the Human Head from Wireless Communications Devices: Measurement Techniques", June 2013
- IEC 62209-1, "Procedure to measure the Specific Absorption Rate (SAR) for hand-held devices used in close proximity to the ear (frequency range of 300 MHz to 3 GHz)", February 2005

Methods Applied and Interpretation of Parameters:

- NORM_{x,y,z}**: Assessed for E-field polarization $\theta = 0$ ($f \leq 900$ MHz in TEM-cell; $f > 1800$ MHz: R22 waveguide). NORM_{x,y,z} are only intermediate values, i.e., the uncertainties of NORM_{x,y,z} does not affect the E²-field uncertainty inside TSL (see below ConvF).
- NORM(f)_{x,y,z} = NORM_{x,y,z} * frequency_response** (see Frequency Response Chart). This linearization is implemented in DASY4 software versions later than 4.2. The uncertainty of the frequency response is included in the stated uncertainty of ConvF.
- DCP_{x,y,z}**: DCP are numerical linearization parameters assessed based on the data of power sweep with CW signal (no uncertainty required). DCP does not depend on frequency nor media.
- PAR**: PAR is the Peak to Average Ratio that is not calibrated but determined based on the signal characteristics
- A_{x,y,z}; B_{x,y,z}; C_{x,y,z}; D_{x,y,z}; VR_{x,y,z}**: A, B, C, D are numerical linearization parameters assessed based on the data of power sweep for specific modulation signal. The parameters do not depend on frequency nor media. VR is the maximum calibration range expressed in RMS voltage across the diode.
- ConvF and Boundary Effect Parameters**: Assessed in flat phantom using E-field (or Temperature Transfer Standard for $f \leq 800$ MHz) and inside waveguide using analytical field distributions based on power measurements for $f > 800$ MHz. The same setups are used for assessment of the parameters applied for boundary compensation (alpha, depth) of which typical uncertainty values are given. These parameters are used in DASY4 software to improve probe accuracy close to the boundary. The sensitivity in TSL corresponds to NORM_{x,y,z} * ConvF whereby the uncertainty corresponds to that given for ConvF. A frequency dependent ConvF is used in DASY version 4.4 and higher which allows extending the validity from ± 50 MHz to ± 100 MHz.
- Spherical isotropy (3D deviation from isotropy)**: in a field of low gradients realized using a flat phantom exposed by a patch antenna.
- Sensor Offset**: The sensor offset corresponds to the offset of virtual measurement center from the probe tip (on probe axis). No tolerance required.
- Connector Angle**: The angle is assessed using the information gained by determining the NORM_x (no uncertainty required).



EX3DV4 – SN:3927

May 23, 2014

Probe EX3DV4

SN:3927

Manufactured: March 8, 2013
Calibrated: May 23, 2014

Calibrated for DASY/EASY Systems
(Note: non-compatible with DASY2 system!)



EX3DV4-- SN:3927

May 23, 2014

DASY/EASY - Parameters of Probe: EX3DV4 - SN:3927

Basic Calibration Parameters

	Sensor X	Sensor Y	Sensor Z	Unc (k=2)
Norm ($\mu\text{V}/(\text{V}/\text{m})^2$) ^A	0.57	0.33	0.61	± 10.1 %
DCP (mV) ^B	96.7	96.5	92.4	

Modulation Calibration Parameters

UID	Communication System Name		A dB	B dB√μV	C	D dB	VR mV	Unc ^E (k=2)
0	CW	X	0.0	0.0	1.0	0.00	133.2	±3.3 %
		Y	0.0	0.0	1.0		148.7	
		Z	0.0	0.0	1.0		135.9	

The reported uncertainty of measurement is stated as the standard uncertainty of measurement multiplied by the coverage factor k=2, which for a normal distribution corresponds to a coverage probability of approximately 95%.

^A The uncertainties of NormX,Y,Z do not affect the E²-field uncertainty inside TSL (see Pages 5 and 6).

^B Numerical linearization parameter: uncertainty not required.

^E Uncertainty is determined using the max. deviation from linear response applying rectangular distribution and is expressed for the square of the field value.



EX3DV4- SN:3927

May 23, 2014

DASY/EASY - Parameters of Probe: EX3DV4 - SN:3927**Calibration Parameter Determined in Head Tissue Simulating Media**

f (MHz) ^C	Relative Permittivity ^F	Conductivity (S/m) ^F	ConvF X	ConvF Y	ConvF Z	Alpha ^G	Depth ^G (mm)	Unct. (k=2)
450	43.5	0.87	11.02	11.02	11.02	0.15	1.30	± 13.3 %
850	41.5	0.92	10.23	10.23	10.23	0.43	0.81	± 12.0 %
1750	40.1	1.37	8.55	8.55	8.55	0.40	0.90	± 12.0 %
1900	40.0	1.40	8.31	8.31	8.31	0.60	0.66	± 12.0 %
2100	39.8	1.49	8.47	8.47	8.47	0.56	0.65	± 12.0 %
2450	39.2	1.80	7.48	7.48	7.48	0.68	0.59	± 12.0 %
5200	36.0	4.66	5.35	5.35	5.35	0.30	1.80	± 13.1 %
5500	35.6	4.96	4.97	4.97	4.97	0.35	1.80	± 13.1 %
5600	35.5	5.07	4.78	4.78	4.78	0.40	1.80	± 13.1 %
5800	35.3	5.27	4.65	4.65	4.65	0.40	1.80	± 13.1 %

^C Frequency validity above 300 MHz of ± 100 MHz only applies for DASY v4.4 and higher (see Page 2), else it is restricted to ± 50 MHz. The uncertainty is the RSS of the ConvF uncertainty at calibration frequency and the uncertainty for the indicated frequency band. Above 5 GHz frequency validity can be extended to ± 110 MHz. Frequency validity below 300 MHz is ± 10, 25, 40, 50 and 70 MHz for ConvF assessments at 30, 84, 128, 150 and 220 MHz respectively.

^F At frequencies below 3 GHz, the validity of tissue parameters (ϵ and σ) can be relaxed to ± 10% if liquid compensation formula is applied to measured SAR values. At frequencies above 3 GHz, the validity of tissue parameters (ϵ and σ) is restricted to ± 5%. The uncertainty is the RSS of the ConvF uncertainty for indicated target tissue parameters.

^G Alpha/Depth are determined during calibration. SPEAG warrants that the remaining deviation due to the boundary effect after compensation is always less than ± 1% for frequencies below 3 GHz and below ± 2% for frequencies between 3-6 GHz at any distance larger than half the probe tip diameter from the boundary.



EX3DV4- SN:3927

May 23, 2014

DASY/EASY - Parameters of Probe: EX3DV4 - SN:3927**Calibration Parameter Determined in Body Tissue Simulating Media**

f (MHz) ^C	Relative Permittivity ^F	Conductivity (S/m) ^F	ConvF X	ConvF Y	ConvF Z	Alpha ^G	Depth ^G (mm)	Unct. (k=2)
450	56.7	0.94	11.67	11.67	11.67	0.10	1.20	± 13.3 %
850	55.2	0.99	9.91	9.91	9.91	0.28	1.18	± 12.0 %
1750	53.4	1.49	8.45	8.45	8.45	0.71	0.64	± 12.0 %
1900	53.3	1.52	8.10	8.10	8.10	0.38	0.91	± 12.0 %
2100	53.2	1.62	8.40	8.40	8.40	0.40	0.87	± 12.0 %
2450	52.7	1.95	7.63	7.63	7.63	0.80	0.50	± 12.0 %
5200	49.0	5.30	4.61	4.61	4.61	0.40	1.90	± 13.1 %
5500	48.6	5.65	4.30	4.30	4.30	0.40	1.90	± 13.1 %
5600	48.5	5.77	4.23	4.23	4.23	0.40	1.90	± 13.1 %
5800	48.2	6.00	4.25	4.25	4.25	0.45	1.90	± 13.1 %

^C Frequency validity above 300 MHz of ± 100 MHz only applies for DASY v4.4 and higher (see Page 2), else it is restricted to ± 50 MHz. The uncertainty is the RSS of the ConvF uncertainty at calibration frequency and the uncertainty for the indicated frequency band. Above 5 GHz frequency validity can be extended to ± 110 MHz. Frequency validity below 300 MHz is ± 10, 25, 40, 50 and 70 MHz for ConvF assessments at 30, 64, 128, 150 and 220 MHz respectively.

^F At frequencies below 3 GHz, the validity of tissue parameters (ϵ and σ) can be relaxed to ± 10% if liquid compensation formula is applied to measured SAR values. At frequencies above 3 GHz, the validity of tissue parameters (ϵ and σ) is restricted to ± 5%. The uncertainty is the RSS of the ConvF uncertainty for indicated target tissue parameters.

^G Alpha/Depth are determined during calibration. SPEAG warrants that the remaining deviation due to the boundary effect after compensation is always less than ± 1% for frequencies below 3 GHz and below ± 2% for frequencies between 3-6 GHz at any distance larger than half the probe tip diameter from the boundary.



EX3DV4- SN:3927

May 23, 2014

Frequency Response of E-Field (TEM-Cell: ifi110 EXX, Waveguide: R22)

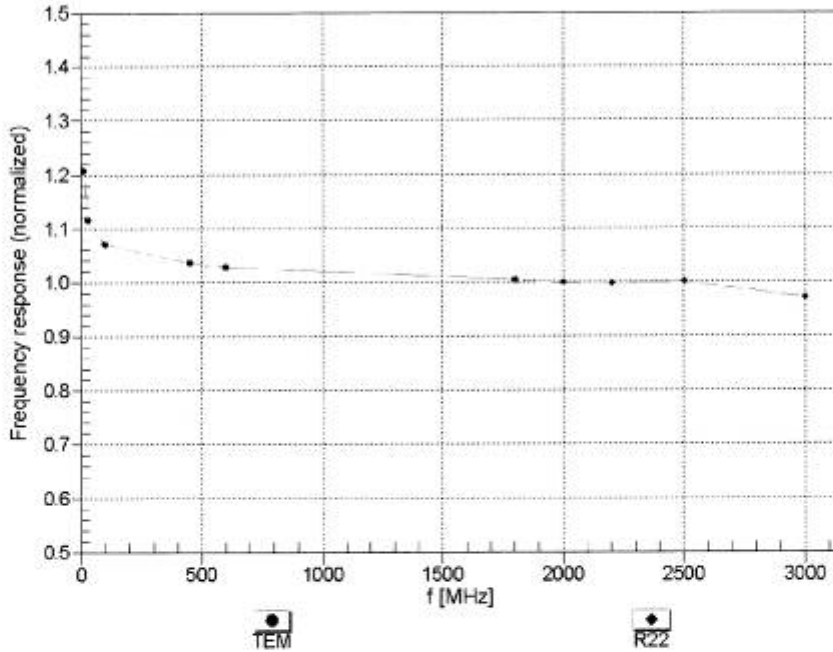

Uncertainty of Frequency Response of E-field: $\pm 6.3\%$ (k=2)



EX3DV4- SN:3927

May 23, 2014

Receiving Pattern (ϕ), $\theta = 0^\circ$

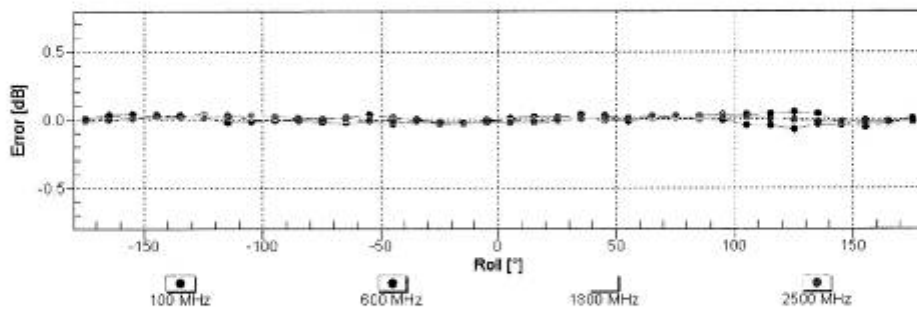
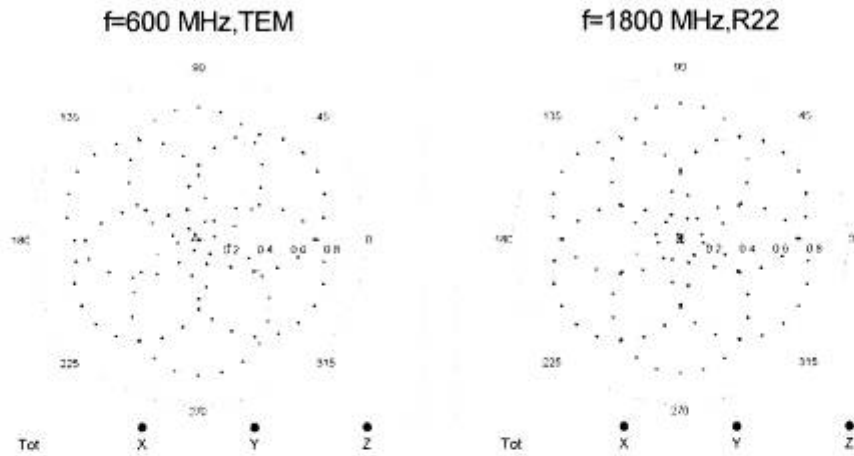

Uncertainty of Axial Isotropy Assessment: $\pm 0.5\%$ ($k=2$)



EX3DV4- SN:3927

May 23, 2014

Dynamic Range $f(SAR_{head})$ (TEM cell , $f_{eval}=1900$ MHz)

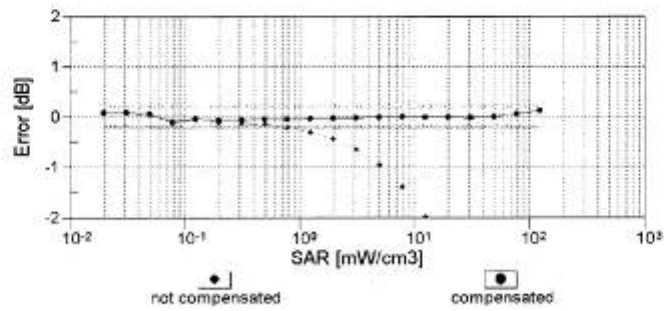
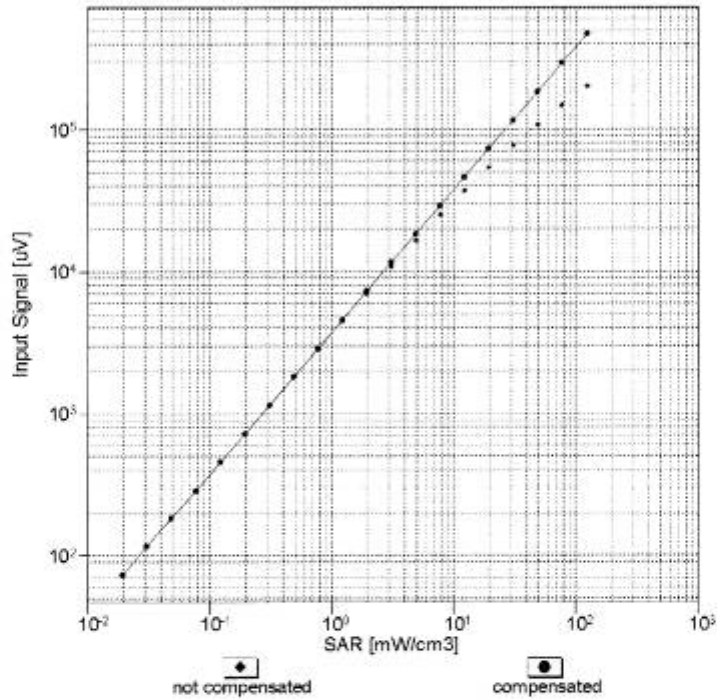

Uncertainty of Linearity Assessment: $\pm 0.6\%$ (k=2)



EX3DV4- SN:3927

May 23, 2014

Conversion Factor Assessment

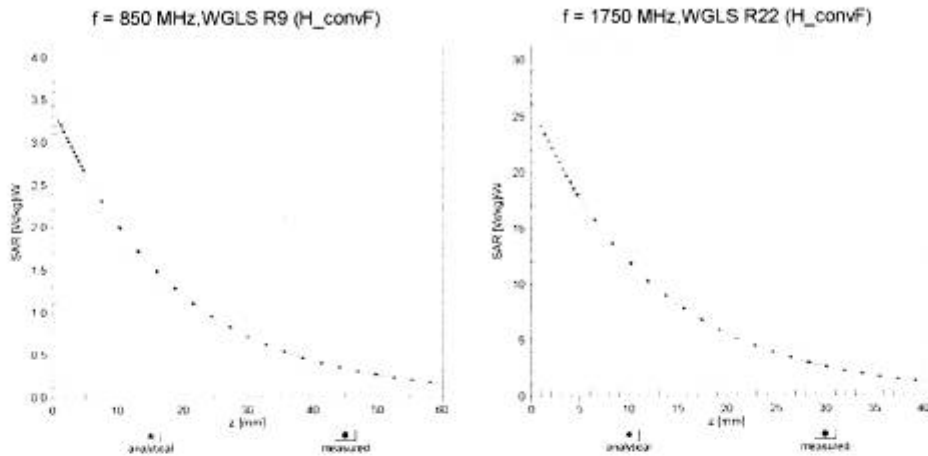

Deviation from Isotropy in Liquid Error (ϕ, θ), f = 900 MHz

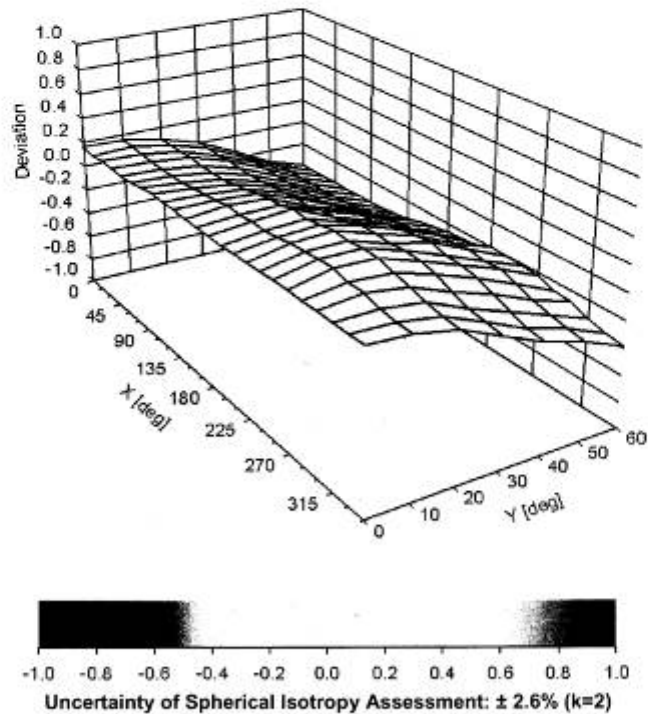



EX3DV4- SN:3927

May 23, 2014

DASY/EASY - Parameters of Probe: EX3DV4 - SN:3927

Other Probe Parameters

Sensor Arrangement	Triangular
Connector Angle (°)	25.1
Mechanical Surface Detection Mode	enabled
Optical Surface Detection Mode	disabled
Probe Overall Length	337 mm
Probe Body Diameter	10 mm
Tip Length	9 mm
Tip Diameter	2.5 mm
Probe Tip to Sensor X Calibration Point	1 mm
Probe Tip to Sensor Y Calibration Point	1 mm
Probe Tip to Sensor Z Calibration Point	1 mm
Recommended Measurement Distance from Surface	2 mm



10. Appendix E. Dipole Calibration Data

Calibration Laboratory of Schmid & Partner Engineering AG
Zeughausstrasse 43, 8004 Zurich, Switzerland



S Schweizerischer Kalibrierdienst
S Service suisse d'étalonnage
C Servizio svizzero di taratura
S Swiss Calibration Service

Accredited by the Swiss Accreditation Service (SAS)
The Swiss Accreditation Service is one of the signatories to the EA Multilateral Agreement for the recognition of calibration certificates

Accreditation No.: **SCS 108**

Client **CerpPASS (Auden)**

Certificate No: **D2450V2-914_Jun13**

CALIBRATION CERTIFICATE																																															
Object	D2450V2 - SN: 914																																														
Calibration procedure(s)	QA CAL-05.v9 Calibration procedure for dipole validation kits above 700 MHz																																														
Calibration date:	June 07, 2013																																														
<p>This calibration certificate documents the traceability to national standards, which realize the physical units of measurements (SI). The measurements and the uncertainties with confidence probability are given on the following pages and are part of the certificate.</p> <p>All calibrations have been conducted in the closed laboratory facility: environment temperature (22 ± 3)°C and humidity < 70%.</p> <p>Calibration Equipment used (M&TE critical for calibration)</p> <table border="1"> <thead> <tr> <th>Primary Standards</th> <th>ID #</th> <th>Cal Date (Certificate No.)</th> <th>Scheduled Calibration</th> </tr> </thead> <tbody> <tr> <td>Power meter EPM-442A</td> <td>GBS7480704</td> <td>01-Nov-12 (No. 217-01640)</td> <td>Oct-13</td> </tr> <tr> <td>Power sensor HP 8481A</td> <td>US37292783</td> <td>01-Nov-12 (No. 217-01640)</td> <td>Oct-13</td> </tr> <tr> <td>Reference 20 dB Attenuator</td> <td>SN: 5058 (20k)</td> <td>04-Apr-13 (No. 217-01736)</td> <td>Apr-14</td> </tr> <tr> <td>Type-N mismatch combination</td> <td>SN: 5047.3 / 06327</td> <td>04-Apr-13 (No. 217-01739)</td> <td>Apr-14</td> </tr> <tr> <td>Reference Probe ES3DV3</td> <td>SN: 3205</td> <td>28-Dec-12 (No. ESS-3205_Dec12)</td> <td>Dec-13</td> </tr> <tr> <td>DAE4</td> <td>SN: 601</td> <td>25-Apr-13 (No. DAE4-601_Apr13)</td> <td>Apr-14</td> </tr> </tbody> </table> <table border="1"> <thead> <tr> <th>Secondary Standards</th> <th>ID #</th> <th>Check Date (in house)</th> <th>Scheduled Check</th> </tr> </thead> <tbody> <tr> <td>Power sensor HP 8481A</td> <td>MY41092317</td> <td>18-Oct-02 (in house check Oct-11)</td> <td>In house check: Oct-13</td> </tr> <tr> <td>RF generator R&S SMT-06</td> <td>100005</td> <td>04-Aug-99 (in house check Oct-11)</td> <td>In house check: Oct-13</td> </tr> <tr> <td>Network Analyzer HP 8753E</td> <td>US37390585 S4206</td> <td>18-Oct-01 (in house check Oct-12)</td> <td>In house check: Oct-13</td> </tr> </tbody> </table>				Primary Standards	ID #	Cal Date (Certificate No.)	Scheduled Calibration	Power meter EPM-442A	GBS7480704	01-Nov-12 (No. 217-01640)	Oct-13	Power sensor HP 8481A	US37292783	01-Nov-12 (No. 217-01640)	Oct-13	Reference 20 dB Attenuator	SN: 5058 (20k)	04-Apr-13 (No. 217-01736)	Apr-14	Type-N mismatch combination	SN: 5047.3 / 06327	04-Apr-13 (No. 217-01739)	Apr-14	Reference Probe ES3DV3	SN: 3205	28-Dec-12 (No. ESS-3205_Dec12)	Dec-13	DAE4	SN: 601	25-Apr-13 (No. DAE4-601_Apr13)	Apr-14	Secondary Standards	ID #	Check Date (in house)	Scheduled Check	Power sensor HP 8481A	MY41092317	18-Oct-02 (in house check Oct-11)	In house check: Oct-13	RF generator R&S SMT-06	100005	04-Aug-99 (in house check Oct-11)	In house check: Oct-13	Network Analyzer HP 8753E	US37390585 S4206	18-Oct-01 (in house check Oct-12)	In house check: Oct-13
Primary Standards	ID #	Cal Date (Certificate No.)	Scheduled Calibration																																												
Power meter EPM-442A	GBS7480704	01-Nov-12 (No. 217-01640)	Oct-13																																												
Power sensor HP 8481A	US37292783	01-Nov-12 (No. 217-01640)	Oct-13																																												
Reference 20 dB Attenuator	SN: 5058 (20k)	04-Apr-13 (No. 217-01736)	Apr-14																																												
Type-N mismatch combination	SN: 5047.3 / 06327	04-Apr-13 (No. 217-01739)	Apr-14																																												
Reference Probe ES3DV3	SN: 3205	28-Dec-12 (No. ESS-3205_Dec12)	Dec-13																																												
DAE4	SN: 601	25-Apr-13 (No. DAE4-601_Apr13)	Apr-14																																												
Secondary Standards	ID #	Check Date (in house)	Scheduled Check																																												
Power sensor HP 8481A	MY41092317	18-Oct-02 (in house check Oct-11)	In house check: Oct-13																																												
RF generator R&S SMT-06	100005	04-Aug-99 (in house check Oct-11)	In house check: Oct-13																																												
Network Analyzer HP 8753E	US37390585 S4206	18-Oct-01 (in house check Oct-12)	In house check: Oct-13																																												
Calibrated by:	Name Leif Klyener	Function Laboratory Technician	Signature 																																												
Approved by:	Name Katja Pokovic	Function Technical Manager	Signature 																																												
			Issued: June 7, 2013																																												
This calibration certificate shall not be reproduced except in full without written approval of the laboratory.																																															



Calibration Laboratory of
Schmid & Partner
Engineering AG
Zeughausstrasse 43, 8004 Zurich, Switzerland



S Schweizerischer Kalibrierdienst
S Service suisse d'étalonnage
C Servizio svizzero di taratura
S Swiss Calibration Service

Accredited by the Swiss Accreditation Service (SAS)
The Swiss Accreditation Service is one of the signatories to the EA
Multilateral Agreement for the recognition of calibration certificates

Accreditation No.: SCS 108

Glossary:

TSL tissue simulating liquid
ConvF sensitivity in TSL / NORM x,y,z
N/A not applicable or not measured

Calibration is Performed According to the Following Standards:

- a) IEEE Std 1528-2003, "IEEE Recommended Practice for Determining the Peak Spatial-Averaged Specific Absorption Rate (SAR) in the Human Head from Wireless Communications Devices: Measurement Techniques", December 2003
- b) IEC 62209-1, "Procedure to measure the Specific Absorption Rate (SAR) for hand-held devices used in close proximity to the ear (frequency range of 300 MHz to 3 GHz)", February 2005
- c) Federal Communications Commission Office of Engineering & Technology (FCC OET), "Evaluating Compliance with FCC Guidelines for Human Exposure to Radiofrequency Electromagnetic Fields; Additional Information for Evaluating Compliance of Mobile and Portable Devices with FCC Limits for Human Exposure to Radiofrequency Emissions", Supplement C (Edition 01-01) to Bulletin 65

Additional Documentation:

- d) DASY4/5 System Handbook

Methods Applied and Interpretation of Parameters:

- *Measurement Conditions:* Further details are available from the Validation Report at the end of the certificate. All figures stated in the certificate are valid at the frequency indicated.
- *Antenna Parameters with TSL:* The dipole is mounted with the spacer to position its feed point exactly below the center marking of the flat phantom section, with the arms oriented parallel to the body axis.
- *Feed Point Impedance and Return Loss:* These parameters are measured with the dipole positioned under the liquid filled phantom. The impedance stated is transformed from the measurement at the SMA connector to the feed point. The Return Loss ensures low reflected power. No uncertainty required.
- *Electrical Delay:* One-way delay between the SMA connector and the antenna feed point. No uncertainty required.
- *SAR measured:* SAR measured at the stated antenna input power.
- *SAR normalized:* SAR as measured, normalized to an input power of 1 W at the antenna connector.
- *SAR for nominal TSL parameters:* The measured TSL parameters are used to calculate the nominal SAR result.

The reported uncertainty of measurement is stated as the standard uncertainty of measurement multiplied by the coverage factor k=2, which for a normal distribution corresponds to a coverage probability of approximately 95%.

**Measurement Conditions**

DASY system configuration, as far as not given on page 1.

DASY Version	DASY5	V52.8.7
Extrapolation	Advanced Extrapolation	
Phantom	Modular Flat Phantom	
Distance Dipole Center - TSL	10 mm	with Spacer
Zoom Scan Resolution	dx, dy, dz = 5 mm	
Frequency	2450 MHz \pm 1 MHz	

Head TSL parameters

The following parameters and calculations were applied.

	Temperature	Permittivity	Conductivity
Nominal Head TSL parameters	22.0 °C	39.2	1.80 mho/m
Measured Head TSL parameters	(22.0 \pm 0.2) °C	37.8 \pm 6 %	1.81 mho/m \pm 6 %
Head TSL temperature change during test	< 0.5 °C	----	----

SAR result with Head TSL

SAR averaged over 1 cm³ (1 g) of Head TSL	Condition	
SAR measured	250 mW input power	13.5 W/kg
SAR for nominal Head TSL parameters	normalized to 1W	53.4 W/kg \pm 17.0 % (k=2)

SAR averaged over 10 cm³ (10 g) of Head TSL	condition	
SAR measured	250 mW input power	6.24 W/kg
SAR for nominal Head TSL parameters	normalized to 1W	24.8 W/kg \pm 16.5 % (k=2)

Body TSL parameters

The following parameters and calculations were applied.

	Temperature	Permittivity	Conductivity
Nominal Body TSL parameters	22.0 °C	52.7	1.95 mho/m
Measured Body TSL parameters	(22.0 \pm 0.2) °C	50.9 \pm 6 %	2.02 mho/m \pm 6 %
Body TSL temperature change during test	< 0.5 °C	----	----

SAR result with Body TSL

SAR averaged over 1 cm³ (1 g) of Body TSL	Condition	
SAR measured	250 mW input power	13.2 W/kg
SAR for nominal Body TSL parameters	normalized to 1W	51.5 W/kg \pm 17.0 % (k=2)

SAR averaged over 10 cm³ (10 g) of Body TSL	condition	
SAR measured	250 mW input power	6.07 W/kg
SAR for nominal Body TSL parameters	normalized to 1W	23.9 W/kg \pm 16.5 % (k=2)

**Appendix****Antenna Parameters with Head TSL**

Impedance, transformed to feed point	57.0 Ω + 1.9 j Ω
Return Loss	- 23.3 dB

Antenna Parameters with Body TSL

Impedance, transformed to feed point	52.1 Ω + 3.5 j Ω
Return Loss	- 28.0 dB

General Antenna Parameters and Design

Electrical Delay (one direction)	1.160 ns
----------------------------------	----------

After long term use with 100W radiated power, only a slight warming of the dipole near the feedpoint can be measured.

The dipole is made of standard semirigid coaxial cable. The center conductor of the feeding line is directly connected to the second arm of the dipole. The antenna is therefore short-circuited for DC-signals. On some of the dipoles, small end caps are added to the dipole arms in order to improve matching when loaded according to the position as explained in the "Measurement Conditions" paragraph. The SAR data are not affected by this change. The overall dipole length is still according to the Standard.

No excessive force must be applied to the dipole arms, because they might bend or the soldered connections near the feedpoint may be damaged.

Additional EUT Data

Manufactured by	SPEAG
Manufactured on	December 19, 2012



DASY5 Validation Report for Head TSL

Date: 07.06.2013

Test Laboratory: SPEAG, Zurich, Switzerland

DUT: Dipole 2450 MHz; Type: D2450V2; Serial: D2450V2 - SN: 914

Communication System: UID 0 - CW ; Frequency: 2450 MHz

Medium parameters used: $f = 2450$ MHz; $\sigma = 1.81$ S/m; $\epsilon_r = 37.8$; $\rho = 1000$ kg/m³

Phantom section: Flat Section

Measurement Standard: DASY5 (IEEE/IEC/ANSI C63.19-2007)

DASY52 Configuration:

- Probe: ES3DV3 - SN3205; ConvF(4.52, 4.52, 4.52); Calibrated: 28.12.2012;
- Sensor-Surface: 3mm (Mechanical Surface Detection)
- Electronics: DAE4 Sn601; Calibrated: 25.04.2013
- Phantom: Flat Phantom 5.0 (front); Type: QD000P50AA; Serial: 1001
- DASY52 52.8.7(1137); SEMCAD X 14.6.10(7164)

Dipole Calibration for Head Tissue/Pin=250 mW, d=10mm/Zoom Scan (7x7x7)/Cube 0:

Measurement grid: dx=5mm, dy=5mm, dz=5mm

Reference Value = 95.695 V/m; Power Drift = 0.05 dB

Peak SAR (extrapolated) = 28.3 W/kg

SAR(1 g) = 13.5 W/kg; SAR(10 g) = 6.24 W/kg

Maximum value of SAR (measured) = 17.6 W/kg

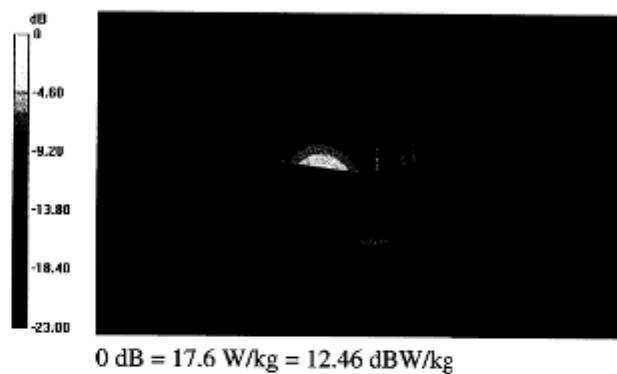



Impedance Measurement Plot for Head TSL

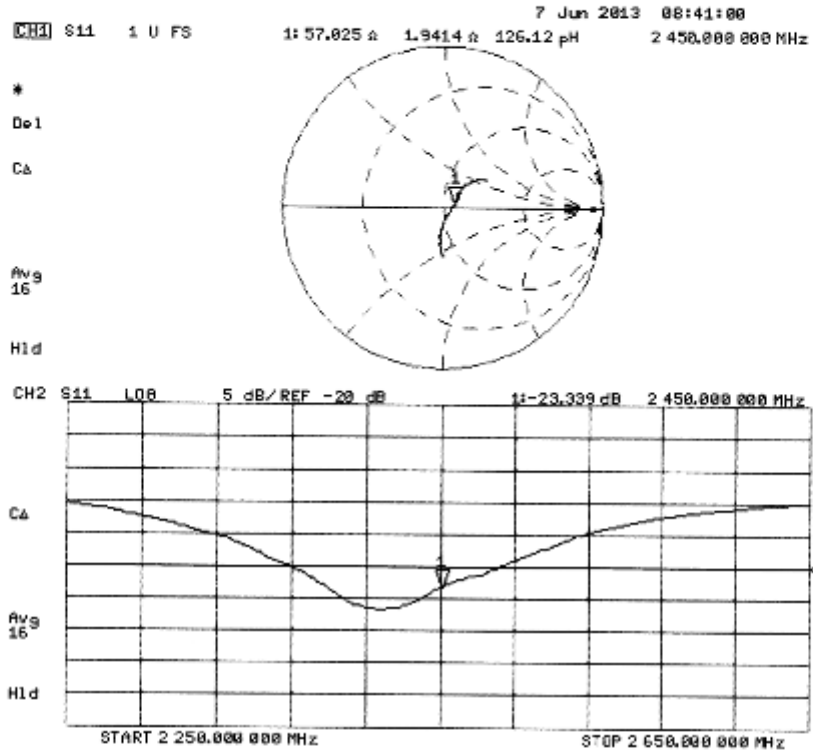

**DASY5 Validation Report for Body TSL**

Date: 07.06.2013

Test Laboratory: SPEAG, Zurich, Switzerland

DUT: Dipole 2450 MHz; Type: D2450V2; Serial: D2450V2 - SN: 914

Communication System: UID 0 - CW ; Frequency: 2450 MHz

Medium parameters used: $f = 2450$ MHz; $\sigma = 2.02$ S/m; $\epsilon_r = 50.9$; $\rho = 1000$ kg/m³

Phantom section: Flat Section

Measurement Standard: DASY5 (IEEE/IEC/ANSI C63.19-2007)

DASY52 Configuration:

- Probe: ES3DV3 - SN3205; ConvF(4.42, 4.42, 4.42); Calibrated: 28.12.2012;
- Sensor-Surface: 3mm (Mechanical Surface Detection)
- Electronics: DAE4 Sn601; Calibrated: 25.04.2013
- Phantom: Flat Phantom 5.0 (back); Type: QD000P50AA; Serial: 1002
- DASY52 52.8.7(1137); SEMCAD X 14.6.10(7164)

Dipole Calibration for Body Tissue/Pin=250 mW, d=10mm/Zoom Scan (7x7x7)/Cube 0:

Measurement grid: dx=5mm, dy=5mm, dz=5mm

Reference Value = 95.695 V/m; Power Drift = 0.01 dB

Peak SAR (extrapolated) = 27.6 W/kg

SAR(1 g) = 13.2 W/kg; SAR(10 g) = 6.07 W/kg

Maximum value of SAR (measured) = 17.5 W/kg

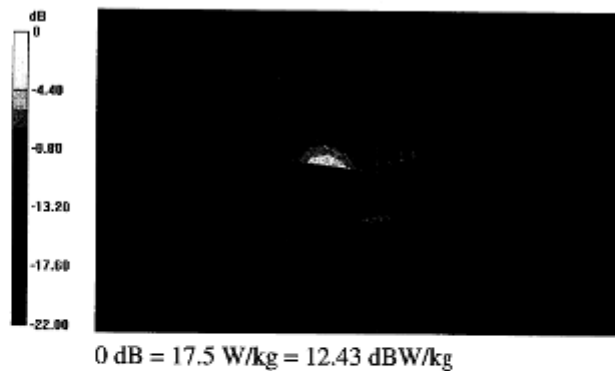



Impedance Measurement Plot for Body TSL

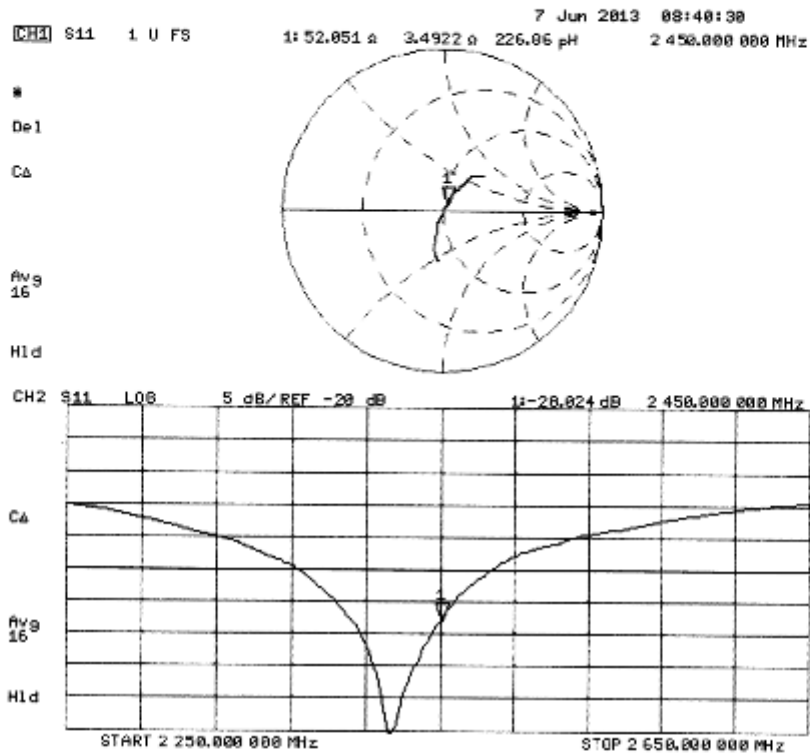



Appendix F. DAE Calibration Data

Calibration Laboratory of Schmid & Partner Engineering AG Zeughausstrasse 43, 8004 Zurich, Switzerland



S Schweizerischer Kalibrierdienst
C Service suisse d'etalonnage
S Servizio svizzero di taratura
S Swiss Calibration Service

Accredited by the Swiss Accreditation Service (SAS)
The Swiss Accreditation Service is one of the signatories to the EA Multilateral Agreement for the recognition of calibration certificates

Accreditation No.: SCS 108

Client CerpPASS (Auden)

Certificate No: DAE4-1379_May14

CALIBRATION CERTIFICATE

Object: DAE4 - SD 000 D04 BJ - SN: 1379
Calibration procedure(s): QA CAL-06.v26 Calibration procedure for the data acquisition electronics (DAE)
Calibration date: May 19, 2014

This calibration certificate documents the traceability to national standards, which realize the physical units of measurements (SI). The measurements and the uncertainties with confidence probability are given on the following pages and are part of the certificate.

All calibrations have been conducted in the closed laboratory facility: environment temperature (22 ± 3)°C and humidity < 70%.

Calibration Equipment used (M&TE critical for calibration)

Table with 4 columns: Standards, ID #, Date/Check Date, and Scheduled Calibration/Check. Includes Primary Standards (Keithley Multimeter) and Secondary Standards (Auto DAE Calibration Unit, Calibrator Box).

Calibrated by: Dominique Steffen, Technician
Approved by: Fin Bomholt, Deputy Technical Manager

Signature of Dominique Steffen and Fin Bomholt

Issued: May 19, 2014

This calibration certificate shall not be reproduced except in full without written approval of the laboratory.



Calibration Laboratory of
Schmid & Partner
Engineering AG
Zeughausstrasse 43, 8004 Zurich, Switzerland



S Schweizerischer Kalibrierdienst
C Service suisse d'étalonnage
S Servizio svizzero di taratura
S Swiss Calibration Service

Accredited by the Swiss Accreditation Service (SAS)
The Swiss Accreditation Service is one of the signatories to the EA
Multilateral Agreement for the recognition of calibration certificates

Accreditation No.: SCS 108

Glossary

DAE data acquisition electronics
Connector angle information used in DASY system to align probe sensor X to the robot coordinate system.

Methods Applied and Interpretation of Parameters

- *DC Voltage Measurement:* Calibration Factor assessed for use in DASY system by comparison with a calibrated instrument traceable to national standards. The figure given corresponds to the full scale range of the voltmeter in the respective range.
- *Connector angle:* The angle of the connector is assessed measuring the angle mechanically by a tool inserted. Uncertainty is not required.
- The following parameters as documented in the Appendix contain technical information as a result from the performance test and require no uncertainty.
 - *DC Voltage Measurement Linearity:* Verification of the Linearity at +10% and -10% of the nominal calibration voltage. Influence of offset voltage is included in this measurement.
 - *Common mode sensitivity:* Influence of a positive or negative common mode voltage on the differential measurement.
 - *Channel separation:* Influence of a voltage on the neighbor channels not subject to an input voltage.
 - *AD Converter Values with inputs shorted:* Values on the internal AD converter corresponding to zero input voltage
 - *Input Offset Measurement:* Output voltage and statistical results over a large number of zero voltage measurements.
 - *Input Offset Current:* Typical value for information; Maximum channel input offset current, not considering the input resistance.
 - *Input resistance:* Typical value for information: DAE input resistance at the connector, during internal auto-zeroing and during measurement.
 - *Low Battery Alarm Voltage:* Typical value for information. Below this voltage, a battery alarm signal is generated.
 - *Power consumption:* Typical value for information. Supply currents in various operating modes.



DC Voltage Measurement

A/D - Converter Resolution nominal

High Range: 1LSB = 6.1µV , full range = -100...+300 mV

Low Range: 1LSB = 61nV , full range = -1.....+3mV

DASY measurement parameters: Auto Zero Time: 3 sec; Measuring time: 3 sec

Calibration Factors	X	Y	Z
High Range	403.805 ± 0.02% (k=2)	404.075 ± 0.02% (k=2)	404.011 ± 0.02% (k=2)
Low Range	3.99838 ± 1.50% (k=2)	3.99504 ± 1.50% (k=2)	4.00152 ± 1.50% (k=2)

Connector Angle

Connector Angle to be used in DASY system	149.5 ° ± 1 °
---	---------------



Appendix

1. DC Voltage Linearity

High Range	Reading (μV)	Difference (μV)	Error (%)
Channel X + Input	199994.29	-1.98	-0.00
Channel X + Input	19999.30	-1.30	-0.01
Channel X - Input	-19998.41	2.90	-0.01
Channel Y + Input	199996.73	0.29	0.00
Channel Y + Input	19996.72	-3.84	-0.02
Channel Y - Input	-20001.24	-0.12	0.00
Channel Z + Input	199995.04	-1.34	-0.00
Channel Z + Input	19998.92	-1.47	-0.01
Channel Z - Input	-20002.08	-0.85	0.00

Low Range	Reading (μV)	Difference (μV)	Error (%)
Channel X + Input	2001.97	1.11	0.06
Channel X + Input	201.61	0.19	0.10
Channel X - Input	-198.88	-0.22	0.11
Channel Y + Input	2001.25	0.31	0.02
Channel Y + Input	201.42	0.07	0.03
Channel Y - Input	-199.14	-0.59	0.30
Channel Z + Input	2001.40	0.60	0.03
Channel Z + Input	199.50	-1.64	-0.82
Channel Z - Input	-199.24	-0.49	0.25

2. Common mode sensitivity

DASY measurement parameters: Auto Zero Time: 3 sec; Measuring time: 3 sec

	Common mode Input Voltage (mV)	High Range Average Reading (μV)	Low Range Average Reading (μV)
Channel X	200	-17.61	-19.05
	-200	20.93	18.82
Channel Y	200	-4.43	-4.39
	-200	4.21	4.00
Channel Z	200	-10.49	-10.31
	-200	8.62	8.36

3. Channel separation

DASY measurement parameters: Auto Zero Time: 3 sec; Measuring time: 3 sec

	Input Voltage (mV)	Channel X (μV)	Channel Y (μV)	Channel Z (μV)
Channel X	200	-	-0.60	-5.10
Channel Y	200	8.15	-	0.34
Channel Z	200	10.42	5.32	-

**4. AD-Converter Values with inputs shorted**

DASY measurement parameters: Auto Zero Time: 3 sec; Measuring time: 3 sec

	High Range (LSB)	Low Range (LSB)
Channel X	16034	13894
Channel Y	16256	12489
Channel Z	15825	15529

5. Input Offset Measurement

DASY measurement parameters: Auto Zero Time: 3 sec; Measuring time: 3 sec

Input 10M Ω

	Average (μ V)	min. Offset (μ V)	max. Offset (μ V)	Std. Deviation (μ V)
Channel X	-1.79	-3.29	-0.79	0.47
Channel Y	-0.21	-2.44	1.81	0.71
Channel Z	-0.03	-1.33	2.40	0.79

6. Input Offset Current

Nominal Input circuitry offset current on all channels: <25fA

7. Input Resistance (Typical values for information)

	Zeroing (kOhm)	Measuring (MOhm)
Channel X	200	200
Channel Y	200	200
Channel Z	200	200

8. Low Battery Alarm Voltage (Typical values for information)

Typical values	Alarm Level (VDC)
Supply (+ Vcc)	+7.9
Supply (- Vcc)	-7.6

9. Power Consumption (Typical values for information)

Typical values	Switched off (mA)	Stand by (mA)	Transmitting (mA)
Supply (+ Vcc)	+0.01	+6	+14
Supply (- Vcc)	-0.01	-8	-9