

 **NOTE**

For usage in Mexico , operation of this equipment is subject to the following two conditions : 1 ) it is possible that this device doesn't cause any detrimental interference and 2 ) this device must take any kind of interference , including that which may cause its malfunctioning.

# Hisense

# USER MANUAL

Before using the TV, please read this manual thoroughly and retain it for future reference.

## Copyright Statement

© 2017 Hisense Company Ltd. All Rights Reserved.

All material in this User Manual is the property of Hisense Company Ltd. and its subsidiaries, and is protected under US, CANADA, MEXICO and International copyright and/or other intellectual property laws. Reproduction or transmission of the materials, in whole or in part, in any manner, electronic, print, or otherwise, without the prior written consent of Hisense Company Ltd. is a violation of Hisense Company Ltd. rights under the aforementioned laws.

No part of this publication may be stored, reproduced, transmitted or distributed, in whole or in part, in any manner, electronic or otherwise, whether or not for a charge or other or no consideration, without the prior written permission of Hisense Company Ltd.

Requests for permission to store, reproduce, transmit or distribute materials may be made to one of the following addresses:

USA: Hisense USA Corporation  
PO Box 3289  
Suwanee, GA 30024

CANADA: Hisense Canada Co., Ltd,  
2283 Argentia Road, Unit 16  
Mississauga, ON, Canada, L5N 5Z2

MEXICO: Hisense Mexico S de RL de CV  
Boulevard Miguel de Cervantes Saavedra No. 301, Torre Norte, Piso 2,  
Colonia Ampliación Granada, C.P. 11520, en México Distrito Federal.

Hisense, and any and all other Hisense product names, logo's, slogans or marks are registered trademarks of Hisense Company Ltd. and its subsidiaries. All other trademarks are the property of their respective holders.

## Disclaimer Page

*\*\*Notwithstanding anything to the contrary, including in any or all descriptions, representations, statements or other communications related to this Hisense device (hereinafter "Device") made in any form whatsoever and at any time, some or all of the pre-installed, or subsequently installed Application Services may not be available or capable of functioning as intended by the provider of the Application Services in any or all usage areas for reasons outside of Hisense's control, including but not limited to, Internet access, local service limitations, etc. Any purchase or use of the Device, including any Application Services, is purely at the user's risk. Application Services are provided on an as-available basis without warranties of any kind, either expressed or implied, that the Application Service will be uninterrupted or error-free, including but not limited to vagaries of weather, disruption of Service, acts of God, warranties of title, local or regional limitations, no infringement, NOR IMPLIED WARRANTIES OF MERCHANTABILITY OR FITNESS FOR A PARTICULAR PURPOSE. No advice or information given by Hisense, providers, affiliates, or contractors or their respective employees shall create such a warranty. Hisense specifically disclaims responsibility for any or all Application Services from functioning at any time, and by purchasing the Device, you accept such disclaimer without any claim on Hisense. You are solely responsible for providing an active and working connection to the Internet, along with any and all hardware and/or software necessary to use the Hisense Device as intended.*

**Disclaimer:**

**Images throughout this document are for illustrative purposes only and may differ from the actual product.**

# Table of Contents

<b>Connecting Devices to your TV</b> .....	<b>3</b>
Connecting an antenna, cable set-top box or satellite receiver .....	3
Connecting an AV device with a composite video cable .....	3
Connecting an AV device with a component video cable .....	4
Connecting an AV device with an HDMI cable .....	4
Connecting headphones .....	5
Connecting speakers (or other audio receivers) .....	5
Connecting a digital sound bar to use ARC (Audio Return Channel) .....	6
<b>Connecting Your TV to a Wired or Wireless Network</b> .....	<b>7</b>
Connecting to a Wireless network .....	7
Connecting to a Wired (Ethernet) network .....	7
<b>Using Your TV Remote Control</b> .....	<b>9</b>
<b>Shortcuts Instructions</b> .....	<b>11</b>
<b>Completing the First-Time Setup Menu</b> .....	<b>12</b>
<b>Basic and Advanced TV Settings</b> .....	<b>14</b>
Accessing the Quick Setup Menu .....	14
Picture Menu .....	14
Sound Menu .....	15
Channel Menu .....	15
Network Menu .....	15
System Menu .....	16
About TV Menu .....	17

# Table of Contents

<b>Parental Controls .....</b>	<b>18</b>
<b>Getting familiar with the Home screen .....</b>	<b>20</b>
<b>Live TV .....</b>	<b>21</b>
Viewing channel information .....	21
Viewing a channel list .....	21
Creating a 'Favorites' list .....	21
Viewing your 'Favorites' list .....	21
<b>Apps.....</b>	<b>22</b>
Apps .....	22
Customizing the name of your TV .....	23
<b>Media .....</b>	<b>23</b>
Panels that appear on the Media screen .....	23
File formats that are supported .....	23
Viewing video.....	23
Browsing content .....	23
Viewing Pictures as a slideshow.....	24
<b>Mirroring content from your device to the TV .....</b>	<b>24</b>
<b>Software updates for your TV .....</b>	<b>25</b>
<b>Quick Problem-Solving Tips.....</b>	<b>26</b>

# Connecting Devices to your TV

## Connecting Devices to your TV

You have several options for connecting your TV to different devices. The method in which you connect will be based upon the type of cables you have and the available outputs on your device.

### Connecting an antenna, cable set-top box or satellite receiver

To connect an antenna, cable set-top box or satellite receiver:

1. Connect one end of a coaxial cable (not included) to the **[RF OUT]** jack on the antenna, cable or satellite box. If you are using an antenna with twin-lead cable, you may need a 300-75 Ohm adapter (not provided) to connect it to the back of your TV. Likewise, if you are using several antennas, you may need a combiner (not provided).
2. Connect the other end of the cable to the **[ANT/CABLE]** jack on the side of TV.
3. Using your remote, press the **[INPUT]** button and select TV as the input source.

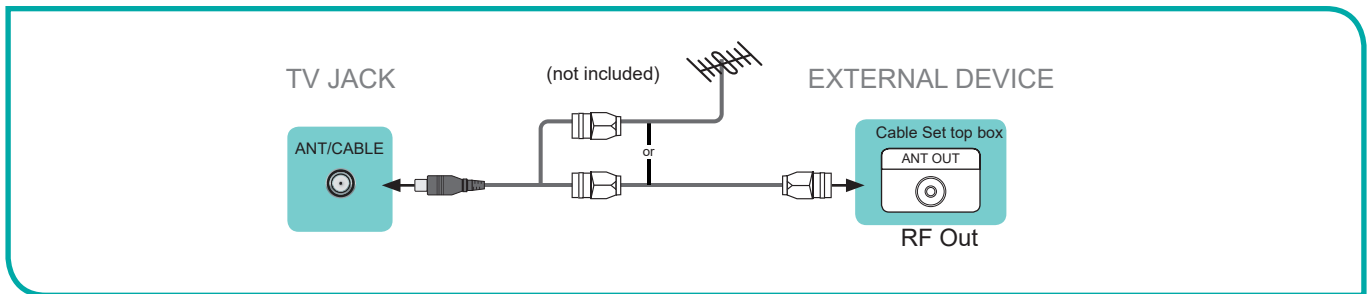

Figure 1. Antenna, cable set-top box or satellite receiver to the TV

### Connecting an AV device with a composite video cable (yellow/red/white)

To connect an AV device with a composite video cable (not provided):

1. Use the audio and video cables to connect the composite video/audio jacks (of the external AV device) to the **[AV IN]** jacks of the TV. (Video = yellow, Audio Left = white, and Audio Right = red).
2. Plug the connected devices into the AV connectors on the TV before switching it on.
3. Using your remote, press the **[INPUT]** button and select **AV** as the input source.

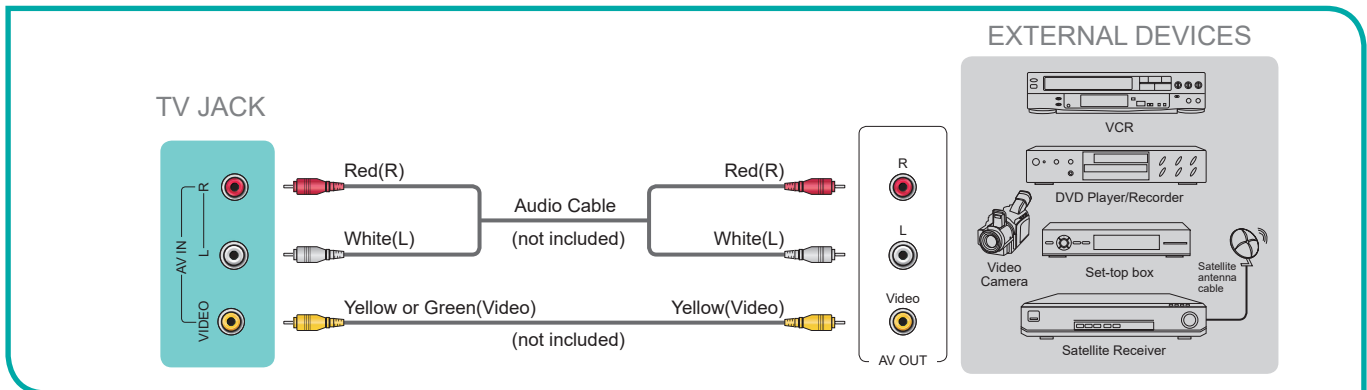

Figure 2. AV device with a composite video cable

# Connecting Devices to your TV

## Connecting an AV device with a component video cable (red/blue/green)

To connect an AV device with a component cable (which is red/blue/green):

1. Use a component video cable (not provided) to connect the component output jacks of the external device to the **YP<sub>B</sub>P<sub>R</sub>** jacks for the TV. Use an audio cable to connect the component audio jacks of the external device to the TV AUDIO (L/R) jacks.
2. Plug the connected devices into the YP<sub>B</sub>P<sub>R</sub> and L/R ports on the TV before switching it on.
3. Using your remote, press the **[INPUT]** button and select **COMPONENT** as the input source.

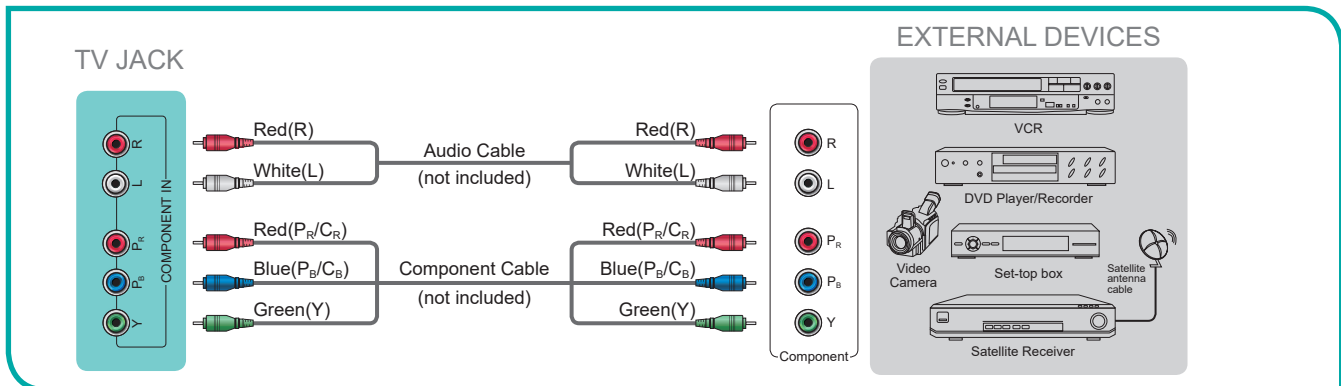

Figure 3. AV device with a component video cable

### NOTE

One AV device can be connected to the TV using a component video or composite video cable.

## Connecting an AV device with an HDMI cable

This type of connection supports digital connections between HDMI-enabled AV devices such as a Personal Video Recorder (PVR), DVD, Blu-Ray, AV receiver and digital devices. In addition, some devices (such as a PVR or DVD player) require an HDMI signal to be set to **Output** in the settings of the device.

Please refer to the User Manual that came with your device for step-by-step instructions.

To connect an AV device with an HDMI cable:

1. Use an HDMI cable to connect the **[HDMI]** output port of the AV device to the **[HDMI]** jack of the TV.
2. Plug the connected devices into the power socket.
3. Using your remote, press the **[INPUT]** button and select the corresponding HDMI input.

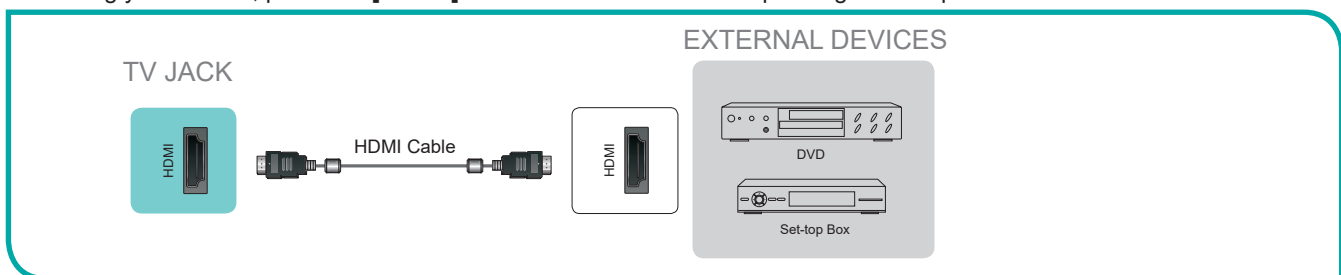

Figure 4. AV device with an HDMI cable

### NOTES

- Because the HDMI connector provides video and audio signals, it is not necessary to connect an audio cable.
- The HDMI cable will not be supplied with the product.
- We strongly recommend to use HDMI Cable with 2 cores as shown in the figure.



# Connecting Devices to your TV

## Connecting headphones

You can connect headphones to the **[AUDIO OUT]** port on your TV. While the headphone is connected, the sound from the built-in speakers will be disabled.

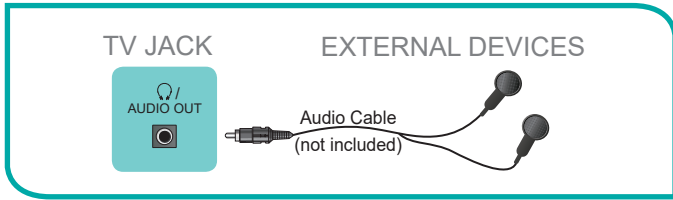

Figure 5. Headphones to the TV

## Connecting speakers (or other audio receivers)

To connect speakers (or other audio receivers) with an audio cable:

1. Use an audio cable (not provided) to connect the **[DIGITAL AUDIO IN]** jack of the audio receiver device to the **[DIGITAL AUDIO OUT]** jack of the TV. Another option is to use an RCA Y-cable (1/8"-stereo mini to L/R phono) to connect an analog sound system to the **[AUDIO OUT]** jack of the TV.
2. Plug the connected devices into the main power socket before switching on the TV.

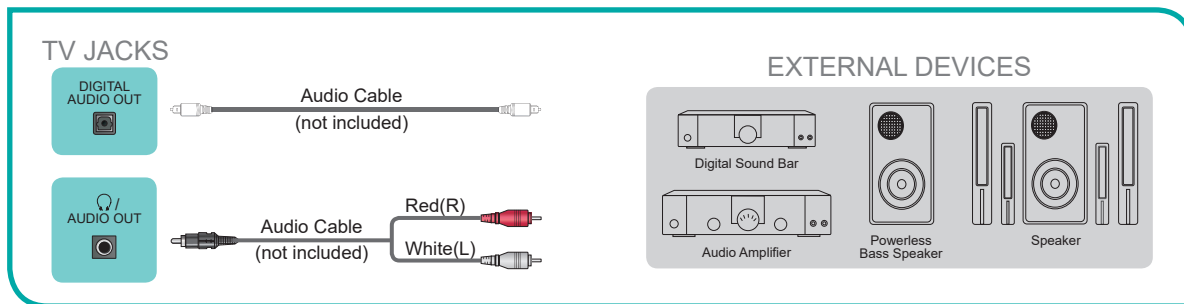

Figure 6. Audio receiver with audio cable

### NOTE

If you prefer to use Audio Return Channel, then follow the steps on the next page under 'Connecting a digital sound bar to use Audio Return Channel'.

### NOTES

- When a digital audio system is connected to the **[DIGITAL AUDIO OUT]** jack, decrease the TV and system volume.
- 5.1 CH (channel) audio is available when the TV is connected to an external device that supports a 5.1 channel surround sound
- You can receive 5.1 channel audio in one of two ways. The first way is to connect the **[DIGITAL AUDIO OUT]** jack from the device to the Amplifier. The second way is to connect the **[DIGITAL AUDIO OUT]** jack on the back of the TV to the **[Optical]** port on the Amplifier. After you've completed one of the two methods then be sure to go into the Advanced Audio Settings of the TV and select RAW to receive the 5.1 channel audio. You will need to also go into the sound or audio settings of your device to ensure it is set to 5.1 Channel output. It may read 'Bitstream', 'RAW' or 'Digital'.

# Connecting Devices to your TV

## Connecting a digital sound bar to use ARC (Audio Return Channel)

If you'd like to use the Audio Return Channel (ARC) feature to have sound sent from the TV back down an HDMI cable to a digital sound bar, then you will need to connect the cable to the **[HDMI (ARC)]** port. By using this feature, you will also be able to control the sound bar with your TV remote instead of having to use multiple remotes for each device.

### NOTE

Only digital sound bars that require a wired connection are compatible with the H6 Series Smart TV.

To connect a digital sound bar with an HDMI cable:

1. Connect the cable that's attached to the soundbar to the HDMI (ARC) port on the TV.
2. Turn on the sound bar by pressing the Power button.
3. Press the **[Quick Setup menu]** button on your remote and go to **System > CEC Function**
4. Turn on the **CEC Control** setting.
5. Select **Sound > Advance Audio Settings > TV Speaker & ARC** and select **ARC First**.
6. If the device has an 'Input Selector' feature then make sure to change it to 'TV'.

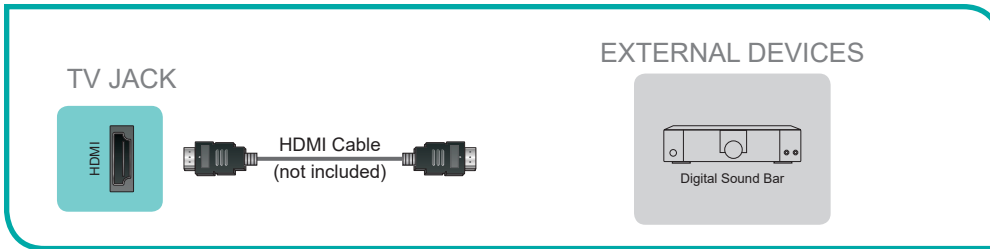

Figure 7. Digital Sound Bar to the HDMI (ARC) port

# Connecting your TV to a Wired or Wireless Network

## Connecting Your TV to a Wired or Wireless Network

You have the option to connect your TV to a wireless or wired network to access the Internet.

### Connecting to a Wireless Network

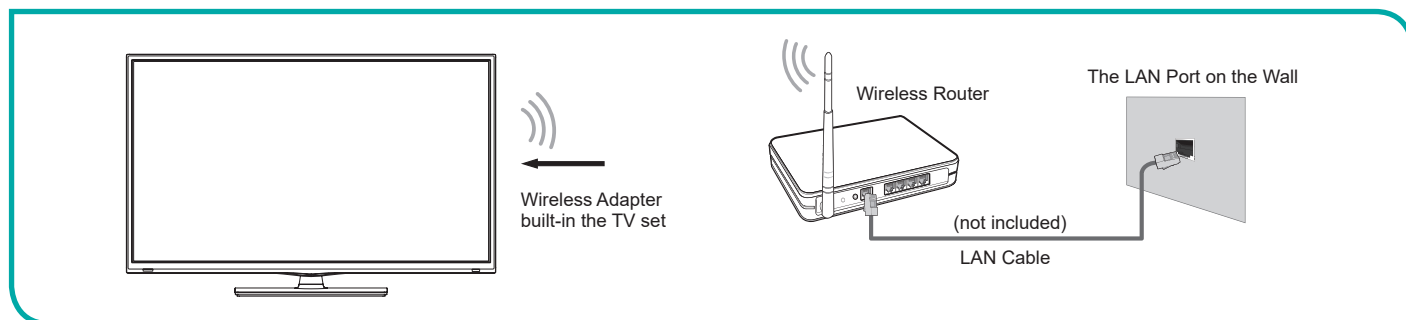

Figure 8. Connect the TV to a wireless network

Our built-in wireless LAN adapter supports the IEEE 802.11 b/g/n communication protocols and we recommend that you use an IEEE 802.11n router. When you play a video over an IEEE 802.11 b/g connection, the video may not play smoothly.

#### NOTES

- You must use the Hisense built-in Wireless LAN Adapter to use a wireless network because the set does not support an external USB network adapter.
- To use a wireless network, your TV must be connected to a wireless IP sharer. If the wireless IP sharer supports Dynamic Host Configuration Protocol (DHCP), your TV can use a DHCP or static IP address to connect to the wireless network.
- Select a channel for the wireless IP sharer that is not currently being used. If the channel set for the wireless IP sharer is currently being used by another device nearby, this will result in interference and communication failure.
- If you apply a security system other than the systems listed below, it will not work with the TV.
- If Pure High-throughput (Greenfield) 802.11N mode is selected and the Encryption type is set to WEP, TKIP or TKIP-AES (WPS2 Mixed) for your Access Point (AP), then the Hisense TV will not support a connection in compliance with these Wi-Fi certification specifications.
- If your access point (AP) supports Wi-Fi Protected Setup (WPS), you can connect to the network via Push Button Configuration (PBC) or PIN (Personal Identification Number). WPS will automatically configure the SSID and WPA key in either mode.

### Connecting to a Wired (Ethernet) Network

You can attach your TV to your LAN in one of the three following ways:

#### Option 1.

- You can attach your TV to your LAN by connecting the LAN port on the back of your TV to an external modem using a Cat 5 LAN cable. See Figure 9.

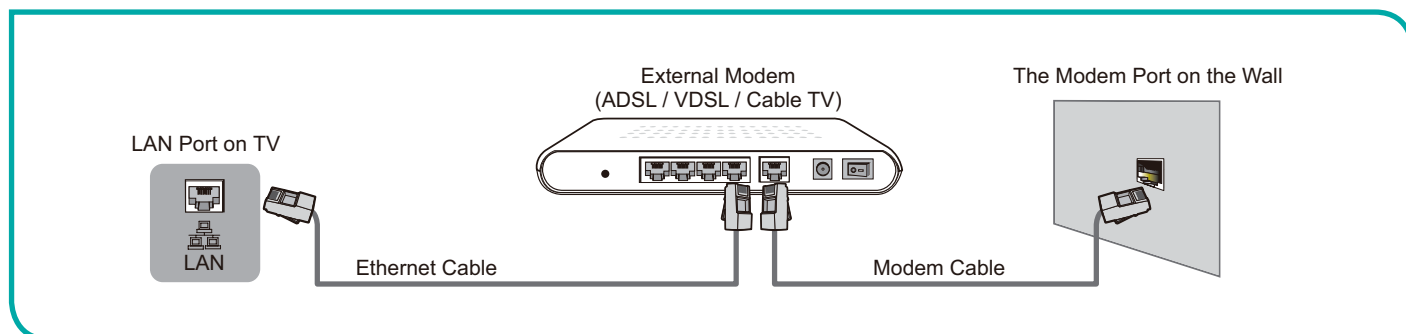

Figure 9. Connect a LAN port on the TV to an external modem

# Connecting your TV to a Wired or Wireless Network

## Option 2

- You can attach your TV to your LAN by connecting the **[LAN]** port on the back of your TV to an IP Sharer which is connected to an external modem. Use an Ethernet cable for the connection. See figure 16.

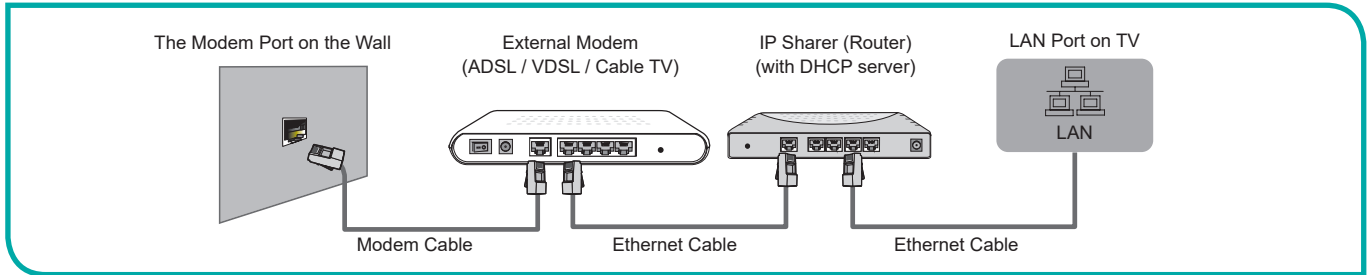

Figure 10. Connect a LAN port on the TV to an IP sharer

## Option 3

- Depending on how your network is configured, you may be able to attach your TV to your LAN by connecting the **[LAN]** port on the back of your TV directly to a network wall outlet with an Ethernet cable. See the diagram below.

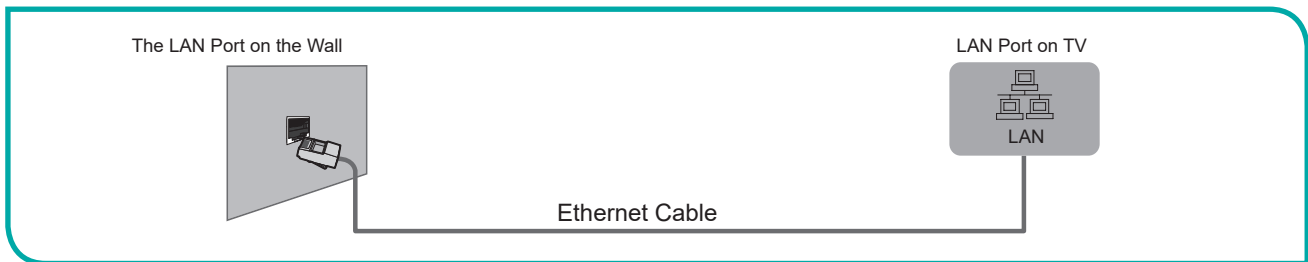

Figure 11. Connect a LAN port on the TV to a network wall outlet

If you have a Dynamic Network, you should use an ADSL modem or router that supports Dynamic Host Configuration Protocol (DHCP). Modems and routers that support DHCP automatically provide the IP address, subnet mask, gateway, and DNS, so you don't have to enter them manually. Most home networks are Dynamic Networks.

Some networks require a Static IP address. If your network requires a Static IP address, you must enter the IP address, subnet mask, gateway, and DNS values manually on your TV's Cable Setup Screen when you set up the network connection. To get the IP address, subnet mask, gateway and DNS values, contact your Internet Service Provider (ISP).

### NOTE

You can use ADSL modems that support DHCP if your network requires a static IP address. ADSL modems that support DHCP also let you use static IP addresses.

# Using Your TV Remote Control

## Buttons on your TV remote

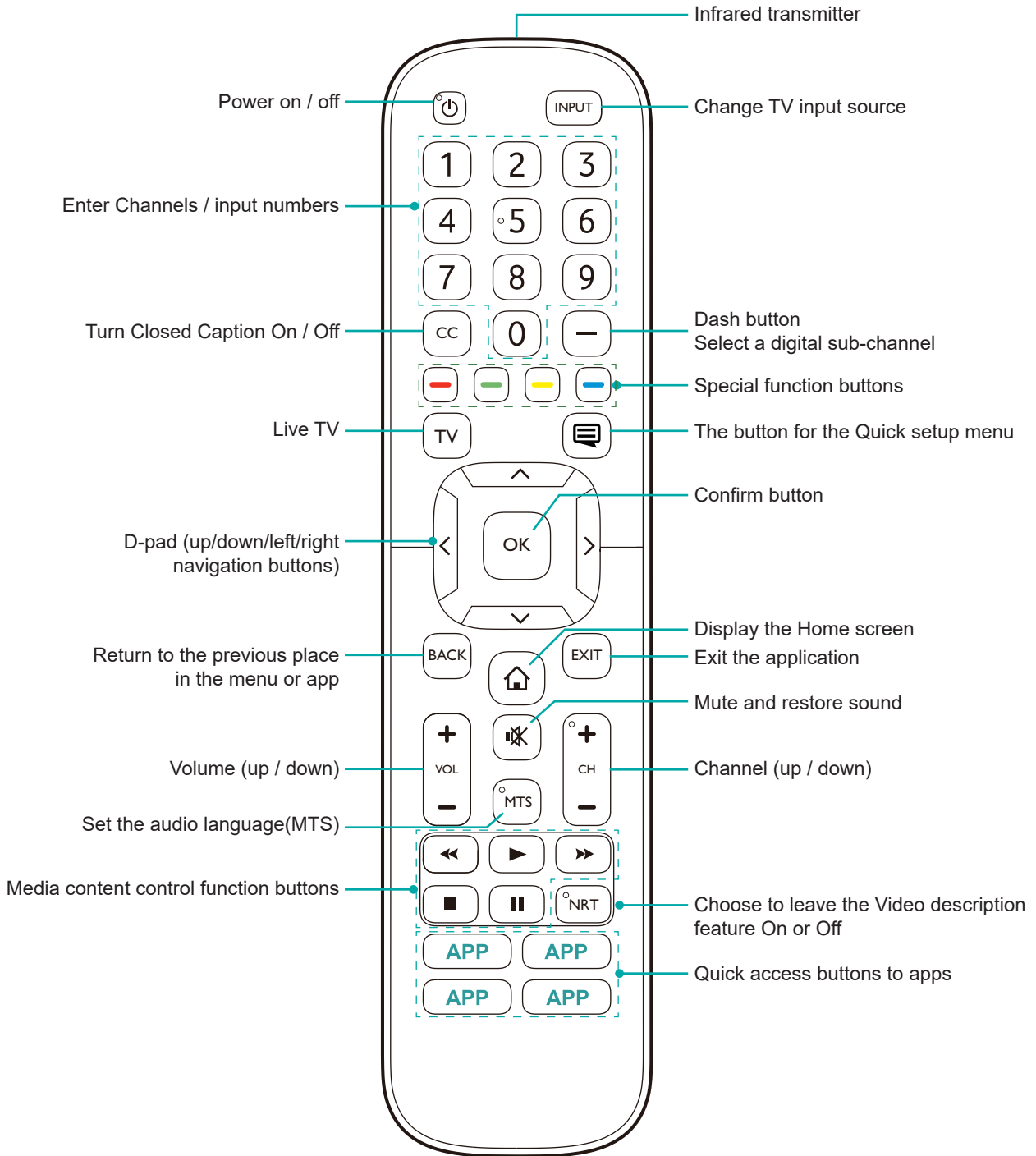

# Using Your TV Remote Control

## Begin using your remote

1. Slide the back cover to open the battery compartment of the remote control.

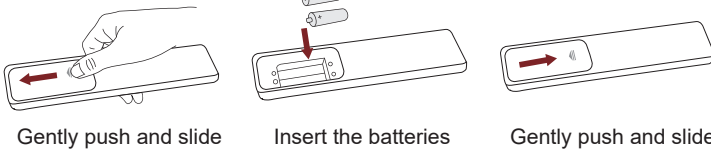

2. Insert two AAA size batteries. Make sure to match the (+) and (-) ends of the batteries with the (+) and ( - ) ends indicated in the battery compartment.

3. Replace the battery compartment cover.

### Important Information about the remote and batteries:

- Discard batteries in a designated disposal area. Do not throw them into a fire.
- Remove old batteries immediately to prevent them from leaking into the battery compartment.
- If you do not intend to use the remote control for a long time, remove the batteries.
- Battery chemicals can cause a rash. If the batteries leak, clean the battery compartment with a cloth. If chemicals touch your skin then wash it immediately.
- Do not mix old and new batteries.
- Do not mix alkaline, standard (carbon-zinc) or rechargeable (NiCd, NiMH, etc.) batteries.
- Do not continue using the remote if it gets warm or hot.

Call our Support Center immediately on the Hisense support website.

## Remote Control Range Information

- The remote control can work at a distance of up to 26 feet in front of the TV set.
- It can work at a 30 degree horizontal or vertical angle.

## Program Your Universal Cable or Satellite Remote Control to Operate Your New Hisense Television (only for USA)

If you would like to program your other household remote controls to your new Hisense television, please refer to the User's Manual supplied by your Cable or Satellite provider. The Cable or Satellite providers' User's Manuals should include instructions on how to program their remote to your television.

A list of Hisense codes for the most common Cable and Satellite providers are listed below. Use the Hisense code that is associated with your Cable or Satellite provider (if applicable).

**DIRECTV**.....0178, 10178, 10019, 10748, 11314, 11660, 11710, 11780, 12049, 10171, 11204, 11326, 11517, 11564, 11641, 11963, 12002, 12183

**Time Warner Cable**.....386, 0178, 10178, 400, 450, 461, 456, 0748, 1463, 0463, 10463

**Comcast**.....0178, 10178, 10463, 11463, 10748, 11314, 11660, 10171, 11204, 11326, 11517, 11641, 11780, 11785, 11892, 11963, 12002

**Cox Communications**.....0178, 10178, 1326, 1463

**Dish Network**.....505, 627, 538, 720, 659

If the Hisense code associated with your Cable or Satellite provider is not listed, does not work or you cannot locate the instructions to program your remote, call your local Cable or Satellite provider's customer service center.

If your Cable or Satellite provider does not have a Hisense code available, please contact us.

## Using Your Cable Set-top Box or Satellite Receiver Remote as a 'Universal' Remote

If you prefer to use your Cable Set-top Box or Satellite Receiver Remote as a 'Universal Remote', then visit the Support page to view a list of the codes.

## Shortcuts Instructions

You can use shortcuts on the remote control for fast operation. For more information about your TV remote, refer to the **Quick Start Guide** in accessories.

### Turning your TV on or off

To turn your TV on:

1. Connect the power cord to the back of the TV, then plug the power cord into an AC outlet.
2. When the TV is powered on, press the [  ] button on the remote to turn TV.

To turn your TV off, press the [  ] button on the remote.

#### NOTES

- When your TV is in standby mode, it is still consuming power. To completely disconnect power, please remove the plug from the AC outlet.
- If your TV does not receive an input signal for several minutes, it automatically goes into standby mode

### Selecting the Input Source

Select the Input Source depending on the video device you have connected to your TV.

To select the input source:

1. Turn on your TV, then press the [INPUT] button on the remote, the list of Source appears.
2. Press the [ < / > ] buttons to select the input source.
3. Press the [OK] button to confirm your selection.

### Using the Live TV

To view broadcast programs, press the [TV] button on your remote.

### Channel search guide

When you select TV as input, if no TV channels were saved before, you will be prompted to do a channel search. Before channel tuning could start, you must specify the tune mode, **Antenna** or **Cable**. You can also go to **Settings > Channel** to change the channel settings.

### Launch Live TV

After channel tuning is done for the first time, the screen will display Live TV operating tips, including: how to show the channel list, how to view channel info and so on.

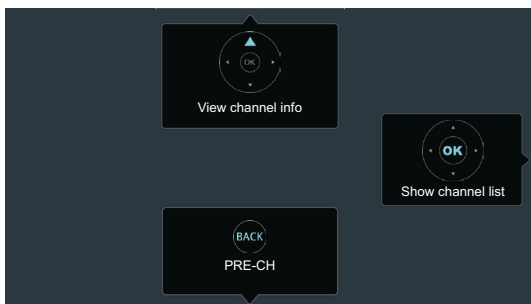

- [OK] Show channel list
- [  ] View channel info
- [Back] View recent channels