

**SHARP**® • **Roku TV**

# **USER MANUAL**

Before using the TV, please read this manual thoroughly and retain it for future reference.

## Copyright Statement

© 2016 Hisense Company Ltd. and Roku, Inc. All Rights Reserved.

All material in this Quick Start Guide is the property of Hisense Company Ltd. and Roku, Inc. and its subsidiaries, and is protected under US and International copyright and/or other intellectual property laws. Reproduction or transmission of the materials, in whole or in part, in any manner, electronic, print, or otherwise, without the prior written consent of Hisense Company Ltd. and Roku, Inc. is a violation of Hisense Company Ltd. and Roku, Inc. rights under the aforementioned laws.

No part of this publication may be stored, reproduced, transmitted or distributed, in whole or in part, in any manner, electronic or otherwise, whether or not for a charge or other or no consideration, without the prior written permission of Hisense Company Ltd. and Roku, Inc.

Requests for permission to store, reproduce, transmit or distribute materials may be made in writing to the following address:

USA: Hisense USA Corporation  
PO Box 3289  
Suwanee, GA 30024

CANADA: Hisense Canada Co., Ltd,  
405 Britannia Rd E., Suite 11  
Mississauga, Ontario, L4Z 3E6

“Sharp™”, “Aquos™”, “Quattron™” and any and all other Sharp product names, logo’s, slogans or marks are registered trademarks owned exclusively by Sharp Corporation.

“Hisense™”, and any and all other Hisense product names, logo’s, slogans or marks are registered trademarks and intellectual property rights of Hisense Company Ltd. and its subsidiaries.

This product is sold to you under one or more license agreements between Sharp Corporation and Hisense International (Hong Kong) America Investment Co. Ltd. All other trademarks are the property of their respective holders. Roku, Roku TV, Happy Streaming and the Roku logo are the trademarks or registered trademarks of Roku, Inc.

## Disclaimers

*\*\*Notwithstanding anything to the contrary, including in any or all descriptions, representations, statements or other communications related to this Sharp, Aquos or Quattron device (hereinafter "Device") made in any form whatsoever and at any time, some or all of the pre-installed, or subsequently installed Application Services may not be available or capable of functioning as intended by the provider of the Application Services in any or all usage areas for reasons outside of the control of the licensors or manufacturer of this device, including but not limited to, Internet access, local service limitations, etc. Any purchase or use of the Device, including any Application Services, is purely at the user's risk. Application Services are provided on an as-available basis without warranties of any kind, either expressed or implied, that the Application Service will be uninterrupted or error-free, including but not limited to vagaries of weather, disruption of Service, acts of God, warranties of title, local or regional limitations, no infringement, NOR IMPLIED WARRANTIES OF MERCHANTABILITY OR FITNESS FOR A PARTICULAR PURPOSE. No advice or information given by the licensors or manufacturers providers, affiliates, or contractors or their respective employees shall create such a warranty. All licensors and the manufacturer of this device, jointly and separately, specifically disclaim any and all responsibility for any or all Application Services from functioning at any time, and by purchasing the Device, you accept such disclaimer without any claim on the licensors and manufacturer. You are solely responsible for providing an active and working connection to the Internet, along with any and all hardware and/or software necessary to use the Device as intended.*

**Disclaimer:**

**Images throughout this document are for illustrative purposes only and may differ from the actual product.**

# Table of Contents

<b>Connecting Devices to Your TV</b>	<b>3</b>
Connecting an antenna, cable or satellite box	3
Connecting an Audio Visual (AV) device with a composite cable	3
Connecting an AV device with an HDMI cable	4
Connecting headphone	4
Connecting a USB device to the USB port	4
Connecting speakers or other audio receivers	5
Connecting to the Internet through a Wireless (WiFi) Device	5
<b>Guided Setup</b>	<b>6</b>
Starting Guided Setup	6
Connected TV Home Screen	11
Non-connected TV Home screen	12
<b>Benefits of connecting</b>	<b>13</b>
Connecting brings out your TV's full potential!	13
What is streaming?	13
But what if I didn't connect my TV?	14
<b>Setting up Antenna TV</b>	<b>15</b>
Why do I have to set up the TV tuner?	15
How do I set up the TV tuner?	15
<b>Using your TV</b>	<b>18</b>
TV status light	18
TV panel buttons	18
Remote control	19
Getting around	19
Watching broadcast TV channels	21
Switching TV inputs	22
Playing content from USB storage devices	23
Playing content from local network media servers	23
<b>Adjusting TV settings</b>	<b>24</b>
Settings menu	24
Options menu	24
Advanced picture settings	26

# Table of Contents

<b>Searching for movies and shows</b> .....	<b>27</b>
How do I search? .....	27
I found a show, now what?.....	27
<b>Using the Roku Channel Store</b> .....	<b>28</b>
<b>Customizing your TV</b> .....	<b>29</b>
Rearrange tiles .....	29
Edit broadcast TV channel lineup .....	29
Rename inputs .....	30
Remove unwanted tiles .....	30
Change themes.....	30
Change sound effects volume .....	31
Configure power settings .....	31
Configure parental controls.....	32
<b>More settings</b> .....	<b>36</b>
Changing network settings .....	36
Changing caption settings.....	36
Changing time settings .....	37
Scanning for broadcast TV channels again.....	37
Using the TV in a home theater.....	38
Restarting the TV.....	40
Resetting the TV.....	40
Getting system updates .....	40
<b>Other devices</b> .....	<b>42</b>
Getting and using the Roku mobile app .....	42
<b>Quick Problem-Solving Tips</b> .....	<b>43</b>

# Connecting Devices to Your TV

You have several options for connecting your TV to different devices. The method in which you connect will be based upon the type of cables you have and the available outputs on your device.

## Connecting an antenna, cable or satellite box

To connect an antenna, cable set-top box or satellite receiver:

1. Connect one end of a coaxial cable (not included) to the **RF OUT** port on the antenna, cable or satellite box. If you are using an antenna with twin-lead cable, you may need a 300-75 Ohm adapter (not provided) to connect it to the back of your TV. Likewise, if you are using several antennas, you may need a combiner (not provided).
2. Connect the other end of the cable to the **ANT/CABLE** port on the side of the back panel.
3. Using your remote, press the [  ] button and select **TV** as the input source.

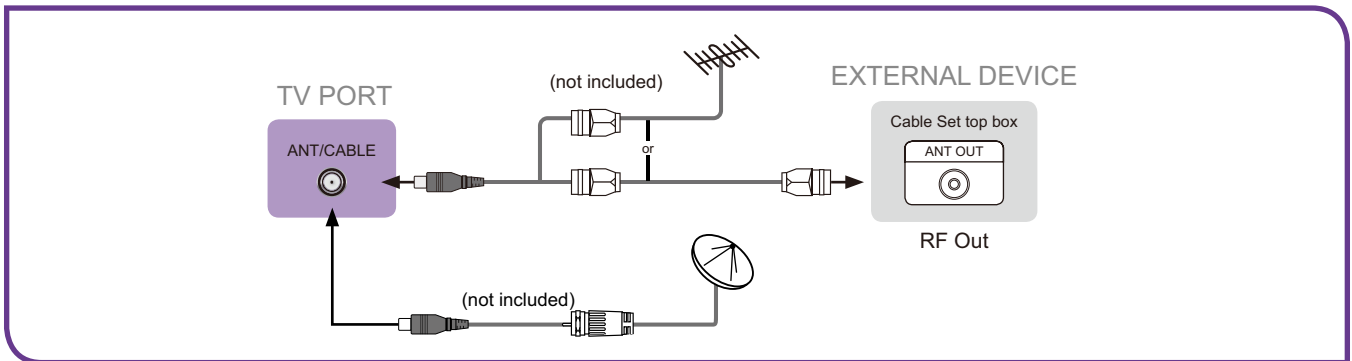

## Connecting an Audio Visual (AV) device with a composite cable

To connect an AV device with a composite video cable (not provided):

1. Use the audio and video cables to connect the composite video/audio ports of the external AV device to the **AV IN** ports of the TV. (Video = yellow, Audio Left = white, and Audio Right = red).
2. Plug the connected devices into the AV connectors on the TV before switching it on.
3. Using your remote, press the [  ] button and select **AV** as the input source.

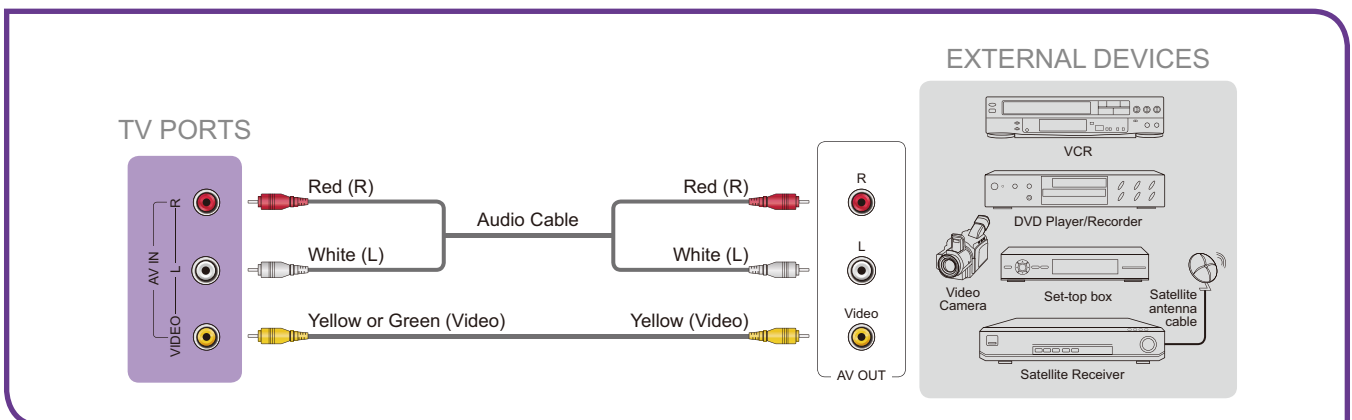

# Connecting Devices to Your TV

## Connecting an AV device with an HDMI cable

This type of connection supports digital connections between HDMI-enabled AV devices such as a Personal Video Recorder (PVR), DVD, Blu-Ray, AV receiver and digital devices. In addition, some devices (such as a PVR or DVD player) require an HDMI signal to be set to Output in the settings of the device.

For instructions, please refer to the User Manual for the device.

To connect an AV device with an HDMI cable (not provided):

1. Use an HDMI cable to connect the HDMI output port of the AV device to the **HDMI** port on the TV.
2. Plug the connected devices into the **HDMI** port on the TV before switching it on.
3. Using your remote, press the [  ] button and select the corresponding HDMI input.

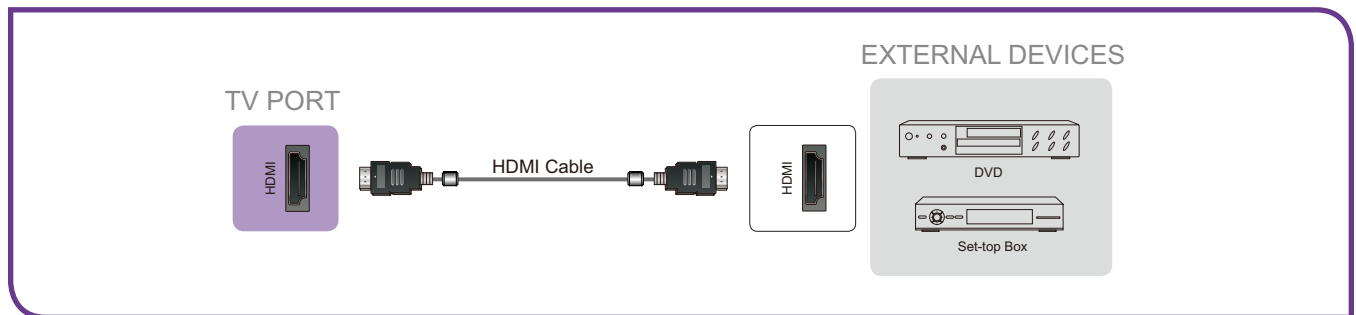

### NOTES

- Because the HDMI connector provides video and audio signals, it is not necessary to connect an audio cable.
- We strongly recommend to use HDMI Cable with 2 cores as shown in the figure.

## Connecting headphone

You can connect headphone (not provided) to the **AUDIO OUT** port on your TV. While the headphone is connected, the sound from the built-in speakers will be disabled.

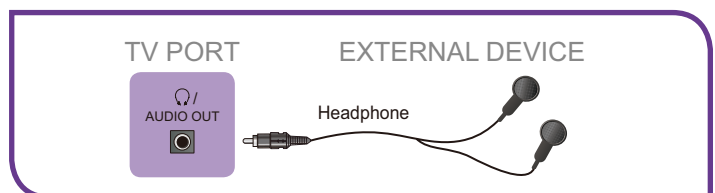

## Connecting a USB device to the USB port

1. Connect the USB devices such as hard drives, USB sticks and digital cameras for browsing photos, listening music and watching recorded movies into the **USB** port.
2. Select the **Roku Media Player** tile from the **Home** screen.

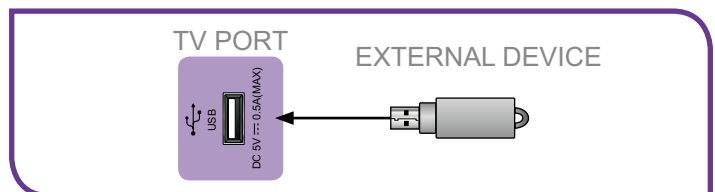

### NOTES

- When connecting a hard disk or a USB hub, always connect the mains adapter of the connected device to the power supply.
- If a USB 1.1 or USB2.0 device requires more than 500mA or 5V, the USB device may not be supported. Exceeding the max supported current may result in damage or data loss.

# Connecting Devices to Your TV

## Connecting speakers or other audio receivers

To connect speakers or other audio receivers with an audio cable (not provided):

1. Use an audio cable to connect the digital audio in port of the audio receiver device to the **DIGITAL AUDIO OUT** port of the TV. Another option is to use an RCA Y-cable (1/8"-stereo mini to L/R phono) to connect analog sound system to the **AUDIO OUT** port of the TV.
2. Plug the connected devices into the main socket before switching on the TV.

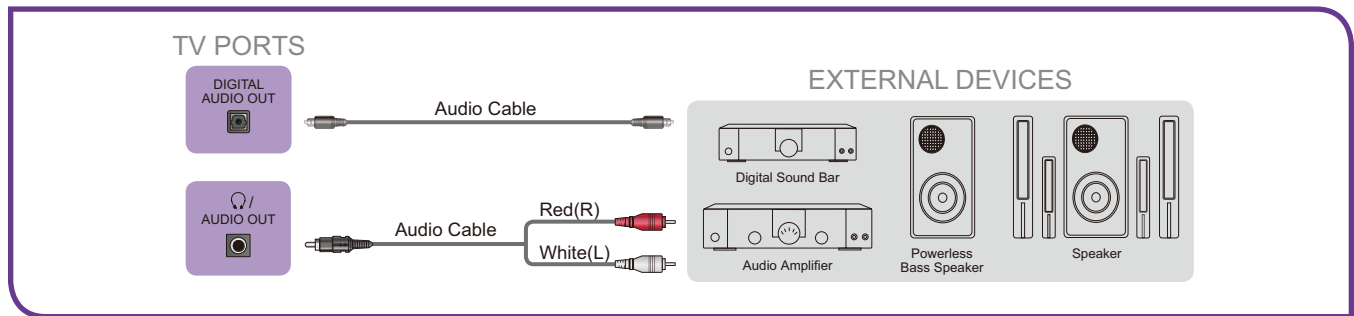

## Connecting to the Internet through a Wireless (WiFi) Device

This section shows how to establish a wireless Internet connection for your TV.

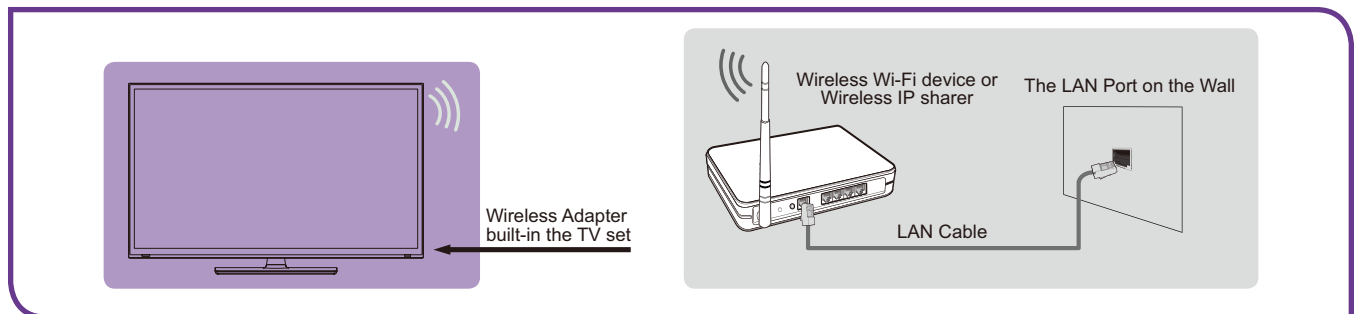

Our built-in wireless LAN adapter supports the IEEE 802.11 b/g/n communication protocols and we recommend that you use an IEEE 802.11n router. When you play a video over an IEEE 802.11 b/g connection, the video may not play smoothly.

### NOTES

- You must use the Hisense built-in Wireless LAN Adapter to use a wireless network because the TV does not support an external USB network adapter.
- To use a wireless network, your TV must be connected to a wireless IP sharer. If the wireless IP sharer supports Dynamic Host Configuration Protocol (DHCP), your TV can use a DHCP or static IP address to connect to the wireless network.
- Select a channel for the wireless IP sharer that is not currently being used. If the channel set for the wireless IP sharer is currently being used by another device nearby, this will result in interference and communication failure.
- If you apply a security system other than the systems listed below, it will not work with the TV.
- If Pure High-throughput (Greenfield) 802.11N mode is selected and the Encryption type is set to WEP, TKIP or TKIP-AES (WPS2 Mixed) for your Access Point (AP), then the Hisense TV will not support a connection in compliance with these Wi-Fi certification specifications.
- If your access point (AP) supports Wi-Fi Protected Setup (WPS), you can connect to the network via Push Button Configuration (PBC) or PIN (Personal Identification Number). WPS will automatically configure the SSID.



# Guided Setup

With the preliminaries out of the way, it's time to turn on your TV. As the TV starts for the first time, it leads you through Guided Setup, which configures the TV before you start to use it.

During Guided Setup, you'll:

- Answer a few questions
- Provide network connection information
- Get a software update
- Link the TV to your Roku account
- Connect devices such as a DVD player, game console, or cable box

## NOTE

- Guided Setup only runs the first time you turn on your TV. If you need to run Guided Setup again, you'll have to perform a factory reset, as explained in [Factory reset everything on page 40](#).

## Starting Guided Setup

---

To start Guided Setup, press the red **[POWER]** button on the remote control to turn on your TV.

When you first turn on your TV, it will take a few seconds to get itself ready. You'll notice the following things happening:

- The status light blinks every time the TV is busy doing something; in this case it's powering up and getting ready for you.
- The **Power-on** screen appears and the status light blinks slowly for a few more seconds. The **Power-on** screen displays a TV logo while the TV starts up.
- After a few seconds, the Guided Setup starts.
- If the TV prompts you for a language, press the **[DOWN]** on the remote control to highlight your preferred language.

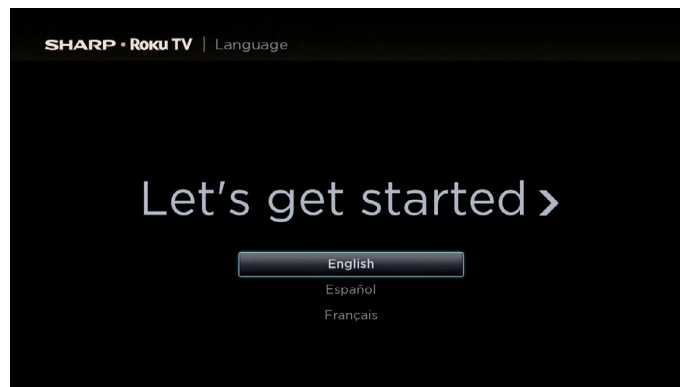

## Setting up your TV

With the first Guided Setup screen on your TV, follow these steps to set up your TV:

1. Press the **[OK]** or **[RIGHT]** buttons on the remote control to go to the next screen:

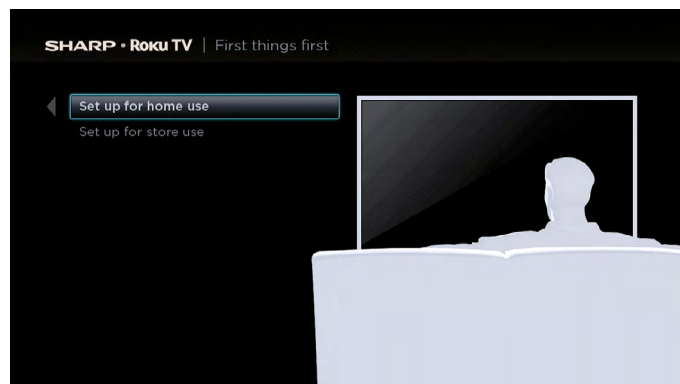

# Guided Setup

2. Press **[OK]** to select **Set up for home use**. Home mode is the right choice for enjoying your TV.

## NOTE

- ‘Store’ mode configures the TV for retail display and is not recommended for any other use. In store mode, some features of the TV are missing or limited. To switch from one mode to the other, you have to perform a factory reset as explained in [Factory reset everything on page 40](#), and then repeat Guided Setup.

After you select **Set up for home use**, the TV scans for the wireless networks within range and displays them in order, with the strongest signals first. In addition to your own wireless signal, the TV might pick up signals from your neighbors.

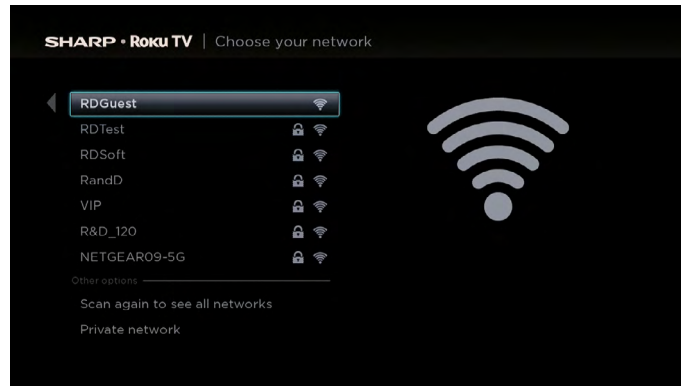

3. Press **[UP]** or **[DOWN]** to highlight the name of your wireless network, and then press **[OK]** to select it.

## NOTE

- Some wireless networks, such as those often found in dorm rooms, hotels, and other public places, may require you to read and agree to terms, enter a code, or provide identifying information before letting you connect to the Internet. If the Roku TV detects that you are connecting to such a network, it prompts you through the connection process using your compatible smartphone or tablet to provide the needed information.

### Other options:

- **Connect to the Internet later** – If you’re unable to connect to the Internet, that’s OK. You can skip this step and use the TV to watch broadcasts, play games, and watch DVDs. If you want to connect later, it’s easy. We’ll show you how in [Benefits of connecting on page 13](#).

## NOTE

- If you decide not to connect, Guided Setup skips ahead to setting up the devices that you’ve connected to your TV. See [Non-connected TV Home screen on page 12](#) to get started using your non-connected TV.
- **Scan again / Scan again to see all networks** – This option depends on the number of wireless networks within range:
- **Scan again** appears if the list already shows all available wireless networks within range. If you don’t see your wireless network name in the list, you might need to adjust the location of your wireless router or the TV, turn on your router, or make other changes. When everything is ready, select **Scan again** to see if your network name now appears in the list.
- **Scan again to see all networks** appears if the TV finds more than seven wireless networks, because the TV initially displays only the strongest seven networks. If you don’t see your wireless network name in the list, this option displays the complete list. If you still don’t see your network name, you might have your router configured to provide wireless service as a “private network.”

## NOTE

- Highlighting either of these options displays an informational panel with the unique media access control (MAC) address of your Roku TV. You will need the MAC address if your wireless router is configured to use MAC address filtering.
- **Private network** – If your wireless network name is hidden, it won’t appear in the list. Select **Private network** to display an on-screen keyboard, and use it to enter your network name. Unless you changed the factory-set network name, you can find the name (also called SSID) on a label on the router.



# Guided Setup

- If your network is password-protected, an on-screen keyboard appears. Use the keyboard to enter the network password.

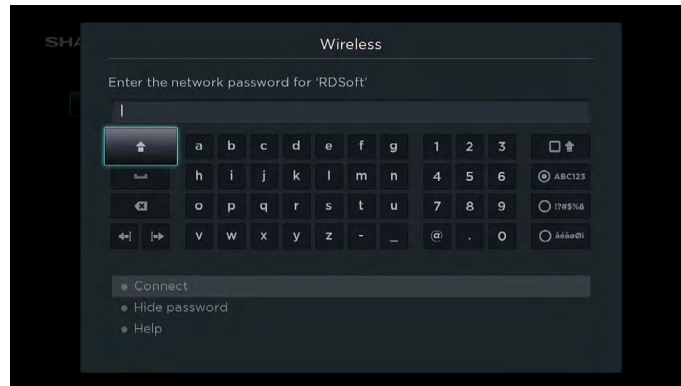

- After you submit your network password, the TV displays progress messages as it connects to your wireless network, your local network, and the Internet.
- Your TV needs to know the local time zone so that it can correctly display time information about the program you are currently watching. If the TV is unable to automatically determine the local time zone, it prompts you to choose your time zone from a list. Use the [UP] and [DOWN] buttons to highlight your time zone, and then press [OK].

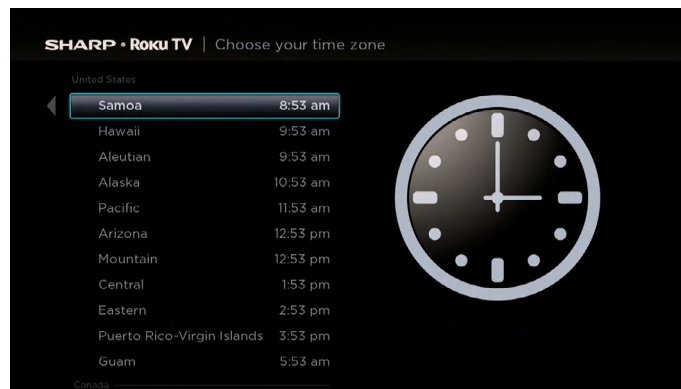

- As soon as the TV is able to connect to the Internet, it downloads and installs its first software update, and then restarts.  
**TIP:** Your TV automatically checks for updates periodically. These updates provide new features and improve your overall experience with the TV. After an update, you might notice that some options have moved, and that there are new options or features.

After the TV restarts, it displays the **Activation** screen:

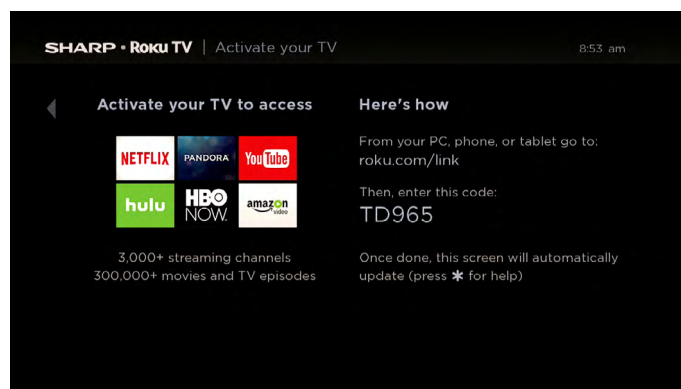

# Guided Setup

8. Using a computer, tablet, or smartphone with an Internet connection, go to the web address displayed on the screen and enter the code that appears on your screen.

You need a **Roku** account to complete this step. If you already have a **Roku** account, you'll be asked to log in. If you don't, you'll be asked to create one. You'll have the option to create a Roku PIN code that can be used to authorize any purchases or payments.

After you log in or create your Roku account, the TV gets an acknowledgment and adds your pre-existing streaming channels, if any, to your TV. This process is automatic and takes a few moments—a little longer if you already have a lot of streaming channels to add.

**TIP:** Streaming channels from all **Roku** devices associated with your account are synchronized periodically, so all of your **Roku** devices have the same streaming channels (subject to compatibility with the device).

After it adds your selected streaming channels, the TV helps you set up the devices that you're connecting to it, such as a cable box, Blu-ray player, or game console:

## Why do I need a Roku Account?

You need a Roku account for several reasons.

- It links you, your TV, your other Roku devices, the Roku web site, and a payment method.
- Fees associated with adding certain channels are paid for by the payment method you have specified.
- Streaming content providers know that it's OK to send content you request to your TV.
- Roku can automatically send updates to your device.

**Important: It doesn't cost anything to use your TV, and there are lots of free channels. If you choose to add a streaming channel or other application with associated fees (most have none), it's paid for by the payment method you have specified.**

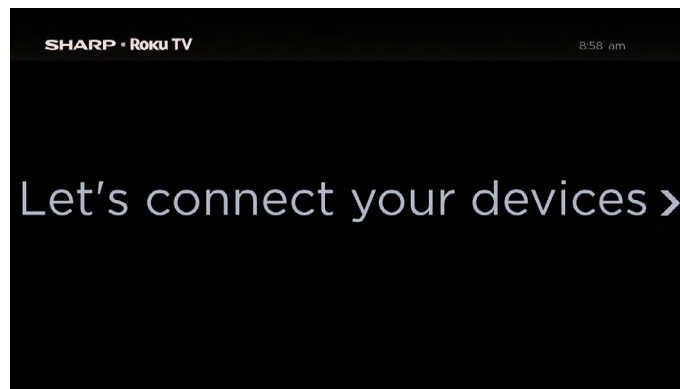

9. Press **[OK]** or **[RIGHT]** to proceed:



# Guided Setup

10. Connect all the devices you plan to use to the TV, turn them all on, and then select **Everything is plugged in and turned on**. The TV now takes you step by step through each of its inputs and asks what kind of device you have connected. On each input that has a connected and active device, you can see its picture and hear its sound.

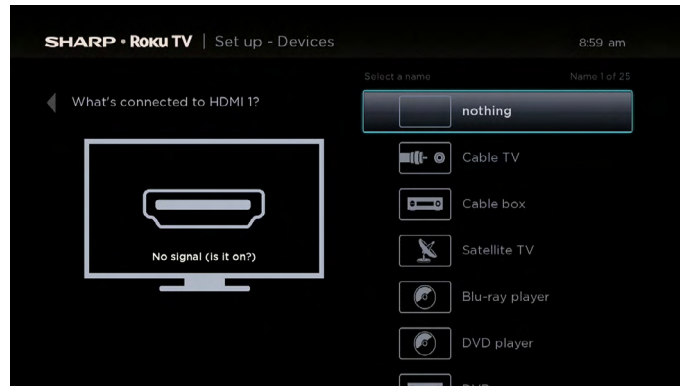

11. Press **[UP]** or **[DOWN]** to highlight the label you want to associate with the input, and the press **[OK]** to move on to the next input.

You're done with Guided Setup.

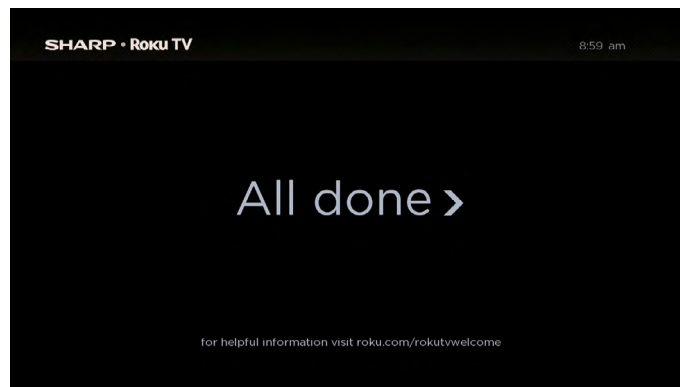

## NOTE

- Some Roku TVs, depending on where you live and other factors, show you an introductory video filled with some great hints and tips. If you're not interested in viewing this video, press on the remote control to exit to the Roku TV Home screen.

When you finish Guided Setup, and whenever you press **[Home]** on the remote control, the **Home** screen greets you.

From here, you can explore everything your TV has to offer. Press the arrow buttons to move around, and press **[OK]** to select a highlighted item. We've designed the TV to encourage you to explore, and you can probably figure out most of the capabilities and settings on your own. If you have any questions or difficulties, you can find answers and solutions in this guide.

If you find yourself a long way from the **Home** screen, you can always get back right away by pressing one button: **[Home]**.

**Tip:** The appearance of the **Home** screen varies depending on whether you decided to connect your TV to the Internet.

# Guided Setup

## Connected TV Home Screen

Here is a typical **Home** screen from a TV that's connected to the Internet and paired with a Roku account.

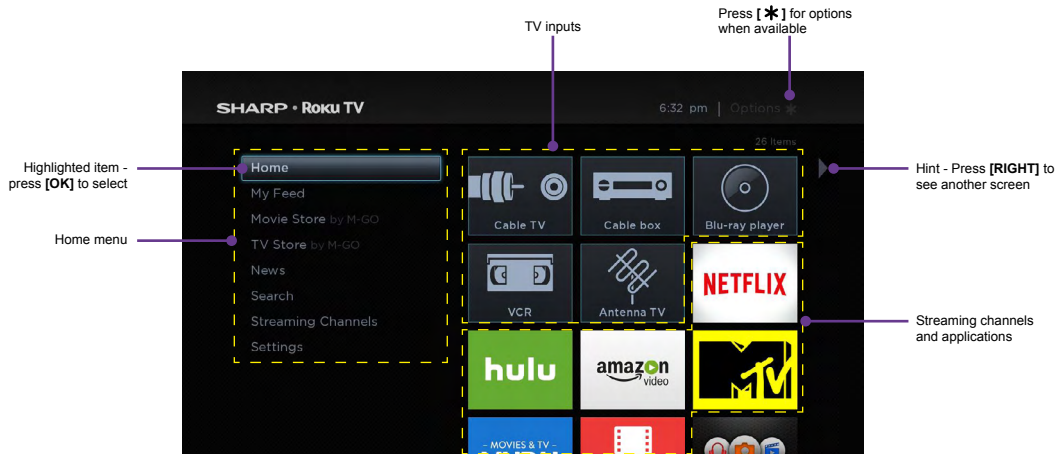

## Personalize your Home screen

You can do a lot to personalize your **Home** screen and make it just right for you and your family:

- Add streaming channels by browsing the Roku Channel Store.
- Remove a tile by highlighting it and pressing [**\***].
- Reposition a tile by highlighting it and pressing [**\***].
- Rename a TV input tile by highlighting it and pressing [**\***].
- Change the screen theme to suit your mood.

# Benefits of connecting

## Non-connected TV Home screen

Here is a typical **Home** screen from a TV that is not connected to the Internet.

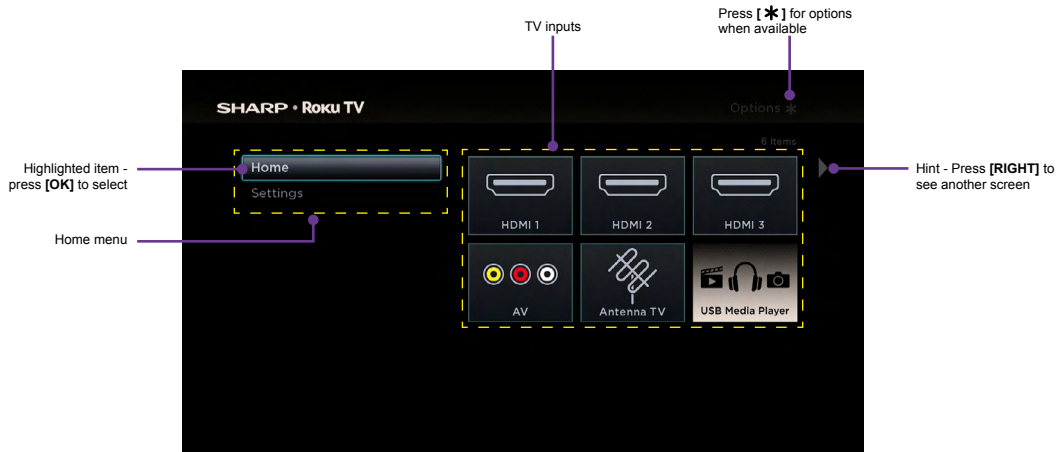

## Personalize your Home screen

You can do a lot to personalize your **Home** screen and make it just right for you and your family:

- Remove a tile by highlighting it and pressing [**\***].
- Reposition a tile by highlighting it and pressing [**\***].
- Rename a tile by highlighting it and pressing [**\***].
- Add streaming channels by browsing the Roku Channel Store (after connecting the TV to the Internet to add the **Streaming Channels** option to the menu).

# Benefits of connecting

## Connecting brings out your TV's full potential!

---

### Make any night a movie night

Your TV offers more than 300,000 movies and TV episodes to choose from, across major streaming movie channels like Netflix, Amazon Instant Video, Hulu Plus, Redbox Instant, VUDU, and more.\*

### Get in the groove

Stream on-demand or live music from any of more than 85 music channels like Pandora, VEVO, Spotify, iHeartRadio, and more. Access your entire MP3 collection instantly with Amazon Cloud Player or the Roku Media Player.

### Explore loads of free trials

Your TV comes packed with special offers, often including free trials from popular streaming channels like Amazon Instant Video, Netflix, Redbox Instant, Spotify, and DailyBurn.

### Rule the water cooler

Binge on the most buzzworthy shows on streaming channels like FOXNOW, HBO GO, Hulu Plus, and Netflix.\* Live stream your sports team with the biggest selection of streaming sports packages out there, including WATCH ESPN, MLB.TV, NBA League Pass Broadband, NHL GameCenter, MLS LIVE, UFC, WWE, and more. International sports offerings on Dishworld include Indian Premier League cricket and Brazilian pro soccer.

## What is streaming?

---

Streaming is viewing or listening to video or audio content that is sent over the Internet, or located on a network-connected media server or on a USB device plugged into the TV's USB port.

With streaming, you can watch most programs on demand, when it's convenient for you. When streaming, you can play, pause, rewind, and fast forward whatever you are watching. You can also replay the last few seconds again, or turn on closed captions.

**Tip:** Some content cannot be paused or skipped. For example, if you are viewing live programming or a program that is supported by ads, you generally are not allowed to skip the ads.

Your TV lets you choose from over 3,000 streaming channels that offer a huge selection of entertainment:

- Over 300,000 movies and TV episodes
- Unlimited music, live and on-demand
- Tons of live and on-demand sports
- Commercial-free kids programming
- International language programming in 22 languages
- 24x7 news and in-depth news commentary
- Games

Most streaming channels are free. Some streaming channels like Amazon Instant Video, Redbox Instant, and VUDU, let you purchase or rent the latest movie releases or popular TV series. Some channels such as Netflix or Hulu Plus charge a monthly subscription fee. Some channels are free if you subscribe to a companion service through your cable or satellite provider. For example, HBO subscribers with participating TV providers can add the HBO Go channel and watch it for free.

If you have an existing subscription to a service like Netflix or Hulu Plus, or if you are an Amazon Prime member, you can just sign in with your existing user name and password.

---

\* Subscriptions or other payments may be required to access content on certain channels. For example, Netflix requires a paid subscription, which gives you access to movie and TV show titles in the Netflix streaming catalog. Some channels may not be available to all households in every market or in all countries where Roku players or other products with the Roku platform are sold.



## Benefits of connecting

To play streaming content that is available on the Internet, you add streaming channels to your **Home** screen. To add a streaming channel to your **Home** screen, use the **Streaming Channels** option on the **Home** screen menu to go to the Roku Channel Store, and then select the streaming channel you want to play. The streaming channel is then added to your **Home** screen, and you can watch it at any time.

For more information on using the Roku Channel Store, see [Using the Roku Channel Store on page 28](#).

### **NOTE**

- Some channels may not be available to all households in every market or in all countries where Roku TVs are sold.

## But what if I didn't connect my TV?

---

What if you went through Guided Setup and chose **Connect to the Internet later**? No worries. Your TV makes it easy to connect whenever you want. As you move around the **Home** screen, you'll see several places where you can start the connection process. For example:

- Every now and then you'll see a message appear on the panel to the right of the **Home** screen offering a **Connect Now** option. Simply highlight and select the **Connect Now** option to get started.
- Use the **Connect and activate now** option in the **Settings** menu. From the **Home** menu, select **Settings**, then **Network**, and then **Connect and activate now**.
- If you want to start over from the beginning, use the **Settings** menu to do a **Factory reset**, and then go through Guided Setup again. This time, choose your home network when prompted.

Regardless of how you connect, the process is the same. If you need details, see Step 3 of [Setting up your TV on page 6](#).

# Setting up Antenna TV

Despite all of the entertainment possibilities of your TV, you may also want to watch broadcast TV. You watch broadcast TV in much the same way you watch other entertainment choices. You select a tile—the **Antenna TV** tile—from the **Home** screen.

The first time you select the **Antenna TV** tile, you have to set up the TV tuner. Setting up the TV tuner scans for active channels and adds them to your channel list.

## Why do I have to set up the TV tuner?

You might be asking, “Why is this step necessary?” Good question.

Not everyone needs to use the TV tuner. For example, you might have a set top box provided by a cable or satellite company that receives all of your channels. Most of these set top boxes use an HDMI® connection.

More and more people are watching only streaming TV and do not have a TV antenna or cable/satellite service. If you don't need the TV tuner, you can bypass setting it up and instead remove it from the **Home** screen as explained in [Remove unwanted tiles on page 30](#).

The TV scans the signals on its antenna input for channels with a good signal, and adds those to the channel list, skipping dead channels and channels with a very weak signal.

The TV will, however, let you add channels with no signal if you have an older set top box, VCR, or game console that can only output a signal on analog channel 3 or 4. These are the only channels that can be added regardless of whether they have a good signal. Typically, you'll only need one of these channels, but both are provided to make setup simpler. You can hide the one you don't want as explained in [Edit broadcast TV channel lineup on page 29](#).

## How do I set up the TV tuner?

Setting up the TV tuner is easy—your TV does most of the work. You just have to answer a couple of questions.

1. Make sure your antenna or other device is connected to the TV's **ANT/CABLE** input.
2. On the **Home** screen, select the **Antenna TV** tile.
3. Read the simple on-screen instructions and select **Start finding channels**.

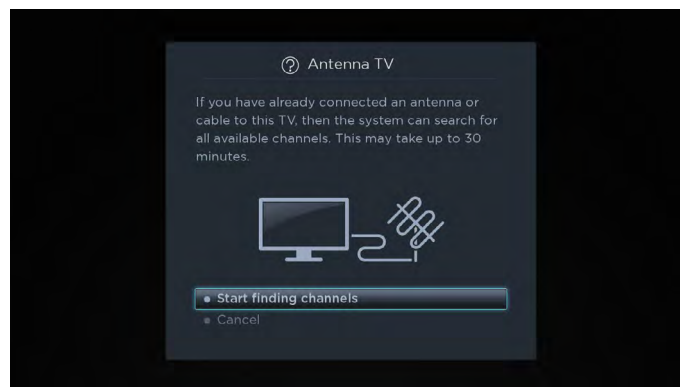

# Setting up Antenna TV

4. If prompted, select your time zone. You'll only need to do this if the TV can't figure out your time zone from your Internet connection.

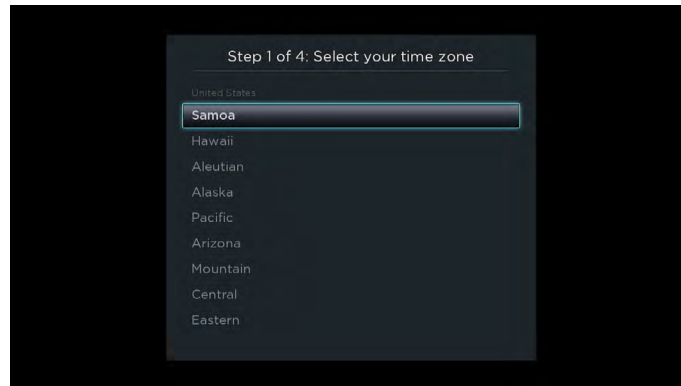

## Why does the TV need my time zone?

The TV needs to know your time zone so that it can correctly display information about the program you are currently watching.

5. When prompted, select whether to add analog channels 3 and 4 (to enable you to connect older set top boxes, VCRs, or game consoles).

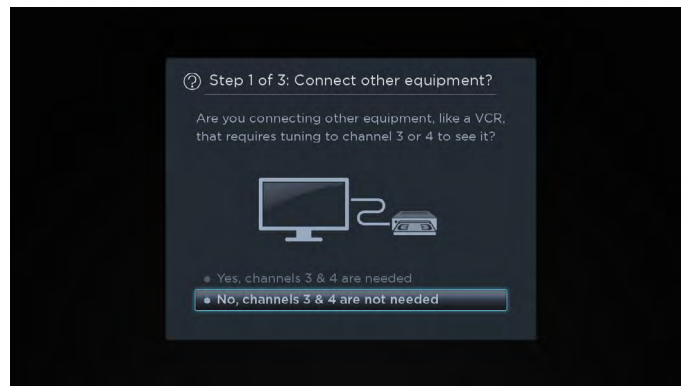

6. Wait while your TV scans for broadcast (antenna TV) stations...

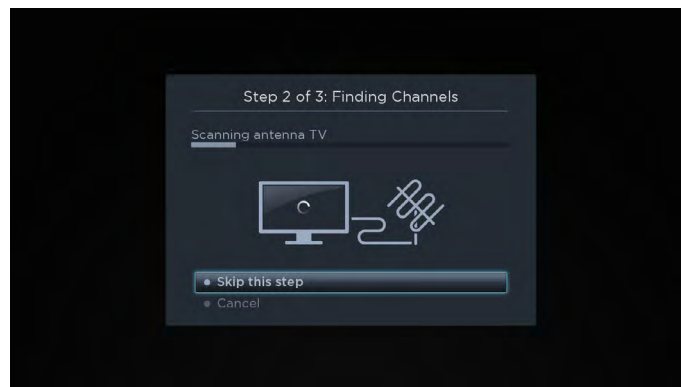

# Setting up Antenna TV

... and then cable TV channels.

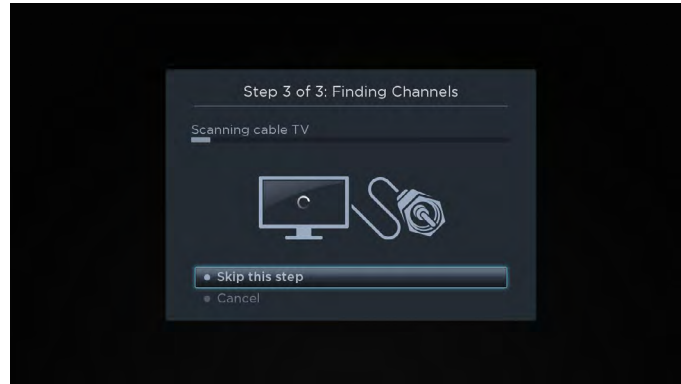

**Tip:** Cable TV channels are channels from a cable TV provider that you can receive by connecting their cable directly to your TV (unscrambled NTSC, ATSC, and QAM channels, if you're interested in the details). In many cases, your cable provider probably requires you to use their set-top box and connect it to a different input, and then use the set-top box to tune your cable stations. In that case, you can skip scanning for cable channels.

7. When the channel scans finish, the TV shows the number of channels it added.

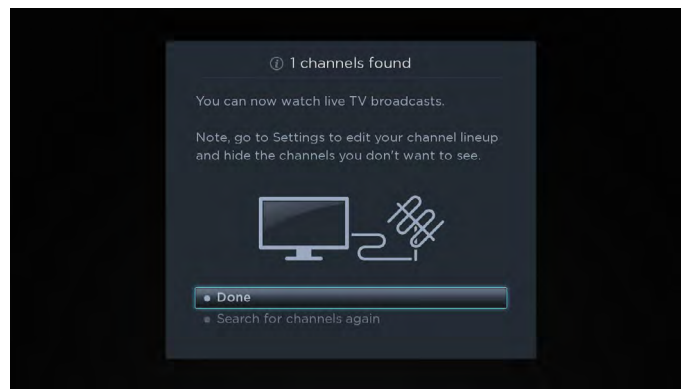

Scanning for channels can take several minutes.

## NOTE

- You should plan to repeat the channel scan periodically to make sure you are receiving all of the latest channels. Broadcasters add and remove channels, move channels to different parts of the spectrum, and change the power levels of their channels periodically. You'll also have to repeat the channel scan if you remove the **Antenna TV** tile from the Home screen or perform a factory reset. To repeat the channel scan at any time, go to **Settings > TV inputs > Antenna TV > Scan again for channels**.

Now, you're ready to watch broadcast TV! While you're watching, try the following:

- Press **[UP]** or **[DOWN]** to change channels.
- Press **[LEFT]** to display the channel list and then use **[UP]** and **[DOWN]** to select a channel to watch. Or press **[REVERSE]** or **[FORWARD]** to jump a page at a time.
- Press **[OK]** to display information about the current program.
- Press **[↶]** to switch to the previously tuned channel.
- Press **[\*]** to see options for picture and sound settings.

[Remote control on page 19](#) has more information on using the remote control buttons while watching TV.

# Using your TV

This section provides information on using the day-to-day features of your TV.

## TV status light

Your TV has a single status light on the front panel. It goes on and off and blinks in different ways depending on the status of the TV, as shown in the following table:

TV condition	Status indicator	Meaning
On (screen is active)	Off	Screen is communicating that TV is on.
Screensaver (screen is active)	Off	Screen is communicating that TV is on.
Off (no power)	Off	TV does not have power.
Off (standby)	On	TV has power and is ready to use.
Starting up from off state	Slow pulsing blink until startup completes	TV is doing something.
On (receiving update from USB)	Slow pulsing blink until update completes	TV is doing something.
Remote control command received	Dims on/off once	TV has received your command.

## TV panel buttons

The controls on the TV enable you to perform simple functions, but are not a substitute for the remote control.

Your TV has seven buttons on the right edge of the screen. They perform the following functions:

- Input
- Channel +
- Channel –
- Volume +
- Volume –
- Mute
- Power

# Using your TV

## Remote control

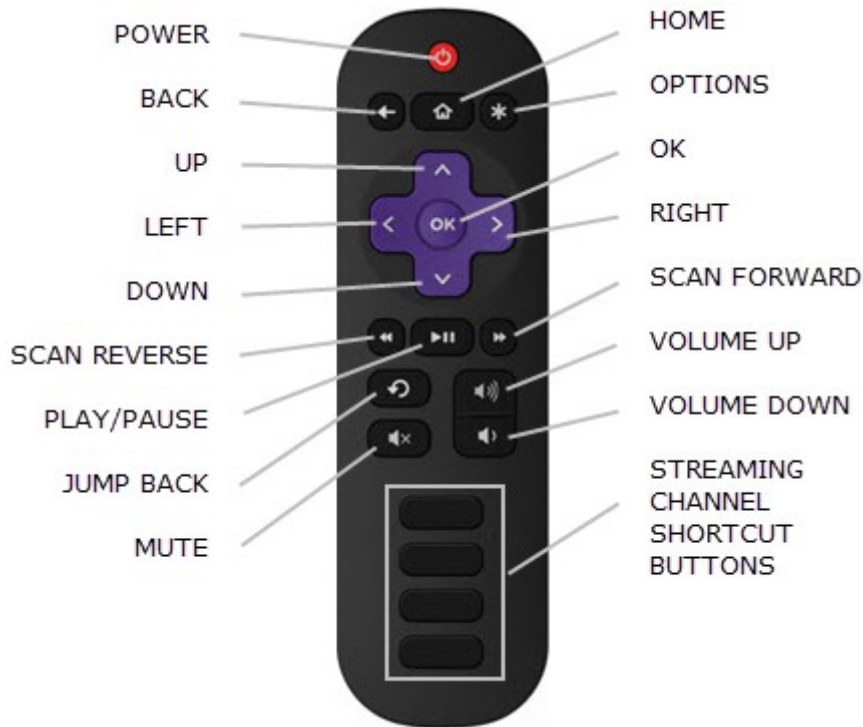

TV IR remote control

## Getting around

You've already done a bit of navigating with the remote control when you completed the Guided Setup and when you set up Antenna TV. This section explains how to use the remote control for everyday TV use.



### POWER

If the TV is in 'Standby' mode, turns power on.  
If the TV is on, puts TV in 'Standby' mode.



### BACK

The action depends on what you are doing with the TV:

- **Menu:** Goes back to previous menu/screen.
- **Home screen tile:** Moves highlight back to the **Home** menu option.
- **Watching Antenna TV or a TV input:** Returns to the screen from which the input was selected.
- **Playing streaming content:** Stops playing stream and returns to the previous menu or screen.
- **Browsing streaming content:** Goes to the previous level in the content tree.



### HOME











Immediately returns to the **Home** screen menu.



### OPTIONS

When the **Options** \* hint in the upper right corner of the screen is not dimmed, displays an Options menu. The menu you see varies depending on what you are doing with the TV.  
Also, in most cases, pressing [ \* ] while a video is playing displays an **Options** menu over part of the screen where you can adjust various picture and sound settings.

# Using your TV

	<b>UP</b>	Moves the highlight up one item.
	<b>DOWN</b>	Moves the highlight down one item.
	<b>LEFT</b>	Moves the highlight left, if possible (if a < hint appears). When watching TV, displays your channel list. When playing most streaming videos, skips backward in the video.
	<b>RIGHT</b>	Moves the highlight to the right, if possible (if a > hint appears). When watching TV with the channel list displayed, dismisses the channel list. When playing most streaming videos, skips forward in the video.
	<b>OK</b>	Selects the highlighted option. When watching TV, this button displays information for the current TV program.
	<b>SCAN REVERSE</b>	When playing streaming video that supports this feature: <ul style="list-style-type: none"><li>• First press scans backward at 1x speed.</li><li>• Second press scans backward at 2x speed.</li><li>• Third press scan backward at 3x speed.</li><li>• Subsequent presses cycle through 1x, 2x, and 3x reverse speed.</li></ul> When playing streaming audio, jumps to the previous track/selection. When any menu, tile, or channel in the channel list is highlighted, jumps up one page. When using a virtual keyboard, jumps to the character at the top of the current column.
	<b>PLAY/ PAUSE</b>	When playing streaming content, alternately pauses and plays the content.
	<b>SCAN FORWARD</b>	When playing streaming video that supports this feature: <ul style="list-style-type: none"><li>• First press scans forward at 1x speed.</li><li>• Second press scans forward at 2x speed.</li><li>• Third press scan forward at 3x speed.</li><li>• Subsequent presses cycle through 1x, 2x, and 3x forward speed.</li></ul> When playing streaming audio, jumps to the next track/selection. When any menu, tile, or channel in the channel list is highlighted, jumps down one page. When using a virtual keyboard, jumps to the character at the bottom of the current column.
	<b>JUMP BACK</b>	When playing streaming video that supports this feature, jumps back 7 seconds with each press and resumes playing. In some channels, if <b>Closed captioning</b> is set to <b>Instant replay</b> , captions are displayed during the duration of the jump back period only. When watching broadcast TV, jumps to previous channel. When using an on-screen keyboard, backspaces in the text you are entering.
	<b>VOLUME UP</b>	Turns volume up one setting with each press. Press and hold to turn volume up rapidly. A volume indicator shows the volume level while you are adjusting the volume and for a few seconds afterward. <b>NOTE</b> <ul style="list-style-type: none"><li>• If the TV is muted, pressing <b>VOLUME UP</b> unmutes the sound.</li></ul>
	<b>VOLUME DOWN</b>	Turns volume down one setting with each press. Press and hold to turn volume down rapidly. A volume indicator shows the volume level while you are adjusting the volume and for a few seconds afterward. <b>NOTE</b> <ul style="list-style-type: none"><li>• If the TV is muted, pressing <b>VOLUME DOWN</b> does not unmute the sound.</li></ul>

# Using your TV



## MUTE

Mutes the TV sound. A volume indicator shows the current volume level and a mute icon when you press this button and for a few seconds afterward. If **Closed captioning** is set to **On mute**, captions are displayed while the TV is muted.



## STREAMING CHANNEL SHORTCUT

Dedicated buttons show the logo of a featured streaming content provider. Pressing a button turns on the TV, and if the TV is connected to the Internet, performs one of the first two following actions:

- Displays the main page of the streaming channel if you have already added the channel to your **Home** screen.
- Displays the sign-up page for the streaming channel if you have not already added the channel so that you can agree to any terms and fees for the service.
- If the TV is in 'Standby' mode (off), turns the TV on. And, if it is connected to the Internet, the TV performs one of the first two actions listed above.

## NOTE

- For information about using a Universal Remote, refer to the [Other devices on page 42](#).

## Watching broadcast TV channels

To watch broadcast TV, select the **Antenna TV** tile in the **Home** screen. Your TV remembers the last channel you watched and starts with that channel playing.

**Tip:** You also can use the buttons on the TV panel to select Antenna TV, as explained in [TV panel buttons on page 18](#).

## Changing channels

To change channels, you can do any of the following:

- Press **[UP]** to change to the next higher channel.
- Press **[DOWN]** to change to the next lower channel.
- Press **[LEFT]** to display the channel list, and then press **[UP]** and **[DOWN]** to move the highlight through the list one channel at a time. Or press **[REVERSE SCAN]** and **[FORWARD SCAN]** to move the highlight through the list one page at a time. When you've highlighted the channel you want to watch, press **[OK]**. (If you decide you don't want to change channels, press **[RIGHT]** or **[BACK]**).
- Press **[↶]** to jump to the previous channel. Press again to return to the channel you were watching before you pressed **[↶]**.

## Viewing program information

To view information about the current program, press **[OK]**. The TV displays a banner at the bottom of the screen with as much information as is available in the program data stream.



Program information banner

Program information, subject to availability, includes:

- Channel number
- Channel call sign
- Signal strength



# Using your TV

- Program title
- Start time, end time, and graph of program length showing current position
- Content rating
- Video resolution (480i, 480p, 720p, 1080i, 1080p)
- Audio quality (Mono Dolby Digital, Stereo Dolby Digital, 5.1 Dolby Digital, Dolby Digital+)
- Audio features (SAP/MTS)
- Closed captioning (CC)
- Current time
- Program description. If the entire description does not fit, press **[OK]** to expand the size of the banner and see the entire description.

## Adjusting settings

Press **[\*]** to display the **Options** menu. Press **[UP]** and **[DOWN]** to highlight an option, and then press **[LEFT]** and **[RIGHT]** to change the setting. [Adjusting TV settings on page 24](#) explains each of the settings in detail.

## Switching TV inputs

---

Switch to a TV input to access the device connected to that input (for example, a Blu-ray player). Switching inputs is as simple as highlighting the input's tile in the **Home** screen, and pressing **[OK]**. The video signal on the input, if any, appears on the screen.

**Tip:** You also can use the buttons on the TV panel to select a TV input, as explained in [TV panel buttons on page 18](#). [Customizing your TV on page 29](#) explains how to rename and remove inputs.

## Auto-detecting devices

Your TV automatically detects when you connect a new device to an HDMI input and turn on its power. The input is automatically added to the **Home** screen if it isn't already present.

## Adjusting audio/video settings

While watching video content on any input, press **[\*]** to display the **Options** menu. Press **[UP]** and **[DOWN]** to highlight an option, and then press **[LEFT]** and **[RIGHT]** to change the setting. [Adjusting TV settings on page 24](#) explains each of the settings in detail.

# Using your TV

## Playing content from USB storage devices

---

Your TV has a USB port that can be used to play personal music, video, and photo files from a USB flash drive or hard disk. If your TV is connected to the Internet, your **Home** screen has the **Roku Media Player** tile. If your TV has not been connected to the Internet, the **Home** screen has the **USB Media Player** tile.

To use this feature, first make sure your media files are compatible with the Roku/USB Media Player. As of the publication date of this guide, the following media file formats are supported:

- **Video** – MKV (H.264), MP4, MOV (H.264), TS (H.264)
- **Music** – AAC, MP3, WMA, WAV (PCM), AIFF, FLAC, AC3, and DTS\*
- **Photo** – JPG, PNG, GIF

To see the latest list of supported formats, view **Help** in the Media Player.

The Roku/USB Media Player displays supported file types only, and hides file types it knows it cannot play.

## Playing content from local network media servers

---

If you have connected your TV to a network, it can play personal video, music, and photo files from a media server on your local network. Media servers include personal computers running media server software such as Plex or Windows Media Player, network file storage systems that have built-in media server software, and other devices that implement the specifications of the Digital Living Network Alliance. Some servers do not fully implement the DLNA specification but are UPNP (Universal Plug and Play) compatible. The Roku Media Player will connect to them as well.

Some media servers can convert files into Roku compatible formats. DRM-protected content is not supported.

---

\* *DTS audio, whether in music or video files, is supported only by pass-through, meaning that the TV cannot directly output the sound of a DTS file, but can pass it through to a DTS-compatible receiver that is connected to the HDMI ARC or S/PDIF connector on the TV.*

# Adjusting TV settings

You can adjust most picture and sound settings while you are watching a program by pressing [ \* ]. If you don't find what you need, there are additional picture and sound settings in the Settings menu.

In most cases, the setting changes you make apply only to the input you are using. Antenna TV, each separate HDMI input, and the AV input each has its own settings that the TV remembers when you return to that input. The TV also remembers the settings that you specify while viewing streaming content.

## Settings menu

Use the **Settings** menu to adjust overall TV settings. Press [ ⏠ ] to go to the **Home** screen, and then navigate to **Settings > TV picture settings**.

You can adjust the following overall TV picture settings from the **Settings** screen:

- **TV brightness** – If the lighting level in your TV room changes, use this setting to help provide a better viewing experience; set to darker for a darker room, and brighter for a brighter room. Choose among **Normal** and four other settings to make the overall picture brighter or darker. So that you don't have to make this type of change for each TV input one at a time, this setting increases or decreases the TV's general brightness across all TV inputs. This setting is identical to the TV brightness setting you can access in the **Options** menu while watching a program.
- **Settings per input** – This section of options lists each TV input. Select an input to switch to that input. Then press [ \* ] to display the **Options** menu, where you can adjust the input's settings while watching a live picture and listening to the sound from that input.

**Tip:** You don't have to go to the **Settings** menu first—you can display an input's **Options** menu and adjust its settings whenever you are watching the input by pressing [ \* ].

## Options menu

The **Options** menu for each TV input provides settings for controlling the appearance of the picture and the quality of the audio.

To view the **Options** menu, press [ \* ] whenever you are watching a TV input or streaming a video. The **Options** menu is a panel that appears over the left side of the screen:

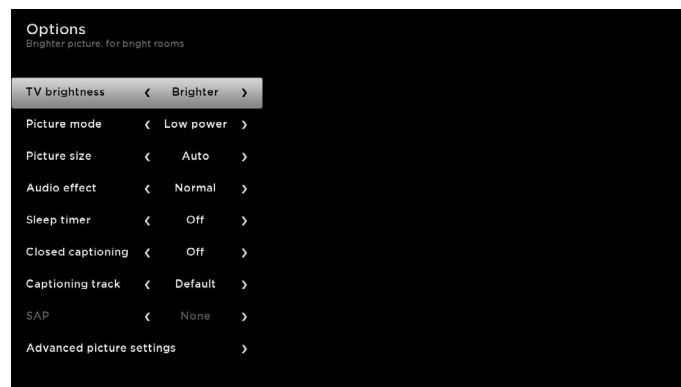

To adjust the settings on the **Options** menu, press [UP] or [DOWN] to highlight a setting, and then press [LEFT] or [RIGHT] to change the setting. You'll notice the changes you make right away in picture appearance or audio quality.

**Tip:** When you highlight a setting, the header text explains the effect of its current value. When you begin to adjust a setting, the other options are hidden so you can see more of the screen. Even though the other settings are hidden, you can move the highlight up or down to adjust the other settings.

# Adjusting TV settings

## Options menu settings

- **TV brightness** – Affects the overall brightness of the picture. *This setting applies across the entire TV; that is, to all TV inputs and is identical to the **TV brightness** setting in the **TV picture settings** menu.*
- **Picture mode** – Provides picture presets for various viewing preferences. *This setting applies to the currently-selected input only.*
- **Picture size** – Adjusts the aspect ratio of the picture, enabling you to view a picture in its original format, or zoom or stretch it to fill the screen. The **Auto** setting produces the best picture in most cases.
- **Audio effect** – Adjusts the sound quality output from the TV speakers. *This setting applies across the entire TV; that is, to all TV inputs.* It does not affect the sound quality from the HDMI (ARC) or SPDIF (TOSLINK) connector.
- **Sleep timer** – Sets a timer that turns off the TV after the specific amount of time. *This setting remains in effect even if you stop watching the current input.*
- **Closed captioning** – Controls when you see captions. *This setting is only offered for Antenna TV, the AV input, and streaming videos. Any set value remains in effect across only these inputs.*
- **Antenna TV** – Turn captions on or off, or set them to appear only when the TV sound is muted.
- **AV input** – Turn captions on or off, or set them to appear only when the TV sound is muted.
- **Streaming video channel** – Turn captions on or off, set them to appear only when the TV sound is muted, or only during instant replay (for streaming content that supports instant replay).

### **NOTE**

- Additional captioning options are provided in the **Captions** screen in **Settings**.
- **Captioning track** – Selects which caption track to display when Closed Captioning is on. *This setting remains in effect on all inputs that provide captions.*
- **SAP** – Selects whether to play a secondary audio program or multichannel television sound, and which choice to play. This setting applies only to Antenna TV on digital channels.

**Tip:** To dismiss the **Options** menu, just wait a few seconds without pressing any buttons. Or press [ \* ] again to dismiss the menu immediately.

# Adjusting TV settings

## Advanced picture settings

The **Advanced picture settings** menu for each TV input provides settings for fine tuning the appearance of the picture. All of the settings in this menu apply only to the currently-selected input.

To use the **Advanced picture settings** menu, first press [ \* ] to display the **Options** menu. Then select **Advanced picture settings**.

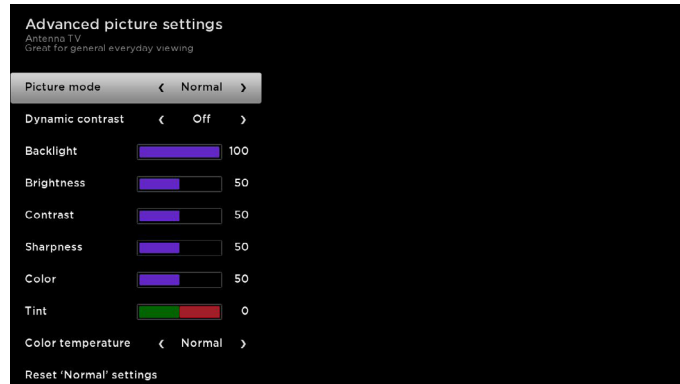

To adjust the settings on the **Advanced picture settings** menu, press [UP] or [DOWN] to highlight a setting, and then press [LEFT] or [RIGHT] to change the setting. You'll notice the changes you make right away in picture appearance.

**Tip:** When you highlight a setting, the header text explains the effect of its current value. When you begin to adjust a setting, the other options are hidden so you can see more of the screen. Even though the other settings are hidden, you can move the highlight up or down to adjust the other settings.

## Advanced picture settings menu options

- **Picture mode** – Provides picture presets for various viewing preferences. This setting duplicates the one on the **Options** menu. When you change the **Picture mode**, other picture settings adjust accordingly. For example, setting the **Picture mode** to **Vivid** sets **Brightness**, **Contrast**, **Sharpness**, and other values to produce a very vibrant picture. Setting **Picture mode** to **Movie** changes these same settings to produce a picture suitable for enjoying movies in a darkened room. If you make changes to the individual picture settings—for example, **Contrast**, or **Sharpness**—these settings are saved for the current input and the current picture mode. In this way, the HDMI 1 input's **Movie** picture mode can be different than the HDMI 2 input's **Movie** picture mode and Antenna TV's **Movie** picture mode. Use **Reset picture settings**, described below, to return the input's current picture mode to its original values.
- **Dynamic contrast** - Adjusts the backlight level of the screen automatically.
- **Backlight** - Adjusts the overall brightness of the screen.
- **Brightness** – Adjusts the dark level of the black areas of the picture.
- **Contrast** – Adjusts the white level of the light areas of the picture.
- **Sharpness** – Adjusts the sharpness of the edges of objects in the picture.
- **Color** – Adjusts the intensity of colors in the picture. A setting of 0 removes all color and displays a black and white picture.
- **Tint** – Adjusts the color balance from green to red to obtain accurate colors in the picture.
- **Color temperature** – Adjusts the overall colors in the picture from **Normal** to slightly more bluish (**Cool**) to slightly more reddish (**Warm**).
- **Game mode** – Controls whether 'Game' mode is on or off. When **On**, the TV performs less image processing and has less input lag. When **Off**, the TV performs more image processing and has more input lag, which is less desirable for action games. *Available only for HDMI inputs.*
- **Reset picture settings** – Returns all picture settings for the input's currently-selected **Picture mode** to their original values.

**Tip:** To dismiss the **Advanced picture settings** menu, just wait a few seconds without pressing any buttons; or, press [ \* ] again to dismiss the menu immediately.

# Searching for movies and shows

Searching for movies and shows across multiple streaming channels is one of the unique features of your TV. Within a single search operation, you can search by:

- Movie name
- TV show name
- Actor or director name
- Streaming channel name
- Game name

**Tip:** Roku Search is available only if your TV is connected to the Internet.

## NOTE

- Roku Search doesn't search across all streaming channels, but searches across lots of popular streaming channels. The actual channels it searches vary by locale, but include popular providers such as Netflix, Hulu Plus, Amazon Instant Video, VUDU, and several others, with more being added all the time.

You can check which streaming channels are included in Roku Search by going to the **Search** screen, clearing all previous searches to reveal the search instructions, and then watching the channel tiles cycle at the bottom of the screen.

To search, select **Search** on the **Home** menu. The **Search** screen has a keyboard grid and initially displays instructions—a set of icons representing search categories and a list of participating provider tiles.

**Tip:** If you don't see the instructions, navigate to the end of the list of recent searches and select **Clear recent search selections**.

## How do I search?

---

To search, use the arrow buttons to enter a few characters of the search term. With each additional character you enter, you narrow down the search and the search results become more relevant.

**Tip:** Use the Roku mobile app on your smartphone or tablet to make typing and searching even faster.

An icon next to each search result shows the category of the result.

Press **[RIGHT]** to highlight the search results.

Press **[UP]** and **[DOWN]** to scroll through the list of search results to highlight the item you want to view.

## I found a show, now what?

---

Now that you've highlighted the show, movie, actor, game, or streaming channel you were looking for, press **[RIGHT]**. If your search result was an actor, director, or other item that does not represent a single item of content, you'll see another list to narrow down your search. Continue highlighting results and pressing **[RIGHT]** until you find a single, viewable content item.

When you narrow down your search to a game or streaming channel, you'll see detailed information, images or screenshots, and available actions such as a list of streaming channels and the cost of getting the item on each channel.

An **HD** logo means that the content is available in high-definition. The checked circle adjacent to the title indicates streaming channels you already have installed.

The next time you use the search feature, the **Search** screen displays a list of recent search selections in place of the search instructions.

Using the recent search selections list makes it easy to quickly get to a previously found item (for example, to find another movie with the same actor, or another TV show in the same series).

# Using the Roku Channel Store

The **Streaming Channels** menu option takes you to the Roku Channel Store, where you can add new streaming channels and applications to your TV.

**Tip:** The **Streaming Channels** menu option is available only if your TV is connected to the Internet.

**Tip:** You also can search for streaming channels by using the **Search** option, as explained in [Searching for movies and shows on page 27](#).

To make it easier to find what you want, the streaming channels in the Roku Channel Store are categorized by topic. Press **[UP]** and **[DOWN]** to highlight the category you want, and then press **[RIGHT]** to move the highlight into the grid of streaming channel tiles.

When you find a streaming channel you want to add or learn more about, highlight it and press **[OK]** to display more details.

- If the streaming channel you are adding is free, you can start watching it immediately.
- If there is a one-time or recurring fee associated with using the streaming channel, you must agree to the terms and conditions, accept the fee, and—if you created one when you activated your TV— enter your Roku PIN code to authorize the charges.
- If you already have a subscription to the streaming channel—for example, you already subscribe to Netflix or you receive HBO through your cable TV provider—you must complete a different, simple authorization step to add the streaming channel.

You only have to complete the authorization or activation step one time, when you initially add the streaming channel. After that, you simply select the streaming channel tile from your **Home** screen to start watching.

**Tip:** New streaming channels and apps are being added weekly, so be sure to check back every now and then.

# Customizing your TV

There are several things you can do to personalize your TV.

## Rearrange tiles

Whenever you add a TV input tile, it's added at the top of your **Home** screen. Whenever you add a new streaming channel from the Roku Channel Store, it's added at the bottom of your **Home** screen.

You can easily rearrange the order of the tiles on the **Home** screen to suit your viewing preferences. For example, you might want **Antenna TV** to be the first tile in your **Home** screen. But, if you mostly watch one streaming channel, you might want its tile to be the first one on your **Home** screen.

Rearranging tiles is easy:

1. From the **Home** screen, highlight one of the tiles you want to move.
2. Press [**\***] to display a list of options for the type of tile you selected.
3. Select **Move input**. The list of options disappears and the highlighted tile shows arrows indicating how it can be moved.

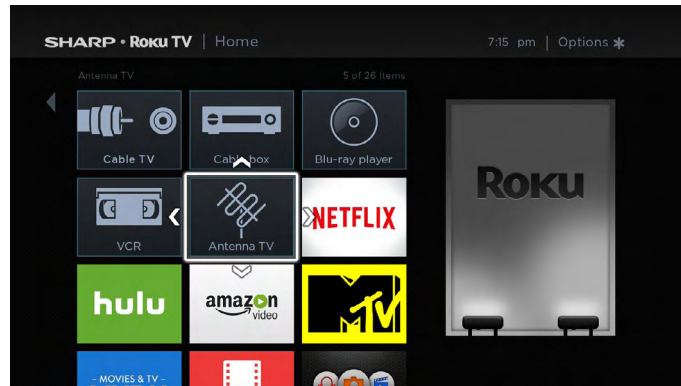

4. Use the arrow buttons to move the highlighted tile to its new position. As you move the tile, it pushes other tiles out of its way.
5. Press [**OK**] to lock the tile into its new position.
6. Repeat these steps to move other tiles until you have arranged your **Home** screen to your liking.

## Edit broadcast TV channel lineup

When you set up the TV tuner as described in [Setting up Antenna TV on page 15](#), the TV adds all the channels with good signals that it could detect in your area. It's likely that you now have more channels than you want in your channel list.

To edit the channel lineup, from the **Home** screen, navigate to **Settings > TV inputs > Antenna TV > Edit channel lineup**. You'll see a screen listing all of your channels. Adjacent to the list of channels is a miniature TV screen playing the highlighted channel's picture and sound.





# Customizing your TV

Highlight each channel you want to hide, and then press **[OK]** to hide the channel.

**Tip:** If you need to see or hear the highlighted channel, wait a couple of seconds for the TV to start playing the channel's picture and sound. Also note that if you've enabled Parental Controls and the program on the current channel is blocked, you won't see a picture or hear sound while editing the channel lineup.

## Rename inputs

Rather than trying to remember that your Blu-ray player is connected to HDMI1 and your game console is connected to HDMI 3, you can rename the TV inputs to match the connected component.

### NOTE

- Renaming an input also changes the icon associated with it.

To rename an input, you can either:

- Highlight the input tile in the **Home** screen, and then press **[\*]** to display a list of options. From the list of options, select **Rename input**. Then select a new name and icon.

or

- From the **Home** screen, navigate to **Settings > TV inputs**. On the **TV inputs** screen, select the input you want to rename, select **Rename**, then choose a new name and icon from the provided list.

Press **[Home]** to return to the **Home** screen. The new name and icon are now in effect.

## Remove unwanted tiles

It's easy to remove unused TV inputs and unwanted channel or app tiles. For example, if you never use the HDMI 3 input, or if you don't like the weather app you added from the Roku Channel Store, you can remove them from your **Home** screen.

You also can remove the **Antenna TV** tile if you never use the TV tuner. However, be aware that removing the Antenna TV tile also deletes the broadcast TV channel list. You'll have to set up the TV tuner again next time you add **Antenna TV**. Instructions for setting up the TV tuner can be found in [Setting up Antenna TV on page 15](#).

- To remove any tile, highlight the input tile in the **Home** screen, and then press **[\*]** to display a list of options. From the list of options, select **Remove input**. In the screen that follows, confirm you want to remove the input.
- Alternatively, to remove a TV input tile from the **Home** screen, navigate to **Settings > TV inputs**. On the **TV inputs** screen, select the input you want to remove, and then select **Remove > Confirm**. Then, press **[Home]** to return to the **Home** screen.

## Change themes

Another way to customize your TV is to change its theme. The theme establishes the look and feel of the TV through colors, designs, and fonts.

**Tip:** Themes are available only when your TV is connected to the Internet.

To change the theme, in the **Home** screen menu navigate to **Settings > Themes**. In the **Themes** screen, choose from the following options:

- **My themes** – Highlight a theme, and then press **[OK]** to switch to that theme.
- **Custom settings** – Turn **Featured themes** on or off. When **Featured themes** is on, the TV automatically switches to featured themes—like 4<sup>th</sup> of July or Holidays—for a limited time whenever Roku makes them available, and then switches back to your selected theme when the featured theme expires. When off, the TV always uses your selected theme.

**Tip:** You can get new themes by using the Roku Channel Store.

# Customizing your TV

## Change sound effects volume

Sound effects are the noises the TV makes to let you know it received your command. You can change the volume of sound effects or turn them off.

To adjust the sound effects volume, in the **Home** screen menu, navigate to **Settings > Audio > Menu volume**. Navigate to the right and then change the setting to **High, Medium, Low, or Off**.

## Configure power settings

Power settings let you set up your TV so that it turns on to the location you choose. Power settings also help your TV save energy by automatically turning it off under certain conditions.

### Power on settings

Power on settings tell the TV what to do when you turn on the power. To configure the power on settings, from the **Home** screen menu, navigate to **Settings > System > Power > Power on**. Highlight the power on location from the list, and then press **[OK]** to select it.

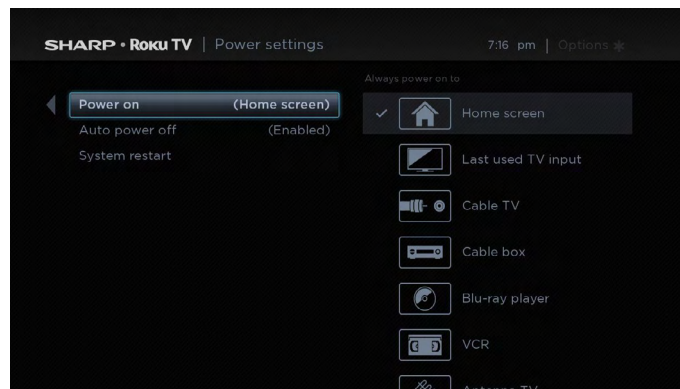

### Auto power off settings

To help you save energy, your TV can automatically turn itself off after a period of inactivity or a period during which no signal has been detected. It is factory-configured to do both of these things, but you can change these settings if needed.

To configure automatic power off, from the **Home** screen menu navigate to **Settings > System > Power > Auto power off**. In the **Power settings** screen, highlight the following options and press **[OK]** to turn them on or off:

- **After 15 minutes of no signal** – If no signal is detected on a TV input for 15 minutes, the TV automatically powers off.
- **After 4 hours of no interaction** – If no remote control or panel button is pressed for 4 hours and the TV is not displaying a TV signal or streaming a video, the TV is automatically powered off.

# Customizing your TV

## Configure parental controls

Parental controls enable you to control whether the members of your household can view certain kinds of broadcast TV programs. When a program or feature is blocked, you can unblock it by entering a parental control PIN that only you know.

### NOTE

- The **Parental Control** feature does not block streaming videos or content from inputs other than Antenna TV.

## Creating a Parental Control PIN

The first time you access the **Parental controls** screen, you must create a new parental control PIN. Thereafter, whenever you want to change parental control settings, unblock programming that has been blocked, change the PIN, or disable parental controls, you must enter your parental control PIN.

**Tip:** Your parental control PIN has nothing to do with your Roku PIN. You can make them the same if you want—this is entirely your choice.

To create a new parental control PIN, from the **Home** screen menu navigate to **Settings > Parental controls**. The screen displays a numeric keypad. Use the arrow buttons and the **[OK]** button to enter a four digit code. Then, repeat the process to enter the same PIN again, just to make sure you correctly entered the PIN you want to use.

- **Important:** If you forget your PIN, the only way to recover is to perform a factory reset operation, as explained in [Factory reset everything on page 40](#). Be sure to write it down in a safe place just in case.

## Blocking Movie Store, TV Store, and News

One of the parental control options is to completely hide the entertainment options that are available directly on the **Home** screen menu.

To hide **Home** screen entertainment options:

1. From the **Home** screen menu, navigate to **Settings > Parental controls**, and then enter your PIN.
2. In the **Parental controls** screen, highlight **Home screen** and then select or clear either of these options:
  - **Hide “Movie Store and TV Store”** – Removes the **Movies Store** and **TV Store** options from the **Home** screen menu.
  - **Hide “News”** – Removes the **News** option from the **Home** screen menu.

**Tip:** To use either of these options after you've hidden them, you must return to this screen and remove the check mark from the corresponding **Hide** command.

## Blocking Broadcast TV shows

For broadcast TV, parental controls use information embedded in the broadcast signal to determine whether to allow a program to be displayed. Parents can configure parental controls to block broadcast TV programs that meet or exceed a specific rating, so they cannot be viewed or heard unless the correct parental control PIN is entered.

### Enabling parental control of TV shows

The first step in blocking TV shows is to enable parental control of TV shows.

This setting is provided separately to make it easier for you to turn parental control of TV shows on and off without disturbing their settings. For example, your kids are going to summer camp for two weeks, and while they are gone, you don't want to have to deal with unblocking shows that you want to watch by entering your PIN. All you need to do is clear **Enable parental controls**, and all TV shows are unblocked. When the kids return, select **Enable parental controls** again, and all of your parental control settings are restored in a single operation.

To enable parental control of TV shows:

1. In the **Home** screen menu, navigate to **Settings > Parental controls**, and then enter your PIN.
2. In the **Parental controls** screen, navigate to **TV tuner > Parental control of TV shows**.
3. Make sure the check box next to **Enable parental controls** is checked. If not, highlight it and press **[OK]**.

# Customizing your TV

## Blocking based on US TV ratings

Most broadcast US TV shows—other than movies—contain rating data that enables parental controls to block shows that parents don't want others to view. The ratings are divided into two groups that function independently:

- Youth group – TV-Y, TV-Y7
- Main group – TV-G, TV-PG, TV-14, TV-MA

Within each of these groups, the ratings interact such that if you block a particular level of content, the TV also blocks all content with a higher rating. Conversely, if you unblock a particular level of content, the TV also unblocks all content with a lower rating. For example, if you block TV-PG programs, the TV also blocks TV-14 and TV-MA programs. If you subsequently unblock TV-14 programs, TV-PG programs are also unblocked, but TV-MA programs remain blocked.

Similarly, within the main group, content types can be individually blocked. For example, you can block just coarse language in shows with a TV-PG rating. If you do, then the TV also blocks shows with coarse language in the higher ratings (TV-14 and TV-MA). Subsequently unblocking coarse language in TV-14 ratings does not unblock coarse language in TV-MA programs, but it does unblock coarse language in TV-PG programs.

To block TV shows based on US television ratings:

1. From the **Home** screen menu, navigate to **Settings > Parental controls**, and then enter your PIN.
2. In the **Parental controls** screen, navigate to **TV tuner > TV ratings**. Choose among the following settings:
  - **Entire ratings** – Highlight the rating you want to block, and then navigate to the **[RIGHT]** and select the first option that blocks the entire rating level (and all higher rating levels).
  - **Individual content types** – Highlight the rating that contains the content type you want to block, and then select the content types you want to block from among those listed. Remember that blocking a content type in one rating blocks the equivalent content type in all higher rating levels.

## Blocking based on US movie ratings

Most movies in the US are rated by the Motion Picture Association of America, or MPAA, so the ratings are known as MPAA ratings. TV broadcast signals carry movie rating data that enables parental controls to block shows that parents don't want others to see. The ratings are:

- G – General audiences
- PG – Parental guidance suggested
- PG-13 – Parents strongly cautioned for children age 13 or younger
- R – Restricted
- NC-17 – Not for age 17 or younger

Unlike US TV ratings, there are no individual content types within the ratings. But like TV ratings, blocking movies with a particular rating also blocks movies with a higher rating, and unblocking movies with a particular rating also unblocks movies with a lower rating.

**Tip:** Blocking movies with an NC-17 rating also blocks programs with the now-obsolete X rating, which can still occur in the program data of older movies.

To block movies based on MPAA ratings:

1. From the **Home** screen menu, navigate to **Settings > Parental controls**, and then enter your PIN.
2. In the **Parental controls** screen, navigate to **TV tuner > Movie ratings**. Choose among the following settings:
3. Select the rating level you want to block. You need only select one rating level, and all higher levels are automatically blocked.

# Customizing your TV

## Blocking based on other ratings

Your TV can block programs having ratings that had not been defined when the TV was manufactured. It does this by detecting a new Rating Region Table in a program and then downloading the new table and displaying its rating in the Parental controls.

When the TV downloads a new Rating Region Table, it adds a new option to the list of rating types: **Other ratings**. If you see this option in the **Parental controls** screen, you have tuned to a station that has implemented a new rating table. Once the new rating table has been downloaded to the TV, it remains in the TV until it is factory reset, and you can configure blocking based on the new ratings.

New Region Rating Tables can have independent rating levels, or rating levels that interact in the same ways as the built-in US TV and MPAA Movie ratings.

**Tip:** If your TV downloads a new Region Rating Table, you'll have to experiment with its settings to understand how to use it.

## Blocking unrated programs

Some broadcast TV shows and movies are assigned a rating of "Unrated". Whether or not such programs contain content that is objectionable to you cannot be determined. However, you can choose to block such programs.

To block all unrated broadcasts:

1. From the **Home** screen menu, navigate to **Settings > Parental controls**, and then enter your PIN.
2. In the **Parental controls** screen, navigate to **TV tuner > Block all unrated programs**.
3. Highlight **Unrated programs** and press **[OK]**. When blocking is enabled, the adjacent padlock icon changed from unlocked to locked.

**Tip:** Blocking programs that have been assigned a rating of "Unrated" does not block programs that have no rating assigned to them (for example a broadcast of a local town council meeting). Programs that do not have an assigned rating display **Rating NA** (for "not applicable", meaning a rating is not needed). Programs that have no assigned rating are considered "safe"; therefore, there is no need to block them.

## What happens when a TV show is blocked?

After you've set up parental controls, TV shows and movies can be blocked:

- When you change channels and the new channel is playing a program whose rating exceeds your settings.
- When a new show comes on the channel you are watching and its rating exceeds your settings.

When a program is blocked by parental control settings, the TV displays a blocked message:

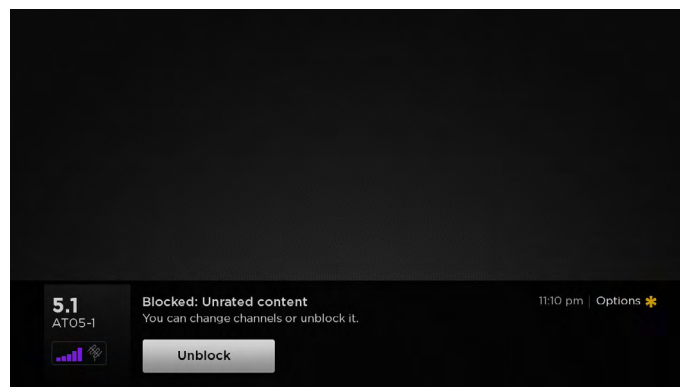

Whenever this blocked message appears, both the video and audio of the show are blocked, as well as program data that would normally appear in the area at the bottom of the screen.

To watch the blocked program, you need to know the PIN code defined when you enabled parental controls, as explained in [Creating a Parental Control PIN on page 32](#).

# Customizing your TV

1. Press **[OK]** to select **Unblock** and display a PIN pad.

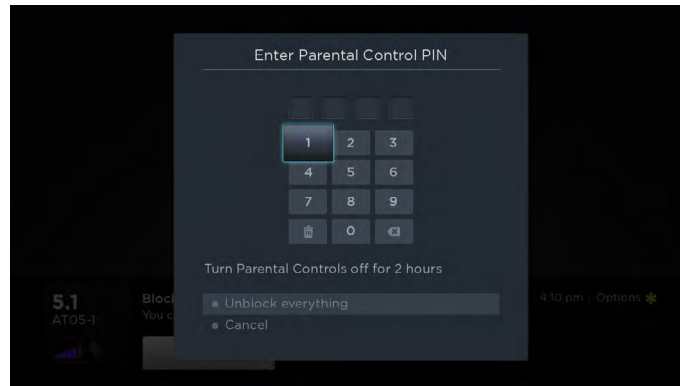

2. Use the arrow buttons to enter your PIN code, and then press **[OK]** to select **Unblock everything**. After unblocking shows that have been blocked, all blocking is disabled for two hours or until you turn off the TV.

## Changing the parental control PIN

To change your parental control PIN:

1. From the **Home** screen menu, navigate to **Settings > Parental controls**, and then enter your PIN.
2. In the **Parental controls** screen, highlight **Change PIN**.
3. Move the highlight into the adjacent keypad, and then use the arrow buttons and the **[OK]** button to enter a four digit code. Then repeat the process to enter the same PIN again, just to make sure you correctly entered the PIN you want to use.

## Resetting parental controls

So now your kids have grown up and gone away to college, and you no longer want to deal with blocked programs.

To erase all parental control settings:

1. From the **Home** screen menu, navigate to **Settings > Parental controls**, and then enter your PIN.
2. In the **Parental controls** screen, highlight **Reset parental controls**.
3. Follow the instructions on the screen to confirm that you want to erase all parental control settings.

**Tip:** Resetting parental controls also erases your parental control PIN.

# More settings

This section describes the features and settings of the TV that were not covered in the other parts of this manual.

## Changing network settings

---

If needed, you can change your network settings at any time. For example, if you change the name of your wireless network (its SSID) or its password, you will need to change your TV's settings so that it can continue to connect. Also, if you decided not to connect to the Internet in [Guided Setup on page 6](#), you can use Network settings to connect at a later time.

To change network settings, from the **Home** screen menu, navigate to **Settings > Network**, and then press **[RIGHT]**. At this point, you can choose the following options:

- **Update connection** – Press **[OK]** to start the update process. The TV uses your current wireless network name and password to reconfirm the wireless connection, the local network connection, and the Internet connection.
- **Set up new wireless connection** – Press **[OK]** to start a scan for wireless networks. The TV scans for the wireless networks within range and displays the first few it finds in order, with the strongest signals first. In addition to your own wireless signal, the TV might pick up signals from your neighbors. Now you can do one of the following:
  - **Select your network name** – Select the name of your network and then enter your wireless password if requested.
  - **Scan again to see all networks** – If you don't see your wireless network name in the list, select **Scan again to see all networks** to list all networks in range. The first scan listed only the first few, strongest wireless signals. The second scan sometimes results in a longer list. If you still don't see your network name, you might need to adjust the location of the wireless router or the TV, turn on your router, or make other changes. When everything is ready, select **Scan again to see all networks** to repeat the network scan.
  - **Private network** – If your wireless network name is hidden, it won't appear in the list. Select **Private network** to display an on-screen keyboard, and use it to enter your network name. Unless you changed the factory-set network name, you can find the name (also called SSID) on a label the router.
    - **Tip:** Wireless networks that are password-protected display a "padlock" icon adjacent to the name.



## Changing caption settings

---

You can change many different settings that affect the appearance of captions.

To change caption settings, from the **Home** screen menu, navigate to **Settings > Captions**, and then press **[RIGHT]**. At this point, you can choose the following options:

- **Captions mode** – Choose **Off**, **On**, **When mute**, or **Instant replay**.
  - If you choose **On**, the TV displays captions whenever they are available in the program information. *This setting applies to Antenna TV, the AV input, and streaming channels.*
  - If you choose **When mute**, the TV displays captions only when the sound is muted. *This setting applies to Antenna TV, the AV input, and streaming channels.*
  - If you choose **Instant replay**, the TV displays captions only during a replay operation; that is, after pressing **[↶]** to jump back a few seconds in streaming video. *This setting applies only to streaming channels when the program being streamed supports instant replay.*

This setting reflects the Closed captioning settings in the Options menu for certain TV inputs, as explained in [Options menu settings on page 25](#). *Note that, once enabled, the captions mode remains set for all applicable inputs until you turn it off.*

**Tip:** *Some streaming channels require you to enable captions through a setting within their channel even though you have turned on captions everywhere else.*

- **Text style** – Choose from a list of fonts. As you move the highlight to each font, you can see a sample of the result in an adjacent panel.
- **Text edge effect** – Choose from a list of edge effect styles, such as raised, depressed, and various shadows. As you move the highlight to each effect, you can see a sample of the result in an adjacent panel.

## More settings

- **Text size** – Choose from a list of sizes. As you move the highlight to each size, you can see a sample of the result in an adjacent panel.
- **Text color** - Choose from a list of colors for the text. As you move the highlight to each color, you can see a sample of the result in an adjacent panel.
- **Text opacity** - Choose from a list of opacity settings for the text. This setting determines how much the area behind the text shows through the text. A value of 100% blocks all of the content behind the text. As you move the highlight to each setting, you can see a sample of the result in an adjacent panel.
- **Background color** - Choose from a list of colors for the background area behind the text. As you move the highlight to each color, you can see a sample of the result in an adjacent panel. Note that you won't see any change unless you set the **Background opacity** to a value other than **Off**.
- **Background opacity** - Choose from a list of opacity settings for the background of the caption. This setting determines how much the area behind the caption background shows through the background. A value of 100% blocks all of the content behind the background. As you move the highlight to each setting, you can see a sample of the result in an adjacent panel.
- **Window color** - Choose from a list of colors for the window rectangle surrounding the entire caption. As you move the highlight to each color, you can see a sample of the result in an adjacent panel. Note that you won't see any change unless you set the **Window opacity** to a value other than **Default** or **Off**.
- **Window opacity** - Choose from a list of opacity settings for the window rectangle surrounding the entire caption. This setting determines how much the area behind the caption window shows through the window. A value of 100% blocks all of the content behind the window. As you move the highlight to each setting, you can see a sample of the result in an adjacent panel.

## Changing time settings

---

You can change time settings to suit your preferences. You can find the following settings by navigating from the **Home** screen menu to **Settings > System > Time**:

- **Sleep timer** – Set a time delay after which the TV will automatically shut off. This setting reflects the setting you can make in the **Options** menu from any TV input, as explained in [Options menu settings on page 25](#). *Note that the sleep timer setting is not input specific.*
- **Time zone** – Select whether to set the time zone automatically or manually, and if set manually, select your current time zone. Typically, a TV connected to the Internet can discover its own time zone automatically, and a TV that is not connected to the Internet must be set manually. Initially, this setting is made when you set up the TV tuner, as explained in [Setting up Antenna TV on page 15](#). Correct time zone information is needed to correctly display program data.
- **Clock format** – Select whether to display time in a 12-hour or 24-hour format, or to turn off time display. This setting is available only on TVs that are connected to the Internet. Non-connected TVs do not display time.

## Scanning for broadcast TV channels again

---

There will be times when you need to create a new channel list. For example, you:

- Change cable providers
- Reorient your TV antenna
- Move to a different city with different channels

Whenever you need to update your TV channel list, the TV can repeat the channel scan.

To repeat the channel scan, from the **Home** screen menu, navigate to **Settings > TV inputs > Antenna TV > Scan again for channels**. Then select **Start finding channels** to begin the channel scan process. The screens and options that appear during this process are identical to those described in [How do I set up the TV tuner? on page 15](#).



# More settings

## Using the TV in a home theater

Your TV has several features that make it an ideal TV for a home theater. But you might not notice them because they remain in the background until you decide to use them.

### Turning off TV speakers

When you use your TV with a sound bar or an external amplifier and speakers, you'll probably want to turn off the internal TV speakers.

To turn off the TV's built-in speakers, in the **Home** screen menu, navigate to **Settings > Audio > TV speakers**. Then highlight **TV speakers on** and press **[OK]** to change the settings to **TV speakers off**.

*Tip: The TV's internal speakers can be turned off and on automatically as needed by system audio control, as described in [Enabling system audio control on page 39](#).*

### Changing the audio mode

The TV has two audio modes, accessed by navigating in the **Home** screen menu to **Settings > Audio > Audio mode**:

- **Stereo** – Use this setting for internal speakers, headphones, and external stereo amplifiers connected through HDMI ARC, SPDIF optical, or headphone port.
- **Auto** – Use this setting to automatically detect the best audio setting based on the audio stream in the content you are watching. If you have connected the TV to an external Dolby Digital or Dolby Digital Plus compatible amplifier, receiver, or sound bar through HDMI® ARC or SPDIF optical, the TV automatically selects the appropriate surround sound capabilities of the device based on the characteristics of the current program.

#### **NOTE**

- *Dolby Digital Plus format is only passed through the HDMI ARC connection.*

### Setting up a digital audio connection

You can connect the TV to an external amplifier, receiver, or sound bar by using either of these two connections:

- **HDMI ARC** – The HDMI Audio Return Channel enables the TV to output digital audio on one of its HDMI connectors. The connected amplifier can also function simultaneously as an input source to the TV, if needed. To use the ARC capability, you must connect an HDMI cable from your amplifier's HDMI ARC connector to the HDMI ARC connector on the TV. You also must:
  - Be sure your HDMI cable is certified by HDMI.
  - Enable **HDMI ARC** under **Settings > System > Control other devices (CEC)**, as explained in [Enabling HDMI ARC on page 39](#).
  - Select the appropriate setting under **Settings > Audio > S/PDIF and ARC**, as explained in [Changing the audio mode on page 38](#).
- **SPDIF optical** – The TV has an SPDIF optical connector that outputs a digital audio signal. To use the optical output, connect a TOSLINK optical cable from the amplifier to the Optical or SPDIF connector on the TV. You also must:
  - Select the appropriate setting under **Settings > Audio > S/PDIF and ARC**, as explained in [Changing the audio mode on page 38](#).

### Controlling other devices through CEC

Consumer Electronics Control (CEC) enables your TV and other CEC-compatible home entertainment components to control one other in various ways. First, the CEC-compatible devices must “discover” one another and report their capabilities. After this, one device can control another according to the features you enable. For example, playing a disc on a Blu-ray player could switch the TV to the Blu-ray player's input. Or, powering off the TV could also power off the Blu-ray player and the home theater receiver.

# More settings

## Discovering connected CEC devices

To discover CEC devices:

1. Make sure that your CEC-compatible components are connected to the TV with a suitable high-speed HDMI cable that supports HDMI ARC and CEC control.
2. Turn on each component and make sure all components have CEC enabled.

*Tip: Some manufacturers have their own branded names for CEC functionality, so you might need to read the product documentation to correctly identify the CEC features of the device.*

3. On the TV's **Home** screen menu, navigate to **Settings > Control other devices (CEC) > Search for CEC devices**, and then press **[OK]** to start the discovery process.

When finished, the TV displays a list of CEC devices that are connected to each HDMI input, as well as any devices that had previously been connected. The TV remembers the names of multiple CEC devices even when they are no longer connected. If the list is longer than the allowed space, press **[\*]** to see a complete list in a scrollable window.

## Enabling HDMI ARC

HDMI ARC is the audio return channel that is available on one of the TV's HDMI ports. The audio return channel enables you to send a Dolby Digital audio signal back to a home theater receiver that is also sending an audio and video signal into the TV. Using HDMI ARC reduces the number of cables needed and optionally lets you control the volume and mute state of the receiver by enabling system audio control.

HDMI ARC is disabled by default. To enable HDMI ARC, in the **Home** screen menu, navigate to **Settings > System > Control other devices (CEC)**, and then highlight **HDMI ARC**. Press **[OK]** to check the adjacent check box.

## Enabling system audio control

System audio control enables the TV remote control to change the volume and mute state of an amplifier or sound bar connected through HDMI, and to display the external device's volume and mute status in the TV's on-screen display.

The TV automatically turns off its internal speakers and sends volume and mute control signals to an external amplifier when all of the following are true:

- System audio control is enabled on the TV.
- A CEC-compatible amplifier is powered on and CEC discoverability is enabled.
- The CEC-compatible amplifier's HDMI ARC connector is connected to the TV's HDMI ARC connector with a suitable HDMI cable.

When the CEC-compatible amplifier is off, the TV automatically turns on its speakers (unless you have turned them off as described in [Turning off TV speakers on page 38](#)) and resumes local control of volume and mute state.

System audio control is disabled by default. To enable system audio control, in the **Home** screen menu, navigate to **Settings > System > Control other devices (CEC)** and highlight **System audio control**. Press **[OK]** to check the adjacent check box.

## Enabling 1-touch play

1-touch play enables a component to control which TV input is active. For example, pressing Play on your Blu-ray player switches the TV to the Blu-ray input.

1-touch play is disabled by default. To enable 1-touch play, in the **Home** screen menu, navigate to **Settings > System > Control other devices (CEC)** and highlight **1-touch play**. Press **[OK]** to check the adjacent check box.

## Enabling system standby

The system standby feature causes other components to power off when you power off your TV. Depending on the CEC System Standby implementation, it also might enable connected components to power off your TV when you power off the component.

System standby is disabled by default. To enable system standby, in the **Home** screen menu, navigate to **Settings > System > Control other devices (CEC)** and highlight **System standby**. Press **[OK]** to check the adjacent check box.

# More settings

## Restarting the TV

---

You can restart the TV when necessary. Restarting has the same effect as unplugging the TV power and then plugging it in again.

To restart the TV, navigate to **Settings > System > Power** and then move right to **System restart** and then **Restart**. Press **[OK]** to confirm restart.

While the TV restarts, the screen goes dark for a few seconds, and then displays the startup screen for a few more seconds. When the restart operation is complete, you'll see the familiar **Home** screen.

## Resetting the TV

---

You can choose to reset only the TV picture and audio settings to their original values, or perform a full factory reset to return the TV to the state it was in when you first unpacked and turned it on.

### Reset TV settings

To reset only the TV picture and audio settings to their original values, navigate to **Settings > System > Advanced system settings > Factory reset**, and then highlight **Reset TV audio/video settings**. Read the information on the screen to make sure you understand what the reset operation does.

To proceed with the reset operation, press **[PLAY/PAUSE]** three times in a row.

### Factory reset everything

A full factory reset returns the TV to its original, out-of-the-box state. When finished, you must repeat Guided Setup, reconnecting to the Internet, re-linking your Roku account, and reloading any streaming channels. You also must repeat Antenna TV setup and input configuration.

Factory reset is the recommended choice if you want to transfer the TV to another owner, and is the only choice if you want to switch from store mode to home mode (if you inadvertently selected store mode during Guided Setup).

To perform a factory reset, navigate to **Settings > System > Advanced system settings > Factory reset**, and then highlight **Factory reset everything**. Read the information on the screen to make sure you understand what this reset operation does.

To proceed with the full factory reset, use the arrow buttons and the **[OK]** button to enter a four digit code.

## Getting system updates

---

If your TV is connected to the Internet and linked with a Roku account, it will automatically get updates from time to time. You don't need to do anything. But if you are aware that an update is available and you don't want to wait until the TV updates itself, you can manually check for updates.

If your TV is not connected to the Internet, you can still get updates by using a USB flash drive.

### Checking for updates on a connected TV

If you're one of those people who has to have the latest, most up-to-date gadgets the moment they are available, you can check for updates as often as you want.

To check for updates, navigate to **Settings > System > System update**, and then select **Check now**. The TV responds either with a message saying that your TV is up to date, or with a message saying that an update is available.

Follow the instructions on the screen to install the system update.

# More settings

## Getting updates on a non-connected TV

If your TV is not connected to the Internet, you can still get system updates by using a USB flash drive and a computer with an Internet connection.

To get a system update, navigate to **Settings > System > System update**:

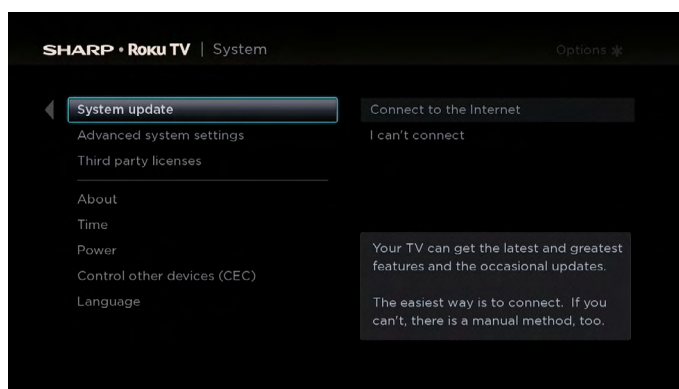

The **System update** screen on a non-connected TV gives you the opportunity to connect your TV to the Internet to automatically update your TV. We recommend this option if it is possible in your situation. To proceed, select **Connect to the Internet** and follow the instructions in [But what if I didn't connect my TV? on page 14](#).

Otherwise, if you can't connect to the Internet, select **I can't connect**, and then follow the instructions on the screen. Here's a summary:

1. On an Internet-connected computer, go to the web site displayed on the **System update** screen.
2. On the **USB Update** web page, select the correct TV model and then click **Download**. Save the file to the root folder of a standard USB flash drive.
3. When the download finished, take the USB flash drive to the TV and plug it into the USB port. When you do, the TV validates the files on the flash drive and displays a 12-digit code.
4. Write down the code and the web address, and take this information back to your Internet-connected computer.
5. On the **12-digit code** page, enter the code your TV displayed, and then click **Next**.
6. On the **6-digit code** page, write down the 6-digit code that appears, and then take it back to your TV.
7. Using the TV remote control, select **Next** to move to the next screen, and then use the on-screen keyboard to enter the 6-digit code. When finished, select **OK**. The system update begins. Do not remove the USB flash drive until the TV restarts.

When the update finishes, the TV restarts. You can check the new version number by navigating to **Settings > System > About**.

### USB flash drive

Any normal USB flash drive will work, provided it has a FAT-16 or FAT-32 file system format. (This is the default for most flash drives.)

The size of the download is small—usually less than 100 MB—and so will fit on any size flash drive you might have.

### 12- and 6-digit codes

The USB update process uses a pair of codes to validate that you are authorized to install an update, and to ensure you are not attempting to install an old, unsupported version of the system software.

# Other devices

## Getting and using the Roku mobile app

---

Roku makes the Roku mobile app free for iOS, Android, and Microsoft Windows 8/8.1 devices. With a Roku mobile app, you can control your Roku device, find and add new Roku Channels, search and find something to watch, and much more. You can find more information by going to [support.roku.com/home](https://support.roku.com/home) and searching for “mobile app.”

# Quick Problem-Solving Tips

When you experience an issue with your TV, turn it off and on again. If this does not resolve the problem, then refer to the tips below. If the problem is still not resolved, then contact our Hisense Electronics Consumer Care Center at [1-888-935-8880](tel:1-888-935-8880) Monday through Friday from 8 A.M. to 8 P.M. EST and Saturday through Sunday from 9 A.M. to 6 P.M. EST.

Customers that are located in Canada should call [1-855-271-6271](tel:1-855-271-6271).

SOUND OR PICTURE ISSUES	POSSIBLE SOLUTIONS
You do not hear any sound or see a picture	<ul style="list-style-type: none"><li>• Check if the power cord is plugged into a powered AC outlet.</li><li>• A power switch on the TV must be turned on. Press the <b>[Power]</b> button on the remote control to activate the unit from Standby.</li><li>• Check to see if the LED light is either red or blue. If it is on, then there is power to the TV.</li></ul>
You have connected an external source to your TV and do not see a picture and/or hear sound	<ul style="list-style-type: none"><li>• Check for the correct output connection on the external source and for the correct input connection on the TV.</li><li>• Make sure you have made the correct selection for the input mode for the incoming signal.</li></ul>
When you turn on your TV, there is a delay for a few seconds before the picture appears	<ul style="list-style-type: none"><li>• This is normal. If you have already set up your TV, it is initializing and searching for previous setting information.</li></ul>
You see a normal picture but do not hear any sound	<ul style="list-style-type: none"><li>• Check the volume settings.</li><li>• Check if 'Mute' mode is set to "On".</li></ul>
You hear sound but do not see a picture or it is in black and white	<ul style="list-style-type: none"><li>• If the picture is black and white, first unplug the TV from the AC outlet and replug it after 60 seconds.</li><li>• Check that the <b>Color</b> is set to 50 or higher.</li><li>• Try different TV channels.</li></ul>
Your sound and picture is distorted or appears wavy	<ul style="list-style-type: none"><li>• An electric appliance may be affecting the TV. Turn off any appliances that are nearby and move them farther away from the TV.</li><li>• Insert the power plug of the TV set into another power outlet.</li></ul>
Your sound and picture is blurry or cuts out	<ul style="list-style-type: none"><li>• If you are using an external antenna, check the direction, position and connection of it.</li><li>• Adjust the direction of your antenna or reset or fine tune the channel.</li></ul>

CONNECTIVITY ISSUES	POSSIBLE SOLUTIONS
You cannot connect to my wireless home network during the guided setup	<ul style="list-style-type: none"><li>• If you are getting 3 or more signal-strength bars above your wireless network, change the location of your TV or adjust the wireless router.</li><li>• Make sure there are no obstructions (for example, cement walls) between your TV and the wireless router.</li><li>• Make sure you have selected the correct wireless router on the <b>Choose wireless network</b> screen.</li><li>• If your network is secured (passwords are case sensitive) make sure that you entered the correct password.</li><li>• If you have turned off SSID broadcasting on your wireless router, you can add your network by selecting <b>Add network</b> from the <b>Select wireless network</b> screen.</li><li>• If security is enabled on your network, temporarily disable it on your router and try connecting again.</li></ul>

# Quick Problem-Solving Tips

## REMOTE CONTROL ISSUES

## POSSIBLE SOLUTIONS

Your remote control is not working

- Try moving closer to the TV.
  - Make sure that the batteries are working and inserted properly.
  - Make sure nothing is blocking the front of your TV.
  - If the status light on the front of your TV flashes once each time you press a button, then the problem is not with the remote.
-