

**Hisense**



# **USER MANUAL**

Before using the TV, please read this manual thoroughly and retain it for future reference.

ES-G

条形码定位框 35x10.5mm  
物料号:

***English***

	<b>CAUTION</b> RISK OF ELECTRIC SHOCK DO NOT OPEN	
<p><b>CAUTION:</b> TO REDUCE THE RISK OF ELECTRIC SHOCK, DO NOT REMOVE COVER (OR BACK). NO USER-SERVICEABLE PARTS INSIDE. REFER SERVICING TO QUALIFIED SERVICE PERSONNEL.</p>		



The lightning flash with arrowhead symbol, within an equilateral triangle is intended to alert the user to the presence of uninsulated dangerous voltage within the product's enclosure that may be of sufficient magnitude to constitute a risk of electric shock.



The exclamation point within an equilateral triangle is intended to alert the user to the presence of important operating and maintenance (servicing) instructions in the literature accompanying the appliance.

## FCC Statement

### NOTE:

This equipment has been tested and found to comply with the limits for a class B digital Device, pursuant to part 15 of the FCC Rules. These limits are designed to provide reasonable protection against harmful interference in a residential installation. This equipment generates, uses and can radiate radio frequency energy and, if not installed and used in accordance with the instructions, may cause harmful interference to radio Communications. However, there is no guarantee that interference will not occur in a particular installation. If this equipment does cause harmful interference to radio or television reception, which can be determined by turning the equipment off and on, the user is encouraged to try to correct the interference by one or more of the following measures:

- Reorient or relocate the receiving antenna.
- Increase the separation between the equipment and the receiver.
- Connect the equipment into an outlet on a circuit different from that to which the receiver is connected.
- Consult the dealer or an experienced radio/TV technician for help.

FCC ID Number WiFi and Bluetooth Module: N89-NU260HS  
The WiFi and Bluetooth Module complies with FCC radiation exposure limits set forth for an uncontrolled environment. This device should be installed and operated with a minimum distance of 20 centimeters between the radiator and your body.



This TV incorporates High-Definition Multimedia Interface (HDMI™) technology.

HDMI, the HDMI logo and High-Definition Multimedia Interface are trademarks or registered trademarks of HDMI Licensing LLC.

Hisense and associated logos where applicable are registered trademarks of Hisense Group in the United States and/or other countries. All other trademarks are property of their respective owners. © 2013 Hisense USA, Corporation. All Rights Reserved.

\* Specifications subject to change without notice.

## Energy Star

Your Hisense TV is ENERGY STAR® qualified in the “Energy Saving” mode. It meets strict energy efficiency guidelines set by the U.S. Environmental Protection Agency and Department of Energy. ENERGY STAR is a joint program of these government agencies, designed to promote energy efficient products and practices. Changes to certain features, settings, and functionalities of this TV (i.e. TV Guide, Picture, Sound) can increase or change the power consumption. Depending upon such changed settings, the power consumption may exceed the limits required for the ENERGY STAR qualification in the “Energy Saving” mode.



### NOTE

Where the MAINS plug or an appliance coupler is used as the disconnect device, the disconnect device shall remain readily operable.

### WARNING

The manufacturer is not responsible for any radio or TV interference caused by unauthorized modifications to this equipment. Such modifications could void the user's authority.



Manufactured under license from Dolby Laboratories.

Dolby and the double-D symbol are trademarks of Dolby Laboratories.



# CHILD SAFETY:

It Makes A Difference How and Where  
You Use Your Flat Panel Display

Congratulations on your purchase! As you enjoy your new product, please keep these safety tips in mind:



## THE ISSUE

- The home theater entertainment experience is a growing trend and larger flat panel displays are popular purchases. However, flat panel displays are not always supported on the proper stands or installed according to the manufacturer's recommendations.
- Flat panel displays that are inappropriately situated on dressers, bookcases, shelves, desks, speakers, chests or carts may fall over and cause injury.

## THIS MANUFACTURER CARES!

- The consumer electronics industry is committed to making home entertainment enjoyable and safe.

## TUNE INTO SAFETY

- One size does NOT fit all. Follow the manufacturer's recommendations for the safe installation and use of your flat panel display.
- Carefully read and understand all enclosed instructions for proper use of this product.
- Don't allow children to climb on or play with furniture and television sets.
- Don't place flat panel displays on furniture that can easily be used as steps, such as a chest of drawers.
- Remember that children can become excited while watching a program, especially on a "larger than life" flat panel display. Care should be taken to place or install the display where it cannot be pushed, pulled over, or knocked down.
- Care should be taken to route all cords and cables connected to the flat panel display so that they cannot be pulled or grabbed by curious children.



## WALL MOUNTING: IF YOU DECIDE TO WALL MOUNT YOUR FLAT PANEL DISPLAY, ALWAYS:

- Use a mount that has been recommended by the display manufacturer and/or listed by an independent laboratory (such as UL, CSA, ETL).
- Follow all instructions supplied by the display and wall mount manufacturers.
- If you have any doubts about your ability to safely install your flat panel display, contact your retailer about professional installation.
- Make sure that the wall where you are mounting the display is appropriate. Some wall mounts are not designed to be mounted to walls with steel studs or old cinder block construction. If you are unsure, contact a professional installer.
- A minimum of two people are required for installation. Flat panel displays can be heavy.

 **CEA**  
Consumer Electronics Association  
[www.CE.org/safety](http://www.CE.org/safety)

# Important Safety Instructions



**CAUTION**

**RISK OF ELECTRIC SHOCK**

**DO NOT OPEN**



---

**CAUTION:** TO REDUCE THE RISK OF ELECTRIC SHOCK, DO NOT REMOVE COVER (OR BACK). NO USER-SERVICEABLE PARTS INSIDE. REFER SERVICING TO QUALIFIED SERVICE PERSONNEL.



The lightning flash with arrowhead symbol, within an equilateral triangle is intended to alert the user to the presence of uninsulated dangerous voltage within the product's enclosure that may be of sufficient magnitude to constitute a risk of electric shock.



The exclamation point within an equilateral triangle is intended to alert the user to the presence of important operating and maintenance (servicing) instructions in the literature accompanying the appliance.

1. Read these instructions.
2. Keep these instructions.
3. Heed all warnings.
4. Follow all instructions.
5. Do not use this apparatus near water.
6. Clean only with dry cloth.
7. Do not block any ventilation openings. Install in accordance with the manufacturer's instructions.
8. Do not install near any heat sources such as radiators, heat registers, stoves, or other apparatus (including amplifiers) that produce heat.
9. Do not defeat the safety purpose of the polarized or grounding-type plug. A polarized plug has two blades with one wider than the other. A grounding type plug has two blades and a third grounding prong. The wide blade or the third prong are provided for your safety. If the provided plug does not fit into your outlet, consult an electrician for replacement of the obsolete outlet.
10. Protect the power cord from being walked on or pinched particularly at plugs, convenience receptacles, and the point where they exit from the apparatus.
11. Only use attachments/accessories specified by the manufacturer.
12. Use only with cart, stand, tripod, bracket, or table specified by the manufacturer, or sold with the apparatus. When a cart is used, use caution when moving the cart/apparatus combination to avoid injury from tip-over.
13. Unplug this apparatus during lightning storms or when unused for long periods of time.
14. Refer all servicing to qualified service personnel. Servicing is required when the apparatus has been damaged in any way, such as power-supply cord or plug is damaged, liquid has been spilled or objects have fallen into the apparatus, the apparatus has been exposed to rain or moisture, does not operate normally, or has been dropped.
15. Apparatus should not be exposed to dripping or splashing, and objects filled with liquids, such as vases, should not be placed on the apparatus.



S3125A

16. An outside antenna system should not be located in the vicinity of overhead power lines or other electric light or power circuits, or where it can fall into such power lines or circuits. When installing an outside antenna system, extreme care should be taken to keep from touching such power lines or circuits, as contact with them might be fatal.
17. Do not overload wall outlets and extension cords, as this can result in a risk of fire or electric shock.
18. Do not push objects through any openings in this unit, as they may touch dangerous voltage points or short out

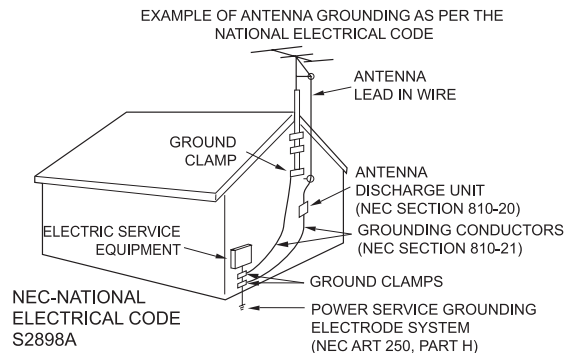

- parts that could result in fire or electric shock. Never spill or spray any type of liquid into the unit.
19. If an outside antenna or cable system is connected to the unit, be sure the antenna or cable system is grounded to provide some protection against voltage surges and built-up static charges, Section 810 of the National Electrical Code, ANSI/NFPA 70, provides information with respect to proper grounding of the mast and supporting structure, grounding of the lead-in wire to an antenna discharge unit, size of grounding conductors, location of antenna discharge unit, connection to grounding electrodes, and requirements for the grounding electrode.
  20. When replacement parts are required, be sure the service technician uses replacement parts specified by the manufacturer or those that have the same characteristics as the original part. Unauthorized substitutions may result in fire, electric shock or other hazards.
  21. Upon completion of any service or repairs to this unit, ask the service technician to perform safety checks to determine that the unit is in proper operating condition.

# Important Safety Instructions

22. When you connect the product to other equipment, turn off the power and unplug all of the equipment from the wall outlet. Failure to do so may cause an electric shock and serious personal injury. Read the owner's manual of the other equipment carefully and follow the instructions when making any connections.
23. Sudden high volume sound may cause hearing or speaker damage. When you use headphones, (if the unit is equipped with a headphone jack) keep the volume at a moderate level. If you use headphones continuously with high volume sound, it may cause hearing damage.

## CONDENSATION:

Moisture will form in the operating section of the unit if the unit is brought from cool surroundings into a warm room or if the temperature of the room rises suddenly. When this happens, unit's performance will be impaired. To prevent this, let the unit stand in its new surroundings for about an hour before switching it on, or make sure that the room temperature rises gradually.

Condensation may also form during the summer if the unit is exposed to the breeze from an air conditioner. In such cases, change the location of the unit.

## HOW TO HANDLE THE LCD PANEL:

- Do not press hard or jolt the LCD panel. It may cause the LCD panel glass to break and injury may occur.
- If the LCD panel is broken, make absolutely sure that you do not touch the liquid in the panel. This may cause skin inflammation.

If the liquid gets in your mouth, immediately gargle and consult with your doctor. Also, if the liquid gets in your eyes or touches your skin, consult with your doctor after rinsing for at least 15 minutes or longer in clean water.

## Possible Adverse Effects on LCD Panel:

If a fixed (non-moving) pattern remains on the LCD Panel for long periods of time, the image can become permanently engrained in the LCD Panel and cause subtle but permanent ghost images. This type of damage is NOT COVERED BY YOUR WARRANTY. Never leave your LCD Panel on for long periods of time while it is displaying the following formats or images:

- Fixed Images, such as stock tickers, video game patterns, TV station logos, and websites.
- Special Formats that do not use the entire screen. For example, viewing letterbox style (16:9) media on a normal (4:3) display (black bars at top and bottom of screen); or viewing normal style (4:3) media on a widescreen (16:9) display (black bars on left and right sides of screen).

**The following symptoms are not signs of malfunction but technical limitation. Therefore we disclaim any responsibility for these symptoms.**

- LCD Panels are manufactured using an extremely high level of precision technology, however sometimes parts of the screen may be missing picture elements or have luminous spots.

This is not a sign of a malfunction.

- Do not install the LCD Panel near electronic equipment that produces electromagnetic waves. Some equipment placed too near this unit may cause interference.
- Effect on infrared devices - There may be interference while using infrared devices such as infrared cordless headphones.

## Declaration of Conformity

This device complies with part 15 of the FCC Rules. Operation is subject to the following two conditions:

- (1) This device may not cause harmful interference and
- (2) This device must accept any interference received, including interference that may cause undesired operation.

## End of life directives

Your TV also contains material that can be recycled and reused. For disposal or recycling information, contact your local authorities or the Electronic Industries Alliance at [www.eia.org](http://www.eia.org) to find a recycler in your area.

## Non-active pixels

The LCD panel contains almost 3 million thin film transistors, which provide exceptionally sharp video quality. Occasionally, a few non-active pixels may appear on the screen as a fixed black (in the case of a dead pixel), blue, green, or red point. These non-active pixels do not adversely affect the performance of your TV, and are not considered defects.

## Power source

### TO USE AC POWER

1. The power cord is attached to the TV at the factory.
2. Connect the AC cord into an AC outlet.

### ⚠ WARNING

Do not connect this unit to the power using any device other than the supplied AC cord. This could cause fire, electrical shock, or damage.

Do not use with a voltage other than the power voltage specified. This could cause fire, electrical shock, or damage.

### ⚠ CAUTION

When this unit is not used for a long time, (e.g., away on a trip) in the interest of safety, be sure to unplug it from the AC outlet.

Do not plug/unplug the AC cord when your hands are wet. This may cause electrical shock.

# Notices de sécurité importantes



**MISE EN GARDE**  
**RISQUE DE CHOC ÉLECTRIQUE**  
**NE PAS OUVRIR**



**ATTENTION:** AFIN DE RÉDUIRE LE RISQUE DE CHOC ÉLECTRIQUE, NE PAS ENLEVER LE COUVERCLE (OU LE DOS). CET APPAREIL NE CONTIENT AUCUNE PIÈCE RÉPARABLE PAR L'UTILISATEUR. FAIRE APPEL À UN TECHNICIEN QUALIFIÉ.



L'éclair avec symbole de flèche dans un triangle équilatéral avise l'utilisateur de la présence d'une tension dangereuse non isolée dans le boîtier du produit et qui peut être d'intensité suffisante pour présenter un risque de choc électrique.



Le point d'exclamation dans un triangle équilatéral avise l'utilisateur de la présence de directives d'utilisation et d'entretien (service) importantes dans la documentation qui accompagne l'appareil.

1. Lisez les instructions.
2. Conservez les instructions.
3. Respectez tous les avertissements.
4. Suivez toutes les directives.
5. N'utilisez pas cet appareil près de l'eau.
6. Ne le nettoyez qu'avec un linge sec.
7. Ne bloquez pas les événements. Effectuez l'installation conformément aux directives du fabricant.
8. Ne l'installez pas près d'une source de chaleur comme un radiateur, un registre, une cuisinière ou autre (y compris un amplificateur) produisant de la chaleur.
9. N'enlevez pas le dispositif de sécurité de la fiche polarisée ou avec mise à la terre. Une fiche polarisée comporte deux lamelles dont une est plus large que l'autre. Une fiche avec mise à la terre comporte deux lamelles et une broche de terre. La lamelle large et la broche de terre sont fournies pour votre sécurité. Si la fiche ne convient pas à la prise de courant, consultez un électricien et faites remplacer la prise de courant.
10. Placez le cordon d'alimentation de façon à ce qu'il ne soit pas écrasé ou pincé surtout au niveau de la fiche, des prises et au point de sortie de l'appareil.
11. N'utilisez que des périphériques/ accessoires spécifiés par le fabricant.
12. Ne l'utilisez qu'avec un chariot, un trépied, un support ou une table spécifiée par le fabricant ou vendue avec l'appareil. Si vous utilisez un chariot, soyez prudent quand vous le déplacez afin d'éviter que l'ensemble chariot/téléviseur culbute.
13. Débranchez l'appareil lors d'un orage électrique ou s'il n'est pas utilisé pendant une période prolongée.
14. Confiez le service à une personne qualifiée. Un service est requis si l'appareil est endommagé d'une façon quelconque (cordon d'alimentation ou fiche endommagée, liquide renversé ou objet échappé dans l'appareil, appareil exposé à la pluie ou à l'humidité, mauvais fonctionnement ou appareil échappé).
15. L'appareil ne devrait pas être exposé aux éclaboussures. Ne placez jamais d'objets remplis de liquide (comme un vase) sur l'appareil.
16. Une antenne extérieure ne devrait pas être située à proximité des lignes haute tension, d'un éclairage



S3125A

- électrique ou d'autres circuits électriques, ni là où elle pourrait s'écraser contre des lignes ou circuits électriques. Lors de l'installation d'une antenne extérieure, il faut prendre les mesures nécessaires pour éviter de toucher les lignes ou circuits électriques car un tel contact pourrait être mortel.
17. Ne surchargez pas les prises murales ni les rallonges car cela présente un risque d'incendie ou de choc électrique.
  18. N'insérez aucun objet dans les ouvertures de l'appareil car vous pourriez toucher un point de tension dangereuse ou court-circuiter une pièce résultant en un incendie ou un choc électrique. Ne renversez ni ne pulvérisez aucun liquide dans l'appareil.

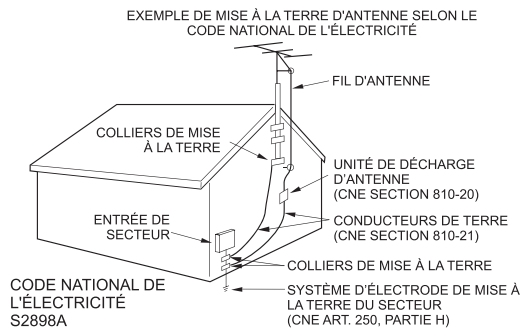

19. Si une antenne ou un système de câble extérieur est branché à l'appareil, assurez-vous que l'antenne ou le système est relié à la terre afin de protéger contre la surtension ou les décharges électrostatiques. La section 810 du Code national de l'électricité, ANSI/NFPA 70, renseigne sur la mise à la terre appropriée du mât et de la structure de soutien, la mise à la terre du fil conducteur à une unité de décharge d'antenne, la taille des conducteurs de terre, l'emplacement de l'unité de décharge d'antenne, la connexion aux électrodes de terre et les exigences concernant l'électrode de terre.
20. Si des pièces de rechange sont requises, assurez-vous que le technicien n'utilise que les pièces spécifiées par le fabricant ou ayant les mêmes caractéristiques que les pièces originales. Toute substitution non autorisée peut présenter un risque d'incendie, de choc électrique ou autre.
21. Une fois l'entretien ou la réparation terminée, demandez au technicien d'effectuer une vérification de sécurité afin d'établir si l'appareil fonctionne correctement.

## Notices de sécurité importantes

22. Si vous connectez le produit à un autre appareil, éteignez-le et débranchez-le de la prise de courant. Autrement vous risquez un choc électrique ou des blessures graves. Lisez le manuel de l'utilisateur de l'autre appareil et suivez les directives de connexion.
23. Un son soudain d'intensité élevée peut endommager l'ouïe ou les haut-parleurs. Si vous utilisez des écouteurs (appareil doté d'une prise d'écouteurs), tenez l'intensité sonore à un niveau moyen. L'utilisation continue d'écouteurs à intensité sonore élevée peut endommager l'ouïe.

### CONDENSATION:

De l'humidité peut se former dans la partie fonctionnelle de l'appareil si celui-ci passe d'un endroit frais à un endroit chaud ou si la température de la pièce s'élève subitement. Dans pareil cas, le rendement de l'appareil peut diminuer. Pour éviter une telle situation, laissez l'appareil s'ajuster au niveau milieu pendant une heure environ avant de le mettre en circuit. Encore, assurez-vous que la température de la pièce s'élève graduellement.

Une condensation peut aussi se former en été si l'appareil est exposé au courant d'air d'un climatiseur. Dans pareil cas, changez l'emplacement de l'appareil.

### MANIPULATION DU PANNEAU ACL:

- N'appuyez pas fort sur l'ACL et ne le secouez pas. Vous risqueriez de briser le verre de l'ACL et de vous blesser.
- Si l'ACL est brisé, assurez-vous de ne pas toucher le liquide dans le panneau. Le liquide peut irriter la peau. Si vous avalez du liquide, gargarisez-vous immédiatement et consultez un médecin. Si le liquide entre en contact avec les yeux ou la peau, rincez-les pendant au moins 15 minutes à l'eau claire et consultez un médecin.

### Effets nocifs possibles de l'écran ACL:

Si un motif fixe reste à l'écran pendant une longue durée, l'image peut devenir imprégnée en permanence sur l'écran ACL et former une image fantôme subtile mais permanente. Ce type de dommage n'est PAS COUVERT PAR LA GARANTIE. Ne laissez jamais l'écran ACL allumé pendant une longue durée quand il affiche des images des types suivants:

- images fixes comme les résultats de la Bourse, les motifs de jeu vidéo, les logos de stations de télévision et les sites Web;
- les formats spéciaux qui ne couvrent pas l'écran entier (format boîte aux lettres [16:9] sur écran normal [4:3] (barres noires dans le haut et le bas) ou vue normale [4:3] sur grand écran [16:9] (barres noires sur la gauche et la droite)).

**Les signes suivants ne proviennent pas d'un mauvais fonctionnement mais d'une limite technique. Nous ne pouvons donc pas être tenus responsables de tels signes.**

- Les écrans ACL sont fabriqués avec un niveau extrêmement élevé de précision mais certaines parties de l'écran peuvent ne pas avoir d'éléments d'image ou présenter des points lumineux.  
Il ne s'agit pas d'un mauvais fonctionnement
- N'installez pas l'écran ACL près d'un équipement électronique qui génère des ondes électromagnétiques car cela pourrait causer une interférence.
- Effet sur les appareils à infrarouge – il peut y avoir interférence quand on utilise un appareil à infrarouges comme un téléphone sans fil à infrarouges.

### Énoncé de conformité

Cet appareil est conforme à la section 15 des règlements de la FCC. Le fonctionnement est régi par deux conditions : (1) l'appareil ne peut pas causer d'interférence nuisible et (2) l'appareil doit accepter toute interférence reçue, y compris une interférence qui peut entraîner un fonctionnement indésirable.

### Directives de fin de vie

Votre téléviseur contient des matériaux qui peuvent être recyclés et réutilisés. Pour l'élimination ou le recyclage, contactez les autorités locales ou l'Association du Recyclage des Produits Electronique au <http://www.eprassociation.ca> pour trouver un centre de recyclage dans votre région.

### Pixels inactives

L'écran ACL compte près de 3 millions de transistors en couches minces fournissant une qualité d'image extrêmement élevée. À l'occasion, des pixels inactifs peuvent apparaître à l'écran sous forme de point fixe noir (pixel mort), bleu, vert ou rouge. Ces pixels inactifs ne nuisent pas au rendement de votre téléviseur et ne sont pas considérés un vice.

### Alimentation électrique

#### SECTEUR

1. Le cordon d'alimentation est branché au téléviseur à l'usine.
2. Branchez le cordon dans une prise de courant.

#### ⚠ AVERTISSEMENT

Ne branchez pas l'appareil à l'aide d'un dispositif autre que le cordon fourni car cela présenterait un risque d'incendie, de choc électrique ou de dommage. N'utilisez pas une tension autre que celle spécifiée pour l'appareil car cela présenterait un risque d'incendie, de choc électrique ou de dommage.

#### ⚠ MISE EN GARDE

Pour des raisons de sécurité, débranchez l'appareil de la prise de courant si vous prévoyez ne pas l'utiliser pendant une période prolongée (ex. : voyage). Ne branchez/débranchez pas le cordon d'alimentation si vous avez les mains mouillées car cela pourrait provoquer un choc électrique.

# Important Safety Instructions

## When Installing the TV Against a Wall or Enclosed Area

Make sure that your TV has adequate air circulation. Allow enough space around the TV as shown below. Avoid operating the TV at temperatures below Inadequate air 41°F (5°C).

### Install with stand

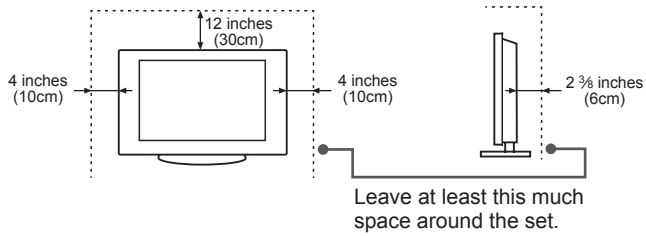

### Install on the wall

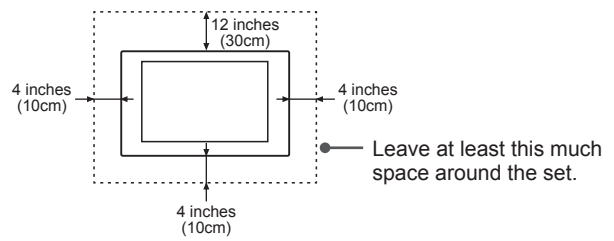

### Never install the TV set as follows:

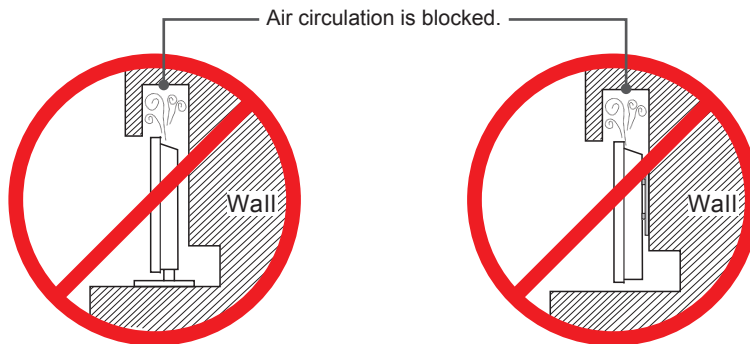

**Inadequate air circulation can lead to overheating of the TV and may cause damage to your TV or cause a fire.**



# Contents

## Getting Started

Viewing the Remote Control.....	3
Pairing the Remote.....	4
Installing Batteries in the Remote Control .....	4
Making Connections.....	5
Turning the TV on or off.....	11
Changing Channels / Volume.....	11
Turning the TV On for the First Time .....	11

## Settings

Accessing the Main Menu .....	12
Setting up channels.....	13
Network .....	13
Parental Control.....	14
Viewing the E-manual.....	15
DLNA Settings .....	15
Media Share Settings in Computer.....	16

## Advanced Features

Accessing Home Menu.....	17
Home Screen.....	17
Voice Search .....	17
HiMedia .....	18
HiBeam.....	18

## Other Information

Trouble Shooting .....	19
------------------------	----

***Illustrations are for your reference only!***

# Getting Started

## Viewing the Remote Control

### Keys on the front of the remote control

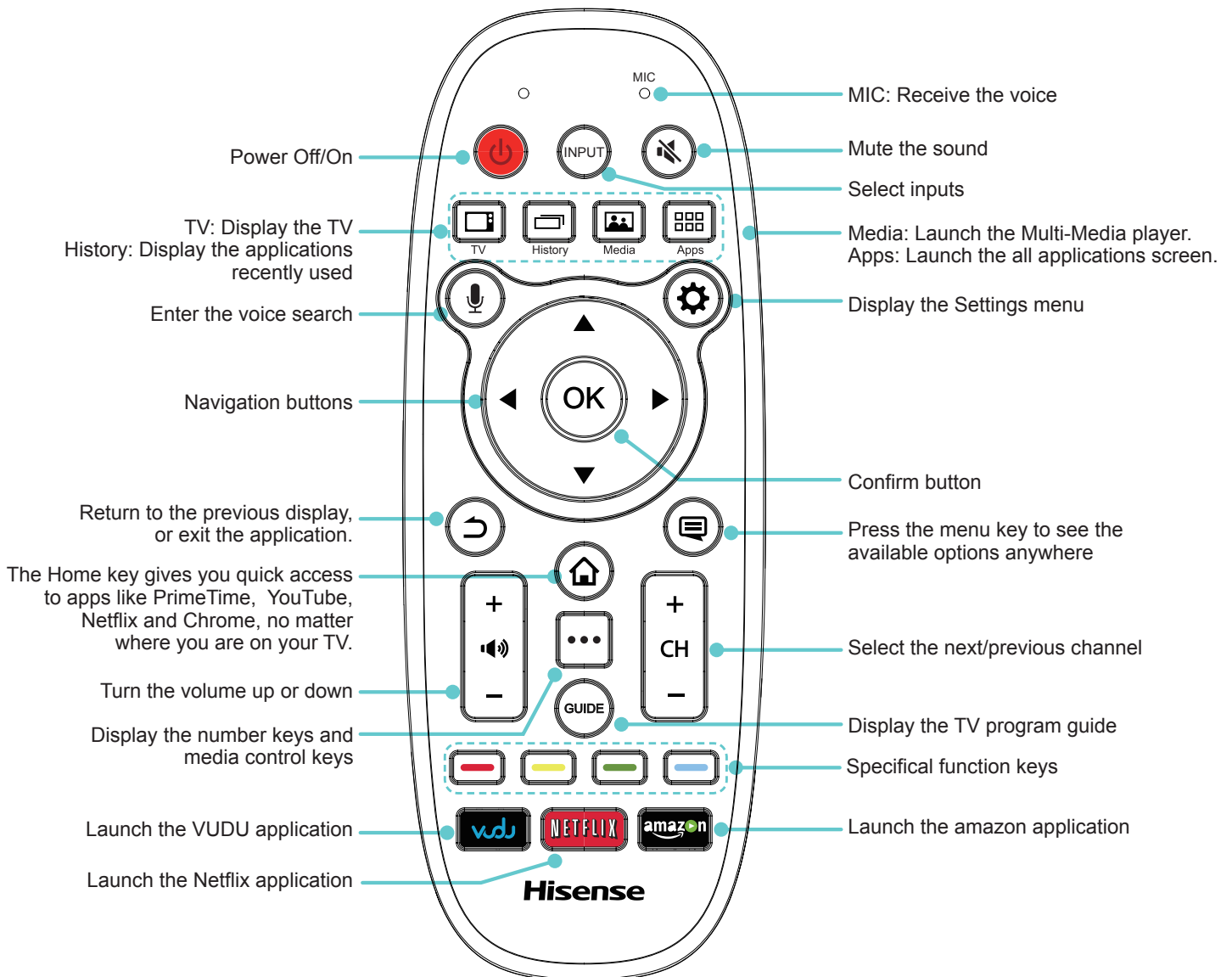

### LED indicator

- The LED on the remote control will blink with each button press.
- In pairing mode, the red LED will light continuously for ~60-seconds.
- When pairing is complete, the blue LED will flash three times.
- The LED light will blink continuously when the battery is low.
- The remote control will automatically go into sleep mode thirty seconds after the last button press. Sleep Mode can conserve battery life. Any movement or button press will immediately wake up the remote.

# Getting Started

## Installing Batteries in the Remote Control

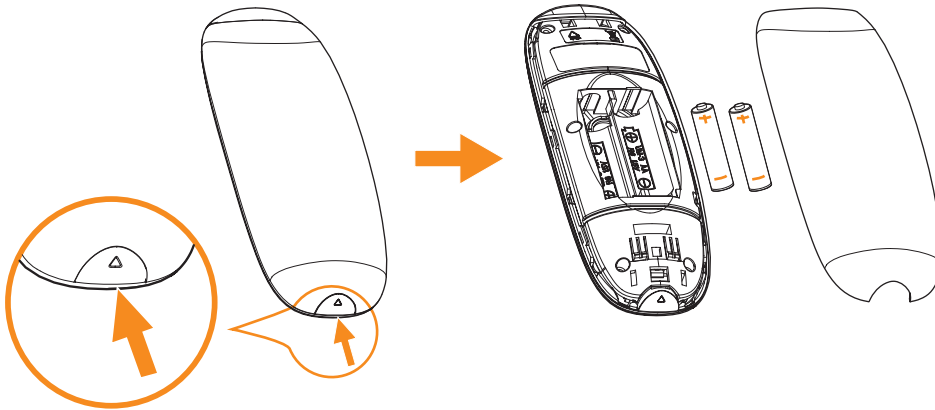

Insert batteries into the remote control as shown.

1. To open the battery cover, push the latch in the direction of the Arrow and lift off the cover.
2. Insert two AA size batteries. Make sure to match the (+) and (-) ends of the batteries with the (+) and (-) ends indicated in the battery compartment.
3. Close the battery cover.

### NOTE

The batteries shall not be exposed to excessive heat such as sunshine, fire or the like.

## Pairing the Remote

The air mouse and microphone functions are available after the remote control is paired.

### ● The First Method

The Setup Wizard menu appears the first time you turn on the TV. Step of the remote pairing, press and hold down the [Red] and [OK] buttons simultaneously until the red LED turns on. When the red LED lights, release the buttons and wait for the TV to pair with the remote. The blue LED on the remote control will flash three times when the pairing is successfully completed.

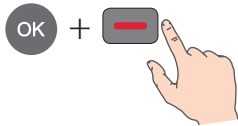

### ● The Second Method

1. Enter **Settings > Bluetooth** to turn on **Bluetooth**.
2. Press and hold the [Red] button and [OK] button for three seconds simultaneously.
3. Select **Find nearby devices** to search the remote control, and the remote control will appear in available devices, then press [▲/▼] button to select the Hisense Vision Remote Control and press [OK] to pair.

## Using the Air Mouse and Voice Input

The remote control supports air mouse and voice input (requires remote control pairing).

Shake the remote control to turn on air mouse function, and press the direction key to turn off the function.

Press the Voice key to start Google Voice Search. You can input voice via the microphone of the remote control.

# Getting Started

## Making Connections

### NOTES

- Check the jacks for position and type before making any connections. Loose connections can result in image or color problems. Make sure that all connections are tight and secure.
- Not all A/V devices have the ability to connect to a TV, please refer to the user manual of your A/V device for compatibility and connection procedure.
- Always unplug the power cord when connecting external equipment.

### Connecting an antenna, cable or cable/satellite box

1. Turn off the TV before connecting the antenna.
2. Connect one end of a coaxial cable (not included) to the RF OUT jack on the antenna, cable or cable/satellite box. If you are using an antenna with twin-lead cable, you may need a 300-75 ohm adapter (not provided) to connect it to the back of your TV. Likewise, if you are using several antennas, you may need a combiner (not provided).
3. Connect the other end of the cable to the ANT/CABLE jack on the side of your TV.

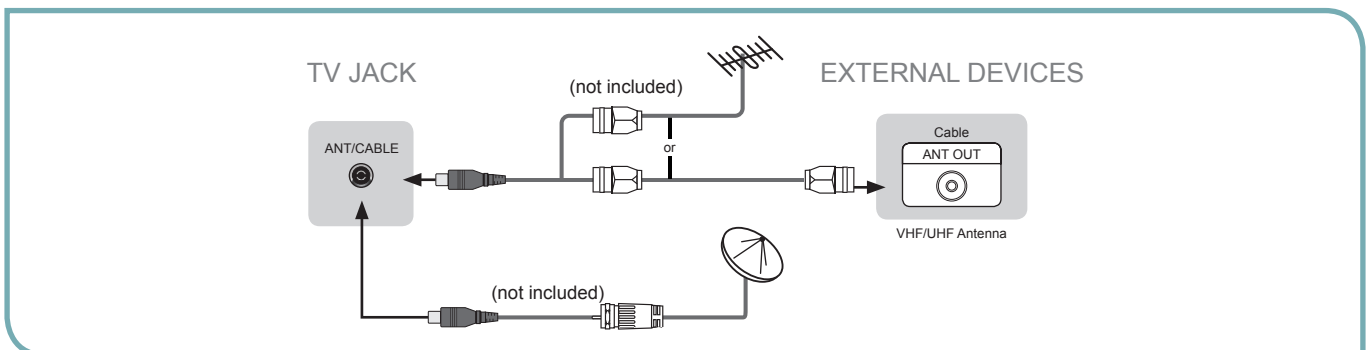

### Connecting an A/V Device with Composite Cable

1. Use the audio and video cables to connect the external A/V device's composite video/audio jacks to the TV's jacks. (Video = yellow, Audio Left = white, and Audio Right = red)
2. Plug the connected devices into the mains socket before switching on the TV.
3. Select the corresponding source on the TV using the INPUT button.

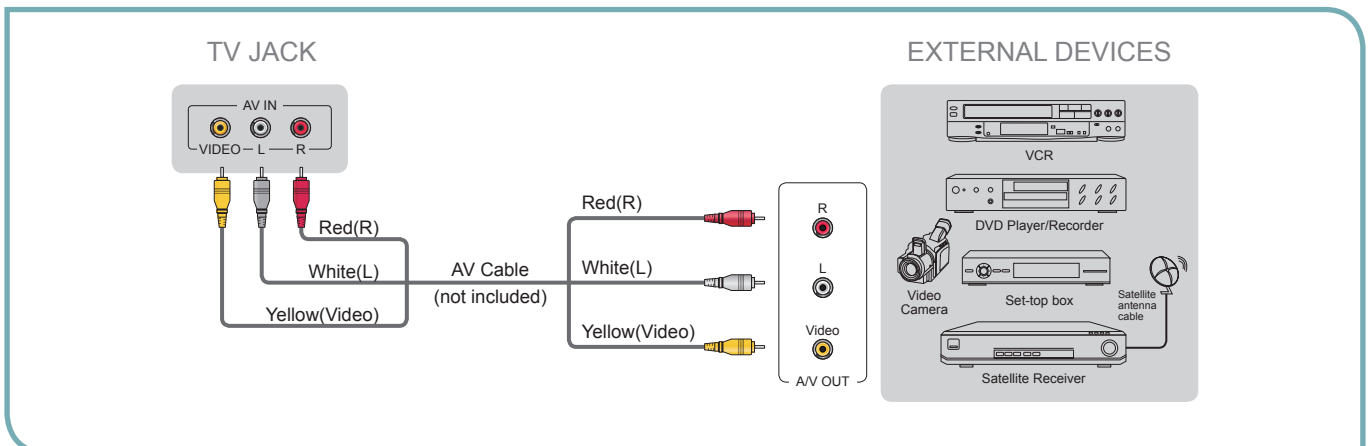

### NOTE

One AV device can be connected to the TV using either composite or component cable.

# Getting Started

## Connecting an A/V Device with Component (YP<sub>B</sub>P<sub>R</sub>) Cable

1. Use a component cable to connect the external A/V device's component output jacks to the TV's YP<sub>B</sub>P<sub>R</sub> jacks. Use an audio cable to connect the external A/V device's component audio jacks to the TV's AUDIO (L/R) jacks.
2. Plug the connected devices into the mains socket before switching on the TV.
3. Select the corresponding source on the TV using the INPUT button.

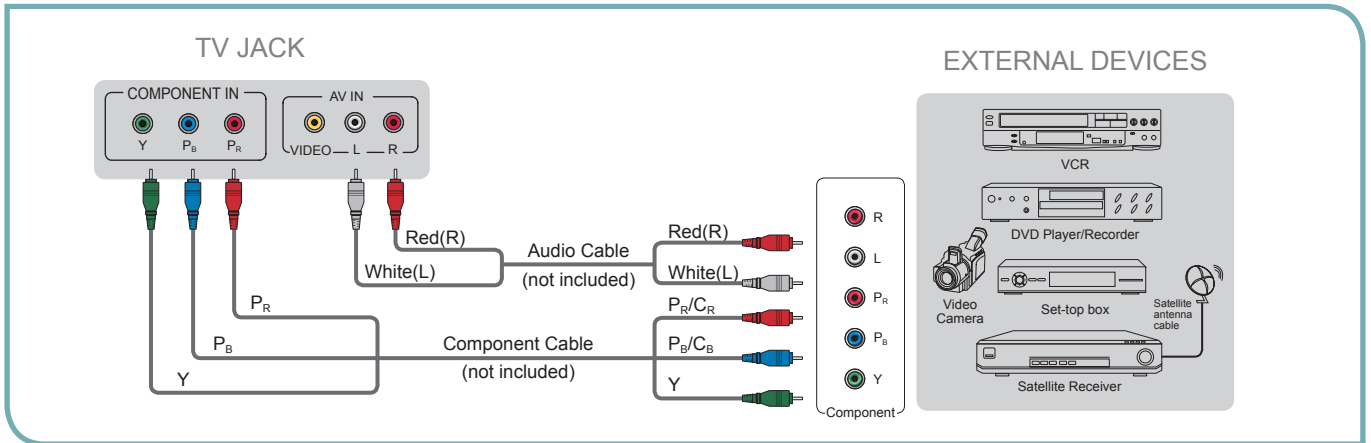

### NOTE

One AV device can be connected to the TV using a component or composite cable.

## Connecting an A/V Device with HDMI Cable

- Supports digital connections between HDMI - enabled AV devices such as PVR, DVD, Blu-Ray, AV receiver and digital devices.
  - Some devices such as PVR or DVD player require HDMI signal to be set to output in the device's settings.
  - Please consult your device user manual for instructions.
1. Use an HDMI cable to connect the A/V device's HDMI output jack to the TV's HDMI jack.
  2. Plug the connected devices into the mains socket before switching on the TV .
  3. Select the corresponding source on the TV using the INPUT button.

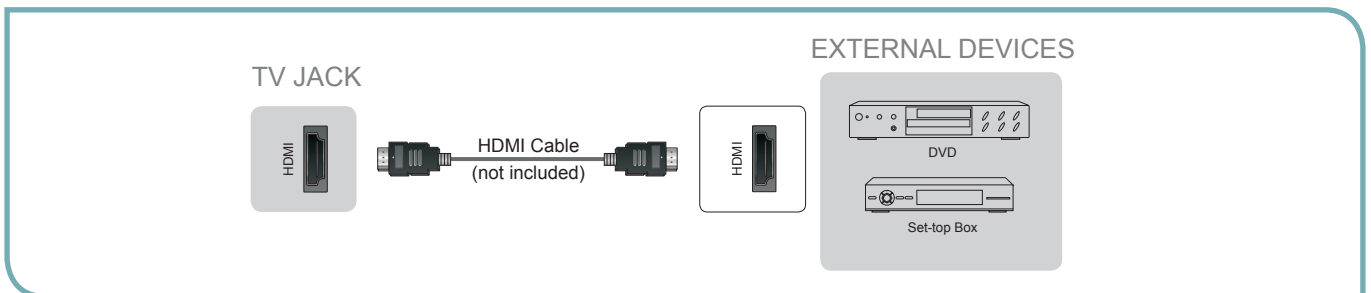

### NOTE

The HDMI connector provides both video and audio signals, it's not necessary to connect an audio cable.

## Connecting a headphone

Headphones or an analog sound bar can be connected to the  /AUDIO OUT jack on your set. (While the headphone is connected, the sound from the built-in speakers will be disabled.)

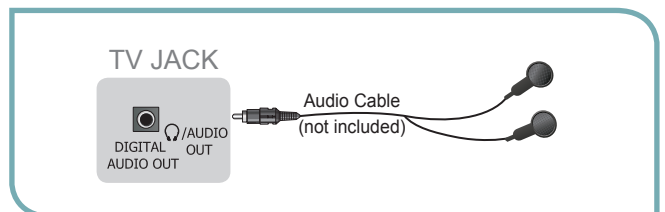

# Getting Started

## ❏ Connecting a PC with VGA Cable

1. Use a VGA cable to connect the PC's VGA output jack to the TV's VGA jack. Use an audio cable to connect the PC's audio output jack to TV's PC/DVI AUDIO IN jack.
2. Plug the connected devices into the mains socket before switching on the TV.
3. Select the corresponding source on the TV using the INPUT button.

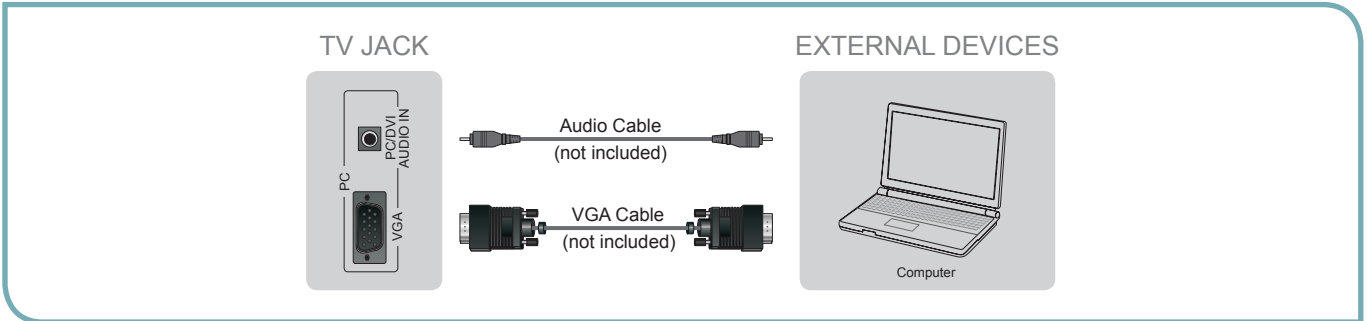

### ✔ NOTES

- Primarily this unit is intended for use as an LCD TV. If you want to use it as a monitor, please contact the manufacturer of the PC Video/Graphic's card for further support. Perfect compatibility is not guaranteed.
- The VGA cable is not supplied with the product.
- We recommend the use of a VGA cable with 2 ferrite cores as shown in the diagram.

## ❏ Connecting an Audio Receiver with a digital Audio cable

1. Use an audio cable to connect the A/V device's digital audio in jack to the TV's DIGITAL AUDIO OUT jack. Or use an RCA Y-cable (1/8"-stereo mini to L/R phono - not provided) to connect analog sound system to the TV's AUDIO OUT jack.
2. Plug the connected devices into the mains socket before switching on the TV.
3. Select the corresponding source on the audio receiver.

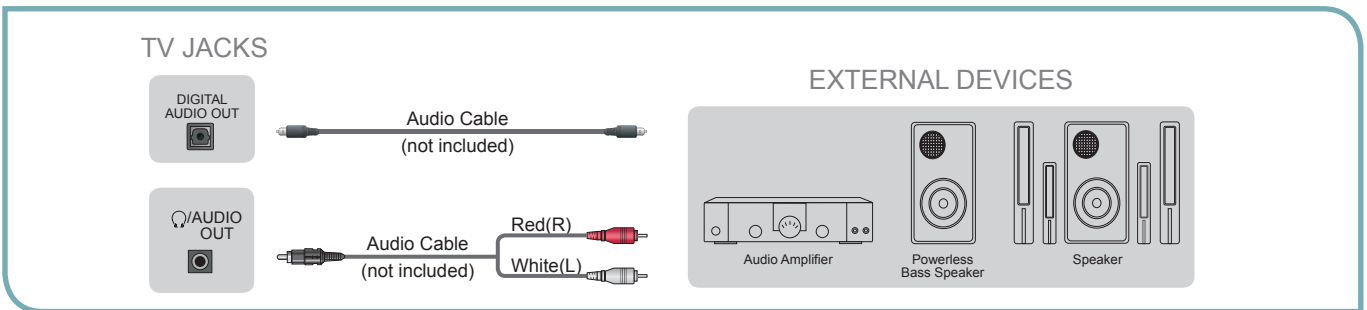

### ✔ NOTES

- When a digital audio system is connected to the DIGITAL AUDIO OUT jack, decrease the volume of both the TV and the system.
- 5.1 CH (channel) audio is available when the TV is connected to an external device supporting 5.1 CH.
- When the receiver (home theater) is set to on, you can hear sound output from the TV's digital audio out jack. When the TV is receiving a DTV signal, the TV will send 5.1 CH sound to the home theater receiver. When the source is connected to the TV via HDMI, only 2 CH audio will be heard from the home theater receiver. If you want to hear 5.1 CH audio, connect the digital audio out jack from your DVD/Blu-ray player/cable box/STB satellite receiver directly to an amplifier or home theater.
- Settings > Sound > Digital sound output must be set to either PCM or Dolby digital.

# Getting Started

## Connecting to a Wired Network

You can attach your TV to your LAN by one of the three following ways:

- You can attach your TV to your LAN by connecting the LAN port on the back of your TV to an external modem using a Cat 5 LAN cable. See the diagram below.

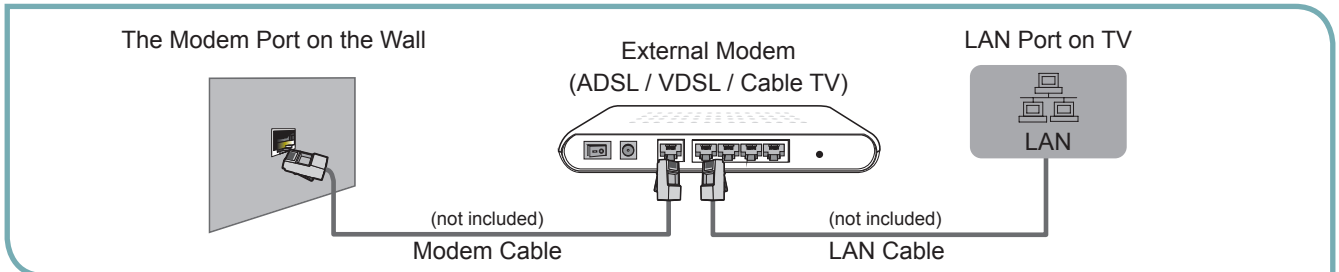

- You can attach your TV to your LAN by connecting the LAN port on the back of your TV to an IP Sharer which is connected to an external modem. Use LAN cable for the connection. See the diagram below.

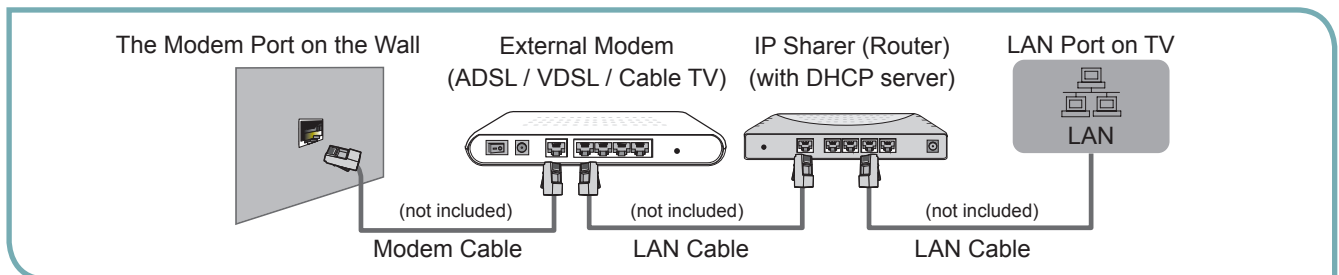

- Depending on how your network is configured, you may be able to attach your TV to your LAN by connecting the LAN port on the back of your TV directly to a network wall outlet with a Cat 5 cable. See the diagram below. Note that the wall outlet is attached to a modem or router elsewhere in your house.

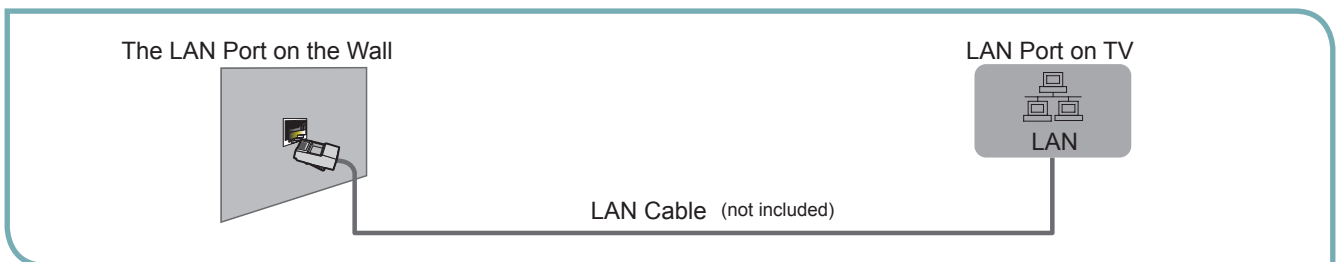

If you have a Dynamic Network, you should use an ADSL modem or router that supports Dynamic Host Configuration Protocol (DHCP). Modems and routers that support DHCP automatically provide the IP address, subnet mask, gateway, and DNS, so you don't have to enter them manually. Most home networks are Dynamic Networks.

Some networks require a Static IP address. If your network requires a Static IP address, you must enter the IP address, subnet mask, gateway, and DNS values manually on your TV's Cable Setup Screen when you set up the network connection. To get the IP address, subnet mask, gateway, and DNS values, contact your Internet Service Provider (ISP).

If you have a Windows computer, you can also get these values through your computer.

### NOTE

You can use ADSL modems that support DHCP if your network requires a Static IP address. ADSL modems that support DHCP also let you use Static IP addresses.

# Getting Started

## Connecting to a Wireless Network

To connect your TV to your network wirelessly, you need a wireless router or modem. See the illustration below.

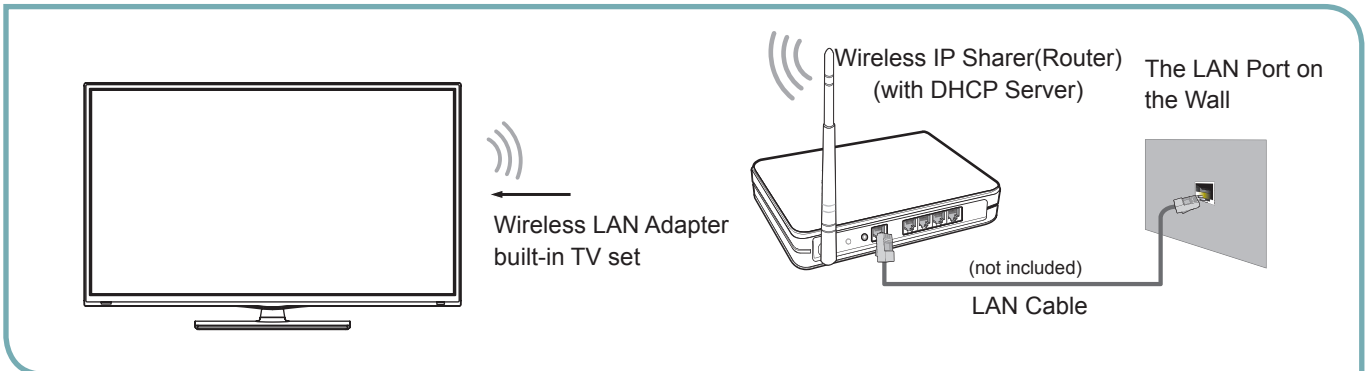

Hisense's built-in Wireless LAN Adapter supports the IEEE 802.11 b/g/n communication protocols. Hisense recommends using IEEE 802.11n router. When you play video over a IEEE 802.11b/g connection, the video may not play smoothly.

### NOTES

- You must use the Hisense's built-in Wireless LAN Adapter to use a wireless network, the set doesn't support external USB network adapter.
- To use a wireless network, your TV must be connected to a wireless IP sharer. If the wireless IP sharer supports DHCP, your TV can use a DHCP or static IP address to connect to the wireless network.
- Select a channel for the wireless IP sharer that is not currently being used. If the channel set for the wireless IP sharer is currently being used by another device nearby, this will result in interference and communication failure.
- If you apply a security system other than the systems listed below, it will not work with the TV.
- If Pure High-throughput (Greenfield) 802.11N mode is selected and the Encryption type is set to WEP, TKIP or TKIP-AES (WPS2 Mixed) for your Access Point (AP), Hisense TVs will not support a connection in compliance with these Wi-Fi certification specifications.
- If your AP supports WPS (Wi-Fi Protected Setup), you can connect to the network via PBC (Push Button Configuration) or PIN (Personal Identification Number). WPS will automatically configure the SSID and WPA key in either mode.

## Wireless Display

If your phone, PAD with Wireless Display function can be achieved wireless connection with the TV.

1. Set the Wireless Display function on your phone or PAD is available.
2. Share your phone or PAD's display.

## To control the other devices

You can control connected devices with the TV remote control without using a remote control of each individual device.

You can use CEC function or connect an IR Blaster to do this. We recommend the IR Blaster. CEC function requires that your device is compatible with HDMI Consumer Electronic Control (CEC).

### CEC

1. Connect the TV to the HDMI CEC - compatible devices.
2. Set the CEC function of the Connected device (please refer to the device's User Guide for instructions).



# Getting Started

3. Press  button, go to **Settings > Local Settings > HDMI settings** to configure the HDMI CEC function.

**Control for HDMI:** Allow the TV to control compatible HDMI devices.

**Device auto power off:** When HDMI CEC is enabled, this function turns off HDMI CEC devices when you turn off your TV.

**TV auto power on:** When HDMI CEC is enabled and you turn on an HDMI CEC device, this function turns on your TV automatically.

**System Audio control:** Control the volume of the AV receiver with the volume key of TV remote control.

**Device list:** Display a list of HDMI CEC devices that are connected to your TV.

## NOTES

- HDMI cables must be used to connect HDMI CEC - compatible devices to your TV.
- The connected device's HDMI CEC feature must be turned on.
- If you connect an HDMI device that is not HDMI CEC - compatible, none of the HDMI CEC Control features will work.
- Depending on the connected HDMI device, the HDMI CEC Control feature may not work.
- After choosing control for HDMI, you may select device auto power off and/or TV auto power on and/or system audio control.

## IR Blaster

You can connect an IR Blaster to control many popular video input devices, AV receivers and audio amplifiers.

### - To control video input

1. Connect the IR Blaster to the TV via the rear panel connector and place it properly on the device to be controlled.
2. Press  button, go to **Settings > Video input**.
3. Enter **Video input** option, Select **Add device manually**, then follow the on-screen instructions.
4. When the setup is finished, press [INPUT] button to display the **Select Device** menu, Use the [**▲/▼**] button to select your add device, press [OK] button to set live TV.
5. Then, you can control the connected device with the remote control of the TV.

### - To control audio amplifier

1. Connect an IR Blaster to the TV and place it properly on the AV receiver.
2. Press  button, go to **Settings > Local settings > AVR**
3. Select **AV Receiver setting**, then follow the on-screen instructions.
3. Then, you can set the IR Blaster to control your audio amplifier.

## NOTE

Two or more video input devices or two or more audio amplifiers/AVRs cannot be controlled simultaneously with IR Blaster. If you want to control a video input device and an audio amplifier/AVR simultaneously, please place the two devices close to each other. or purchase on IR Blaster cable with multiple emitters.

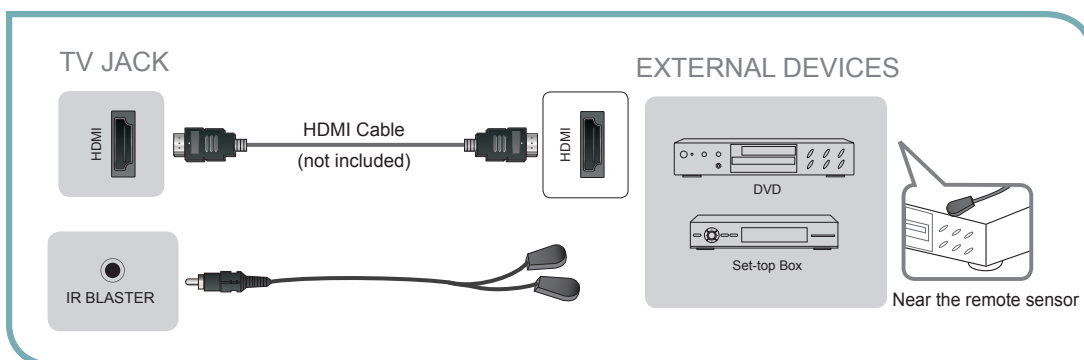



# Getting Started

## Turning the TV on or off

**IMPORTANT:** If you have not yet paired the remote to the TV, please refer to the section titled **Pairing the Remote in this manual.**

To turn your TV on or off (standby mode):

1. Plug the power cord into an AC power outlet.
2. Press  button, your TV turns on.
3. Press  button again to turn off your TV. When you turn off your TV, it goes into standby mode.

### NOTES

- When your TV is in standby mode, it is still receiving power. To completely disconnect power, unplug the power cord.
- It may take 15-20 seconds for the TV to be ready after pressing the power button.

## Changing Channels / Volume

1. Press the [CH +/-] button on the TV/remote control to change the channel.
2. Press the [VOL +/-] button on the TV/remote control to adjust the volume.
3. Press the [...] button to display numeric menu, then select digit channel number to display the corresponding channels.

### NOTE

- [CH +/-] button can be used in ANT/CABLE mode only.

## Turning the TV On for the First Time

The Setup Wizard menu appears the first time you turn on the TV. The wizard will guide you step-by-step through the initial setup and configuration of your television.

**IMPORTANT:** Make sure that the antenna or cable is connected and a wired or wireless Internet connection is available.

1. Make sure that you have:
  - Installed the remote control batteries.
  - Connected an antenna, cable or CATV/SAT set-top-box PVR.
  - Connected the power cord.
2. Press [POWER ] button to turn on your TV.
3. The **Setup Wizard** menu displays. Follow Step 1 through 11 in the Setup Wizard menu procedure.

## Setup Wizard

Follow the on-screen instructions to customize your TV settings according to your preferences.

Step 1

Select menu language

Selecting menu language.

Step 2

Pairing remote controller

Pairing the remote control.

Step 3

Legal notice

Hisense legal information.

Step 4

Connect to the Internet

Connecting to the Internet via Ethernet cable or WiFi.

Step 5

DLNA setting

Connecting to the DLNA device.

Step 6

Select usage patterns

Selecting Home or Retail.

Step 7

Google Account

Signing in with your Google Account.

Step 8

Help make Google TV better

Check the TV to send the usage statistics and crash reports to Google automatically.

Step 9

Enter ZIP code

Enter ZIP code so that you receive accurate programming information.

Step 10

Set up TV service

Select the video input you use to connect your TV service to your TV.

Step 11

Set up AV Receiver control

Select your Audio amplifier manufacturer. To control your receiver, connect the IR blaster.

That's it!

The initial settings are completed.

# Settings

## Accessing the Main Menu

You can change various settings for your TV from the Settings menu.

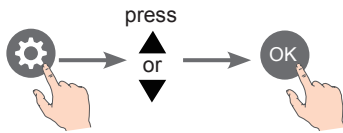

You can also access the Settings menu from the menu that appears when the Home menu is displayed.

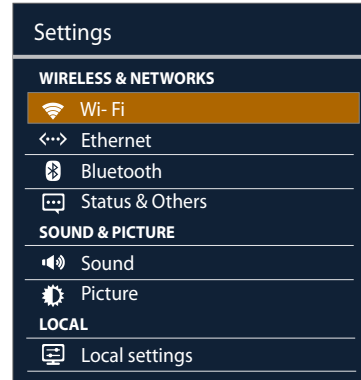
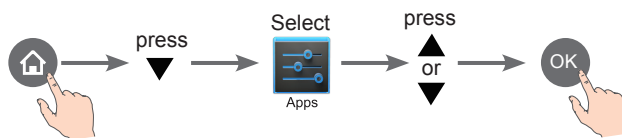

You will be able to review or update the TV settings including:

<b>Item</b>	<b>Description</b>
<b>WIRELESS &amp; NETWORKS</b>	Manage internet and Bluetooth connections.
<b>Wi-Fi</b>	Wireless network setup.
<b>Ethernet</b>	Wired network setup.
<b>Bluetooth</b>	Manage Bluetooth connection.
<b>Status &amp; Others</b>	Status of network applications and other functions.
<b>SOUND &amp; DISPLAY</b>	Adjust the Sound and Picture.
<b>Sound</b>	Adjust sound.
<b>Picture</b>	Adjust the picture.
<b>CHANNEL MANAGEMENT</b>	Set up and edit channels.
<b>Channel</b>	Channel manager.
<b>LOCAL</b>	Manage system settings.
<b>Local settings</b>	Manage HDMI settings, IR blaster settings, power-on settings, etc.
<b>Video Input</b>	Set up TV service provider.
<b>Storage</b>	Unmount USB storage, view available storage.
<b>FTP server</b>	External access via FTP.
<b>Apps</b>	Manage applications and development options.
<b>PERSONAL</b>	Manage system personal settings.
<b>Security</b>	Manage system security.
<b>Language &amp; input</b>	Manage system language, input devices, IP remotes.
<b>Backup &amp; reset</b>	Backup app data or erase all data on TV.
<b>Privacy &amp; safety</b>	Manage privacy, safety and lock settings.
<b>ACCOUNTS</b>	Manage accounts.
<b>Add a Google Account</b>	Manage Google accounts.

# Settings

<b>SYSTEM</b>	System information.
<b>Date, time &amp; location</b>	Set date, time, time zone and formats.
<b>Accessibility</b>	Manage accessibility options.
<b>Developer options</b>	Developer use options.
<b>About TV</b>	System information.

## Setting up channels

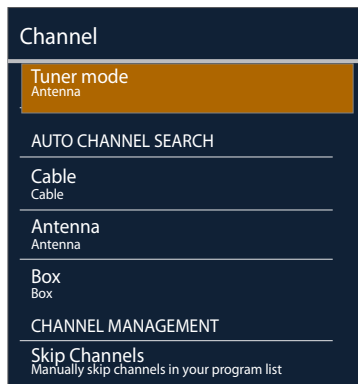

### Getting started

You need to connect Cable / Antenna or the cable / satellite box to watch TV.

#### To scan channels automatically.

1. Press [INPUT] button to set the ANT/CABLE source.
2. Press button to display the Settings menu.
3. Go to **Settings > Channel > Cable / Antenna**.
4. Press [OK] button to start automatic tuning.  
The TV scans and saves available channels automatically.
5. When you want to return to the previous menu, press button.

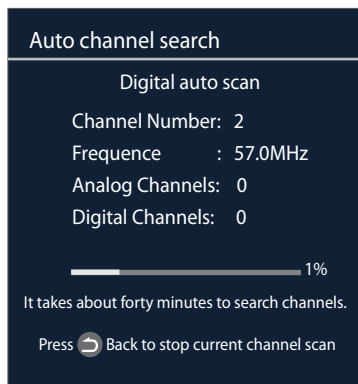

## Network

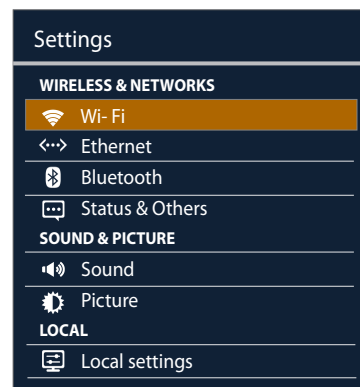

### Wi-Fi

You can select an available Wi-Fi network from the list of Wi-Fi networks found in your area or set up a new Wi-Fi network.

#### How to set up

1. Press button to display the Settings menu.
2. Go to **Settings > Wi-Fi**.
3. Press [OK] button to set Wi-Fi enabled.
3. A screen will appear listing all of the wireless networks within range of the TV. Use the [/] button to select the wireless network and press [OK] button to confirm.
4. A screen will appear prompting you to enter the password for the selected security mode. Using the remote control to enter the password. Use [/] buttons to highlight **Connect** and press [OK] button to confirm.
5. If you need to add network, a screen will appear prompting you to enter the **Network SSID** of your wireless network. Using the remote control to enter the SSID and select the security mode for your wireless network.
6. When done, Use [/] buttons to highlight **Save** and press [OK] button.

# Settings

## Ethernet





Use the Automatic Network Setup while your connecting the TV to a network that supports DHCP. To set up your TV's cable network connection automatically, follow these steps:

### How to set up automatically

1. Connect your TV to your LAN as described in the previous section.
2. Press  button to display the Settings menu.
3. Go to **Settings > Ethernet**.
4. Set **IP settings** to **Dynamic**.  
Auto acquires and enters the needed Internet values automatically.
5. When done, select **Status** to check the Internet connectivity. If the Network Function has not acquired the network connection values, go to the directions for Manual.

Use the Automatic Network Setup when connecting your TV to a network that requires a Static IP address. To get the network connection values on most windows computers, follow these steps:

### Getting the Network Connection Values

1. Press  button to display the Settings menu.
2. Go to **Settings > Ethernet > Static**.
3. Set **IP settings** to **Static**, then press [/] button to select item and press [/] button to move the cursor to the entry field. Then press 0~9 buttons to enter the numbers.
4. When done, press [OK] button to confirm.

## Parental Control

Prevent unauthorized users, such as children, from watching unsuitable programs.

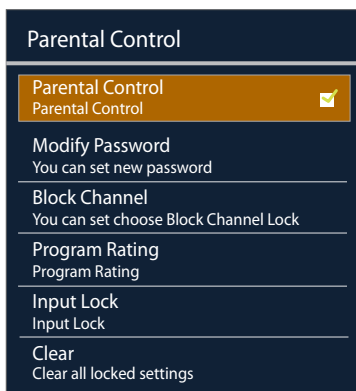

### You can adjust:



1. Press  button to display the Settings menu.
2. Go to **Settings > Privacy & Control > Parental Control**.  
**Enter password:** When you first use this function, the default password is [0000]. Once you press [OK] button to open soft keyboard, input this password, you can set options.  
**Parental Control:** Press [OK] button to set Parental Control enabled.  
**Modify Password:** If you want to change the default password, first enter the new password then enter the same password again.  
**Block Channel:** Block selected Channels on the TV.  
**Program Rating :** Block selected Programs ratings on the TV.
  - **You can set Program Rating:** Press [OK] button to set Program Rating enabled.
  - **U.S. TV Rating:** Restrict TV programs by USA Ratings.
  - **U.S. Movie Rating:** Restrict movies by USA Ratings.
  - **Canadian English/French Rating:** Restrict movies and TV programs by Canadian Ratings.
  - **Open V-Chip:** Display an advanced V-Chip ratings table for digital channels (USA only).

## Viewing the E-manual

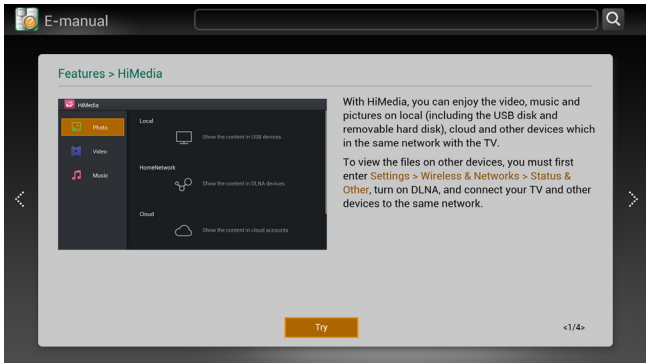
This TV has a built-in E-manual that contains information about your TV's key features and instructions for using them.



### How to view the E-manual

1. Press  button to access the Home menu.
2. Press [**▼**] button to access the Apps menu.
3. Press [**▲/▼/◀/▶**] button to select the **E-manual** App, and press [OK] button to open the **E-manual**.
4. Press [**▲/▼**] button to select the E-manual option, then press [OK] button to view it.
5. Press [**◀/▶**] button to switch the page.
6. When you want to return to the previous menu, press  button.

## DLNA Settings

Computer, TV and other digital devices can be connected via DLNA. You can use the TV set as a DLNA DMP (Digital Media Player) device to enjoy movies, pictures, music and other multimedia materials stored on your home network devices through DLNA connection.

DLNA Setting needs to be set on TV and computer Respectively.

### Network Setup

1. To use DLNA to enjoy movies, pictures, music, you have to connect the TV into a network first.
2. For more information on how to configure your network, refer to "Network".
  - It is recommended to locate both the TV and the PC in same subnet. The first 3 parts of the subnet address of the TV and the PC IP addresses should be the same and only the last part (the host address) should be changed.
3. Using a LAN cable, connect between the external modem and the PC onto which Windows Media Player Manager Program will be installed.

### Set DLNA to On

1. Press [Home] button to access the Home menu.
2. Go to **Settings > Status & Other > DLNA switch**.
3. Press [OK] button to set DLNA enabled.

# Settings

## Media Share Settings in Computer

If your computer does not support DLNA, you may install software that supports DLNA such as TVerseity or Windows Media Player. We recommend Windows Media Player as the installation and setup is easier.

1. Start the Windows Media Player(V11 or higher).
2. Click “Library” and then “Add to Library...”.

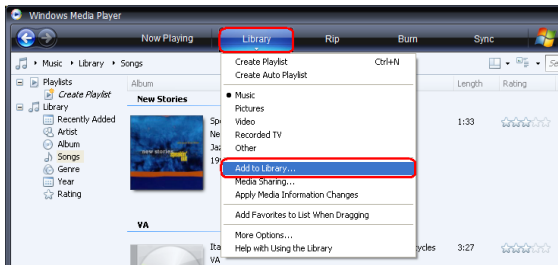

3. The “Add To Library” will pop up on the screen. Click “Add”.

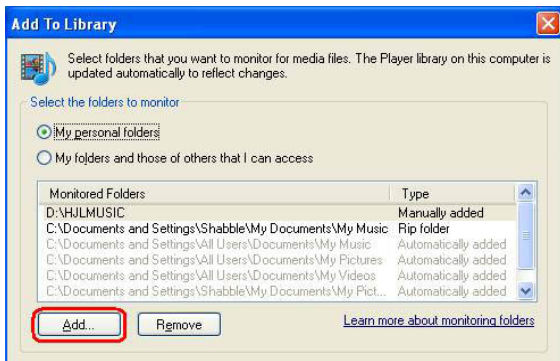

4. Select a folder and click “OK”.

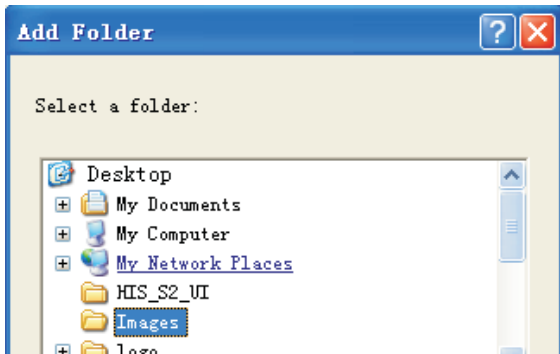

5. Click “Close” to close the dialog.

## Settings to Share Files

1. Click “Library” and move the cursor to select “Media Sharing...”

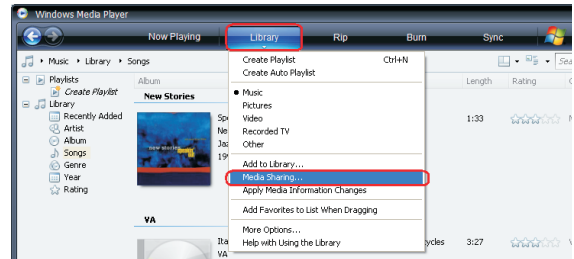

2. Click the box to select “Share my media” and click “OK”.

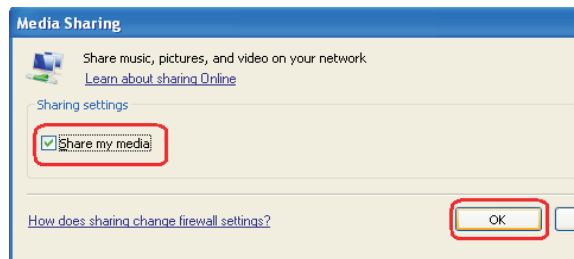

3. An equipment icon will appear on the white area if the DLNA Settings has been correctly set. Select the appropriate icon and then click “Allow”.

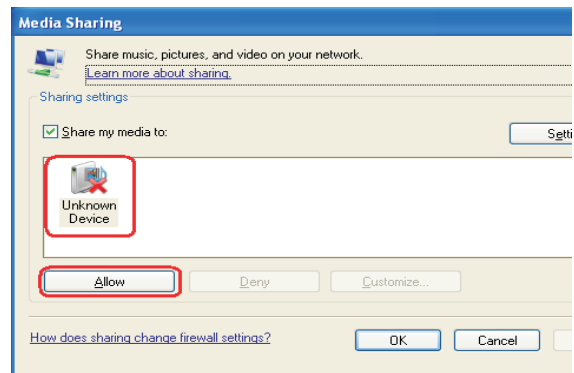

4. The TV now has access to the shared files on the computer.

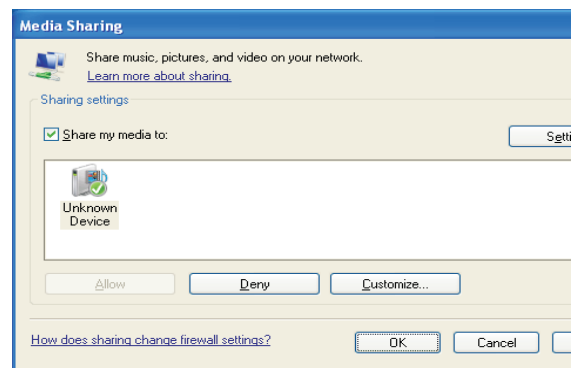

# Advanced Features

## Accessing Home Menu

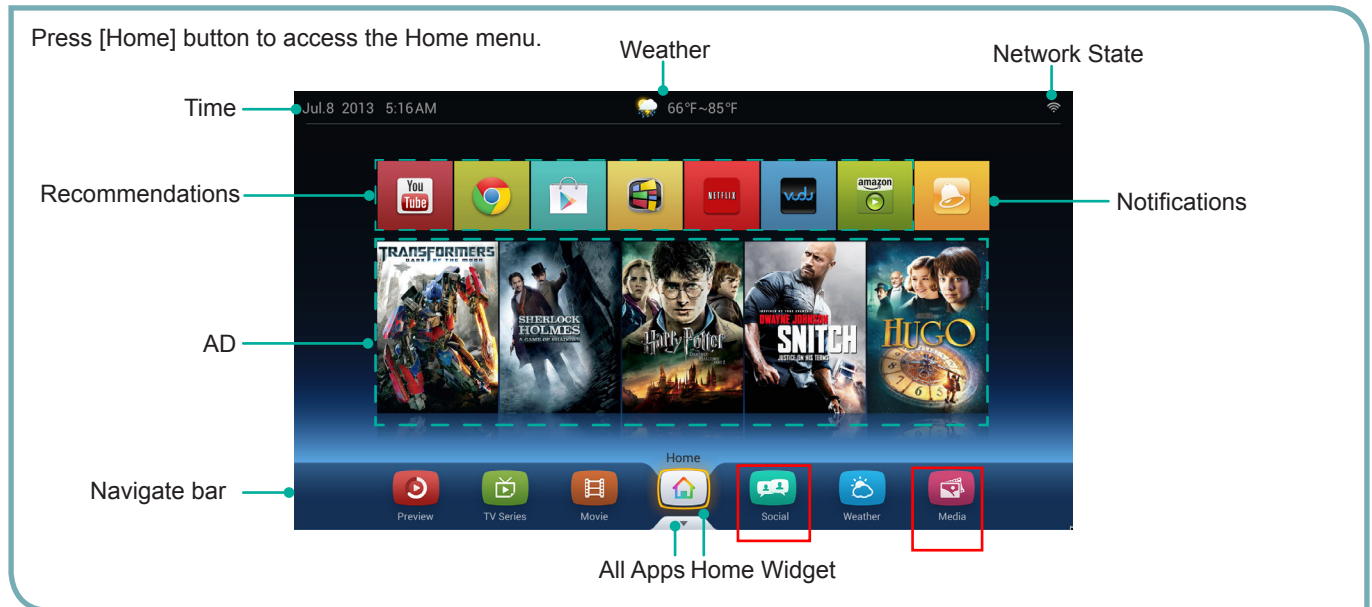

## Home Screen

You can access various content and applications from the Home screen. The home screen contains Notifications, All Apps, and shortcuts to select applications and websites.

### You can adjust:

1. Press button to access the Home menu.
2. Press [///>] to access various content and applications on the Home screen.

**Notifications** - Click on the notifications icon to display information about downloading applications, software updates, notifications regarding your account, etc.

**All Apps** - All Apps contains all pre-loaded and downloaded items as well as Channel shortcuts (saved as 'favorites'), Settings, and Downloads.

**Navigate bar** - Select one to launch an application. You can customize the applications.

### NOTE

Function icons on the main screen can not be adjusted.

## Changing the wall paper

The wall paper of the Home screen can be customized to suit your preferences.

1. Press [>] button when the Home screen is displayed.
2. Press [/>] to select the theme of the wall paper.

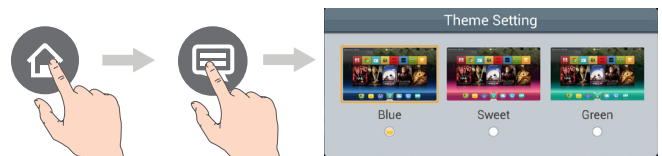

## Voice Search

The TV allows you to find TV shows and movies, launch apps, open webpages, and more by voice search function.

Simply press the button and start speaking to the MIC on the remote control.

### NOTE

Please connect to the network and Bluetooth before using the voice search feature.

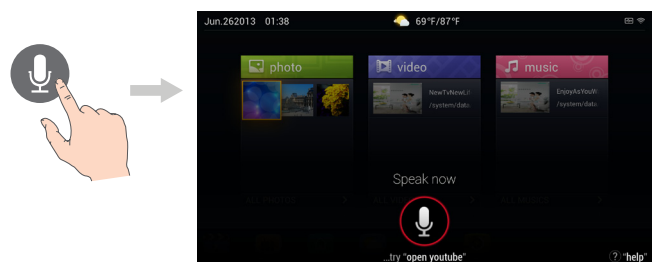



# Advanced Features

## HiMedia

This function enable you to enjoy photos, music and/or video files saved on a USB device.

### Getting started



#### - Connecting a USB Device

Connect a USB device containing photo, music and/or video files to the USB jack on the TV.

#### - Connecting to PC through network

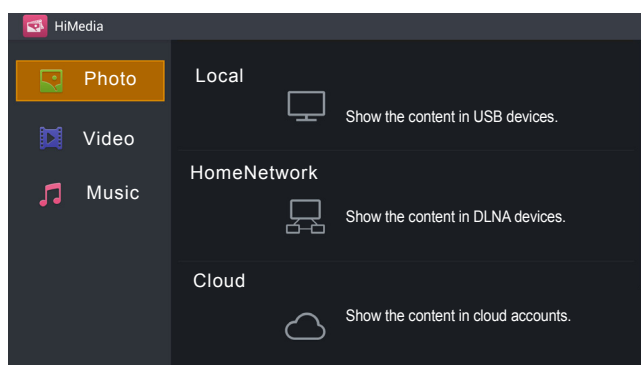
### Entering the Media Menu











1. Press the [Media] button to display **HiMedia** menu.
2. Press [▲/▼] button to select an icon(**Photo, Video, Music**), then press the [▶] button to enter.
3. Press [▲/▼] button to select the devices of saved files. Press the [OK] button.
  - This function differs depending on the **Local / Home Network / Cloud** (Only for Photo file type).
    - Local** - Show the content on USB devices.
    - Home Network** - Show the content on DLNA devices.
    - Photo Apps** - Start photo applications, such as Google Photo.
4. Press [▲/▼/◀/▶] button to select the folder/file you want to open and then press [OK] to enter/play the folder/file.
5. Press  to return the previous directory.
6. Press [OK] to play the file.
7. Press  button to display/exit the options menu.

### Playable format list

<i>Files Format</i>	<i>Playable format</i>
<b>Photo</b>	JPG
<b>Music</b>	MP3
<b>Video</b>	MPEG1(.dat), MPEG2(.mpg/.ts), XVID(.avi), MPEG4H.264(.mov/.ts/.mkv/.mp4)

### Icons available during playing

1. Press  button to display/exit the options menu.
2. Press [▲/▼/◀/▶] button to select an icon, then press the [OK] button to confirm.

<i>Icon</i>	<i>Operations</i>
	Starts or re-starts playback (video/music playback). Starts Slideshow or starts moving a panoramic photo (photo playback).
	Pauses playback (video/music playback).
	Fast forwards the video.
	Fast rewinds the video.
	Exit play mode and return to the HiMedia menu.
	Skips to the previous file (video playback)/track (music playback)/file (photo playback).
	Skips to the next file (video playback)/track (music playback)/file (photo playback).

## HiBeam (Digital Media Receiver)

### Brief introduction

With the Digital Media Receiver you do not have to crowd around a small tablet PC or smartphone screen to share video, music or pictures with friends and family. Simply browse, discover and beam media files stored on your Android or iOS device to your TV using the Twonky Beam application.

### Operation introduction

1. **TV side**
  - Confirm the TV is connected to a local area network.
  - Set DLNA enabled.
2. **Device Setup**
  - Download the Twonky Beam application using the link found on the Hisense website at [www.hisense-usa.com](http://www.hisense-usa.com).
  - Confirm the device is connected to the same local area network as the TV.
  - Launch the Twonky Beam application, select the video, music or picture you want to share and beam it to the TV.
  - You can control the playback using the TV remote or from the device application.

## Other Information

### Trouble Shooting

**When something appears wrong with your TV refer to below chart. If the proposed remedy's do not work , then unplug the AC cord from wall, wait at least 60 seconds, plug AC back in and then turn on the TV. If the problem still cannot be solved, please contact the help line provided on the warranty card or a professional technician.**

<i><b>SYMPTOMS</b></i>	<i><b>POSSIBLE SOLUTIONS</b></i>
No sound or picture.	<ul style="list-style-type: none"> <li>● Check if the power cord is plugged into AC outlet and if it has electricity.</li> <li>● Check if you have pressed [POWER] button on the TV or [POWER] button on the remote control.</li> <li>● Check to see if LED on. If illuminated, power to TV is OK.</li> </ul>
I have connected an external source to my TV and I get no picture and/or sound.	<ul style="list-style-type: none"> <li>● Check for the correct output connection on the external source and for the correct input connection on the TV.</li> <li>● Make sure you have made the correct selection for the input mode for the incoming signal.</li> </ul>
When I turn on my television, there is a few second delay before the picture appears. Is this normal?	Yes, this is normal. That is the TV searching for previous setting information and initializing the TV.
Picture is normal, but no sound.	<ul style="list-style-type: none"> <li>● Check the volume settings.</li> <li>● Check if Mute mode is set "on".</li> </ul>
	<ul style="list-style-type: none"> <li>● Check if headphones are connected.</li> </ul>
	<ul style="list-style-type: none"> <li>● Check if the audio output is set to AV receiver (if so, be sure the AVR is powered on and set to the proper input).</li> </ul>
	<ul style="list-style-type: none"> <li>● If using a cable / satellite set top box, check if Mute is set to On.</li> </ul>
Sound and picture distorted or appear wavy.	<ul style="list-style-type: none"> <li>● An electrical appliance may be affecting TV set. Turn off any appliances, if interference goes away, move appliance farther away from TV.</li> <li>● Insert the power plug of the TV set into another power outlet.</li> </ul>
Sound and picture is blurry or cuts out momentarily.	<ul style="list-style-type: none"> <li>● If using an external antenna, check the direction, position and connection of the antenna.</li> <li>● Adjust the direction of your antenna or reset or fine tune the channel.</li> </ul>
Horizontal/vertical stripe on picture or picture is shaking.	Check if there is interfering source nearby, such as appliance or electric tool.
The plastic cabinet makes a "clicking" type of sound.	"Click" sound can be caused when the room temperature changes. This change causes the television cabinet to expand or contract, which makes the sound. This is normal and the TV is OK.
Black square appears in the center of my television screen?	The Closed Caption function is set in the text mode. To remove it, access Closed Caption from the menu screen and change the Mode setting from text to either CC1 or off .
On some channels getting another language or sometimes no sound at all.	<p>That would indicate that the MTS mode on your unit is set to "SAP" mode. We suggest setting the MTS mode to either "Stereo" or "Mono".</p> <ul style="list-style-type: none"> <li>● SAP is Second Audio Program. It's a second audio channel that is usually used for a second language or descriptive audio for the visually impaired.</li> <li>● MTS stands for Multichannel Television Sound, a standard that allows the encoding of 3 channels of audio within a standard NTSC (analog) video signal to a television. A television that is able to receive MTS Stereo allows you to watch television with stereo sound.</li> </ul>
Not getting all of my cable channels on the television or I'm only getting 13 channels.	Check the cable connection for an incoming signal. The best way to confirm signal is to use another TV and/or contact your cable company.

## Other Information

<i><b>SYMPTOMS</b></i>	<i><b>POSSIBLE SOLUTIONS</b></i>
Remote control does not work.	<ul style="list-style-type: none"> <li>● Confirm that TV still has power and is operational.</li> <li>● Change the batteries in the remote control.</li> <li>● Check if the batteries are correctly installed.</li> <li>● Confirm the remote control is paired with the TV (see “Pairing the Remote”).</li> <li>● If using a universal remote, be sure to select the TV mode on the remote.</li> <li>● If the remote still does not work:               <ul style="list-style-type: none"> <li>-Remove and reinstall the batteries correctly to reset the remote or install new batteries.</li> <li>-Press TV Power to turn on the TV. With a universal remote if you have reset or changed the batteries you will need to reprogram the remote for the other units.</li> </ul> </li> </ul>
Network connection fail.	<ul style="list-style-type: none"> <li>● Check network physical connection, make sure connection is correct.</li> <li>● Make sure configuration is correct according to your network service provider.</li> </ul>
Connect Netflix fail.	<ul style="list-style-type: none"> <li>● Check network connection is correct, both physically and configuration.</li> <li>● Make sure that network connection test is successful.</li> <li>● <b>For Netflix:</b> Enter “Netflix” to reset Netflix account.</li> </ul>
DLNA does not work.	<ul style="list-style-type: none"> <li>● Check network connection is correct, both physically and configuration.</li> <li>● Make sure DLNA server (PC or Mac) has shared media content and TV has permission to access shared media.</li> <li>● Enter Home &gt; Settings &gt; Status &amp; Others, set “DLNA switch” enabled.</li> </ul>
How do I get the Applications to work on my TV?	<ul style="list-style-type: none"> <li>● You need a broadband (high speed) Internet service with a speed of no less than 1.5 Mbps.</li> <li>● Connect the TV to the Internet through your router by an ethernet cable or wireless connection. If the connection fails, check with your internet service provider or router manufacturer to determine if there is a firewall, content filter, or proxy settings that may block the TV from accessing the Internet.</li> <li>● After connecting the TV to the Internet, press the [Home] button on the remote to access the Applications.</li> </ul> <p><b>Caution:</b> Do not try to repair the TV yourself. Refer all servicing to qualified repair personnel.</p>
I can't find my TV channel after the first boot setting.	That may because you didn't set your TV device for the first time. Enter Settings > Video input > Add device manually to configure the TV device.
I enter my ZIP code, but can't find my place.	<ul style="list-style-type: none"> <li>● Make sure your zip code is correct .</li> <li>● Check your network connection, make sure your network is connected.</li> </ul>
No output from one of the speakers.	Adjust Balance in the settings.
The power is on but the screen appears extremely dark.	Adjust the brightness and contrast in the menu option.
“No Signal” appears on the screen.	Check if the signal cable is connected between the TV and products properly.
The reception on some channels is poor.	<ul style="list-style-type: none"> <li>● Scroll to other channels. There may a problem with the broadcast.</li> <li>● The station signal may be weak. Aim the antenna to the proper direction.</li> <li>● Check if there is local interferences such as an electrical appliance or power tool.</li> </ul>
Message is displayed saying “Unsupported Audio (Video)” or the video (audio) is working normally but the audio (video) is not working normally.	<ul style="list-style-type: none"> <li>● Check whether the file is playing normally on a PC (Check whether the file is damaged.).</li> <li>● Check whether the audio (video) code is supported.</li> <li>● Check whether the bit rate is supported.</li> <li>● Check whether the sample rate is supported.</li> </ul>
Thin lines appear in the background of the screen.	Check the video cable connections.

## Other Information

<b>SYMPTOMS</b>	<b>POSSIBLE SOLUTIONS</b>
The TV turns off suddenly.	● Check the power control settings. The power supply may be interrupted.
	● Check if the Auto sleep feature is activated in the Time settings.
The image can't be shown on the full screen.	● Check if the movie aspect ratio is different from TV.
	● Go to Settings > Picture > Aspect ratio to set the aspect ratio.
Can't connect an IR Blaster to control the device.	● Go to Tools > Settings > Video input to check if the setting is right.
	● Check if your IR Blaster is placed in the right place.
	● Press [INPUT] button to display the Select Device menu, check if you choose the device you add.
Can't use CEC function to control the device.	● Go to Settings > Local settings > HDMI settings to check if the setting is right.
	● Check if your device is compatible with Control for HDMI. If you connect an HDMI device that is not HDMI CEC - compatible, all the HDMI CEC Control features will not work.