

Hisense

USER MANUAL

Before using the TV, please read this manual thoroughly and retain it for future reference.

CHILD SAFETY:

It Makes A Difference How and Where
You Use Your Flat Panel Display

Congratulations on your purchase! As you enjoy your new product, please keep these safety tips in mind:



THE ISSUE

- The home theater entertainment experience is a growing trend and larger flat panel displays are popular purchases. However, flat panel displays are not always supported on the proper stands or installed according to the manufacturer's recommendations.
- Flat panel displays that are inappropriately situated on dressers, bookcases, shelves, desks, speakers, chests or carts may fall over and cause injury.

THIS MANUFACTURER CARES!

- The consumer electronics industry is committed to making home entertainment enjoyable and safe.

TUNE INTO SAFETY

- One size does NOT fit all. Follow the manufacturer's recommendations for the safe installation and use of your flat panel display.
- Carefully read and understand all enclosed instructions for proper use of this product.
- Don't allow children to climb on or play with furniture and television sets.
- Don't place flat panel displays on furniture that can easily be used as steps, such as a chest of drawers.
- Remember that children can become excited while watching a program, especially on a "larger than life" flat panel display. Care should be taken to place or install the display where it cannot be pushed, pulled over, or knocked down.
- Care should be taken to route all cords and cables connected to the flat panel display so that they cannot be pulled or grabbed by curious children.



WALL MOUNTING: IF YOU DECIDE TO WALL MOUNT YOUR FLAT PANEL DISPLAY, ALWAYS:

- Use a mount that has been recommended by the display manufacturer and/or listed by an independent laboratory (such as UL, CSA, ETL).
- Follow all instructions supplied by the display and wall mount manufacturers.
- If you have any doubts about your ability to safely install your flat panel display, contact your retailer about professional installation.
- Make sure that the wall where you are mounting the display is appropriate. Some wall mounts are not designed to be mounted to walls with steel studs or old cinder block construction. If you are unsure, contact a professional installer.
- A minimum of two people are required for installation. Flat panel displays can be heavy.



Important Safety Instructions

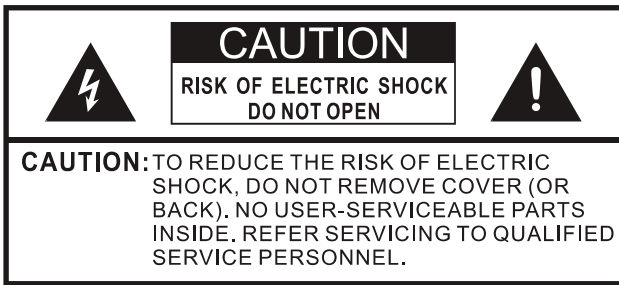

1. Read these instructions.
2. Keep these instructions.
3. Heed all warnings.
4. Follow all instructions.
5. Do not use this apparatus near water.
6. Clean only with dry cloth.
7. Do not block any ventilation openings. Install in accordance with the manufacturer's instructions.
8. Do not install near any heat sources such as radiators, heat registers, stoves, or other apparatus (including amplifiers) that produce heat.
9. Do not defeat the safety purpose of the polarized or grounding-type plug. A polarized plug has two blades with one wider than the other. A grounding type plug has two blades and a third grounding prong. The wide blade or the third prong are provided for your safety. If the provided plug does not fit into your outlet, consult an electrician for replacement of the obsolete outlet.
10. Protect the power cord from being walked on or pinched particularly at plugs, convenience receptacles, and the point where they exit from the apparatus.
11. Only use attachments/accessories specified by the manufacturer.
12. Use only with cart, stand, tripod, bracket, or table specified by the manufacturer, or sold with the apparatus. When a cart is used, use caution when moving the cart/apparatus combination to avoid injury from tip-over.
13. Unplug this apparatus during lightning storms or when unused for long periods of time.
14. Refer all servicing to qualified service personnel. Servicing is required when the apparatus has been damaged in any way, such as power-supply cord or plug is damaged, liquid has been spilled or objects have fallen into the apparatus, the apparatus has been exposed to rain or moisture, does not operate normally, or has been dropped.
15. Apparatus should not be exposed to dripping or splashing, and objects filled with liquids, such as vases, should not be placed on the apparatus.



S3125A



The lightning flash with arrowhead symbol, within an equilateral triangle is intended to alert the user to the presence of uninsulated dangerous voltage within the product's enclosure that may be of sufficient magnitude to constitute a risk of electric shock.



The exclamation point within an equilateral triangle is intended to alert the user to the presence of important operating and maintenance (servicing) instructions in the literature accompanying the appliance.

16. An outside antenna system should not be located in the vicinity of overhead power lines or other electric light or power circuits, or where it can fall into such power lines or circuits. When installing an outside antenna system, extreme care should be taken to keep from touching such power lines or circuits, as contact with them might be fatal.
17. Do not overload wall outlets and extension cords, as this can result in a risk of fire or electric shock.
18. Do not push objects through any openings in this unit, as they may touch dangerous voltage points or short out parts that could result in fire or electric shock. Never spill

EXAMPLE OF ANTENNA GROUNDING AS PER THE NATIONAL ELECTRICAL CODE

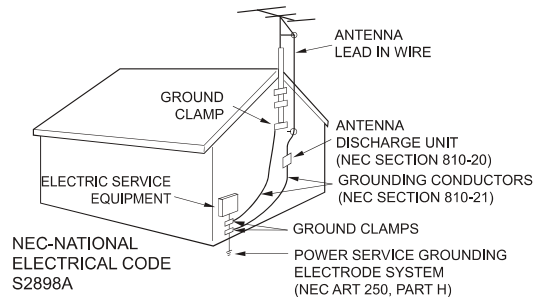

- or spray any type of liquid into the unit.
19. If an outside antenna or cable system is connected to the unit, be sure the antenna or cable system is grounded to provide some protection against voltage surges and built-up static charges, Section 810 of the National Electrical Code, ANSI/NFPA 70, provides information with respect to proper grounding of the mast and supporting structure, grounding of the lead-in wire to an antenna discharge unit, size of grounding conductors, location of antenna discharge unit, connection to grounding electrodes, and requirements for the grounding electrode.
 20. When replacement parts are required, be sure the service technician uses replacement parts specified by the manufacturer or those that have the same characteristics as the original part. Unauthorized substitutions may result in fire, electric shock or other hazards.
 21. Upon completion of any service or repairs to this unit, ask the service technician to perform safety checks to determine that the unit is in proper operating condition.

Important Safety Instructions

22. When you connect the product to other equipment, turn off the power and unplug all of the equipment from the wall outlet. Failure to do so may cause an electric shock and serious personal injury. Read the owner's manual of the other equipment carefully and follow the instructions when making any connections.
23. Sudden high volume sound may cause hearing or speaker damage. When you use headphones, (if the unit is equipped with a headphone jack) keep the volume at a moderate level. If you use headphones continuously with high volume sound, it may cause hearing damage.

CONDENSATION:

Moisture will form in the operating section of the unit if the unit is brought from cool surroundings into a warm room or if the temperature of the room rises suddenly. When this happens, unit's performance will be impaired. To prevent this, let the unit stand in its new surroundings for about an hour before switching it on, or make sure that the room temperature rises gradually.

Condensation may also form during the summer if the unit is exposed to the breeze from an air conditioner. In such cases, change the location of the unit.

HOW TO HANDLE THE LCD PANEL:

- Do not press hard or jolt the LCD panel. It may cause the LCD panel glass to break and injury may occur.
- If the LCD panel is broken, make absolutely sure that you do not touch the liquid in the panel. This may cause skin inflammation.
If the liquid gets in your mouth, immediately gargle and consult with your doctor. Also, if the liquid gets in your eyes or touches your skin, consult with your doctor after rinsing for at least 15 minutes or longer in clean water.

Possible Adverse Effects on LCD Panel:

If a fixed (non-moving) pattern remains on the LCD Panel for long periods of time, the image can become permanently engrained in the LCD Panel and cause subtle but permanent ghost images. This type of damage is NOT COVERED BY YOUR WARRANTY. Never leave your LCD Panel on for long periods of time while it is displaying the following formats or images:

- Fixed Images, such as stock tickers, video game patterns, TV station logos, and websites.
- Special Formats that do not use the entire screen. For example, viewing letterbox style (16:9) media on a normal (4:3) display (black bars at top and bottom of screen); or viewing normal style (4:3) media on a widescreen (16:9) display (black bars on left and right sides of screen).

The following symptoms are not signs of malfunction but technical limitation. Therefore we disclaim any responsibility for these symptoms.

- LCD Panels are manufactured using an extremely high level of precision technology, however sometimes parts of the screen may be missing picture elements or have luminous spots.
This is not a sign of a malfunction.
- Do not install the LCD Panel near electronic equipment that produces electromagnetic waves. Some equipment placed too near this unit may cause interference.
- Effect on infrared devices - There may be interference while using infrared devices such as infrared cordless headphones.

Declaration of Conformity

This device complies with part 15 of the FCC Rules. Operation is subject to the following two conditions:
(1) This device may not cause harmful interference and (2) This device must accept any interference received, including interference that may cause undesired operation.

End of life directives

Your TV also contains material that can be recycled and reused. For disposal or recycling information, contact your local authorities or the Electronic Industries Alliance at <http://www.eia.org>, the Electronic Products Recycling Association at <http://www.eprassociation.ca> (for Canada) in your area.

Non-active pixels

The LCD panel contains almost 3 million thin film transistors, which provide exceptionally sharp video quality. Occasionally, a few non-active pixels may appear on the screen as a fixed black (in the case of a dead pixel), blue, green, or red point. These non-active pixels do not adversely affect the performance of your TV, and are not considered defects.

Power source

TO USE AC POWER

1. The power cord is attached to the TV at the factory.
2. Connect the AC cord into an AC outlet.

WARNING

Do not connect this unit to the power using any device other than the supplied AC cord. This could cause fire, electrical shock, or damage.

Do not use with a voltage other than the power voltage specified. This could cause fire, electrical shock, or damage.

CAUTION

When this unit is not used for a long time, (e.g., away on a trip) in the interest of safety, be sure to unplug it from the AC outlet.

Do not plug/unplug the AC cord when your hands are wet. This may cause electrical shock.

Notices de sécurité importantes



MISE EN GARDE

**RISQUE DE CHOC ÉLECTRIQUE
NE PAS OUVRIR**



ATTENTION: AFIN DE RÉDUIRE LE RISQUE DE CHOC ÉLECTRIQUE, NE PAS ENLEVER LE COUVERCLE (OU LE DOS). CET APPAREIL NE CONTIENT AUCUNE PIÈCE RÉPARABLE PAR L'UTILISATEUR. FAIRE APPEL À UN TECHNICIEN QUALIFIÉ.



L'éclair avec symbole de flèche dans un triangle équilatéral avise l'utilisateur de la présence d'une tension dangereuse non isolée dans le boîtier du produit et qui peut être d'intensité suffisante pour présenter un risque de choc électrique.



Le point d'exclamation dans un triangle équilatéral avise l'utilisateur de la présence de directives d'utilisation et d'entretien (service) importantes dans la documentation qui accompagne l'appareil.

1. Lisez les instructions.
2. Conservez les instructions.
3. Respectez tous les avertissements.
4. Suivez toutes les directives.
5. N'utilisez pas cet appareil près de l'eau.
6. Ne le nettoyez qu'avec un linge sec.
7. Ne bloquez pas les événements. Effectuez l'installation conformément aux directives du fabricant.
8. Ne l'installez pas près d'une source de chaleur comme un radiateur, un registre, une cuisinière ou autre (y compris un amplificateur) produisant de la chaleur.
9. N'enlevez pas le dispositif de sécurité de la fiche polarisée ou avec mise à la terre. Une fiche polarisée comporte deux lamelles dont une est plus large que l'autre. Une fiche avec mise à la terre comporte deux lamelles et une broche de terre. La lamelle large et la broche de terre sont fournies pour votre sécurité. Si la fiche ne convient pas à la prise de courant, consultez un électricien et faites remplacer la prise de courant.
10. Placez le cordon d'alimentation de façon à ce qu'il ne soit pas écrasé ou pincé surtout au niveau de la fiche, des prises et au point de sortie de l'appareil.
11. N'utilisez que des périphériques/ accessoires spécifiés par le fabricant.
12. Ne l'utilisez qu'avec un chariot, un trépied, un support ou une table spécifiée par le fabricant ou vendue avec l'appareil. Si vous utilisez un chariot, soyez prudent quand vous le déplacez afin d'éviter que l'ensemble chariot/téléviseur culbute.
13. Débranchez l'appareil lors d'un orage électrique ou s'il n'est pas utilisé pendant une période prolongée.
14. Confiez le service à une personne qualifiée. Un service est requis si l'appareil est endommagé d'une façon quelconque (cordon d'alimentation ou fiche endommagée, liquide renversé ou objet échappé dans l'appareil, appareil exposé à la pluie ou à l'humidité, mauvais fonctionnement ou appareil échappé).
15. L'appareil ne devrait pas être exposé aux éclaboussures. Ne placez jamais d'objets remplis de liquide (comme un vase) sur l'appareil.
16. Une antenne extérieure ne devrait pas être située à proximité des lignes haute tension, d'un éclairage



S3125A

électrique ou d'autres circuits électriques, ni là où elle pourrait s'écraser contre des lignes ou circuits électriques. Lors de l'installation d'une antenne extérieure, il faut prendre les mesures nécessaires pour éviter de toucher les lignes ou circuits électriques car un tel contact pourrait être mortel.

17. Ne surchargez pas les prises murales ni les rallonges car cela présente un risque d'incendie ou de choc électrique.
18. N'insérez aucun objet dans les ouvertures de l'appareil car vous pourriez toucher un point de tension dangereuse ou court-circuiter une pièce résultant en un incendie ou un choc électrique. Ne renversez ni ne pulvérisez aucun liquide dans l'appareil.

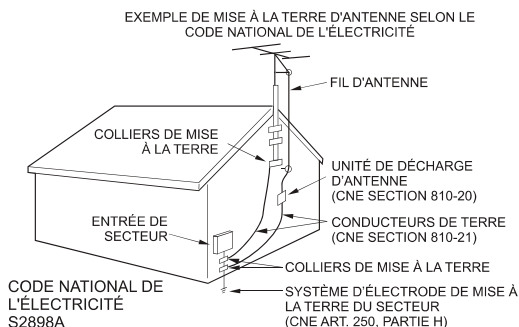

19. Si une antenne ou un système de câble extérieur est branché à l'appareil, assurez-vous que l'antenne ou le système est relié à la terre afin de protéger contre la surtension ou les décharges électrostatiques. La section 810 du Code national de l'électricité, ANSI/NFPA 70, renseigne sur la mise à la terre appropriée du mât et de la structure de soutien, la mise à la terre du fil conducteur à une unité de décharge d'antenne, la taille des conducteurs de terre, l'emplacement de l'unité de décharge d'antenne, la connexion aux électrodes de terre et les exigences concernant l'électrode de terre.
20. Si des pièces de rechange sont requises, assurez-vous que le technicien n'utilise que les pièces spécifiées par le fabricant ou ayant les mêmes caractéristiques que les pièces originales. Toute substitution non autorisée peut présenter un risque d'incendie, de choc électrique ou autre.
21. Une fois l'entretien ou la réparation terminée, demandez au technicien d'effectuer une vérification de sécurité afin d'établir si l'appareil fonctionne correctement.

Notices de sécurité importantes

22. Si vous connectez le produit à un autre appareil, éteignez-le et débranchez-le de la prise de courant. Autrement vous risquez un choc électrique ou des blessures graves. Lisez le manuel de l'utilisateur de l'autre appareil et suivez les directives de connexion.
23. Un son soudain d'intensité élevée peut endommager l'ouïe ou les haut-parleurs. Si vous utilisez des écouteurs (appareil doté d'une prise d'écouteurs), tenez l'intensité sonore à un niveau moyen. L'utilisation continue d'écouteurs à intensité sonore élevée peut endommager l'ouïe.

CONDENSATION:

De l'humidité peut se former dans la partie fonctionnelle de l'appareil si celui-ci passe d'un endroit frais à un endroit chaud ou si la température de la pièce s'élève subitement. Dans pareil cas, le rendement de l'appareil peut diminuer. Pour éviter une telle situation, laissez l'appareil s'ajuster au niveau milieu pendant une heure environ avant de le mettre en circuit. Encore, assurez-vous que la température de la pièce s'élève graduellement.

Une condensation peut aussi se former en été si l'appareil est exposé au courant d'air d'un climatiseur. Dans pareil cas, changez l'emplacement de l'appareil.

MANIPULATION DU PANNEAU ACL:

- N'appuyez pas fort sur l'ACL et ne le secouez pas. Vous risqueriez de briser le verre de l'ACL et de vous blesser.
- Si l'ACL est brisé, assurez-vous de ne pas toucher le liquide dans le panneau. Le liquide peut irriter la peau. Si vous avalez du liquide, gargarisez-vous immédiatement et consultez un médecin. Si le liquide entre en contact avec les yeux ou la peau, rincez-les pendant au moins 15 minutes à l'eau claire et consultez un médecin.

Effets nocifs possibles de l'écran ACL:

Si un motif fixe reste à l'écran pendant une longue durée, l'image peut devenir imprégnée en permanence sur l'écran ACL et former une image fantôme subtile mais permanente. Ce type de dommage n'est PAS COUVERT PAR LA GARANTIE. Ne laissez jamais l'écran ACL allumé pendant une longue durée quand il affiche des images des types suivants:

- images fixes comme les résultats de la Bourse, les motifs de jeu vidéo, les logos de stations de télévision et les sites Web;
- les formats spéciaux qui ne couvrent pas l'écran entier (format boîte aux lettres [16:9] sur écran normal [4:3] (barres noires dans le haut et le bas) ou vue normale [4:3] sur grand écran [16:9] (barres noires sur la gauche et la droite)).

Les signes suivants ne proviennent pas d'un mauvais fonctionnement mais d'une limite technique. Nous ne pouvons donc pas être tenus responsables de tels signes.

- Les écrans ACL sont fabriqués avec un niveau extrêmement élevé de précision mais certaines parties de l'écran peuvent ne pas avoir d'éléments d'image ou présenter des points lumineux.
Il ne s'agit pas d'un mauvais fonctionnement
- N'installez pas l'écran ACL près d'un équipement électronique qui génère des ondes électromagnétiques car cela pourrait causer une interférence.
- Effet sur les appareils à infrarouge – il peut y avoir interférence quand on utilise un appareil à infrarouges comme un téléphone sans fil à infrarouges.

Énoncé de conformité

Cet appareil est conforme à la section 15 des règlements de la FCC. Le fonctionnement est régi par deux conditions : (1) l'appareil ne peut pas causer d'interférence nuisible et (2) l'appareil doit accepter toute interférence reçue, y compris une interférence qui peut entraîner un fonctionnement indésirable.

Directives de fin de vie

Votre téléviseur contient des matériaux qui peuvent être recyclés et réutilisés. Pour l'élimination ou le recyclage, contactez les autorités locales ou l'Electronic Industries Alliance à l'adresse <http://www.eia.org>, les produits l'Association du Recyclage des Produits Electronique au <http://www.eprassociation.ca> (pour le Canada) dans votre région.

Pixels inactives

L'écran ACL compte près de 3 millions de transistors en couches minces fournissant une qualité d'image extrêmement élevée. À l'occasion, des pixels inactifs peuvent apparaître à l'écran sous forme de point fixe noir (pixel mort), bleu, vert ou rouge. Ces pixels inactifs ne nuisent pas au rendement de votre téléviseur et ne sont pas considérés un vice.

Alimentation électrique

SECTEUR

1. Le cordon d'alimentation est branché au téléviseur à l'usine.
2. Branchez le cordon dans une prise de courant.

⚠ AVERTISSEMENT

Ne branchez pas l'appareil à l'aide d'un dispositif autre que le cordon fourni car cela présenterait un risque d'incendie, de choc électrique ou de dommage. N'utilisez pas une tension autre que celle spécifiée pour l'appareil car cela présenterait un risque d'incendie, de choc électrique ou de dommage.

⚠ MISE EN GARDE

Pour des raisons de sécurité, débranchez l'appareil de la prise de courant si vous prévoyez ne pas l'utiliser pendant une période prolongée (ex. : voyage). Ne branchez/débranchez pas le cordon d'alimentation si vous avez les mains mouillées car cela pourrait provoquer un choc électrique.

Important Safety Instructions

When Installing the TV Against a Wall or Enclosed Area

Make sure that your TV has adequate air circulation. Allow enough space around the TV as shown below. Avoid operating the TV at temperatures below 41°F (5°C).

Install with stand

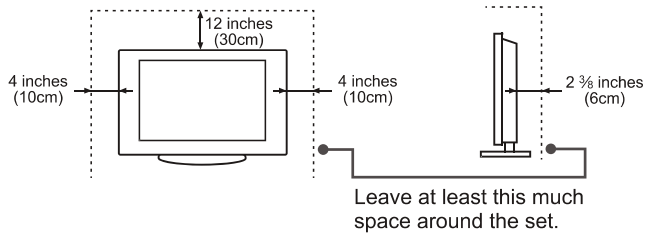

Install on the wall

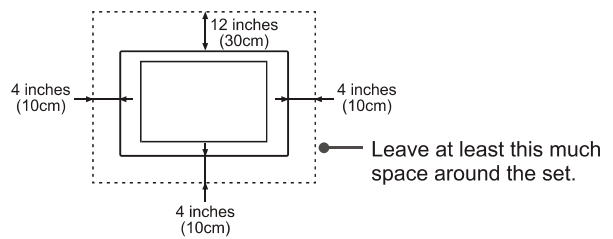

Never install the TV set as follows:

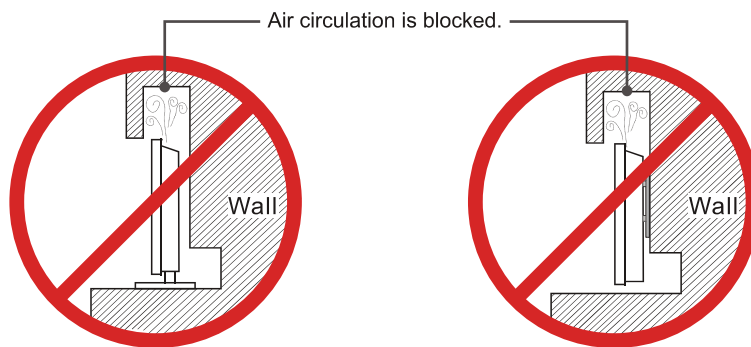

Inadequate air circulation can lead to overheating of the TV and may cause damage to your TV or cause a fire.

Legal Notices

FCC Statement

NOTE:

This equipment has been tested and found to comply with the limits for a class B digital Device, pursuant to part 15 of the FCC Rules. These limits are designed to provide reasonable protection against harmful interference in a residential installation. This equipment generates, uses and can radiate radio frequency energy and, if not installed and used in accordance with the instructions, may cause harmful interference to radio Communications. However, there is no guarantee that interference will not occur in a particular installation. If this equipment does cause harmful interference to radio or television reception, which can be determined by turning the equipment off and on, the user is encouraged to try to correct the interference by one or more of the following measures:

- Reorient or relocate the receiving antenna.
- Increase the separation between the equipment and the receiver.
- Connect the equipment into an outlet on a circuit different from that to which the receiver is connected.
- Consult the dealer or an experienced radio/TV technician for help.

FCC ID Number WiFi Module: N89-WU322HS

The WiFi Module complies with FCC radiation exposure limits set forth for an uncontrolled environment. This device should be installed and operated with a minimum distance of 20 centimeters between the radiator and your body.

This TV incorporates High-Definition Multimedia Interface (HDMI™) technology.

HDMI, the HDMI logo and High-Definition Multimedia Interface are trademarks or registered trademarks of HDMI Licensing LLC.



Hisense and associated logos where applicable are registered trademarks of Hisense Group in the United States and/or other countries. All other trademarks are property of their respective owners. 2013 Hisense USA, Corporation. All Rights Reserved. Manufactured under license from Dolby Laboratories. Dolby and the double-D symbol are trademarks of Dolby Laboratories.

* Specifications subject to change without notice.



NOTE

Where the MAINS plug or an appliance coupler is used as the disconnect device, the disconnect device shall remain readily operable.

WARNING

The manufacturer is not responsible for any radio or TV interference caused by unauthorized modifications to this equipment. Such modifications could void the user's authority.

Contents

Getting Started

Installing Batteries in the Remote Control	3
Making Connections	4
Network Connection	7

Basic Features

Turning your TV on or off.....	9
Turning the TV On for the First Time	9
Changing Channels / Volume	10
Selecting the Input Source	10
Shortcuts Instructions	11
To Use the Menu	12
Using the Picture Menu	12
Using the Audio Menu	13
Using the TV Menu.....	14
Using the Setup Menu	14
Using the Network Menu	16

Advanced Features

DLNA Setting.....	18
Media Share Settings in Computer.....	18
Setting to Share Files	19
Network Function.....	20
Using the Home Menu.....	21
Movies	21
Apps	21
AccuWeather	21
YouTube	21
VUDU Movies	22

Contents

Advanced Features

VUDU Apps	22
Netflix.....	23
Vimeo	23
Pandora	24
Twitter	24
Picasa.....	24
Opera.....	25
Opera Apps.....	27
Digital Media Receiver (HiBeam)	28
Digital Media Player(HiMedia)	28
Browse Pictures.....	29
Enjoy Video Files.....	29
Enjoy Music Files.....	30

Other Information

Troubleshooting.....	31
----------------------	----

Getting Started

Installing Batteries in the Remote Control

Change the batteries

1. Press the release button on the back of the remote control to remove the battery compartment cover.
2. Insert two AAA size batteries. Make sure to match the (+) and (-) ends of the batteries with the (+) and (-) ends indicated in the battery compartment.
3. Replace the battery compartment cover.

❶ Remove the battery compartment cover

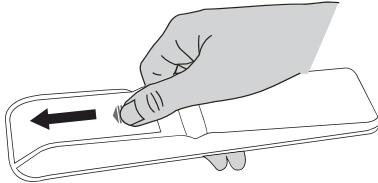

❷ Insert the batteries

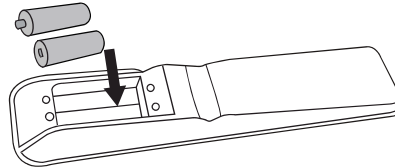

NOTES

1. Dispose of your batteries in a designated disposal area. Do not throw the batteries into a fire.
2. Remove depleted batteries immediately to prevent leakage into the battery compartment.
3. If you do not intend to use the remote control for a long time, remove the batteries.
4. Batteries should not be exposed to excessive heat, such as sunshine, heat registers, or fire.
5. Battery chemicals can cause a rash. If the batteries leak, clean the battery compartment with a cloth. If chemicals touch your skin, wash immediately.
6. Do not mix old and new batteries.
7. Do not mix alkaline, standard (carbon-zinc) or rechargeable (ni-cad, ni-mh, etc.) batteries.

Match your remote with TV

- Insert Batteries.
- Connect the TV to power.
- → Aim your remote control within 6-inches of the lower left corner of your TV.
- Press the — and LA ST keys simultaneously for at least 3 seconds. The LED at the top of your remote will light for one second and blink slowly three times to indicated the remote has paired with the TV. Note: If the LED blinks rapidly, the remote has failed to pair with the TV, repeat the pairing procedure.

❏ The effective range of remote control

1. The remote control distance: up to 26 feet in front of the TV set.

Getting Started

Making connections

NOTES

- Check the jacks for position and type before making any connections. Loose connections can result in image or color problems. Make sure that all connections are tight and secure.
- Not all A/V devices have the ability to connect to a TV, please refer to the user manual of your A/V device for compatibility and connections procedure.
- Always unplug the power cord when connecting external equipment.

Connecting an antenna, cable or cable/satellite box

1. Turn off the TV before connecting the antenna.
2. Connect one end of a coaxial cable (not included) to the RF OUT jack on the antenna, cable or cable/satellite box. If you are using an antenna with twin-lead cable, you may need a 300-75 ohm adapter (not provided) to connect it to the back of your TV. Likewise, if you are using several antennas, you may need a combiner (not provided).
3. Connect the other end of the cable to the ANT/CABLE jack on the side of your TV.

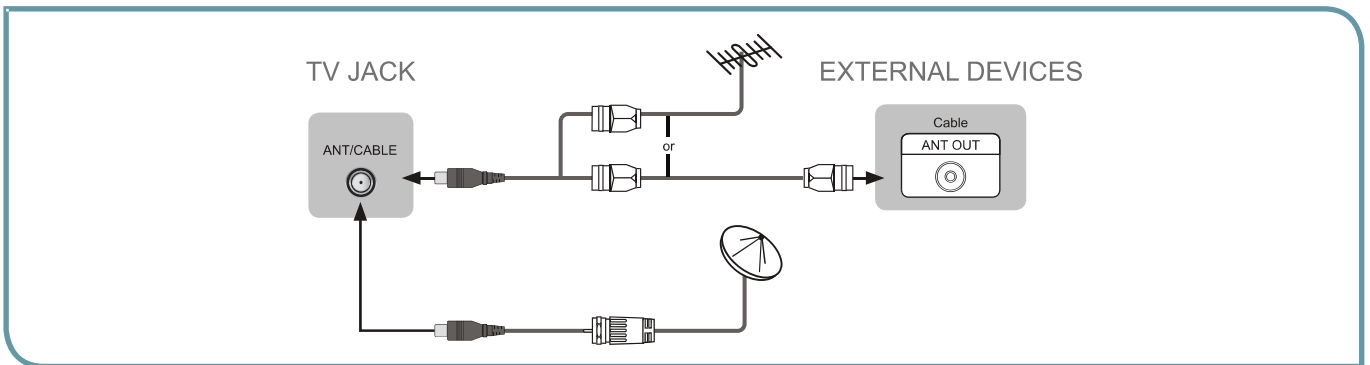

Connecting an A/V Device with Composite Cable

1. Use the audio and video cables to connect the external A/V device's composite video/audio jacks to the TV's jacks. (Video = yellow, Audio Left = white, and Audio Right = red)

NOTE

Connect the yellow video plug to the Green Y-input jack on the TV.

2. Plug the connected devices into the mains socket before switching on the TV.
3. Select the corresponding source from the TV.

