

**Hisense**



**H3C Series**

**H3C Series TV  
Quick Start Guide**

Help Hisense improve the environment by reducing paper waste.  
For detailed instructions and feature descriptions, access the full User Manual online .

© 2016 Hisense Company Ltd. All Rights Reserved.

All material in this Quick Start Guide is the property of Hisense Company Ltd. and its subsidiaries, and is protected under US, CANADA, MEXICO and International copyright and/or other intellectual property laws. Reproduction or transmission of the materials, in whole or in part, in any manner, electronic, print, or otherwise, without the prior written consent of the Hisense Company Ltd. is a violation of Hisense Company Ltd. rights under the aforementioned laws.

No part of this publication may be stored, reproduced, transmitted or distributed, in whole or in part, in any manner, electronic or otherwise, whether or not for a charge or other or no consideration, without the prior written permission of Hisense Company Ltd.

Requests for permission to store, reproduce, transmit or distribute materials may be made to one of the following addresses:

USA: Hisense USA Corporation

PO Box 3289

Suwanee, GA 30024

CANADA: Hisense Canada Co., Ltd,

405 Britannia Rd E., Suite 11

Mississauga, Ontario, L4Z 3E6

MEXICO: Hisense Mexico S de RL de CV

Boulevard Miguel de Cervantes Saavedra No. 301, Torre Norte, Piso 2,

Colonia Ampliación Granada, C.P. 11520, en México Distrito Federal.

Hisense, and any and all other Hisense product names, logo's, slogans or marks are registered trademarks of Hisense Company Ltd. and its subsidiaries. All other trademarks are the property of their respective holders.

## Enjoy TV in a Super Simple and Super Unique Way!

### LED TV with Popular Features

- LED backlight that offers better brightness and contrast
- Energy-efficient design to reduce your utility bill
- HiMedia Digital Media Player to play back digital content from your USB drive
- 1080p resolution for (49" )

### Multiple Connection Methods

- 1 Digital Audio Out port
- 1 USB Connector
- 3 HDMI Connectors
- RF Antenna connector
- 1 VGA connector
- Component ports
- Composite ports

### High-Quality Picture and Sound

- Vibrant contrast and brightness to display images accurately
- Crisp sound and powerful TV speaker output
- 1080p full high definition (FHD) resolution for (49" TV)







### Easy Setup Menu and Simple Design

- Short and easy-to-follow first-time setup menu
- Simple user interface (UI) design to navigate the TV screens
- Descriptive features to help make your selections

## WELCOME TO THE HISENSE FAMILY!

Congratulations on the purchase of your new Hisense TV! This Quick Start Guide will walk you through a few easy steps to set up your TV. For more details about all of the features and instructions to use them, download a PDF of the *Hisense H3C Series TV User Manual* from the Hisense support website below.

Because we value your business, we want to keep you in the know of 'all things Hisense'. Using your mobile phone, scan the Registration page QR code to register your TV. Depending on the make and model of your phone, you may need to download a QR code scanning app.

Country	Customer Care Center	Hisense Support Page	REGISTER YOUR TV
U.S.A	<ul style="list-style-type: none"> <li>• <b>Phone:</b> 1-888-935-8880</li> <li>• <b>Hours of Operation:</b> Monday - Friday: 9 AM to 9 PM EST Saturday - Sunday: 9 AM to 6 PM EST</li> <li>• <b>Service Email:</b> Service@hisense-usa.com</li> </ul>	<a href="http://www.hisense-usa.com/support/">http://www.hisense-usa.com/support/</a> 	<a href="http://www.hisense-usa.com/support/productReg.asp">http://www.hisense-usa.com/support/productReg.asp</a> 
CANADA	<ul style="list-style-type: none"> <li>• <b>Phone:</b> 1-855-344-7367</li> <li>• <b>Hours of Operation:</b> Monday - Friday: 8 AM to 8 PM EST</li> <li>• <b>Service Email:</b> canadasupport@hisense.com</li> </ul>	 <a href="http://www.hisense-canada.com/support/">http://www.hisense-canada.com/support/</a>	 <a href="http://www.hisense-canada.com/support/productReg.asp">http://www.hisense-canada.com/support/productReg.asp</a>
MEXICO	<ul style="list-style-type: none"> <li>• <b>Phone:</b> 01-800-008 8880</li> <li>• <b>Hours of Operation:</b> Monday - Friday 9:00-18:00</li> <li>• <b>Service Email:</b> servicio@hisense.com.mx</li> </ul>	<a href="http://www.hisense.com.mx/support/">http://www.hisense.com.mx/support/</a> 	<a href="http://www.hisense.com.mx/support/productReg.asp">http://www.hisense.com.mx/support/productReg.asp</a> 

To view and open the user manual, you will need to install Adobe® Reader® (which is FREE) to your computer. Once you arrive on the Support page of the Hisense website, enter the model number located on the back of the TV or on the outside of the box.

**Disclaimer:** *This Quick Start Guide is intended as a general guideline to help you set up your Hisense TV. Images throughout this document are for illustrative purposes only and may differ from the actual product.*

## Packaged contents

Your package in which you purchased your new TV contains the following items:

- TV
- 2 AAA batteries
- A left and right leg that forms the TV stand
- *Hisense H3C Series TV Quick Start Guide (this document)*
- *Important Safety Information and Warranty Card leaflet*
- 4 Screws (ST4X25C)
- Remote Control

### IMPORTANT:

To prevent accidentally discarding items that came with your TV, be sure to **check ALL of the foam** in the carton box.

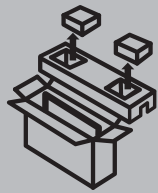

- Please check foam for accessories before discarding.
- Veuillez vérifier la mousse pour qu'il n'y ait pas d'accessoires avant de la jeter.
- Antes de desechar la espuma, asegúrese de retirar todos los accesorios.

## Required tools and devices

- Phillips screwdriver (not included) to secure the TV stand
- HDMI and other types of cables (not included) to connect external devices to the TV
- Wall mount bracket (not included) if you prefer to mount the TV to the wall

# BUTTONS AND PORTS ON THE H3C SERIES TV

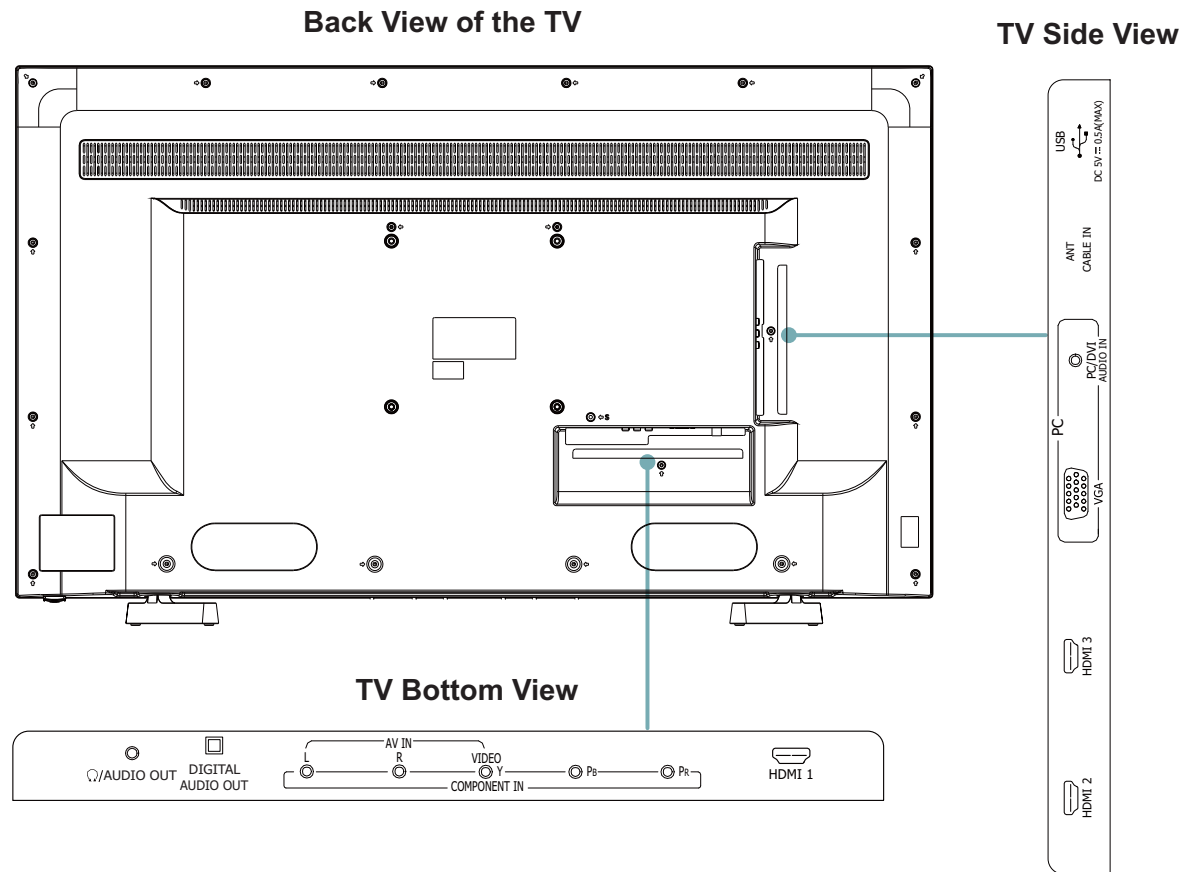

## STEP 1. Attach the TV stand or wall mount bracket (not included)

**Attach the TV Stand** (For steps to attach the wall mount see page 6)

**CAUTION:**

- Be sure to disconnect the A/C power cord before installing a stand or Wall-Mount brackets.
- The LED display is very fragile and must be protected at all times when installing the legs that form the stand. Be sure to protect the TV screen from getting scratched or damaged by any hard objects. In addition, DO NOT exert pressure on the front of the TV at any time because it could crack.

To attach the left and right leg that forms the stand:

1. Carefully place your TV face down on a soft, flat surface to prevent damage to the TV or scratching to the screen.
2. Remove the 2 legs from the foam and then insert the stands into the bottom slots of the TV.
3. Use the screws that came inside the carton with your TV to secure each leg tightly.

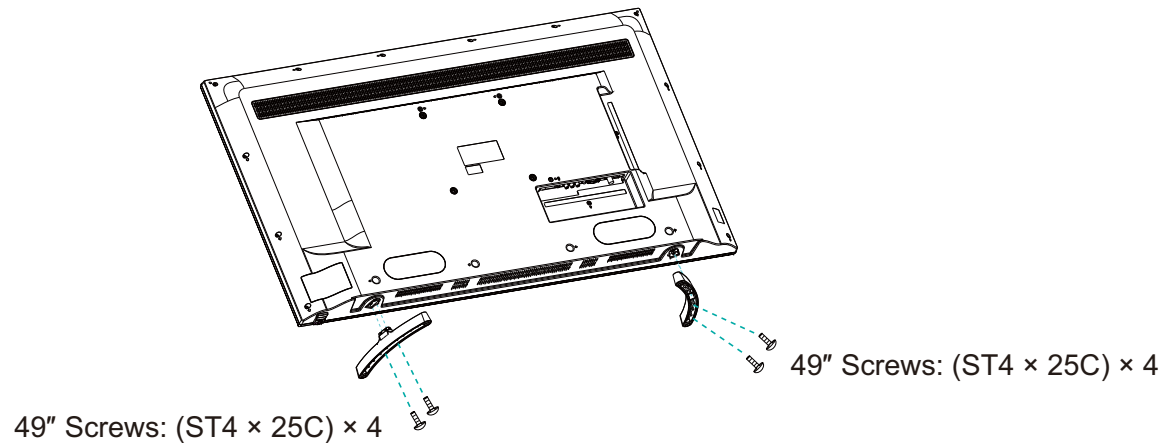

### Attach the Wall Mount Bracket (not included)

Before you begin the third-party manufacturer instructions, be sure to do the following things:

1. Place the TV face down on a clean, safe and cushioned surface.
2. Remove the TV stand if you already attached it.
3. Place the spacers (not included) in the corresponding bracket holes.

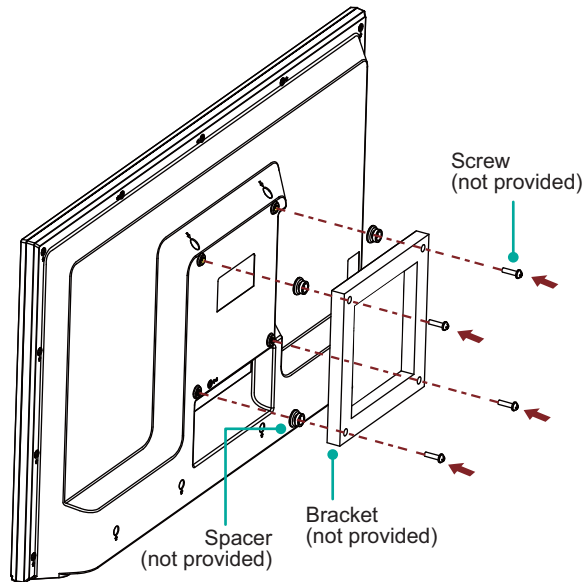

#### CAUTION:

- When you attach the mount, be sure to use the spacers (provided by the third-party manufacturer) between the TV and the bracket.

- To prevent internal damage to the TV and ensure it is mounted securely, be sure to use fixing screws (not provided) that are 8.0 - 10.0 mm in length when measured from the attaching surface of rear cover.

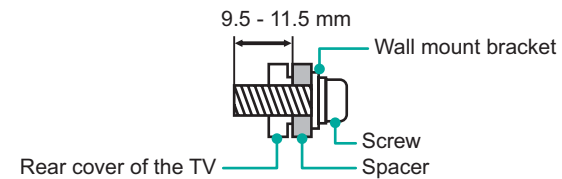

Wall mount hole pattern VESA (mm)	200 × 200
Wall mount screw size (mm)	M6

Follow instructions provided with the Wall mount bracket.











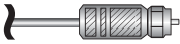

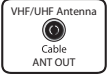







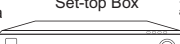









- To complete the installation, please contact the wall-mount manufacturer.
- The selected screws are 9.5 - 11.5 mm in length when measured from the attaching surface of the rear cover. The length of the screws differ depending on the Wallmount bracket model.











**NOTE:** The length of the screws differ depending on the wall mount bracket model.

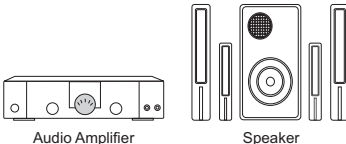

## STEP 2. Connect devices to your TV

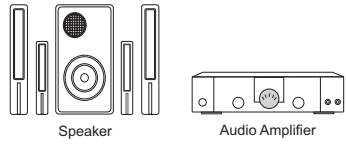
Check to ensure that you have selected the right cables for the ports and that they are connected securely. Loose connections can affect the quality of the picture image and color.

TV label		Port	Cable	External Equipment	Brief Description
ANT/CABLE IN				 Antenna  VHF/UHF Antenna Cable ANT OUT	Connect an outdoor VHF/UHF antenna.
HDMI					Connect a High Definition Multimedia Interface (HDMI) cable from an external device.
COMPO-NENT IN	Y		 Green	 VCR  DVD Player/Recorder  Video Camera  Set-top Box  Satellite Receiver  Satellite antenna cable	Connect a component video cable and left-right audio cables from an external AV device.
	P <sub>B</sub>		 Blue		
	P <sub>R</sub>		 Red		
	L		 White		
	R		 Red		
AV IN	VIDEO		 Yellow		Connect a composite video cable and left-right audio cables from an external AV device.
	L		 White		
	R		 Red		
PC IN	VGA			 PC	Connect a VGA cable from your PC to use the TV as a monitor. Connect an audio cable from the PC audio out.
	PC / DVI AUDIO IN				

TV label	Port	Cable	External Equipment	Brief Description
DIGITAL AUDIO OUT			 Audio Amplifier      Speaker	Connect an optical cable from an external digital audio system.
Ω / AUDIO OUT				Connect headphones to hear audio from the TV.
		 White Red	 Speaker      Audio Amplifier	Connect an audio adapter (not provided) from an external analog audio system.
 USB DC 5V $\equiv$ 0.5A(MAX)				Connect a USB device for browsing photos, music and movies. The unit only recognizes a USB Memory Stick.

## Buttons on your TV remote

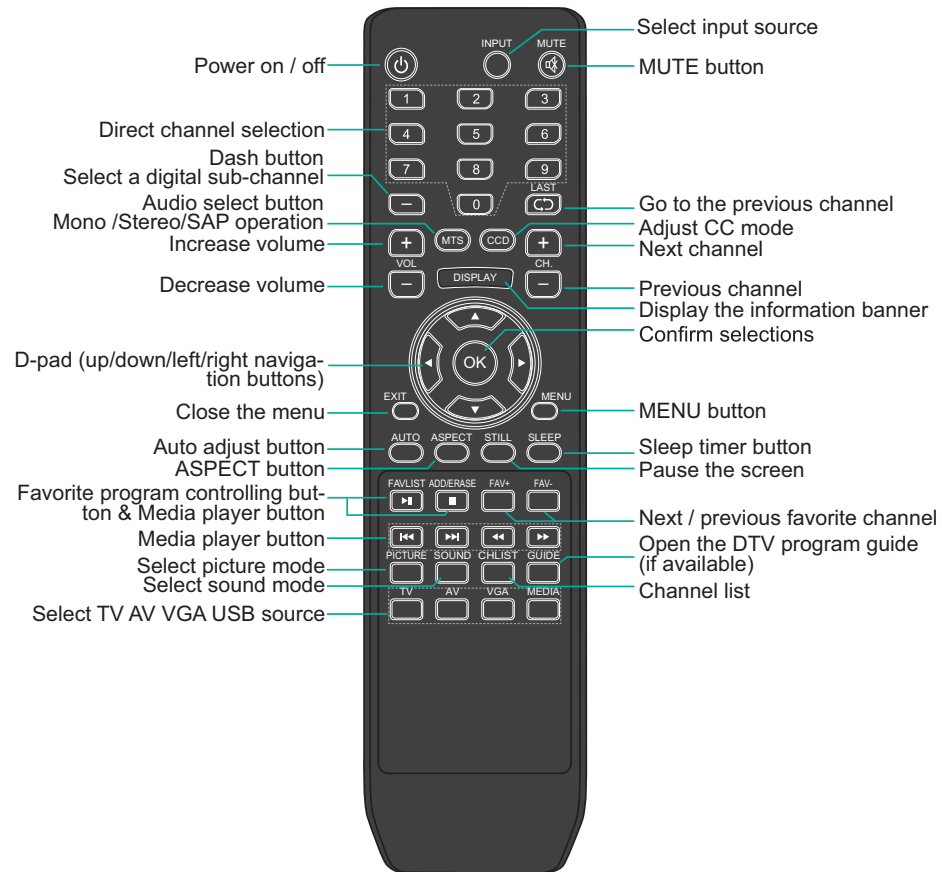

### STEP 3. Begin using your remote

1. Slide the back cover to open the battery compartment of the remote control.

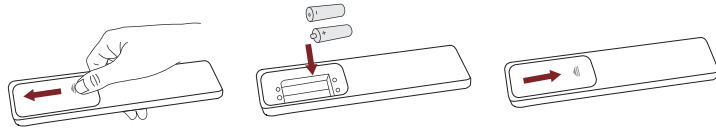

Gently push and slide

Insert the batteries

Gently push and slide

2. Insert two AAA size batteries. Make sure to match the (+) and (-) ends of the batteries with the (+) and (-) ends indicated in the battery compartment.

3. Replace the battery compartment cover.

#### Important Information about the remote and batteries:

- **Discard batteries in a designated disposal area. Do not throw them into a fire.**
- **Remove old batteries immediately to prevent them from leaking into the battery compartment.**
- **If you do not intend to use the remote control for a long time, remove the batteries.**
- **Battery chemicals can cause a rash. If the batteries leak, clean the battery compartment with a cloth. If chemicals touch your skin then wash it immediately.**
- **Do not mix old and new batteries.**
- **Do not mix alkaline, standard (carbon-zinc) or rechargeable (NiCd, NiMH, etc.) batteries.**
- **Do not continue using the remote if it gets warm or hot.**  
**Call our Support Center immediately on the Hisense support website.**

#### Remote Control Range Information

- The remote control can work at a distance of up to 26 feet in front of the TV set.
- It can work at a 30 degree horizontal or vertical angle.

#### Notes for battery disposal:

The batteries used with this product contain chemicals that are harmful to the environment.

To preserve our environment, dispose of used batteries according to your local laws or regulations.

Do not dispose of batteries with normal household waste.

For more information, please contact the local authority or your retailer where you purchased the product.

All trademarks are the property of their respective owners and all rights are acknowledged.

**the use of apparatus in moderate climates.**

#### Program Your Universal Cable or Satellite Remote Control to Operate Your New Hisense Television (only for USA)

If you would like to program your other household remote controls to your new Hisense television, please refer to the User's Manual supplied by your Cable or Satellite provider. The Cable or Satellite providers' User's Manuals should include instructions on how to program their remote to your television.

A list of Hisense codes for the most common Cable and Satellite providers are listed below. Use the Hisense code that is associated with your Cable or Satellite provider (if applicable).

**DIRECTV**.....0178, 10178, 10019, 10748, 11314, 11660, 11710, 11780, 12049, 10171, 11204, 11326, 11517, 11564, 11641, 11963, 12002, 12183

**Time Warner Cable**.....386, 0178, 10178, 400, 450, 461, 456, 0748, 1463, 0463, 10463

**Comcast**.....0178, 10178, 10463, 11463, 10748, 11314, 11660, 10171, 11204, 11326, 11517, 11641, 11780, 11785, 11892, 11963, 12002

**Cox Communications**.....0178, 10178, 1326, 1463

**Dish Network**.....505, 627, 538, 720, 659

If the Hisense code associated with your Cable or Satellite provider is not listed, does not work or you cannot locate the instructions to program your remote, call your local Cable or Satellite provider's customer service center.

If your Cable or Satellite provider does not have a Hisense code available, please contact us at one of the phone numbers on Page 2.

### Using Your Cable Set-top Box or Satellite Receiver Remote as a 'Universal' Remote

If you prefer to use your Cable Set-top Box or Satellite Receiver Remote as a 'Universal Remote', then visit the Support page to view a list of the codes.

## STEP 4. Power on the TV

Plug the power cord into a power outlet.

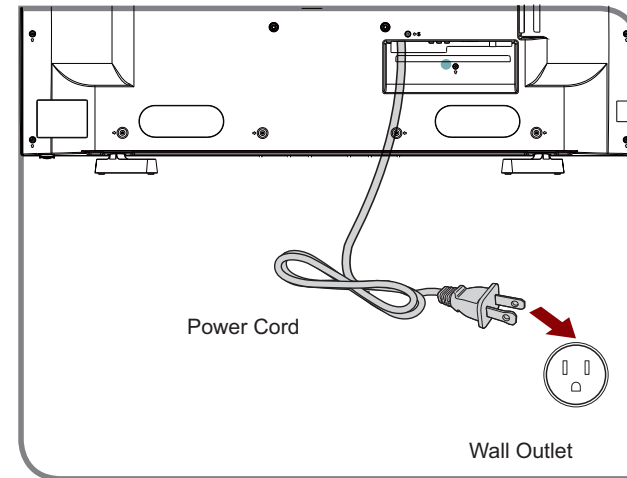

Press the **Power button**  on the remote to turn on the TV. A splash screen that shows the Hisense logo appears. Next, the First-Time Setup Menu begins by prompting you to choose your **Language, Country, and Time Zone.**



## STEP 5. Complete the first-time setup menu

After the splash screen that shows the Hisense logo appears, begin the first-time setup menu.



Menu	Operations
Language setting	<ul style="list-style-type: none"> <li>Choose your language: <b>English, Español or Français</b>, and then select <b>Next</b>.</li> </ul>
Use Mode	<ul style="list-style-type: none"> <li>Select your Mode Setting: Home Mode or Retail Mode.</li> <li><b>Home Mode</b> is the recommended setting which offers full functionality of the television. If you selected <b>Retail Mode</b>, Energy Savings is not realized.</li> </ul>
Time zone setting	<ul style="list-style-type: none"> <li>Select the local time zone according to your region.</li> <li>Daylight Saving: Set the Daylight Savings time for your area.</li> </ul>
Channel Search	<ul style="list-style-type: none"> <li>Select your Tuner Mode: Air or Cable, press <b>OK button</b> to confirm.</li> <li>Select <b>Next</b> and press <b>OK button</b> to scan channels.</li> </ul>

The above is for reference only ! For details, please see the "Completing the First-Time Setup Menu" part in the USER MANUAL!

## STEP 6. Selecting the Input Source

When you finish the first-time setup, you must select the TV signal source. Because your TV stores this information, you do not need to change the TV signal source unless it changes. For example, if you begin receiving channels from a cable provider instead of an antenna, then you'll need to change the TV signal source.

- Turn on your TV, then press **INPUT button** on the remote or on the TV. The INPUT menu opens.
- Press **▲/▼ button** to highlight the input source, then press **OK button**.

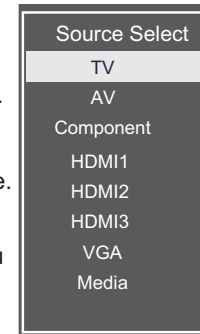

**Disclaimer:** *Subscriptions or other payments may be required to access content through some applications. Some or all of the included or downloaded application services in this Hisense device may not function depending on the Internet connection, local limitations of included applications or other reasons outside of Hisense's control. HISENSE EXPRESSLY DISCLAIMS RESPONSIBILITY FOR ANY APPLICATION SERVICE FROM FUNCTIONING AT ANY TIME, FOR CONTENT IN ANY APPLICATION SERVICE, FOR DISRUPTIONS OF SERVICE, LOCAL OR REGIONAL LIMITATIONS, WARRANTIES OF TITLE, NO INFRINGEMENT, AND FOR IMPLIED WARRANTIES OF MERCHANTABILITY OR FITNESS FOR A PARTICULAR PURPOSE. By purchasing this device, you accept such Disclaimer without any claim on Hisense at any time.*

## PRODUCT SPECIFICATIONS

<b>Model Name</b>		<b>49H3C+</b>
Dimension (W × H × D)	Without Stand	43.5 x 25.4 x 3.4 inches (1106 x 646 x 87 mm)
	With Stand	43.5 x 26.6 x 8.9 inches (1106 x 675 x 225 mm)
Weight	Without Stand	27.1 lbs (12.3 kg)
	With Stand	27.8 lbs ( 12.6 kg)
Active Screen Size (Diagonal)		49 inches
Screen Resolution		1920 × 1080
Audio Power		8 W + 8 W
Power Supply		120 V ~ 60 Hz
Receiving systems	Analog	NTSC
	Digital	ATSC / QAM
Receiving Channels		VHF: 2~13 UHF: 14~69 CATV: 1 ~ 125 Digital Terrestrial Broadcast (8VSB): 2 ~ 69 Digital cable (64/256 QAM): 1 ~ 135
Tuner Type		Frequency synthesized
Environmental Conditions		Temperature: 41°F ~ 95°F (5°C ~ 35°C) Humidity: 20% ~ 80% RH Atmospheric pressure: 86 kPa ~ 106 kPa
Component Input		480 I / 60 Hz, 480 P / 60 Hz, 720 P / 60 Hz, 1080 I / 60 Hz, 1080 P / 60 Hz (for 40")
VGA Input		VGA (640×480 / 60 Hz), SVGA (800×600 / 60 Hz), XGA (1024×768 / 60 Hz)
HDMI Input		RGB / 60 Hz (640×480, 800×600, 1024×768), YUV / 60 Hz (480 I, 480 P, 720 P, 1080 I, 1080 P(for 40"))
Ports		3 HDMI ports, 1 USB port, 1 RF input, 1 RCA composite combine with component Video input, 1 left/right Audio input for composite, 1 Digital Audio output, 1 Earphone Audio output, 1 PC/DVI Audio input, 1 PC Video input
Key features		LED Backlight, Energy Star Qualified, Digital Media Player, 720P(32")/1080P(40"), Narrow Frame

"+" would be replaced by any number, letter or blank.

**Disclaimer:** All product, product specifications, and data are subject to change without notice to improve reliability, function, design or otherwise.

## QUICK PROBLEM-SOLVING TIPS

When you experience an issue with your TV, turn it off and on again. If this does not resolve the problem, then refer to the tips below. If the problem is still not resolved, then refer to our contact information on page 2.

ISSUES	POSSIBLE SOLUTIONS
There is no sound or picture from the TV	<ul style="list-style-type: none"> <li>• Check to see if the power cord is plugged into a power outlet.</li> <li>• Press the <b>⏻ Power button</b> on the remote control to activate the unit from 'Standby' mode.</li> <li>• Check to see if the LED light is on or not. If it is, then the TV is receiving power.</li> </ul>
I have connected an external source to my TV and do not see a picture and/or hear any sound	<ul style="list-style-type: none"> <li>• Check for the correct output connection on the external source and for the correct input connection on the TV.</li> <li>• Make sure you have made the correct selection for the input mode for the incoming signal.</li> </ul>
When I turn on my TV, there is a delay for a few seconds before the picture appears. Is this normal?	<ul style="list-style-type: none"> <li>• Yes, this is normal. The TV is initializing and searching for previous setting information.</li> </ul>
The picture is normal but there is no sound	<ul style="list-style-type: none"> <li>• Check the volume settings.</li> <li>• Check if 'Mute' mode is set to <b>On</b>.</li> </ul>
Sound but no picture or black and white picture	<ul style="list-style-type: none"> <li>• If the picture is black and white, unplug the TV from the AC outlet and replug it after 60 seconds.</li> <li>• Check that the Color is set to 50 or higher.</li> <li>• Try different TV channels.</li> </ul>
The sound and/or picture is distorted or appears wavy	<ul style="list-style-type: none"> <li>• An electric appliance may be affecting the TV. Turn off any appliances that are nearby and move it farther away from the TV.</li> <li>• Insert the power plug of the TV set into another power outlet.</li> </ul>
The sound and picture is blurry or cuts out	<ul style="list-style-type: none"> <li>• If using an external antenna, check the direction, position and connection of the antenna.</li> <li>• Adjust the direction of your antenna or reset or fine tune the channel.</li> </ul>
A horizontal or vertical stripe appears on the picture and/or the picture is shaking	<ul style="list-style-type: none"> <li>• Check to see if there is an appliance or electric tool nearby that is causing interference.</li> </ul>
The plastic cabinet makes a "clicking" type of sound	<ul style="list-style-type: none"> <li>• The 'click' sound can occur when the temperature of the television changes. This change causes the television cabinet to expand or contract, which makes the sound. This is normal and the TV is OK.</li> </ul>
The remote control does not work	<ul style="list-style-type: none"> <li>• Confirm that TV still has power and is operational.</li> <li>• Change the batteries in the remote control.</li> <li>• Check if the batteries are correctly installed.</li> </ul>



## Certification and Compliance

### FCC Notice

This device has been tested and found to comply with the limits for a Class B digital device pursuant to Part 15 of the FCC Rules. These limits are designed to provide reasonable protection against harmful interference in a residential installation. This device generates, uses, and can radiate radio frequency energy and, if not installed and used in accordance with the instructions, may cause harmful interference to radio communications.

However, there is no guarantee that interference will not occur in a particular installation. If this device does cause harmful interference to radio or television reception, which can be determined by turning the device off and on, the user is encouraged to try to correct the interference by one or more of the following measures:

- Reorient or relocate the receiving antenna.
- Increase the separation between the device and receiver.
- Connect the device into an outlet on a circuit different from that to which the receiver is connected.
- Consult the dealer or an experienced radio/TV technician for help.

**NOTE: The manufacturer is not responsible for any radio or TV interference caused by unauthorized modifications to this equipment. Such modifications could void the user's authority to operate the equipment.**

### ENERGY STAR

Your Hisense TV is ENERGY STAR® qualified in the "Energy Saving" mode. It meets strict energy efficiency guidelines set by the U.S. Environmental Protection Agency and Department of Energy. ENERGY STAR



is a joint program of these government agencies, designed to promote energy efficient products and practices. Changes to certain features, settings, and functionalities of this TV (i.e. TV Guide, Picture, Sound) can increase or change the power consumption. Depending upon such changed settings, the power consumption may exceed the limits required for the ENERGY STAR qualification in the "Energy Saving" mode.

**HDMI** The terms HDMI and HDMI High-Definition Multimedia Interface, and the HDMI Logo are trademarks or registered trademarks of HDMI Licensing LLC in the United States and other countries.



©2016. All rights reserved. Hisense and the Hisense logo are trademarks of Hisense. Other brand and product names are trademarks of their respective owners.

# Hisense

## **Important Safety Information and Warranty Card**

Please read this thoroughly and keep it for future reference.

# CHILD SAFETY:

It Makes A Difference How and Where  
You Use Your Flat Panel Display

Congratulations on your purchase! As you enjoy your new product, please keep these safety tips in mind:

## THE ISSUE

- The home theater entertainment experience is a growing trend and larger flat panel displays are popular purchases. However, flat panel displays are not always supported on the proper stands or installed according to the manufacturer's recommendations.
- Flat panel displays that are inappropriately situated on dressers, bookcases, shelves, desks, speakers, chests or carts may fall over and cause injury.

## THIS MANUFACTURER CARES!

- The consumer electronics industry is committed to making home entertainment enjoyable and safe.



## TUNE INTO SAFETY

- One size does NOT fit all. Follow the manufacturer's recommendations for the safe installation and use of your flat panel display.
- Carefully read and understand all enclosed instructions for proper use of this product.
- Don't allow children to climb on or play with furniture and television sets.
- Don't place flat panel displays on furniture that can easily be used as steps, such as a chest of drawers.
- Remember that children can become excited while watching a program, especially on a "larger than life" flat panel display. Care should be taken to place or install the display where it cannot be pushed, pulled over, or knocked down.
- Care should be taken to route all cords and cables connected to the flat panel display so that they cannot be pulled or grabbed by curious children.

## WALL MOUNTING: IF YOU DECIDE TO WALL MOUNT YOUR FLAT PANEL DISPLAY, ALWAYS:

- Use a mount that has been recommended by the display manufacturer and/or listed by an independent laboratory (such as UL, CSA, ETL).
- Follow all instructions supplied by the display and wall mount manufacturers.
- If you are not sure of your ability to complete the installation, then contact the wall-mount manufacturer or the retailer from which you purchased the TV.
- Make sure that the wall where you are mounting the display is appropriate. Some wall mounts are not designed to be mounted to walls with steel studs or old cinder block construction. If you are unsure, contact a professional installer.
- A minimum of two people are required for installation. Flat panel displays can be heavy.



**CEA**  
Consumer Electronics Association

[www.CE.org/safety](http://www.CE.org/safety)

# Important Safety Instructions

	<b>CAUTION</b> RISK OF ELECTRIC SHOCK DO NOT OPEN	
TO REDUCE THE RISK OF ELECTRIC SHOCK, DO NOT REMOVE COVER (OR BACK). NO USER-SERVICEABLE PARTS INSIDE. REFER SERVICING TO QUALIFIED SERVICE PERSONNEL.		

1. Read these instructions.
2. Keep these instructions.
3. Heed all warnings.
4. Follow all instructions.
5. Do not use this apparatus near water.
6. Clean only with dry cloth.
7. Do not block any ventilation openings. Install in accordance with the manufacturer's instructions.
8. Do not install near any heat sources such as radiators, heat registers, stoves, or other apparatus (including amplifiers) that produce heat.
9. Do not defeat the safety purpose of the polarized or grounding-type plug. A polarized plug has two blades with one wider than the other. A grounding type plug has two blades and a third grounding prong. The wide blade or the third prong are provided for your safety. If the provided plug does not fit into your outlet, consult an electrician for replacement of the obsolete outlet.
10. Protect the power cord from being walked on or pinched particularly at plugs, convenience receptacles, and the point where they exit from the apparatus.
11. Only use attachments/accessories specified by the manufacturer.
12. Use only with cart, stand, tripod, bracket, or table specified by the manufacturer, or sold with the apparatus. When a cart is used, use caution when moving the cart/apparatus combination to avoid injury from tip-over.



S3125A

13. Unplug this apparatus during lightning storms or when unused for long periods of time.
14. Refer all servicing to qualified service personnel. Servicing is required when the apparatus has been damaged in any way, such as power-supply cord or plug is damaged, liquid has been spilled or objects have fallen into the apparatus, the apparatus has been exposed to rain or moisture, does not operate normally, or has been dropped.
15. To reduce the risk of fire or electric shock, do not expose this apparatus to rain or moisture.
16. Warning: the apparatus with Class I construction shall be connected to a MAINS socket outlet with a protective earthing connection.



The lightning flash with arrowhead symbol, within an equilateral triangle is intended to alert the user to the presence of uninsulated dangerous voltage within the product's enclosure that may be of sufficient magnitude to constitute a risk of electric shock.



The exclamation point within an equilateral triangle is intended to alert the user to the presence of important operating and maintenance (servicing) instructions in the literature accompanying the appliance.

17. To prevent injury, this apparatus must be securely attached to the floor/wall in accordance with the installation instructions.
18. The MAINS plug used as the disconnect device. The disconnect device shall remain readily operable.
19. Keep your TV away from moisture. Do not expose your TV to rain or moisture. If water penetrates into your TV, unplug the power cord and contact your dealer. Continuous use in this case may result in fire or electric shock.
20. Do not expose batteries to excessive heat such as sunshine, fire or the like.
21. Danger of explosion if battery is incorrectly replaced. Replace only with the same or equivalent type.

## CONDENSATION:

Moisture will form in the operating section of the unit if the unit is brought from cool surroundings into a warm room or if the temperature of the room rises suddenly. When this happens, unit's performance will be impaired. To prevent this, let the unit stand in its new surroundings for about an hour before switching it on, or make sure that the room temperature rises gradually.

Condensation may also form during the summer if the unit is exposed to the breeze from an air conditioner. In such cases, change the location of the unit.

## HOW TO HANDLE THE LCD PANEL:

- Do not press hard or jolt the LCD panel. It may cause the LCD panel glass to break and injury may occur. If the LCD panel is broken, make absolutely sure that you do not touch the liquid in the panel. This may cause skin inflammation.
- If the liquid gets in your mouth, immediately gargle and consult with your doctor. Also, if the liquid gets in your eyes or touches your skin, consult with your doctor after rinsing for at least 15 minutes or longer in clean water.

## POSSIBLE ADVERSE EFFECTS ON LCD PANEL:

If a fixed (non-moving) pattern remains on the LCD Panel for long periods of time, the image can become permanently engrained in the LCD Panel and cause subtle but permanent ghost images. This type of damage is **NOT COVERED BY YOUR WARRANTY**. Never leave your LCD Panel on for long periods of time while it is displaying the following formats or images:

- Fixed Images, such as stock tickers, video game patterns, TV station logos, and websites.
- Special Formats that do not use the entire screen. For example, viewing letterbox style (16:9) media on a normal (4:3) display (black bars at top and bottom of screen); or viewing normal style (4:3) media on a widescreen (16:9) display (black bars on left and right sides of screen).

**The following symptoms are not signs of malfunction but technical limitation. Therefore we disclaim any responsibility for these symptoms.**

- LCD Panels are manufactured using an extremely high level of precision technology, however sometimes parts of the screen may be missing picture elements or have luminous spots.  
This is not a sign of a malfunction.
- Do not install the LCD Panel near electronic equipment that produces electromagnetic waves. Some equipment placed too near this unit may cause interference.
- Effect on infrared devices - There may be interference while using infrared devices such as infrared cordless headphones.

## **DECLARATION OF CONFORMITY**

This device complies with part 15 of the FCC Rules. Operation is subject to the following two conditions:

- (1) This device may not cause harmful interference and
- (2) This device must accept any interference received, including interference that may cause undesired operation.

Changes or modifications not expressly approved by the party responsible for compliance could void the user's authority to operate the equipment.

## **End of life directives**

Your TV also contains material that can be recycled and reused. For disposal or recycling information, contact your local authorities or the Electronic Industries Alliance at [www.eia.org](http://www.eia.org) (for USA), the Electronic Products Recycling Association at <http://www.eprassociation.ca> (for Canada) to find a recycler in your area.

## **Non-active pixels**

The LCD panel contains almost 3 million thin film transistors, which provide exceptionally sharp video quality. Occasionally, a few non-active pixels may appear on the screen as a fixed black (in the case of a dead pixel), blue, green, or red point. These non-active pixels do not adversely affect the performance of your TV, and are not considered defects.

## **Power source**

### **WARNINGS:**

- **Do not connect this unit to the power using any device other than the supplied AC cord. This could cause fire, electrical shock, or damage.**
- **Do not use with a voltage other than the power voltage specified. This could cause fire, electrical shock, or damage.**

### **CAUTION:**

- **When this unit is not used for a long time, (e.g., away on a trip) in the interest of safety, be sure to unplug it from the AC outlet.**
- **Do not plug/unplug the AC cord when your hands are wet. This may cause electrical shock.**

**No naked flame sources, such as lighted candles, should be placed on the apparatus.**

# Attaching a Wall Mount or Stand to the TV

Make sure that your TV has adequate air circulation. Allow enough space around the TV as shown below. Avoid operating the TV at temperatures below 41°F (5°C).

## WARNINGS:

- When you mount your TV on the wall or place it on furniture, maintain a distance of at least 4 inches between the TV and other objects (walls, cabinet sides, and so on) to ensure proper ventilation. Failing to maintain proper ventilation may cause the TV to overheat.
- Do not mount the TV at more than a 12 degree tilt.
- Do not use screws that differ from the length and diameter that we have recommended (See the Hisense User Manual or Quick Start Guide).
- Do not fasten the screws too firmly. This may damage the TV or cause it to fall, leading to personal injury. Hisense is not liable for these kinds of accidents.
- Be careful when you touch the TV. Some parts may be warm or hot.
- Do not place any type of fabric or papers underneath, on top of, or beside the TV. This can block ventilation and cause a fire.
- For detailed information about installing the wall mount bracket, see the third-party manufacturer's instructions or contact a professional installer for assistance.
- Do not operate or handle the TV with wet hands.

## Correct way to attach a TV stand

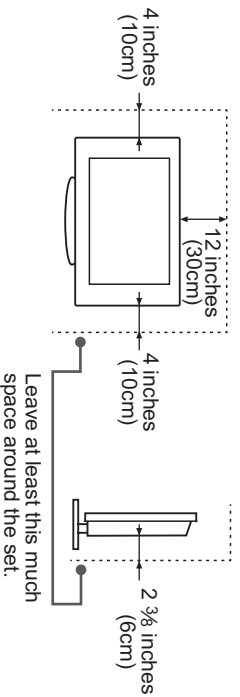

## Correct way to attach on the wall

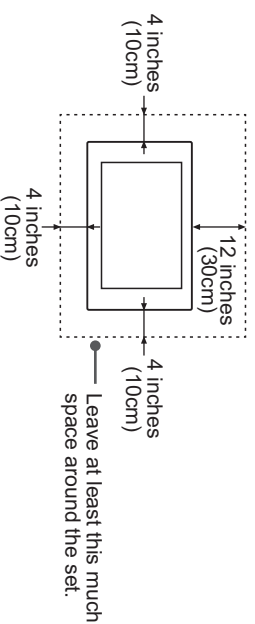

## Incorrect way to attach the Wall Mount bracket or Stand to the TV

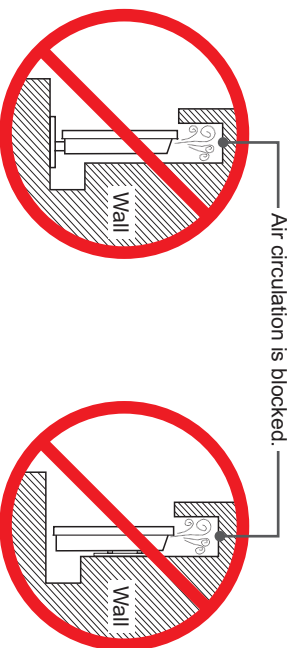

Inadequate air circulation can cause the TV to overheat.

# Hisense

## **Information importante de sécurité et la carte de garantie**

Vous devrez le lire minutieusement et le conservez pour référence future.



# SÉCURITÉ DES ENFANTS:

La façon dont vous utilisez votre téléviseur à écran plat et l'endroit où vous l'utilisez peuvent faire toute une différence.

Nous vous félicitons de votre achat ! Veuillez garder ces conseils à l'esprit alors que vous profiterez de votre nouveau produit:



## SYNTONISEZ À LA SÉCURITÉ

- Une taille ne convient pas à tout: Suivez les recommandations du fabricant pour l'installation et l'utilisation sûres du téléviseur à écran plat.
- Lisez et comprenez attentivement toutes les instructions fournies afin d'assurer une utilisation appropriée du produit.
- Ne laissez pas les enfants grimper sur ou jouer avec les meubles ou le téléviseur.
- Ne placez pas le téléviseur à écran plat sur un meuble qui peut être utilisé facilement comme escabeau, tels qu'une commode.
- Rappelez-vous que les enfants peuvent devenir agités quand ils regardent une émission, surtout sur un écran plat « plus grand que nature ». Assurez-vous de placer le téléviseur là où il ne peut pas être poussé, tiré ou renversé.
- Prenez soin d'acheminer tous les fils et les câbles du téléviseur connectés sur l'écran plat de façon qu'ils ne puissent pas être tirés ou saisis par un enfant curieux.

## MONTAGE MURAL : SI VOUS MONTEZ LE TÉLÉVISEUR À ÉCRAN PLAT À UN MUR, VOUS DEVEZ TOUJOURS :

- Utiliser un support recommandé par le fabricant du téléviseur et/ou répertorié par un laboratoire indépendant (tel que UL, CSA, ETL).
- Suivre les instructions fournies par les fabricants du téléviseur et du support mural.
- Si vous n'êtes pas sûr de votre capacité pour terminer l'installation, contactez le fabricant du montage mural ou le détaillant où vous avez acheté le téléviseur.
- Assurez-vous que le mur sur lequel le téléviseur est monté est approprié. Certains supports de fixation ne sont pas conçus pour les murs à une construction à ossature d'acier ou aux anciens blocks de béton. Si vous avez des doutes, consultez un installateur professionnel.
- Un minimum de deux personnes est nécessaire pour faire l'installation. Les téléviseurs à écran plat peuvent être lourds.

## LA QUESTION

- Le cinéma maison représente une tendance à la hausse ; il en est de même pour les téléviseurs à grand écran plat. Toutefois, les téléviseurs à écran plat ne sont pas toujours placés sur des supports appropriés ou installés conformément aux recommandations du fabricant.

- Les téléviseurs à écran plat placés sur une armoire, une bibliothèque, une étagère, un bureau, des haut-parleurs ou un coffre ou des tables roulantes inadaptés peuvent être renversés et causer des blessures.

## CE FABRICANT SE SOUCIE DE VOTRE SÉCURITÉ !

- L'industrie de l'électronique grand public est vouée à assurer l'utilisation sûre et agréable des systèmes de divertissement au foyer.



**CEA**  
Consumer Electronics Association

[www.CE.org/safety](http://www.CE.org/safety)





# Notices importantes de sécurité

	<b>MISE EN GARDE</b> RISQUE DE CHOC ÉLECTRIQUE NE PAS OUVRIR	
---	--	---

AFIN DE RÉDUIRE LE RISQUE DE CHOC ÉLECTRIQUE, N'ENLEVEZ PAS LE COUVERCLE (OU LE DOS). AUCUNE PIÈCE INTERNE RÉPARABLE PAR L'UTILISATEUR. FAITEZ APPEL À UN TECHNICIEN QUALIFIÉ.

1. Lisez ces instructions.
2. Conservez ces instructions.
3. Respectez tous les avertissements.
4. Suivez toutes les instructions.
5. N'utilisez pas cet appareil à proximité de l'eau.
6. Ne le nettoyez qu'avec un linge sec.
7. Ne bloquez aucune des ouvertures d'aération. Effectuez l'installation conformément aux instructions du fabricant.
8. Ne l'installez pas près de sources de chaleur comme les radiateurs, les corps de chauffe, les fourneaux ou d'autres dispositifs (y compris les amplificateurs) produisant de la chaleur.
9. Ne retirez pas le dispositif de sécurité de la fiche polarisée ou la fiche de terre. Une fiche polarisée comporte deux lames dont l'une est plus large que l'autre. Une fiche de type terre comporte deux lames et une troisième broche de mise à la terre. La lame large et la troisième broche de mise à la terre sont fournies pour votre sécurité. Si la fiche fournie ne convient pas à la prise de courant, consultez un électricien pour remplacer la prise de courant obsolète.
10. Placez le cordon d'alimentation de façon qu'il ne soit pas ni piétiné ni pincé, en particulier au niveau de la fiche, des prises de courant et du point de sortie de l'appareil.
11. N'utilisez que des périphériques / accessoires spécifiés par le fabricant.
12. Ne l'utilisez qu'avec un chariot, un trépied, un support ou une table spécifié par le fabricant ou vendu avec l'appareil. Si vous utilisez un chariot, faites attention lors du déplacement de l'ensemble chariot / appareil S3125A afin d'éviter toute blessure en cas de renversement.
13. Débranchez l'appareil lors en cas d'orages ou quand il ne sera pas utilisé pendant longtemps.
14. Confiez toute réparation au personnel qualifié. Des réparations sont nécessaires si l'appareil est endommagé d'une façon quelconque, tels que le cordon d'alimentation ou fiche endommagé, si du liquide a été renversé ou si les objets ont tombés sur l'appareil, si l'appareil a été exposé à la pluie ou à l'humidité, si l'appareil ne marche pas normalement ou que l'on a fait tomber.
15. Pour réduire le risque d'incendie ou de choc électrique, n'exposez pas cet appareil à la pluie ou à l'humidité.
16. Attention: l'appareil de classe I doit être raccordé à une prise secteur dotée d'une connexion à la terre.



	<p>Le symbole représentant un éclair dans un triangle équilatéral a pour but d'avertir l'utilisateur de la présence d'une tension dangereuse non isolée à l'intérieur du boîtier du produit qui peut être d'intensité suffisante pour constituer un risque de choc électrique.</p>
	<p>Le point d'exclamation dans un triangle équilatéral a pour but d'avertir l'utilisateur de la présence des instructions d'utilisation et de maintenance (entretien) importantes dans la documentation qui accompagne l'appareil.</p>

17. Pour éviter les blessures, cet appareil doit être fixé en toute sécurité au sol / mur conformément aux instructions d'installation.
18. La prise d'alimentation utilisée comme dispositif de déconnexion. Le dispositif de déconnexion doit rester aisément accessible.
19. Gardez votre téléviseur à l'écart de l'humidité. N'exposez pas votre téléviseur à la pluie ou à l'humidité. Si l'eau pénètre dans votre téléviseur, débranchez le cordon d'alimentation et contactez votre revendeur. L'utilisation continue dans ce cas pourrait provoquer un incendie ou de choc électrique.
20. N'exposez pas les piles à une chaleur excessive comme le soleil, un feu ou une chose similaire.
21. Danger d'explosion si la batterie est remplacée de façon incorrecte. Remplacez uniquement avec le même ou équivalent type.

## CONDENSATION:

De l'humidité peut se former dans la partie fonctionnelle de l'unité si celle-ci est transportée d'un milieu froid à un milieu chaud ou si la température de la pièce s'élève subitement. Quand cela survient, le rendement de l'unité peut être compromis. Pour éviter une telle situation, laissez l'unité s'ajuster au nouveau milieu pendant une heure environ avant de la mettre sous tension ou assurez-vous que la température de la pièce s'élève graduellement.

Une condensation peut aussi se former pendant l'été si l'unité est exposée au courant d'air d'un climatiseur. En pareil cas, changez l'emplacement de l'appareil.

## MANIPULATION DU PANNEAU LCD:

- N'appuyez pas fort sur et ne le secouez pas l'écran LCD. Vous risquez de briser le verre de l'écran LCD et de vous blesser. Si l'écran LCD est brisé, faites particulièrement attention de ne pas toucher le liquide dans le panneau. Le liquide peut provoquer une inflammation de la peau.
- Si le liquide entre dans votre bouche, gargarisez-vous immédiatement et consultez votre médecin. Aussi, si le liquide entre en contact avec vos yeux ou la peau, rincez-les pendant environ 15 minutes, ou plus longtemps, à l'eau claire et consultez votre médecin.

## EFFETS NOCIFS POSSIBLES DE L'ECRAN LCD:

Si un motif fixe reste à l'écran LCD pendant une longue période, l'image peut devenir imprégnée en permanence sur l'écran LCD et former une image fantôme subtile, mais permanente. Ce type de dommage n'est **PAS COUVERT PAR LA GARANTIE**. Ne laissez jamais l'écran LCD allumé pendant une longue durée quand il affiche des images de types suivants:

- Les images fixes comme les symboles boursiers, les motifs de jeu vidéo, les logos de stations de télévision et les sites Web.
- Les formats spéciaux qui ne remplissent pas l'écran entier. Par exemple : l'affichage d'image en format panoramique (16:9) sur un écran normal (4:3) (bandes noires en haut et en bas de l'écran) ; ou l'affichage du format normal (4:3) sur un grand écran (16:9) (bandes noires sur la gauche et la droite de l'écran).

**Les signes suivants ne proviennent pas d'un mauvais fonctionnement mais d'une restriction technique. Nous ne pouvons donc pas être tenus responsables pour de tels signes.**

- Les écrans LCD sont fabriqués en utilisant un niveau extrêmement élevé de technologie de précision, cependant il est possible que certains éléments de l'écran peuvent ne pas avoir d'éléments d'image ou affichent des points lumineux. Ceci ne doit pas être considéré comme un signe de mauvais fonctionnement.
- N'installez pas l'écran LCD à proximité d'un équipement électronique qui génère des ondes électromagnétiques car cela pourrait causer une interférence. Certains équipements plaçant tout près de cette unité peuvent provoquer des interférences.
- Effet sur les appareils à infrarouge – il peut y avoir une interférence quand on utilise un appareil à infrarouges comme un téléphone sans fil à infrarouges.

## ENONCE DE CONCORMITÉ

Cet appareil est conforme à la section 15 des règlements de la FCC. Le fonctionnement est soumis à deux conditions suivantes:

- (1) Cet appareil ne peut pas causer d'interférence nuisible et
- (2) cet appareil doit accepter toute interférence reçue, y compris une interférence qui peut entraîner un fonctionnement indésirable.

## Directives sur la fin de vie

Votre téléviseur contient des matériaux qui peuvent être recyclés et réutilisés. Pour plus d'information de mise au rebut ou de recyclage, contactez les autorités locales ou l'Electronic Industries Alliance au [www.eia.org](http://www.eia.org) (pour les États-Unis), l'Association du recyclage des produits électroniques au <http://www.eprassociation.ca> (pour le Canada) dans votre région.

## Pixels inactifs

L'écran LCD compte près de 3 millions de transistors en couches minces fournissant une qualité d'image extrêmement élevée. A l'occasion, des pixels inactifs peuvent apparaître à l'écran sous forme de point fixe noir (pixel mort), bleu, vert ou rouge. Ces pixels inactifs ne nuisent pas au rendement de votre téléviseur et ne sont pas considérés comme des défauts.

## Alimentation électrique

### AVERTISSEMENT:

- Ne branchez pas cette unité sur le bloc d'alimentation à l'aide d'un dispositif autre que le cordon CA fourni. Cela peut provoquer une incendie, un choc électrique ou dommage.
- N'utilisez aucun autre voltage que le voltage spécifié. Cela peut provoquer une incendie, un choc électrique ou dommage.

### MISE EN GARDE:

- Pour des raisons de sécurité, débranchez l'unité de la prise de courant CA si vous prévoyez ne pas l'utiliser pendant une longue période (ex. : voyage).
- Ne branchez/débranchez pas le cordon d'alimentation CA si vous avez les mains mouillées. Cela peut provoquer un choc électrique.

**Aucune source de flamme, telle que des bougies allumées, ne doit être placée sur l'appareil.**

# Fixation d'un montage mural ou pied au téléviseur

Assurez que le téléviseur dispose d'une bonne circulation d'air. Il faut prévoir suffisamment de l'espace libre autour du téléviseur, comme indiqué au-dessous. Evitez d'utiliser le téléviseur à une température inférieure à 41°F (5°C).

## AVERTISSEMENTS:

- Lorsque vous montez votre téléviseur sur le mur ou le placer sur un meuble, maintenez une distance d'au moins 4 pouces entre le téléviseur et d'autres objets (murs, côtés de l'armoire, et ainsi de suite) pour assurer une ventilation adéquate. A défaut de maintenir une bonne ventilation peut causer la surchauffe de la télévision.
- Ne montez pas le téléviseur au plus une inclinaison de 12 degrés.
- N'utilisez pas de vis qui diffèrent de la longueur et de diamètre que nous avons recommandée (voir le manuel de l'utilisateur de Hisense ou le guide de démarrage rapide).
- Ne serrez pas les vis trop fermement. Cela peut endommager le téléviseur ou provoquer sa chute et causer des blessures. Hisense n'est pas responsable de ces types d'accidents.
- Soyez prudent lorsque vous touchez le téléviseur. Certaines pièces peuvent être tiède ou chaude.
- Ne placez pas n'importe quel type de tissu ou du papier en dessous, au-dessus ou à côté du téléviseur. Cela peut bloquer la ventilation et provoquer un incendie.
- Pour des informations détaillées sur l'installation du support mural, consultez la troisième partie des instructions du fabricant ou contactez un installateur professionnel pour avoir de l'assistance.
- N'utilisez pas ou opérez le téléviseur avec les mains mouillées.

## La façon correcte pour attacher au pied de téléviseur La façon correcte pour attacher au mur

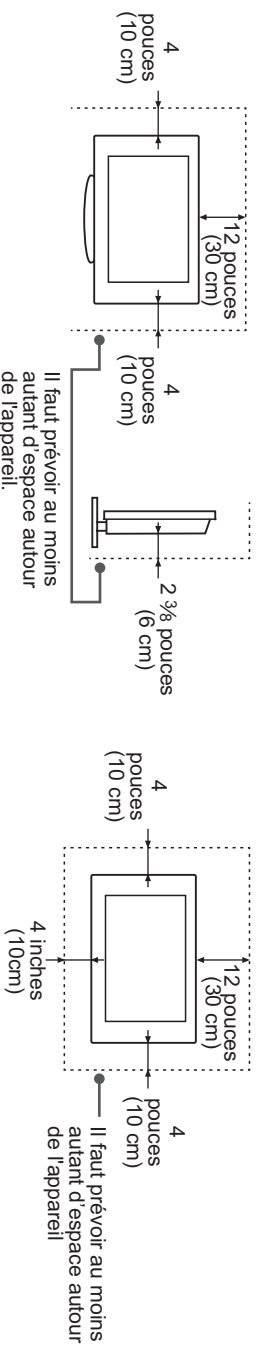

## La façon incorrecte pour attacher a la support de montage mural ou pied de téléviseur

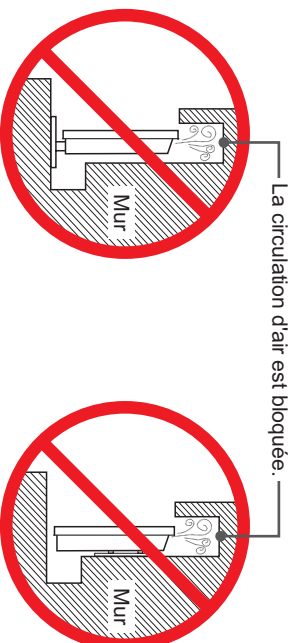

Un manque de circulation de l'air peut surchauffer le téléviseur.

# Hisense

## **Información Importante sobre seguridad y garantía**

Por favor léalo cuidadosamente y guárdelo para futuras referencias.

# SEGURIDAD DE LOS NIÑOS:

Hay una diferencia entre cómo y dónde se utiliza la pantalla plana.

¡Felicitaciones por su compra! Mientras disfruta de su nuevo producto, por favor, tenga presentes estos consejos de seguridad:

## LA EMISION

- La experiencia de entretenimiento de cine en casa es una tendencia creciente y las pantallas planas más grandes cada vez son más populares. Sin embargo, las pantallas planas no son siempre compatibles con los soportes adecuados o instalados de acuerdo a las recomendaciones del fabricante.
- Las pantallas de panel plano que se encuentran instaladas de manera inapropiada en cómodas, libreros, estantes, escritorios, altavoces, cajones o carros pueden caer y causar lesiones.

## ¡NOS IMPORTA!

- La industria de la electrónica de consumo se ha comprometido a ofrecer entretenimiento divertido y seguro.



## LA SEGURIDAD PRIMERO

- Un mismo tamaño no sirve para todos. Siga las recomendaciones del fabricante para la instalación y uso seguro de la pantalla plana.
- Lea y entienda todas las instrucciones adjuntas para el uso adecuado de este producto.
- No permita que los niños se suban o jueguen con los muebles y el televisor.
- No coloque la pantalla plana en muebles que se pueden utilizar como escalera, como un mueble con cajones.
- Recuerde que los niños pueden emocionarse al ver un programa, especialmente en una pantalla plana "muy grande". Se debe tener cuidado de colocar o instalar la pantalla donde no pueda ser empujada, tirada, o golpeada con facilidad.
- Se debe tener cuidado con todos los cables conectados a la pantalla de panel plano para que los niños curiosos no los puedan coger o agarrar.

## MONTAJE EN LA PARED: SI USTED DECIDE MONTAR EN LA PARED SU PANTALLA PLANA, SIEMPRE:

- Utilice un montaje que haya sido recomendado por el fabricante de la pantalla y / o por un laboratorio independiente (tal como UL, CSA, ETL).
- Siga todas las instrucciones suministradas por la pantalla y los fabricantes de montaje en pared.
- Si no está seguro de su capacidad para completar la instalación, póngase en contacto con el fabricante para montaje en pared o con el establecimiento en el que adquirió el televisor.
- Asegúrese de que la pared donde se instalará la pantalla es la adecuada. Algunos soportes de pared no están diseñados para ser montados en las paredes con vigas de acero o estructuras cilíndricas antiguas. Si no está seguro, póngase en contacto con un instalador profesional.
- Se requieren un mínimo de dos personas para la instalación. Las pantallas planas pueden pesar bastante.



**CEA**  
Consumer Electronics Association

[www.CE.org/safety](http://www.CE.org/safety)



# Importantes Instrucciones de Seguridad

	<b>PRECAUCIÓN</b> RIESGO DE DESCARGA ELÉCTRICA NO ABRIR	
<b>PRECAUCIÓN: PARA REDUCIR EL RIESGO DE DESCARGA ELÉCTRICA, NO RETIRE LA CUBIERTA (DELANTERA O TRASERA). NO HAY PIEZAS EN EL INTERIOR QUE EL USUARIO PUEDA REPARAR. SI NECESITA SERVICIO COMUNIQUESE CON PERSONAL CUALIFICADO.</b>		

1. Lea las instrucciones.
2. Guarde estas instrucciones.
3. Respete todas las advertencias.
4. Siga todas las instrucciones.
5. No utilice este aparato cerca del agua.
6. Solo límpielo con un paño seco.
7. No obstruya las rejillas de ventilación. Instale de acuerdo con las instrucciones del fabricante.
8. No lo instale cerca de fuentes de calor tales como radiadores, calefactores, estufas u otros aparatos (incluyendo amplificadores) que produzcan calor.
9. No anule el propósito de seguridad del enchufe polarizado o con toma de tierra. Un enchufe polarizado tiene dos clavijas, una más ancha que la otra. Una toma de tierra tiene dos clavijas y una tercera clavija de tierra. La hoja ancha o la tercera clavija se proporciona para su seguridad. Si el enchufe no encaja en su tomacorriente, consulte a un electricista para reemplazar la toma obsoleta.
10. Proteja el cable de alimentación de ser pisado o pellizcado en particular en los enchufes, tomacorrientes y el punto donde salen del aparato.
11. Use únicamente los dispositivos / accesorios especificados por el fabricante.
12. Use únicamente la carretilla, plataforma, tripode, soporte o mesa especificados por el fabricante, o vendidos con el aparato. Cuando se usa un carro, tenga cuidado al mover la combinación carro / aparato para evitar daños por vuelco. 
13. Desenchufe este aparato durante tormentas eléctricas o cuando no se utilice por largos períodos de tiempo.
14. Solicite el servicio de personal cualificado. Se requiere servicio cuando el aparato ha sido dañado de alguna forma, si el cable de alimentación o el enchufe está dañado, se ha derramado líquido o han caído objetos dentro del aparato, el aparato ha sido expuesto a lluvia o humedad, no funciona con normalidad, o se ha caído.
15. Para reducir el riesgo de incendio o descarga eléctrica, no exponga este aparato a la lluvia ni a la humedad.
16. Advertencia: el aparato con la construcción de Clase I deberá conectarse a un tomacorriente de ALIMENTACIÓN con una conexión de puesta a tierra protectora.



El símbolo con un rayo dentro de un triángulo equilátero pretende alertar al usuario de la presencia de voltaje peligroso sin aislar dentro del gabinete del producto que puede ser de magnitud suficiente para constituir un riesgo de descarga eléctrica.

El signo de exclamación dentro de un triángulo equilátero pretende alertar al usuario de la presencia de importantes instrucciones de uso y mantenimiento (servicio) en la literatura que acompaña al aparato.

17. Para prevenir las lesiones, este aparato debe estar bien sujeto al suelo/pared conforme a las instrucciones de instalación.
18. El enchufe de red se utiliza como dispositivo de desconexión. El dispositivo de desconexión debe estar siempre disponible.
19. Mantenga su TV lejos de la humedad. No exponga su TV a la lluvia ni a la humedad. Si el agua penetra en su TV, desenchufe el cable eléctrico y póngase en contacto con su distribuidor. El uso continuo en este caso puede causar el incendio o la descarga eléctrica.
20. No exponga las pilas al calor como el sol o el fuego.
21. Existe el peligro de explosión si se sustituyen las pilas incorrectamente. Sustitúyalas sólo con el mismo tipo o tipo equivalente.

## CONDENSACIÓN:

La humedad se formará en la sección operativa de la unidad si esta es traída de un lugar frío a una habitación caliente o si la temperatura de la habitación sube repentinamente. Cuando esto sucede, el rendimiento de la unidad se verá afectado. Para prevenirlo, deje la unidad en su nuevo ambiente durante aproximadamente una hora antes de encenderla, o asegurarse de que la temperatura ambiente se eleve gradualmente.

La condensación se puede formar durante el verano si la unidad está expuesta a la brisa de aire acondicionado. En estos casos, cambie la ubicación de la unidad.

## CÓMO MANEJAR EL PANEL LCD:

- No presione con fuerza ni empuje el panel LCD. Puede hacer que el vidrio del panel LCD se rompa y puede ocurrir alguna lesión. Si el panel LCD se rompe, asegúrese absolutamente de no tocar el líquido. Esto puede causar inflamación de la piel.
- Si el líquido entra en la boca, haga gárgaras inmediatamente y consulte con su médico. Además, si el líquido entra en los ojos o toca la piel, consulte con su doctor después de al menos 15 minutos o más de lavar en agua limpia.

## POSIBLES EFECTOS ADVERSOS EN EL PANEL LCD:

Si una imagen fija (sin movimiento) permanece en la pantalla LCD durante largos períodos de tiempo, esta imagen puede convertirse en permanente en el panel LCD y crear una sutil imagen fantasma. Este tipo de daño **NO ESTÁ CUBIERTO POR LA GARANTÍA**. Nunca deje su pantalla LCD encendida durante largos períodos de tiempo mientras está mostrando los siguientes formatos o imágenes:

- Imágenes fijas, tales como cottizaciones de bolsa, patrones de video juegos, logos de estaciones de televisión y sitios web.
- Formatos especiales que no utilizan toda la pantalla. Por ejemplo, el estilo de buzón (16:9) normal (4:3) pantalla (barras de color negro en la parte superior e inferior de la pantalla), o ver el estilo normal (4:3) pantalla ancha (16:9) pantalla (barras de color negro en los lados derecho e izquierdo de la pantalla).

**Los siguientes síntomas no son signos de mal funcionamiento, sino de limitaciones técnicas. Por lo tanto, se rechazarán cualquier tipo de responsabilidades respecto a estos síntomas.**

- Los paneles LCD están fabricados con un altísimo nivel de precisión tecnología, sin embargo a veces algunos elementos de imagen o puntos siempre iluminados pueden fallar. Esto no es un signo de un mal funcionamiento.
- No instale el panel LCD cerca de un equipo electrónico que produce ondas electromagnéticas. Algunos equipos colocados demasiada cerca de la unidad pueden causar interferencias.
- Efectos en los dispositivos infrarrojos - Puede haber interferencias durante el uso de dispositivos infrarrojos, como auriculares inalámbricos.

## DECLARACIÓN DE CONFORMIDAD

Este dispositivo cumple con el apartado 15 de las Normas de la FCC. La operación está sujeta a las siguientes dos condiciones:

- (1) Este dispositivo no debe causar interferencias perjudiciales y
- (2) Este dispositivo debe aceptar cualquier interferencia recibida, incluyendo interferencias que puedan provocar un funcionamiento no deseado.

## Instrucciones del fin de uso

Su televisor contiene también materiales que pueden ser reciclados y reusados. Para la eliminación o reciclaje de información, póngase en contacto con las autoridades locales o con la Alianza de Industrias Electrónicas en [www.eia.org](http://www.eia.org) (para EE.UU.) la Asociación de Reciclaje de Productos Electrónicos en <http://www.eprassociation.ca> (para Canadá) para encontrar un centro de reciclaje en su área.

## Píxeles no activos

El panel LCD contiene casi 3 millones de transistores, que proporcionan una calidad de video excepcionalmente nítida. De vez en cuando, algunos píxeles no activos pueden aparecer en la pantalla como un punto fijo de color negro (en caso de un píxel muerto), azul, verde o rojo. Estos píxeles no activos no afectan negativamente el rendimiento de su televisor y no se consideran defectuosos.

## Fuente de alimentación

### ADVERTENCIA:

- No conecte esta unidad utilizando otro dispositivo que no sea el cable de alimentación de CA proporcionado. Hacerlo podría provocar incendios, descargas eléctricas u otros daños.
- No lo utilice con una tensión distinta a la tensión de alimentación especificada. Hacerlo podría provocar incendios, descargas eléctricas u otros daños.

### PRECAUCIÓN:

- Cuando esta unidad no sea utilizada por un largo periodo de tiempo, (por ejemplo, en un viaje) en el interés de la seguridad, asegúrese de desconectarlo de la toma de CA.
- No conecte / desconecte el cable de CA si sus manos están mojadas. Esto puede causar una descarga eléctrica.

**No fuentes inflamables, como unas velas encendidas, deben ponerse sobre el aparato.**

# Sujetar un Montaje de la Pared o Soporte al TV

Asegúrese de que su televisor tiene buena circulación de aire. Deje suficiente espacio alrededor del televisor como se muestra a continuación. Evite utilizar el televisor a temperaturas menores de 41 ° F (5 ° C).

## ADVERTENCIA:

- Cuando usted monta su TV en la pared o lo coloca en los muebles, mantenga una distancia de al menos 4 pulgadas entre el TV y otros objetos (paredes, laterales del armario, etc.) para asegurar la ventilación apropiada. El no cumplir el mantenimiento de una ventilación apropiada puede hacer que el TV se recaliente.
- No monte el TV con más de 12 grados de inclinación.
- No use tornillos que difieren de la longitud y el diámetro que hemos recomendado (Consulte el manual del usuario Hisense o la Guía de inicio rápido).
- No apriete los tornillos demasiado firmemente. Se puede dañar el TV o provocar que se caiga, produciendo lesiones personales. Hisense no se hace responsable de estos tipos de accidentes.
- Tenga cuidado cuando usted toque el TV. Algunas partes pueden estar calientes.
- No coloque ningún tipo de tela o papeles por debajo, en la parte superior, o al lado del TV. Se puede bloquear la ventilación y causar un incendio.
- Para obtener la información detallada sobre la instalación del soporte de montaje en pared, véase las instrucciones del fabricante de tercero o póngase en contacto con un instalador profesional para obtener la ayuda.
- No opere ni manipule el TV con manos mojadas.

## Forma correcta de sujetar un soporte de TV

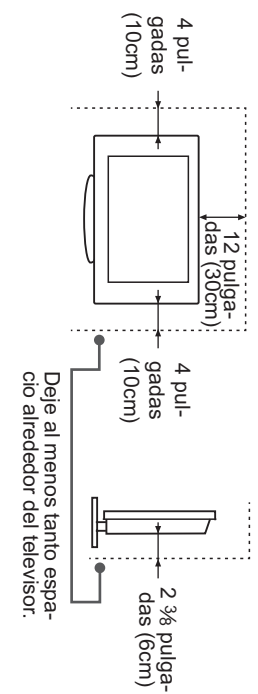

## Forma correcta de sujetar en la pared

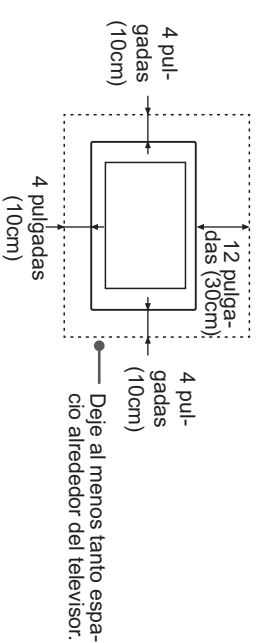

## La circulación de aire inadecuada puede hacer que el TV sobrecaliente.

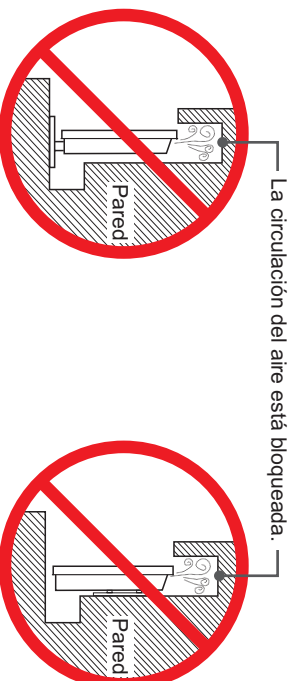

La circulación de aire inadecuada puede hacer que el TV sobrecaliente.



## Limited Warranty for Hisense TV's

**IMPORTANT:** In case the TV may need to be serviced, keep the original packaging materials and original receipt.

This Limited Warranty for Hisense Branded Products (including any accessories that came with the packaging) as supplied and distributed is warranted by **Hisense USA Corporation** ("Hisense") to the **ORIGINAL PURCHASER** against defects in materials and workmanship ("Warranty") as follows:

### 1. LABOR

Labor will be covered for a period of 1 year from the date of ORIGINAL CUSTOMER PURCHASE for TV models that are smaller than 50 inches.

Labor will be covered for a period of 2 years from the date of ORIGINAL CUSTOMER PURCHASE for TV models that are 50 inches and larger. If HISENSE (or a HISENSE authorized service provider) determines that the Product—or any functional part—is defective, then:

- HISENSE will repair or replace the Product with a **like refurbished product of similar or better quality** at no charge to the original purchaser OR
- Pay the labor charges to any HISENSE authorized service provider

After the Warranty period has expired, then the purchaser is responsible for all labor charges.

### 2. PARTS

Parts will be covered for a period of 1 year from the date of ORIGINAL CUSTOMER PURCHASE for TV models that are smaller than 50 inches.

Parts will be covered for a period of 2 years from the date of ORIGINAL CUSTOMER PURCHASE for TV models that are 50" and larger. HISENSE will supply (at no charge to the original purchaser) new, rebuilt or refurbished replacement functional parts in exchange for defective functional parts.

After the Warranty period has expired, then the purchaser is responsible for the costs of all parts.

### 3. 3D GLASSES AND REMOTE

HISENSE will repair or replace the accessory with a **like refurbished product of similar or better quality** (at HISENSE's option) for a period of 90 days. After the 90-day warranty period has expired, then the purchaser is responsible for all charges.

### 4. ON-SITE SERVICE

On-site service requires that an authorized servicer be given clear, complete and easy access to the product. On-site service does not include that the servicer remove or reinstall the product.

It is possible that certain on-site repairs will need to be completed off site and at Hisense's discretion, require that the product be shipped directly to our warehouse. Once we receive the product and repair or replace it, Hisense will return the repaired/replaced product back.

### Warranty Service and Troubleshooting Information for Customers in the United States and Puerto Rico

To obtain warranty service and troubleshooting information, contact our **Consumer Electronics Care Center**.  
Call 1-888-935-8880 (Monday–Friday from 9 a.m. - 9 p.m. EST; Saturday–Sunday from 9 a.m. - 6 p.m.) or Email  
[service@hisense-usa.com](mailto:service@hisense-usa.com)

# Warranty for USA

## REQUIREMENTS THAT MUST BE MET TO RECEIVE WARRANTY SERVICE

To receive Warranty service, the ORIGINAL PURCHASER or SALES AGENT must contact HISENSE to determine the problem and service procedures. Proof of purchase in the form of an ORIGINAL BILL OF SALE or RECEIPTED INVOICE that shows evidence the product is within the applicable Warranty period(s), must be presented (to HISENSE or an authorized service provider), in order to obtain the requested service.

## EXCLUSIONS AND LIMITATIONS

This Warranty covers manufacturing defects in materials and workmanship encountered in the normal use of the Product and does not cover consumer instruction, delivery, installation, setup, adjustments, signal reception problems (including antenna), availability of third-party provided services or content (including, without limitation, image, audio or video content), cosmetic damage or damage due to acts of nature, accident, misuse, abuse, negligence, commercial use or modification of, (or to any part) of the Product. In addition, this Warranty does not cover images "burnt" into the screen. This Warranty applies to the ORIGINAL PURCHASER ONLY and does not cover products sold 'AS IS', 'WITH ALL FAULTS' or consumables (for example, fuses, batteries, bulbs and so on). This Warranty is invalid if the factory-applied serial number has been altered or removed from the product.

This Warranty is only valid in the United States and Puerto Rico and only applies to products purchased and serviced in the United States and Puerto Rico.

.....

THERE ARE NO EXPRESS WARRANTIES OTHER THAN THOSE EXPRESSLY DESCRIBED ABOVE AND NO WARRANTIES (WHETHER EXPRESS OR IMPLIED) INCLUDING BUT NOT LIMITED TO ANY IMPLIED WARRANTIES OF MERCHANTABILITY OR FITNESS FOR A PARTICULAR PURPOSE SHALL APPLY AFTER THE EXPRESS WARRANTY PERIOD STATED ABOVE, AND NO OTHER EXPRESS WARRANTY OR GUARANTY GIVEN (BY ANY PERSON, FIRM OR ENTITY WITH RESPECT TO THE PRODUCT) SHALL BE BINDING ON HISENSE. THIS WARRANTY IS THE EXCLUSIVE WARRANTY WITH RESPECT TO THE PRODUCT AND HISENSE IS THE EXCLUSIVE WARRANTY PROVIDER FOR THE PRODUCT. REPAIR OR REPLACEMENT IS THE EXCLUSIVE REMEDY OF THE CONSUMER. HISENSE SHALL NOT BE LIABLE FOR ANY INCIDENTAL OR CONSEQUENTIAL DAMAGES CAUSED BY THE USE, MISUSE OR INABILITY TO USE THE PRODUCT. NOTWITHSTANDING THE FOREGOING, CONSUMER'S RECOVERY AGAINST HISENSE SHALL NOT EXCEED THE PURCHASE PRICE OF THE PRODUCT SOLD BY HISENSE. THIS WARRANTY SHALL NOT EXTEND TO ANYONE OTHER THEN THE ORIGINAL PURCHASER WHO PURCHASED THE PRODUCT AND IS NOT TRANSFERABLE.

Some states do not allow the exclusion or limitation of incidental or consequential damages or allow limitations on warranties; therefore, the limitations or exclusions stated above may not apply to you. This Warranty gives you specific rights and you may have other rights, which vary from state to state.

## CUSTOMER RECORD (Please Retain for your records)

Date of Purchase: ..... Store/Dealer: .....

Model No.: ..... Serial No.: .....

## Garantía Limitada para Hisense TV

**IMPORTANTE:** En caso de que el TV necesite ser reparado, guarde los materiales originales de embalaje y el recibo original.

La Garantía Limitada de Producto de Marca Hisense (incluyendo cualquier accesorio incluido en el embalaje) suministrado y distribuido está garantizada por Hisense USA Corporation ("Hisense") al comprador original contra defectos en materiales y mano de obra ("Garantía") de la siguiente manera:

### 1. MANO DE OBRA

La mano de obra quedará cubierta por un periodo de 1 año desde la fecha de la COMPRA DEL CLIENTE ORIGINAL para los modelos de TV que son más pequeños que 50 pulgadas.

La mano de obra quedará cubierta por un periodo de 2 años desde la fecha de la COMPRA DEL CLIENTE ORIGINAL para los modelos de TV que son 50 pulgadas y más grandes. Si HISENSE (o un proveedor de servicio autorizado por HISENSE) determina que el Producto - o cualquier pieza funcional - es defectuoso, entonces:

- HISENSE reparará o sustituirá el Producto por un producto restaurado de calidad similar o mejor gratuitamente al comprador original O
- Pagará los gastos de mano de obra a cualquier proveedor de servicio autorizado por HISENSE.

Una vez que haya expirado el período de Garantía, el comprador será responsable de todos los gastos de mano de obra.

### 2. PIEZAS

Las piezas quedarán cubiertas por un periodo de 1 año desde la fecha de la COMPRA DE CLIENTE ORIGINAL para los modelos de TV que son más pequeños que 50 pulgadas.

Las piezas quedarán cubiertas por un periodo de 2 años desde la fecha de la COMPRA DE CLIENTE ORIGINAL para los modelos de TV que son 50 " y más grandes. HISENSE suministrará (gratuitamente al comprador original) las piezas funcionales de recambio nuevas, reconstruidas o restauradas a cambio de las piezas funcionales defectuosas. Una vez que haya expirado el período de Garantía, el comprador será responsable de los gastos de todas las piezas.

### 3. GAFAS 3D Y CONTROL REMOTO

HISENSE reparará o sustituirá el **accesorio por un producto como el restaurado de calidad similar o mejor** (en la opción del HISENSE) para un periodo de 90 días. Una vez que el período de 90 días de la garantía haya expirado, el comprador será responsable de todos los gastos.

### 4. SERVICIO IN SITU

El servicio in situ requiere que se preste al proveedor de servicio autorizado el acceso claro, completo y fácil al producto. El servicio in situ no incluye que el proveedor de servicio quite o reinstale el producto.

Es posible que cierta reparación in situ tenga que ser completada fuera del sitio y en la discreción de Hisense, se requerirá que el producto sea enviado directamente a nuestro almacén. Una vez que recibamos el producto, se le reparará o sustituirá, entonces Hisense devolverá el producto reparado/sustituido.

### Información de Servicio de Garantía Y Soluciones de Problemas para Los Clientes en Los Estados Unidos y Puerto Rico

Para obtener la información de servicio de garantía y soluciones de problemas, contacte con nuestro Centro de Atención al Cliente Electrónico. Llame a 1-888-935-8880(Lunes-Viernes, desde 9 a.m. a 9 p.m. EST; sábado y domingo, de 9 a.m. a 6 p.m.) o mande email a [service@hisense-usa.com](mailto:service@hisense-usa.com).

## REQUISITOS QUE DEBEN CUMPLIR PARA RECIBIR SERVICIO DE LA GARANTÍA

Para recibir el servicio de Garantía, el COMPRADOR ORIGINAL o el AGENTE DE VENTAS deben ponerse en contacto con HISENSE para determinar el problema y los procedimientos de servicio. La prueba de compra en forma de una FACTURA ORIGINAL DE VENTA o una FACTURA DE PAGO que evidencia que el Producto está dentro del período aplicable de Garantía, se debe presentar (a HISENSE, o a un proveedor de servicio autorizado), a fin de obtener el servicio solicitado.

## EXCLUSIONES Y LIMITACIONES

Esta garantía cubre los defectos de fabricación en materiales y mano de obra bajo el uso normal del producto, y no cubre la instrucción de los consumidores, la entrega, la instalación, la configuración, los ajustes, los problemas de recepción de señal (incluyendo la antena), la disponibilidad de los servicios prestados de terceros o contenido (incluyendo, sin limitación, imagen, audio o vídeo), daños superficiales, los daños debidos a causas de fuerza mayor, accidentes, mal uso, abuso, negligencia, uso comercial o modificación del Producto. Además, esta Garantía no cubre las imágenes "quemadas" en la pantalla. Esta Garantía se aplica sólo al comprador original y no cubre los productos vendidos TAL CUAL O CON TODOS LOS DEFECTOS, o bienes consumibles (por ejemplo, fusibles, baterías, bombillas, etc.). Dicha Garantía es inválida si el número de serie de la fábrica aplicado ha sido cambiado o quitado del Producto. Esta Garantía es válida sólo en los Estados Unidos y Puerto Rico, y sólo se aplica a Productos comprados y servidos en los Estados Unidos y Puerto Rico.

NO HAY GARANTÍAS EXPRESAS QUE NO SEAN AQUELLOS EXPRESAMENTE DESCRITOS ARRIBA, Y GARANTÍAS NO EXPRESAS O IMPLÍCITAS, INCLUYENDO, PERO NO LIMITADAS A, CUALQUIER GARANTÍA IMPLÍCITA DE COMERCIALIZACIÓN O IDONEIDAD PARA UN OBJETIVO PARTICULAR, SE APLICARÁ DESPUÉS DEL PERÍODO DE GARANTÍA INDICADO ANTERIORMENTE, Y NINGUNA OTRA GARANTÍA EXPRESA O GARANTÍA DADA (POR CUALQUIER PERSONA, FIRMA O ENTIDAD CON RESPECTO AL PRODUCTO) PERTENECERÁ A HISENSE. ESTA GARANTÍA ES LA GARANTÍA EXCLUSIVA CON RESPECTO AL PRODUCTO Y HISENSE ES EL PROVEEDOR EXCLUSIVO DE GARANTÍA PARA EL PRODUCTO. LA REPARACIÓN O EL REEMPLAZO ES EL REMEDIO EXCLUSIVO DEL CONSUMIDOR. HISENSE NO SE HACE RESPONSABLE DE NINGÚN DAÑO Y PERJUICIOS DIRECTOS O INDIRECTOS CAUSADOS POR EL USO, EL MAL USO O LA INHABILIDAD DE USO DEL PRODUCTO. NO OBSTANTE EL ANTERIOR, LA RECUPERACIÓN DEL CONSUMIDOR CONTRA HISENSE NO DEBERÁ EXCEDER EL PRECIO DE COMPRA DEL PRODUCTO VENDIDO POR HISENSE. ESTA GARANTÍA NO SE EXTENDERÁ A NADIE QUE NO SEA EL COMPRADOR ORIGINAL QUE COMPRÓ EL PRODUCTO Y NO ES TRANSFERIBLE.

Algunos estados no permiten la exclusión o la limitación por daños y perjuicios incidentales o consecuentes, o no permiten las limitaciones en garantías; por lo tanto, los estados susodichos de limitaciones o exclusiones pueden no aplicar a usted. Esta Garantía le da derechos específicos, y usted puede tener otros derechos, que varían de un estado al otro estado.

## REGISTRO DE CLIENTE (Por favor Conserve para sus registros)

Fecha de Compra: ..... Tienda/Distribuidor: .....

Número de Modelo: ..... Número de Serie: .....



## Warranty for Canada

### HISENSE LCD TV's Limited WARRANTY TO ORIGINAL PURCHASER LCD - LED TV

#### Up to 32" - carry or ship in service only 37" and above-On-Site service

The Warranty for Hisense Branded Product (including any accessories included in the packaging) as supplied and distributed is warranted by **Hisense Canada Co. Ltd** ("Hisense") to the original purchaser against defects in material and workmanship ("Warranty") as follows:

- LABOR:** For a period of one year from date of original customer purchase, if this Product or any functional part is determined by HISENSE, or a HISENSE authorized service provider, to be defective, HISENSE will repair or replace the Product, at HISENSE's option, at no charge to the original purchaser, or pay the labor charges to any HISENSE authorized service provider.  
After the expiration of the one year Warranty period, purchaser is responsible for all labor charges.
- PARTS:** For a period of one year from the date of original customer purchase, HISENSE will supply, at no charge to the original purchaser, replacement functional parts in exchange for defective functional parts. After the one year Warranty period, purchaser is responsible for the costs of all parts.
- TRANSPORTATION:** Customer assumes responsibility for all transportation or shipping charges of product to Hisense Service Center. Hisense is not responsible for damages that occur due to improper packaging and shipping of your unit to Hisense Service Center. During the aforementioned warranty period, Hisense will pay the cost of shipping the TV back to the consumer at Hisense expense. Any damages that arise due to the return shipment will be the responsibility of Hisense. Product 32" or below are not eligible for in-home service.
- On-Site SERVICE:** On-site service requires clear, complete and easy access to the product by the authorized servicer and does not include removal or re-installation of an installed product. It is possible that certain on site repairs will not be completed on-site, but will require that the product or parts of the product, at the servicer's discretion be removed for shop diagnosis and/or repair and then returned.

#### To obtain Warranty Service and Troubleshooting information:

Call our Electronics Consumer Care Center at 1-855-344-7367  
or Email [canadasupport@hisense.com](mailto:canadasupport@hisense.com) in Canada.

To receive Warranty service, the original purchaser or sales agent must contact HISENSE for problem determination and service procedures. Proof of purchase in the form of an original bill of sale or receipted invoice, evidencing that the Product is within the applicable Warranty period(s), MUST be presented to HISENSE, or an authorized service provider, in order to obtain the requested service.

**Exclusions and Limitations:** This Warranty covers manufacturing defects in materials and workmanship encountered in the normal use of the Product, and does not cover consumer instruction, delivery, installation, set-up, adjustments, signal reception problems (including antenna), cosmetic damage or damage due to acts of nature, accident, misuse, abuse, negligence, commercial use or modification of, or to any part of the product. In addition, this Warranty does not cover images "burnt" into the screen. This Warranty applies to the original purchaser only and does not cover products sold AS IS or WITH ALL FAULTS, or consumables (e.g., fuses, batteries, bulbs etc.), and the Warranty is invalid if the factory-applied serial number has been altered or removed from the Product. This Warranty is valid only in Canada Only, and only applies to Products purchased and serviced in Canada Only.

**THERE ARE NO EXPRESS WARRANTIES OTHER THAN THOSE EXPRESSLY DESCRIBED ABOVE, AND NO WARRANTIES WHETHER EXPRESS OR IMPLIED, INCLUDING, BUT NOT LIMITED TO, ANY IMPLIED WARRANTIES OF MERCHANTABILITY OR FITNESS FOR A PARTICULAR PURPOSE, SHALL APPLY AFTER THE EXPRESS WARRANTY PERIOD STATED ABOVE, AND NO OTHER EXPRESS WARRANTY OR GUARANTEE GIVE BY ANY PERSON, FIRM OR ENTITY WITH RESPECT TO THE PRODUCT SHALL BE BINDING ON HISENSE. THIS WARRANTY IS THE EXCLUSIVE WARRANTY WITH RESPECT TO THE PRODUCT AND HISENSE IS THE EXCLUSIVE WARRANTY PROVIDER FOR THE PRODUCT. REPAIR OR REPLACEMENT IS THE EXCLUSIVE REMEDY OF THE CONSUMER. HISENSE SHALL NOT BE LIABLE FOR ANY INCIDENTAL OR CONSEQUENTIAL DAMAGES CAUSED BY THE USE, MISUSE OR INABILITY TO USE THE PRODUCT. NOTWITHSTANDING THE FOREGOING, CONSUMER'S RECOVERY AGAINST HISENSE SHALL NOT EXCEED THE PURCHASE PRICE OF THE PRODUCT SOLD BY HISENSE. THIS WARRANTY SHALL NOT EXTEND TO ANYONE OTHER THAN THE ORIGINAL PURCHASER WHO PURCHASED THE PRODUCT AND IS NOT TRANSFERABLE..**

### CUSTOMER RECORD

(Please Retain for your records)

Date of Purchase: \_\_\_\_\_ Store/Dealer: \_\_\_\_\_

Model No.: \_\_\_\_\_ Serial No.: \_\_\_\_\_

**Important:** Keep all original products packaging materials and *the original receipt* in the event Product needs service.

## Garantie pour le Canada

### HISENSE LCD TV's Limited GARANTIE POUR ACHETEUR ORIGINAL TV LCD - LED

#### Jusqu'à 32" – Service de transporter ou d'expédier seulement 37" et au-dessus – Service sur place

La garantie qui s'applique au produit Hisense fourni et distribué (y compris tous les accessoires inclus dans l'emballage) est promise par Hisense Canada Corp. («Hisense») à l'acheteur original contre les défauts de matériaux et de fabrication («Garantie») comme suit:

- 1. MAIN-DOEUVRE:** Pendant une période d'un an à compter de la date de l'achat initial, si ce produit ou une partie fonctionnelle s'avère défectueux par HISENSE, ou par un fournisseur de services autorisé par HISENSE, HISENSE procédera à la réparation ou au remplacement du produit par un produit similaire renoué de qualité similaire, à l'appréciation de HISENSE, sans frais pour l'acheteur d'origine, ni charge de main-d'œuvre à tout fournisseur de service autorisé par HISENSE. Après l'expiration de la période de garantie d'un an, l'acheteur est à la charge de tous les frais de main-d'œuvre.
- 2. PIÈCES:** Pour une période d'un an à compter de la date de l'achat initial, HISENSE fournira, gratuitement à l'acheteur original, des pièces rechanges fonctionnelles en échange de pièces défectueuses fonctionnelles. Hors de la période de garantie d'un an, l'acheteur est responsable pour les coûts de toutes les pièces.
- 3. TRANSPORT:** Le client assume la responsabilité de tous les frais de transport ou d'expédition de produit au centre de service de Hisense. Hisense n'est pas responsable des dommages occasionnés en raison de l'emballage et de l'expédition inappropriés de votre part au centre de service de Hisense. Au cours de la période de garantie précitée, Hisense prendra en charge le coût de l'expédition du téléviseur au consommateur. Les dommages qui surviennent en raison de l'expédition seront à la charge du Hisense. Produit de 32" ou au-dessus ne sont pas admissibles pour le service à domicile.
- 4. Service à domicile:** Le service à domicile réclame un accès clair, complet et facile au produit par le fournisseur de service autorisé et ne comprend pas l'enlèvement ou la réinstallation d'un produit installé. Il est possible que certains réparations ne seront pas achevés sur place, il faudra pourtant que le produit ou des parties du produit, à la discrétion du prestataire de service soient retirés pour le diagnostic à boutique et / ou pour la réparation, puis retournés.

#### Pour bénéficiaire de cette garantie et informations de dépannage:

**Appelez notre centre de service à la clientèle d'électronique au 1-855-344-7367  
ou écrivez nous par méil: [canadasupport@hisense.com](mailto:canadasupport@hisense.com) au Canada.**

Pour bénéficier du service de garantie, l'acheteur original ou l'agent de vente doit communiquer avec HISENSE pour déterminer le problème et les procédures de service. Une preuve d'achat sous la forme d'une facture d'origine de vente ou d'un reçu acquitté, attestant que le produit est dans la période de garantie applicable (s), doit être présentée à HISENSE, ou à un fournisseur de services autorisé, afin d'obtenir le service demandé.

**Exclusions et Restrictions:** Cette garantie couvre les défauts des matériaux et de fabrication occasionnés dans l'utilisation normale du Produit, et ne couvre pas les instructions du consommateur, la livraison, l'installation, la mise en place, les ajustements, les problèmes de réception de signaux (y compris l'antenne), les détériorations esthétiques ou les détériorations causées par les actes de la nature, par l'accident, par l'abus, par la négligence, par l'utilisation commerciale ou par la modification, ou n'importe quelle partie du produit. En outre, cette garantie ne couvre pas les images "brûlées" dans l'écran. Cette garantie s'applique seulement à l'acheteur original et ne couvre pas les produits vendus TEL QUEL ou AVEC TOUTS LES DÉFAUTS, ou les consommables (par exemple, fusibles, piles, ampoules, etc), et la garantie est annulée si le numéro de série appliqué par usine a été modifié ou enlevé du produit. Cette garantie est valable uniquement au Canada, et s'applique seulement aux produits achetés et entretenus au Canada.

**IL N'EXISTE AUCUNE GARANTIE EXPRESSE AUTRE QUE CELLES EXPRESSÉMENT CI-DESSUS NI GARANTIE EXPRESSE OU IMPLICITE, Y COMPRIS, MAIS SANS S'Y LIMITER, TOUTE GARANTIE IMPLICITE DE QUALITÉ MARCHANDE OU D'ADEQUATION A UNE FIN PARTICULIERE, NE S'APPLIQUE APRES LA PERIODE DE GARANTIE EXPRESSE CI-DESSUS, ET AUCUNE D'AUTRE GARANTIE EXPRESSE OU GARANTIE LIVREE PAR TOUTE PERSONNE, ENTREPRISE OU ENTITÉ EN CE QUI CONCERNE LE PRODUIT N'EST OBLIGATOIRE SUR HISENSE. CETTE GARANTIE EST LA SEULE GARANTIE EN CE QUI CONCERNE LE PRODUIT ET HISENSE EST LE FOURNISSEUR EXCLUSIVE DE SERVICE POUR LE PRODUIT. LA REPARATION OU LE REMPLACEMENT EST LA SEULE REMEDE POUR LES CONSOMMATEURS. HISENSE NE SERA PAS RESPONSABLE DES DOMMAGES DIRECTES OU INDIRECTS RESULTANT DE L'UTILISATION, DE LA MAUVAISE UTILISATION OU DE INCAPACITE D'UTILISER LE PRODUIT. TOUTEFOIS, RECUPERATION DES CONSOMMATEURS CONTRE HISENSE NE DOIT PAS DEPASSER LE PRIX PAYE POUR LE PRODUIT VENDU PAR HISENSE. CETTE GARANTIE N'EST VALABLE POUR AUCUNE PERSONNE AUTRE QUE L'ACHETEUR D'ORIGINE AVANT ACHETER LE PRODUIT ET N'EST PAS TRANSMISSIBLE.**

## RECORD DU CLIENT

(Veuillez le garder pour vos enregistrements)

Date d'Achat : \_\_\_\_\_ Magasin / Distributeur : \_\_\_\_\_

Modèle No: \_\_\_\_\_ Numéro de série : \_\_\_\_\_

**Important:** Gardez toutes matières originales d'emballage de produits et le reçu original pour le besoin de service ultérieurement.