

# Hisense • Roku TV

## H4 Series



## Quick Start Guide

Help Hisense improve the environment by reducing paper waste.  
For detailed instructions and feature descriptions, access the full  
User Manual online at [www.hisense-usa.com/support](http://www.hisense-usa.com/support).

# Your easiest way to endless entertainment

Connect now to get the most out of your Hisense • Roku® TV



## Choose & personalize

Personalize your Home screen with broadcast TV, your favorite 1500+ streaming channels, your game console and other devices.



## Control with ease

Control your Hisense • Roku TV with the super simple remote, your smartphone or tablet.



## Search

Find movies and TV shows across top streaming channels,\* sorted so you can choose the best option or value.



## Cast media

Send video, music and photos from your smartphone or tablet to the big screen.

\*Roku® Search is for movies and TV shows and does not work with all channels.

# Get the most out of your Hisense • Roku TV

Congratulations on your new Hisense • Roku TV! This Quick Start Guide will walk you through a few easy steps to get your TV set up, start streaming over 1,500 streaming channels, and much more. For more details about setup and features of your new TV, access the online *Hisense • Roku TV User Manual* at [www.hisense-usa.com/support](http://www.hisense-usa.com/support).

To access the user manual, you will need to enter your model number located on the side and back of the TV or on the outside of the box.

From the **Support** page, you can also:

- Access Frequently Asked Questions
- Download the latest firmware for your TV
- Order accessories
- Access warranty information

To speak to a representative in our Electronics Consumer Care Center, call 1-888-935-8880 Monday through Friday from 8 A.M. to 8 P.M. EST and Saturday through Sunday from 9 A.M. to 6 P.M. EST.

You can also send an email to [Service@hisense-usa.com](mailto:Service@hisense-usa.com).

*This Quick Start Guide is intended as a general guideline to help you set up your Hisense • Roku TV. Images throughout this document are for illustrative purposes only and may differ from the actual product.*

# Register your TV to receive Hisense news

Because we value your business, we want to keep you in the know of 'all things Hisense'. Using your mobile phone, scan the first QR code to register your TV and the second QR code to access the **Support** page. Depending on the make and model of your phone, you may need to download a QR code scanning application. You can also access the **Product Registration** or **Support** page by visiting [www.hisense-usa.com/support/productreg](http://www.hisense-usa.com/support/productreg) or [www.hisense-usa.com/support](http://www.hisense-usa.com/support).



Registration page QR code



Support page QR code

## Packaged contents

Your package in which you purchased your new TV contains the following items:

- Hisense • Roku TV
- Stand cover
- TV base
- Power cord
- *Hisense • Roku TV Quick Start Guide* (this document)
- *Important Safety Information and Warranty Card* leaflet
- 2 AAA batteries
- Hisense • Roku TV remote
- 8 Phillips screws (total): 4 (M5x12mm) and 4 (ST4x16mm)

**IMPORTANT:** Look inside the styrofoam (within the upper and bottom parts of the box) to make sure that you have removed all items that come with the TV.

## Required tools and devices

- Phillips screwdriver (not included) to attach the TV stand
- Wireless router (not included) for Internet connectivity

# Buttons and ports on the Hisense • Roku TV

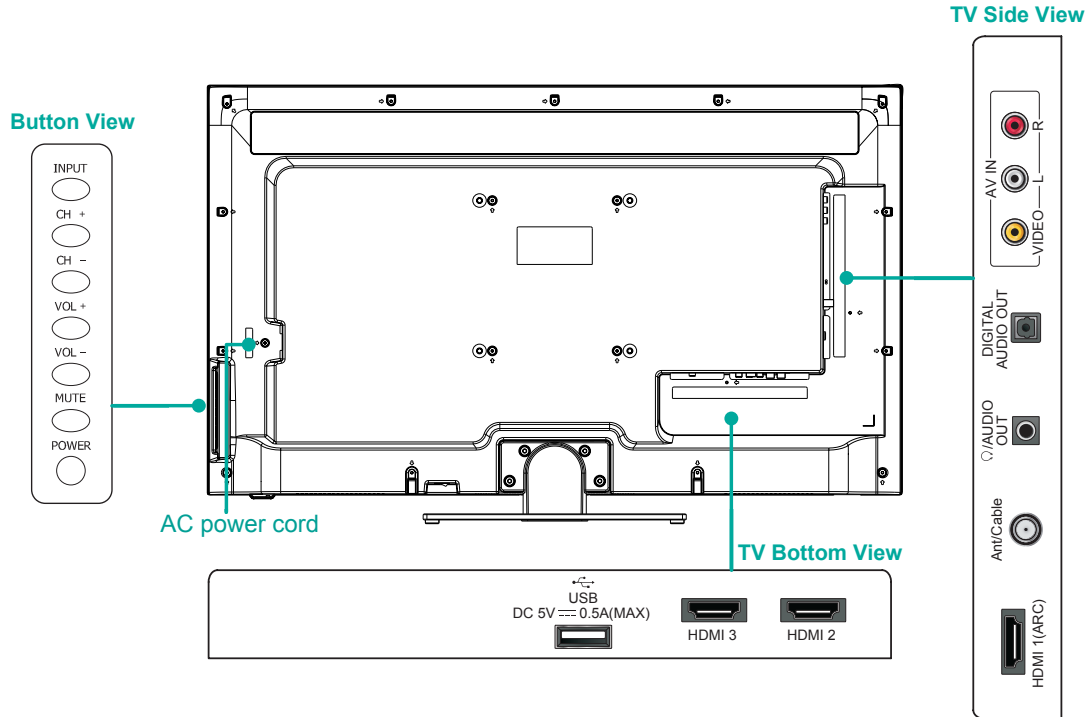

# STEP 1. Attach the TV stand or wall mount bracket (not included)

For steps to attach the wall mount see page 7.

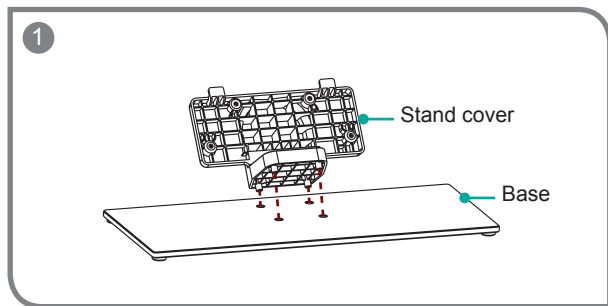

Insert the stand cover into the base as shown.

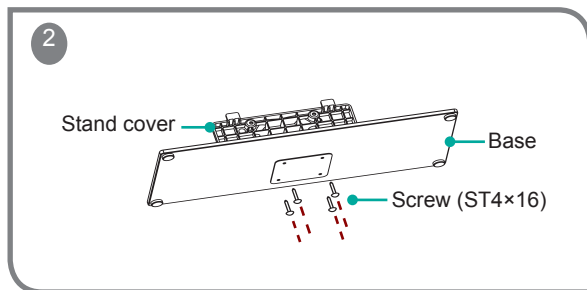

Secure the stand cover to the base with 4 screws (ST4×16).

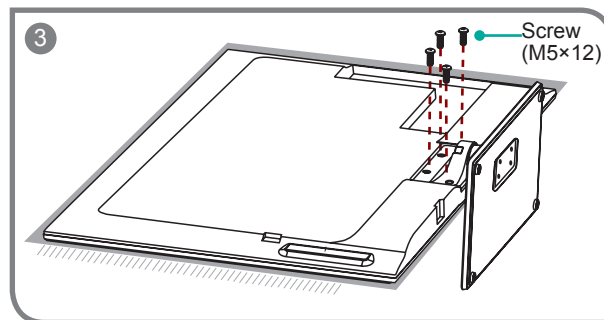

Place the TV face down on a soft surface and secure the stand to the TV with the 4 (M5×12) screws.

## Install the wall mount bracket (not included)

If you wish to mount the TV on a wall, you must purchase a wall mount bracket separately. However, before you begin the manufacturer's instructions be sure to:

1. Remove the TV stand if you already attached it.
2. Place the TV face down on a clean, safe and cushioned surface.
3. Place the spacers (not included) in the corresponding bracket holes.

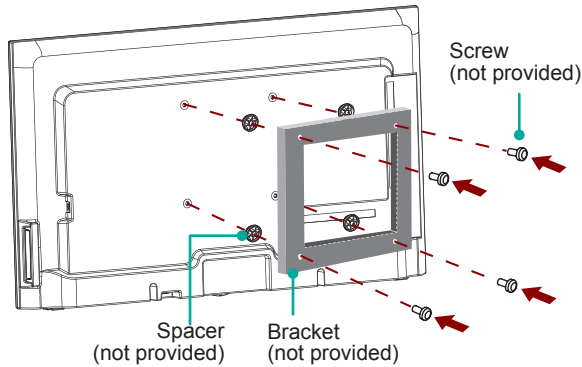

### CAUTION:

- When attaching the wall mount, use the spacers (provided by the third-party manufacturer) between the TV and the bracket.

- To prevent internal damage to the TV and ensure it is mounted securely, use fixing screws (not provided) that are 9.5-11.5 mm in length when measured from the attaching surface of the mounting hook.

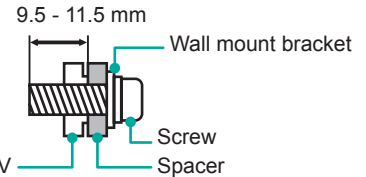

Wall mount hole pattern VESA (mm)	400 x 400
Wall mount screw size (mm)	M6









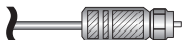
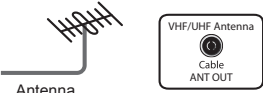

Follow instructions provided with the wall mount bracket.

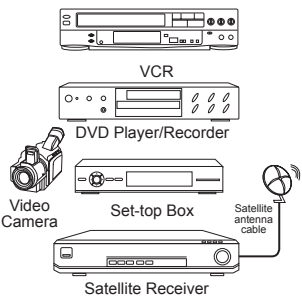
- If you are not sure of your ability to complete the installation, contact a professional installer or service technician for assistance. Hisense is not responsible for any damages or injuries that occur due to mishandling or incorrect assembly.
- The selected screws are 9.5-11.5 mm in length when measured from the attaching surface of the TV rear cover.

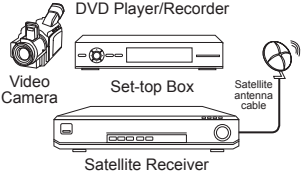

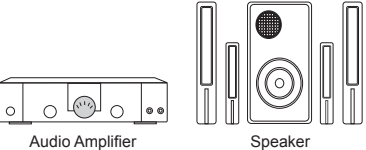

**Note:** The diameter and length of the screws differ depending on the wall mount bracket model.

## STEP 2. Connect devices to your TV

Check to ensure that you have selected the right cables for the ports and that they are connected securely. Loose connections can affect the quality of the picture image and color.

TV label		Port	Cable	External Equipment	Brief Description
ANT/CABLE				 <p>Antenna</p>	Connect an outdoor or indoor antenna.
HDMI				 <p>VCR DVD Player/Recorder Video Camera Set-top Box Satellite Receiver</p>	Connect a High Definition Multimedia Interface (HDMI) cable from an external device.
AV IN	VIDEO		 Yellow	 <p>Video Camera Set-top Box Satellite Receiver</p>	Connect a composite video cable and left-right audio cables from an external AV device.
	L		 White		
	R		 Red		
DIGITAL AUDIO OUT				 <p>Audio Amplifier Speaker</p>	Connect an optical cable from an external digital audio system.

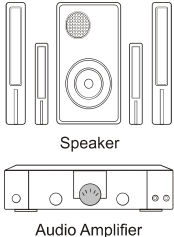

TV label	Port	Cable	External Equipment	Brief Description
Ω / AUDIO OUT				Connect headphone for audio out of the TV.
		 <p>White</p> <p>Red</p>	 <p>Speaker</p> <p>Audio Amplifier</p>	Connect an audio adapter (not provided) from an external analog audio system.
USB DC 5V $\equiv$ 0.5A(MAX)				Connect a USB device for browsing photos, music and movies. The unit only recognizes a USB Memory Stick.

# Meet your remote

The TV remote should feel right at home in your hand. We designed it to be incredibly intuitive for watching TV and navigating on-screen menus.

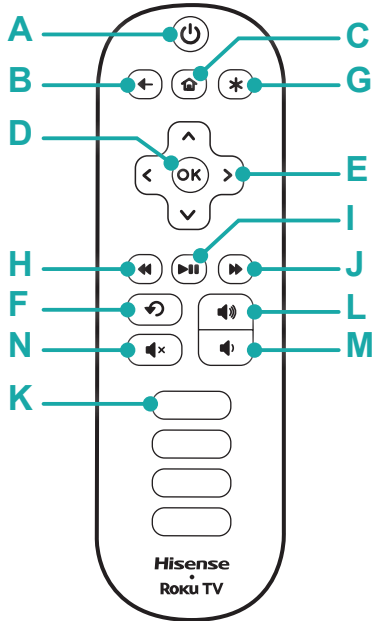

- A** **POWER** Turn TV on and off
- B** **BACK** Return to previous screen
- C** **HOME** Return to Roku Home screen
- D** **OK** Select an option from a menu
- E** **UP or DOWN** Move up or down; **LEFT or RIGHT** Move left or right
- F** **INSTANT REPLAY** Replay last 7 seconds of streaming video
- G** **OPTIONS** View more options
- H** **RWD SCAN** Rewind streaming video, scroll left one page at a time
- I** **PLAY/PAUSE** Start or pause playback
- J** **FWD SCAN** Fast forward streaming video, scroll right one page at a time
- K** **CHANNEL SHORTCUT** Instant access to popular channels
- L** **VOLUME UP** Increase TV volume
- M** **VOLUME DOWN** Decrease TV volume
- N** **MUTE** Silence TV sound

**TIP:** The **(\*)** button gives you easy access to picture settings, display options and more. Try it on every screen.

## STEP 3. Power up

Power up your TV remote by inserting the included batteries.

### CAUTION

- Dispose the batteries in a designated disposal area. Do not throw them into a fire.
- Remove old batteries immediately to prevent them from leaking into the battery compartment.
- If you do not intend to use the remote control for a long time, remove the batteries.
- Battery chemicals can cause a rash. If the batteries leak, clean the battery compartment. If chemicals touch your skin, wash it immediately.
- Do not mix old and new batteries.
- Do not mix alkaline, standard (carbon-zinc) or rechargeable (for example, NiCd or NiMH) batteries.
- If your remote gets warm/hot during use, discontinue use and contact customer support immediately at [www.hisense-usa.com/support](http://www.hisense-usa.com/support).

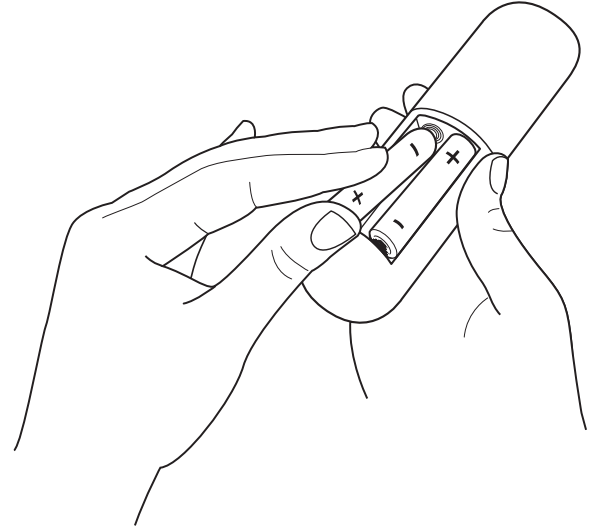

# Using Your Cable Set-top Box or Satellite Receiver Remote as a 'Universal' Remote

If you prefer to use your Cable Set-top Box or Satellite Receiver Remote as a 'Universal Remote', then refer to the manual that your cable or satellite service provided. It will include instructions on how to program their remote to your television.

## Codes for the Most Common Cable and Satellite Providers

Use the Hisense code that is associated with your cable or satellite provider (if applicable)

Service Provider	Hisense Code
AT&T U-Verse	1346, 1013, 1041, 1327, 1363, 1004
Bright House Cable	0748
Cablevision	068, 069, 078, 096, 100, 164, 168, 229, 026
Charter	12355, 2002, 1204, 1423, 1517, 0171, 1963, 0463, 1463, 0842, 1326, 167, 415, 424, 450, 456, 461, 507, 523, 567, 577, 586
Comcast	0178, 10178, 10463, 11463, ,10748, 11314, 11660, 10171, 11204, 11326, 11517, 11641, 11780, 11785, 11892, 11963, 12002
Cox Communication	0178, 10178, 1326, 1463,
DirecTV	0178, 10178, 10019, 10748, 11314, 11660, 11710, 11780, 12049, 10171, 11204, 11326, 11517, 11564, 11641, 11963, 12002
Dish Network	505, 627, 538, 720, 659
Time Warner	386, 0178, 10178, 400, 450, 461, 456, 0748, 1463, 0463, 10463
Tivo	0091

Service Provider	Hisense Code
ONN	4671, 0371, 2891
RCA	12049
UEI	2183, 3519
Verizon	0198, 0490, 0775, 3264, 0205, 0532

**Note:**

If the Hisense code associated with your Cable or Satellite provider is not listed above, does not work or you cannot locate the instructions for programming your remote to your television, call your service provider's Customer Service center.

If your service provider does not have a Hisense code available, then locate additional codes in the FAQ section at [www.hisense-usa.com/support](http://www.hisense-usa.com/support) or call the Hisense Electronic Consumer Care Center at 1-888-935-8880 Monday – Friday from 8 a.m. to 8 p.m. EST, Saturday and Sunday from 9 a.m. to 6 p.m. EST.

## Turn on the TV

Connect the power cord to the back of your TV and plug it into a power outlet.

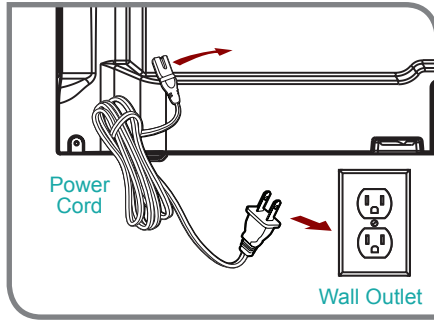

Press the **Power**  button on the remote to turn on the TV. A startup screen appears that displays the **Hisense • Roku TV** logo.



Choose **Set up for home use** to access all TV features and maximize Eco Save.

**Note:** Only retailers that need to set up the TV for display should select **Set up for store use**.

# Connecting brings out your TV's full potential!

## Make any night a movie night

More than 35,000 movies to choose from, across major streaming movie channels like Netflix, Amazon Instant Video, Redbox Instant, VUDU, and more.\*

## Get in the groove

Stream music from one of 85 music channels like Pandora, VEVO and Spotify. Access your entire MP3 collection instantly with Amazon Cloud Player or the Roku Media Player.

## Explore loads of free trials

Your Hisense • Roku TV comes packed with special offers, including 30-day free trials from popular streaming channels like Amazon Instant Video, Netflix, Redbox Instant, Spotify, DailyBurn, and more.

\*Subscriptions or other payments may be required to access content on certain channels. For example, Netflix requires a paid subscription, which gives you access to movie and TV show titles in the Netflix streaming catalog. Some channels may not be available to all households in every market or in all countries where Roku players or other products with the Roku platform are sold.

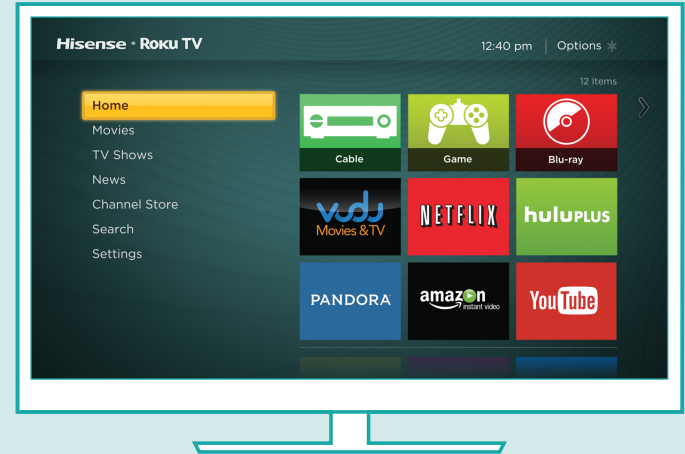

## Rule the watercooler

Binge on the most buzzworthy shows on streaming channels like FOXNOW, HBO GO, Hulu Plus, & Netflix.\*

Live stream your favorite sports with the biggest selection of streaming sports packages out there.

## STEP 4. Complete the guided setup

It's the final stretch, hurray! To connect your Hisense • Roku TV to the Internet:

1. Sign in to your wireless network. The TV automatically finds the local wireless networks in your area and lists them from the strongest to weakest signal. Select your network and sign in. Remember that network passwords are case sensitive.
2. Activate your Roku account. From your smartphone, tablet, or computer, go to [www.roku.com/link](http://www.roku.com/link) and enter the code that is displayed on your TV screen. Roku accounts are free, and while a valid credit card number is required to create your account, rest assured you will only be charged if you authorize purchases of apps and games from the Roku Channel Store.

If you are not ready to connect your TV to a wireless network, you can still use it to view live broadcast channels through your antenna, Set Top Box (STB) or Satellite.

**Complete the rest of the on-screen prompts and setup is done. Congratulations!**

**NOTE:** Once you're connected, your TV will automatically update with the latest software—plus you can start streaming the entertainment you know and love. Unlike other TVs, your new Hisense • Roku TV automatically receives regular software updates in the background when it's connected to the Internet. This allows it to give you a better experience.

*\*\*Disclaimer: Subscriptions or other payments may be required to access content through different providers or download apps. Some or all of the Application Services in this Hisense device may not function depending on the Internet connection, local limitations of included Applications, or other reasons outside of Hisense's control.*



## STEP 5. Personalize your Home screen

The Hisense • Roku TV **Home** screen is your starting point to enjoy endless live and streaming entertainment.

The **Home** screen menu lets you access a ton of streaming entertainment, search for streaming movies and TV shows and change your settings.

The grid of tiles on the right lets you visually choose among your favorite streaming channels and the inputs where you have attached devices such as a DVR, game console, antenna, or set top box.

Continue using the remote to personalize your **Home** screen and channel line-up, stream movies, and so much more. The fun has just begun!

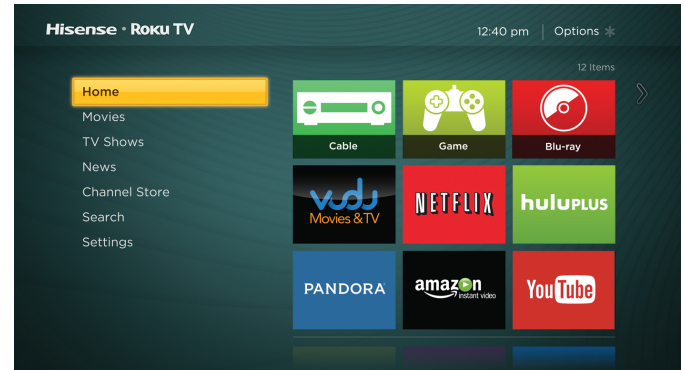

## Product specifications



MODEL NAME		48" H4 Series	50" H4 Series
Dimension (W x H x D)	Without Stand	43" x 25.5" x 3.3 " (1091 x 647 x 85 mm)	44.4" x 26.3" x 3.1 " (1129 x 667 x 79.9 mm)
	With Stand	43" x 26.2" x 7.7 " (1091 x 666 x 195 mm)	44.4" x 27" x 7.7 " (1129 x 688 x 195 mm)
Weight	Without Stand	33.1 lbs (15 kg)	33.1 lbs (15 kg)
	With Stand	37.5 lbs (17 kg)	37.5 lbs (17 kg)
<b>DISPLAY</b>			
Active Screen Size (Diagonal)		47.6 inch	49.5 inch
Screen Resolution		1920 x 1080	1920 x 1080
Panel Selected		Full High Definition backlight	Full High Definition backlight
<b>POWER</b>			
Power Supply		AC 120V, 60Hz	AC 120V, 60Hz
Standby Consumption		Less than 1W	Less than 1W
Audio Power		8W + 8W	10W + 10W
<b>CHANNELS &amp; SIGNALING</b>			

## Product specifications (continued)

Receiving Channels	VHF: 2 - 13, UHF: 14 - 69, CATV: 1 - 125 Digital Terrestrial Broadcast (8VSB): 2 - 69 Digital cable (64/256 QAM): 1 - 135	VHF: 2 - 13, UHF: 14 - 69, CATV: 1 - 125 Digital Terrestrial Broadcast (8VSB): 2 - 69 Digital cable (64/256 QAM): 1 - 135
<b>CHANNELS &amp; SIGNALING</b>		
Tuner Type	Frequency synthesized	Frequency synthesized
Receiving System	Analog: NTSC Digital: ATSC/QAM	Analog: NTSC Digital: ATSC/QAM
HDMI Input	RGB/60Hz (640x480,800x600,1024x768) YUV/60Hz (480I,480P,720P,1080I,1080P)	RGB/60Hz (640x480,800x600,1024x768) YUV/60Hz (480I,480P,720P,1080I,1080P)
<b>OTHER FEATURES</b>		
Parental Control	Yes	Yes
HD Supported Definitions	480i, 480P, 720P, 1080i,1080P	480i, 480P, 720P, 1080i,1080P
Sleep Timer	Yes	Yes
Wall Mount Support	VESA Standard (excluded)	VESA Standard (excluded)
Energy Star 6.1	Yes	No
Wi-Fi Built In	Yes	Yes
Environmental Conditions	Temperature: 41°F - 95°F (5°C - 35°C) Humidity: 20% - 80% RH Atmospheric pressure: 86 kPa - 106 kPa	Temperature: 41°F - 95°F (5°C - 35°C) Humidity: 20% - 80% RH Atmospheric pressure: 86 kPa - 106 kPa

## Quick problem-solving tips

When you experience an issue with your TV, turn it off and on again. If this does not resolve the problem, then refer to the tips below. If the problem is still not resolved, then contact our Hisense Electronics Consumer Care Center at **1-888-935-8880** Monday through Friday 8 A.M. to 8 P.M. EST and Saturday through Sunday from 9 A.M. to 6 P.M. EST.

SOUND OR PICTURE ISSUES	POSSIBLE SOLUTIONS
You do not see a picture when turning on the TV	<ul style="list-style-type: none"><li>• Check if the LED light is on. If it is, then there is power to the TV.</li><li>• The TV may be in Standby mode. Press the <b>Power</b>  button on the remote control to activate the unit from Standby.</li><li>• Check if the power cord is plugged into an active electrical outlet.</li></ul>
You have connected an external source to your TV but can not find it on the <b>Home</b> screen	<ul style="list-style-type: none"><li>• Make sure your external source is turned on.</li><li>• Check to see if the correct input tile is selected on the <b>Home</b> Screen for the external source you want to view.</li><li>• Check to see if the external source device connection is snug and fully inserted into the TV port.</li></ul>
When you turn on your TV, there is a delay for a few seconds before the picture appears	<ul style="list-style-type: none"><li>• This is normal. If you have already set up your TV, it is initializing and searching for previous setting information.</li></ul>
You see a normal picture but do not hear any sound	<ul style="list-style-type: none"><li>• Check that volume is turned up.</li><li>• Check if “Mute” mode is ON. Turn off mute by pressing the <b>Mute</b>  button again, or pressing volume up.</li></ul>
You hear sound but picture color is faded or in black and white	<ul style="list-style-type: none"><li>• Check that the Color value is set to 50 or greater.</li><li>• Check the color on another channel or input tile.</li></ul>
Your sound or picture is distorted or appears wavy	<ul style="list-style-type: none"><li>• Turn off and/or remove any electrical appliance that may be nearby the TV panel.</li><li>• Insert the power plug of the TV set into another power outlet.</li></ul>

## Quick problem-solving tips (continued)

SOUND OR PICTURE ISSUES	POSSIBLE SOLUTIONS
Your sound or picture is blurry or cuts out	<ul style="list-style-type: none"><li>• If you are using an external antenna, check the connections for a snug and tight fit.</li><li>• Adjust or reposition the antenna placement.</li></ul>
You see horizontal/vertical stripes on the picture, or it is shaking	<ul style="list-style-type: none"><li>• Turn off and/or remove any electrical appliance that may be nearby the TV panel.</li><li>• Insert the TV power cord into another electrical outlet.</li></ul>
CONNECTIVITY ISSUES	POSSIBLE SOLUTIONS
You cannot connect to your wireless network	<ul style="list-style-type: none"><li>• Make sure you have selected the correct wireless network name on the <b>Choose Wireless Network</b> screen.</li><li>• Make sure that you entered the correct wireless password for your network (passwords are case sensitive).</li><li>• If you have turned off SSID broadcasting on your wireless router, add your network by selecting <b>Add Private Network</b> from the <b>Select Wireless Network</b> screen.</li><li>• To check if it is a password problem, temporarily disable security on the wireless router.</li><li>• If you are not getting 3 or more signal strength bars above the wireless network icon, adjust the position of the TV (if possible) or the wireless router. Even a few inches in one direction or another may help.</li></ul>
REMOTE CONTROL ISSUES	POSSIBLE SOLUTIONS
Your remote control is not responding to button presses	<ul style="list-style-type: none"><li>• Check that the TV is still on.</li><li>• Check that the batteries are good and are inserted properly.</li><li>• Check that there are no obstacles between the remote control and the front of the TV.</li><li>• Try moving closer to the TV. If the LED on the TV flashes when you press any of the buttons on the remote control, the issue is not with the remote control.</li></ul>

# Certification and Compliance

## FCC Notice

This device has been tested and found to comply with the limits for a Class B digital device pursuant to Part 15 of the FCC Rules. These limits are designed to provide reasonable protection against harmful interference in a residential installation. This device generates, uses, and can radiate radio frequency energy and, if not installed and used in accordance with the instructions, may cause harmful interference to radio communications.

However, there is no guarantee that interference will not occur in a particular installation. If this device does cause harmful interference to radio or television reception, which can be determined by turning the device off and on, the user is encouraged to try to correct the interference by one or more of the following measures:

- Reorient or relocate the receiving antenna.
- Increase the separation between the device and receiver.
- Connect the device into an outlet on a circuit different from that to which the receiver is connected.
- Consult the dealer or an experienced radio/TV technician for help.

**NOTE: The manufacturer is not responsible for any radio or TV interference caused by unauthorized modifications to this equipment. Such modifications could void the user's authority to operate the equipment.**

The WiFi Module complies with FCC radiation exposure limits set forth for an uncontrolled environment. This device should be installed and operated with a minimum distance of 20 centimeters between the radiator and your body.

## Energy Star

Your Hisense TV is ENERGY STAR® qualified in the "Eco Save" mode. It meets strict energy efficiency guidelines set by the U.S. Environmental Protection Agency and Department of Energy. ENERGY STAR is a joint program of these government agencies, designed to promote energy efficient products and practices. Changes to certain features, settings, and functionalities of this TV (i.e. TV Guide, Picture, Sound) can increase or change the power consumption. Depending upon such changed settings, the power consumption may exceed the limits required for the ENERGY STAR qualification in the "Eco Save" mode.

**NOTE: This only applies for some TV models.**



**HDMI** This TV incorporates High-Definition Multimedia Interface (HDMI™) technology.

HDMI, the HDMI logo and High-Definition Multimedia Interface are trademarks or registered trademarks of HDMI Licensing LLC.



©2014. All rights reserved. Hisense and the Hisense logo are registered trademarks of Hisense. Other brand and product names are registered trademarks of their respective owners.



© Hisense Company Ltd. and 2014 Roku, Inc.

All material in this Quick Start Guide is the property of Hisense Company Ltd. and Roku Inc. and its subsidiaries, and is protected under U.S. and International copyright and/or other intellectual property laws. Reproduction or transmission of the materials, in whole or in part, in any manner, electronic, print, or otherwise, without the prior written consent of Hisense Company Ltd. and Roku, Inc. is a violation of the rights of Hisense Company Ltd. and Roku, Inc. rights under the aforementioned laws.

No part of this publication may be stored, reproduced, transmitted or distributed, in whole or in part, in any manner, electronic or otherwise, whether or not for a charge or other or no consideration, without the prior written permission of Hisense Company Ltd. and Roku, Inc.

Requests for permission to store, reproduce, transmit or distribute materials may be made to the following address:

Hisense USA Corporation  
7310 McGinnis Ferry Road  
Suwanee, GA 30024.

Hisense, and any and all other Hisense product names, logo's, slogans or marks are registered trademarks of Hisense Company Ltd. and its subsidiaries. All other trademarks are the property of their respective holders. Roku, Roku TV, Happy Streaming and the Roku logo are the trademarks or registered trademarks of Roku, Inc.