

Antes de utilizar el televisor, por favor lea este manual detenidamente y consérvelo para futuras referencias.

MANUAL DEL USUARIO

Hisense
INNOVATION IS LIFE

USER MANUAL

Before using the TV, please read this manual thoroughly and retain it for future reference.

Contents

Getting Started

Viewing the Remote Control.....	2
Installing Batteries in the Remote Control	3
Making Connections	4

Basic Features

Turning your TV on or off.....	7
Turning the TV for the First Time	7
Selecting the Input Source	8
Changing Channels / Volume.....	8
Shortcuts Instructions	8
To Use the Menu	9
Using the Video Menu	9
Using the Audio Menu	10
Using the TV Menu.....	10
Using the Setup Menu	11
Using the Parental Menu	12

Advanced Features

Digital Media Player.....	14
Enjoy Video Files.....	14
Browse the Pictures.....	14
Playable Format List.....	15

Getting Started

Viewing the Remote Control

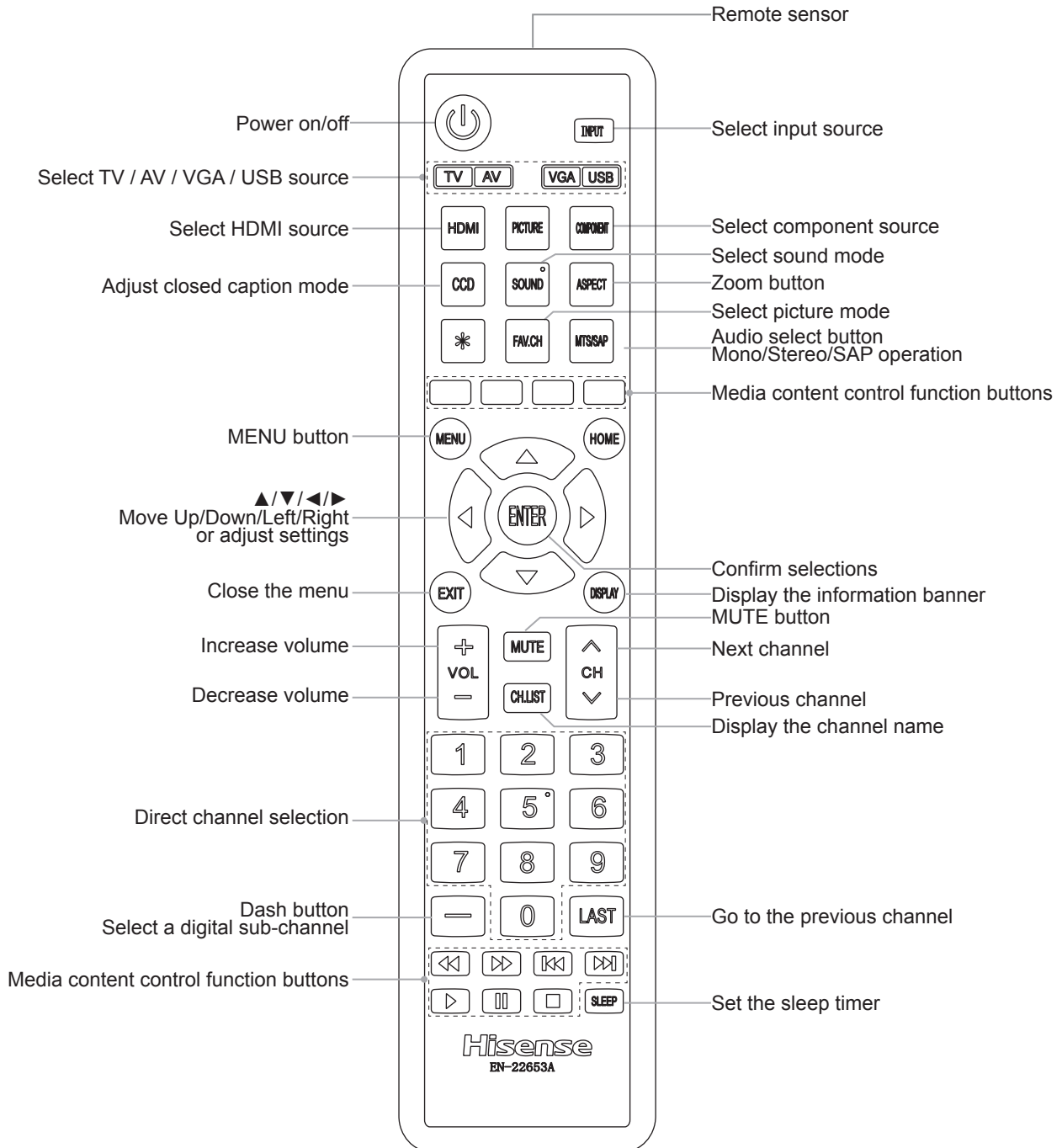

NOTE

The Picture is Only for Reference.

Getting Started

Installing Batteries in the Remote Control

Change the batteries

1. Slide the back cover to open the battery compartment of the remote control.
2. Insert two AAA size batteries. Make sure to match the (+) and (-) ends of the batteries with the (+) and (-) ends indicated in the battery compartment.
3. Close the battery compartment cover.

The remote control requires:

- Number of Batteries: 2
- Type: AAA
- Voltage: 1,5Vcc

❶ Gently push and slide

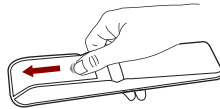

❷ Insert the batteries

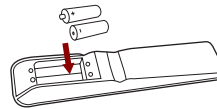

❸ Gently push and slide

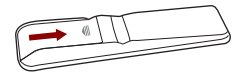

NOTES

1. Dispose of your batteries in a designated disposal area. Do not throw the batteries into a fire.
2. Do not mix battery types or combine used batteries with new ones.
3. Remove depleted batteries immediately to prevent battery acid from leaking into the battery compartment.
4. If you do not intend to use the remote control for a long time, remove the batteries.
5. Batteries should not be exposed to excessive heat, such as sunshine, heat registers, or fire.
6. Battery chemicals can cause a rash. If the batteries leak, clean the battery compartment with a cloth. If chemicals touch your skin, wash immediately.
7. Do not mix old and new batteries.
8. Do not mix alkaline, standard (carbon-zinc) or rechargeable (ni-cad, ni-mh, etc.) batteries.

Program Your Universal Cable or Satellite Remote Control to Operate Your New Hisense Television!

If you would like to program your other household remote controls to your new Hisense television, please consult the User's Manual supplied by your Cable or Satellite provider. The Cable or Satellite providers' User's Manuals should include instructions on how to program their remote to your television.

Below is a list of Hisense codes for the most common Cable and Satellite providers. Use the Hisense code that is associated with your Cable or Satellite provider (if applicable).

DIRECTV.....0178 or 10019
Time Warner Cable.....386 or 0178
Comcast.....0178 or 10178
Cox Communications.....0178
Dish Network.....627 or 505
AT&T U-verse.....1346

If the Hisense code associated with your Cable or Satellite provider is not listed above, if the code above does not work, or if you cannot locate the instructions for programming your household remote to your television, call your local Cable or Satellite provider's customer service center.

The effective range of remote control

1. The remote control distance: 315 inches in front of the TV set.
2. The remote control angle: taking the television infrared light receiver window as an apex, 236 inches away, its controlled angle (left to right) is within 30 degrees, while the vertical angle (up to down) is within 30 degrees.

Getting Started

Making connections

NOTES

- Check the jacks for position and type before making any connections. Loose connections can result in image or color problems. Make sure that all connections are tight and secure.
- Not all A/V devices have the ability to connect to a TV, please refer to the user manual of your A/V device for compatibility and connections procedure.
- Always unplug the power cord when connecting external equipment.

Connecting an antenna, cable or cable/satellite box

1. Turn off the TV before connecting the antenna.
2. Connect one end of a coaxial cable (not included) to the RF OUT jack on the antenna, cable or cable/satellite box. If you are using an antenna with twin-lead cable, you may need a 300-75 ohm adapter (not provided) to connect it to the back of your TV. Likewise, if you are using several antennas, you may need a combiner (not provided).
3. Connect the other end of the cable to the ANT/CABLE jack on the side of your TV.

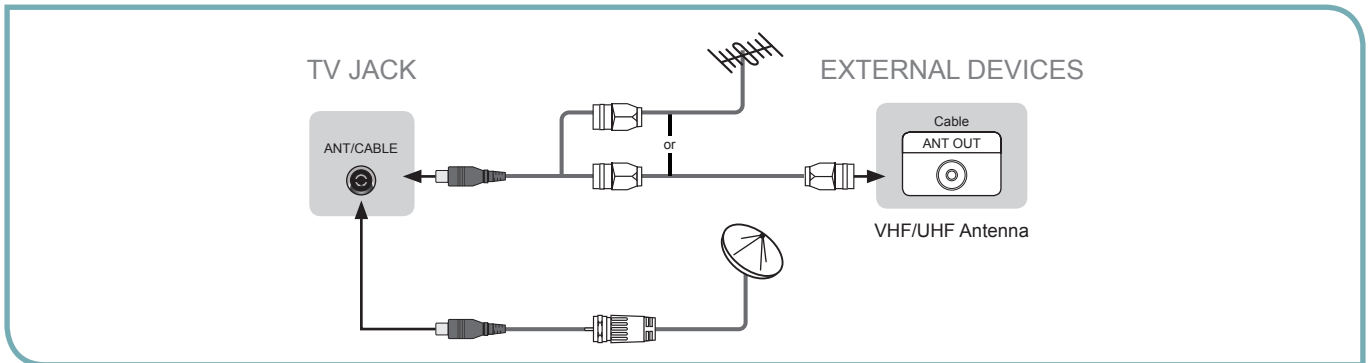

Connecting an A/V Device with Composite Cable

1. Use the audio and video cables to connect the external A/V device's composite video/audio jacks to the TV's jacks. (Video = yellow, Audio Left = white, and Audio Right = red)
2. Plug the connected devices into the mains socket before switching on the TV.
3. Select the corresponding source from the TV.

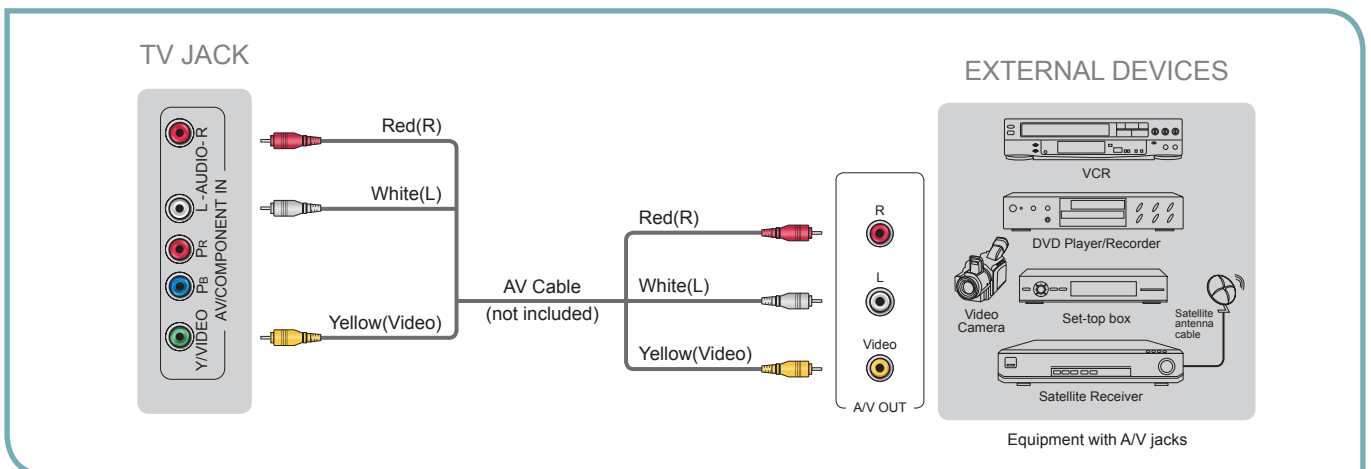

Getting Started

❏ Connecting an A/V Device with Component (YP_BP_R) Cable

1. Use a component cable to connect the external A/V device's component output jacks to the TV's YP_BP_R jacks. Use an audio cable to connect the external A/V device's component audio jacks to the TV's AUDIO (L/R) jacks.
2. Plug the connected devices into the mains socket before switching on the TV.
3. Select the corresponding source from the TV.

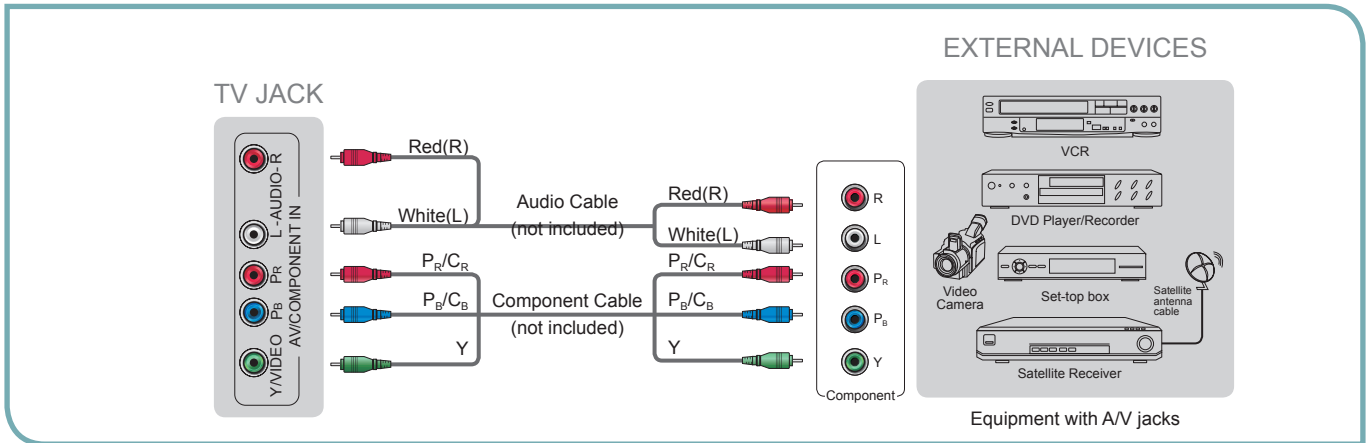

❏ Connecting an A/V Device with HDMI Cable

- Support digital connections between HDMI - enabled A/V devices such as PVR, DVD, Blu-ray, AV receiver and digital devices.
 - Some devices such as PVR or DVD player require HDMI signal to be set to output in the device's settings.
 - Please consult your device user manual for instructions.
1. Use an HDMI cable to connect the A/V device's HDMI output jack to the TV's HDMI jack.
 2. Plug the connected devices into the mains socket before switching on the TV .
 3. Select the corresponding source from the TV.

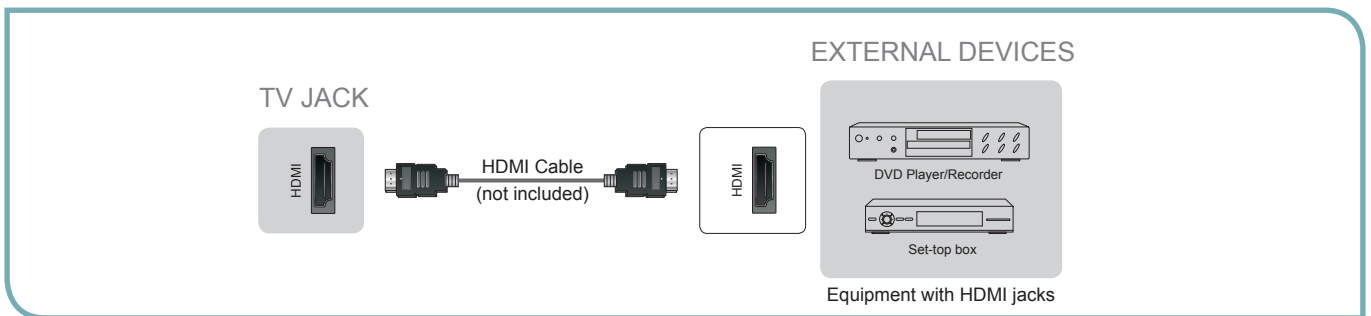

✔ NOTE

The HDMI connector provides both video and audio signals, it's not necessary to connect the audio cable.

❏ Connecting a headphone

Headphones can be connected to the /AUDIO OUT output on your set. (While the headphone is connected, the sound from the built-in speakers will be disabled.)

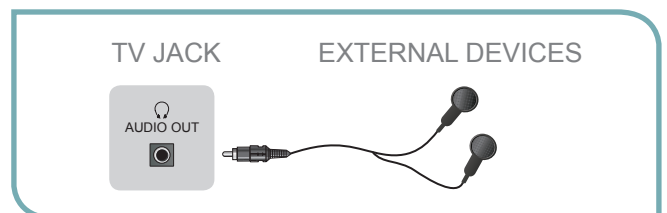

Getting Started

Connecting a PC with VGA Cable

1. Use a VGA cable to connect the PC's VGA output jack to the TV's VGA jack. Use an audio cable to connect the PC's audio output jack to TV's PC/DVI AUDIO IN jack.
2. Plug the connected devices into the mains socket before switching on the TV.
3. Select the corresponding source from the TV.

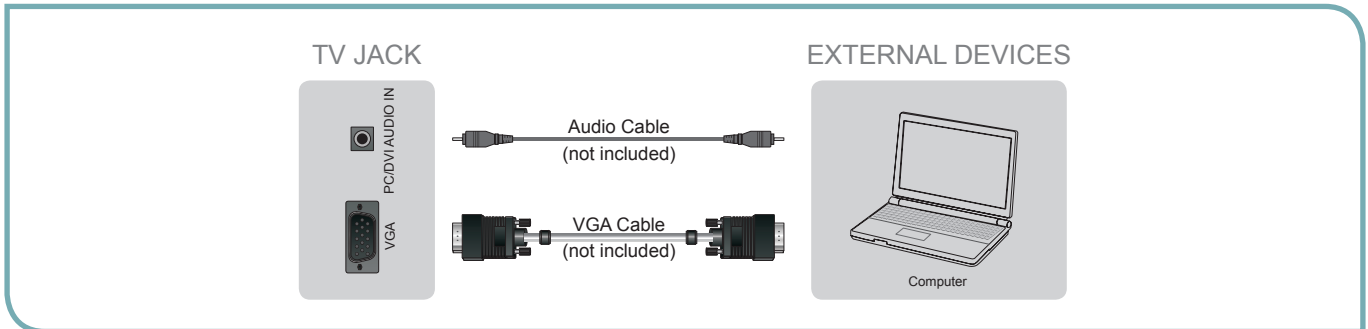

NOTES

- Primarily this unit is intended for use as an LCD TV. If you want to use it as a monitor, please contact the manufacturer of the PC Video/Graphic's card for further support. Perfect compatibility is not warranted.
- The VGA cable will not supplied with the product.
- We strongly recommend to use VGA cable with 2 cores as shown in the figure.

Connecting an Audio Receiver with Audio cable

1. Use an audio Optical to connect the A/V device's digital audio in jack to the TV's DIGITAL OUTPUT (Optical) jack. Or use an RCA Y-cable (1/8"-stereo mini to L/R phono - not provided) to connect analog sound system to the TV's AUDIO OUT jack.
2. Plug the connected devices into the mains socket before switching on the TV.
3. Select the corresponding source from the TV.

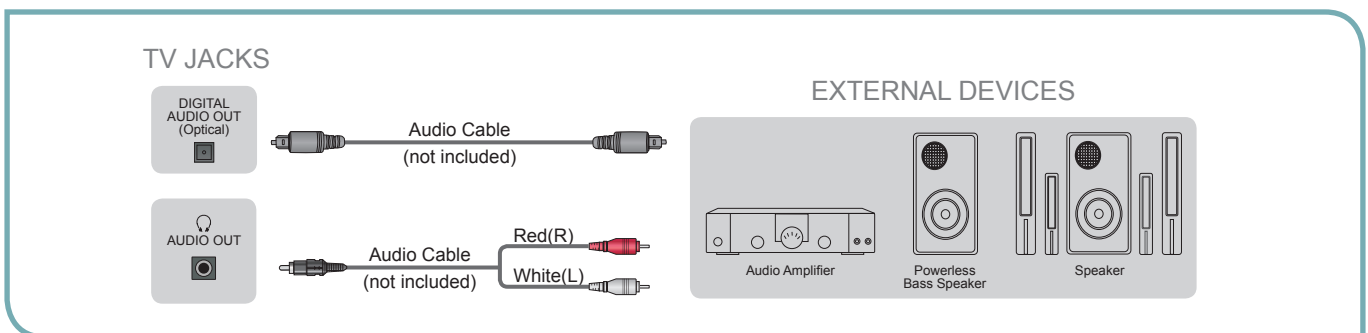

NOTES

- When a digital audio system is connected to the DIGITAL OUTPUT (Optical) jack, decrease the volume of both the TV and the system.
- 5.1 CH (channel) audio is available when the TV is connected to an external device supporting 5.1 CH.
- When the receiver (home theater) is set to on, you can hear sound output from the TV's digital audio out jack. When the TV is receiving a DTV signal, the TV will send 5.1 CH sound to the home theater receiver. When the source is connected to the TV via HDMI, only 2 CH audio will be heard from the home theater receiver. If you want to hear 5.1 CH audio, connect the digital audio out jack from your DVD/Blu-ray player/cable box/STB satellite receiver directly to an amplifier or home theater.

Basic Features

Turning your TV on or off

To turn your TV on or off (standby mode):

1. Plug the power cord into an AC power outlet.
2. Press [POWER] button. Your TV turns on.
3. Press [POWER] button again to turn off your TV. When you turn off your TV, it goes into standby mode.

! WARNING

When your TV is in standby mode, it is still receiving power. To completely disconnect power, unplug the power cord.

✓ NOTE

If your TV does not receive an input signal for several minutes, it automatically goes into standby mode.

Turning the TV On for the First Time

The Setup Wizard menu appears the first time you turn on the TV. It will assist you to specify the menu language, Picture Mode, Tuner Mode and Channel Installation.

IMPORTANT: Make sure that the antenna or cable is connected.

1. Make sure that you have:
 - Installed the remote control batteries.
 - Connected an antenna or cable.
 - Connected the power cord.
2. Connect your TV's power cord to a power outlet, then press power. The Initial Setup screen opens.

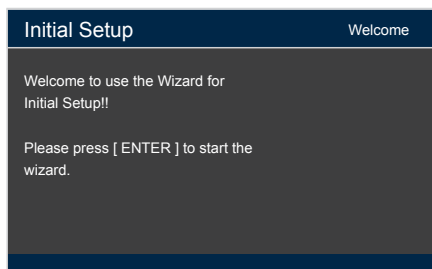

3. Please press [ENTER] to start the wizard, then press [▲/▼] button to select your language, press [ENTER] button to confirm.

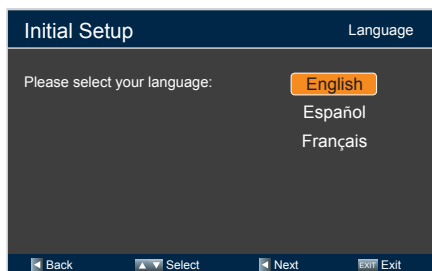

4. Press [▲/▼] to select your Picture Mode: Home Mode or Retail Mode, press [ENTER] button to confirm.

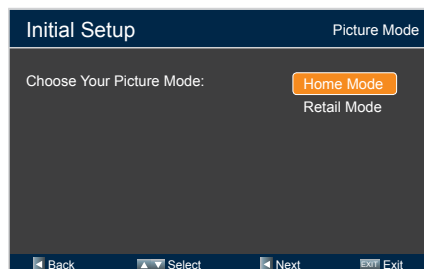

If you select Retail Mode, a message appears "If you select Retail Mode, then Energy saving is not realized. Are you sure?" Select "Yes" to continue, or select "No" to change your selection.

5. Press [▲/▼] to select your Tuner Mode: Antenna or Cable, press [ENTER] button to confirm.

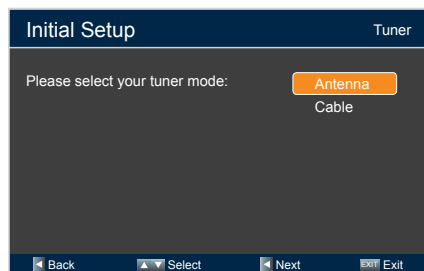

6. Press [▲/▼] to set the Channel Installation: Scan or Skip Scan, press [ENTER] button to confirm.

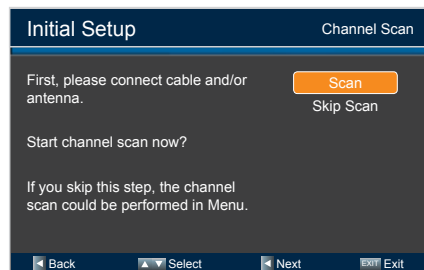

- If you select "Scan", your TV automatically starts Channel Installation available in your viewing area.
- If you select "Skip Scan", your TV does not scan for channels.
- Depending on the reception condition, it may take several minutes to scan channels. Please allow the process to complete without interruption.

Basic Features

Selecting the Input Source

The first time you turn on your TV, you must select the TV signal source. Your TV stores this information, so you do not need to change the TV signal source unless it changes. For example, you change from an outside antenna to cable TV.

To select the video input source:

1. Turn on your TV, then press [INPUT] button on the remote or on the TV. The Input Source menu opens.
2. Press [▲/▼] button to highlight the input source, then press [ENTER] button.

Changing Channels / Volume

1. Press the [CH ▲/▼] (or [CH +/-]) on the TV/remote control to change the channel.
2. Press the [VOL ▲/▼] (or [VOL +/-]) on the TV/remote control to adjust the volume.
3. Press the numeric buttons on the remote control to display the corresponding channels.

NOTE

Changing the channels can also be achieved by directly entering the channel number using the numeric keys on the remote control. If you are entering a two or three digit channel number, the time between key presses should be less than 3 seconds.

Shortcuts Instructions

Aspect - Select the screen aspect ratio from Normal, Wide, Zoom and Cinema.

Normal: The original 4:3 aspect ratio (1.33:1 signal) is preserved, so black bars are added to the left and right of the image. Standard TV broadcasts are displayed with a 4:3 aspect ratio.

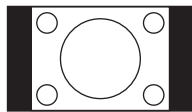

Wide: When watching a standard broadcast or full-frame movie in this mode, the display image is stretched proportionately to fill the TV screen. When watching a widescreen (1.78:1 signal) program or movie, the display image fills the TV screen.

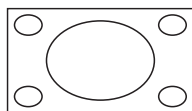

Auto: Automatically adjusts the image based on the screen size and the TV program.

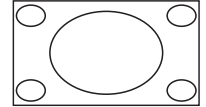

Zoom: Stretch the 4:3 aspect ratio image vertically and horizontally to fill the screen at 1:1.78 aspect ratio.

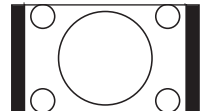

Cinema: Stretch the 4:3 aspect ratio image vertically and horizontally to fill the screen at 1:2.35 aspect ratio.

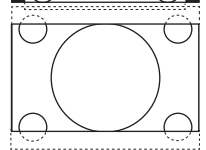

Picture - Press to set the picture mode. It can be set as Vivid, Standard, Energy Savings, Theater or Custom. This mode achieves a certain image display effect by setting the brightness, contrast and color etc.

NOTE

The Game mode is not available in TV and USB source.

Sound - Press to set the sound mode. It can be set as Standard, Theater, News, Music and Custom.

Mute - Press to turn the sound off, press this button again to turn the sound back on. This function is used to switch off sound temporarily.

Sleep - It can set the TV to let it enter into the Standby state automatically. Press this button repeatedly to select the proper sleeping clock mode, and the clock tells you the remaining time before the TV enters Standby state.

Display - Display the information banner. The information including channel number, channel name, current system time, tuner mode, audio stream, video format, audio language, closed caption mode, parental locks rated, program details, etc.

Basic Features

To Use the Menu

- 1 Press the [MENU] to open the main menu.
- 2 Press [▲/▼] to select a menu option, then press [▶/ENTER] button to enter the menu.
- 3 In each menu, you can:
 - Press [▲/▼] to select an item,
 - Press [◀/▶] to adjust the value, or
 - Press [▶/ENTER] to enter the submenu,
 - Press [MENU] to back the previous menu.
- 4 Press [EXIT] to exit the menu.

NOTE

The menus in the user manual may vary slightly from the actual screen.

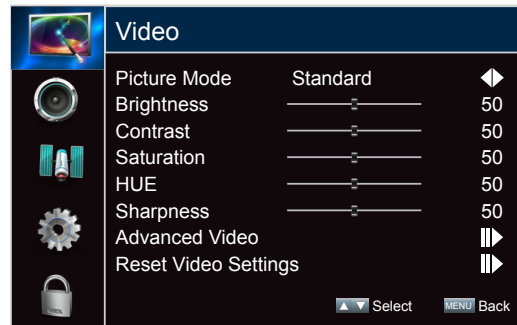

Using the Video Menu



You can adjust:

Picture Mode - Adjust the Picture Mode. You can select Vivid, Standard, Energy Savings, Game, Theater or Custom.

NOTE

The option of the Picture Mode is different in different inputs. (For more information, see "Shortcuts Instructions")

Brightness - Increase or decrease the brightness of the picture. Increasing the brightness can add more light to dark areas of the picture, while decreasing the brightness can add more darkness to light areas of the picture.

Contrast - Increase or decrease the contrast of the picture. Increase the contrast to adjust the white areas of the picture or decrease the contrast to adjust the black areas of the picture.

Saturation - Adjust the intensity of the colors.

HUE - Adjust the overall color of the picture.

Sharpness - You can increase the sharpness level for clearer images or decrease the sharpness level for smoother images.

Advanced Video - Access advanced video settings such as Back Light, Color Temperature and DNR.

Back Light: Sets the overall brilliance of the screen. When the option of Adaptive Back Light sets Low or High, you cannot change the Back Light setting.

120HZ Smooth Effect: Inserts frames to reduce judder in fast action scenes. You can select On or Off.

NOTE

Only Model 50" has this function.

Aspect Ratio: To choose the screen aspect ration from Wide, Auto, Normal, Zoom and Cinema.

NOTE

The option of the screen Aspect Ration is different in different inputs. (For more information, see "Shortcuts Instructions")

Color Temperature: Change the color temperature. You can select the color temperature from three options: Cool, Standard or Warm.

Overscan: Adjusts the picture's reproduction rate. You can select On or Off.

NOTE

Only available in DTV and Component source.

DNR: Select to reduce the noise level of connected equipment: off, Low, Medium, Strong, Auto.

Adaptive Luma Control: According to the content of picture, it can adjust brightness automatically.

Adaptive Back Light: Enhances the contrast ratio between light and dark areas of the picture. You can select Off, Low, or High.

Reset Video Settings - Resets all Video Settings to the factory defaults.

Basic Features

Using the Audio Menu

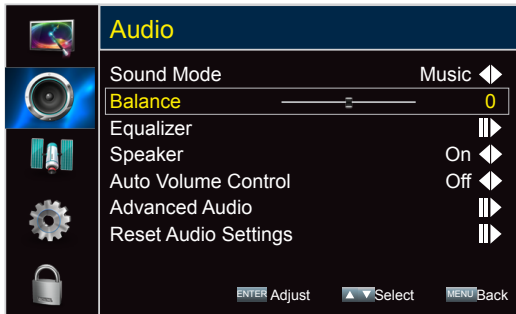

You can adjust:

Sound Mode - Select the Sound Mode: Standard, Theater, News, Music or Custom.

Balance - Adjust the volume of the left and right speakers.

Equalizer - Soften or enhance the sound at specific frequency points.

Speaker - Selects where to play TV audio. You can select On (default setting) to play audio through TV speakers, or select Off to play audio through the speakers on an external audio system.

Auto Volume Control - Automatically adjusts volume to a consistent level; attenuates loud passages.

Advanced Audio - Access Advanced Audio settings such as SPDIF Type, MTS, Audio Language.



SPDIF Type: Send digital audio to an external audio system. You can select PCM, RAW or Off.

- **PCM:** PCM outputs two channel audio regardless of the input format.
- **RAW:** When the data stream carries Dolby signal, digital SPDIF outputs Dolby data stream. When the data stream carries no Dolby signal, it transports PCM data stream.

MTS: Select the default audio stream, you can select Mono, Stereo or SAP (Second Audio Program).

- **MONO:** Select this option if there is noise or static on weak stereo broadcasts.

- **STEREO:** Select this option for programs broadcast in stereo.
- **SAP:** Depending on the particular program being broadcast, you can listen to a foreign-language translation.

Audio Language - Change the default value for audio language. (Digital channels only)

Reset Audio Settings - Resets all Audio Settings to the factory defaults.

Using the TV Menu



You can adjust:

Tuner Mode - Select the TV signal source. You can select Antenna or Cable.

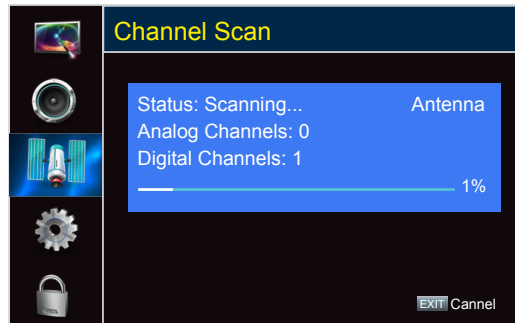

Channel Scan - Scans for channels that have signals and stores the channels information in memory.

Digital Channels: The scanned TV program in digital signals.

Analog Channels: The scanned TV program in analog signals.

Channel Skip - You can cancel a channel stored in memory.

NOTE

When you press [CH Δ/∇] (or [CH +/-]) button, your TV skips the channel you cancelled. You can still tune to the channel using the number buttons on the remote control.

Basic Features

Favorite List - Display your Favorite List. You can add or delete channels to create your favorite list.



Audio Only - Listen to the program audio only, when you turn off the picture on your TV.

NOTES

- Audio Only works only when the input source is TV, and your TV is receiving a broadcast signal.
- To exit audio only mode, press any button. When you exit audio only mode, the Audio Only option is automatically reset to Off.

Analog Closed Caption: Select an Analog Caption setting from CC1~CC4, TEXT1~TEXT4.

Digital Closed Caption: Select a Digital Caption setting: Service1~Service6.

Digital Caption Style: There are two Caption Styles. One is the automatic function set as the broadcaster, while the other is the custom style where you can adjust the font size, color, opacity, background color etc..

Time - Access Time settings such as Time Zone, Date/Time, Sleep Timer.



Time Zone: Select your local time zone: Eastern Time, Hawaii, Alaska, Arizona, Indiana, Mountain Time, Central Time or Pacific Time.

Date/Time: You can set time manually or select automatic if the TV is connected to an antenna or cable source.

- **Auto Synchronization:** Select "On" to for automatic date and time setting using information from broadcast stations in your area.
- **Date:** Set the current year/month/day.
- **Time:** Set the current time.
- **Timer:** When "On", you can set the time when the TV turns on/off automatically.
- **Power On Timer:** Set the desired time for the TV to turn on automatically.
- **Power Off Timer:** Set the desired time for the TV to turn off automatically.

Sleep Timer: Specify the amount of time before your TV automatically turns off.

Menu Language - You can select the menu's language to English, Spanish or French.

HDMI-CEC - HDMI-CEC lets you control HDMI CEC-compatible devices connected to the HDMI jacks on your TV using the remote control that came with your TV. To use HDMI-CEC, you must set the HDMI-CEC Control setting on the Settings-HDMI-CEC menu to On.

Using the Setup Menu

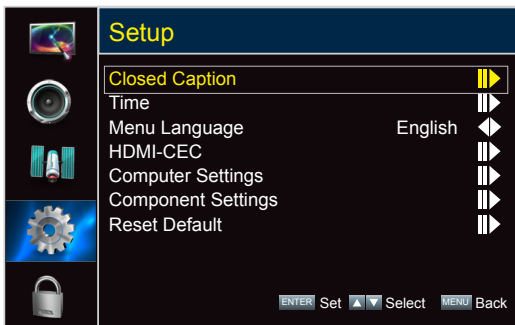

You can adjust:

Closed Caption - Adjust Closed Caption settings.

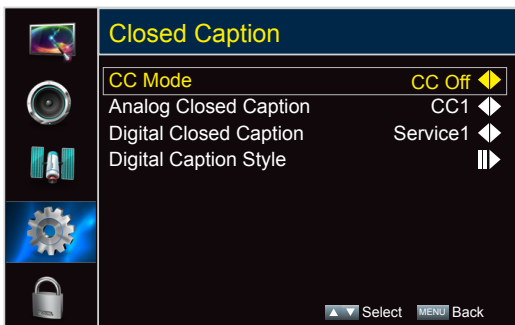

CC Mode: To select CC Off (turns off closed caption), CC On (turns on closed caption), or CC on when Mute (turns on closed caption when the sound is muted).

Basic Features

NOTES

- HDMI cables must be used to connect HDMI CEC-compatible devices to your TV.
- The connected device's HDMI CEC feature must be turned on.
- If you connect an HDMI device that is not HDMI CEC-compatible, all the HDMI-CEC Control features do not work.
- Depending on the connected HDMI device, the HDMI-CEC Control feature may not work.



HDMI-CEC Control: Turning HDMI-CEC function on or off.

Device Auto Power Off: When HDMI-CEC is turned on, Device Auto Power Off turns off HDMI CEC devices when you turn off your TV.

TV Auto Power On: When HDMI-CEC is turned on and you turn on an HDMI CEC device, TV Auto Power On turns on your TV automatically.

Audio Receiver: When HDMI-CEC is turned on and you have connected an audio receiver to your TV, turning on Audio Receiver lets you use your TV's remote control to control the volume on the audio receiver.

Root Menu: You can open an HDMI-CEC-compatible device's root menu, then use your TV's remote control to control the device.

HDMI-CEC Device Lists: You can display a list of HDMI CEC devices that are connected to your TV.

Computer Settings (Only available in VGA mode.)- Access Computer Settings such as H.Position, V.Position, Phase, Phase and Auto Adjust.

H.Position: Move the image right or left.

V.Position: Move the image up or down.

Phase: Adjust the focus of stable images.

Clock: Adjust the sample frequency.

Auto Adjust: Detects input signal clock, phase and position and adjusts TV display accordingly.

Component Settings (Only available in Component mode.) - Access Component Settings such as phase, Reset Component Settings.

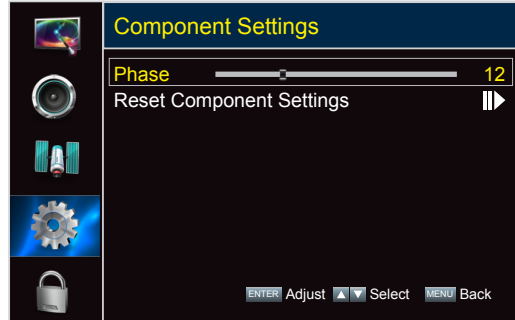

Phase: Adjust the focus of stable images.

Reset Component Settings: This function can help you restore the component settings.

Reset Default - Every TV has its original setting before leaving the factory. This function can help you restore these settings.

Using the Parental Menu

When you first use this function, the default password is [0000]. Once you input this password, you can set options.



You can adjust:

Button Lock - Block or unblock the button of remote control.

Rating Enable - Block or unblock TV ratings.

Block Unrated - Block unrated TV programs.

U.S. TV Ratings - Restrict TV programs by USA Ratings.

Open V-Chip: Display an advanced V-Chip ratings table for digital channels (USA only).

Block Unrated: Block unrated TV programs.

U.S. Movie Ratings - Restrict movie by USA Ratings.

Canadian English/French Ratings - Restrict movie and TV programs by Canadian Ratings.

Change Password - If you want to change the default password, first enter the new password then enter the same password again.

Basic Features

Following is the description of these ratings.

U.S. TV Ratings

Age	Defined as
TV-Y	All children
TV-Y7	Directed to older children
TV-G	General audience
TV-PG	Parental Guidance suggested
TV-14	Parents Strongly cautioned
TV-MA	Mature Audience only

Contents	Defined as
A	All of the ratings below that rating set blocked automatically
D	Suggestive dialogue
L	Strong language
S	Sexual situations
V	Violence
FV	Fantasy Violence

U.S. Movie Ratings

Rating	Defined as
G	General audience
PG	Parental Guidance suggested
PG-13	Parents strongly cautioned
R	Restricted
NC-17	No one 17 and under admitted
X	Adult audience only

Canadian English Ratings

Rating	Description
C	Children
C8+	Children 8 years and older
G	General Programming, suitable for all audiences
PG	Parents Guidance
14+	Viewers 14 years and older
18+	Adult Programming

Canadian French Ratings

Rating	Description
G	General
8 ans+	8+General; Not recommended for young children
13 ans+	Programming may not be suitable for children under the age of 13
16 ans+	Programming is not be suitable for children under the age of 16
18 ans+	Programming restricted to adults

NOTE

As you block rating, all rating higher than the ones you select are blocked as well. E.g. if you choose to block the MPAA rating R, the higher ratings, NC-17 and X, are automatically blocked too.

Advanced Features

Digital Media Player

Please note that Hisense will not assume any responsibility for any lost data and cannot guarantee perfect compatibility with all mass storage devices. Be sure to insert the USB disk with standard USB 2.0 port. Data Input from USB Memory Stick only. Do not connect any device to this terminal such as digital camera, keyboard, mouse, etc.

NOTE

Never remove the USB flash drive or turn off your TV while viewing video/photo.

- Press [INPUT] button to display the INPUT menu, press [▲/▼] button to highlight the USB source, then press [ENTER] button to confirm. (If you want to exit DMP, you can press [INPUT] button to switch to other sources).
- Press [RED] button to switch the media type.
- Press [CH /V] button to turn to the previous/next page.



Media content control function buttons

When viewing video/photo, you can press these buttons on the remote control to control video/photo.

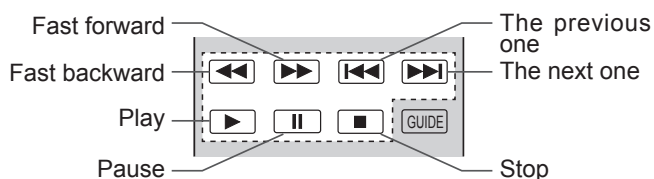

NOTE

When browsing the photos, only the and buttons are available.

Enjoy Video Files

1. Press [RED] button to switch the media type to Video.
2. Press [▲/▼/◀/▶] to select the video you want to view.
3. Press [ENTER] to play the video.
4. Press [EXIT] to exit the video and return to the previous directory.
5. When enjoying the video, press [MENU] button to display/exit the menu. Press [▶/ENTER] to enter the submenu and press [◀/EXIT] to return to the upper menu.

Play/Pause: You can play/pause the video.

Repeat: Adjust the loop mode of video.

Show Info: View the video information.

Picture Mode: Select the picture mode from Vivid, Standard, Theater, Energy Savings and Custom.

Screen Mode: Select the screen aspect ratio from Normal, Zoom, Wide, Cinema and Auto.

Audio Mode: Select the audio mode from Standard, Theater, News, Music and Custom.

6. You can press [MTS/SAP] button one or more times to select the sound track. Press [ASPECT] button one or more times to enlarge the image by 1X, 2X, 4X and 8X.

Browse the Photos

1. Press [RED] button to switch the media type to Photo.
2. Press [▲/▼/◀/▶] to select the photo you want to view.
3. Press [ENTER] to browse the photo.
4. Press [EXIT] to return to the previous directory.
5. When browsing photos, press [MENU] button to display/exit the menu. Press [▶/ENTER] to enter the submenu and press [◀/EXIT] to return to the upper menu.

NOTE

When the photos in browsing or pausing, the menu will be different.

Play/Pause: You can browse/pause the photo.

Repeat: Repeats the slide show when it reaches the end.

Shuffle: Displays the slide show photo in random order.

Duration: Allows you to browse the photo at different speed. You can also press [GREEN] button to select it.

Effect: Set how the photo appears on the screen. You can also press [YELLOW] button to select it.

Rotate: Allows the photo to rotate 90 degrees.

Show Info: View the photo information.

Advanced Features

NOTES

- The unit recognizes only a USB Memory Stick.
- Do not use a USB hub or an extension cable to connect an external hard disk drive to the unit. (Not supported)
- A USB Memory Stick is always inserted to this unit directly.
- A USB Memory Stick is not supplied with this unit.
- We do not guarantee that all USB Memory Sticks can be supported by this unit.
- Be sure to keep a backup copy of the original files on your device before you play them back on this unit. We have no responsibilities for damage or loss of your stored data.
- To protect your USB Memory Stick files from being erased place the write protect sliding tab in the protect position.
- When you are ready to remove a USB Memory Stick, set the unit to go into Standby mode to avoid any damage to your data and the unit.
- A USB Memory Stick that requires its own driver or the device with a special system such as fingerprint recognition are not supported.
- This unit is not allowed to use the USB Memory Stick which requires an external power supply (300 mA or more).

Playable Format List

Video Decoder Support List

File extension	Container	Video Decoder	Resolution	Bitrate (bps)
*.avi	AVI	MPEG1	768*576	1.8M
		MPEG2 MP@HL	1920*1080	40M
		MPEG-4 SP@HL 3.0	1920*1080	40M
		MPEG-4 ASP@HL 4.0	1920*1080	40M
*.wmv	ASF	MPEG-4 SP@HL 3.0	1920*1080	40M
*.asf		MPEG-4 ASP@HL 4.0	1920*1080	40M
*.mp4	MP4	MPEG-4 SP@HL 3.0	1920*1080	40M
*.mov		MPEG-4 ASP@HL 4.0	1920*1080	40M
*.3gp	MKV	MPEG-4 SP@HL 3.0	1920*1080	40M
*.mkv		MPEG-4 ASP@HL 4.0	1920*1080	40M
*.mpg	PS	MPEG1	768*576	1.8M
*.mpeg				
*.vro		MPEG2 MP@HL	1920*1080	40M
*.vob				
*.ts	TS	MPEG2 MP@HL	1920*1080	40M
*.ogm	OGG	MPEG2 MP@HL	1920*1080	40M
		MPEG-4 SP@HL 3.0	1920*1080	40M
		MPEG-4 ASP@HL 4.0	1920*1080	40M

Audio Decoder Support List

File extension	Container	Audio Decoder
*.avi	AVI	MPEG1 Layer1/2
		MPEG2 AAC
		MPEG4 AAC-LC
		MPEG4 HE-AAC AC3
*.MP4	MP4	MPEG1 Layer1/2
		MPEG2 AAC
		MPEG4 AAC-LC
		MPEG4 HE-AAC
*.mpg	PS	MPEG1 Layer1/2
*.mpeg		
*.vro		AC3
*.vob		
*.ts	TS	MPEG1 Layer1/2
		MPEG2 AAC
		MPEG4 AAC-LC
		MPEG4 HE-AAC AC3
*.rm	RM	MP3 MPEG2 AAC
*.mkv	MKV	MPEG1 Layer1/2
		MPEG2 AAC
		MPEG4 AAC-LC
		MPEG4 HE-AAC
		AC3