

Using the Remote Control

Quick starts

Basic Operation

Connecting power cord to the TV

1. Connect the power cord to the connector on the back of the TV, if the power cord in accessories.
Note: When connecting the power cord to the connector of the TV, make sure the power cord is fully inserted in the place. Bad contact may cause high temperature of the connector and the risk of fire or other damages.
2. Connect the power cord to the AC power outlet.

Power ON/OFF

1. Connect the TV to a power outlet. If the power indicator is blue, it means that the TV is STANDBY. Press the Standby button on the front control or on the remote control to turn the TV on. Once the TV is turn on, the power indicator will be turned off. Several seconds later, the TV picture will be displayed on the screen.
2. Press the Standby button on the front control or on the remote control to turn the TV off temporarily.
3. Always remove the AC power plug from the outlet when not using this TV for a long period of time.

Signal source selection

Press the [INPUT] button to select TV, AV, Component, VGA and HDMI inputs. There are two ways to select the source: One is to press the [INPUT] button continuously, while the other is to use the ARROW and [ENTER] buttons to confirm the source.

Select channels

Please use [CH \wedge / CHV] button on the remote panel to select channels. [CH \wedge] indicates channel number up; [CHV] indicates channel number down. Press [CH \wedge / ChV] button on the side panel of the TV to select the channels. If you want to choose any of the skipped channels, press the number directly.

Use [Mute] button

Press the [Mute] button to mute the sound. Press the [Mute] button again to resume the sound.

Select picture modes

Press the [PICTURE] button to select the picture mode from four options: Standard, Cinema, User or Vivid. You can adjust the picture mode based upon your personal preference.

Select sound modes

Press the [AUDIO] button to select sound modes from Standard, Speech, User or Music.

Select screen modes

Press the [ASPECT] button to select from six zoom modes: Wide, Normal, Zoom, Cinema, Dot-to-Dot or Auto.

Use [GUIDE] button

Press the [GUIDE] button to display features of the ATSC program and the EPG function.

Use [DISPLAY] button

Press the [DISPLAY] button to view current source information.

Using the Remote Control

Quick starts

Use [EXIT] button

Press the [EXIT] button to exit the OSD menu.

Select channels by numbers

To select a channel: Press the channel number you would like to go to. For example, to select channel number 120, press buttons 1, 2 and 0, respectively and then press [ENTER] to confirm.

Use [MENU] button

Press the [MENU] button to display the TV OSD menu.

Use [LAST] button

Press the [LAST] button to return to the previous channel.

Use [ENTER] button

Press the [ENTER] button to select a particular item.

Adjust Volume

Press [VOLA / VOLV] button to adjust the volume.

Use [CCD] button

Press the [CCD] button to change the CCD mode. Using this button will set the Closed Caption mode when viewing a DTV or TV channel.

Note: Set the default Closed Caption setting for all channels in the Menu. For ATV the options are CC1, CC2, CC3, CC4, TEXT1, TEXT2, TEXT3, TEXT4 or Off. For DTV, the options are from Service1 to Service6 or Off.

Use [MTS/SAP] button

Press the [MTS/SAP] button to change the sound mode (Mono, Stereo, SAP). This button will select the MTS options of Stereo, SAP, or Mono in TV mode, alternate audio channels, and when available, in DTV mode.

Use [SLEEP] button

Press the [SLEEP] button repeatedly to set the sleep time, which can be set to: 10 Mins, 20 Mins, 30 Mins, 40 Mins, 50 Mins, 60 Mins, 90 Mins, 120 Mins or Off.

Use [TIME] button

Press the [TIME] button to display the current time.

Changing the TV Settings

Using the TV Menu

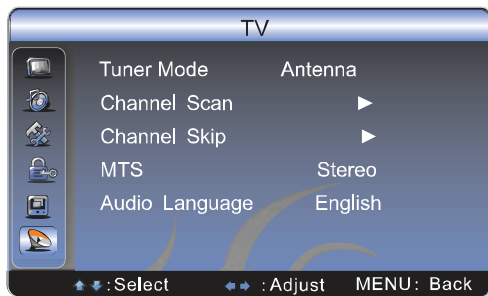

- 1 Press [MENU] button to display the main menu.
- 2 Press [▲/▼] button to select TV item.
- 3 Press [▶/ENTER] button to enter TV menu.
- 4 Press [▲/▼] button to select the option, press [▶/ENTER] button to enter or press [◀/▶] button to adjust the option.
- 5 Press the [Menu] button to close the menu.

You can adjust:

- Tuner Mode – Select the TV signal source. You can select Antenna or Cable.
- Channel Scan – Scans for channels that have signals and stores the channels information in memory.

DTV: The scanned TV programmes in digital signals.

TV: The scanned programmes in analog signals.

- Channel Skip – Deletes a channel stored in memory. When you press CH▲ or CHV, your TV skips the channel you deleted. You can still tune to the channel using the number buttons on the remote control.
- MTS – Selects the sound mode. You can select Mono, Stereo, or SAP (Second Audio Program)
- Audio Language – Selects the audio language for a program.

SAP (Second Audio Program) – Depending on the particular program being broadcast, you can listen to a foreign-language translation.

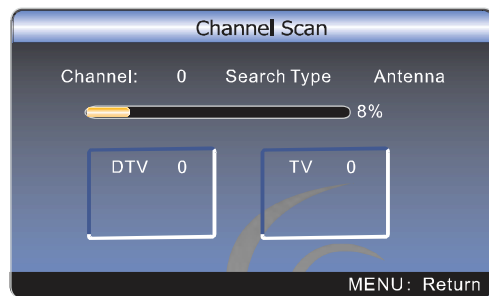

Changing the TV Settings

Using the Video Menu

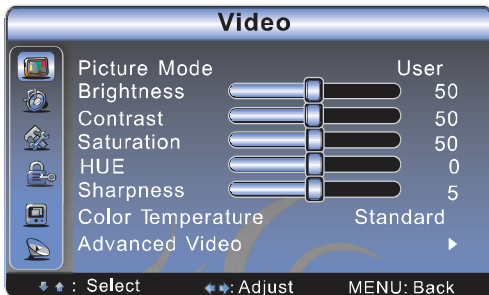

- 1 Press [MENU] button to display the main menu.
- 2 Press [▲/▼] button to select Video item.
- 3 Press [▶/ENTER] button to enter Video menu.
- 4 Press [▲/▼] button to select the option, press [▶/ENTER] button to enter or press [◀/▶] button to adjust the option.
- 5 Press the [Menu] button to close the menu.

You can adjust:

- Picture Mode – Adjusts the Picture Mode. You can select Standard, Cinema, User or Vivid.
- Brightness – You can increase or decrease the brightness of the picture. Increasing the brightness can add more light to dark areas of the picture, while decreasing the brightness can add more darkness to light areas of the picture.
- Contrast – You can increase or decrease the contrast of the picture. Increase the contrast to adjust the white areas of the picture or decrease the contrast to adjust the black areas of the picture.
- Saturation – Adjusts the intensity of the colors.
- Sharpness – You can increase the sharpness level for clearer images or decrease the sharpness level for smoother images.
- Color temperature – Changes the color temperature. You can select the color temperature from three options: Cool, Standard or Warm.
- Advanced Video – Accesses advanced video settings such as DNR, Adaptive Luma Control, Flesh Tone and MFC.

- ◇ DNR: It can optimize the picture signal from time and space; reduce the outside noise interference and return the pure initial signal. It has four ratings: Low, Standard, Strong and Off.
- ◇ Adaptive Luma Control: According to the content of picture, it can adjust brightness automatically.
- ◇ Flesh Tone: When this feature is "on" state, the TV could be the basis of image content, for color correction.



Changing the TV Settings

Using the Video Menu

- ◇ MFC: To improve the perception of moving images. The weak setting is suitable for most programs and is recommended for general viewing. normal and strong settings can further enhance motion, however on some cases can create a halo effect on edges of moving objects. You may need to switch settings pending the contents your viewing.

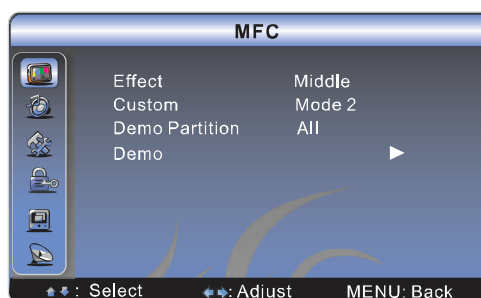

HISENSE using MFC's unique motion compensation technology, which eliminates the tail and jitter of dynamic images effectively, and makes the image edge clearer.

It reduce the dynamic screen blur which is difficult to be perceived by human eyes. Even playing rolling subtitles, the font edge is also clear.

Effect - Removes drag from fast scenes with a lot of movement to provide a clearer picture.

If you enable MFC (Motion Flow Compensation), noise may appear on the screen.

If this occurs, set "Effect" to off.

Custom : The TV can be set to automatically sense and process film signals from all sources and adjust the picture for optimum quality.

- Mode 1 : Adjusts the judder reduction level from video sources when playing 24Hz films.

- Mode 2 : Adjusts the blur reduction level from video sources.

Demo Partition - Press [◀/▶] buttons to choose left, right or all in the screen for MFC Demo.

Demo - This is only intended for use in retail environments.

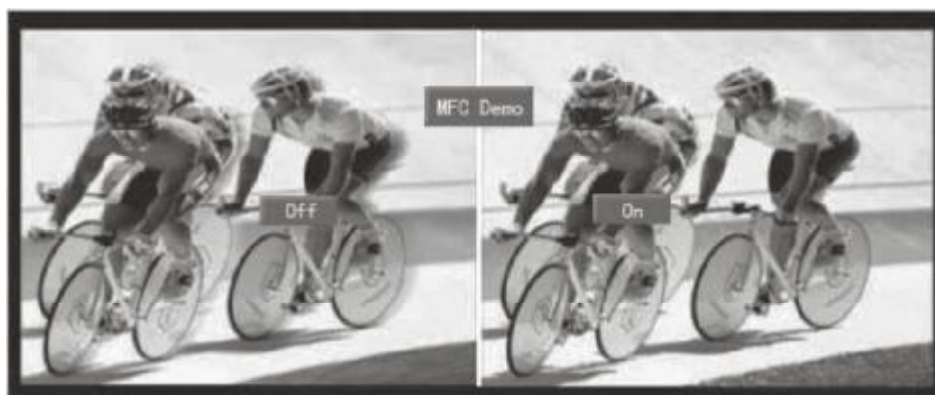

Changing the TV Settings

Using the Audio Menu

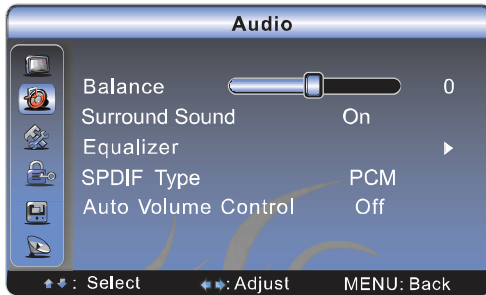

- 1 Press [MENU] button to display the main menu.
- 2 Press [▲/▼] button to select Audio item.
- 3 Press [▶/ENTER] button to enter Audio menu.
- 4 Press [▲/▼] button to select the option, press [▶/ENTER] button to enter or press [◀/▶] button to adjust the option.
- 5 Press the [Menu] button to close the menu.

You can adjust:

- Balance – Adjusts the volume of the left and right speakers.
- Surround Sound – Turns the surround sound effect on or off.
- Equalizer – Weaken or enlarge the sound of the main frequency points.
- SPDIF Type – Selects the SPDIF type. You can select PCM, Dolby Digital or Off.

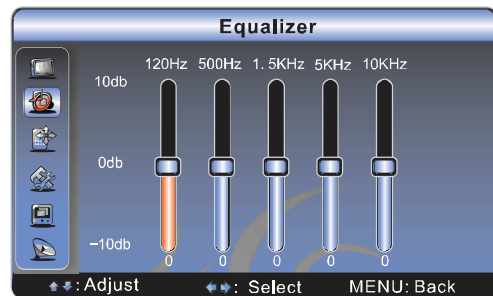

PCM - PCM is an encoding, mainly used for analog signal, Dolby mainly used for digital signal.

Dolby - when the data stream carries Dolby signal, digital SPDIF outputs Dolby data stream.

When the data stream carries no Dolby signal, it transports PCM data stream.

- Auto Volume Control – Adjust volume according to different audio signal.

Note: Via SPDIF Type, you can choose the digital audio out type. If Auto Volume Control is On, that means audio out control is activated.

Changing the TV Settings

Using the Setup Menu

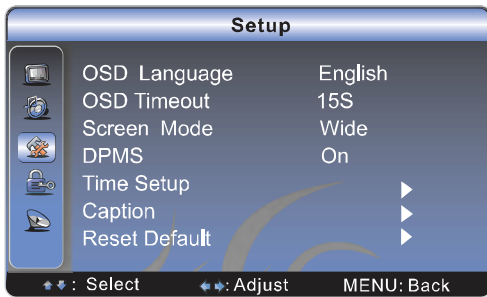

- 1 Press [MENU] button to display the main menu.
- 2 Press [▲/▼] button to select Setup item.
- 3 Press [▶/ENTER] button to enter Setup menu.
- 4 Press [▲/▼] button to select the option, press [▶/ENTER] button to enter or press [◀/▶] button to adjust the option.
- 5 Press the [Menu] button to close the menu.

You can adjust:

- OSD Language – Use the right or left arrow button to choose the OSD Language among English, Spanish and French.
- Screen Mode – Use the arrow button to choose the screen aspect ration from Wide, Normal, Zoom, Cinema, Dot-to-Dot or Auto.

1 Normal

The original 4:3 aspect ratio (1.33:1 signal) is preserved, so black bars are added to the left and right of the image. Standard TV broadcasts are displayed with a 4:3 aspect ratio.



2 Wide

When watching a standard broadcast or full-frame movie in this mode, the display image is stretched proportionately to fill the TV screen. When watching a widescreen (1.78:1 signal) program or movie, the display image fills the TV



3 Zoom

Stretches the 4:3 aspect ratio image vertically and horizontally to fill the screen at 1:1.78 aspect ratio.



Changing the TV Settings

Using the Setup Menu

4 Cinema

Stretches the 4:3 aspect ratio image vertically and horizontally to fill the screen at 1:2.35 aspect ratio.



5 Dot to dot

Use the function to see the full image without any cutoff, when HDMI (720p/1080i/1080p), Component (1080i/1080p), DTV (1080i) or VGA signals are inputs.



- DPMS – This is a good function for a computer monitor. When DPMS is on, the computer will control the screen on or off. For example, if the computer is in sleep mode, the screen will be switched off. If the computer is activated, the screen also is activated.
- Time Setup – You can set up the exact time by yourself. You can also set up Sleeper Time and Auto Sleep Time.

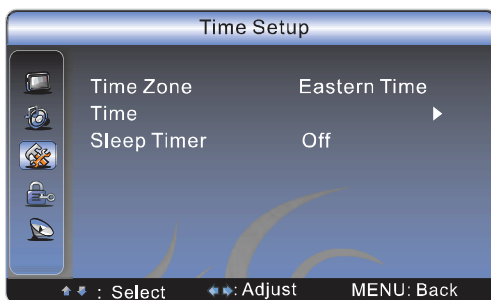

Changing the TV Settings

Using the Setup Menu

- Caption: There are three items in it – Analog Closed Caption, Digital Closed Caption and Digital Caption Style.

This is a function about caption, display caption by analog signal and display caption by digital signal.

Analog Closed Caption: CC1, CC2, CC3, Cc4, TEXT1, TEXT2, TEXT3, TEXT4.

Digital Closed Caption: Service1, Service2, Service3, Service4, Service5, Service6.

Digital Caption Style: There are two Caption Styles. One is the automatic function set as the broadcaster, while the other is the custom style where you can adjust the font size, color, opacity, background color etc., accordingly.

- Reset Default – Every TV has its original setting before leaving the factory. So this function helps you restore these settings.

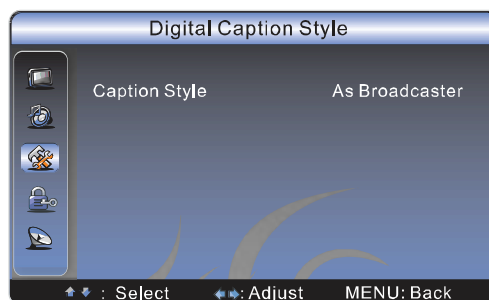
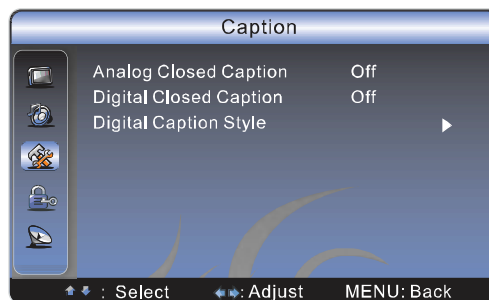

Changing the TV Settings

Using the Parental Menu

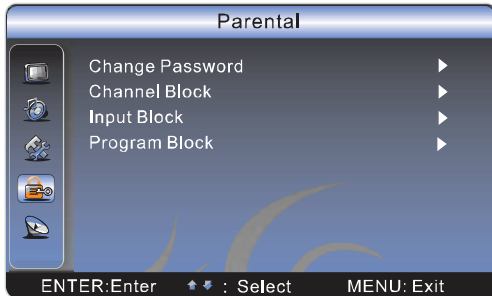

- 1 Press [MENU] button to display the main menu.
- 2 Press [▲/▼] button to select Parental item.
- 3 Press [▶/ENTER] button to enter Parental menu.
- 4 Press [▲/▼] button to select the option, press [▶/ENTER] button to enter or press [◀/▶] button to adjust the option.
- 5 Press the [Menu] button to close the menu.

When you first use this function, the default password is [0000].

Once you input this password, you can: Press ▲/▼ to highlight an option, then press ◀/ ▶ to adjust the option. You can adjust:

- Change Password – The first time you use this function, use the default password. If you want to change it, first enter the new password then enter the same password again.
- Channel Block – This function will let you block any channel you want.
- Input Block – You can block the input source with this function. For example, if you want to block AV input, just highlight [AV] and press [ENTER]. The AV input will not be seen in the screen.
- Clean All – This function will let you clean all the channels stored on this TV.

Note: If you choose this function, all the programs you preset will be lost.

- Program Block–
 - A. Rating Enable is on.
 - B. U. S. TV Ratings: You can choose TV ratings according to the illustration on the screen.
 - C. The settings for U. S. Movie Ratings, Canada (English) Ratings and Canada (French) Ratings follow Step B.

If you want to block the unrated program, please turn on this function.

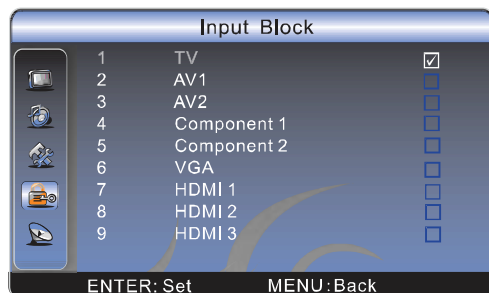
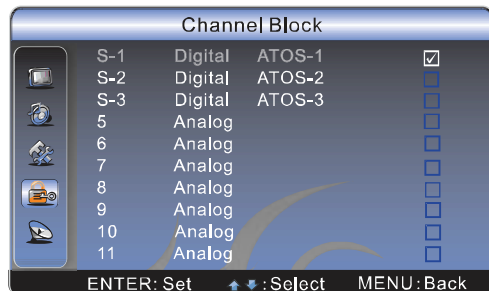

Changing the TV Settings

Using the Parental Menu

Following is the description of these ratings.

Age	Defined as
TV-Y	All children
TV-Y7	Directed to older children
TV-G	General audience
TV-PG	Parental Guidance suggested
TV-14	Parents Strongly cautioned
TV-MA	Mature Audience only

Contents	Defined as
FV	Fantasy Violence
D	Suggestive dialogue
L	Strong language
S	Sexual situations
V	Violence

Rating	Defined as
G	General audience
PG	Parental Guidance suggested
PG-13	Parents strongly cautioned
R	Restricted
NC-17	No one 17 and under admitted
X	Adult audience only

Changing the TV Settings

Using the Parental Menu

About Canada (French)

Rating	Description
G	General
8 ans+	8+General; Not recommended for young children
13 ans+	Programming may not be suitable for children under the age of 13
16 ans+	Programming is not be suitable for children under the age of 16
18 ans+	Programming restricted to adults

About Canada (English)

Rating	Description
C	Children
C8+	Children eight years and older
G	General Programming, suitable for all audiences
PG	Parents Guidance
14+	Viewers 14 years and older
18+	Adult programming

NOTE: As you block rating, all rating higher than the ones you select are blocked as well. For example, if you choose to block the MPAA rating R, the higher ratings, NC-17 and X, are automatically blocked too .

Appendix

Trouble shooting

Before calling a service technician, please check the following table for a possible cause of the problem and some solutions.

Customer important notice: If the TV can not be operated, please unplug the power and restart .

Symptoms	Possible Solutions
TV will not turn on	<ul style="list-style-type: none">▪ Make sure the power cord is plugged in, then press Power (Standby).▪ The remote control batteries may be dead. Replace the batteries.▪ Unplug the VGA wire and plug the power wire again.
No picture, no sound	<ul style="list-style-type: none">▪ Check if you have set the timer off.▪ Check the antenna/cable connections.▪ Press [Display] to see if you have selected the right signal source.
No sound, picture OK	<ul style="list-style-type: none">▪ The sound may be muted. Press [VOL+] on the remote control.▪ The station may have broadcast difficulties. Try another channel.▪ Check the speakers cable connections.
Poor sound, picture OK	<ul style="list-style-type: none">▪ The station may have broadcast difficulties. Try another channel▪ Check the speakers cable connections.
Poor picture, sound OK	<ul style="list-style-type: none">▪ Check the antenna connections.▪ The station may have broadcast difficulties. Try another channel.▪ Adjust the picture from the menu.
Unable to select a certain channel	<ul style="list-style-type: none">▪ The channel may be skipped. Choose this channel by directly selecting the buttons from the remote control.
Poor colour or no colour	<ul style="list-style-type: none">▪ The station may have broadcast difficulties. Try another channel.▪ Adjust Saturation in the Video settings menu.
The remote control does not operate	<ul style="list-style-type: none">▪ There may be an obstruction between the remote control and the remote control sensor.▪ The batteries may be installed with a wrong polarity.▪ The remote control batteries may be dead. Replace the batteries.
Disorder display at power on	<ul style="list-style-type: none">▪ This may be caused because of a very short interval between POWER OFF and ON.▪ Unplug the power and restart.

Appendix

Specifications

Model	LTDN46K15US
Screen Diagonal Size	46 inches
Screen Resolution	1920X1080 Pixels
Power Consumption	125W
Wall-mount screws pattern	M6X25mm (4 pcs)
Wall-mount dimension(VESA)	200mm X 200mm
Size with base(inch)(L X WX H)	53.5X6.5X33.3
Weight with base(lbs)	44.2 lbs
Power Supply	AC 60Hz 120V
Television System	American TV standard NTSC / ATSC system
Audio multiplex	BTSC system
Channel coverage	VHF: 2~13 UHF: 14~69 CATV: 1~125
	Digital Terrestrial Broadcast (8VSB): 2~69
	Digital Cable(64/256 QAM): 1~135
Sound Output Power (RMS)	8W+8W
Component (Y/Pb/Pr) mode	480I/60Hz, 480P/60Hz, 720P/60Hz, 1080I/60Hz, 1080P/60Hz
PC (VGA) mode	640X480/60Hz, 800X600/60Hz, 1024X768/60Hz 1280X1024/60Hz
HDMI mode	480I/60Hz, 480P/60Hz, 720P/60Hz, 1080I/60Hz, 1080P/60Hz
	640X480/60Hz, 800X600/60Hz, 1024X768/60Hz
Environmental Conditions	Temperature 5°C~35°C (41F~95F)
	Humidity : 20%-80%RH
	Atmospheric pressure: 86kPa-106kPa
Supplied accessories	Remote control, Batteries, User Manual.

Note: Design and specifications are subject to change without notice.

CUSTOMER NOTICE: Use carefully when operating to prevent damage to the screen.

Wall Brackets Manual

The wall bracket contains the following components:

1. Hook Quantity 1 2. Hoisting cable Quantity 1 3. Mounting bracket Quantity 2

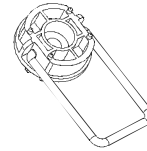
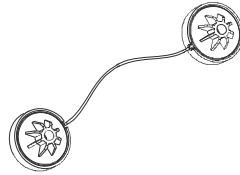
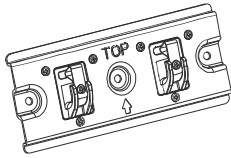

4. Expansion bolt components
3 sets

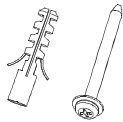

5. Screw, M8X25 and M6X25
4 separately

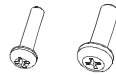

6. Rubber Washer
Quantity 4

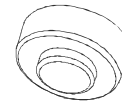

Wall Bracket Installing Instructions

Step 1 Hook installing

Note: The applicable wall where the wall bracket is to be installed is concrete wall. Wood or gypsum structures wall are in need of special reinforcement and can not be used directly.

1. Please drill fixation holes for expansion bolt on the wall according to the model of your wall bracket and the requirement shown in the following diagram.

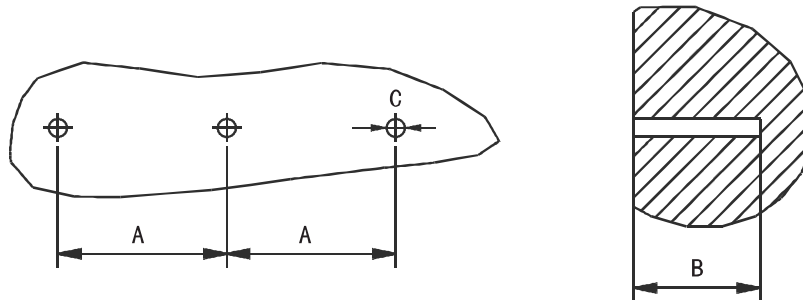

LG 019 Hole Pitch, A=94mm Hole Depth, B=70mm Hole Diameter, C=10mm

LG 020 Hole Pitch, A=146mm Hole Depth, B=70mm Hole Diameter, C=10mm

2. Put nylon sleeve into the holes respectively as the following diagram shows.

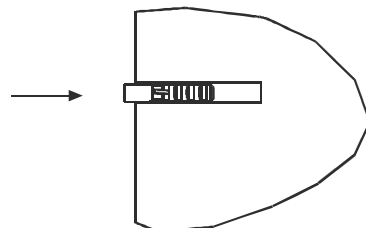

3. Fix Hook

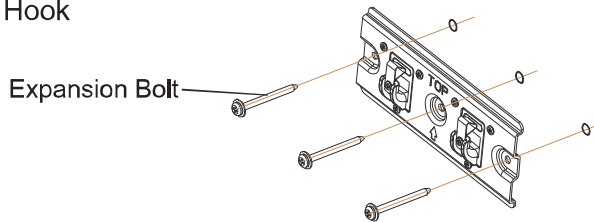

Step 2 Hoisting cable and mounting bracket installing

1. Lay the TV on the level desktop with its screen downwards. Please be noted that the desktop should be covered with soft materials to avoid scratching the front of surface.
2. Remove the four screws where the wall bracket is on the back of TV.
3. Fix hoisting cable and mounting bracket, select screws between M8X25 and M6X25 according to the diameter of the holes of the wall bracket, and install washer to avoid scratching the wall.

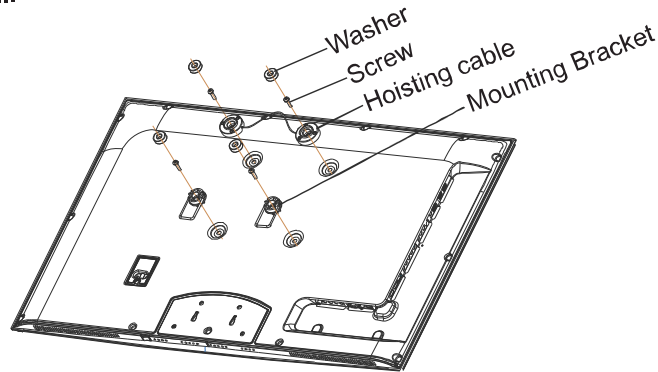

Step 3 Hang over TV

Hang over TV on the hook which has installed hoisting cable and mounting bracket and adjust the angle of TV to horizontality. The hanged over TV is as the following diagram shows.

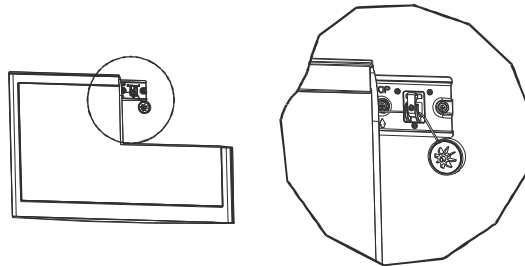

Note: This process requires multiple people to operate to avoid scratching TV or wall.

The use of mounting bracket: Mounting bracket applies to plug /unplug signal cable in TV hang-over state as shown in the following diagram.

