

**Hisense**  
INNOVATION IS LIFE

印刷条码

# USER MANUAL

Before using the TV, please read this manual thoroughly and retain it for future reference.

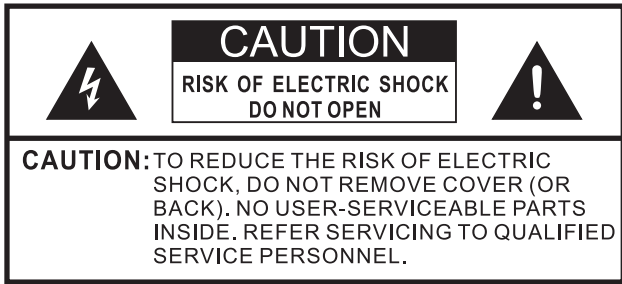

The lightning flash with arrowhead symbol, within an equilateral triangle is intended to alert the user to the presence of uninsulated dangerous voltage within the product's enclosure that may be of sufficient magnitude to constitute a risk of electric shock.



The exclamation point within an equilateral triangle is intended to alert the user to the presence of important operating and maintenance (servicing) instructions in the literature accompanying the appliance.

## FCC Statement

### NOTE:

This equipment has been tested and found to comply with the limits for a class B digital Device, pursuant to part 15 of the FCC Rules. These limits are designed to provide reasonable protection against harmful interference in a residential installation. This equipment generates, uses and can radiate radio frequency energy and, if not installed and used in accordance with the instructions, may cause harmful interference to radio Communications. However, there is no guarantee that interference will not occur in a particular installation. If this equipment does cause harmful interference to radio or television reception, which can be determined by turning the equipment off and on, the user is encouraged to try to correct the interference by one or more of the following measures:

- Reorient or relocate the receiving antenna.
- Increase the separation between the equipment and the receiver.
- Connect the equipment into an outlet on a circuit different from that to which the receiver is connected.
- Consult the dealer or an experienced radio/TV technician for help.

FCC ID Number WiFi Module: WWMMN421V1

### ! WARNING

The manufacturer is not responsible for any radio or TV interference caused by unauthorized modifications to this equipment. Such modifications could void the user's authority.

## Energy Star

Your Hisense TV is ENERGY STAR®

qualified in the "Home" mode. It meets strict energy efficiency guidelines set by the U.S. Environmental Protection Agency and Department of Energy. ENERGY STAR is a joint program of these government agencies, designed to promote energy efficient products and practices. Changes to certain features, settings, and functionalities of this TV (i.e. TV Guide, Picture, Sound) can increase or change the power consumption. Depending upon such changed settings, the power consumption may exceed the limits required for the ENERGY STAR qualification in the "Home" mode.



### ☑ NOTE

Where the MAINS plug or an appliance coupler is used as the disconnect device, the disconnect device shall remain readily operable.

This TV incorporates High-Definition Multimedia Interface (HDMI™) technology. HDMI, the HDMI logo and High-Definition Multimedia Interface are trademarks or registered trademarks of HDMI Licensing LLC.



Hisense and associated logos where applicable are registered trademarks of Hisense Group in the United States and/or other countries. All other trademarks are property of their respective owners. 2011 Hisense USA, Corporation. All Rights Reserved. Manufactured under license from Dolby Laboratories. Dolby and the double-D symbol are trademarks of Dolby Laboratories.



\* Specifications subject to change without notice. All other trademarks, logos and copyrights are the property of their respective owners.

# CHILD SAFETY:

It Makes A Difference How and Where  
You Use Your Flat Panel Display

Congratulations on your purchase! As you enjoy your new product, please keep these safety tips in mind:



## THE ISSUE

- The home theater entertainment experience is a growing trend and larger flat panel displays are popular purchases. However, flat panel displays are not always supported on the proper stands or installed according to the manufacturer's recommendations.
- Flat panel displays that are inappropriately situated on dressers, bookcases, shelves, desks, speakers, chests or carts may fall over and cause injury.

## THIS MANUFACTURER CARES!

- The consumer electronics industry is committed to making home entertainment enjoyable and safe.

## TUNE INTO SAFETY

- One size does NOT fit all. Follow the manufacturer's recommendations for the safe installation and use of your flat panel display.
- Carefully read and understand all enclosed instructions for proper use of this product.
- Don't allow children to climb on or play with furniture and television sets.
- Don't place flat panel displays on furniture that can easily be used as steps, such as a chest of drawers.
- Remember that children can become excited while watching a program, especially on a "larger than life" flat panel display. Care should be taken to place or install the display where it cannot be pushed, pulled over, or knocked down.
- Care should be taken to route all cords and cables connected to the flat panel display so that they cannot be pulled or grabbed by curious children.



## WALL MOUNTING: IF YOU DECIDE TO WALL MOUNT YOUR FLAT PANEL DISPLAY, ALWAYS:

- Use a mount that has been recommended by the display manufacturer and/or listed by an independent laboratory (such as UL, CSA, ETL).
- Follow all instructions supplied by the display and wall mount manufacturers.
- If you have any doubts about your ability to safely install your flat panel display, contact your retailer about professional installation.
- Make sure that the wall where you are mounting the display is appropriate. Some wall mounts are not designed to be mounted to walls with steel studs or old cinder block construction. If you are unsure, contact a professional installer.
- A minimum of two people are required for installation. Flat panel displays can be heavy.

 **CEA**  
Consumer Electronics Association  
[www.CE.org/safety](http://www.CE.org/safety)

## Important Safety Instructions

1. Read these instructions.
2. Keep these instructions.
3. Heed all warnings.
4. Follow all instructions.
5. Do not use this apparatus near water.
6. Clean only with dry cloth.
7. Do not block any ventilation openings. Install in accordance with the manufacturer's instructions.
8. Do not install near any heat sources such as radiators, heat registers, stoves, or other apparatus (including amplifiers) that produce heat.
9. Do not defeat the safety purpose of the polarized or grounding-type plug. A polarized plug has two blades with one wider than the other. A grounding type plug has two blades and a third grounding prong. The wide blade or the third prong are provided for your safety. If the provided plug does not fit into your outlet, consult an electrician for replacement of the obsolete outlet.
10. Protect the power cord from being walked on or pinched particularly at plugs, convenience receptacles, and the point where they exit from the apparatus.
11. Only use attachments/accessories specified by the manufacturer.
12. Use only with cart, stand, tripod, bracket, or table specified by the manufacturer, or sold with the apparatus. When a cart is used, use caution when moving the cart/apparatus combination to avoid injury from tip-over.
13. Unplug this apparatus during lightning storms or when unused for long periods of time.
14. Refer all servicing to qualified service personnel. Servicing is required when the apparatus has been damaged in any way, such as power-supply cord or plug is damaged, liquid has been spilled or objects have fallen into the apparatus, the apparatus has been exposed to rain or moisture, does not operate normally, or has been dropped.
15. Apparatus should not be exposed to dripping or splashing, and objects filled with liquids, such as vases, should not be placed on the apparatus.
16. An outside antenna system should not be located in the vicinity of overhead power lines or other electric light or power circuits, or where it can fall into such power lines or circuits. When installing an outside antenna system, extreme care should be taken to keep from touching such power lines or circuits, as contact with them might be fatal.
17. Do not overload wall outlets and extension cords, as this can result in a risk of fire or electric shock.
18. Do not push objects through any openings in this unit, as they may touch dangerous voltage points or short out parts that could result in fire or electric shock. Never spill or spray any type of liquid into the unit.



S3125A

19. If an outside antenna or cable system is connected to the unit, be sure the antenna or cable system is grounded to provide some protection against voltage surges and built-up static charges, Section 810 of the National Electrical Code, ANSI/NFPA 70, provides information with respect to proper grounding of the mast and supporting structure, grounding of the lead-in wire to an antenna discharge unit, size of grounding conductors, location of antenna discharge unit, connection to grounding electrodes, and requirements for the grounding electrode.

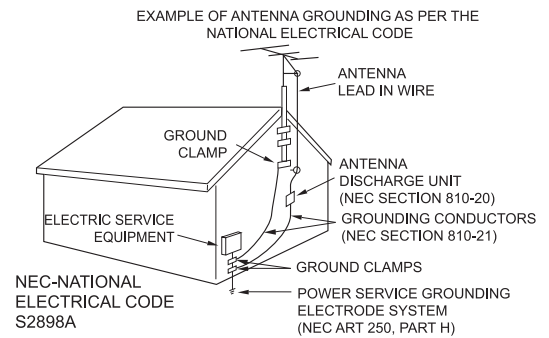

20. When replacement parts are required, be sure the service technician uses replacement parts specified by the manufacturer or those that have the same characteristics as the original part. Unauthorized substitutions may result in fire, electric shock or other hazards.
21. Upon completion of any service or repairs to this unit, ask the service technician to perform safety checks to determine that the unit is in proper operating condition.
22. When you connect the product to other equipment, turn off the power and unplug all of the equipment from the wall outlet. Failure to do so may cause an electric shock and serious personal injury. Read the owner's manual of the other equipment carefully and follow the instructions when making any connections.
23. Sudden high volume sound may cause hearing or speaker damage. When you use headphones, (if the unit is equipped with a headphone jack) keep the volume at a moderate level. If you use headphones continuously with high volume sound, it may cause hearing damage.

### CONDENSATION:

Moisture will form in the operating section of the unit if the unit is brought from cool surroundings into a warm room or if the temperature of the room rises suddenly. When this happens, unit's performance will be impaired. To prevent this, let the unit stand in its new surroundings for about an hour before switching it on, or make sure that the room temperature rises gradually.

Condensation may also form during the summer if the unit is exposed to the breeze from an air conditioner. In such cases, change the location of the unit.

# Important Safety Instructions

## HOW TO HANDLE THE LCD PANEL:

- Do not press hard or jolt the LCD panel. It may cause the LCD panel glass to break and injury may occur.
- If the LCD panel is broken, make absolutely sure that you do not touch the liquid in the panel. This may cause skin inflammation.  
If the liquid gets in your mouth, immediately gargle and consult with your doctor. Also, if the liquid gets in your eyes or touches your skin, consult with your doctor after rinsing for at least 15 minutes or longer in clean water.

## Possible Adverse Effects on LCD Panel:

If a fixed (non-moving) pattern remains on the LCD Panel for long periods of time, the image can become permanently engrained in the LCD Panel and cause subtle but permanent ghost images. This type of damage is NOT COVERED BY YOUR WARRANTY. Never leave your LCD Panel on for long periods of time while it is displaying the following formats or images:

- Fixed Images, such as stock tickers, video game patterns, TV station logos, and websites.
- Special Formats that do not use the entire screen. For example, viewing letterbox style (16:9) media on a normal (4:3) display (black bars at top and bottom of screen); or viewing normal style (4:3) media on a widescreen (16:9) display (black bars on left and right sides of screen).

**The following symptoms are not signs of malfunction but technical limitation. Therefore we disclaim any responsibility for these symptoms.**

- LCD Panels are manufactured using an extremely high level of precision technology, however sometimes parts of the screen may be missing picture elements or have luminous spots.  
This is not a sign of a malfunction.
- Do not install the LCD Panel near electronic equipment that produces electromagnetic waves. Some equipment placed too near this unit may cause interference.
- Effect on infrared devices - There may be interference while using infrared devices such as infrared cordless headphones.

## Declaration of Conformity

This device complies with part 15 of the FCC Rules. Operation is subject to the following two conditions:  
(1) This device may not cause harmful interference and (2) This device must accept any interference received, including interference that may cause undesired operation.

## End of life directives

Your TV also contains material that can be recycled and reused. For disposal or recycling information, contact your local authorities or the Electronic Industries Alliance at [www.eia.org](http://www.eia.org) to find a recycler in your area.

## Non-active pixels

The LCD panel contains almost 3 million thin film transistors, which provide exceptionally sharp video quality. Occasionally, a few non-active pixels may appear on the screen as a fixed black (in the case of a dead pixel), blue, green, or red point. These non-active pixels do not adversely affect the performance of your TV, and are not considered defects.

## Power source

### TO USE AC POWER

1. The power cord is attached to the TV at the factory.
2. Connect the AC cord into an AC outlet.

### ⚠ WARNING

Do not connect this unit to the power using any device other than the supplied AC cord. This could cause fire, electrical shock, or damage.

Do not use with a voltage other than the power voltage specified. This could cause fire, electrical shock, or damage.

### ⚠ CAUTION

When this unit is not used for a long time, (e.g., away on a trip) in the interest of safety, be sure to unplug it from the AC outlet.

Do not plug/unplug the AC cord when your hands are wet. This may cause electrical shock.



## Important Safety Instructions

**Disclaimer:** Hisense USA companies ("Hisense"). A wired or wireless Internet connection is required for certain features and is not included with the television; please contact a local Internet Service Provider for assistance. Content suppliers may require a subscription to activate or use their services which is not included with the television and is sold separately. The Hisense TV web browser supports a variety of multimedia platforms however it does not support all players nor does it support every player version, therefore, access to certain web content may be limited or unavailable.

**INTERNET CONNECTION, ACCEPTANCE OF END USER LICENSE AGREEMENT (EULA) AND REGISTRATION OF YOUR HISENSE TELEVISION SERIAL NUMBER IS REQUIRED. YOU MUST BE AT LEAST 13 YEARS OF AGE TO REGISTER ONLINE. HISENSE MAY ADD, DELETE, MODIFY, OR TERMINATE ONLINE SERVICES WITHOUT NOTICE.**

**Consent to Use of Data:** To facilitate the provision of software updates, any dynamically served content, product support and other services you agree that Hisense and its affiliates may collect, use, store and transmit technical and related information that identifies your television (including an Internet Protocol Address), its operating system, application software and any connected devices. Hisense and its affiliates may also use this information in the aggregate, in a form which does not personally identify you, to improve our products and services and we may share anonymous aggregate data with our third party service providers.

**Internet Performance Issues:** A broadband Internet connection is required for access to Internet Apps and Content. To avoid poor performance while accessing Internet Apps and Content, be sure other devices on the same Internet connection are not running file sharing applications, streaming audio or video content and are not logged in to chat-rooms. These applications may consume your connection's bandwidth, causing lag or other undesirable effects. This television uses TCP and UDP port(s) to access Internet Apps and Content. Please consult your router or personal firewall documentation for information on how to allow access to these ports. If you are installing this television on a corporate Internet connection, contact your network administrator for information and assistance.

**Liability:** The Hi-Smart portal may be linked to other sites on the World Wide Web or Internet which are not under the control of or maintained by Hisense. Such links do not constitute an endorsement by Hisense. You acknowledge that Hisense is providing these links to you only as a convenience; you further agree that Hisense is not responsible for the content of such sites.

**INFORMATION ACCESSED OR OBTAINED VIA Hi-Smart IS PROVIDED "AS IS" WITHOUT WARRANTY OF ANY KIND, EITHER EXPRESS OR IMPLIED, INCLUDING BUT NOT LIMITED TO, THE IMPLIED WARRANTIES OF MERCHANTABILITY, FITNESS FOR A PARTICULAR PURPOSE, OF NON INFRINGEMENT. SOME JURISDICTIONS DO NOT ALLOW FOR THE EXCLUSION OF IMPLIED WARRANTIES, SO THE ABOVE EXCLUSIONS MAY NOT APPLY TO YOU.**

Access to certain areas of the Hi-Smart portal is restricted and requires a password for entry. If you are an authorized password holder, you agree that you are entirely responsible for the confidentiality of your password and account information, and agree to notify Hisense immediately if your password is lost, stolen, disclosed to an unauthorized third party, or other wise may have been compromised. You agree that you are entirely responsible for any and all activities which occur under your account, including any fees which may be incurred under your password protected account whether or not you are the individual who undertakes such activities. You agree to immediately notify Hisense of any unauthorized use of your account or any other breach of security in relation thereof known to you.

You acknowledge that Hi-Smart may include certain inaccuracies or typographical errors which may affect the quality of materials and third-party content. You acknowledge that the materials or any third-party content have not been independently verified or authenticated in whole or in part by Hisense, and agree that Hisense does not warrant the accuracy or timeliness of materials or the third-party content, and further agree that Hisense has no liability for any omissions in the materials and content, whether provided by Hisense or any third-party.

To the maximum extent permitted by applicable law, Hisense shall not be liable to you or a third-party claiming through you for any damage suffered as a result of your displaying, copying or downloading information or material accessed or obtained via Hi-Smart. In no event shall Hisense be liable to you or any third-party for any indirect, extraordinary, exemplary, punitive, special incidental or consequential damages (including loss of data, revenue, profits or other economic advantage) however arising, whether for breach or in tort even if HISENSE has previously advised of the possibility of such possible damage.

**Technical Support:** If you have questions regarding installation, configuration or operation of this product, please telephone a Hisense Customer Care representative who will be happy to assist you with any difficulties you may be experiencing.

Dial: 1-888-935-8880 (Toll Free)  
Email: [service@hisense-usa.com](mailto:service@hisense-usa.com)

# Contents

## Getting Started

Accessories List.....	3
Installing the Stand.....	3
Installing a Wall-Mount Bracket.....	4
When Installing the TV Against a Wall or Enclosed Area.....	5
Viewing the Control Panel.....	6
Viewing the Remote Control.....	7
Installing Batteries in the Remote Control.....	8
Match the Remote Control with TV.....	8
Making Connections.....	9

## Basic Features

Turning the TV on or off.....	13
Turning the TV On for the First Time.....	13
Selecting the Input Source.....	13
Changing Channels / Volume.....	14
Shortcuts Instructions.....	14
To Use the Menu.....	15
Using the Picture Menu.....	15
Using the Audio Menu.....	15
Using the Screen Menu.....	16
Using the Channels Menu.....	16
Using the Settings Menu.....	17
Using the Lock Menu.....	18

## Advanced Features

Network Connection.....	19
DLNA Settings.....	22
Media Share Settings in Computer.....	23
Settings to Share Files.....	23



# Contents

## Advanced Features

Network Function.....	24
Enter the Network Applications.....	25
VUDU HD Movies.....	25
VUDU Apps .....	27
Netflix.....	27
Opera.....	28
YouTube .....	30
Other Apps.....	31
Other Information.....	32
Digital Media Play.....	33
Enjoy Video Files.....	33
Enjoy Music Files.....	34
Browse the Pictures.....	34
Browse the Text Files .....	35

## Other Information

Trouble Shooting .....	36
General.....	38

***Illustrations are for your reference only!***

# Getting Started

## Accessories List



User Manual



Quick Setup Guide



Warranty Card



Remote Control



Battery × 2



Screws: Screws for 32" (ST4×L16)×3



Screws for 42" (M6×L12)×4

## Installing the Stand

### NOTES

1. The LCD display is very fragile, and must be protected at all times when removing the base stand. Be sure that no hard or sharp object, or anything that could scratch or damage the LCD display, comes into contact with it. DO NOT exert pressure on the front of the TV at any time because the screen could crack.
2. For tabletop use, the TV must be attached to the provided stand as shown on this page.
3. To Wall-Mount, brackets (not provided) must be attached to the TV as shown on next page.

### WARNING

Be sure to disconnect the AC power cord before installing a stand or Wall-Mount brackets.

### CAUTION

Use a covered table or bench to lay the TV on and handle the TV carefully to prevent damage to the TV screen or cabinet during assembly.

Follow the illustrations below to complete the installation steps:

#### ● 32D77W

1. Attach the stand to the TV set as shown in the picture.
2. Use the screws (ST4XL16)X3 to fix the stand tightly.

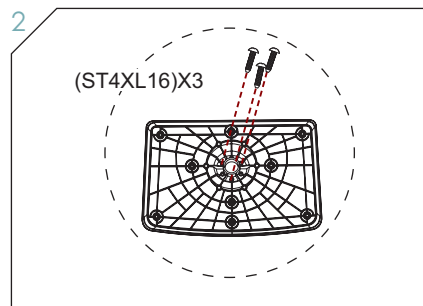
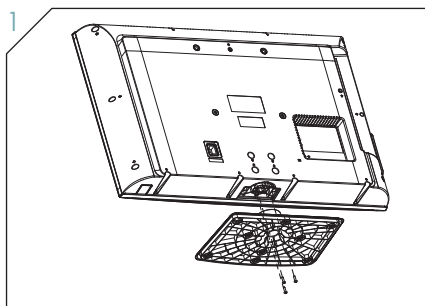

# Getting Started

## ● 42D77W

1. Take out the base and insert it into the installing slot in the lower part of the TV until all of the holes match each other.
2. Fasten the base and the TV set together with the 4×(M6×L12) screws provided.

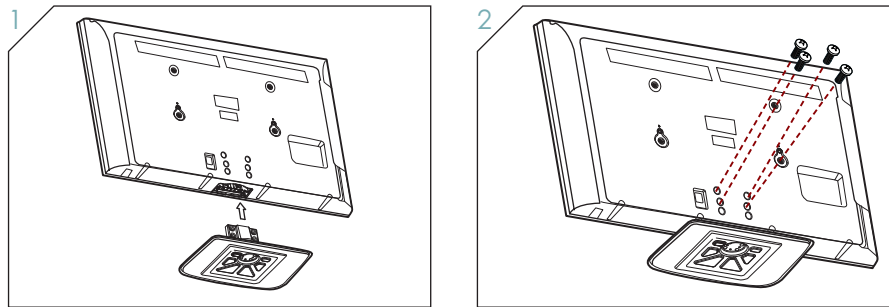

## Installing a Wall-Mount Bracket

If you want to attach the TV to a Wall-Mount bracket (not provided), you should first remove the stand if it is pre-attached .

1. Place the spacers (not provided) in the corresponding bracket holes. Attach purchased bracket (1.5 ~ 2.5 mm thickness) on the TV with 4 screws (M6 × L25)(not provided) . Follow instructions provided with the wall bracket.

32D77W

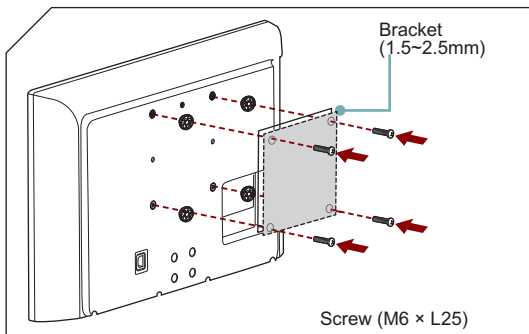

Wall-Mount hole pattern VESA (mm)	200 × 200
Wall-Mount screw size (mm)	M6

42D77W

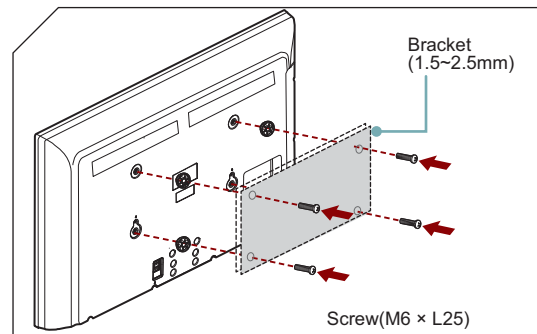

Wall-Mount hole pattern VESA (mm)	400 × 200
Wall-Mount screw size (mm)	M6

### ⚠ WARNING

Use only the 4 screws (M6 × L25) (not provided) to prevent internal damage to the TV set or cause it to fall.

2. Follow instructions provided with the Wall-Mount bracket.
  - If you are not sure of your ability to do complete the installation, contact a professional installer or service technician for assistance. The manufacturer is not responsible for any damages or injuries that occur due to mishandling or incorrect assembly.
  - The selected screws are 6.5 ~ 7.5 mm in length when measured from the attaching surface of the TV's rear cover. The diameter and length of the screws differ depending on the Wall-Mount Bracket model.

# Getting Started

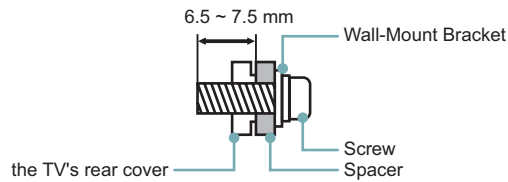

## When Installing the TV Against a Wall or Enclosed Area

Make sure that your TV has adequate air circulation. Allow enough space around the TV as shown below. Avoid operating the TV at temperatures below inadequate air 41°F (5°C).

### Install with stand

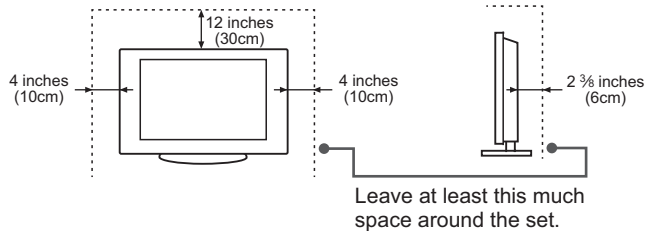

### Install on the wall

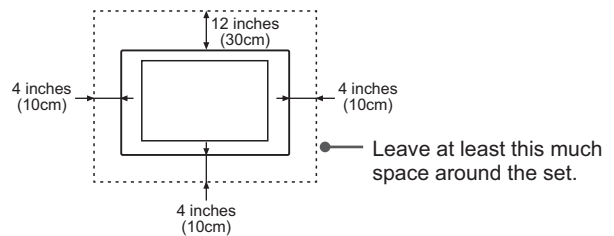

### Never install the TV set as follows:

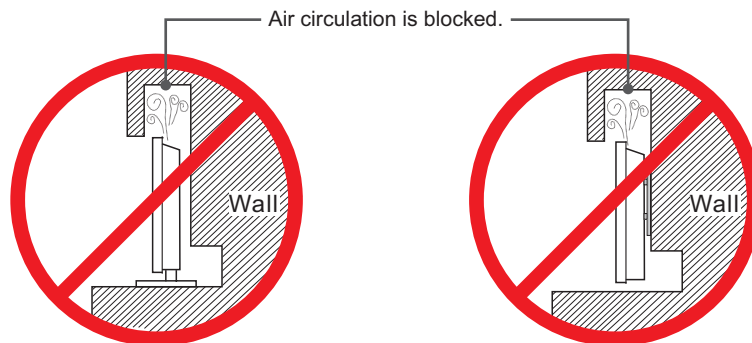

**Inadequate air circulation can lead to overheating of the TV and may cause damage to your TV or cause a fire.**

# Getting Started

## Viewing the Control Panel

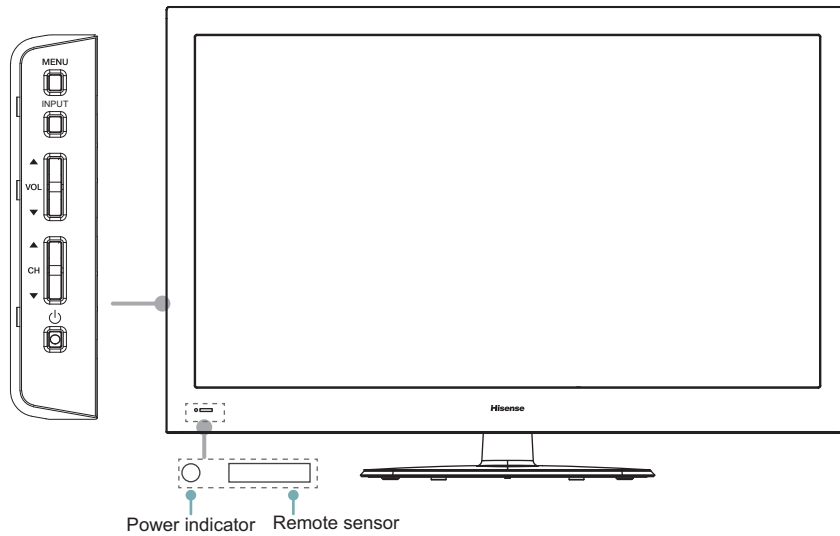

<b>item</b>	<b>Description</b>
<b>Power Sensor</b>	Receives remote signals from the remote control. Do not put anything near the sensor, as its function may be affected.
<b>Power Indicator</b>	Light up in standby mode.
<b>MENU</b>	Open or close the OSD menu
<b>INPUT</b>	Select among the different signal sources.
<b>CH▲/CH▼</b>	Select the channel
<b>VOL▲/VOL▼</b>	Adjust the volume.
<b>Standby button</b>	Turn on the TV or put the TV in standby mode.

### NOTES

- FOR ILLUSTRATION ONLY.
- Powering up or down the TV requires several seconds of processing time. Do not rapidly turn the TV on/off as abnormal operation may occur.

# Getting Started

## Viewing the Remote Control

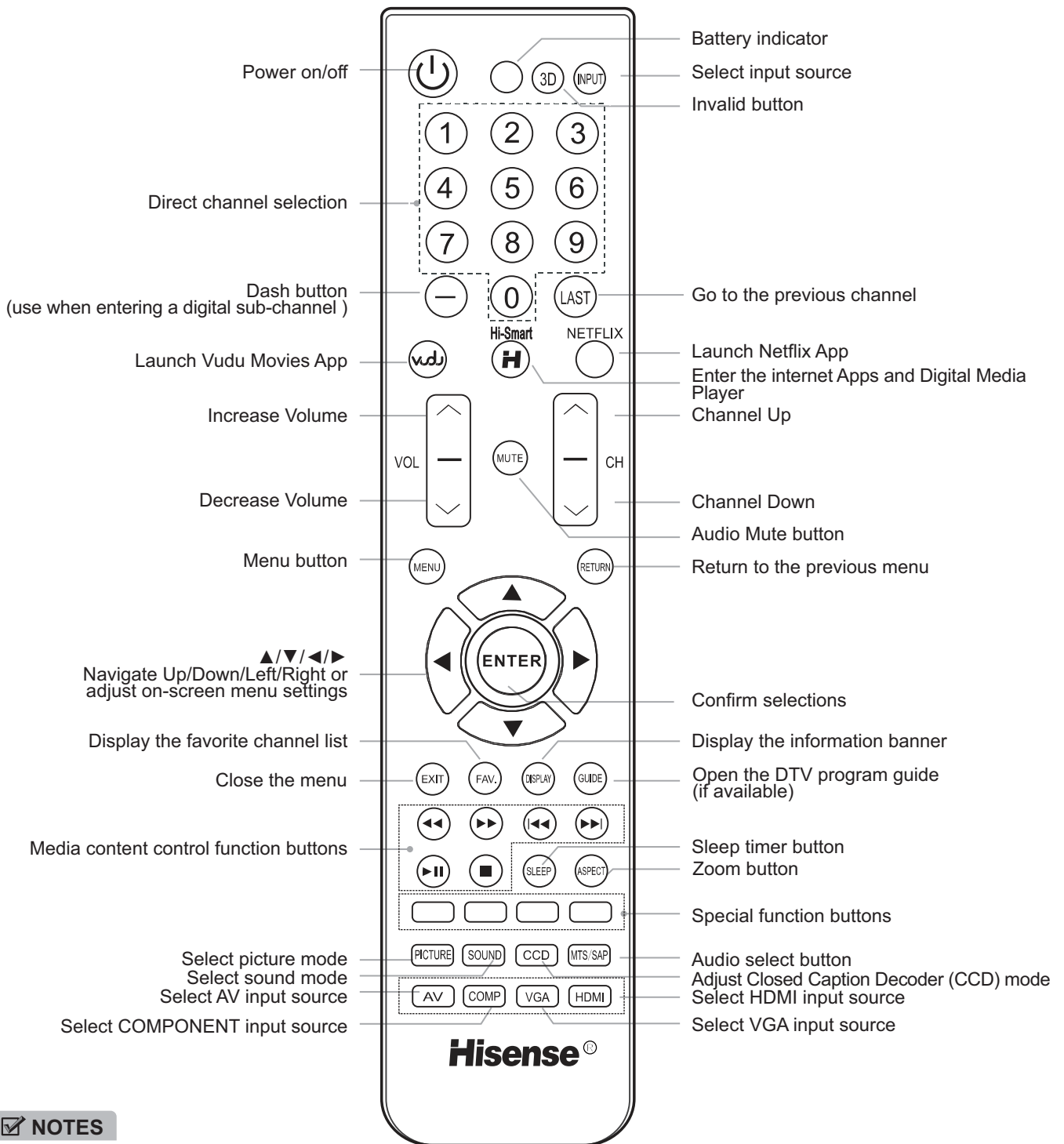

### NOTES

- FOR ILLUSTRATION ONLY.
- [RED/GREEN/YELLOW/BLUE] buttons are used for Electronic Program Guide (EPG). After pressing the [GUIDE], [Hi-Smart] or [Hi-DMP] button, the same color buttons will appear with explanations in the on-screen display (OSD). Follow the steps shown in the OSD.



# Getting Started

## Installing Batteries in the Remote Control

1. Slide the back cover to open the battery compartment of the remote control.
2. Insert two AAA size batteries. Make sure to match the (+) and (-) ends of the batteries with the (+) and (-) ends indicated in the battery compartment.
3. Close the battery compartment cover.

❶ Gently push and slide

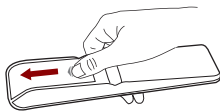

❷ Insert the batteries

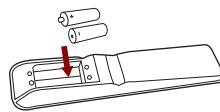

❸ Gently push and slide

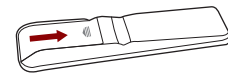

### NOTES

1. Dispose of your batteries in a designated disposal area. Do not throw the batteries into a fire.
2. Do not mix battery types or combine used batteries with new ones.
3. Remove depleted batteries immediately to prevent battery acid from leaking into the battery compartment.
4. If you do not intend to use the remote control for a long time, remove the batteries.
5. Batteries should not be exposed to excessive heat, such as sunshine, heat registers, or fire.
6. Battery chemicals can cause a rash. If the batteries leak, clean the battery compartment with a cloth. If chemicals touch your skin, wash immediately.
7. Do not mix old and new batteries.
8. Do not mix alkaline, standard (carbon-zinc) or rechargeable (ni-cad, ni-mh, etc.) batteries.

1. Program Your Universal Cable or Satellite Remote Control to Operate Your New Hisense Television!
2. If you would like to program your other household remote controls to your new Hisense television, please consult the User's Manual supplied by your Cable or Satellite provider. The Cable or Satellite providers' User's Manuals should include instructions on how to program their remote to your television.
3. Below is a list of Hisense codes for the most common Cable and Satellite providers. Use the Hisense code that is associated with your Cable or Satellite provider (if applicable).

DIRECTV.....0178 or 10019

Time Warner Cable.....386 or 0178

Comcast.....0178

Cox Communications.....0178

Dish Network.....627 or 505

If the Hisense code associated with your Cable or Satellite provider is not listed above, if the code above does not work, or if you cannot locate the instructions for programming your household remote to your television, call your local Cable or Satellite provider's customer service center.

If your Cable or Satellite provider does not have an Hisense code available, please visit <http://www.hisense-usa.com> for additional codes.

# Getting Started

## Making Connections

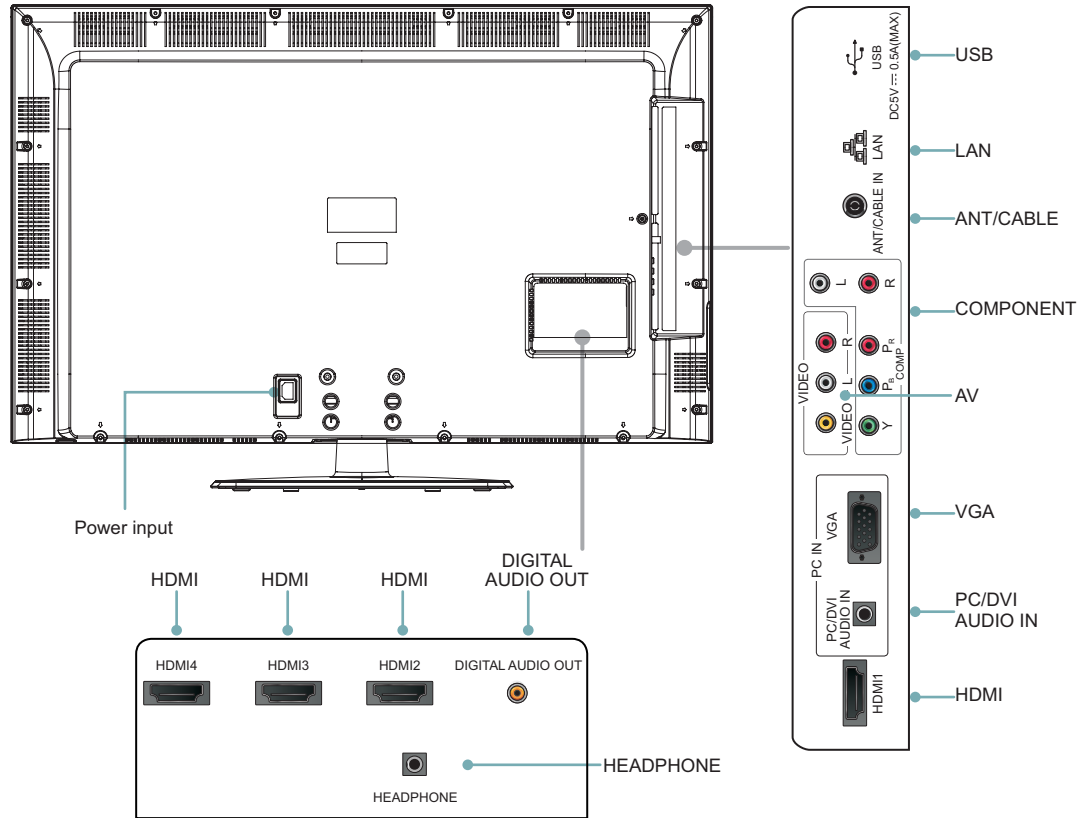

<b>Item</b>	<b>Description</b>
<b>ANT/CABLE IN</b>	Connect an antenna or cable TV to this jack.
<b>HDMI</b>	HDMI (High-Definition Multimedia Interface) provides an uncompressed, all digital audio/video interface between this TV and any HDMI-device, such as a set-top box, Blu-ray disc player, or A/V receiver.
<b>COMPONENT</b>	Connect to a DVD player, Digital Set-Top-Box, or other A/V devices with component (Y/P <sub>B</sub> /P <sub>R</sub> ) video and audio output jacks.
<b>VIDEO/AUDIO(L,R)</b>	Connect to the composite video and audio (L/R) output jacks on external video devices.
<b>VGA PC/DVI AUDIO IN</b>	Connect to a PC or other devices with a VGA interface.
<b>HEADPHONE</b>	Connect headphone for private listening.
<b>DIGITAL AUDIO OUT</b>	Connect to an external digital audio device.
<b>USB</b>	Port for Digital Media Player .
<b>LAN</b>	Connect an ethernet cable to access a network or the Internet.

### NOTE

- FOR ILLUSTRATION ONLY.
- Some external devices impossible insert to this set for individual difference. Please replace with appropriate external signal cable or increase the adapter to match with the port in such case.

# Getting Started

## NOTES

- Check the jacks for position and type before making any connections. Loose connections can result in image or color problems. Make sure that all connections are tight and secure.
- Not all A/V devices have the ability to connect to a TV, please refer to the user's manual of your A/V device for compatibility and connections procedure.
- Always unplug the power cord when connecting external equipment.

## Connecting an antenna, cable or cable/satellite box

1. Turn off the TV before connecting the antenna.
2. Connect one end of a coaxial cable (not included) to the RF OUT jack on the antenna, cable or cable/satellite box. If you are using an antenna with twin-lead cable, you may need a 300-75 ohm adapter (not provided) to connect it to the back of your TV. Likewise, if you are using several antennas, you may need a combiner (not provided).
3. Connect the other end of the cable to the ANT/CABLE IN jack on the side of your TV.

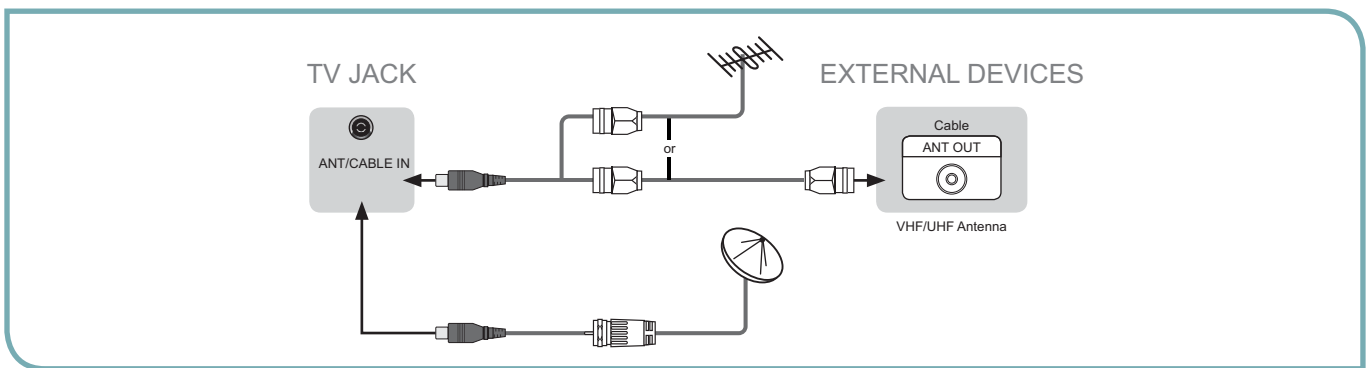

## Connecting an A/V Device with Composite Cable

1. Use the audio and video cables to connect the external A/V device's composite video/audio jacks to the TV's jacks. (Video = yellow, Audio Left = white, and Audio Right = red)
2. Plug the connected devices into the mains socket before switching on the TV.
3. Select the corresponding source from the TV.

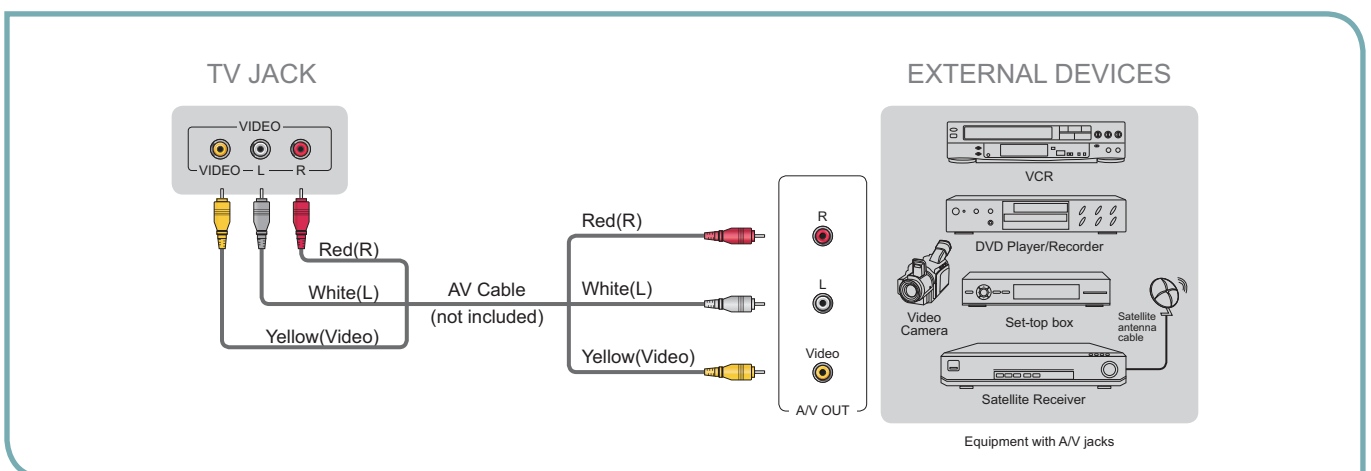

## Getting Started

### ❏ Connecting an A/V Device with Component (Y<sub>P<sub>B</sub>P<sub>R</sub></sub>) Cable

1. Use a component cable to connect the external A/V device's component output jacks to the TV's Y<sub>P<sub>B</sub>P<sub>R</sub></sub> jacks. Use an audio cable to connect the external A/V device's component audio jacks to the TV's AUDIO (L/R) jacks.
2. Plug the connected devices into the mains socket before switching on the TV.
3. Select the corresponding source from the TV.

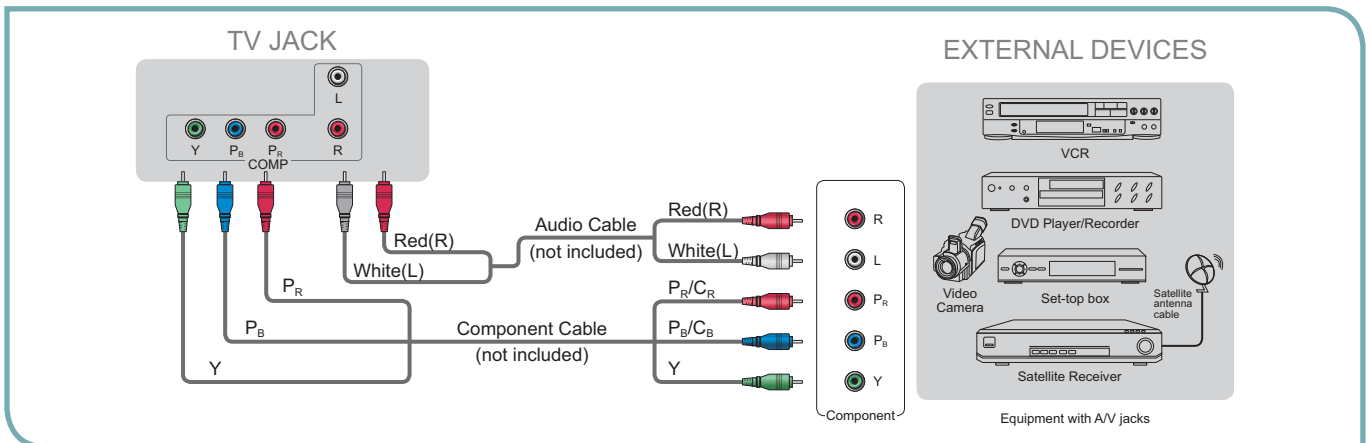

### ❏ Connecting an A/V Device with HDMI Cable

- Support digital connections between HDMI - enabled AV devices such as PVR, DVD, Blu-Ray, AV receiver and digital devices.
  - Some devices such as PVR or DVD player require HDMI signal to be set to output in the device's settings.
  - Please consult your device user manual for instructions.
1. Use an HDMI cable to connect the A/V device's HDMI output jack to the TV's HDMI jack.
  2. Plug the connected devices into the mains socket before switching on the TV .
  3. Select the corresponding source from the TV.

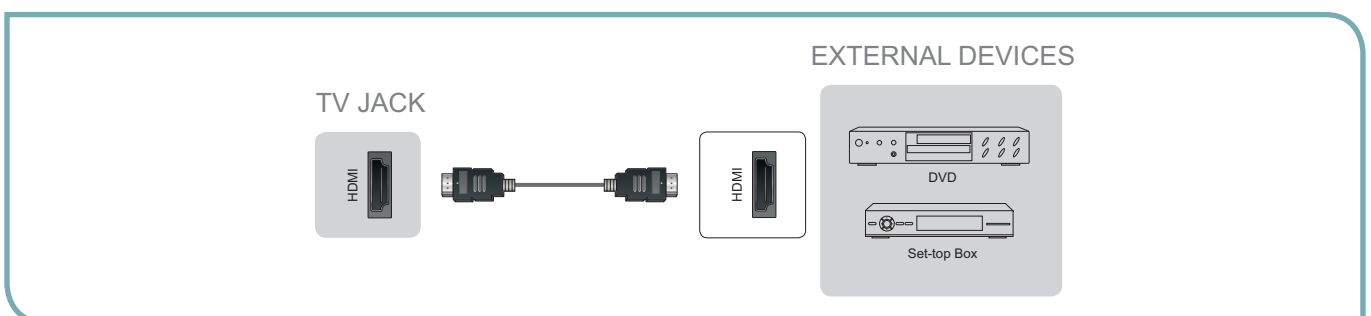

#### ✔ NOTE

The HDMI connector provides both video and audio signals, it's not necessary to connect an audio cable.

### ❏ Connecting a headphone

Headphones or an analog sound bar can be connected to the HEADPHONE output on your set. (While the headphone is connected, the sound from the built-in speakers will be disabled.)

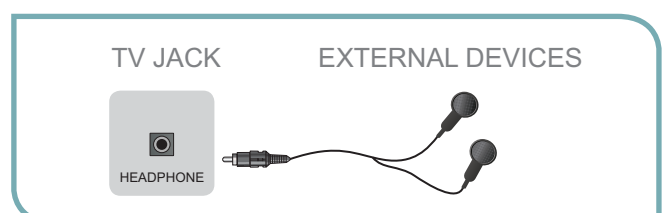

## Getting Started

### Connecting a PC with VGA Cable

1. Use a VGA cable to connect the PC's VGA output jack to the TV's VGA jack. Use an audio cable to connect the PC's audio output jack to TV's PC/DVI AUDIO IN jack.
2. Plug the connected devices into the mains socket before switching on the TV.
3. Select the corresponding source from the TV.

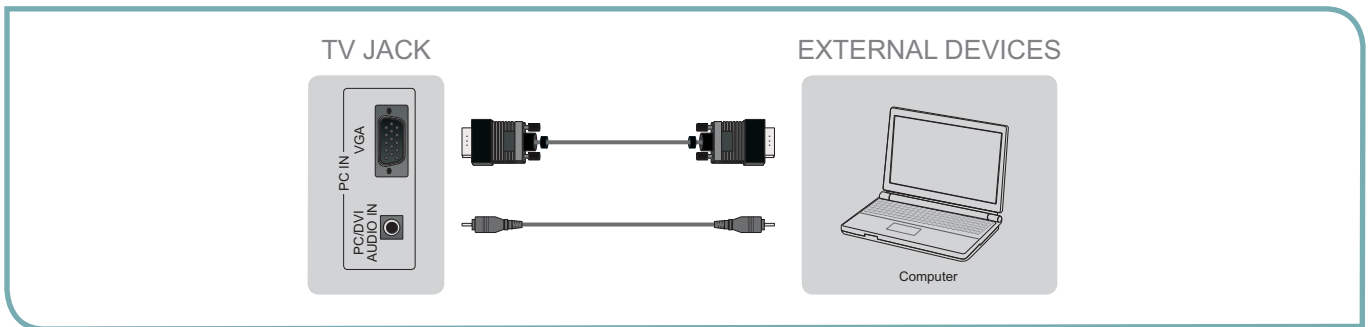

#### NOTES

- Primarily this unit is intended for use as an LCD TV. If you want to use it as a monitor, please contact the manufacturer of the PC Video/Graphic's card for further support. Perfect compatibility is not guaranteed.
- The VGA cable will not supplied with the product.
- We strongly recommend to use VGA cable with 2 ferrite cores as shown in the figure.

### Connecting an Audio Receiver with Digital Audio out cable

1. Use a coaxial cable to connect the A/V device's digital audio in jack to the TV's DIGITAL AUDIO OUT jack.
2. Plug the connected devices into the mains socket before switching on the TV.
3. Select the corresponding source from the TV.

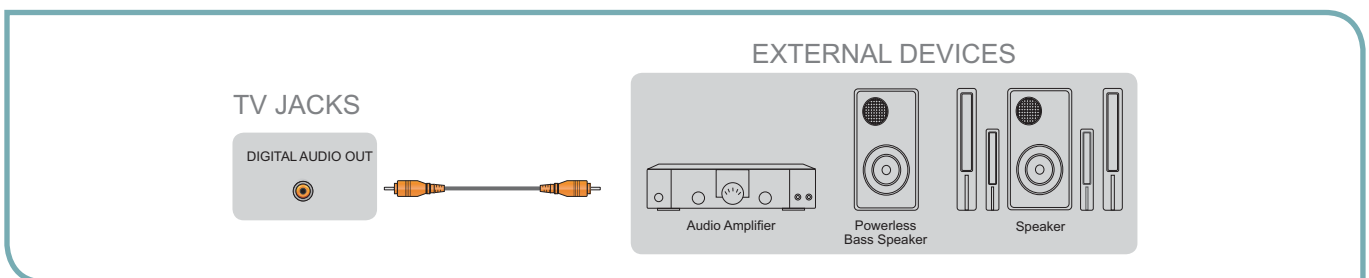

#### NOTES

- When a digital audio system is connected to the DIGITAL AUDIO OUT (COAXIAL) jack, decrease the volume of both the TV and the system.
- 5.1 CH (channel) audio is available when the TV is connected to an external device supporting 5.1 CH.
- When the receiver (home theater) is set to on, you can hear sound output from the TV's digital audio out jack. When the TV is receiving a DTV signal, the TV will send 5.1 CH sound to the home theater receiver. When the source is connected to the TV via HDMI, only 2 CH audio will be heard from the home theater receiver. If you want to hear 5.1 CH audio, connect the digital audio out jack from your DVD/Blu-ray player/cable box/STB satellite receiver directly to an amplifier or home theater.

### Connecting an ethernet cable to access a network or the Internet

Connect an ethernet cable to access a network or the Internet. TV also features wireless connectivity. For more information, see "Network Connection".

## Basic Features

### Turning the TV on or off

**IMPORTANT: At first, you have to match the remote control with TV.**

To turn your TV on or off (standby mode):

1. Plug the power cord into an AC power outlet.
2. Press [POWER] button or use the Tap Pad located on the TV (see “viewing the control panel”). Your TV turns on.
3. Press [POWER] button again to turn off your TV. When you turn off your TV, it goes into standby mode.

#### ! WARNING

When your TV is in standby mode, it is still receiving power. To completely disconnect power, unplug the power cord.

#### ✓ NOTE

If your TV does not receive an input signal for several minutes, it automatically goes into standby mode.

### Turning the TV On for the First Time

The Setup Wizard menu appears the first time you turn on the TV. It will assist you to specify the menu language, Picture Mode, Tuner Mode and Channel Installation.

**IMPORTANT: Make sure that the antenna or cable is connected and a wired or wireless Internet connection is available.**

1. Make sure that you have:
  - Installed the remote control batteries.
  - Connected an antenna or cable.
  - Connected the power cord.
  - Matched the remote control with TV.
2. Press [POWER] button to turn on your TV. The **Setup Wizard** menu displays.
3. Press [▲/▼/◀/▶] to select your menu language: English, Spanish or French, press [ENTER] button to confirm.

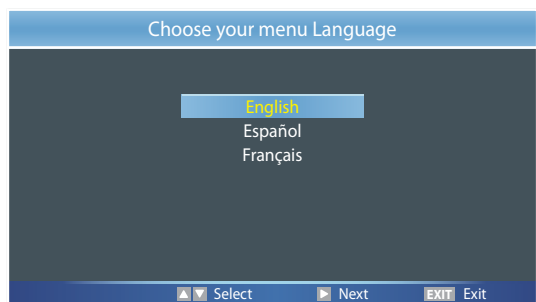

4. Press [▲/▼] to select your Picture Mode: Home Mode or Retail Mode, press [ENTER] button to confirm.
  - If you select Retail Mode, a message appears “Are you sure you want retail mode?” Select “Yes” to continue, or select “No” to change your selection.

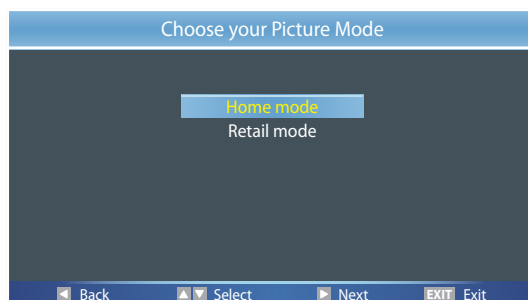

- If you selected Retail Mode, Energy Saving is not realized.
5. Press [▲/▼] to select your Tuner Mode: Antenna or Cable, press [ENTER] button to confirm.

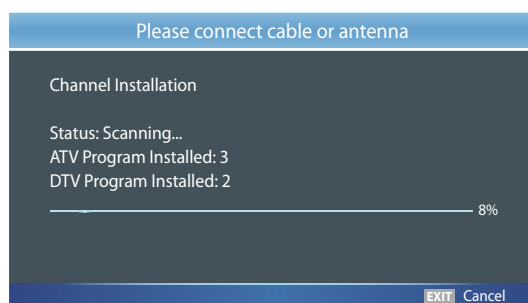

6. Press [▲/▼] to set the Channel Installation: Scan or Skip Scan, press [ENTER] button to confirm.
  - If you select “Scan”, your TV automatically starts Channel Installation available in your viewing area.
  - If you select “Skip Scan”, your TV does not scan for channels.
  - Depending on the reception condition, it may take up to 25 minutes or more to complete memorizing channels. Please allow the process to complete without interruption.

### Selecting the Input Source

The first time you turn on your TV, you must select the TV signal source. Your TV stores this information, so you do not need to change the TV signal source unless it changes. For example, you change from an outside antenna to cable TV.

**To select the video input source:**

1. Turn on your TV, then press [INPUT] button on the remote or on the TV. The Input Source menu opens.
2. Press [▲/▼] button to highlight the input source, then press [ENTER] button.
3. Press [POWER] button again to turn off your TV. When you turn off your TV, it goes into standby mode.





## Basic Features

### Changing Channels / Volume

1. Press the [CH  $\Delta$ /V] (or [CH +/-]) on the TV/remote control to change the channel.
2. Press the [VOL  $\Delta$ /V] (or [VOL +/-]) on the TV/remote control to adjust the volume.
3. Press the numeric buttons on the remote control to display the corresponding channels.

#### NOTE

Changing the channels can also be achieved by directly entering the channel number using the numeric keys on the remote control. If you are entering a two or three digit channel number, the time between key presses should be less than 3 seconds.

### Shortcuts Instructions

**Aspect** - Select the screen aspect ratio from Normal, Wide, Zoom and Cinema.

**Normal:** The original 4:3 aspect ratio (1.33:1 signal) is preserved, so black bars are added to the left and right of the image. Standard TV broadcasts are displayed with a 4:3 aspect ratio.

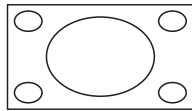

**Wide:** When watching a standard broadcast or full-frame movie in this mode, the display image is stretched proportionately to fill the TV screen. When watching a widescreen (1.78:1 signal) program or movie, the display image fills the TV screen.

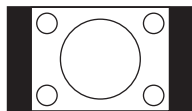

**Zoom:** Stretch the 4:3 aspect ratio image vertically and horizontally to fill the screen at 1:1.78 aspect ratio.

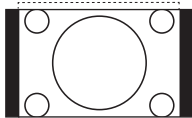

**Cinema:** Stretch the 4:3 aspect ratio image vertically and horizontally to fill the screen at 1:2.35 aspect ratio.

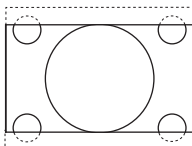

**DISPLAY** - Display the information banner. The information including channel number, channel name, current system time, tuner mode, audio stream, video format, audio language, closed caption mode, parental locks rated, program details, etc.

**GUIDE** - Open the DTV program guide. The program guide information is provided by the broadcasting company.

**FAV** - Display your Favorite List. You can add or delete channels to create your favorite list.

**Cursor up/down:** Press [ $\blacktriangle$ / $\blacktriangledown$ ] button to select the option.

**Add/Erase:** Press [YELLOW] button to add or delete the channel from Favorite List.

**Page up/down:** Press [RED/GREEN] button to page up or down.

**VUDU** - VUDU™ is an on-demand, pay-per-view, service that offers high-definition movies via the Web. You can access the VUDU service by pressing this button.

**Hi-Smart** - Press to open the Hi-Smart Hub. The Hi-Smart Hub provides convenient access to Services and Apps which let you watch movies, TV shows, listen to music, and much more.

**NETFLIX** - Press to open the Netflix interface. Netflix is an online DVD and Blu-ray Disc rental service, offering instant access to movies and TV shows to Netflix members. Netflix unlimited membership required (subscription not included).

# Basic Features

## To Use the Menu

- 1 Press the [Menu] button to open the main menu.
- 2 Press [▲/▼] to select a menu option, then press [▶/ENTER] to enter the menu.
- 3 In each menu, you can:
  - Press [▲/▼] to select an item,
  - Press [◀/▶] to adjust the value, or
  - Press [▶/ENTER] to enter the submenu,
  - Press [RETURN] to exit the submenu.
- 4 Press [EXIT] button to exit the menu.

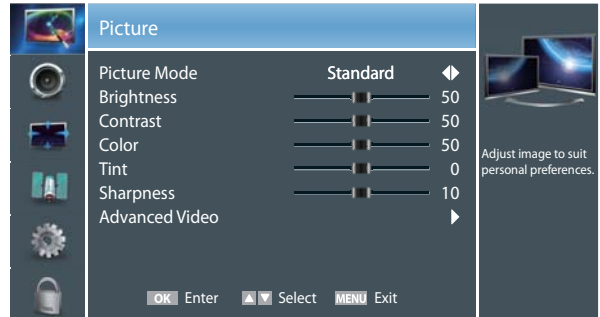

**NOTE**

FOR ILLUSTRATION ONLY.

## Using the Picture Menu

### You can adjust:

**Picture Mode** - Adjust the Picture Mode. You can select Standard, Theater, Energy Saving, Game, Custom or Vivid.

**Brightness** - Increase or decrease the brightness of the picture. Increasing the brightness can add more light to dark areas of the picture, while decreasing the brightness can add more darkness to light areas of the picture.

**Contrast** - Increase or decrease the contrast of the picture. Increase the contrast to adjust the white areas of the picture or decrease the contrast to adjust the black areas of the picture.

**Color** - Adjust the level of color in the picture.

**Tint** - Adjust flesh tones so they appear natural.

**Sharpness** - You can increase the sharpness level for clearer images or decrease the sharpness level for smoother images.

**Advanced Video** - Access advanced video settings such as Color Temperature, Noise Reduction and Adaptive Contrast.

**Color Temperature:** Change the color temperature. You can select a preset color temperature: Cool, Standard and Warm.

**Noise Reduction:** Optimize the picture quality by filtering signal interference. You can select Off, Low, Medium or High.

**Adaptive Contrast:** Automatically adjusts the contrast level of the selected input source.

## Using the Audio Menu

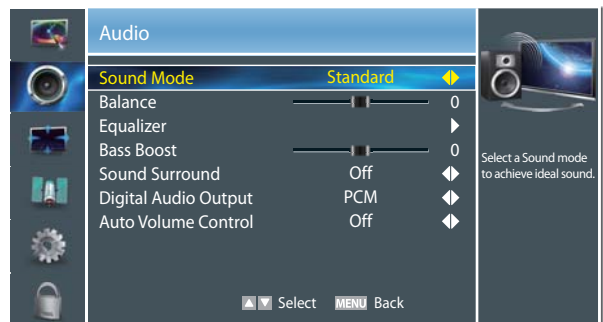

### You can adjust:

**Sound Mode** - Select the Sound Mode: Standard, Speech, User or Music.

**Balance** - Adjust the volume of the left and right speakers.

**Equalizer** - Soften or enhance the sound at specific frequency points.

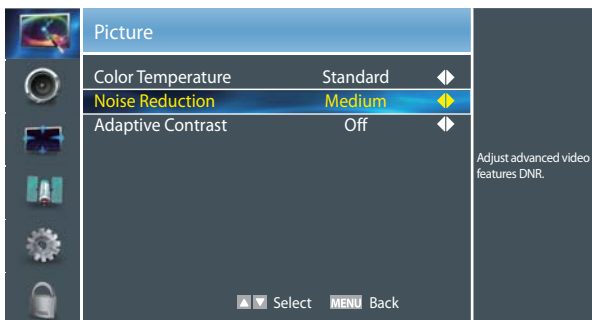

# Basic Features

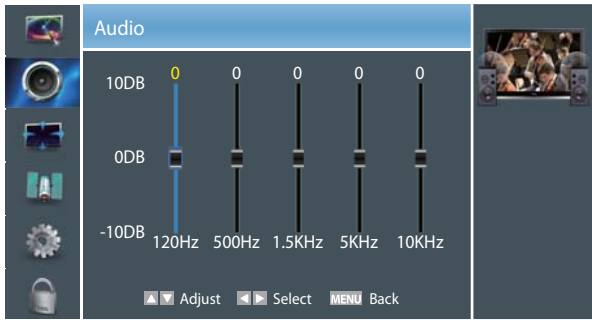

**Bass Boost** - Adjust the bass performance.

**Sound Surround** - Simulates surround sound and enhances bass response.

**Digital Audio Output** - Send digital audio to an external audio system. You can select PCM, RAW or Off.

**PCM:** PCM outputs two channel audio regardless of the input format.

**RAW:** Passes through (output = input) the incoming audio signal without decoding. E.g. incoming Dolby Digital, DTS or PCM data stream is simply output as it is without any processing.

**Auto Volume Control** - Automatically adjusts volume to a consistent level; attenuates loud passages.

## Using the Channels Menu

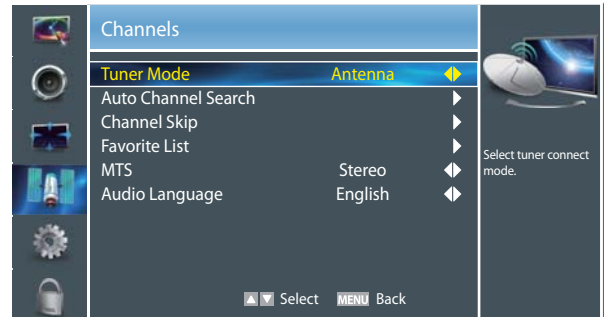

**You can adjust:**

**Tuner Mode** - Select TV source: Antenna or Cable.

**Auto Channels Search** - Scans for channels that have signals and stores the channels information in the channel list.

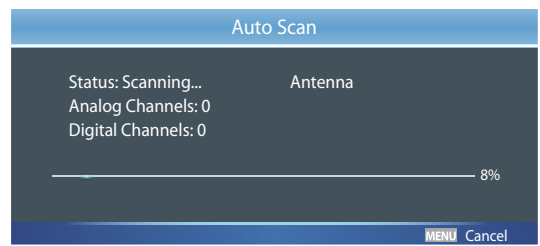

**Channel Skip** - You can cancel a channel stored in the channel list.

## Using the Screen Menu

### NOTE

Only available in VGA mode.

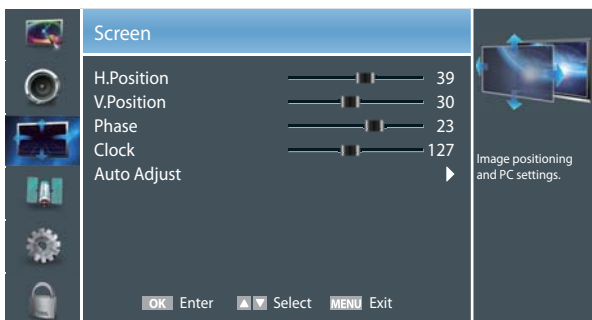

**You can adjust:**

**H.Position** - Move the image right or left.

**V.Position** - Move the image up or down.

**Phase** - Adjust the focus of stable images.

**Clock** - Adjust the sample frequency.

**Auto Adjust** - Detects input signal clock, phase and position and adjusts TV display accordingly.

### NOTE

When you press [CHA / V] button, your TV skips the channel you cancelled. You can still tune to the channel using the number buttons on the remote control.

**Favorite List** - Add or delete channels to create a favorite list. You can press [FAV] button to display your Favorite List.

**MTS** - Select the default audio stream: Mono, Stereo or SAP.

**Audio Language** - Select the audio language: English, Español or Français.

### NOTE

Only available in TV mode.

# Basic Features

## Using the Settings Menu

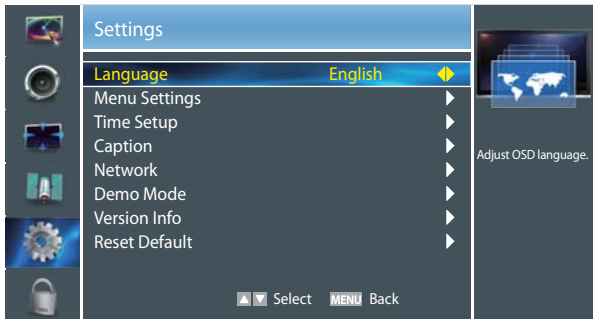

### You can adjust:

**Language** - You can select the menu's language to English, Español or Français.

**Menu Settings** - You can set On-screen menu system.

**Timeout:** Select the display time of the menu: 10-20-...-60 seconds.

**Time Setup** - Set the time zone, daylight saving, time and sleep timer.

**Time Zone:** Select your local time zone: Eastern Time, Indiana, Central Time, Mountain Time, Arizona, Pacific Time, Alaska or Hawaii.

**Daylight Saving:** Set the Daylight Saving time for your area.

**Time:** You can set time manually or select automatic if the TV is connected to an antenna or cable source.

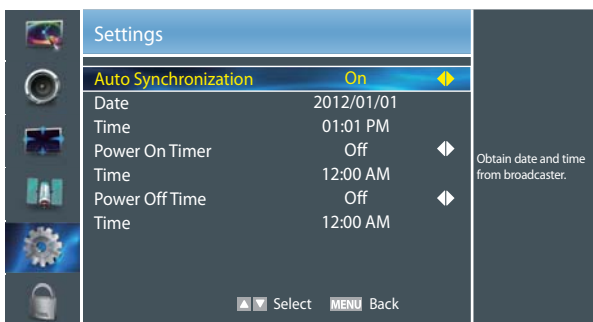

- **Auto Synchronization:** Select "On" for automatic date and time setting using information from broadcast stations in your area.
- **Date/Time:** Set the current year/month/day/time.
- **Power On Timer:** When "On", you can set the time when the TV turns on automatically.
- **Time:** Set the desired time for the TV to turn on automatically.
- **Power Off Timer:** When "On", you can set the time when the TV turns off automatically.
- **Time:** Set the desired time for the TV to turn off automatically.

**Sleep Timer:** Specify the amount of time before your TV automatically turns off: Off -10-...-120 minutes.

**Caption** - Adjust Closed Captioning settings.

**Caption Control:** Select the Closed Caption mode: CC Off, CC On or CC On When Mute.

**Analog Closed Caption:** Select an Analog Caption setting:

- **CC1~CC4:** Closed captioning appears in a small banner across the bottom of the screen. CC1 is usually the "printed" version of the audio. CC2~CC4 display content are provided by the broadcaster.
- **Text1~Text4:** Closed captioning that covers half or all of the screen. Text1~Text4 display content are provided by the broadcaster.
- **Off:** To turn off the Analog Caption.

**Digital Closed Caption:** Select a Digital Caption setting: Service1~Service6 or Off.

**Digital Caption Style:** Customize the look of digital Closed Captioning.

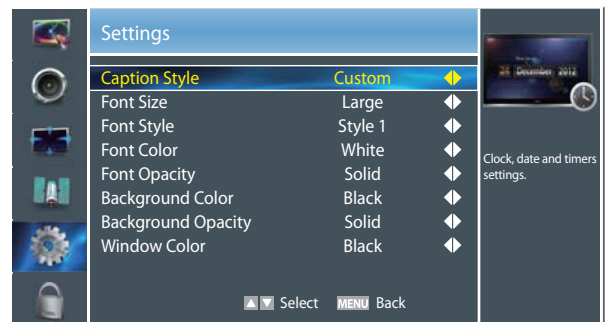

- **Caption Style:** Set the look of Digital CC. "As Broadcaster" uses broadcaster's style.
- **Font Size/Style/Color/Opacity:** Select the size/style/color/opacity level of font.
- **Background Color/Opacity:** Select the color/opacity level of the background.
- **Window Color:** Select the color of the window.

**Network** - You can setup the network configuration in this menu. For more information, see "Network Connection" and "Network Setup".

**Demo Mode** - Displays a banner at the bottom of the screen which describes the key features of the TV.

**Version Info** - Display the software version information. You may need to reference this information when contacting Customer Care or upgrading the firmware online.

**Reset Default** - Restores the TV configuration to factory settings. You will need to complete the setup for such things as Tuner/Channel settings, Network connection, Date/Time and other user preferences.

# Basic Features

## Using the Lock Menu

When you first use this function, the default password is [0000]. Once you input this password, you can set options.

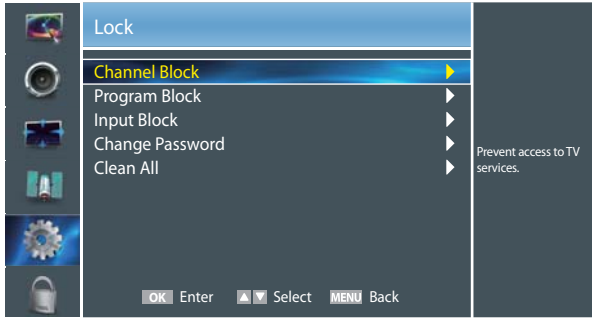

### You can adjust:

**Channel Block** - Block selected Channels on the TV.

**Program Block** - Block selected Programs on the TV.

**Rating Enable:** Block or unblock TV ratings.

**U.S. TV Ratings:** Restrict TV programs by USA Ratings.

**U.S. Movie Ratings:** Restrict movie by USA Ratings.

**Canadian English/French Ratings:** Restrict movie and TV programs by Canadian Ratings.

**Open V-Chip:** Display an advanced V-Chip ratings table for digital channels (USA only).

**Block Unrated:** Block unrated TV programs.

**Input Block** - Block selected Input source on the TV.

**Change Password** - If you want to change the default password, first enter the new password then enter the same password again.

**Clean All** - You can reset all locks to factory mode.

Following is the description of these ratings.

### U.S. Movie Ratings

Rating	Defined as
G	General audience
PG	Parental Guidance suggested
PG-13	Parents strongly cautioned
R	Restricted
NC-17	No one 17 and under admitted
X	Adult audience only

### U.S. TV Ratings

Age	Defined as
TV-Y	All children
TV-Y7	Directed to older children
TV-G	General audience
TV-PG	Parental Guidance suggested
TV-14	Parents Strongly cautioned
TV-MA	Mature Audience only

Contents	Defined as
A	All of the ratings below that rating set blocked automatically
D	Suggestive dialogue
L	Strong language
S	Sexual situations
V	Violence
FV	Fantasy Violence

### Canadian English Ratings

Rating	Description
C	Children
C8+	Children 8 years and older
G	General Programming, suitable for all audiences
PG	Parents Guidance
14+	Viewers 14 years and older
18+	Adult Programming

### Canadian French Ratings

Rating	Description
G	General
8 ans+	8+General; Not recommended for young children
13 ans+	Programming may not be suitable for children under the age of 13
16 ans+	Programming is not be suitable for children under the age of 16
18 ans+	Programming restricted to adults

## Advanced Features

### Network Connection

You can set up your TV so that it can access the Internet through your local area network (LAN) with a Ethernet or wireless connection.

#### Connecting to a Wired Network

You can attach your TV to your LAN by one of the three following ways:

- You can attach your TV to your LAN by connecting the LAN port on the back of your TV to an external modem using a Cat 5 LAN cable. See the diagram below.

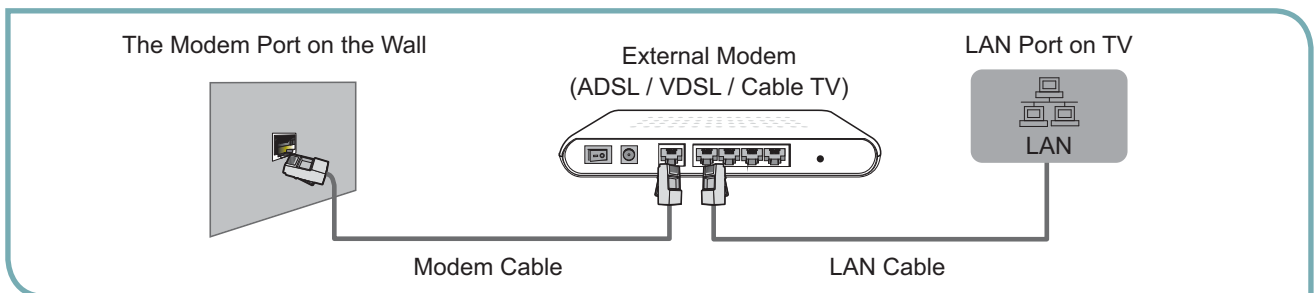

- You can attach your TV to your LAN by connecting the LAN port on the back of your TV to an IP Sharer which is connected to an external modem. Use LAN cable for the connection. See the diagram below.

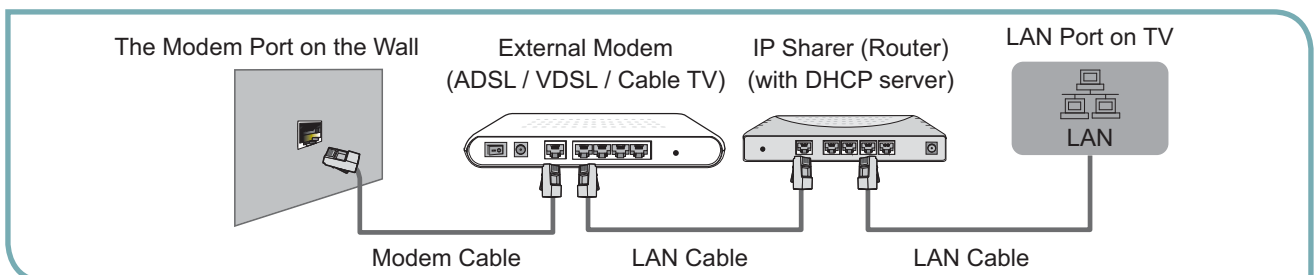

- Depending on how your network is configured, you may be able to attach your TV to your LAN by connecting the LAN port on the back of your TV directly to a network wall outlet with a Cat 5 cable. See the diagram below. Note that the wall outlet is attached to a modem or router elsewhere in your house.

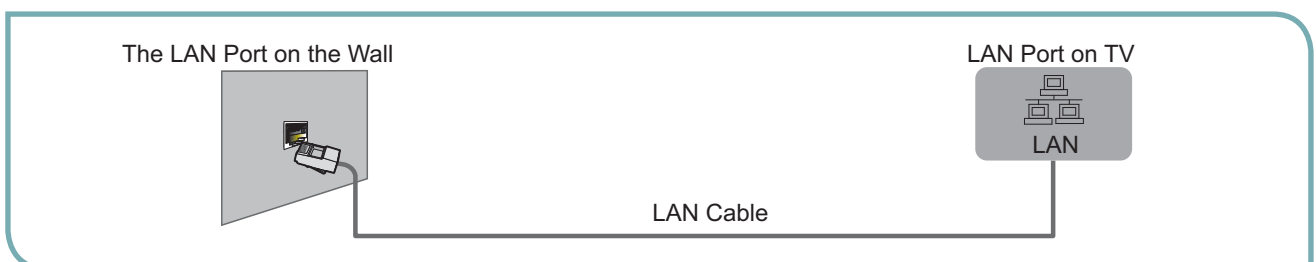

If you have a Dynamic Network, you should use an ADSL modem or router that supports Dynamic Host Configuration Protocol (DHCP). Modems and routers that support DHCP automatically provide the IP address, subnet mask, gateway, and DNS, so you don't have to enter them manually. Most home networks are Dynamic Networks.

Some networks require a Static IP address. If your network requires a Static IP address, you must enter the IP address, subnet mask, gateway, and DNS values manually on your TV's Cable Setup Screen when you set up the network connection. To get the IP address, subnet mask, gateway, and DNS values, contact your Internet Service Provider (ISP).

If you have a Windows computer, you can also get these values through your computer.

#### NOTE

You can use ADSL modems that support DHCP if your network requires a Static IP address. ADSL modems that support DHCP also let you use Static IP addresses.



# Advanced Features

## Network Setup (Auto)

Use the Automatic Network Setup while your connecting the TV to a network that supports DHCP. To set up your TV's cable network connection automatically, follow these steps:

- **How to set up automatically**

1. Connect your TV to your LAN as described in the previous section.
2. Turn on your TV, operate according to the description in the Settings menu until the Network screen appears.

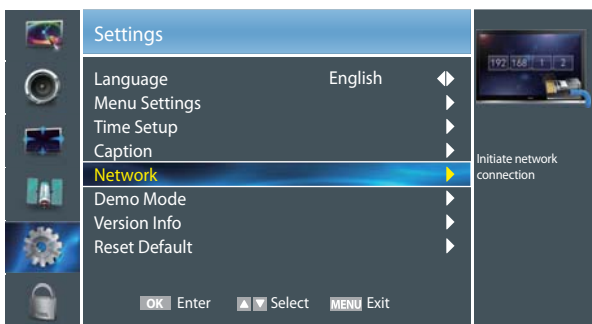

3. On the Network screen, select Configuration and press [ENTER] button to enter the submenu.

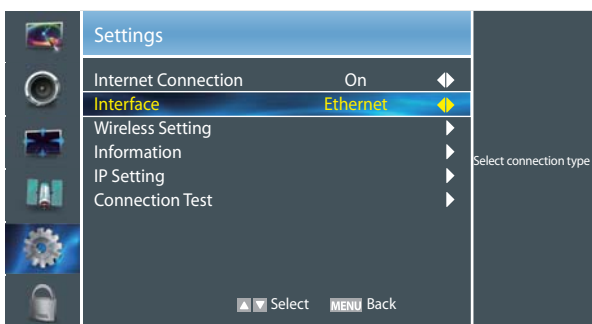

4. Set Internet Connection to On and Interface to Ethernet.
5. Select IP Setting and press [ENTER] button to enter it.

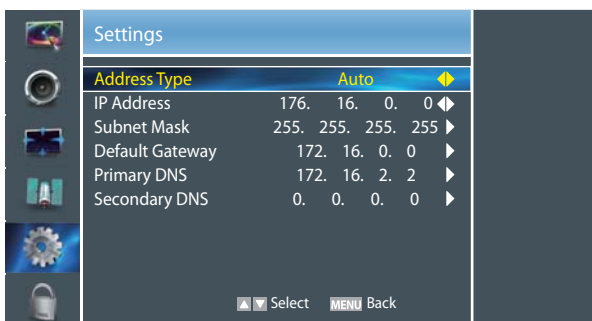

6. Set Address Type to Auto.
7. Auto acquires and enters the necessary connection values automatically.
8. If the connection values are not automatically entered, please check your modem and router manuals for

directions to enable automatic IP addressing by DHCP. Or, follow the steps listed to the follow to manually configure the network connection.

## Network Setup (Manual)

Use the Automatic Network Setup when connecting your TV to a network that requires a Static IP address.

- **Getting the Network Connection Values**

To get the network connection values on most windows computers, follow these steps:

1. Right click the Network icon on the bottom right of the screen.
2. In the pop-up menu that appears, click Status.
3. On the dialog that appears, click the Support tab.
4. On the Support tab, click the Details button. The network connection values are displayed.

- **How to set up manually**

To set up your TV's network connection manually, follow these steps:

1. Follow Steps 1 through 5 in the "How to set up automatically" procedure.
2. Set Address Type to Manual.

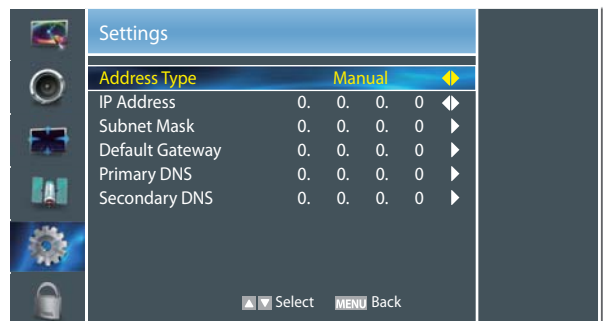

3. Press [▲/▼] button to select IP Address and press [◀/▶] button to move the cursor to the entry field. Then press 0~9 buttons to enter the numbers.
4. Press [MENU] button to exit IP Address and press [▲/▼] button to select the next options to enter the numbers.
5. When done, press [MENU] button to return to the previous menu.
6. Select Connection Test to check the internet connectivity.

## Advanced Features

### ❏ Connecting to a Wireless Network

To connect your TV to your network wirelessly, you need a wireless router or modem. See the illustration below.

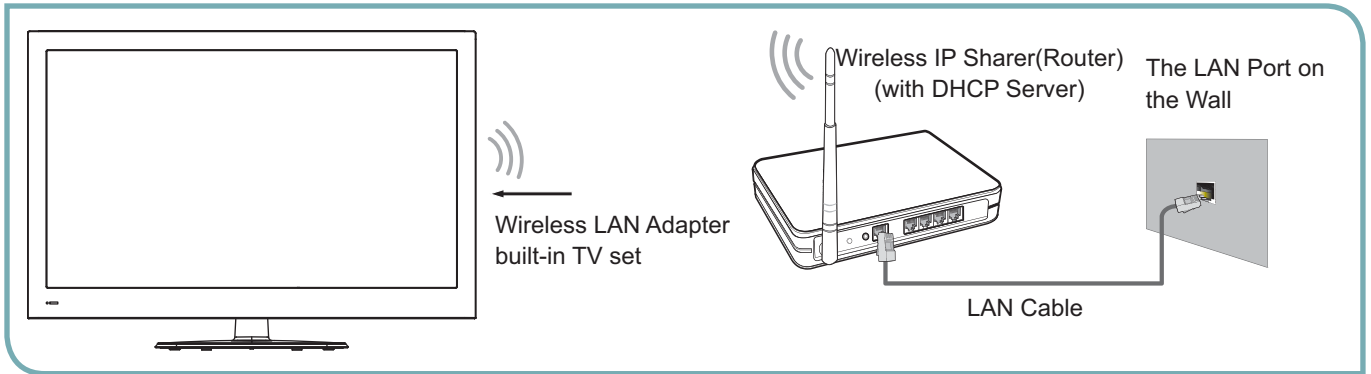

Hisense's built-in Wireless LAN Adapter supports the IEEE 802.11 b/g/n communication protocols. Hisense recommends using IEEE 802.11n router. When you play the video over a IEEE 802.11b/g connection, the video may not play smoothly.

#### ✔ NOTES

- You must use the Hisense's built-in Wireless LAN Adapter to use a wireless network, the set doesn't support external USB network adapter.
- To use a wireless network, your TV must be connected to a wireless IP sharer. If the wireless IP sharer supports DHCP, your TV can use a DHCP or static IP address to connect to the wireless network.
- Select a channel for the wireless IP sharer that is not currently being used. If the channel set for the wireless IP sharer is currently being used by another device nearby, this will result in interference and communication failure.
- If you apply a security system other than the systems listed below, it will not work with the TV.
- If Pure High-throughput (Greenfield) 802.11N mode is selected and the Encryption type is set to WEP, TKIP or TKIP-AES (WPS2 Mixed) for your Access Point (AP), Hisense TVs will not support a connection in compliance with new Wi-Fi certification specifications.
- If your AP supports WPS (Wi-Fi Protected Setup), you can connect to the network via PBC (Push Button Configuration) or PIN (Personal Identification Number). WPS will automatically configure the SSID and WPA key in either mode.
- Connection Methods: You can setup the wireless network connection three ways.
  - Scan
  - Manual
  - Auto

# Advanced Features

## Wireless Setting

### How to set up

1. Turn on your TV, operate according to the description in the Settings menu until the Network screen appears.

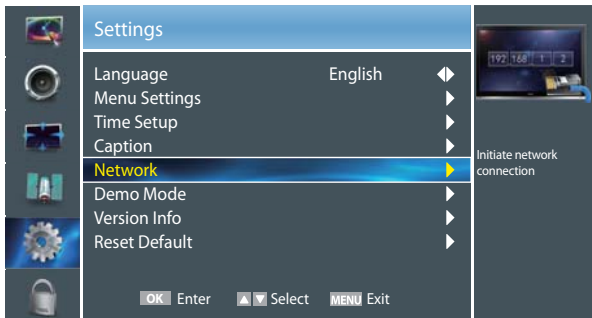

2. On the Network screen, select Configuration and press [ENTER] button to enter the submenu.

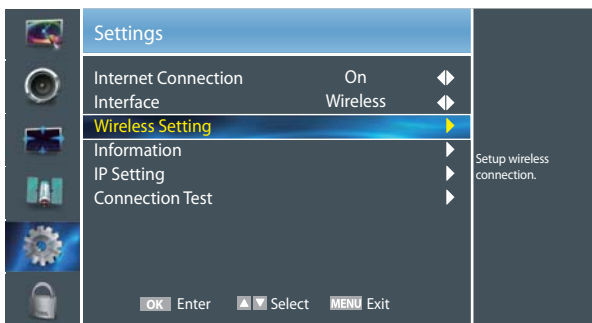

3. Set Internet Connection to On and Interface to Wireless.
4. Select Wireless Setting and press [ENTER] button to enter it.  
You can select: Scan\Manual\Auto.
5. If you select Scan, a screen will appear listing all of the wireless networks within range of the TV. Use the [▲/▼] keys to select the wireless network with your router SSID and press [ENTER] to confirm. Proceed to Step 7.
6. If you select Manual, a screen will appear prompting you to enter the SSID of your wireless network. Press [ENTER] and an on-screen keyboard will pop up. Enter the SSID and select OK. Press [ENTER] to confirm and a screen will appear prompting you select the security mode for your wireless network. Use the [▲/▼] keys to select the proper security mode and press [ENTER] to confirm. If you selected None for the security mode, proceed to step 9.
7. A screen will appear prompting you to enter the password for the selected security mode. Press [ENTER] and an on-screen keyboard will pop up. Enter the password and select OK. Press [ENTER] to confirm. Proceed to Step 9.
8. If you select Auto, a screen will appear prompting you to select PIN (personal identification number) or PBC

(push button configuration) setup. Choose the method supported by your wireless access point.

- 8a. If you choose PIN, an identification number will appear on the screen for you to enter into the access point. After entering the PIN, press the [▶] key. If the PIN is in use by another device, select [REFRESH] to obtain a new PIN and enter it into the access point. After entering the PIN, press the [▶] key.
- 8b. If you choose PBC, a screen will appear prompting to press [▶] key. After pressing the [▶] key you have two minutes to locate and press the Push Button on your access point to connect to the TV.
9. Press the [MENU] key to return to the previous menu.
10. Select Connection Test to check the Internet connectivity.

## DLNA Settings

Computer, TV and other digital devices can be connected via DLNA and they can share files with each other. You can use the TV set as a DLNA DMP (Digital Media Player) device to enjoy movies, pictures, music and other multimedia materials in your computer through DLNA connection.

DLNA Setting needs to be set on TV and computer respectively.

### Network Setup:

1. Turn on your TV, operate according to the description in the Settings menu until the Network screen appears.
2. On the Network screen, select Configuration and press [ENTER] button to enter the submenu.
3. Set Internet Connection to On and Interface to Ethernet.
4. Select IP Setting and press [ENTER] button to enter it.
5. Set Address Type to Auto.

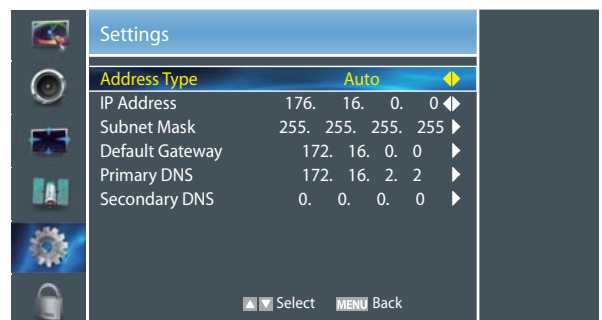

6. Auto acquires and enters the necessary connection values automatically.
7. If the connection values are not automatically entered, please check your modem and router manuals for directions to enable automatic IP addressing by DHCP. Or, follow the steps below to manually configure the network connection.

# Advanced Features

To set up your TV's network connection manually, follow these steps:

- 1). Follow Steps 1 through 5 in the "How to set up automatically" procedure.
- 2). Set Address Type to Manual.

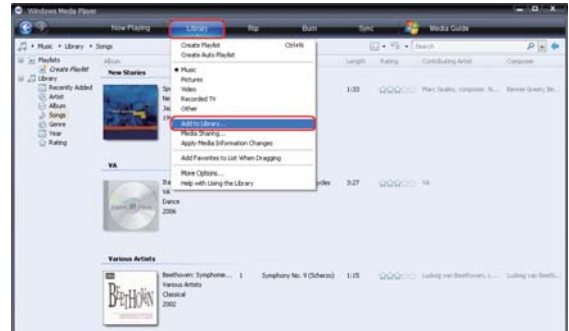
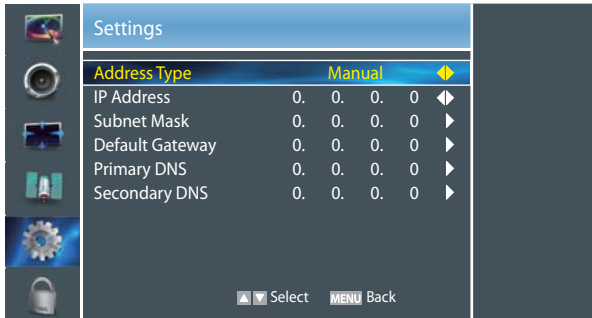

3. The "Add To Library" will pop up on the screen. Click "Add".

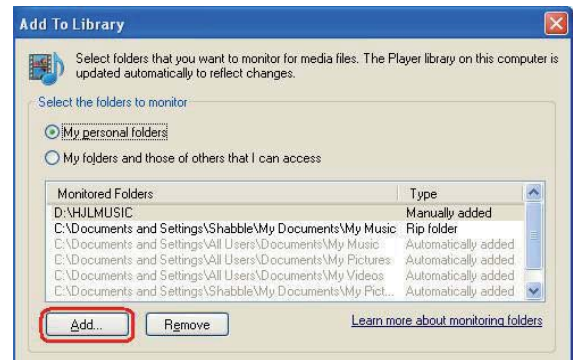

8. Set Address Type to Manual, enter IP Setting. Then press [▲/▼] button to select IP Address and press [◀/▶] button to move the cursor to the entry field. Then press 0~9 buttons to enter the numbers.
9. Press [MENU] button to exit IP Address and press [▲/▼] button to select the next options to enter the numbers.
10. When done, press [MENU] to return to the previous menu.
11. Select Connection Test to check the Internet connectivity.

4. Select a folder and click OK button.

## Set DLNA to On:

1. On the Network screen, select Applications and press [ENTER] button to enter the submenu.
2. Press [◀/▶] button to set DLNA to On.

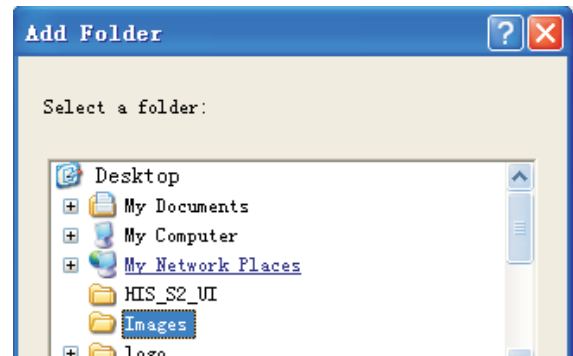
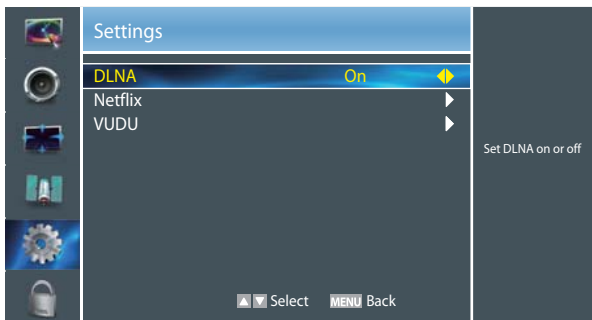

5. Click "Close" to close the dialog.

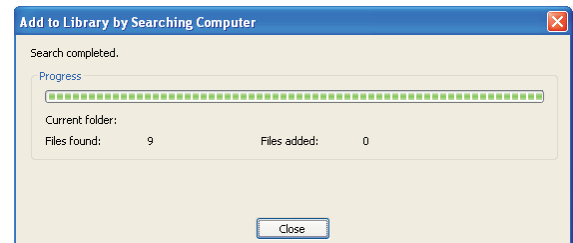

## Media Share Settings in Computer

If your computer does not support DLNA, you may install software that supports DLNA such as TVersity or Windows Media Player. We recommend Windows Media Player as the installation and setup is easier.

1. Start the Windows Media Player(V11 or higher).
2. Click "Library" and then "Add to Library...".

## Settings to Share Files

1. Click "Library" and move the cursor to select "Media Sharing...".

# Advanced Features



2. Click the box to select “Share my media” and click [OK].

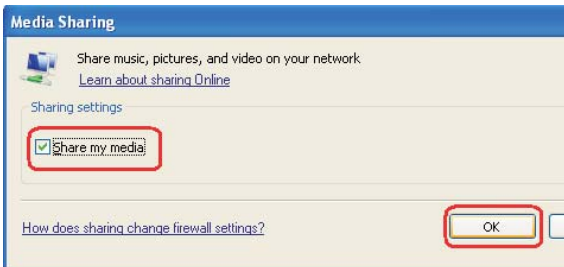

3. An equipment icon will appear on the white area if the DLNA Settings has been correctly set. Select the appropriate icon and then click “Allow”.

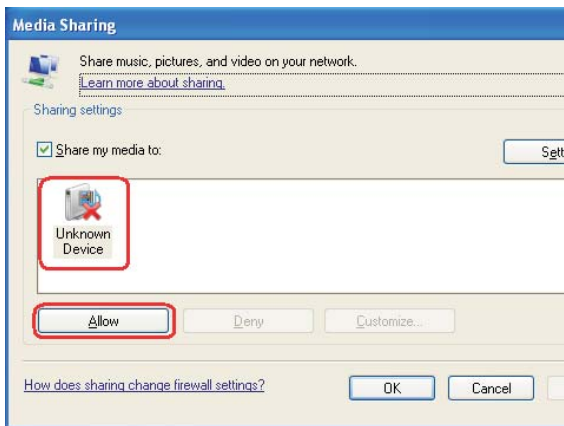

4. The TV now has access to the shared files on the computer.



## Network Function

### NOTICE FOR USE

If you use VUDU services, see the following note before using it.

1. Use of Internet services requires a working broadband Internet connection (1 to 2 Mbps for SD video, 2.25 to 4.5 Mbps for HD video and 4.5 to 9 Mbps for HDX video).
2. VUDU and other Internet-based services are not provided by Hisense, may change or be discontinued at any time and may be subject to restrictions imposed by your Internet service provider. The quality, functionality, or availability of such services may be affected by the capacity of your Internet connection. Use of VUDU video-on-demand and other Internet services may require the creation of a separate account through a computer with internet access.
3. Certain VUDU services may not be available for this TV model.
4. VUDU video-on-demand and other Internet services may require payment of one-time and/or recurring charges.
5. You are solely responsible for any charges incurred as a result of using Internet-based content, including, without limitation, communications charges for the provision of Internet or network services and any charges incurred for third-party Internet content services, such as video on demand or subscription services. All third-party services are provided in accordance with whatever terms and conditions are established between such third-party providers and you.
6. HISENSE MAKES NO REPRESENTATIONS OR WARRANTIES ABOUT THE CONTENT, AVAILABILITY OR FUNCTIONALITY OF THE VUDU SERVICE OR OTHER INTERNET DELIVERED THIRD-PARTY SERVICES AND DOES NOT WARRANT THAT ANY OF THEM WILL BE UNINTERRUPTED, ERROR FREE OR SATISFACTORY. ANY IMPLIED WARRANTY, INCLUDING BUT NOT LIMITED TO ANY IMPLIED WARRANTY OF MERCHANTABILITY OR FITNESS FOR A PARTICULAR PURPOSE OF ANY THIRD PARTY CONTENT OR SERVICE, IS EXPRESSLY EXCLUDED AND DISCLAIMED. UNDER NO CIRCUMSTANCES WILL HISENSE BE LIABLE IN CONTRACT, TORT OR UNDER ANY OTHER THEORY FOR ANY DAMAGES ARISING OUT OF OR IN CONNECTION WITH YOUR USE OF ANY CONTENT OR SERVICE PROVIDED BY ANY THIRD PARTY, EVEN IF ADVISED OF THE POSSIBILITY OF SUCH DAMAGES.



# Advanced Features

## Operational buttons

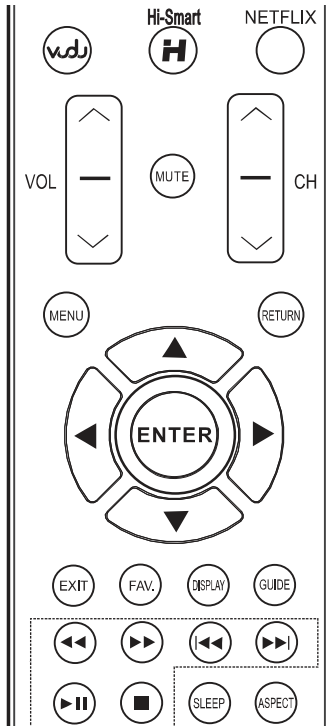

Buttons	Description
	Press to launch Vudu Movies App directly.
	Opens the Hi-Smart Hub with links to various Internet Services.
	Press to launch Netflix App directly.
	Selects the on-screen menu items.
	Confirms selections.
	Closes the menu.
	Returns to the previous menu.
	Stops playback and displays the movie title screen.
	Pauses playback. Press the button to return to playback.
	Displays the TrickPlay screen and fast forwards playback.
	Displays the TrickPlay screen and fast reverses playback.
	Plays the next video.
	Plays the previous video.

## Enter the Network Applications

1. Press the [Hi-Smart] button to display network main menu.



2. Press [] button to select the interface you want to view and press [ENTER] to enter the following description.

No	Interface description
1	The current signal
2	The Hisense advertisement
3	Hisense market
4	Network options
5	Source options

## VUDU HD Movies

### Brief introduction

VUDU is an on-demand service that offers high-definition movies on Web.

For enjoying more movies, please register and log in to your account.

### Operation instructions

You can access the VUDU HD Movies by the following method:

1. Press the [Hi-Smart] button to display network main menu.
2. Press [] button to select the VUDU HD Movies icon and press [ENTER] to enter it (Refer to "Enter the network application"), or press [VUDU] button to enter directly.
3. Select the Sign Up Now icon on the VUDU HD Movies interface, and press [ENTER] to enter.

# Advanced Features

- Please read the content of the Disclaimer first. If agree, Press [GREEN] button and then access the network main menu. If disagree, press [RED] button or [YELLOW] button to cancel or exit Disclaimer menu, then network cannot be used.

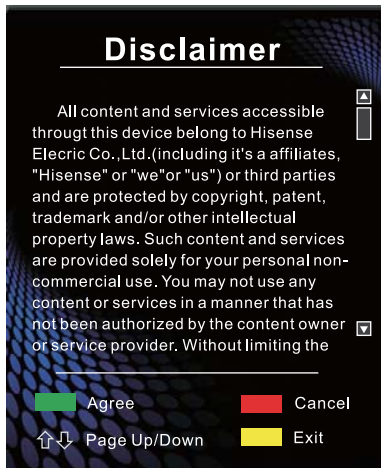

- Enter your email address to start your VUDU experience. ( Refer to "How to Input the Email Address" )
- Press [▲/▼/◀/▶] button to move the cursor to select service items in the VUDU HD Movies home page, and press [ENTER] button to confirm.
- In the process of watching a movie, press [ENTER] button to display/exit the tool bar, press [◀/▶] button to select the function icon, and press [ENTER] button to confirm.
- Press [RETURN] button to return the upper menu, or press [EXIT] button to close the menu.

## ● Tool Bar

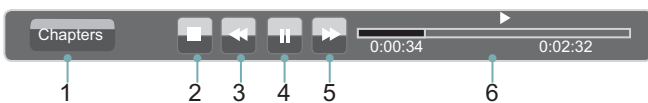

- Press [ENTER] button to enter and press [◀/▶] button to select the chapter.
- Stop playback.
- Fast backward. Press [ENTER] button to select the backward speed. You can press [◀◀] button to achieve the function.
- Play/Pause. You can press [▶||] button to play/pause directly when there is no control bar on the screen.
- Fast forward. Press [ENTER] button to select the forward speed. You can press [▶▶] button to achieve the function.
- Progress bar. The progress bar when playing.

## 🔑 How to Input the Email Address

- Press [▲/▼/◀/▶] button to move the cursor to the address bar and press [ENTER] button to confirm.

- Press [ENTER] button to display the keyboard. There are some shortcuts on the bottom of the keyboard so that you can input part of the address often used directly. Other keys are used as the keyboard of your computer.

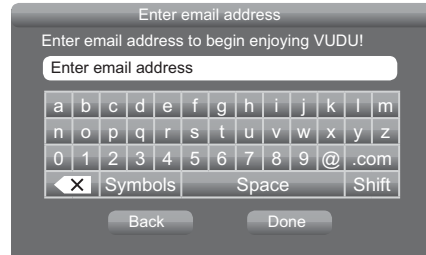

- Press [▲/▼/◀/▶] button to move the cursor to the characters you want to select and then press [ENTER] button to confirm. If you want to delete one character, move the cursor to Back key [X] and press [ENTER] button to confirm.
- Move the cursor to Done key and press [ENTER] button to confirm if you have completed the address input. Then the new address will appear on the address bar.

## 📌 NOTE

TV screen may be difference with picture.

## 🔑 VUDU HD Movies home page

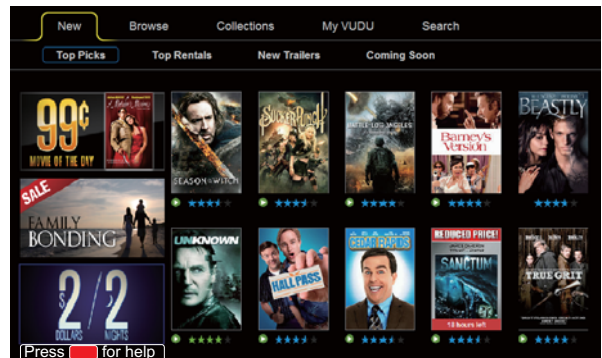

Title	Function
New	The latest movies
Top Picks	Mostly picked up movies
Top Rentals	Mostly rented movies
New Trailers	Latest trailers
Coming Soon	The movies can be picked soon
Browse	Browse all the movies in VUDU
Collections	Browse the classified movies
My VUDU	The movies user bought or rented
Search	Search movies in VUDU

# Advanced Features

## VUDU HD Movies subpage



Title	Function
Rent/Own	To rent or buy current movie
Watch Trailer	To watch trailer of the current movie
2 Minute Preview	To preview current movie for 2 minutes
Add to Wishlist	Add current movie to your wishlist
Rate/share	To rate current movie or share it to your friends in Facebook or Twitter
Overview	The overview of current movie
Cast&Crew	The cast and crew of current movies and find their related movies
Reviews	The reviews of current movie
Similar	The similar types of movies
More Info	The detail information of current movie

## VUDU Apps

### Brief introduction

The applications platform for connected TVs.

- VUDU Apps provides customers with access to a wide range of Internet services and applications including streaming video, music on demand, photo browsing, social networking and more.
- VUDU Apps supports the development of responsive apps designed specifically for use on home HD televisions.
- VUDU Apps uses a unique, cloud-based architecture optimized for consumer electronics devices, including delivering the latest applications to consumers without the need for software downloads or frequent firmware updates.
- Devices featuring VUDU Apps\* will begin shipping to consumers since the first quarter of this year.
- VUDU Apps\*\* allows you to see app updates while watching live television.

### Operation instructions

You can access the VUDU Apps by the following methods:

1. Press the [Hi-Smart] button to display network main menu.
2. Press [◀/▶/▲/▼] button to select the VUDU Apps icon and press [ENTER] to enter it.
3. Press [◀/▶/▲/▼] button to select the widget you want to access, and press [ENTER] to enter it.
4. You can press [RETURN] to return the upper menu or press [EXIT] button to close the Widgets display.

### VUDU Apps home page

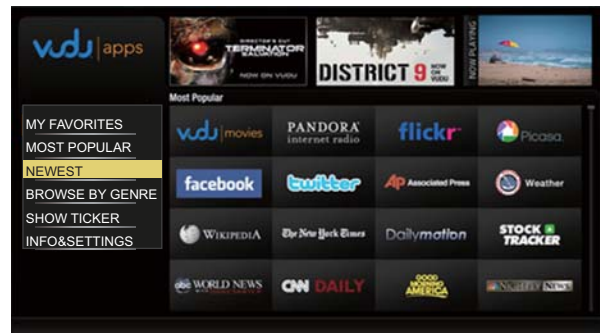

Title	Function
My favorites	The user's favorite applications
Most popular	The most popular applications
Newest	The newest applications in VUDU
Browse by genre	Browse applications by genre
Show Ticker	Show the applications at the bottom of screen while watching TV
Info&settings	VUDU Apps system information

## Netflix

**Netflix unlimited membership required.**

### Brief introduction

Instantly watch thousands of TV episodes & movies streaming over the Internet from Netflix. Unlimited membership required.

### NOTES

- TV screen may be difference with picture.
- For more information on Netflix visit <http://www.netflix.com/help> or login to your Netflix account and click "Help" at the top of the page.
- Your broadband fluency and picture quality depend on the network speed and original bit rate.
- Illustrations are examples and may differ from the actual Netflix screens. The display and operations may change as a result of a software update. Use Netflix without configuring a proxy server. Part or all of Netflix may not be available when connecting to the Internet via a proxy server.



# Advanced Features

## Operation instructions

1. Press the [Hi-Smart] button to display network main menu.
2. Press [◀/▶/▲/▼] button to select the Netflix icon and press [ENTER] to enter it, or press [NETFLIX] button to enter Netflix website directly.
3. Input Email and Password in following window to sign in. ( Refer to “How to Input the Email Address” )



4. Press [▲/▼/◀/▶] button to move the cursor to select service items in the Netflix home page, and [ENTER] button to confirm.
5. In the process of watching a movie, press operational buttons to control the movie.
6. Press [RETURN] button to return the upper menu, or press [EXIT] button to close the menu.

## Netflix Movies home page

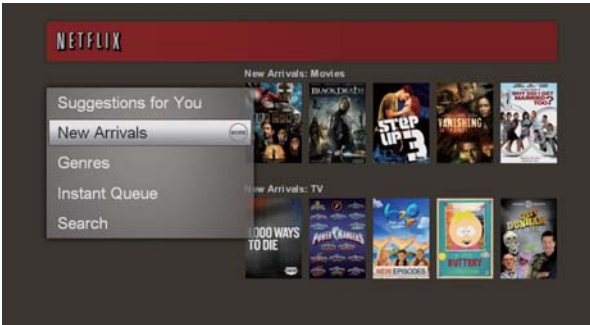

Title	Function
Suggestions for you	The movies suggested for you by Netflix
New Arrivals	The new arrivals
Genres	Browse movies in different genres
Instant Queue	Your list of movies
Search	Search for available titles

## Opera

### The function of the buttons on the remote control

Buttons	Description
▲/▼/◀/▶	Press these buttons to move the cursor on the screen as the mouse of the computer.
MENU	Press the button to display/cancel the keyboard on the screen.
ENTER	Press the button to confirm the selection. Press the button twice to search the new website.

### Operation instructions

#### How to enter the Opera Browser

The Network setup must be correct. Then you can use the network.

1. Press the [Hi-Smart] button to display network main menu.
2. Press [◀/▶/▲/▼] button to select the opera icon and press [ENTER] to enter it.



3. Then the default interface will appears on the screen. There are some function icons on the bottom of the screen:

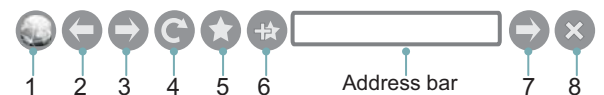

#### The function of the buttons on the screen:

1. Back to main page.  
Move the cursor to the icon and press [ENTER] button to return to the default interface.
2. Back to previous page.  
Move the cursor to the icon and press [ENTER] button to return to the previous viewed web page.
3. Return a page.  
Move the cursor to the icon and press [ENTER] button to go forward to the previous viewed web pages.

## Advanced Features

4. Refresh page.  
Move the cursor to the icon and press [ENTER] button to refresh the current page.
5. Folder.  
Move the cursor to the icon and press [ENTER] button to enter the favorite folder.
6. Add Folder.  
Move the cursor to the icon and press [ENTER] button to add the website to the favorite folder.
7. Address bar.  
Input the website you want to view.
8. Sure to enter the Address of the page  
Move the cursor to the icon and press [ENTER] button to search the website.
9. Exit Opera.  
Move the cursor to the icon and press [ENTER] button to close the page.

### ● How to Input the New Address



1. Press [▲/▼/◀/▶] button to move the cursor to the address bar and press [ENTER] button to confirm.
2. Press [MENU] to display the keyboard.  
There are some shortcuts on the bottom of the keyboard so that you can input part of the address often used directly.  
Other keys are used as the keyboard of your
3. Press [▲/▼/◀/▶] button to move the cursor to the characters you want to select and then press [ENTER] button to confirm.  
If you want to delete one character, move the cursor to Back key and press [ENTER] button to confirm. Or if you want to re-enter all the characters, move the cursor to Reset key and press [ENTER] button to confirm.
4. Move the cursor to Enter key and press [ENTER] button to confirm if you have completed the address input.  
Then the new address will appear on the address bar.
5. Move the cursor to the address bar and press [ENTER] button twice to enter the website.  
Or move the cursor to the → and press [ENTER] button to search.

### NOTE

There is only recommend to open the English website.

### ● How to Add a Bookmark

If you want to find the often viewed website from the favorite folder, you can follow the steps to add it to the folder.

1. Input the address on the address bar and enter it.
2. Press [▲/▼/◀/▶] button to move the cursor to the ⚙️ and press [ENTER] button to confirm.  
The menu will pop up on the screen.

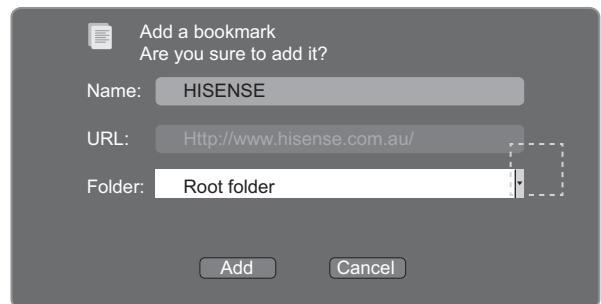

3. Press [▲/▼/◀/▶] button to move the cursor to the icon marked with dashed box on the right screen. Then press [ENTER] button to confirm to display all the folders.
4. Press [▲/▼] button to select the folder you want to add the bookmark to. And press [ENTER] button to confirm.
5. Move the cursor to the Add button and then press [ENTER] button to confirm.  
If you do not want to add the book mark, move the cursor to the Cancel button and press [ENTER] button to confirm.

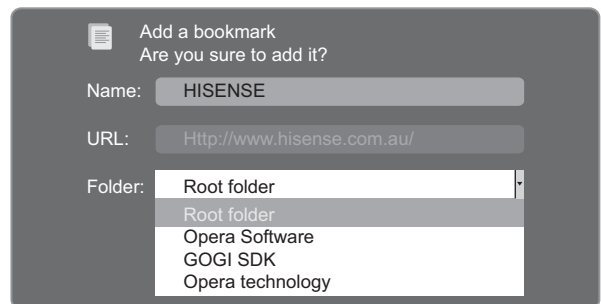

### ● How to Add a Folder

You can add a folder to the favorite as follows:

1. Move the cursor to the ⚙️ icon and press [ENTER] button to confirm. The menu will pop up on the screen.
2. Move the cursor to Add a folder button and press [ENTER] button to confirm.  
A pop-up menu appears on the screen.
3. Move the cursor to Name bar and press [ENTER] button to confirm. Follow the steps 2~4 in "How to Input the New Address" to input the name.
4. Move the cursor to Add button and press [ENTER] button to confirm and the new folder has been added.

## Advanced Features

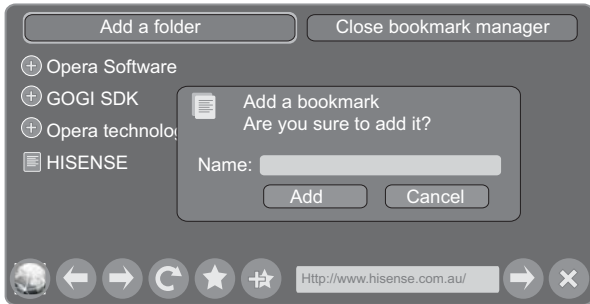

### ● How to Edit/Delete a Folder/Bookmark

1. Move the cursor to the ★ icon and press [ENTER] button to confirm. The menu will pop up on the screen.
2. Move the cursor to the folder /bookmark directly and there will be two icons on the right of it. Move the cursor to one of the icons and press [ENTER] button to display a pop-up menu.

: Edit button.

- 1). Move the cursor to the Name/URL bar and press [ENTER] button to confirm. Follow the steps 2~4 in "How to Input the New Address" to edit it.

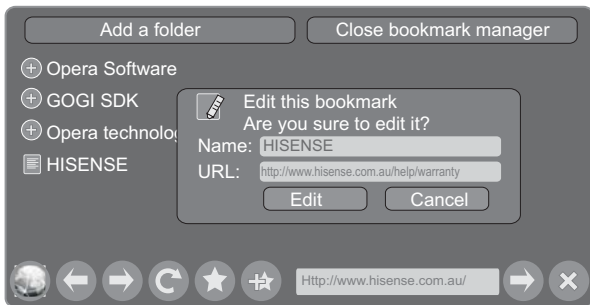

- 2). Move the cursor to Edit button, then press [ENTER] to confirm and the folder/bookmark will be saved.

: Delete button.

Move the cursor to the Delete button and press [ENTER] button to confirm. Then the folder/bookmark will be deleted from the favorite folder.

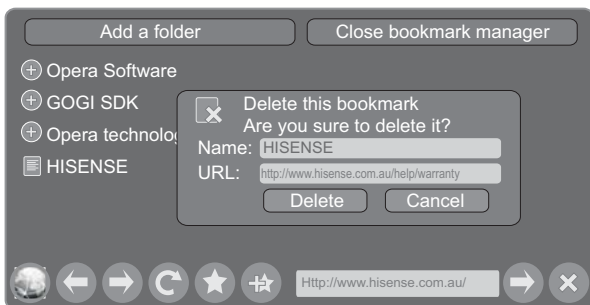

### NOTE

There is only Name bar on the pop-up menu for folder.

### ● How to select the Website from the favorite folder

1. Move the cursor to the ★ icon and press [ENTER] button to confirm. The menu will pop up on the screen.
2. Move the cursor to the + icon before the folder name and press [ENTER] button to confirm. The websites in the folder will appear in the following lines.
3. Move the cursor to the website you want to view and press [ENTER] button to confirm. If the website is in the root folder, you can select it directly. And do not need operate as step 2.

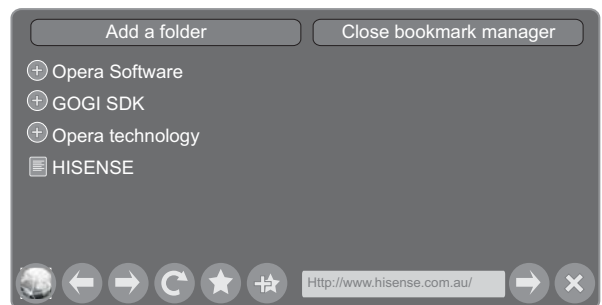

### ● How to exit the manager

Move the cursor to the Close bookmark manager icon and press [ENTER] button to confirm.

## YouTube

### Brief introduction

Watches the video via YouTube.

### Operation introduction

1. Press the [Hi-Smart] button to display network main menu.
2. Press [▲/▼/◀/▶] button to select the YouTube icon and press [ENTER] to enter it.

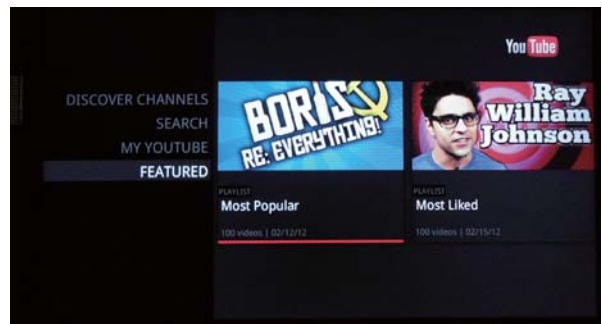

# Advanced Features

## Other Apps

### Operation introduction

1. Press the [Hi-Smart] button to display network main menu.
2. Press [▲/▼/◀/▶] button to select the Other Apps and press [ENTER] to enter it.

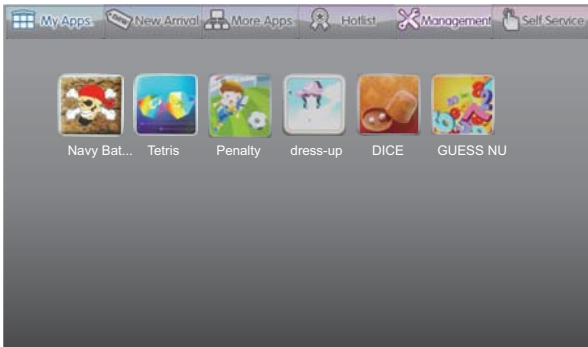

Title	Function
My Apps.	Your local applications
New Arrival	The applications of the latest online
More Apps.	Applications classification to download
Hotlist	The pop ranking applications
Management	Delete the local applications
SelfService	View the service information

3. Follow the steps as following.

#### ● My Apps:

Display the applications of downloaded and installed on the local.

- 1) Press [◀/▶] to select the title of My Apps and press [▼/ENTER] to enter it.

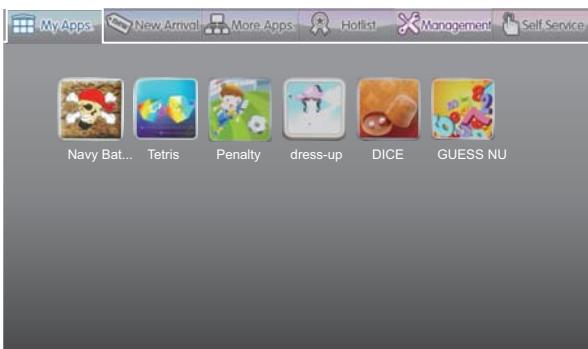

- 2) Press [▲/▼/◀/▶] to select the applications you want to enter and press [Enter] to confirm.
- 3) Press [RETURN] to return to the title.

#### ● New Arrival:

- 1) Press [◀/▶] to select the title of New Arrival and press [▼/ENTER] to enter it.

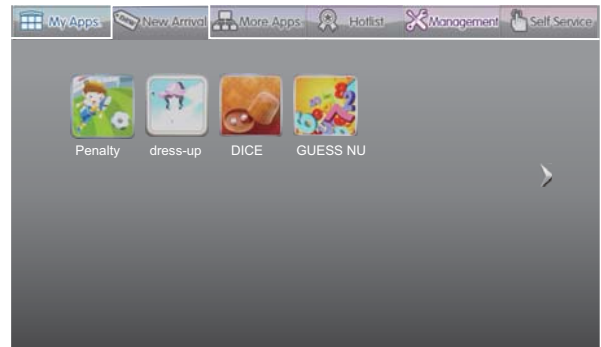

- 2) Press [▲/▼/◀/▶] to select the applications you want to install and press [ENTER] to confirm.

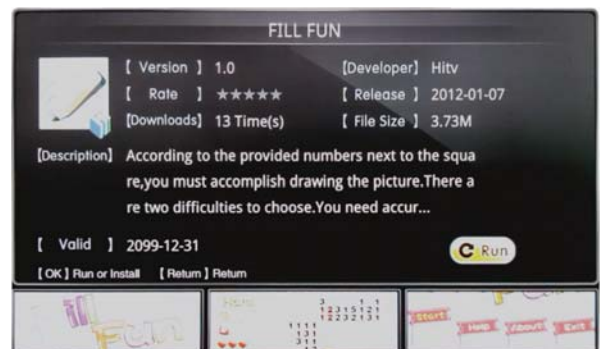

- 3) Press [ENTER] to install the applications or press [RETURN] to return to the new arrival home page. If installed, the application will be shown in My Apps interface.

- 4) Press [RETURN] to return to the title.

#### ● More Apps:

Classify the applications by story, knowledge and funny game.

- 1) Press [◀/▶] to select the title of More Apps and press [▼/ENTER] to enter it.



- 2) Press [▲/▼] to select the classification and press [ENTER] to confirm.
- 3) Press [▲/▼/◀/▶] to select the applications you want to install and press [ENTER] to confirm.
- 4) Press [ENTER] to install the applications or press [RETURN] to return to the More Apps home page.

# Advanced Features

If installed, the applications will be shown in My Apps interface.

## ● Hotlist:

- 1) Press [◀/▶] to select the title of Hotlist and press [▼/ENTER] to enter it.

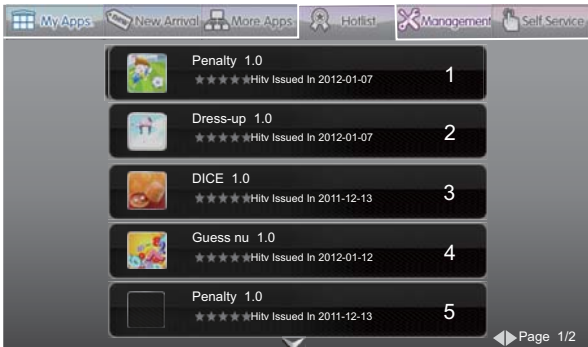

- 2) Press [◀/▶] to page up/down and press [▲/▼] to select the applications you want to install and press [ENTER] to confirm.

- 3) Press [ENTER] to install the applications or press [RETURN] to return to the Hotlist homepage.

If installed, the applications will be shown in My Apps interface.

- 4) Press [RETURN] to return to the title.

## ● Management:

- 1) Press [◀/▶] to select the title of Management and press [▼/ENTER] to enter it.

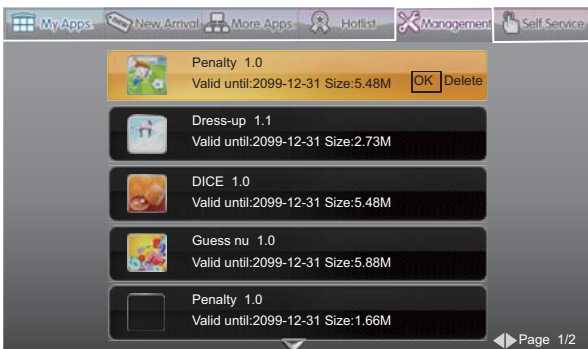

- 2) Press [◀/▶] to page up/down and press [▲/▼] to select the applications you want to delete.

- 3) Press [ENTER] to display the menu.



- 4) Press [◀/▶] to select Yes/No and press [ENTER] to delete.

- 5) Press [RETURN] to return to the title.

## ● SelfService:

Press [◀/▶] to select the title of SelfService and press [ENTER] to view the service information.

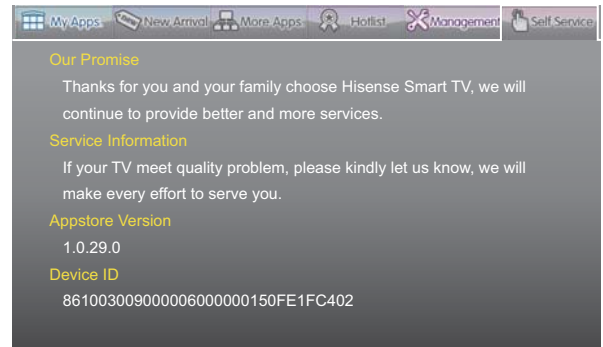

## Other Information

- **VUDU customer care:** To learn more about VUDU, visit the frequently Asked questions at [www.vudu.com/support](http://www.vudu.com/support).

- **Netflix customer service:**

US: (866) 716-0414

Canada: (866) 348-2353



# Advanced Features

## Digital Media Play

Please note that Hisense will not assume any responsibility for any lost data and cannot guarantee perfect compatibility with all mass storage devices. Be sure to insert the USB disk or mobile hard disk with standard USB2.0 port.

- Press [INPUT] button to display the INPUT menu, press [▲/▼] button to highlight the Hi-DMP source, then press [ENTER] button to confirm. (If you want to exit Hi-DMP, you can press [INPUT] button to switch to other sources).
  - Press [RED] button to switch the media type.
  - Press [YELLOW/BLUE] to turn to the previous/next page.
1. Press [▲/▼/◀/▶] button to select the folder/file you want to open and then press [ENTER] to enter/play the folder/file.
  2. Press [RETURN] to return to the previous directory.



## Enjoy Video Files

1. Press [RED] button to switch to All or Video.
  2. Press [▲/▼/◀/▶] to select the video you want to view.
  3. Press [ENTER] to play the video.
  4. Press [■/RETURN] to exit the video and return to the previous directory.
  5. Press [ENTER] button to display/exit the video control bar.
  6. Press [◀/▶] button to select the function icon and then press [ENTER] to confirm.
- **Tool bar**



1. The progress bar when playing.
2. Play/Pause. You can press [▶||] directly to play/pause when there is no control bar on the screen.
3. Play the previous video. You can press [◀◀] directly to achieve the function when no control bar display on the screen.

4. Play the next video. You can press [▶▶] to achieve the function when no control bar display on the screen.
5. Fast backward. Then press [ENTER] to select the backward speed. You can press [◀◀] to achieve the function.
6. Fast forward. Then press [ENTER] to select the forward speed. You can press [▶▶] to achieve the function.
7. Select time to play
  - 1) Press [◀/▶] to select the position you want to set.
  - 2) Press [0~9] to set the time and press [▲/▼/◀/▶] to adjust it.
  - 3) Press [ENTER] to confirm and the video will to play at the time you have set.
8. Play list
  - 1) Press Yellow/Blue button to page and press [▲/▼] to select the video.



- 2) Press [ENTER] to confirm. And press [Exit] to exit the menu.
9. Options
  - 1) Press [▲/▼] to select the options in the menu.
  - 2) Press [◀/▶] to select the settings.
  - 3) Press [ENTER] to confirm.
10. Program info
 

Allows you to view the program information.
11. Stop playback

### NOTE

You can press [ASPECT] button to change the aspect ratio (Normal, Full Screen, Original Size) while playing the video.

### Playable format list

Files Format	Playable format
Photo	JPG
Music	Mp3
Video	MPEG1(.dat), MPEG2(.mpg/.ts), XVID (.avi), H.264(.mov/.ts/.mkv)

# Advanced Features

## Enjoy Music Files

1. Press [RED] button to switch to All or Music.
2. Press [▲/▼/◀/▶] to select the music you want to view.



3. Press [ENTER] to play the music.

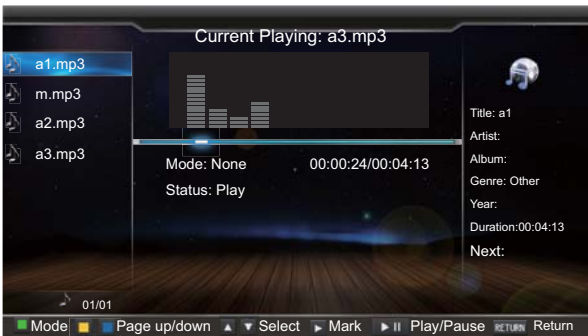

4. All the music is listed on the left. Press [▲/▼] button to select the music and press [▶] button to mark it. You can press [YELLOW/BLUE] button to turn to the previous / next page.
  - Press [GREEN] button to select the Mode: Mark/All/Single.
5. Press [RETURN] to exit the music playback interface.

## Browse the Pictures

1. Press [RED] button to switch to All or Picture.



2. Press [▲/▼/◀/▶] to select the picture you want to view.

3. Press [ENTER] to browse the picture.
4. Press [■/RETURN] to exit the picture and return to the previous directory.

### ● Tool bar

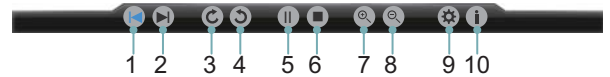

### When browsing the pictures

Press [ENTER] button to display/exit the picture control bar, and press [◀/▶] button to select the function icon and then press [ENTER] button to confirm.

1. Browse the previous picture. You can press [◀◀] button directly to achieve the function when no control bar displays on the screen.
2. Browse the next picture. You can press [▶▶] button directly to achieve the function when no control bar displays on the screen.
3. Allows the picture to rotate 90 degrees clockwise.
4. Allows the picture to rotate 90 degrees anti-clockwise.
5. Play/pause. You can press [ENTER] button directly when no control bar on the screen.
6. Stop browsing the picture. You can press [■] button directly when no control bar on the screen.
7. Zoom in the picture.
8. Zoom out the picture.
9. Option Set. Press [▲/▼] button to select the options and press [◀/▶] button to set them.

Speed - Allows you to browse the picture at different speed.

Effect - Allows you to set how the picture appears on the screen.

Background Music - Allows you to enjoy the music when browsing the pictures if it is set On.

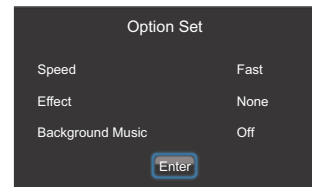

10. Picture info. Allows you to view the picture information.

# Advanced Features

## Browse the Text Files

1. Press [RED] button to switch to All or Book.
2. Press [▲/▼/◀/▶] to select the text you want to view.



3. Press [ENTER] button to confirm.
4. Press [■/RETURN] to exit the text and return to the previous directory.

### ● Tool bar

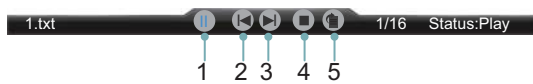

### When browsing the text files

When no tool bar appears on the screen, you can press [▲/▼] to move the text lines up/down.

Press [ENTER] to display/exit the tool bar. Press [◀/▶] to select the corresponding icons and then press [ENTER] to confirm.

1. Stop/resume automatic page
2. View the previous page.
3. View the next page.
4. Stop browsing.
5. Allows you to select page to view.

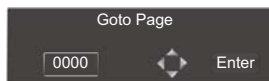

- 1). Press [0~9] buttons to input the page or press [▲/▼] to adjust it.
- 2). Press [◀/▶] to select Enter and press [ENTER] to confirm.



## Other Information

### Trouble Shooting

**When something appears wrong with your TV refer to below chart. If the proposed remedy's do not work , then unplug the AC cord from wall, wait at least 60 seconds, plug AC back in and then turn on the TV. If the problem still cannot be solved, please contact the help line provided on the warranty card or a professional technician.**

<i><b>SYMPTOMS</b></i>	<i><b>POSSIBLE SOLUTIONS</b></i>
No sound or picture.	<ul style="list-style-type: none"> <li>● Check if the power cord is plugged into AC outlet and if it has electricity.</li> <li>● Check if you have pressed [POWER] button on the TV or [POWER] button on the remote control.</li> <li>● Check to see if LED light is either red or blue. If illuminated, power to TV is OK.</li> </ul>
I have connected an external source to my TV and I get no picture and/or sound.	<ul style="list-style-type: none"> <li>● Check for the correct output connection on the external source and for the correct input connection on the TV.</li> <li>● Make sure you have made the correct selection for the input mode for the incoming signal.</li> </ul>
When I turn on my television, there is a few second delay before the picture appears. Is this normal?	Yes, this is normal. That is the TV searching for previous setting information and initializing the TV.
Picture is normal, but no sound.	<ul style="list-style-type: none"> <li>● Check the volume settings.</li> <li>● Check if Mute mode is set "on".</li> </ul>
Sound but no picture or black and white picture.	<ul style="list-style-type: none"> <li>● If black and white picture first unplug TV from AC outlet and re-plug after 60 seconds.</li> <li>● Check Color Setting if picture is black and white.</li> </ul>
Sound and picture distorted or appear wavy.	<ul style="list-style-type: none"> <li>● An electrical appliance may be affecting TV set. Turn off any appliances, if interference goes away, move appliance farther away from TV.</li> <li>● Insert the power plug of the TV set into another power outlet.</li> </ul>
Sound and picture is blurry or cuts out momentarily.	<ul style="list-style-type: none"> <li>● If using an external antenna, check the direction, position and connection of the antenna.</li> <li>● Adjust the direction of your antenna or reset or fine tune the channel.</li> </ul>
Horizontal/vertical stripe on picture or picture is shaking.	Check if there is interfering source nearby, such as appliance or electric tool.
The plastic cabinet makes a "clicking" type of sound.	"Click" sound can be caused when the room temperature changes. This change causes the television cabinet to expand or contract, which makes the sound. This is normal and the TV is OK.
Black square appears in the center of my television screen?	The Closed Caption function is set in the text mode. To remove it, access Closed Caption from the menu screen and change the Mode setting from text to either CC1 or off .
On some channels getting another language or sometimes no sound at all.	<p>That would indicate that the MTS mode on your unit is set to "SAP" mode. We suggest setting the MTS mode to either "Stereo" or "Mono". For further instruction, please see "MTS" in your user manual.</p> <ul style="list-style-type: none"> <li>● SAP is Second Audio Program. It's a second audio channel that is usually used for a second language or descriptive audio for the visually impaired.</li> <li>● MTS stands for Multichannel Television Sound, a standard that allows the encoding of 3 channels of audio within a standard NTSC (analog) video signal to a television. A television that is able to receive MTS Stereo allows you to watch television with stereo sound.</li> </ul>
Not getting all of my cable channels on the television or I'm only getting 13 channels.	Check the cable connection for an incoming signal. The best way to confirm signal is to use another TV and/or contact your cable company.
[CHA / V] don't work when I set the Channel to Cable? They work with the Air setting?	After switching to Cable, please auto program the channels. The TV will "remember" all the channels then the TV will allow you to surf the channels with [CHΛ / V] buttons.

## Other Information

<i><b>SYMPTOMS</b></i>	<i><b>POSSIBLE SOLUTIONS</b></i>
Remote control does not work.	<ul style="list-style-type: none"> <li>● Confirm that TV still has power and is operational.</li> <li>● Change the batteries in the remote control.</li> <li>● Check if the batteries are correctly installed.</li> <li>● If using a universal remote, be sure to select the TV mode on the remote.</li> <li>● If the remote still does not work:               <ul style="list-style-type: none"> <li>-remove and reinstall the batteries correctly to reset the remote or install new batteries.</li> <li>-press TV and then Power to turn on the TV. With a universal remote if you have reset or changed the batteries you will need to reprogram the remote for the other units.</li> </ul> </li> </ul>
Network connection fail.	<ul style="list-style-type: none"> <li>● Check network physical connection, make sure connection is correct.</li> <li>● Enter "Menu", "Settings", "Network", "Configuration", make sure configuration is correct according to your network service provider.</li> <li>● Enter "Menu", "Settings", "Network", "Configuration", "Connection Test" to make sure that network connection test is successful.</li> </ul>
Connect VUDU/Netflix fail.	<ul style="list-style-type: none"> <li>● Check network connection is correct, both physically and configuration.</li> <li>● Enter "Menu", "Settings", "Network", "Configuration", "Connection Test" to make sure that network connection test is successful.</li> <li>● <b>For VUDU:</b> Enter "Menu", "Settings", "Network", "Configuration", "Applications", "VUDU", "Deactivation" to reset VUDU account.</li> <li>● <b>For Netflix:</b> Enter "Menu", "Settings", "Network", "Configuration", "Applications", "Netflix", "Deactivation" to reset Netflix account.</li> </ul>
Log out VUDU/Netflix or change log in account.	<ul style="list-style-type: none"> <li>● <b>For VUDU:</b> <ol style="list-style-type: none"> <li>1. Press [EXIT] button on remote to exit VUDU.</li> <li>2. Enter "Menu", "Settings", "Network", "Configuration", "Applications", "VUDU", "Deactivation" to reset VUDU account.</li> </ol> </li> <li>● <b>For Netflix:</b> <ol style="list-style-type: none"> <li>1. Press [EXIT] button on remote to exit VUDU.</li> <li>2. Enter "Menu", "Settings", "Network", "Configuration", "Applications", "Netflix", "Deactivation" to reset Netflix account.</li> </ol> </li> </ul>
DLNA does not work.	<ul style="list-style-type: none"> <li>● Check network connection is correct, both physically and configuration.</li> <li>● Make sure DLNA server (PC or Mac) has shared media content and TV has permission to access shared media.</li> <li>● Enter "Menu", "Settings", "Network", "Applications", turn on "DLNA".</li> <li>● Select Hi-DMP source to find shared contents. Select "Hi-DMP" source by using [INPUT] button on remote or press [Hi-Smart] button and then select "Multi-Media" icon.</li> </ul>
How do I get the Hi-Smart Hub to work on my TV?	<ul style="list-style-type: none"> <li>● You need a broadband (high speed) Internet service with a speed of no less than 1.5 Mbps.</li> <li>● Connect the TV to the Internet through your router by an ethernet cable or wireless connection. If the connection fails, check with your internet service provider or router manufacturer to determine if there is a firewall, content filter, or proxy settings that may block the TV from accessing the Internet.</li> <li>● After connecting the TV to the Internet, press the [Hi-Smart] button on the remote to access the Hi-Smart Hub.</li> </ul> <p><b>Caution:</b> Do not try to repair the TV yourself. Refer all servicing to qualified repair personnel.</p>

## Other Information

### General

**NOTE**

Features, appearance and specifications are subject to change without notice.

<b>Model Name</b>		<b>32D77W</b>	<b>42D77W</b>
<b>Dimension</b>	<b>Without Stand</b>	Width: 31.2 inches (792 mm) Height: 19.8 inches (503 mm) Depth: 4 inches (101.5 mm)	Width: 40.2 inches (1020 mm) Height: 25 inches (634 mm) Depth: 4.2 inches (106 mm)
	<b>With Stand</b>	Width: 31.2 inches (792 mm) Height: 22.1 inches (561 mm) Depth: 9.1 inches (230 mm)	Width: 40.2 inches (1020 mm) Height: 27.6 inches (700 mm) Depth: 11.2 inches (285 mm)
<b>Weight</b>	<b>Without Stand</b>	19.8 lbs (9 kg)	34.2 lbs (15.5 kg)
	<b>With Stand</b>	20.9 lbs (9.5 kg)	37.5 lbs (17 kg)
<b>LCD Panel Minimum size (diagonal)</b>		32 inches	42 inches
<b>Screen resolution</b>		1366 × 768	1920 × 1080
<b>Audio power</b>		6 W + 6 W	8 W + 8 W
<b>Power consumption</b>		Please refer to the rating label.	
<b>Power supply</b>		120 V ~ 60 Hz	
<b>Receiving systems</b>	<b>Analog</b>	NTSC	
	<b>Digital</b>	NTSC / ATSC / QAM	
<b>Environmental conditions</b>		Temperature: 41°F ~ 95°F (5°C~ 35°C) Humidity: 20%-80% RH Atmospheric pressure: 86 kPa - 106 kPa	
<b>Component Input</b>		480 I / 60 Hz, 480 P / 60 Hz, 720 P / 60 Hz, 1080 I / 60 Hz, 1080 P / 60 Hz	
<b>VGA Input</b>		VGA (640×480 / 60 Hz), SVGA (800×600 / 60 Hz), XGA (1024×768 / 60 Hz)	
<b>HDMI Input</b>		RGB / 60 Hz (640×480, 800×600, 1024×768) YUV / 60 Hz (480 I, 480 P, 720 P, 1080 I, 1080 P)	

The remote control requires:

- Number of Batteries: 2
- Type: AAA
- Voltage: 1,5Vcc