

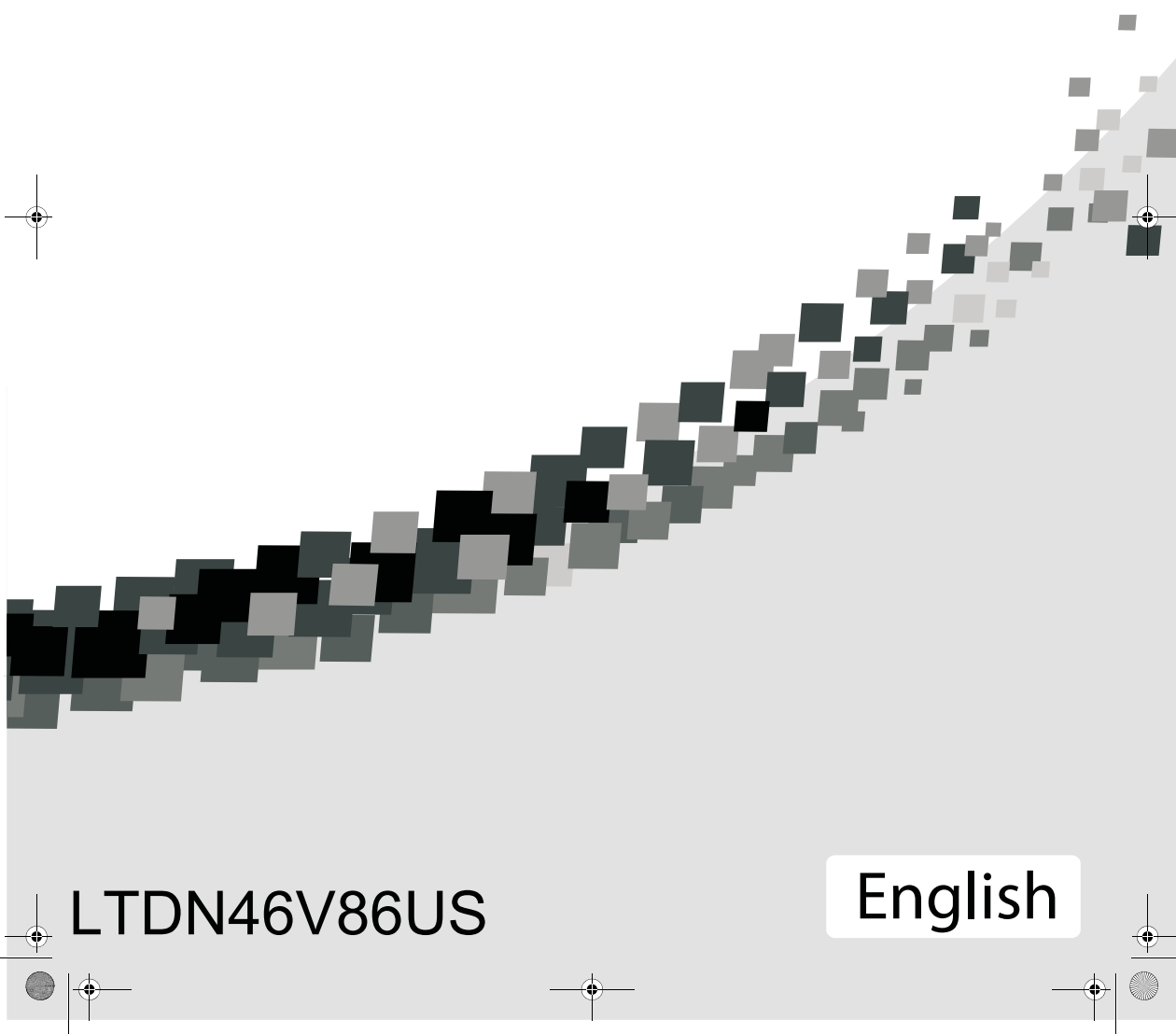

LCD TV

USER MANUAL

Before using the TV, Please read this manual thoroughly, retain it for future reference.



LTDN46V86US

English

Hisense LTDN46V86US 46" LCD TV

Contents

CHILD SAFETY	1
Important safety instructions	2
Warnings	2
Cautions	2
Accessories	3
Installing and removing the stand	3
Installing the stand	3
Removing the stand	4
Installing a wall-mount bracket	4
TV components	4
Front and side controls	4
Back connections	5
Remote control	5
Using the remote control	6
Installing remote control batteries	6
Aiming the remote control	7
Making connections	7
Connecting the power	7
Selecting a location	8
Connecting an HDMI device	8
Connecting a component video device	8
Connecting an antenna, cable TV, or satellite TV box	9
Connecting a VCR, camcorder, or game console	9
Connecting a computer	9
Connecting a home theater system	10
Connecting headphones	10
Turning on your TV for the first time	11
Understanding the basics	11
Turning your TV on or off	11
Selecting the video input source	11
Selecting a channel	11
Adjusting the volume	12
Displaying program information	12
Navigating the menus	12
On-screen menu overview	12
Adjusting the picture	13
Choosing the display format (aspect ratio)	13
Adjusting the sound	14
Selecting the audio mode	14
Changing channel settings	14
Setting parental controls	14
Adjusting TV settings	15
Troubleshooting	16

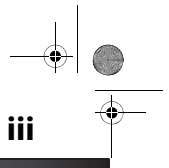
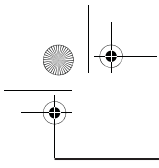

Video and audio16
Remote control16
General17
Maintenance17
 Cleaning17
Specifications17
Legal notices17

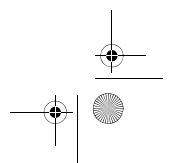
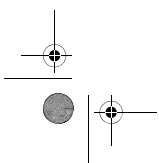

CHILD SAFETY

It makes a difference how and where you use your flat panel display

As you enjoy your new product, keep these safety tips in mind

The issue

The home theater entertainment experience is a growing trend, and larger TVs are popular purchases. However, TVs are not always supported on the proper stands or installed according to the manufacturer's recommendations. We and the consumer electronics industry are committed to making home entertainment enjoyable and safe.

TVs that are inappropriately placed on dressers, bookcases, shelves, desks, speakers, chests, or carts may fall over and cause injury.

Tune into safety

- One size of TV stand does **not** fit all. Use only a TV stand rated for the weight of your TV.
- Carefully read and understand all enclosed instructions for proper use of this product.
- Don't let children climb on or play with entertainment system furniture and TVs.
- Don't place TVs on furniture that can easily be used as steps, such as a crate or chest of drawers.
- Remember that children can become excited while watching a program, especially on a "larger-than-life" TV. Make sure that you place or install the TV where it cannot be pushed, pulled over, or knocked down.
- Make sure that you route all cords and cables so that they cannot be pulled or grabbed by curious children.



Wall mounting

If you decide to wall mount your TV, always remember:

- One size of wall mount does **not** fit all. Use only a wall mount rated for the weight of your TV and that has been recommended by this TV manufacturer, listed in this manual, or otherwise listed by an independent laboratory as suitable for your TV.
- Follow all instructions supplied by the TV and wall mount manufacturers.
- If you have any doubts about your ability to safely wall mount your TV, get help from a professional installer.
- Make sure that the wall where you are mounting the TV is appropriate. Some wall mounts are not designed to be mounted to walls backed with steel studs or cinder blocks. If you are unsure, ask a professional installer.
- TVs can be heavy. At least two people are required for safe wall mount installation.



Important safety instructions

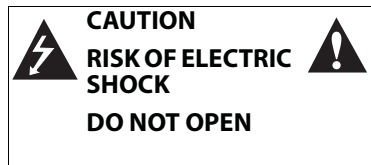

This symbol indicates that dangerous voltage constituting a risk of electric shock is present within your TV. This label is located on the back of your TV.



This symbol indicates that there are important operating and maintenance instructions in the literature accompanying your TV.

- 1 Read these instructions.
- 2 Keep these instructions.
- 3 Heed all warnings.
- 4 Follow all instructions.
- 5 Do not use this apparatus near water.
- 6 Clean only with a dry cloth.
- 7 Do not block any ventilation openings. Install in accordance with the manufacturer's instructions.
- 8 Do not install near any heat sources such as radiators, heat registers, stoves, or other apparatus (including amplifiers) that produce heat.
- 9 Do not defeat the safety purpose of the polarized or grounding-type plug. A polarized plug has two blades with one wider than the other. A grounding type plug has two blades and a third grounding prong. The wide blade or the third prong are provided for your safety. If the provided plug does not fit into your outlet, consult an electrician for replacement of the obsolete outlet.
- 10 Protect the power cord from being walked on or pinched particularly at plugs, convenience receptacles, and the point where they exit from the apparatus.
- 11 Only use attachments/accessories specified by the manufacturer.
- 12 Use only with a cart, stand, tripod, bracket, or table specified by the manufacturer, or sold with the apparatus. When a cart is used, use caution when moving the cart/apparatus combination to avoid injury from tip-over.  S3125A
- 13 Unplug this apparatus during lightning storms or when unused for long periods of time.
- 14 Refer all servicing to qualified service personnel. Servicing is required when the apparatus has been damaged in any way, such as power-supply cord or plug is damaged, liquid has been spilled or objects have fallen into the apparatus, the apparatus has been exposed to rain or moisture, does not operate normally, or has been dropped.
- 15 The wall plug is the disconnecting device. The plug must remain readily operable.
- 16 An apparatus with a three-prong, grounding-type plug is a Class I apparatus, which needs to be grounded to prevent possible electric shock. Make sure that you connect this Class I television to a grounding-type, three-prong outlet.
- 17 Remote control batteries should not be exposed to excessive heat such as sunshine, fire, or the like.

- 18 The apparatus should not be exposed to dripping or splashing, and no objects filled with liquids, such as vases, should be placed on the apparatus.

Warnings

Electric shock hazard

To reduce the risk of fire or electric shock, do not remove any cover or expose the device to rain or moisture. No user-serviceable parts are inside. Refer servicing to qualified service technicians.

Lightning

For added protection for your device receiver during a lightning storm, or when it is left unattended and unused for long periods of time, unplug it from the power outlet and disconnect any antenna or cable system. This helps prevent property damage and personal injury from lightning and power line surges.

Power lines

An outside antenna system should not be located in the vicinity of overhead power lines or other electric light or power circuits, or where it can fall into such power lines or circuits. When installing an outside antenna system, extreme care should be taken to keep from touching such power lines or circuits as contact with them might be fatal.

Handling the LCD panel

- Your TV's screen is made of glass. Do not drop your TV or hit, jolt, or press hard against the LCD panel. If the screen breaks, be careful of broken glass.
- If the LCD panel is broken, make absolutely sure that you do not touch the liquid in the panel. This may cause skin inflammation.
- If the liquid gets in your mouth, immediately gargle, rinse, and consult with your doctor. Also, if the liquid gets in your eyes or touches your skin, consult with your doctor after rinsing for at least 15 minutes or longer in clean water.

Replacement parts

When replacement parts are required, make sure that the service technician uses replacement parts specified by the manufacturer that have the same characteristics as the original part. Unauthorized substitutions may result in fire, electric shock, personal injury, or other hazards.

Safety check

After completing any service or repair to this device, ask the service technician to perform routine safety checks to determine that your TV is in correct operating condition.

Power source

Operate your TV only from the type of power source indicated on the marking label. If you are not sure of the type of power supplied to your home, consult an electrician or your local power company.

Cautions

Damage requiring service

Unplug this TV from the power outlet and refer servicing to qualified service personnel under the following conditions:

- When the power supply cord or plug is damaged or frayed.
- If liquid has been spilled or objects have fallen into your TV.
- If your TV has been exposed to rain or water.

- If your TV does not operate normally by following the operating instructions. Adjust only those controls that are covered by the operating instructions because incorrect adjustment of other controls may result in damage and will often require extensive work by a qualified technician to restore your TV to its normal operation.
- If your TV has been dropped or damaged in any way.
- When your TV exhibits a distinct change in performance.

Outdoor antenna grounding

If an outside antenna or cable system is connected to your TV, make sure that the antenna or cable system is grounded to provide some protection against voltage surges and built-up static charges. Article 810 of the National Electrical Code, ANSI/NFPA No. 70, provides information with respect to correct grounding of the mast and supporting structure, grounding of the lead-in wire to an antenna discharge unit, size of grounding conductors, location of the antenna-discharge unit, connection to grounding electrodes, and requirements for the grounding electrode.

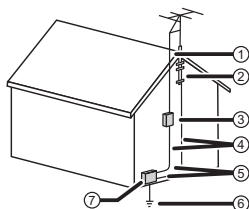

①	Antenna lead-in wire
②	Grounding clamp
③	Antenna discharge unit
④	Grounding conductors
⑤	Ground clamps
⑥	Power service grounding electrode system
⑦	Electric service equipment

Note to CATV system installer

Article 820 of the National Electrical Code, ANSI/NFPA No. 40 provides guidance for correct grounding. Specifically, it states that the cable ground must be connected to the grounding system of the building as close to the point of cable entry as practical.

Condensation

Moisture will form on the TV if the TV is brought from cool surroundings into a warm room or if the temperature of the room rises suddenly. When this happens, the TV's performance may be impaired. To prevent this, let the TV stand in its new surroundings for about an hour before switching it on, or make sure that the room temperature rises gradually. Condensation may also form during the summer if the TV is exposed to the breeze from an air conditioner. In such cases, change the location of the TV.

Mobile telephone warning

To avoid interference with your TV picture and sound, operating problems, or even damage, keep your cordless and cellular telephones away from the TV.

End of life directives

Your TV contains tin-lead solder and a fluorescent lamp containing a small amount of mercury. Disposal of these materials may be regulated for environmental reasons. Your TV also contains material that can be recycled and reused. For disposal or recycling information, contact your local authorities or the Electronic Industries Alliance at www.eia.org to find a recycler in your area.

Non-active pixels

The LCD panel contains almost 3 million thin film transistors, which provide exceptionally sharp video quality. Occasionally, a few non-active pixels may appear on the screen as a fixed blue, green, or red point. These non-active pixels do not adversely affect the performance of your TV, and are not considered defects.

Accessories

Make sure the following accessories are included in the box with your TV:

- Remote control
- User Manual
- AAA batteries (2)
- Stand
- Power cord
- Quick Setup Guide

Installing and removing the stand

You must install your TV into the stand in order for it to stand upright on a cabinet or other flat surface. If you intend to mount your TV on a wall or other vertical surface, you must remove the stand column.

Warning: Before attempting assembly or removal of the stand, unplug the AC power cord.

Cautions:

- Read these instructions carefully before you try to assemble the stand or remove the stand column.
- Make sure that you handle the TV carefully when attempting to assemble or remove the stand. If you are not sure of your ability to do this, contact a professional installer or service technician. Hisense is not responsible for any damages or injuries that occur because of mishandling or incorrect assembly.
- Use a soft cushion or covering to prevent scratching or damage to the TV screen or cabinet.

Installing the stand

Note: Your TV may differ from the illustrations shown.

To install the stand:

- 1 Remove the stand from the box and place it on a table or bench.
- 2 Lay the TV (screen down) on the edge of the table or bench. Make sure that you put a soft cloth or cushion between the table or bench and the TV.

- 3 Align the base with the TV, then secure the stand to the TV with the four screws (M6 x 12) provided.

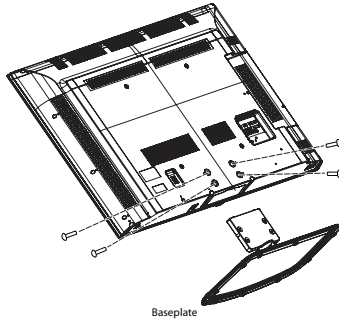

- 4 Carefully lift the TV into an upright position. To remove the stand, see the following procedure.

Removing the stand

You must remove the stand before you can wall-mount the TV.

Note: Your TV may differ from the illustrations shown.

To remove the stand:

- 1 Lay the TV (screen down) on the edge of the table or bench. Make sure that you put a soft cloth or cushion between the table or bench and the TV.
- 2 Remove the four screws holding the stand to the TV, then remove the stand.

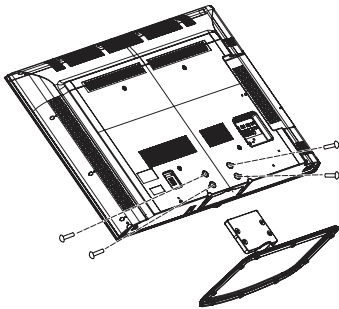

Installing a wall-mount bracket

If you want to attach the TV to a wall-mount bracket (not provided), you should first remove the stand, if it has been installed.

Warning: These instructions are for use by qualified service person only. To reduce the risk of hazards, do not perform any servicing other than that contained in the operating instructions unless you are qualified to do so.

To install a wall-mount bracket:

- 1 Lay your TV face down on a table or bench. Make sure that you put down a soft cushion or cloth so that your TV is not scratched.
- 2 Remove the pedestal stand. See "Removing the stand" above.

- 3 Secure the wall-mount bracket to the back of your TV using the four screws provided with the bracket.

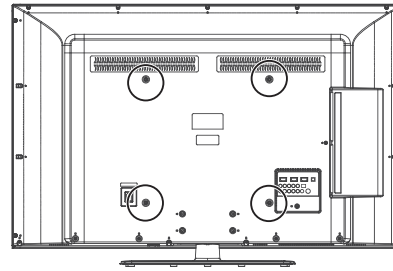

TV components

Front controls

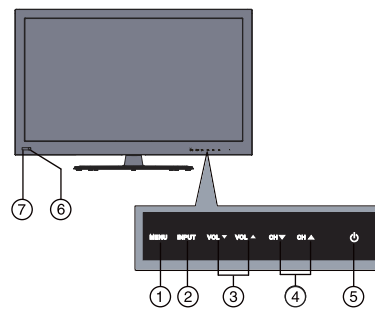

Item	Name	Description
①	MENU	Press to open the on-screen menu.
②	INPUT	Press to open the INPUT SOURCE menu. For more information, see "Selecting the video input source" on page 11.
③	VOL ▲ / VOL ▼	In TV mode, press to increase or decrease the volume. In menu mode, press to move right or left or to adjust menu settings.
④	CH ▲ / CH ▼	In TV mode, press to select the next or previous channel. In menu mode, press to move up or down.
⑤	⏻ (power)	Press to turn on the TV or put the TV in standby mode. Caution: The TV continues to receive power even in standby mode. Unplug the power cord to disconnect power.
⑥	Power indicator	Lights red when your TV is in standby mode. Turns off when the TV is on.
⑦	Remote control sensor	Receives signals from the remote control. Do not block. For more information, see "Aiming the remote control" on page 7.

Back connections

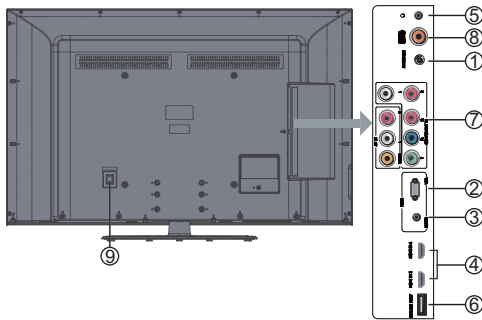

#	Item	Description
①	ANT/CABLE IN	Connect an antenna or cable TV to this jack. For more information, see "Connecting an antenna or cable TV (no box)" on page 11.
②	PC IN VGA	Connect the video (VGA) for a computer to this jack. For more information, see "Using VGA" on page 14.
③	PC IN AUDIO	Connect the audio for a computer or a DVI device to this jack. For more information, see "Using VGA" on page 14 or "Using DVI (same as HDMI but requires a sound connection)" on pages 8 or 11.
④	HDMI1/HDMI2	Connect HDMI devices to these jacks. An HDMI cable carries both video and sound. You do not need to make an audio connection for an HDMI device. For more information, see "Using HDMI (best)" on pages 8, 11, or 14. When connecting a DVI device using an HDMI-DVI adapter, connect the device to the HDMI1 or HDMI2 jack.
⑤	⌂ (headphone)	Connect headphones to this jack. For more information, see "Connecting headphones" on page 15.
⑥	Service port	For software update only. Do not use.
⑦	COMPONENT Y/Pb/Pr and AV IN	Connect the video for a component video device to these jacks. Connect the video cable from a composite video device to the "Y" jack. For more information, see "Using component video (better)" on pages 9 or 12.
⑧	DIGITAL OUT	Connect an audio amplifier to this jack. For more information, see "Using digital audio" on page 15.
⑨	AC IN	Connect the supplied power cord here.

Remote control

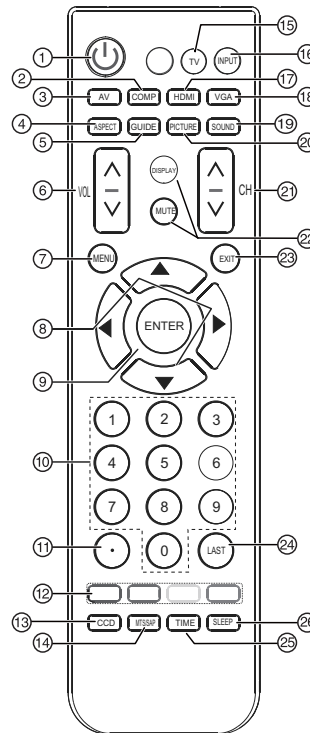

Item	Name	Description
①	POWER ⏻	Press to turn on the TV or put the TV in standby mode. Caution: The TV continues to receive power even in standby mode. Unplug the power cord to disconnect power.
②	COMP	Press repeatedly to select a device connected to the COMP IN jacks.
③	AV	Press repeatedly to select a device connected to the AV IN jacks.
④	ASPECT	Press to select the video display format. For more information, see "To adjust the picture." on page 13.
⑤	GUIDE	Press to open the DTV program guide (if available) when viewing digital channels. For more information, see "Displaying program information" on page 12.
⑥	VOL ▲ / VOL ▼	Press to increase or decrease the volume.
⑦	MENU	Press to open the on-screen menu.
⑧	▲ ▼ ◀ ▶	Press to move up, down, left, or right in on-screen menus or to adjust menu settings.
⑨	ENTER	Press to confirm selections in on-screen menus or to open sub-menus.

Item	Name	Description
⑩	Numbers	Press the number buttons to enter channel numbers or the parental control password. For more information, see "Selecting a channel" on page 11.
⑪	. (dot)	Press to select a digital sub-channel. See "Selecting a channel" on page 11.
⑫	Program guide (EPG) function buttons	After pressing the GUIDE button when viewing digital channels, the same color buttons will appear with explanations in the on-screen display (OSD). Follow the steps shown in the OSD.
⑬	CCD	Press to turn closed captioning on or off. For more information, see "Adjusting TV settings" on page 15.
⑭	MTS/SAP	When viewing analog (non-digital) channels, press to select STEREO, SAP (secondary audio language), or MONO . When viewing digital channels, press to select the audio track. For more information, see "Selecting the audio mode" on page 14.
⑮	TV	Press to select the TV as the video input source. For more information, see "Selecting the video input source" on page 11.
⑯	INPUT	Press to open the <i>INPUT SOURCE</i> menu, then press ▲ or ▼ to select the video input source you want. For more information, see "Selecting the video input source" on page 11.
⑰	HDMI	Press repeatedly to select a device connected to one of the HDMI jacks.
⑱	VGA	Press to select VGA mode.
⑲	SOUND	Press to select the sound mode. You can select Standard, Speech, User, and Music . For more information, see "Selecting the audio mode" on page 14.
⑳	PICTURE	Press to select the video mode. You can select Vivid, Standard, Theater, Energy Saving, Sports, and Custom . For more information, see "Adjusting the picture" on page 13.
㉑	CH ^ / v	Press to go to the next or previous channel in the channel list. For more information, see "Turning on your TV for the first time" on page 11 and "Selecting a channel" on page 11.
㉒	DISPLAY	Press to display the information banner. For more information, see "Displaying program information" on page 12.
㉓	MUTE	Press to mute the sound. Press again to restore the sound.
㉔	EXIT	Press to close the on-screen menu.
㉕	LAST	Press to go to the last viewed channel. For more information, see "Selecting a channel" on page 11.
㉖	TIME	Press to display the current time.
㉗	SLEEP	Press to set the sleep timer. For more information, see "Adjusting TV settings" on page 15.

Using the remote control

Installing remote control batteries

To install remote control batteries:

- 1 Press down on the battery compartment cover lock, then remove the remote control cover.



- 2 Insert two AAA batteries into the battery compartment. Make sure that the + and – symbols on the batteries match the + and – symbols in the battery compartment.
- 3 Replace the cover. Make sure that the lock snaps into place.

Battery precautions:

- Dispose of batteries as hazardous waste.
- Do not mix batteries of different types.
- Do not mix old and new batteries. Mixing old and new batteries can shorten the life of new batteries and can cause old batteries to leak.
- Remove batteries as soon as they become inoperable. Chemicals that can leak from the batteries can cause a rash. If the batteries leak, clean the battery compartment with a cloth.
- If the remote control is not used for an extended period of time, remove the batteries.
- Do not expose batteries to excessive heat such as sunshine, fire, or other heat sources.

Aiming the remote control

To aim the remote control:

- Point the remote control towards the remote sensor on the front of your TV.

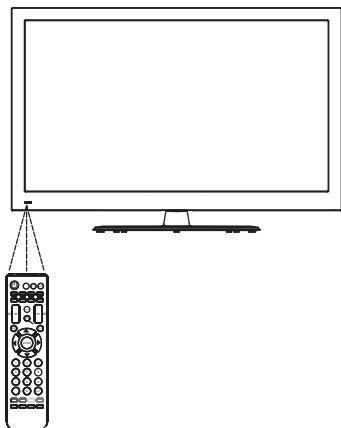

Notes:

- Do not expose the remote control to shock or liquids.
- Do not use the remote control in an area with high humidity.
- Do not place the remote control in direct sunlight.
- Do not place objects, such as furniture, between the remote control and the remote sensor.
- The remote control may not work if direct sunlight or bright light shines on the remote sensor. Either move your TV or change the angle at which you use the remote control.

Notes:

- The AC plug on the TV may be different from the one shown.
- Make sure that you only use the type of power source indicated on the marking label.
- Always unplug the power cord when not using the TV for a long period of time.

Making connections

Before you make any connections:

- Check the plugs on the ends of cables to make sure that they are the correct type before you try plugging them into jacks on the TV.
- Make sure that all plugs are securely inserted into the jacks. Loose connections can result in image or color problems.
- When connecting devices to the TV, make sure that the TV and the device are turned off and that the power cords are unplugged.

Connecting the power

To connect the power cord:

- Connect the power cable to the **AC IN** jack on the back of the TV, then connect the other end to a power outlet.

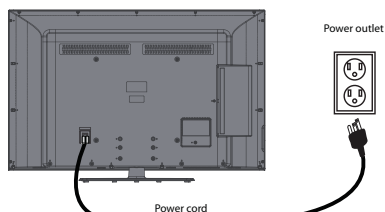

Selecting a location

You should select a location for the TV:

- Where direct light does not reflect on the screen
- That has indirect and soft lighting
- Where the TV has access to an antenna or cable TV connection
- Where the TV has access to a power outlet

Note: Watching TV in total darkness or with a reflection on the screen may cause eye strain.

Connecting an HDMI device

Note: If your device has an HDMI connection, we recommend you use it to get the best picture and sound quality possible.

To connect an HDMI device:

- Connect one end of an HDMI cable (not included) to the HDMI 1, HDMI 2 jack on the back of your TV, then connect the other end of the cable to the HDMI OUT jack on the HDMI device.

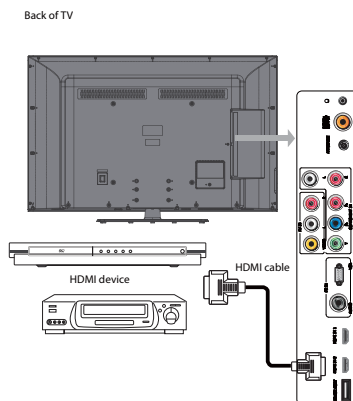

Note: To connect a DVI device, use a DVI to HDMI adapter cable to connect to the **HDMI** jack on the TV, then connect an audio cable to the **PC IN AUDIO** jack on the back of the TV.

To play from the HDMI device:

- 1 Turn on the TV, then press **INPUT**. The **INPUT SOURCE** menu opens.
- 2 Press **▲** or **▼** to select **HDMI1**, **HDMI2**, then press **ENTER**.
Note: You can also press **HDMI** once to select **HDMI1**, twice to select **HDMI2**.
- 3 Turn on the HDMI device, then set it to the correct mode. Refer to the instructions that came with the HDMI device.

Connecting a component video device

Component cables often have red, green, and blue color-coded video connectors and red and white audio connectors. Match the colors when making connections.

To connect a component video device:

- 1 Connect a component video cable to the **COMPONENT OUT** jacks on the component video device.

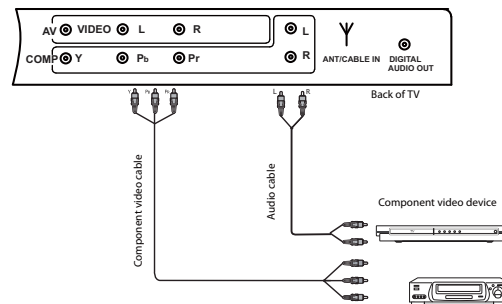

- 2 Connect the other end of the component video cable to the **COMPONENT IN** jacks on the side of your TV.
- 3 Connect an audio cable to the **AUDIO OUT** jacks (L/R) on the component device.
- 4 Connect the other end of the audio cable to the **COMPONENT AUDIO-R** and **AUDIO-L** jacks on the back of your TV.

To play from the component video device:

- 1 Turn on the TV, then press **INPUT**. The **INPUT SOURCE** menu opens.
- 2 Press **▲** or **▼** to select **Component**, then press **ENTER**.
Note: You can also press **COMP** once to select **Component**.
- 3 Turn on the component video device and start playback. Refer to the instructions that came with the component video device.

Connecting an antenna, cable TV, or satellite TV box

If you are connecting a satellite TV or cable box, you can use one of the following (if available):

- Best - HDMI cable
- Better - Video component cables
- Good - Video composite cable
- Acceptable - 75-ohm coaxial cable.

To connect an antenna, cable TV, or satellite TV box:

- Connect one end of a 75-Ohm, coaxial cable to the **ANT/CABLE IN** jack on the back of the TV, then connect the other end of the cable to the antenna or cable TV wall jack.

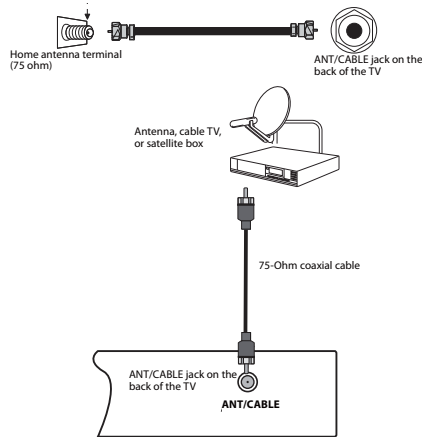

Notes:

- We recommend using a 75-Ohm, coaxial cable to reduce interference and noise that may be caused by radio wave transmissions.
- Do not bundle the coaxial cable with the power cord or any other cables.
- If you are using an antenna and reception is not good, contact a service technician to adjust the antenna.

Connecting a VCR, camcorder, or game console

Note: If the VCR, camcorder, or game console has component jacks (better), or an HDMI jack (best), connect them using the best available connection.

To connect a VCR, camcorder, or game console:

- 1 Make sure that your TV's power cord is unplugged and the VCR, camcorder, or game console is turned off.

- 2 Connect one end of a standard AV cable into the **AV IN VIDEO** jack on the back of the TV, then connect the other end of the cable to the **AV OUT VIDEO** jack on the external device.

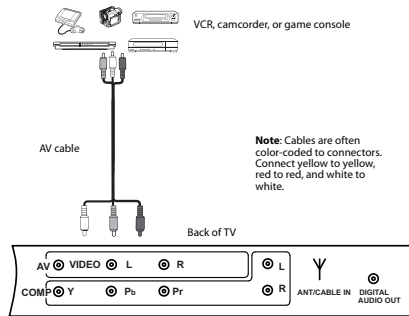

- 3 Connect the audio connectors of the AV cable (the red and white connectors) to the **AV OUT AUDIO** jacks of the external device, then connect them to the **AV IN L** and **R** jacks on the back of your TV.

To play the external AV device:

- 1 Turn on the TV, then press **INPUT**. The **INPUT SOURCE** menu opens.
- 2 Press **▲** or **▼** to select **AV** then press **ENTER**.
Note: You can also press **AV** once to select **AV**.
- 3 Turn on the device, then start playback on the device.

Connecting a computer

To connect a computer:

- 1 Make sure that your TV's power cord is unplugged and the computer is turned off.
- 2 Connect one end of a VGA cable (not included) to the **VGA** jack on the back of the TV, then connect the other end of the cable to the **VGA** jack on the computer.

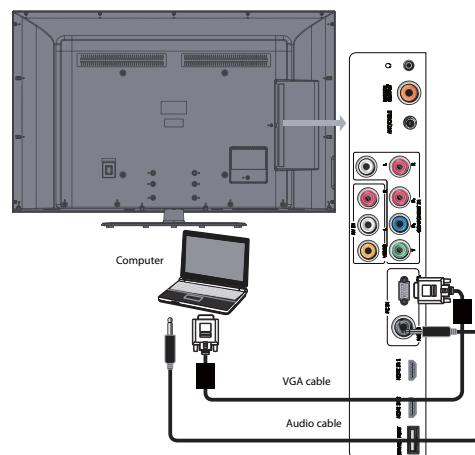

Note: The VGA cable will not be supplied with product. We strongly recommend to use VGA cable with 2 cores as shown in the figure.

- 3 Connect one end of an audio cable with a stereo mini-plug (not included) to the **PC/DVI AUDIO IN** jack on the back of the TV, then connect the other end of the cable to the **AUDIO OUT** jack on the computer.

To play video from the computer:

- 1 Turn on the TV, then press **INPUT**. The **INPUT SOURCE** menu opens.
- 2 Press **▲** or **▼** to select **VGA**, then press **ENTER**.
- 3 Turn on the computer, then adjust the computer display properties as needed.

Connecting a home theater system

Connecting using a digital audio cable

To connect using a digital optical cable:

- 1 Make sure that your TV's power cord is unplugged and the home theater system is turned off.
- 2 Connect one end of a digital coaxial audio cable (not included) to the **DIGITAL AUDIO OUT** jack on the back of the TV.

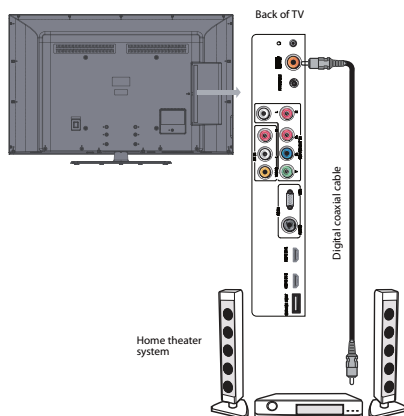

- 3 Connect the other end of the audio cable to the digital coaxial input jack on the home theater system.

Note: The **DIGITAL OUTPUT** jack only works with digital TV channels or when using an HDMI device

To play TV sound through a home theater system:

- 1 Turn on the TV and select a program to watch.
- 2 Turn on the home theater system and select the TV sound source, then adjust the volume to a comfortable level.

Connecting headphones

Warning: When using headphones, adjust the headphone volume to avoid excessively loud volume which can damage your hearing.

To connect headphones:

- Plug the headphones (not included) into the  (headphone) jack on the back of the TV.

Note: The TV sound automatically mutes when headphones are connected.

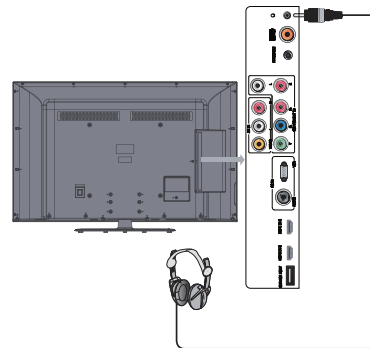

Turning on your TV for the first time

To configure your TV:

- 1 Make sure that you have inserted the batteries in the remote control, connected your devices to the TV, and connected the AC power.
- 2 Press **⏻** (Power), then wait several seconds. The *Initial Setup* screen opens (only the first time you turn on your TV). Follow the prompts to complete the setup.

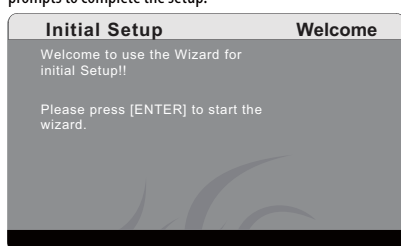

- 3 Press **ENTER** to start the wizard, the *language select* screen opens.

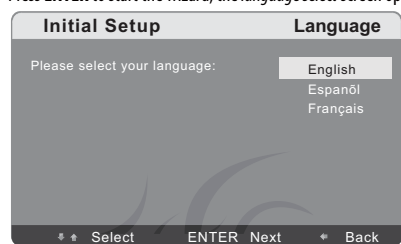

- 4 Press **▲** or **▼** to select the menu language you want, then press **ENTER**. The *Tuner Mode* screen opens.

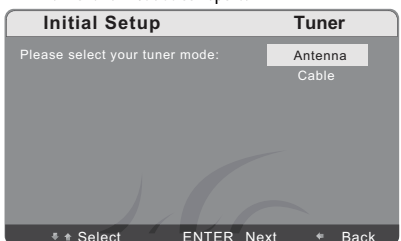

- 5 Press **▲** or **▼** to highlight **Antenna** or **Cable** depending on the type of connection you have, then press **ENTER**. The *Channel Scan* screen opens.

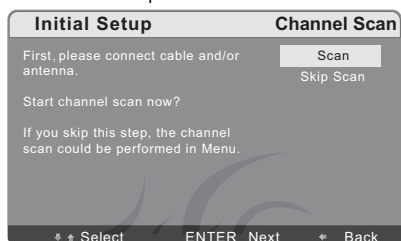

- 6 Press **▲** or **▼** to select **Scan**, then press **ENTER**. The channel scan begins.



Your TV automatically scans for available channels in your area and stores the channel information in the channel list. This may take several minutes. While scanning, the TV displays a progress report.

Notes:

- Channel scan is not necessary if you are using a satellite or cable box.
- Channel scan can take up to 30+ minutes.
- You can press **EXIT** at any time to stop the auto scan, but you will need to run the auto scan again to create a channel list.

Understanding the basics

Turning your TV on or off

To turn your TV on or off (standby mode):

- 1 Plug the power cord into an AC power outlet.
- 2 Press **⏻** (power). Your TV turns on.
- 3 Press **⏻** again to turn off your TV. When you turn off your TV, it goes into standby mode.

Warning: When your TV is in standby mode, it is still receiving power. To completely disconnect power, unplug the power cord.

Note: If your TV does not receive an input signal for several minutes, it automatically goes into standby mode.

Selecting the video input source

To select the video input source:

- 1 Turn on your TV, then press **INPUT** on the remote control or on the TV. The *INPUT SOURCE* menu opens.
- 2 Press **▲** or **▼** to highlight the video source you want, then press **ENTER**. Options include **TV**, **AV**, **Component**, **VGA** (computer), **HDMI1** or **HDMI2**.

Selecting a channel

Tip: If you are using a cable or satellite box, use the remote control that came with that device to change channels.

To select a channel:

- Press **CH ▲** / **CH ▼** to go to the next or previous channel.
- Press the number buttons to enter the channel number you want, then wait for the channel to change, or press **ENTER** to change the channel immediately.

- To select a digital channel, press the number buttons to select the main digital channel, then press the dot (.) button, then the number buttons again to select the sub-channel. Wait for the channel to change or press **ENTER** to change the channel.

Note: Button presses must be within three seconds of each other.

- Press **LAST** to go to the last channel viewed.

Adjusting the volume

To adjust the volume:

- Press **VOL** \wedge / **VOL** \vee to increase or decrease the volume.
- Press **MUTE** to temporarily turn off all sound. Press **MUTE** again to restore the sound.

Displaying program information

To display program information:

- Press **DISPLAY** to show an information banner. The information banner shows current program information such as channel number, video input source, and resolution.
- Digital signal information**—Displays channel number, station name, channel label (if preset), broadcast program name, TV rating, signal type, audio information, resolution, CC mode, current time, and current program start and end times when watching a digital channel.
- Analog signal information**—Displays channel number, channel label (if preset), signal type, audio information, and resolution when watching an analog channel.
- Press **GUIDE** to show the digital program guide, which may show a list of available programs, program times, and program summaries, depending on the information provided by the broadcaster.

Navigating the menus

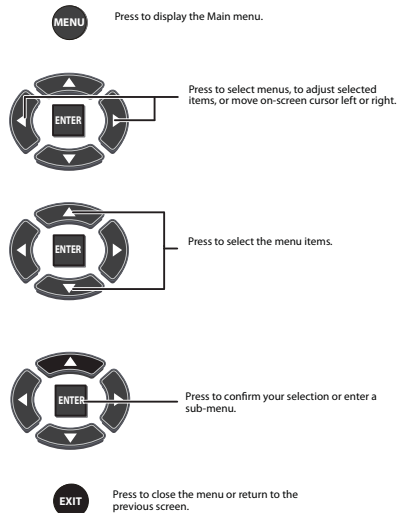

On-screen menu overview

Use the on-screen menu to configure the various operational settings of your TV. To access the menu, press **MENU**. The menus and their corresponding functions are described in the following table:

Video	Picture Mode	Lets you enable one of six preset viewing options optimized for different viewing conditions.
	Brightness	Lets you adjust the level of brightness on the screen. Increasing brightness can add more light to dark areas of the picture.
	Contrast	Lets you adjust the level of picture contrast. Increasing the contrast adds more light to the white areas of the picture.
	Saturation	Lets you adjust the level of color intensity.
	HUE	Lets you adjust the overall color of the picture (only supported in TV/AV mode).
	Sharpness	Lets you adjust the focus of the picture. Increase sharpness for a clearer picture, or decrease sharpness for a smoother picture.
	Color Temperature	Lets you select one of three preset color temperature settings: Cool , Standard , or Warm .
Audio	Advanced Video	Accesses advanced video settings such as DNR, Adaptive Luma Control, Flesh Tone.
	Balance	Lets you adjust the balance between the left and right speakers.
	Surround Sound	Lets you turn the surround sound effect on or off.
	Equalizer	Lets you select the audio frequency you want to adjust and change its value.
	SPDIF Type	Lets you select the preferred audio format for SPDIF audio signals. SPDIF is only available on digital channels or when using an HDMI device. Choose from PCM , Dolby digital , or Off .
Setup	Auto Volume Control	Lets you select whether to apply the audio settings for all input sources, as well as for both analog and digital TV channels (OFF), or only to the current one (ON).
	OSD Language	Lets you select the language for the on-screen display. Choose from English , French , or Spanish .
	OSD Timeout	Lets you set the OSD timeout. You can select the time from 5 sec to 60 sec, and the step is 5 sec.
	Screen Mode	Lets you select the aspect ratio of the screen. Choose from Normal , Wide , Cinema or Zoom .
	DPMS	Use this setting when using your TV with a computer. When using a connected computer, lets the computer control if the screen is on or off.
	Time Setup	Lets you configure the system clock and time zone settings. You can also choose to enable the Date/Time features and set up the sleep timer.
	Caption	Lets you configure the settings for closed captioning (CC, also known as subtitles) in TV programs.
	Reset Default	Lets you reset all operational settings to their default factory value. Do this only if any of the following conditions occurs: <ul style="list-style-type: none"> The system fails to respond to the remote control (make sure the remote control batteries are still working and that you are within the transmission range). The new configuration settings cause unexpected results. You forget the system PIN.

Parental	Channel Block	Lets you select certain channels to be blocked.
	Program Block	Lets you select certain programs to be blocked.
	Input Block	Lets you select certain input sources to be blocked.
	Change Password	Lets you set a new password for parental controls.
	Clean All	Eliminates all channels (and presets) stored in the TV.
TV	Tuner Mode	Lets you select the signal source for your TV (Antenna or Cable).
	Channel Scan	Lets you initiate an automatic channel scan to set up the available channels in your TV.
	Channel Skip	Lets you select certain channels to eliminate from the available channels list.
	MTS	Lets you enable the SAP (Second Audio Program) function. This lets you listen to a program using an alternative second language. Function availability depends on your TV provider.
	Audio Language	Lets you select the language track you prefer for viewing digital TV programs. Available options depend on your digital TV provider.

Note: Menu items that are not selectable are grayed out. Menus in this manual are described in TV mode, unless otherwise indicated.

Adjusting the picture

To adjust the picture:

- 1 Press **MENU**. The *Main* menu opens.
- 2 Press **ENTER** or **▶**. The *Video* menu opens.



- 3 Press **▲** or **▼** to highlight an option, then press **◀** or **▶** to adjust the option. You can select:
 - **Picture Mode**—Selects the picture mode. You can select:
 - **Vivid** (a bright and vivid picture)
 - **Standard** (a standard picture)
 - **Cinema** (a finely detailed picture)
 - **User** (customized picture).

*Note: You can also press **PICTURE** on the remote control to select the picture mode.*

- **Brightness**—Lets you increase or decrease the brightness of the picture. Increasing the brightness can add more light to dark areas of the picture, while decreasing the brightness can add more darkness to light areas of the picture.
- **Contrast**—Lets you increase or decrease the contrast of the picture. Increase the contrast to adjust the white areas of the picture or decrease the contrast to adjust the black areas of the picture.
- **Saturation**—Lets you adjust the intensity of the colors.
- **HUE**—Lets you adjust the overall color of the picture (only supported in TV/AV mode).
- **Sharpness**—Lets you increase the sharpness level for clearer images or decrease the sharpness level for smoother images.
- **Color Temperature**—Lets you change the color temperature. You can select the color temperature from three options: **Cool**, **Standard**, or **Warm**.
- **Advanced Video**—Lets you access and adjust advanced video settings, such as DNR, Adaptive Luma Control, Flesh Tone.

- 4 Press **MENU** to return to the previous menu, or press **EXIT** to close the menu.

Choosing the display format (aspect ratio)

To choose the display format:

- Press **ASPECT** on the remote control repeatedly to cycle through the available display formats. Options include:
 - **Normal**—Selects the correct aspect ratio to match the source image.
 - **Zoom**—Enlarges the picture but may crop the top and bottom.
 - **Wide**—Shows a full-screen picture.
 - **Cinema**—Stretches the picture at the edges [21:9 aspect], but maintains a good aspect ratio at the center of the screen.

Adjusting the sound

To adjust the sound:

- 1 Press **MENU**. The *Main* menu opens.
- 2 Press **◀** or **▶** to highlight **Audio**, then press **ENTER** or **▶**. The *Audio* menu opens.



- 3 Press **▲** or **▼** to highlight an option, then press **◀** or **▶** to adjust the option. You can select:
 - **Balance**—Adjusts the balance between the left and right audio channels.
 - **Surround Sound**—Turns the surround sound effect on or off.
 - **Equalizer**—Lets you select the frequency you want to adjust and change its value.
 - **SPDIF Type**—Lets you select the preferred audio format for SPDIF audio signals. SPDIF is only available on digital channels or when using an HDMI device. Choose from **PCM**, **Dolby Digital**, or **Off**.

Note: By selecting **SPDIF Type**, you can choose the digital audio output type.

- **Auto Volume Control**—Lets you turn automatic volume control on or off. When this option is turned on, it keeps the audio in a preset range to eliminate large spikes in volume.
- 4 Press **MENU** to return to the previous menu, or press **EXIT** to close the menu.

Selecting the audio mode

To select the audio mode:

- Press **SOUND** on the remote control one or more times to cycle through the available sound modes. Options include **Standard**, **Speech**, **User**, and **Music**.

Changing channel settings

To change the channel settings:

- 1 Press **MENU**. The *Main* menu opens.
- 2 Press **◀** or **▶** to highlight **TV**, then press **ENTER** or **▶**. The *TV* menu opens.



- 3 Press **▲** or **▼** to highlight an option, then press **◀** or **▶** to adjust the option. You can select:
 - **Tuner Mode**—Lets you select **Antenna** or **Cable**.
 - **Channel Scan**—Lets you scan for channels that have signals and stores the channels information in memory. When you press **CH ▲** or **CH ▼**, your TV skips any channels that do not have a signal.
 - **Channel Skip**—Lets you delete a channel stored in memory. When you press **CH ▲** or **CH ▼**, your TV skips the channel you deleted. You can still tune to the channel using the number buttons on the remote control.
 - **MTS**—Lets you select the sound mode. You can select **Mono**, **Stereo**, or **SAP** (second audio program).
 - **Audio Language**—Lets you select the audio language for a program (if other languages are available).
- 4 Press **MENU** to return to the previous menu, or press **EXIT** to close the menu.

Setting parental controls

Parental controls let you prevent your children from watching inappropriate material on TV. When set, parental controls read the rating of the program (with some exceptions, such as news and sports) and deny access to programs that exceed the ratings level you select. To watch programs that exceed the selected rating, you must enter a password.

To set parental controls:

- 1 Press **MENU**. The *Main* menu opens.
- 2 Press **◀** or **▶** to highlight **Parental**, then press **ENTER** or **▶**. The *Parental* menu opens.



- 3 Press the number buttons to enter the four-digit password. The default password is **0000**. You should change the password to a number you can remember. The *Parental Controls* menu opens.
- 4 Press **▲** or **▼** to highlight an option, then press **◀** or **▶** to adjust the option. You can select:
 - **Change Password**—Lets you change the password. The first time you use this function, use the default password (0000). If you want to change it, first enter the new password then enter the same password again.
 - **Channel Block**—Lets you block any channel you select.
 - **Input Block**—Lets you block the input source with this function. For example, if you want to block AV input, highlight **AV**, then press **ENTER**. The AV input will be blocked.
 - **Program Block**—
 - **A**—Rating Enable is on.
 - **B**—U.S. TV Ratings: You can choose TV ratings according to the illustration on the screen.
 - **C**—The settings for U.S. Movie Ratings, Canada (English) Ratings, and Canada (French) Ratings follow Step B. If you want to block an unrated program, turn on this function. You can select all the ratings listed in the charts below.

*Note: On the MPAA RATING screen, press **▲** or **▼** to select the rating. That rating and all other higher ratings are blocked.*

U.S. TV ratings (age-based)	
These ratings are determined by the Federal Communications Commission (FCC).	
TV-Y	All children.
TV-Y7	Suitable for children 7 and older.
TV-G	General audiences.
TV-PG	Parental guidance suggested.
TV-14	Parental guidance strongly suggested.
TV-MA	Mature audiences only.

U. S. TV ratings (content-based)	
FV	Fantasy violence.
V	Violence.
S	Sexual situations.
L	Strong language.
D	Suggestive dialog.

U.S. movie (MPAA) ratings	
These ratings are determined by the Motion Picture Association of America (MPAA).	
G	General audiences.
PG	Parental guidance suggested.
PG-13	Suitable for children 13 and older.
R	Parental guidance suggested for children under 17.
NC-17	Not suitable for children under 17.
X	Adults only.

Canadian English ratings

These ratings are based on the Canadian Home Video Rating System, determined by the Canadian Motion Picture Distributors Association (CMPDA).

C	Suitable for all children.
C8+	Suitable for children 8 and older.
G	General audiences.
PG	Parental guidance suggested.
14+	Suitable for children 14 and older.
18+	Adults only.

Canadian French ratings

These ratings are based on the classification categories determined by La Règle du cinéma du Québec.

G	General audiences.
8 ans+	Suitable for children 8 and older.
13 ans+	Suitable for children 13 and older.
16 ans+	Suitable for children 16 and older.
18 ans+	Adults only.

- 5 Press **EXIT** to close the menu.

Adjusting TV settings

To adjust the setup:

- 1 Press **MENU**. The *Main* menu opens.
- 2 Press **◀** or **▶** to highlight **Setup**, then press **ENTER** or **▶**. The *Setup* menu opens.



- 3 Press **▲** or **▼** to highlight an option, then press **◀** or **▶** to adjust the option. You can select:
 - **OSD Language**—Press the right or left arrow buttons to choose the OSD Language. Choices include **English**, **Spanish**, and **French**.
 - **OSD Timeout**—Lets you set the OSD timeout. You can select the time from 5 sec to 60 sec, and the step is 5 sec.
 - **Screen Mode**—Press the arrow buttons to choose the screen aspect ratio. Choices include **Normal**, **Wide**, or **Cinema to Zoom**. You can also press the **Aspect** button on your remote control.
 - **DPMS**—Use this setting with a computer. When DPMS is on, the computer controls whether the screen is on or off. For example, if the computer is in sleep mode, the screen is switched off. If the computer is activated, the screen also is activated.
 - **Time Setup**—Lets you set the exact time. You can also set up **Sleep Timer** and **Auto Sleep Time**.

- **Caption**—Lets you set up closed captions. Choose from **Analog Closed Caption**, **Digital Closed Caption**, and **Digital Caption Style**.
 - **Analog Closed Caption**—**CC1**, **CC2**, **CC3**, **CC4**, **TEXT1**, **TEXT2**, **TEXT3**, and **TEXT4**.
 - **Digital Closed Caption**—**Service1**, **Service2**, **Service3**, **Service4**, **Service5**, and **Service6**.
 - **Digital Caption Style**—There are two digital caption styles. One is the automatic function set by the broadcaster, and the other is the custom style where you can adjust the font size, color, opacity, background color, and so on.
 - **Reset Default**—Resets the TV to its original factory settings.
- 4 Press **MENU** to return to the previous menu, or press **EXIT** to close the menu.

Troubleshooting

Before calling for service, check the following information for possible solutions to problems you may experience. If none of these solutions work, turn off the TV, then turn it on again.

Caution: Do not try to repair the TV yourself. Refer all servicing to qualified repair personnel.

Video and audio

Problem	Solution
No picture (screen is not lit) and no sound.	<ul style="list-style-type: none"> • Make sure that the power cord is plugged in. • Press POWER  on the TV or the remote control. • Make sure that the correct video input source is selected. For more information, see "Selecting the video input source" on page 11. • Try another channel. The station may be experiencing problems.
Dark, poor, or no picture (screen is lit), but sound is good.	<ul style="list-style-type: none"> • Adjust the brightness. For more information, see "To adjust the picture:" on page 13. • Make sure that the correct picture mode is selected. For more information, see "To adjust the picture:" on page 13. • Make sure that the antenna or cable TV is connected correctly and securely. For more information, see "Connecting an antenna, cable TV, or satellite TV box" on page 9.
No color, dark picture, or color is not correct.	<ul style="list-style-type: none"> • Adjust the color saturation. For more information, see "Adjusting the picture" on page 13.
Only snow (noise) appears on the screen.	<ul style="list-style-type: none"> • Try another channel. The station may be experiencing problems. • Make sure that the antenna or cable TV is connected correctly and securely. For more information, see "Connecting an antenna, cable TV, or satellite TV box" on page 9.
Dotted lines or stripes appear on the screen.	<ul style="list-style-type: none"> • Adjust the antenna. • Move the TV away from noise sources such as cars, neon signs, or hair dryers.

Problem	Solution
Double images.	<ul style="list-style-type: none"> • Try using a highly directional outdoor antenna or cable TV.
The picture has a few bright or dark spots.	<ul style="list-style-type: none"> • A few bright or dark spots on an LCD screen is normal. It does not affect the operation of this TV.
Good picture, but no sound.	<ul style="list-style-type: none"> • Make sure that the sound is not muted. • Make sure that the sound mode is set to Stereo or Mono. For more information, see "Selecting the audio mode" on page 14.
Audio noise.	<ul style="list-style-type: none"> • Make sure that there is no interference with infrared equipment such as a cordless telephone or headphones. Move the infrared equipment away from the TV to eliminate the noise.

Remote control

Problem	Solution
Remote control does not work.	<ul style="list-style-type: none"> • Make sure that the TV power cord is plugged in. • Make sure that there are no obstructions between the remote control and the remote control sensor on the front of the TV. • Make sure that the batteries are installed correctly. For more information, see "Installing remote control batteries" on page 6. • Replace the batteries. For more information, see "Installing remote control batteries" on page 6.

General

Problem	Solution
One or more channels do not display.	<ul style="list-style-type: none"> Make sure that the channels are not blocked. For more information, see "Setting parental controls" on page 14.
Password is lost.	<ul style="list-style-type: none"> Enter 0532 to access parental controls, then set a new password. For more information, see "Setting parental controls" on page 14.
Some settings cannot be accessed.	<ul style="list-style-type: none"> If a setting is grayed, the setting is not available in the current video input mode.
TV cabinet creaks.	<ul style="list-style-type: none"> When the TV is in use, the temperature rises naturally and may cause the cabinet to expand or contract which can cause a creaking noise. This is not a malfunction.
Control buttons on the TV do not work.	<ul style="list-style-type: none"> Disconnect the power cord, wait a few seconds, then reconnect the power cord and turn on the TV.

Note: If the problem is not solved by using these troubleshooting instructions, try turning off your TV, then turning it on again.

Maintenance

Just like with any other household appliance, the performance and life-expectancy of your TV depends on how well you maintain it. Follow the procedures described here to clean the TV case and the LCD screen.

Cautions:

- Make sure that the TV is turned off and the power cord is disconnected from the power outlet before cleaning the TV.
- Never spray or pour any liquid directly onto the screen or the case.

Cleaning

- Clean your TV with a soft, dry cloth. If surfaces are extremely dirty, use a soft cloth dampened with a small amount of non-ammonia, non-alcohol-based, non-abrasive detergent solution.
- Clean the screen with a clean, soft, lint-free cloth. If additional cleaning is necessary, apply a small amount of non-ammonia, non-alcohol-based, non-abrasive detergent solution to the cloth.

Specifications

Specifications subject to change without notice.
Weight and dimensions shown are approximate.

TV type	LCD
TV panel	46-inch FHD LCD
TV system	NTSC-M, ATSC
Receiving channels	VHF: 2 - 13 UHF: 14 - 69 CATV: 1 - 125 CADTV: 1-135 DTV: 2-69

Audio multiples	BTSC system
Audio out	8W x 2
Power requirement	AC 120 V, 60 Hz
Power consumption	215W
Dimensions (W x H x D with stand)	44.06 x 29.51 x 11.65 inches (1119 x 749.5 x 296mm)
Weight	46.30 lbs. (21 kg)
Input terminals	Composite video/L and R audio (1) Component video/L and R audio (1) HDMI (2) VGA and PC/DVI audio (1) ANT/Cable (1)
Output terminals	Digital Coaxial Audio (1) Headphone (1)
Control terminals	SERVICE PORT (1)

Legal notices

FCC Part 15

This device complies with Part 15 of the FCC Rules. Operation of this product is subject to the following two conditions: (1) this device may not cause harmful interference, and (2) this device must accept any interference received, including interference that may cause undesired operation.

This equipment has been tested and found to comply within the limits for a class B digital device, pursuant to Part 15 of the FCC Rules. These limits are designed to provide reasonable protection against harmful interference in a residential installation. This equipment generates, uses, and can radiate radio frequency energy and, if not installed and used in accordance with the instructions, may cause harmful interference to radio communications. However, there is no guarantee that interference will not occur in a particular installation. If this equipment does cause harmful interference to radio or television reception, which can be determined by turning the equipment off and on, the user is encouraged to try to correct the interference by one or more of the following measures:

- Reorient or relocate the receiving antenna.
- Increase the separation between the equipment and receiver.
- Connect the equipment into an outlet on a circuit different from that to which the receiver is connected.
- Consult the dealer or an experienced technician for help.

FCC warning

Changes or modifications not expressly approved by the party responsible for compliance with the FCC Rules could void the user's authority to operate this equipment.

Cables

Connections to this device must be made with shielded cables with metallic RF/EMI connector hoods to maintain compliance with FCC Rules and Regulations.



This product contains electrical or electronic materials. The presence of these materials may, if not disposed of properly, have potential adverse effects on the environment and human health. Presence of this label on the product means it should not be disposed of as unsorted waste and must be collected separately. As a consumer, you are responsible for ensuring that this product is disposed of properly.



Manufactured under license from Dolby Laboratories.
"Dolby" and the double-D symbol are trademarks of Dolby Laboratories.
Confidential unpublished works. © 1992 -1997 Dolby Laboratories, Inc. All rights reserved.



This TV incorporates High-Definition Multimedia Interface (HDMI™) technology.
HDMI, the HDMI logo and High-Definition Multimedia Interface are trademarks or registered trademarks of HDMI Licensing LLC.