

Hisense®

LCD TV

USER'S MANUAL

Before using the TV, Please read this manual thoroughly, retain it for future reference.

LCD42V68PCA

IES0

English

Contents

Specification	2
Important safety instructions	3
Important safety instructions and environment	5
Base Installation Instruction	6
View the control panel and connection panel	7
Connection to other devices	8
View the remote control	10
Brief operation of the remote control	11
Basic operation	13
Turning on/off	13
Changing channels/volume	13
Channel setting	14
Picture setting	15
Sound setting	16
Screen setting	17
Function setting	18
Trouble shooting	19
Accessories	19
Federal communications commission statement	20

Specification

Model Name		LCD42V68PCA
Dimension (W×H×D)(mm)	Without stand	1033 ×679×102
	With stand	1033×738×302
Weight(kg)	Without stand	18.3
	With stand	20
LCD Panel Minimum size (cm)		106
Screen resolution		1920×1080
Power consumption		refer to the rating lable
Power supply		AC 120V~60Hz
Receiving systems	RF	NTSC
	AV	NTSC
Environmental conditions		Temperature 5°C~ 35°C Humidity:20%-80% RH, Atmospheric pressure: 86kPa-106kPa
Component Input		480I、480P、 720P/60Hz、 1080I/60Hz 1080P/60Hz
VGA Input		VGA (640×480 60Hz) 、 SVGA (800×600 60Hz) XGA (1024×768 60Hz) 、 SXGA(1280×1024 60Hz)
HDMI Input		RGB/60Hz (640×480、800×600、1024×768) YUV/60Hz (480I、480P、720P、1080I、1080P)

Important safety instructions

➤ Important safety instructions

Attentions

- ⚠ The lightning flash symbol with an arrowhead inside a triangle alerts the user about an uninsulated dangerous voltage that may be of sufficient magnitude to constitute a risk of electric shock.
- ⚠ The flash with the symbol of exclamation inside a triangle alerts the user to the important instruction related to the product.
- ◆ General instruction.

Alerts: Before using the product, please read the following clauses carefully.

Power and signal

- ⚠ Unplug the power plug and antenna cable before lightning storms to avoid any possible damage to TV. Please do not touch the inducting wire of the antenna.
- ⚠ If you do not use the product for a long time, please pull out the power plug.
- ◆ Please do not press the power line and signal line with foreign objects.
- ◆ Please do not overload the power outlet, this could lead to a fire hazard.
- ◆ Keep the power line away from high temperature.
- ◆ If the outdoor antenna is outside for an extended period of time, the picture quality of the TV may be affected, so please check and replace the antenna regularly.

LCD display instruction and maintenance

- ⚠ LCD display panel is a highly technical product, composed of millions of transistors. There can be dark or bright spots appearing on the panel. Please note that this is a normal phenomenon, which does not affect the overall performance. Incorrect maintenance will lead to damage to the LCD screen, which will affect the image. Please pay attention to the following items:
- ⚠ Please do not clean the screen with solvents, such as alcohol, gasoline, etc. or chemical reagents, such as acid, alkali, etc.
- ⚠ Please do not clean the screen with any kind of detergent.
- ⚠ After the TV is turned off, you can clean the screen with a clean and soft cotton cloth to properly safeguard it, but repeated cleaning with force is prohibited.
- ⚠ Directly touching the screen with your fingers may damage the screen's surface. Please do not put pressure on the LCD as it is delicate and more vulnerable than glass CRT.
- ◆ Please do not touch the LCD screen with a hard object. The screen is easily scratched.

Product

- ◆ Servicing: Do not attempt to service this TV yourself as opening or removing covers may expose you to dangerous voltage or other hazards. Refer all servicing to qualified service personnel. Opening TV will void your product warranty.
- ◆ If there is an abnormal sound or smell, or there is sound but no image, please turn off the TV and pull out the plug immediately and contact our professional technicians.
- ⚠ Please do not remove the back cover. Maintenance should only be carried out by the professional technicians.
- ◆ Please do not cover or block the ventilation holes. These holes are used to allow internal heat build-up to escape and prevent over-heating.

Important safety instructions

➤ Important safety instructions

- ◆ Never push objects of any kind into this TV through openings as they may touch dangerous voltage points or short out parts that could result in fire or electric shock. Never spill liquid of any kind into the TV.

Maintenance

- ◆ Do not clean this unit with volatile oils or diluent, which may cause cabinet deterioration or damage its surface coating.
- ◆ If the cabinet becomes dirty, please clean it with a damp soft cloth which has a neutral detergent
- ◆ In cases where the TV cabinet/stand has been painted or treated with a chemical solvent, the possibility of a chemical action may occur between the rubber and cushion of TV base and TV cabinet. users are advised to put a layer of protective material (such as pressboard or glass sheet, etc.) on the TV cabinet and then place the TV set.

Method of placement

- ✓ Even and steady surfaces
- × Places under direct sunlight or close to heating devices
- × Places with poor ventilation
- × Places close to furnace or places to which water, oil or smoke
- × Places with poor ventilation
- × Unsteady places
- × Places with excessive vibration
- × Places with excessive dust and moisture
- × Places with high temperatures

Watching TV

- ◆ Watch TV at a proper distance, and the best distance is 5 to 7 times the length of the vertical height of the LCD.
- ◆ Keep the lighting indoors bright enough to read newspaper.
- ◆ The volume should be properly set in at a reasonable level if you do not have sound proof walls.

Others

- ◆ It is recommended that 2 or more people should load, unload and carry the unit; try to avoid a collision when carrying the unit, and protect the LCD screen in particular.
- ◆ If you touch the LCD screen when turning on or off the TV, you may feel the slight electric shock, which is the so-called electrostatic and does no harm to your health.

Pay special attention to the following items

- ◆ The information contained in this manual is subject to change without notice.
- ◆ All the other product names mentioned in this manual are the logos or trademarks of their respective owners.

Caution

Plastic bags can be dangerous. To avoid danger of suffocation, keep this bag away from babies and children.

Important safety instructions and Environment

➤ Environment

- ◆ The symbol of the **barred** dustbin means that this apparatus cannot be disposed of with other current domestic waste. Some components may be harmful to the environment.
- ◆ Do not dispose of with regular waste or deposit it in any public or private domain not licensed for proper electronic disposal. Contact your local environmental waste department for correct recycling methods.
- ◆ The selective collection of waste electronics makes it possible to reduce the number of dangerous substances which are not recycled and thus contribute to the safe guarding of the environment.



ROHS (Reduction of Hazardous Substance) European Directive 2002/95/EC

- ◆ This European directive limits the use of dangerous and hazardous substances which are not recyclable or those of which recycling is difficult.
- ◆ This allows recycling easily the EEE (European electrical and electronic equipment) and contributes to the safeguard of the environment.
- ◆ Substances included in this product match to the RoHS directive.

Battery

- ◆ Do not throw away batteries with common domestic waste. Throw Batteries in a collecting zone indicated. Do dispose off batteries in fire.
- ◆ Do not mix different kinds of batteries. Do not combine the worn batteries with the new ones.
- ◆ Immediately remove the over-heated battery to prevent the acid from leaking into the battery compartment.
- ◆ If you do not intend to use the remote control for a long period of time, remove the batteries.

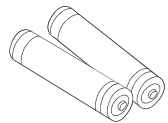

Base installation instruction

Base Installation Instruction

1. Lay a cloth or other soft material on a flat table to avoid damage to the LCD screen.
2. Put the TV back upward and the LCD screen downward and keep it flat on the surface.
3. Take out the base and insert it into the installing slot in the lower part of the TV until all of the holes match each other.
4. Fasten the base and the TV set together with the 4 screws provided.
5. Erect the TV set, and put it on the proper position for watching.

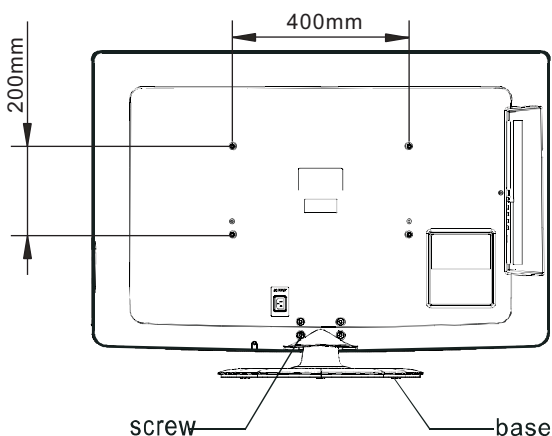

Note:

The above figures are for reference only, please refer to the actual units to determine the appearances. Every hole of the base must be fastened with screws!

View the control panel and connection panel

Note: The appearance is different from each model, please refer to the actual units.

TV Front

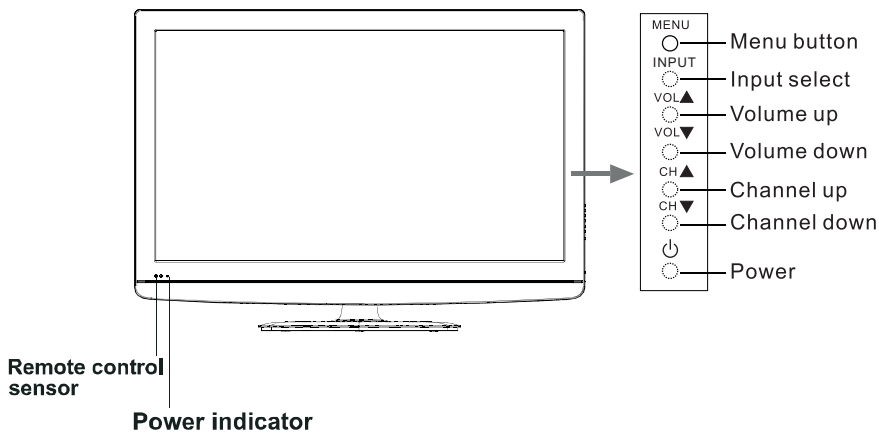

TV Rear

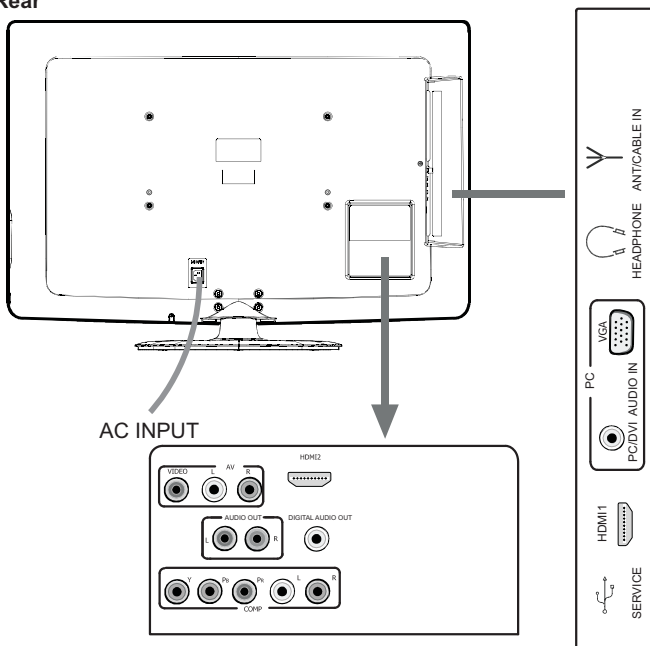

Connections to other devices

Warning: Before connecting the TV to any other electronic device, unplug the TV and electronic device AC cords from the AC input.

Connecting the broadcast antenna or the cable TV

To have an optimal picture quality, it is strongly recommended to have an external antenna or a cable TV.

Note:

- When using the outdoor antenna, please unplug the cord of the indoor antenna (if any) from the antenna terminal outlet. It is recommended that coaxial cable (75Ω) be used to eliminate the interference caused by the mismatched impedance.
- The antenna cable should not be bound together with the power cord.
- When using the cable TV, please insert the plug of the coaxial cable (75Ω) directly into the antenna outlet.

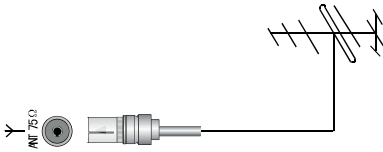

How to connect the AV devices

The multimedia function of this unit makes it possible for the unit to be connected to more external devices. The above figures about how to connect the unit with other AV devices. After having been connected with various external devices, select the desired Source with the remote control to enjoy the wonderful display.

Video in(composite video) transmits video as a single signal.

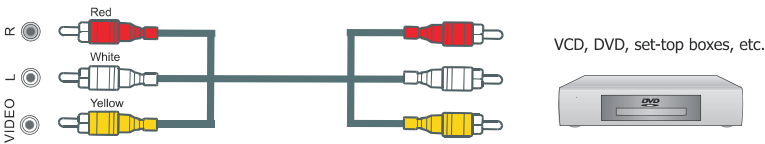

S-video transmits video in separate color and black-and-white image signals and delivers a sharper image than a composite video connection.

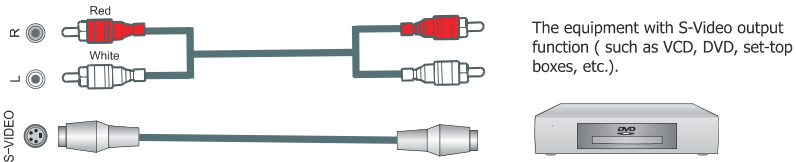

Connections to other devices

Component video(Y, Pb, Pr)transmits video as separate red, green and blue signals. Use this connection for high-definition video signals from a DVD or other equipment.

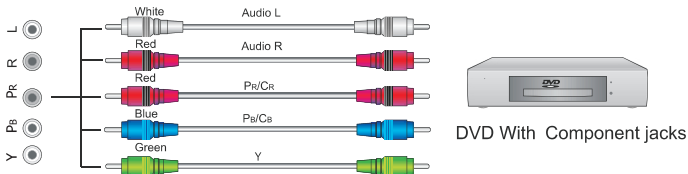

Connecting the devices with HDMI interface

HDMI, which is also called "High Definition Multimedia Interface", is a newer generation interface that transmits digital AV signals via a single cable without compression. The difference between HDMI and DVI lies in that HDMI is equipped with HDCP(High-Bandwidth Digital Content Protection) encoding function with a comparatively smaller size, and supports multi-sound track digital audio at the same time.

The HDMI interface can be connected to the equipment with HDMI output function (such as DVD players, set-top boxes, etc.).

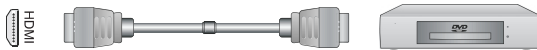

The equipment with HDMI output jack
(such as DVD players, set-top boxes, etc.).

The connection with PC

Thanks to the PC standard RGB interface with D-sub 15 pins, it is very easy for it to be connected with the PC. What you need to do is to insert the PC display card 15 pin output signal cord into the corresponding interface at the back of this unit. For audio using the TV, plug a 3.5 mm stereo cable from PC/DVI AUDIO IN.

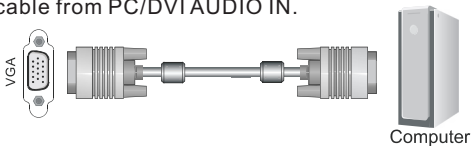

The D-Sub cable will not supplied with the product.
We strongly recommend to use D-Sub cable with 2 cores as shown in the figure.

View the remote control

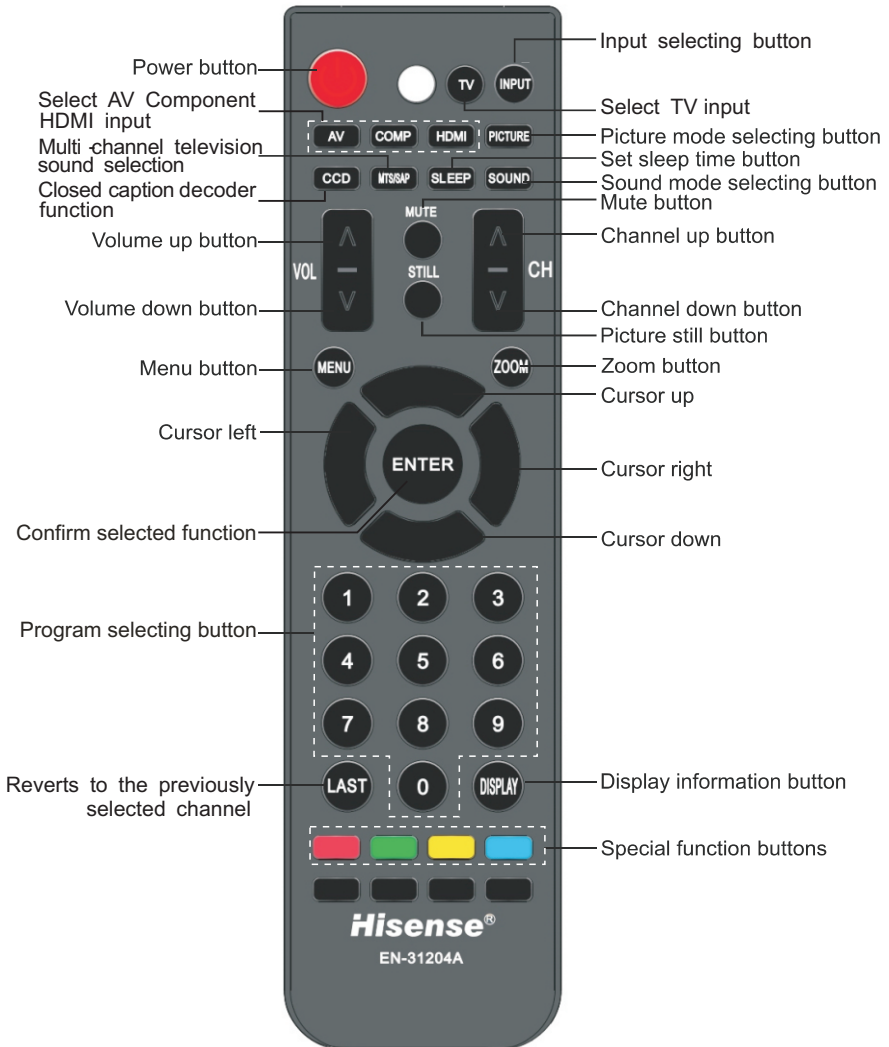

Brief operation of the remote control

Change the batteries

1. Open the battery cover on the back of the remote control.
2. Install two AAA size (1.5V) batteries. Match the "+" and "-" signs on the batteries to the signs on the battery compartment.
3. Close the battery cover.

Note:

1. If the remote control doesn't work normally, unstable, or cannot control the TV, please replace the batteries.
2. If you do not use the remote control for a long time, remove the batteries.

The effective range of remote control

1. The remote control distance: 8 meters in front of the TV set.
2. The remote control angle: taking the television infrared light receiver window as an apex, 6 meters away, its controlled angle (left to right) is within 30 degrees, while the vertical angle (up to down) is within 30 degrees.

Quick function operation of the remote control

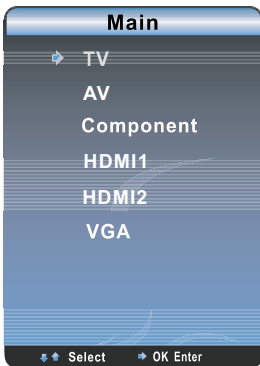

1. **Input:** Choose the current input signal of the main picture. First press this button to display the signal inputs: TV, AV, Component, HDMI1, HDMI2, VGA. Press ▲/▼ button to select the source you wanted to enter, then press ►/ENTER button to confirm.
2. **Picture:** It can be set as Standard, Bright, soft and User. This mode achieves a certain image display effect by setting the brightness, contrast and color etc.
3. **Sound :** It can be set as Music, Standard, Speech and User. This mode achieves a special sound effect by setting equalizer.
4. **Still:** Press this button the moving picture becomes a still one.
5. **Mute:** Press Mute button to turn the sound off, press this button again to turn the sound back on. This function is used to switch off sound temporarily.

Picture Mode

Mode	Picture feature
Standard	Normal picture
Bright	Bright and fresh picture
Soft	Mild picture
User	The picture feature you set

Sound Mode

Mode	Sound feature
Music	Various music mode
Standard	Standard music
Speech	Enhance the dialogue effect
User	The sound feature you set

Brief operation of the remote control

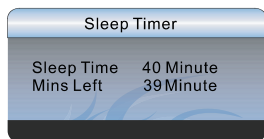

6. **Sleep:** Press this button repeatedly to select the proper sleeping clock mode, and the clock tells you the remaining time before the TV enters Standby mode. The clock mode is as follows: Off-10minutes-20minutes-30minutes...120minutes.

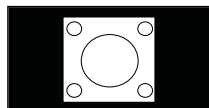

1:1

7. **Zoom:** For the various Sources, this unit has various display modes. Press Zoom button to select the proper display mode, including "1:1", "4:3", "Full Screen", "Zoom 1", "Zoom 2", "Panorama".

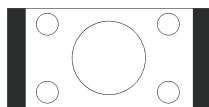

4:3

- ◇ **1:1** :Use the function to see the full image when AV and TV.
- ◇ **4:3**: Shows the standard 4:3 ratio picture image in the center of the TV with dark bars on the left and right.

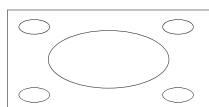

Full Screen

- ◇ **Full Screen**: This mode displays the picture of input source expanded to fill the screen.

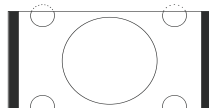

Zoom 1

- ◇ **Zoom1**: Proportionally stretches the TV picture, but clips the top and bottom of the image to fit the screen. Eliminates black bars.

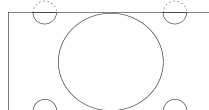

Zoom 2

- ◇ **Zoom2**: Zooms further into the middle of the screen and clips off more from the top and bottom.

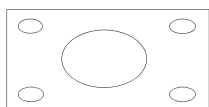

Panorama

- ◇ **Panorama**: Similar to Full Screen mode, but shows more of the sides.

Note: The option of zoom mode is different in different sources.

Basic operation

Turning on/off

1. Connect the TV power line to AC outlet.
2. Press the Power button on the TV set. When the TV is on, press the Power button on the remote control, and the TV will enter Standby mode. LED light is red. Press this button again, and you can watch TV normally. LED light is blue.
3. Press the Power button again to turn off the TV.

Note:

- ◆ In order to reduce power consumption, set the TV in "Standby" mode when not watching TV. If you do not watch TV for an extended period of time, we recommend unplugging TV from power source.
- ◆ If the TV is turned off, to turn it on again, please wait at least 5 seconds in case the abnormal phenomena occurred.

Changing Channels/ Volume

1. Press CH \wedge / \vee button on the remote control, you can change the channels.
(Press VOL \wedge / \vee button to raise or lower the volume).
2. Press CH \wedge / \vee button on the front panel of the TV set, you can also change the channels.
(Press VOL \wedge / \vee button to raise or lower the volume).
3. Press the numeric buttons on the remote control to display the corresponding channels.

Channel setting

To set the channels:



- 1 Press Menu button to display the main menu.
- 2 Press ▲/▼ button to select Channel item.
3. Press ► button to enter Channel menu.
- 4 Press ▲/▼ button to select the option, press ► button. button to enter or press ◀▶ button to adjust the option.
- 5 When you are finished, press the Menu button to close the menu.

The options are:

- Program NO.: Adjusts the current channel number.
 - Colour System: Adjusts the colour system.
 - Fine Tune: Fine adjusts frequency to achieve a perfect effect.
 - RF Input: select the signal source for your TV (Antenna or Cable)
 - Auto Install: Searches the channels automatically.
 - Program Edit: Edit the channels, Including:
 - ◇ Rename: press Red button to change the name of the selected channel. Press ▲/▼ button to adjust the token of the name. Press ENTER button to confirm or Green button to cancel. The longest channel number name has 6 letters.
 - ◇ Skip the channel: press Green button to select skip function. If you want to cancel skip, press Green button again.
- The channels which are set to skipped will be skipped when pressing the CH/VV button on the remote control to brows the programs. However, they will still be directly selected by pressing the Program No.

Picture setting

To adjust the picture:

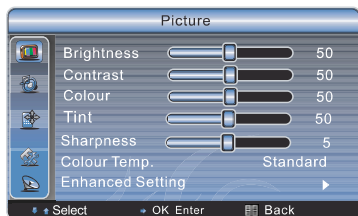

- 1 Press Menu button to display the main menu.
- 2 Press ▲/▼ button to select Picture item.
3. Press ► button to enter Picture menu.
- 4 Press ▲/▼ button to select the option, press ► button to enter or press ◀▶ button to adjust the option.
- 5 When you are finished, press the Menu button to close the menu.

The options are:

- **Brightness:** Increases the brightness to add more light to dark areas of the picture. Decreases the brightness to add more dark to light areas of picture.
- **Contrast:** Increases the picture level to adjust the white areas of the picture. Decreases the picture level to adjust the black areas of the picture.
- **Colour:** Adjusts the intensity of the colour.
- **Tint:** The option is only available under NTSC system. It adjusts the overall colour of the picture.
- **Sharpness:** Increases the sharpness level to show cleaner and cleaner image. Decreases the level to show a smoother picture.
- **Colour Temp.:** Selects the colour temperature. You can select Standard, Warm or Cool.
- **Enhanced Settings:** Accesses advanced video settings, Including:
 - DNR (Digital Noise Reduction):** It can optimize the picture signal from time and space; reduce the outside noise interference and return the pure initial signal. It has four ratings: Low , Standard, Strong and Off.
 - CTI (Color Transient Improvement):** Marginal improvements in color, that color the edge of a sharp transition.
 - Flesh Tone:** When this feature is "on" state, the TV could be the basis of image content, for color correction.
 - ALC (Adaptive Luma Control):** According to the screen in different scenes, the dynamic adjustment of image contrast to show the effect of better quality.

Sound setting

To adjust the sound:



- 1 Press Menu button to display the main menu.
- 2 Press ▲/▼ button to select Sound item.
- 3 Press ► button to enter Sound menu.
- 4 Press ▲/▼ button to select the option, press ► button. button to enter or press ◀▶ button to adjust the option.
- 5 When you are finished, press the Menu button to close the menu.

The options are:

- Balance: Adjusts the volume from the left and right speakers.
- Speakers: Choice of internal speaker or external speakers, when the speaker is set to internal, the sound comes from the TV's internal speakers. when the speaker is set to external, The audio output level is a line level fixed and should be connected to an external amplifier or amplified speakers. This output level will not drive a non-powered speaker.
- Surround: Enhance the sound of the surround sound and bass effects.
- Equalizer: Reduce or enlarge the sound of the main frequency points.
- Lip Sync: Keeps sound and image synchronization. This feature is active only in TV mode.

Screen setting

To adjust the screen :

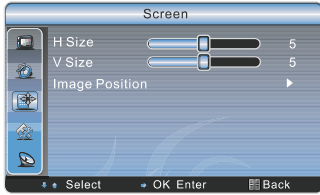

- 1 Press Menu button to display the main menu.
- 2 Press ▲/▼ button to select Screen item.
- 3 Press ► button to enter Screen menu.
- 4 Press ▲/▼ button to select the option, press ► button. button to enter or press ◀▶ button to adjust the option.
- 5 When you are finished, press the Menu button to close the menu.

The options are:

- H-Size: Adjusts the horizontal size of the image.
- V-Size: Adjusts the vertical size of the image.
- Image Position: Adjusts the position of image on screen by press ▲/▼/◀▶ button.

Note:

HDMI interface transmits whole digital signal and Geometry Adjust function is not used, so Screen cannot be selected under HDMI. H-Size and V-Size are not available under VGA source, Phase and Manual Clock are only available under VGA source.

Function setting

To set the parameters:

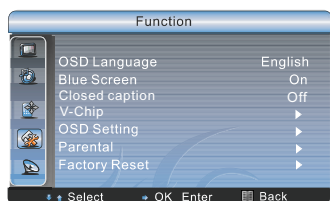

- 1 Press Menu button to display the main menu.
- 2 Press ▲/▼ button to select Function item.
- 3 Press ► button to enter Function menu.
- 4 Press ▲/▼ button to select the option, press ► button. button to enter or press ◀▶ button to adjust the option.
- 5 When you are finished, press the Menu button to close the menu.

The options are:

- OSD Language: Sets the menu language.
- Blue Screen: Turns on or off display of a blue screen as the image when there is no video signal.
- Closed caption: You may view specially labeled (cc) TV programs, movies, news, prerecorded tapes, etc. with either a dialogue caption or text display added to the program.
- V-chip : Enables parents to prevent their children from watching inappropriate programs on TV.
- OSD Setting: It including Time and Transparency, sets the time and transparency of menu separately.
- Parental: Lock some channels or videos to protect your children. When you first use this function, the default Password is [0000]. Only you input this password, you can continue to the next operation.

Channel Lock: The function can let you block any channel you want.

Video Lock: You can block the input source by this function.

Change Password: At the first time, you can use the default password. If you want to change it. This function will be needed. First enter the new password then enter the same password again. You will get the new password.

Clear All: This function will let you clean all the channels remembered in this TV.

Note: if you choose this function, all the program you preset will be lost.

- Factory Reset: Resets your TV to the factory defaults. You can use this function when this unit is in an abnormal state or you want to make it return to the factory reset.

Appendix

Troubleshooting

Before calling a service technician, please check the following table for a possible cause of the problem and some solutions.

Customer important notice: If the TV can not be operated, please unplug the power and restart .

Symptoms	Possible Solutions
TV will not turn on	<ul style="list-style-type: none">▪ Make sure the power cord is plugged in, then press Power (Standby).▪ The remote control batteries may be dead. Replace the batteries.▪ Unplug the VGA wire and plug the power wire again.
No picture, no sound	<ul style="list-style-type: none">▪ Check if you have set the timer off.▪ Check the antenna/cable connections.▪ Press [Display] to see if you have selected the right signal source.
No sound, picture OK	<ul style="list-style-type: none">▪ The sound may be muted. Press [VOL+] on the remote control.▪ The station may have broadcast difficulties. Try another channel.▪ Check the speakers cable connections.
Poor sound, picture OK	<ul style="list-style-type: none">▪ The station may have broadcast difficulties. Try another channel▪ Check the speakers cable connections.
Poor picture, sound OK	<ul style="list-style-type: none">▪ Check the antenna connections.▪ The station may have broadcast difficulties. Try another channel.▪ Adjust the picture from the menu.
Unable to select a certain channel	<ul style="list-style-type: none">▪ The channel may be skipped. Choose this channel by directly selecting the buttons from the remote control.
Poor colour or no colour	<ul style="list-style-type: none">▪ The station may have broadcast difficulties. Try another channel.▪ Adjust Saturation in the Video settings menu.
The remote control does not operate	<ul style="list-style-type: none">▪ There may be an obstruction between the remote control and the remote control sensor.▪ The batteries may be installed with a wrong polarity.▪ The remote control batteries may be dead. Replace the batteries.
Disorder display at power on	<ul style="list-style-type: none">▪ This may be caused because of a very short interval between POWER OFF and ON.▪ Unplug the power and restart.

Federal Communications Commission Statement

NOTE

The manufacturer is not responsible for any radio or tv interference caused by unauthorized modifications to this equipment. Such modifications could void the user's authority.

NOTE

This equipment has been tested and found to comply with the limits for a class B digital Device, pursuant to part 15 of the FCC Rules. These limits are designed to provide reasonable protection against harmful interference in a residential installation. This equipment generates, uses and can radiate radio frequency energy and, if not installed and used in accordance with the instructions, may cause harmful interference to radio Communications. However, there is no guarantee that interference will not occur in a particular installation. If this equipment does cause harmful interference to radio or television reception, which can be determined by turning the equipment off and on, the user is encouraged to try to correct the interference by one or more of the following measures:

- 1.Reorient or relocate the receiving antenna.
- 2.Increase the separation between the equipment and the receiver.
- 3.Connect the equipment into an outlet on a circuit different from that to which the receiver is connected.
- 4.Consult the dealer or an experienced radio/TV technician for help.