

# Getting Started

## Making connections

### NOTES

- Check the jacks for position and type before making any connections. Loose connections can result in image or color problems. Make sure that all connections are tight and secure.
- Not all A/V devices have the ability to connect to a TV, please refer to the user manual of your A/V device for compatibility and connections procedure.
- Always unplug the power cord when connecting external equipment.

### Connecting an antenna, cable or cable/satellite box

1. Turn off the TV before connecting the antenna.
2. Connect one end of a coaxial cable (not included) to the RF OUT jack on the antenna, cable or cable/satellite box. If you are using an antenna with twin-lead cable, you may need a 300-75 ohm adapter (not provided) to connect it to the back of your TV. Likewise, if you are using several antennas, you may need a combiner (not provided).
3. Connect the other end of the cable to the ANT/CABLE jack on the side of your TV.

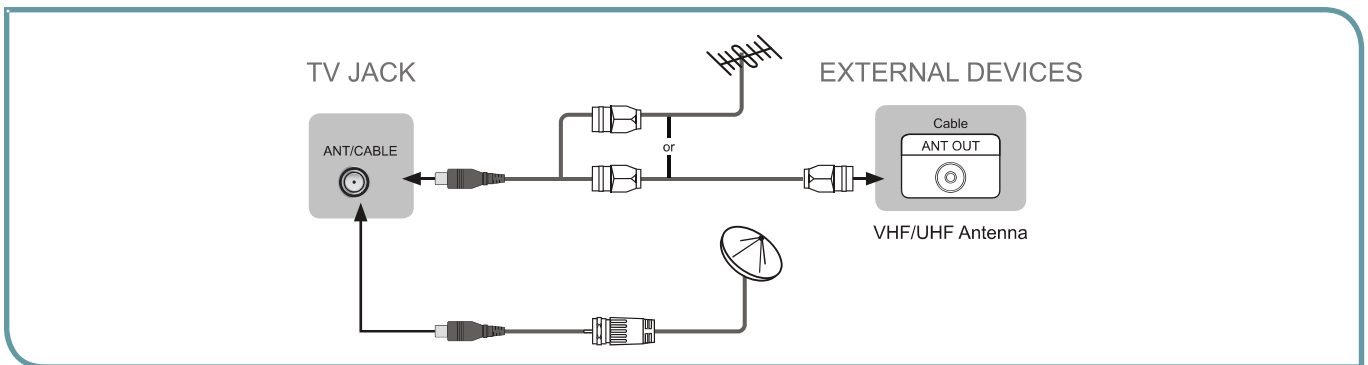

### Connecting an A/V Device with Composite Cable

1. Use the audio and video cables to connect the external A/V device's composite video/audio jacks to the TV's jacks. (Video = yellow, Audio Left = white, and Audio Right = red)
2. Plug the connected devices into the mains socket before switching on the TV.
3. Select the corresponding source from the TV.

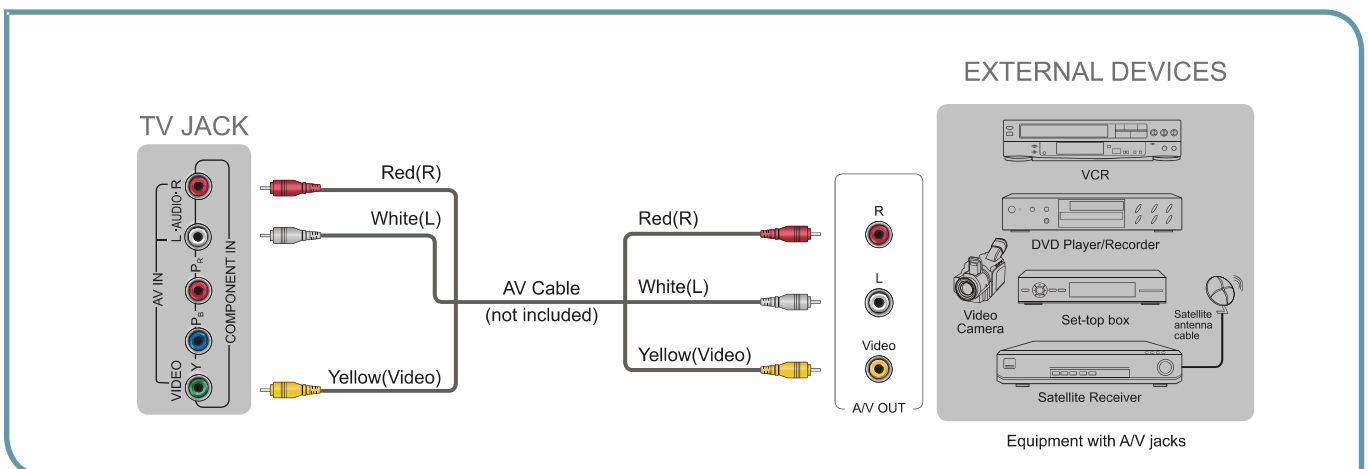

# Getting Started

## ❏ Connecting an A/V Device with Component (YP<sub>B</sub>P<sub>R</sub>) Cable

1. Use a component cable to connect the external A/V device's component output jacks to the TV's YP<sub>B</sub>P<sub>R</sub> jacks. Use an audio cable to connect the external A/V device's component audio jacks to the TV's AUDIO (L/R) jacks.
2. Plug the connected devices into the mains socket before switching on the TV.
3. Select the corresponding source from the TV.

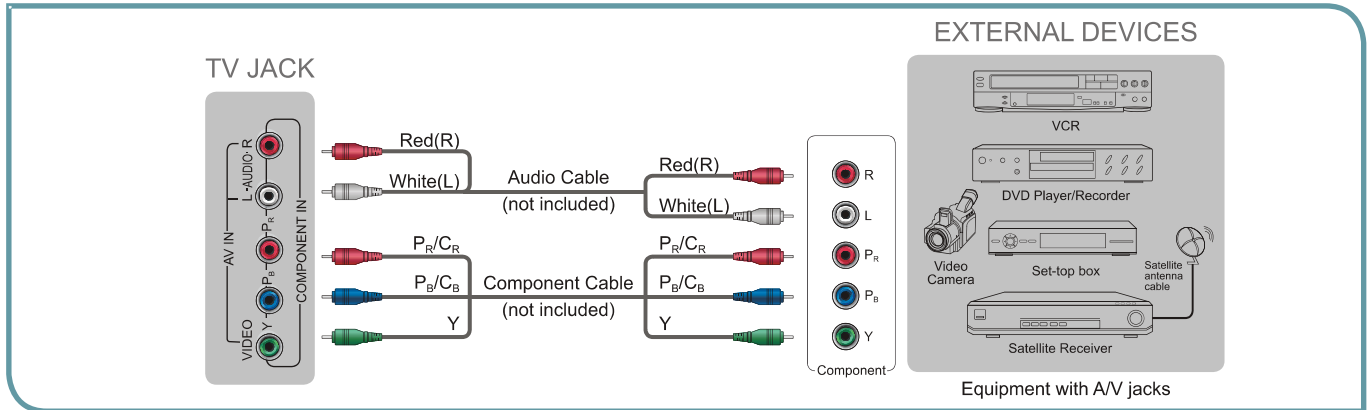

## ❏ Connecting an A/V Device with HDMI Cable

- Support digital connections between HDMI - enabled A/V devices such as PVR, DVD, Blu-ray, AV receiver and digital devices.
- Some devices such as PVR or DVD player require HDMI signal to be set to output in the device's settings.
- Please consult your device user manual for instructions.

1. Use an HDMI cable to connect the A/V device's HDMI output jack to the TV's HDMI jack.
2. Plug the connected devices into the mains socket before switching on the TV .
3. Select the corresponding source from the TV.

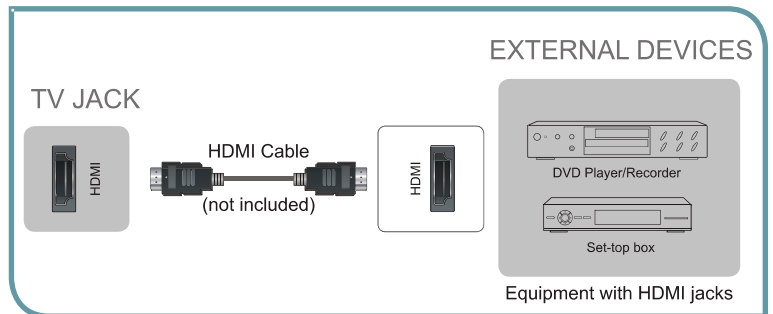

### ☑ NOTE

The HDMI connector provides both video and audio signals, it's not necessary to connect the audio cable.

## ❏ Connecting an MHL-enabled device

You can connect an MHL-enabled device, such as a cell phone or Roku Streaming Stick™, and view your device's screen on the TV.

1. Connect one end of an HDMI-to-MHL cable to the micro USB port on the device.
2. Connect the other end of the cable to the HDMI / MHL jack.
3. Select the corresponding source from the TV.

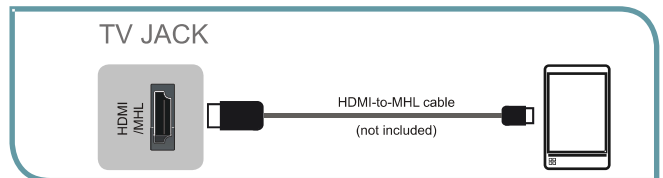

### ☑ NOTE

This feature may not be available, depending on your TV series.

## ❏ Connecting a headphone

Headphones can be connected to the /AUDIO OUT output on your set. (While the headphone is connected, the sound from the built-in speakers will be disabled.)

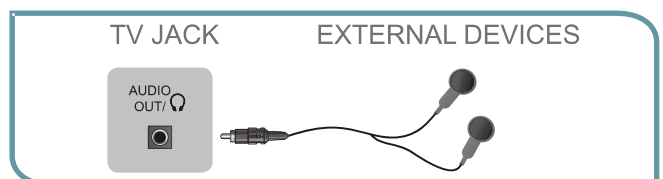

# Getting Started

## Connecting a PC with VGA Cable

1. Use a VGA cable to connect the PC's VGA output jack to the TV's VGA jack. Use an audio cable to connect the PC's audio output jack to TV's PC/DVI AUDIO IN jack.
2. Plug the connected devices into the mains socket before switching on the TV.
3. Select the corresponding source from the TV.

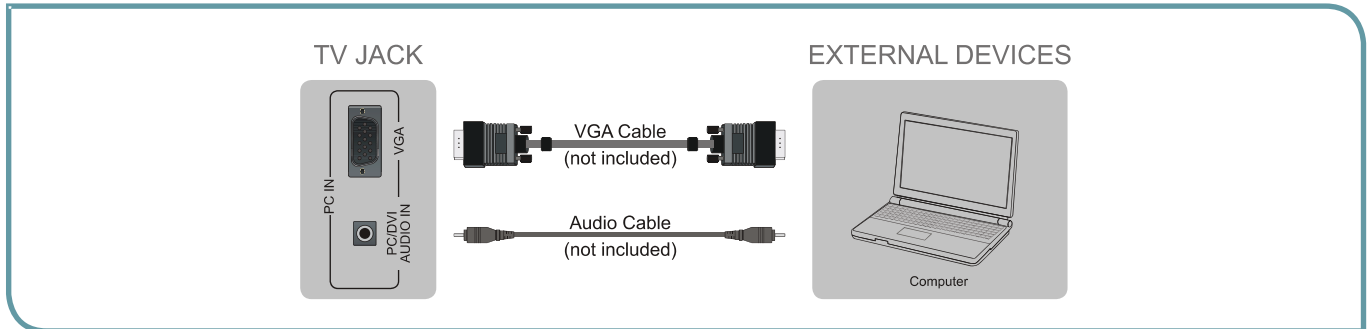

### NOTES

- Primarily this unit is intended for use as an LCD TV. If you want to use it as a monitor, please contact the manufacturer of the PC Video/Graphic's card for further support. Perfect compatibility is not warranted.
- The VGA cable will not supplied with the product.
- We strongly recommend to use VGA cable with 2 cores as shown in the figure.

## Connecting an Audio Receiver with Audio cable

1. Use an audio cable to connect the A/V device's digital audio in jack to the TV's DIGITAL OUTPUT jack. Or use an RCA Y-cable (1/8"-stereo mini to L/R phono - not provided) to connect analog sound system to the TV's AUDIO OUT jack.
2. Plug the connected devices into the mains socket before switching on the TV.
3. Select the corresponding source from the TV.

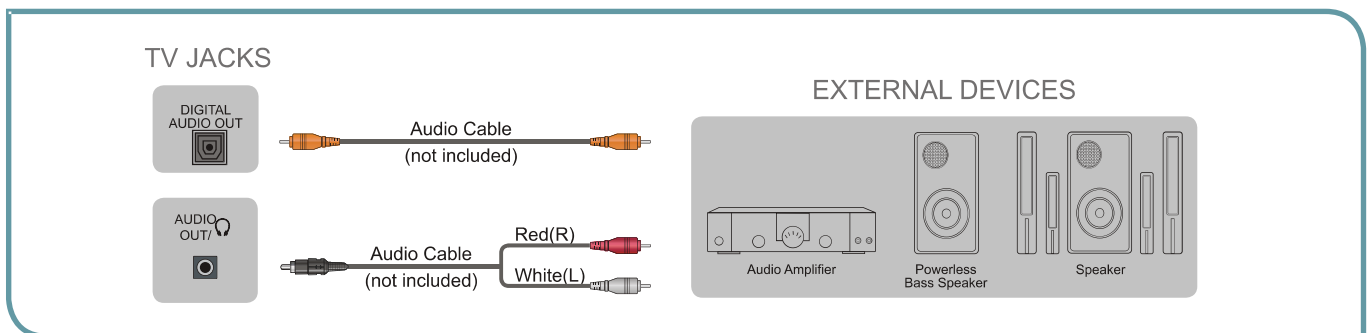

### NOTES

- When a digital audio system is connected to the DIGITAL AUDIO OUT (Optical) jack, decrease the volume of both the TV and the system.
- 5.1 CH (channel) audio is available when the TV is connected to an external device supporting 5.1 CH.
- When the receiver (home theater) is set to on, you can hear sound output from the TV's digital audio out jack. When the TV is receiving a DTV signal, the TV will send 5.1 CH sound to the home theater receiver. When the source is connected to the TV via HDMI, only 2 CH audio will be heard from the home theater receiver. If you want to hear 5.1 CH audio, connect the digital audio out jack from your DVD/Blu-ray player/cable box/STB satellite receiver directly to an amplifier or home theater.

# Basic Features

## Turning Your TV On or Off

To turn your TV on or off (standby mode):

1. Plug the power cord into an AC power outlet.
2. Press [POWER] button. Your TV turns on.
3. Press [POWER] button again to turn off your TV. When you turn off your TV, it goes into standby mode.

### WARNING

When your TV is in standby mode, it is still receiving power. To completely disconnect power, unplug the power cord.

### NOTE

If your TV does not receive an input signal for several minutes, it automatically goes into standby mode.

## Turning the TV On for the First Time

The Setup Wizard menu appears the first time you turn on the TV. It will assist you to specify the menu language, Picture Mode, TV Source and Channel Installation.

**IMPORTANT: Make sure that the antenna or cable is connected.**

1. Make sure that you have:
  - Installed batteries into the remote control .
  - Connected an antenna or cable.
  - Connected the power cord.
2. Connect your TV's power cord to a power outlet, then press power. The initial setup screen opens. Press [▲/▼] button to select your language, press [ENTER] button to confirm.

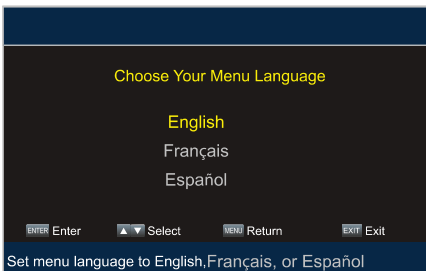

3. Press [▲/▼] to select your options and press [◀/▶] to set the options.

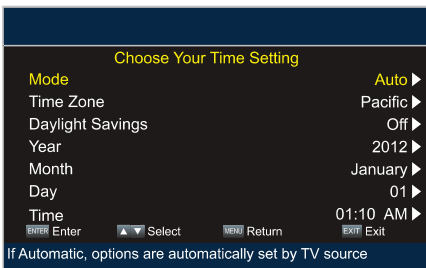

- If Auto selected, the options of Year/Month/Day/Time are not available.
  - Setting the Time: Press [◀/▶] to select the number you want to set and press [▲/▼] to set.
4. Press [▲/▼] to select your Picture Mode: Home Mode or Retail Mode, press [ENTER] button to confirm.

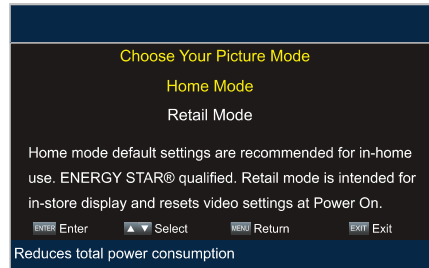

If you select Retail Mode, a message appears "Are you sure you want retail mode?" Select "Yes" to continue, or select "No" to change your selection.

5. Press [▲/▼] to select your TV Source: Antenna or Cable, press [ENTER] button to confirm.

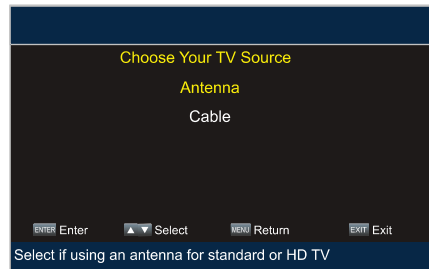

- Then your TV automatically starts Channel Installation available in your viewing area.

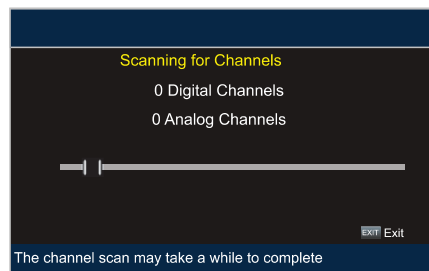

- Depending on the reception condition, it may take several minutes to scan channels. Please allow the process to complete without interruption.
- If you press [EXIT] to exit the scanning, a message appears "Please Run Channel Auto Scan", you should scan channels from the menu of Channels

# Basic Features

## Selecting the Input Source

The first time you turn on your TV, you must select the TV signal source. Your TV stores this information, so you do not need to change the TV signal source unless it changes. For example, you change from an outside antenna to cable TV.

### To select the video input source:

1. Turn on your TV, then press [INPUT] button on the remote or on the TV. The Input source menu opens.
2. Press [▲/▼] button to highlight the input source, then press [ENTER] button.

## Changing Channels / Volume

1. Press the [CH  $\Delta/\nabla$ ] (or [CH +/-]) on the TV/remote control to change the channel.
2. Press the [VOL  $\Delta/\nabla$ ] (or [VOL +/-]) on the TV/remote control to adjust the volume.
3. Press the numeric buttons on the remote control to display the corresponding channels.

### NOTE

Changing the channels can also be achieved by directly entering the channel number using the numeric keys on the remote control. If you are entering a two or three digit channel number, the time between key presses should be less than 3 seconds.

## Shortcuts Instructions

**Aspect** - Select the screen aspect ratio from Normal, Wide, Auto, Zoom, Cinema and 1:1 PIXEL MAP.

**Normal:** The original 4:3 aspect ratio (1.33:1 signal) is preserved, so black bars are added to the left and right of the image. Standard TV broadcasts are displayed with a 4:3 aspect ratio.

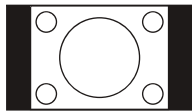

**Wide:** When watching a standard broadcast or full-frame movie in this mode, the display image is stretched proportionately to fill the TV screen. When watching a widescreen (1.78:1 signal) program or movie, the display image fills the TV screen.

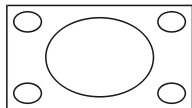

**Auto:** Automatically adjusts the image based on the screen size and the TV program.

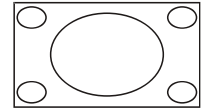

**Zoom:** Stretch the 4:3 aspect ratio image vertically and horizontally to fill the screen at 1:1.78 aspect ratio.

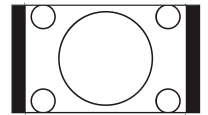

**Cinema:** Stretch the 4:3 aspect ratio image vertically and horizontally to fill the screen at 1:2.35 aspect ratio.

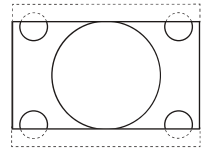

**1:1 PIXEL MAP (VGA and HDMI(RGB) only):** Detect the resolution of the signal and display an image with the same number of pixels.

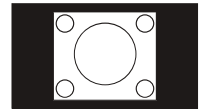

### NOTE

The aspect ratio varies with different sources.

**Picture** - Press to set the picture mode. It can be set as Vivid, Standard, Theater, Energy Savings or Custom. This mode achieves a certain image display effect by setting the brightness, contrast and color etc.

**Sound** - Press to set the sound mode. It can be set as Standard, Theater, Music, Speech and Custom.

**Mute** - Press to turn the sound off, press this button again to turn the sound back on. This function is used to switch off sound temporarily.

**Sleep** - It can set the TV to let it enter into the Standby state automatically. Press this button repeatedly to select the proper sleeping clock mode, and the clock tells you the remaining time before the TV enters Standby state.

**Display** - Display the information banner. The information including channel number, channel name, current system time, tuner mode, audio stream, video format, audio language, closed caption mode, parental locks rated, program details, etc.

# Basic Features

## To Use the Menu

- 1 Press [MENU] to open the main menu.
- 2 Press [▲/▼] to select a menu option, then press [▶/ENTER] button to enter the menu.
- 3 In each menu, you can:
  - Press [▲/▼] to select an item,
  - Press [◀/▶] to adjust the value, or
  - Press [▶/ENTER] to enter the submenu,
  - Press [MENU] to back the previous menu.
- 4 Press [EXIT] to exit the menu.

### NOTE

The menus in the user manual may vary slightly from the actual screen.

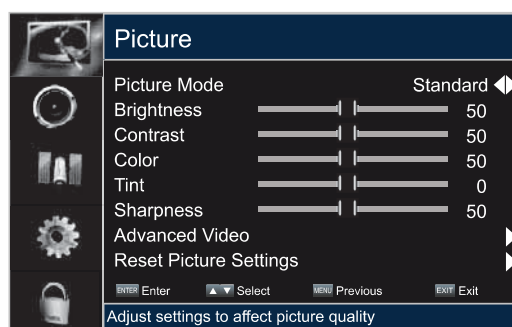

## Using the Picture Menu

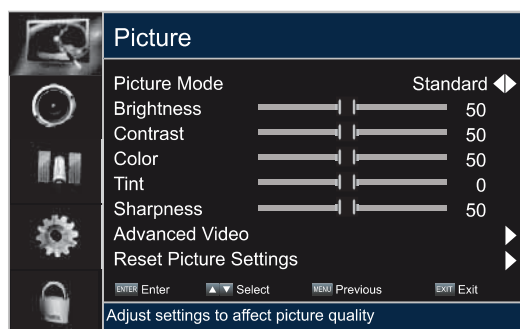

### You can adjust:

**Picture Mode** - Adjust the Picture Mode. You can select Vivid, Standard, Theater, Energy Savings or Custom.

**Brightness** - Increase or decrease the brightness of the picture. Increasing the brightness can add more light to dark areas of the picture, while decreasing the brightness can add more darkness to light areas of the picture.

**Contrast** - Increase or decrease the contrast of the picture. Increase the contrast to adjust the white areas of the picture or decrease the contrast to adjust the black areas of the picture.

**Color** - Adjusts the color intensity of the picture. A low setting may make the color look faded. A high setting may make the color look artificial.

**Tint** - Adjusts the color balance of the picture. Use this control to make skin tones look more natural.

**Sharpness** - You can increase the sharpness level for clearer images or decrease the sharpness level for smoother images.

**Advanced Video** - Access advanced video settings such as Backlight, Color Temperature and Noise Reduction.

**Dynamic Backlight Control:** Enhances the contrast ratio between light and dark areas of the picture. You can select Off, Low, or High.

**Backlight:** Sets the overall brilliance of the screen. When the option of **Dynamic Backlight Control** is turned Low or High, you cannot change the Back Light setting.

**Aspect Ratio:** To choose the screen aspect ration from Wide, Cinema, Auto, Normal, 1:1 PIXEL MAP and Zoom .

### NOTE

The option of the screen Aspect Ration is different in different inputs. (For more information, see "Shortcuts Instructions")

**Color Temperature:** Change the color temperature. You can select the color temperature from three options: Cool, Normal or Warm.

**Overscan:** Adjusts the picture's reproduction rate. You can select On or Off.

### NOTE

Only available in DTV, Component and HDMI(YUV) source.

**Noise Reduction:** Select to reduce the noise level of connected equipment: off, Low, Medium and High.

**Adaptive Contrast:** Automatically adjusts picture detail and brightness. You can select On or Off.

**120Hz Effect:** Inserts frames to reduce judder in fast action scenes. You can select On or Off.

### NOTE

Only available in the models that support 120 Hz.

**Reset Picture Settings** - Resets all Picture Settings to the factory defaults.

# Basic Features

## Using the Audio Menu

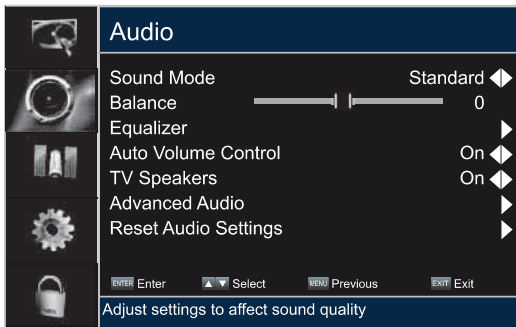

### You can adjust:

**Sound Mode** - Select the Sound Mode: Standard, Theater, Music, Speech or Custom.

**Balance** - Adjust the volume of the left and right speakers.

**Equalizer** - Soften or enhance the sound at specific frequency points.

**Auto Volume Control** - Automatically adjusts volume to a consistent level; attenuates loud passages.

**TV Speakers** - Selects where to play TV audio. You can select On (default setting) to play audio through TV speakers, or select Off to play audio through the speakers on an external audio system.

**Advanced Audio** - Access Advanced Audio settings such as Digital Audio Out, MTS/SAP, Audio Language.

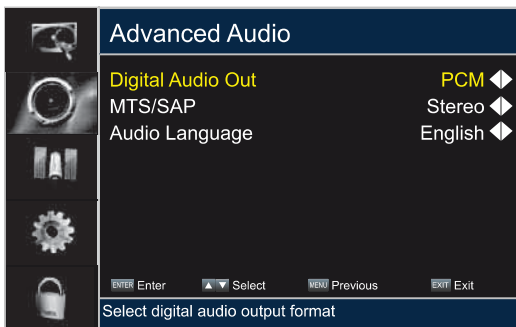

**Digital Audio Out:** Send digital audio to an external audio system. You can select PCM or RAW.

- **PCM:** PCM outputs two channel audio regardless of the input format.
- **RAW:** When the data stream carries Dolby signal, digital SPDIF outputs Dolby data stream. When the data stream carries no Dolby signal, it transports PCM data stream.

**MTS/SAP (Analog channels only):** Select the default audio stream, you can select Mono, Stereo or SAP (Second Audio Program).

- **Mono:** Select this option if there is noise or static on weak stereo broadcasts.
- **Stereo:** Select this option for programs broadcast in stereo.

- **SAP:** Depending on the particular program being broadcast, you can listen to a foreign-language translation.

**Audio Language** (Digital channels only) - Change the default value for audio language.

**Reset Audio Settings** - Resets all audio settings to the factory defaults.

## Using the Channels Menu

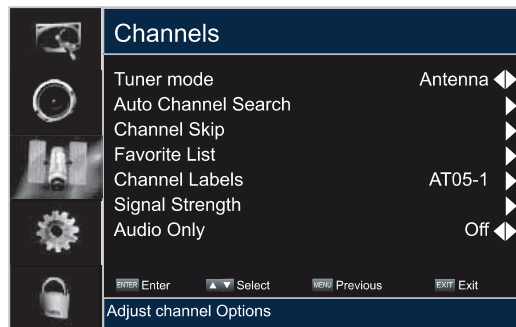

### You can adjust:

**Tuner Mode** - Select the TV signal source. You can select Antenna or Cable.

**Auto Channel Search** - Scans for channels that have signals and stores the channels information in memory.

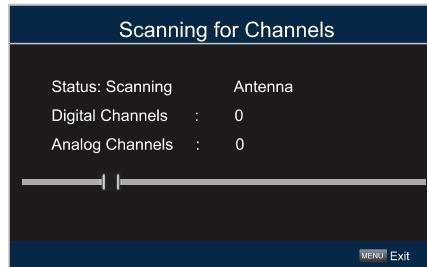

**Digital Channels:** The scanned TV program in digital signals.

**Analog Channels:** The scanned TV program in analog signals.

**Channel Skip** - You can hide channels in the channel list. Press [▲/▼] to select the channels you want to hide and press [ENTER] to confirm.

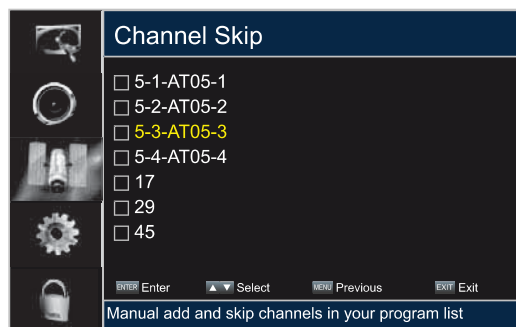

# Basic Features

## NOTE

When you press [CH  $\wedge$ /V] (or [CH +/-]) button, your TV skips the hidden channels. You can still tune to the channel by pressing the number buttons on the remote control.

**Favorite List** - Display your Favorite List. You can add or delete channels to create your favorite list.

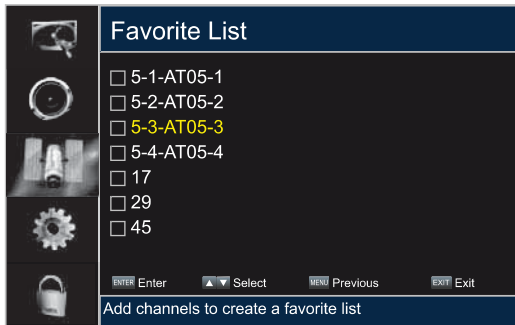

**Channel Labels** - Change the channel name. Press [◀/▶] to select the character you want to change, then press [▲/▼] to set the character.

**Signal Strength** (Digital channels only)- You can check the digital signal strength to determine if you need to adjust your antenna or digital cable input.

**Audio Only** - Listen to the program audio only, when you turn off the picture on your TV.

## NOTES

- Audio Only works only when the input source is TV, and your TV is receiving a broadcast signal.
- To exit audio only mode, press any button. When you exit audio only mode, the Audio Only option is automatically reset to Off.

## Using the Settings Menu

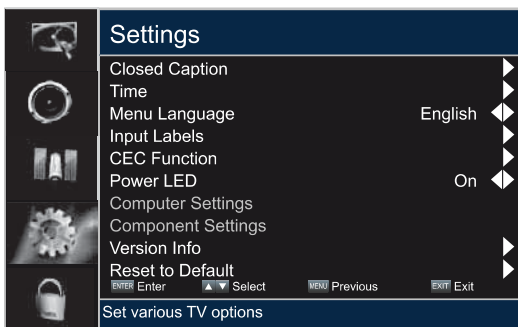

**You can adjust:**

**Closed Caption** - Adjust Closed Caption settings.

**Closed Caption:** To select CC Off (turns off closed caption), CC On (turns on closed caption), or CC on when Mute (turns on closed caption when the sound is muted).

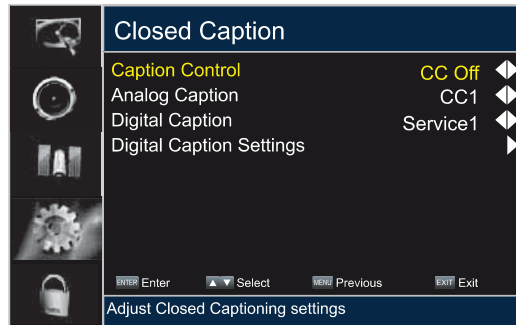

**Analog Caption:** Select an Analog Caption setting from CC1~CC4, TEXT1~TEXT4, Off.

**Digital Caption:** Select a Digital Caption setting: Service1~Service6, Off.

**Digital Caption Settings:** There are two Caption Styles. One is the automatic function set as the broadcaster, while the other is the custom style where you can adjust the font size, color, opacity, background color etc..

**Time** - Access Time settings such as Time Zone, Date/Time, Sleep Timer.

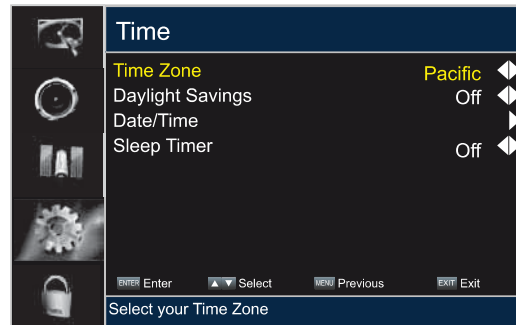

**Time Zone:** Select your local time zone: Pacific, Alaska, Hawaii, Newfoundland, Atlantic, Eastern, Central and Mountain.

**Daylight Savings:** Press [▲/▼] to highlight Daylight Savings, then press [◀/▶] to select On (if your viewing area observes Daylight Savings Time) or Off (if your viewing area does not observe Daylight Savings Time).

**Date/Time:** You can set time manually or select automatic if the TV is connected to an antenna or cable source.

● **Auto synchronization:** Select Manual (to set the date and time manually) or Auto (to set the date and time automatically from a TV signal source based on the time zone you select).

If you selected Manual, set the following options.

● **Date:** Set the current year/month/day.

● **Time:** Set the current time.

**Sleep Timer:** Specify the amount of time before your TV automatically turns off.

**Menu Language** - You can select the menu's language to English, Spanish or French.