

1 ACCESSORIES LIST

- User Manual
- Quick Setup Guide
- Remote Control
- Battery (AAA) × 2
- Screw (M4×12)×1
- Screw (M5×12)×4

If the item is not specified in the accessories list, it should be provided by customer.

2 INSTALLING THE STAND

NOTE

Product image is only for reference, actual product may vary in appearance.

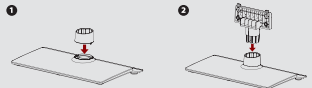

Insert the decorative part into the base making sure that the groove in the decorative part aligns with the ridge in the base.

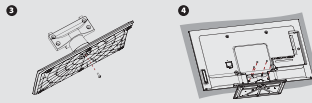

Secure the stand column to the base with 1 screw (M4X12) provided.

To install the base stand, slide in the base stand until the screw holes are aligned.

Secure the base stand to the TV with 4 screws (M5X12) provided.

CAUTION
Carefully place your TV face-down on a soft, cushioned surface to prevent damage to the TV or scratching to the screen.

3 INSTALLING A WALL-MOUNT BRACKET

- If you want to attach the TV to a wall-mount bracket (not provided), you should first remove the stand if it is pre-attached. Make sure the TV is laid face-down on a clean, safe, and cushioned surface.
- Attach purchased bracket on the TV with the 4 screws (Not provided).

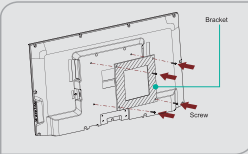

WARNING

To prevent internal damage to the TV and ensure the TV is mounted securely, be sure to use fixing screws (Not provided) which are 7 mm to 9 mm in length when measured from the attaching surface of the mounting hook.

<p>7-9 mm Wall-mount Bracket Screw</p>	<p>Wall-mount hole pattern VESA (mm)</p> <p>200 × 200</p>
	<p>Wall-mount screw size (mm)</p> <p>M6</p>

3. Follow instructions provided with the wall bracket.

- If you are not sure of your ability to complete the installation, contact a professional installer or service technician for assistance. The manufacturer is not responsible for any damages or injuries that occur due to mishandling or incorrect assembly.
- Be sure to use the provided spacers between the TV and the bracket when attaching the mount.

4 REMOTE CONTROL

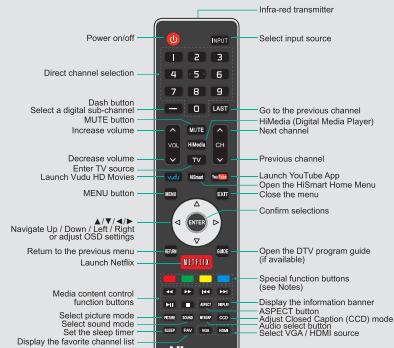

NOTE:

- Illustrations are for your reference only.
- Red/Green/Yellow/Cyan buttons are used for Electronic Program Guide (EPG). After pressing the [GUIDE] button when viewing digital channels, the same color buttons will appear with explanations in the on-screen display (OSD). Follow the steps shown in the OSD.

5 MAKING CONNECTIONS

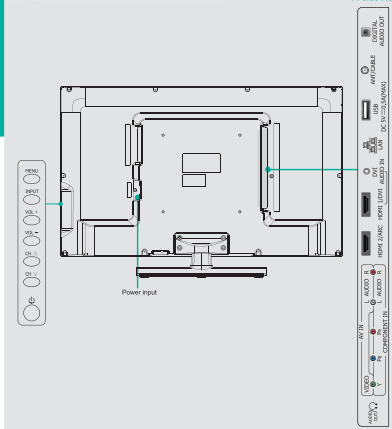

HDMI / COMP / AV

Connect an HDMI cable or Comp/AV Adapter from an external AV equipment.

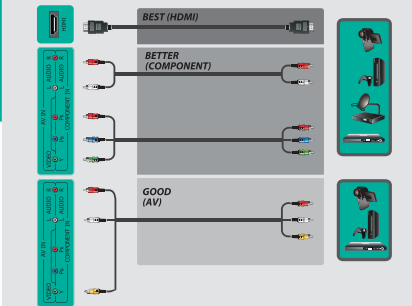

USB

Connect a USB device for browsing photos, music and movies.

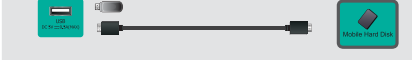

6 TV CONNECTORS

Check the jacks for position and type before making any connections. Loose connections can result in image or color problems. Make sure that all connections are tight and secure.

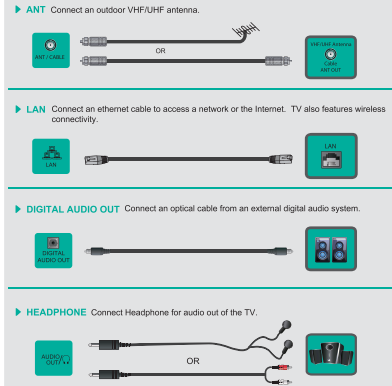

7 Turning the TV On for the First Time



MENU	OPERATIONS
Language setting	<ul style="list-style-type: none"> Please press [ENTER] to start the wizard, then press [▲/▼] button to select your language: English, Spanish or French, select [Next] to confirm enter the Welcome screen. In the Welcome screen introduced the available input devices and interfaces.
Country setting	<ul style="list-style-type: none"> Please press [▲/▼] button to select the country where you will operate the TV.
Time zone setting	<ul style="list-style-type: none"> Select the local time zone according to your region. Daylight Saving: Set the Daylight Saving time for your area.
Use Mode	<ul style="list-style-type: none"> Select your Mode Setting: Home Mode or Retail Mode. If you select Retail Mode, a message appears: "Are you sure to change to retail mode?" Select "OK" to continue, or select "No" to change your selection. Home Mode is the recommended setting which offers full functionality of the television. If you selected Retail Mode, Energy Saving is not realized.
Select Network	<ul style="list-style-type: none"> Select Network: Connect your TV to access the network. When the Network Setting menu opens, Hisense Service Terms and Conditions will appear. Press [▶] to scroll through the pages. Please read it carefully. If you want to access the internet, press the [Align] button to set your TV's network connections. Otherwise, press the [Disable] button to enter the Channel search menu. You can set up the network configuration in this menu. For more information, please refer to the section titled "Network Connection" and "Network Setup" in the user manual.
Channel Search	<ul style="list-style-type: none"> Press [▲/▼] to select your Tuner Mode: Antenna or Cable, press [ENTER] button to confirm. Press [▶] to set the Channel Installation: Scan or Skip Scan, press [ENTER] button to confirm. If you select "Scan", your TV automatically starts Channel Installation available in your viewing area. If you select "Skip Scan", your TV does not scan for channels. Depending on the reception condition, it may take up to 30 minutes or more to complete memorizing channels. Please allow the process to complete without interruption. After scan, you will enter the complete interface. It will display all information that you set just now and then you can press "GO" to exit the wizard.

NOTE:
If you are using a cable or satellite box and you have connected it to the TV using a Coaxial cable, you should select the cable option. Be sure the cable or satellite box is turned on before starting the channel scan. If you use a cable or satellite box connected to a TV, Component or HDMI, you don't need to scan for channels.

8 SPECIFICATIONS

Model Name	32K20DW	
Dimension	Without Stand	Width: 28.9 inches (735.3 mm) Height: 17.4 inches (441.9 mm) Depth: 3.0 inches (76 mm)
	With Stand	Width: 28.9 inches (735.3 mm) Height: 19.6 inches (497.6 mm) Depth: 7.9 inches (200 mm)
Weight	Without Stand	13.2 lbs (6 kg)
	With Stand	14.3 lbs (6.5 kg)
LCD Panel Minimum size (diagonal)	31.5 inches	
Screen resolution	1366 × 768	
Audio power	6 W × 6 W	
Power consumption	Power consumption	
Power supply	120 V ~ 60 Hz	
Receiving systems	Analog	NTSC
	Digital	ATSC / QAM
Receiving channels	VHF: 2-13 UHF: 14-69 CATV: 1 - 125	Digital Terrestrial Broadcast (DTTB) 2 - 69
	Digital cable (64/256 QAM): 1 - 135	
Tuner type	Frequency synthesized	
Environmental conditions	Temperature: 41°F ~ 95°F (5°C ~ 35°C)	Humidity: 20% ~ 80% RH
	Atmospheric pressure: 86 kPa ~ 106 kPa	
Component Input	480 I / 60 Hz, 480 P / 60 Hz, 720 P / 60 Hz, 1080 I / 60 Hz, 1080 P / 60 Hz	
HDMI Input	RGB / 60 Hz (480x600, 800x600, 1024x768)	
	YUV / 60 Hz (480 I, 480 P, 720 P, 1080 I, 1080 P)	

9 HELP TOPICS

When there is something wrong with your TV, you can try turning off the TV and restarting it. You can also refer to the following chart for problem and solution tips. If the problem cannot be resolved, please contact Hisense for additional assistance.

SYMPTOMS	POSSIBLE SOLUTIONS
No sound or picture	<ul style="list-style-type: none"> Confirm power cord is plugged into the AC outlet and the AC outlet is getting electricity. Attempt to power on unit using the power button on both the TV and the Remote.
Picture is normal, but no sound	<ul style="list-style-type: none"> Check the volume settings. Check if Mute mode is set "on".
I have connected an external source to my TV and I get no picture and/or sound.	<ul style="list-style-type: none"> Check for the correct output connection on the external source and for the correct input connection on the TV. Make sure you have made the correct selection for the input mode for the incoming signal.
Network connection fail.	<ul style="list-style-type: none"> Check network physical connection, make sure connection is correct. Enter "Menu", "Network", "Configuration", make sure configuration is correct according to your network service provider. Enter "Menu", "Network", "Configuration", "Connection Test" to make sure that network connection test is successful.
Connect Vudu/Netflix fail.	<ul style="list-style-type: none"> Check network physical connection, make sure connection is correct. Enter "Menu", "Network", "Configuration", make sure configuration is correct according to your network service provider. Enter "Menu", "Network", "Applications", "VUDU/Netflix", "Deactivation" to reset "VUDU/Netflix" account.
How do I get easy IPTV to work on my TV?	<ul style="list-style-type: none"> You need a broadband (high speed) Internet service with a speed of no less than 1.5 Mbps. Connect the TV to the internet through your router by an Ethernet Cable or wireless. If connection fails, check with your internet service provider or router manufacturer to determine if there is a firewall, content filter, or proxy settings that may block the TV from accessing the internet. Before calling for service, check the following information for possible solutions to problems you may experience. If none of these solutions work, turn off the TV, then turn it on again. Caution: Do not try to repair the TV yourself. Refer all servicing to qualified repair personnel.