

LCD TV

User's Guide

For use with models: L26HDF12TA /
L32HDF12TA / L40FHDF12TA





Need Assistance?

Please visit our website at www.tclusa.com
or call 1-877-300-8837.

The Creative Life

TCL

Important Information

	CAUTION RISK OF ELECTRIC SHOCK. DO NOT OPEN.		 This symbol indicates that this product incorporates double insulation between hazardous main voltage and user accessible parts. When servicing, use only identical replacement parts.
<p>Caution: To reduce the risk of electric shock, do not remove cover (or back). No user serviceable parts inside. Refer servicing to qualified service personnel.</p>			
	This symbol indicates “dangerous voltage” inside the product that presents a risk of electric shock or personal injury.		This symbol indicates important instructions accompanying the product.

WARNING

To reduce the risk of fire or electric shock, do not expose this product to rain or moisture. This product should not be exposed to dripping or splashing. No objects filled with liquids, such as vases, should be placed on the component.

WARNING

The TV is unstable if it is not properly attached to the base or mounted to the wall. Please follow the base or wall mounting instructions provided in the User’s Guide to ensure your safety.

WARNING The batteries shall not be exposed to excessive heat such as sunshine, fire or the like.



This symbol indicates that this product contains mercury. Special disposal of this product for environmental reasons may be required under the laws applicable to your jurisdiction. For disposal or recycling information, please contact your local authorities or the Electronic Industries Alliance: www.eiae.org.

Refer to the identification/rating label located on the back panel of your product for its proper operating voltage.

FCC regulations state that unauthorized changes or modifications to this equipment may void the user’s authority to operate it.

Cable TV Installer: This reminder is provided to call your attention to Article 820-40 of the National Electrical Code (Section 54 of the Canadian Electrical Code, Part 1) which provides guidelines for proper grounding and, in particular, specifies that the cable ground should be connected to the grounding system of the building as close to the point of cable entry as practical.

Important: This television is a table model and is designed to sit on a firm, flat surface. Don’t place the TV on soft carpeting or similar surface because the ventilation slots on the bottom of the unit will be blocked, resulting in reduced lifetime from overheating. To assure adequate ventilation for this product, maintain a spacing of 4 inches from the top and side of the TV receiver and 2 inches from the rear of the TV receiver and other surfaces.

Also, make sure the stand or base you use is of adequate size and strength to prevent the TV from being accidentally tipped over, pushed off, or pulled off. This could cause personal injury and/or damage to the TV. Refer to the Important Safety Instructions on the next page.

The Power button (followed by the power symbol) on this TV and your remote control puts the TV into a very low-power standby mode but will not completely turn the power off. In order to completely shut the power off, you will need to disconnect the power cord from the outlet. The mains plug/appliance coupler is used as disconnect device, the disconnect device shall remain readily operable. Therefore, you should ensure that the TV is installed in a manner that allows you to disconnect the power cord when desired.

Product Registration

Please register your TCL purchase on-line at www.tclusa.com. It will make it easier to contact you should it ever be necessary. Registration is not required for warranty coverage.

Product Information

Keep your sales receipt to obtain warranty parts and service and for proof of purchase. Attach it here and record the serial and model numbers in case you need them. These numbers are located on the product.

Model No. _____ Serial No. _____
Purchase Date _____ Dealer/Address/Phone _____

Important Safety Instructions

1. Read and follow all instructions.
2. Keep these instructions.
3. Heed all warnings.
4. Do not block any ventilation openings. Install in accordance with the manufacturer's instructions.
5. Do not install near any heat sources such as radiators, heat registers, stoves, or other apparatus (including amplifiers) that produce heat.
6. Do not negate the safety purpose of the polarized or grounding-type plug. A polarized plug has two blades with one wider than the other. A grounding type plug has two blades and a third grounding prong. The wide blade or the third prong is provided for your safety. If the provided plug does not fit your outlet, consult an electrician for replacement of the obsolete outlet.
7. Protect the power cord from being walked on or pinched particularly at plugs, receptacles, and the point where it exits from the component.
8. Do not use this component near water.
9. Only use the attachments/accessories specified by the manufacturer.
10. Clean only with dry cloth.
11. Use only with the cart, stand, tripod, bracket, or table specified by the manufacturer, or sold with the component. When the TV is placed on a cart, use caution when moving the cart to avoid injury from tip-over.
12. Unplug this component during lightning storms or when unused for long periods of time.
13. Refer all servicing to qualified service personnel. Service is required when the component is damaged in any way, such as power supply cord or plug damage, liquid spilled on or objects falling onto the component, rain or moisture exposure, abnormal operation, or if the component has been dropped.
14. If an outside antenna or cable system is connected to the product, be sure the antenna or cable system is grounded so as to provide some protection against voltage surges and built-up static charges. Section 810 of the National Electrical Code, ANSI/NFPA No. 70-1984 (Section 54 of Canadian Electrical Code, Part 1) provides information with respect to proper grounding of the mast and supporting structure, grounding of the lead-in wire to an antenna-discharge unit, size of grounding conductors, location of antenna-discharge unit, connection to grounding electrodes, and requirements for the grounding electrode. See following example:

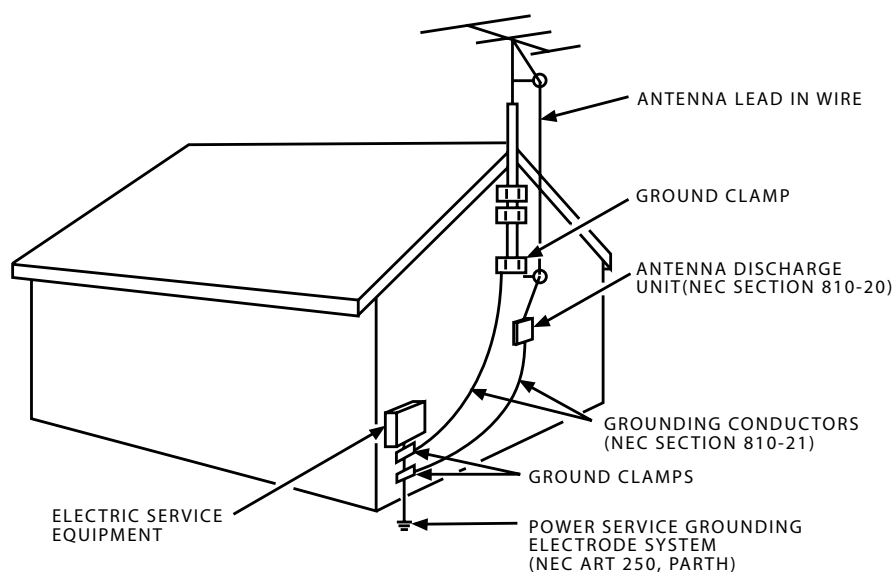

Table of Contents

Important Information	2
Important Safety Instructions.....	3

Chapter 1 - Connections and Setup

Before Initial Setup	5
Protect Against Power Surges.....	5
Safety Information	5
Avoid Audio Interference	5
Avoid Direct Light	5
Check Supplied Parts.....	5
Attaching Your TV to the Table Stand.....	6
Mounting Your TV to the Wall	7
Explanation of Jacks and Buttons on TV	8
Rear Panel	8
Side Input Jacks	9
TV Panel Buttons	9
Obtain the Signal.....	10
What You Need	10
What You Need to Know	10
Choose Your Connections	11
Composite Video Connection (Good) ..	12
Component Video Connection(Better) ..	12
HDMI Connection (Best).....	13
HDMI/DVI Connection.....	13
PC Connection.....	14
Plug in the TV	14
Put Batteries in the Remote.....	14
Turn on the TV.....	14
Using the Remote Control to Complete the Initial Setup.....	14
Complete the Initial Setup	15
Set the Menu Language.....	15
Set the TV Location Mode	15
Set the Time Zone.....	15
Auto Channel Scan	16
Skip Scan.....	16

Chapter 2 - Understanding the Basics

Turning the TV On and Off	17
Selecting the Video Input Source	17
Selecting a Channel	17
Adjusting/Muting the Volume	17
Screen Formats	18
Channel Banner.....	18

Chapter 3 - Using the Remote Control

Remote Control Buttons	19
------------------------------	----

Chapter 4 - Using the TV Menu

Using the Menu System	20
Picture Menu	20
Picture Settings.....	20
Expert Settings.....	20
Advanced Settings	21
PC Settings	21
Reset Picture Settings	21
Sound Menu	22
Setup Menu	23
Signal Type	23
Channel Scan	23
Channel Skip.....	24
Channel Edit	24
Input Skip.....	25
Input Labels	25
Closed Caption	26
Time Setup.....	27
Reset All.....	28
Parental Controls and V-Chip.....	28
Create/Change V-Chip Password	28
Reset V-Chip Password	28
Channel Block.....	29
Button Block.....	29
V-Chip Rating Enable.....	29
V-Chip Rating Screen	30
US V-Chip TV Ratings	30
Blocking Specific Content Themes	30
US V-Chip Movie Rating Limit.....	31
Blocking Canada V-Chip Ratings.....	31
Open V-Chip	32
Blocking Unrated/Exempt Programs....	32
Reset Downloadable Data	32
Input Block.....	32
Language Menu.....	32
USB Menu	33
USB Connection.....	33

Chapter 5 - Other Information

Frequently Asked Questions (FAQs)	34
Troubleshooting	35
Care and Cleaning.....	37
V-Chip Rating Explanations.....	38
US V-Chip Rating System.....	38
Canadian English V-Chip Rating System ...	38
Canadian French V-Chip Rating System....	39
Television Specifications.....	39
Limited Warranty	40

Chapter 1 - Connections and Setup

Before Initial Setup

Protect Against Power Surges

- Connect all components before you plug any power cords into the wall outlet or power strip.
- NEVER plug your TV into an outlet that is controlled by a wall switch.
- Turn off the TV before you connect or disconnect any cables.
- Make sure all antennas and cables are properly grounded. Refer to the Important Safety Instructions.

Safety Information

- Protect components from overheating.
- Don't block ventilation holes on any of the components. Arrange the components so that air can circulate freely.
- Don't stack components.
- If you place the component in a stand, make sure you allow adequate ventilation.
- If you connect an audio receiver or amplifier, place it on the top shelf so the heated air from it won't harm other components.

Avoid Audio Interference

- Position cables properly; insert each cable firmly into the designated jack.
- If you place components above the TV, route all cables down one side of the back of the TV instead of straight down the middle.
- If your antenna uses 300-ohm twin lead cables, do not coil the cables.
- Keep twin lead cables away from audio/video cables.

Avoid Direct Light

Don't place the TV where sunlight or room lighting is directed toward the screen. Use soft or indirect lighting.

Check Supplied Parts

Check that the following parts were packed with your product.

- 1 Remote Control and 2 AAA Batteries;
- User's Guide;
- Quick Start Guide;
- Parts List for Table Stand (see pages 6 and 7)

Replacing your remote

If you need to replace your remote, visit www.tclusa.com. A shipping and handling fee, and the appropriate sales tax, will be charged upon ordering. Have your Visa or MasterCard ready.

Attaching Your TV to the Table Stand

Your TV comes without the table stand attached so that you can choose to mount your TV either to its table stand or to a wall (wall mount sold separately). If you want to mount your TV to the wall, don't attach the table stand, remove the hinge cover and hinge. Follow the Mounting Your TV to the Wall instructions on page 7.

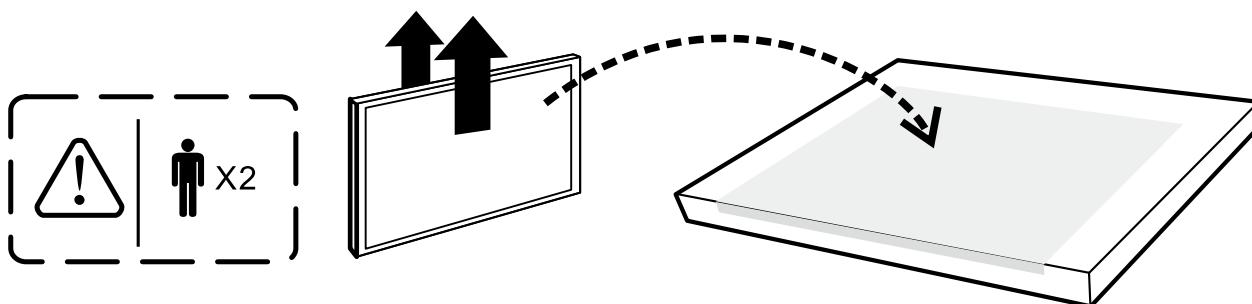

First, remove the TV bag and place it on a large, flat surface such as a table or countertop. Remove the TV from the carton and place it face down on the TV bag. Be sure that the TV is face down to avoid scratching the screen. Then follow the steps below:

Note: A-1 and A-2 for model L26HDF12TA and L32HDF12TA.

B-1 and B-2 for model L40FHDF12TA .

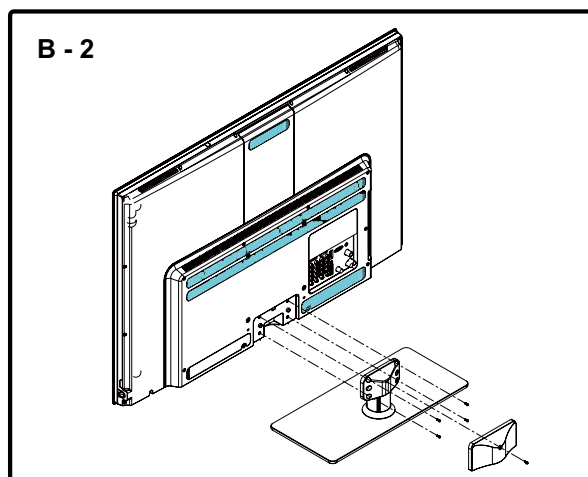
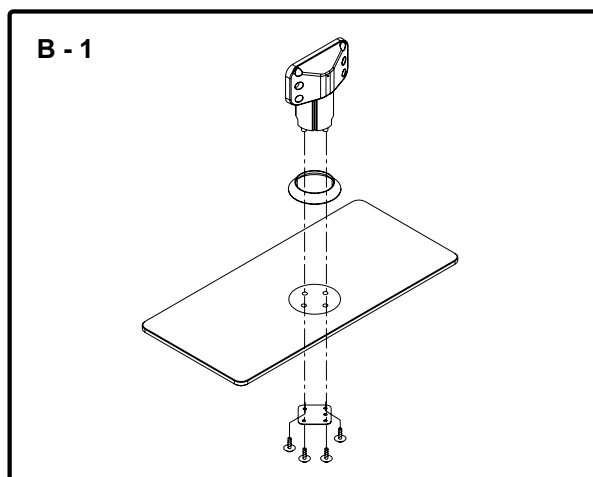
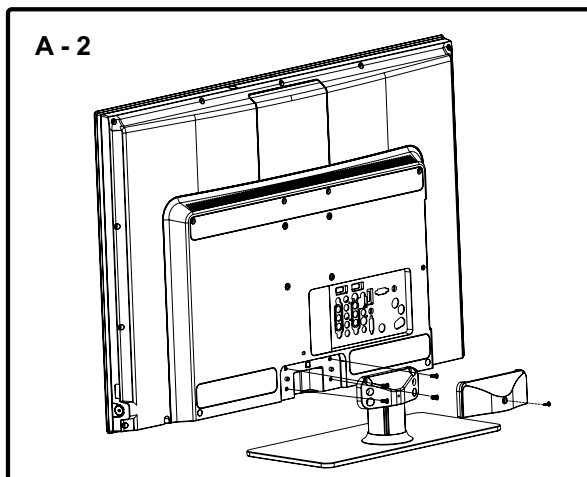
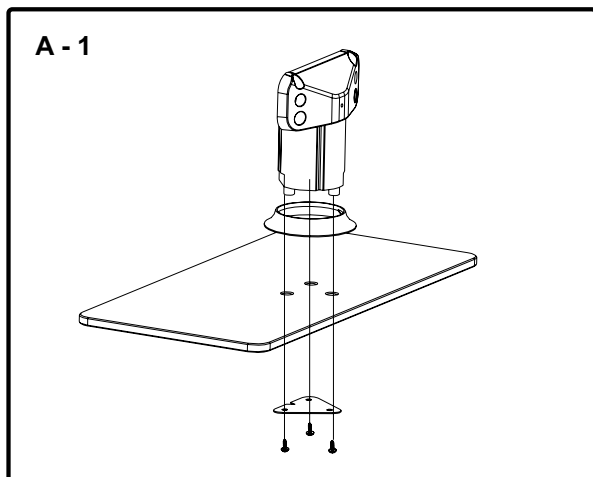

Mounting Your TV to the Wall

If you are mounting your TV to the wall, don't attach the table stand, remove the hinge cover and hinge.

To mount your TV to the wall, purchase a VESA wall mount.

Model L32HDF12TA/L26HDF12TA

Purchase a VESA 200 x 100, M4 screw

Model L40FHDF12TA

Purchase a VESA 200 x 100 , M4 screw

The VESA number is the horizontal and vertical measurement of the mounting holes. For example, 200x100 refers to the fact that the mounting measurements are 200mm horizontally and 100mm vertically.

Notes: Follow the directions included with the wall mount to mount the TV to the wall.

Caution: Your wall mount must be able to bear a minimum of five times the TV's net weight to avoid causing damage.

Explanation of Jacks and Buttons on TV

This section describes the jacks on the back panel of your TV. There are several ways to connect components.

Rear Panel

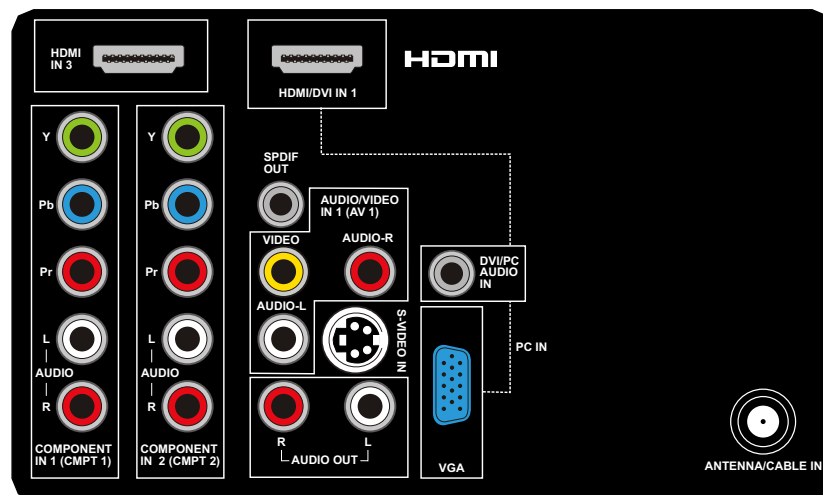

ANTENNA/CABLE IN

Lets you connect a coaxial cable to receive the signal from your antenna, cable, or cable box.

AUDIO (R/L) OUT Use an RCA audio cable to connect your TV to a compatible audio receiver. (not available in USB mode)

AUDIO/VIDEO IN 1 (AV 1) Lets you connect a component that has composite video jacks, such as a VCR or DVD player.

- **L AUDIO** Provides left audio connection when using the VIDEO IN jack. The left audio connectors are usually white. For mono audio sources, be sure to use the L AUDIO IN .
- **R AUDIO** Provides right audio connection when using the VIDEO IN jack. The right audio connector is usually red.

COMPONENT IN 1 and IN 2 Lets you connect a component that has component video jacks, such as a DVD player.

- **CMPT Y Pb Pr (Component Video)** Provides good picture quality because the video is separated into three signals. Use three video-grade or component video cables for the connection.
- **CMPT L AUDIO** Provides left audio connection when using the CMPT VIDEO inputs. The left audio connector is usually white. For mono audio sources, be sure to use the left AUDIO input.
- **CMPT R AUDIO** Provides right AUDIO connection when using the CMPT VIDEO inputs. The right audioconnector is usually red.

SPDIF OUT - DIGITAL AUDIO OUT (coaxial) Use a digital coaxial cable to connect your TV to a compatible audio receiver.

HDMI IN 3 Lets you connect a component, such as a digital cable box, with an HDMI output for the best picture quality.

HDMI/DVI IN 1 (High-Definition Multimedia Interface/Digital Visual Interface) Provides an uncompressed digital connection that carries both video and audio data by way of an integrated mini-plug cable. Since HDMI technology is based on Digital Visual Interface (DVI), the jack on the back of your TV is also compatible with DVI components.

(PC IN) VGA Connect your computer or other component with a VGA output to this jack using a 15-pin, D-sub cable.

DVI/PC AUDIO IN (used for DVI/PC only) Provides audio connection when using HDMI/DVI INPUT 1 jack for DVI or when using PC IN.

Note: If using a DVI component, remember to connect the audio cable because the DVI cable carries only the picture signal, not the sound.

S-VIDEO INPUT Allows you to connect an S-VIDEO cable from another component. Make sure you also connect audio cables form the component to the TV(share the same AUDIO input jacks of AV 1). To access a component connected to the S-VIDEO jack, press the **INPUT** button on your remote until you select **S-VIDEO**.

Side Input Jacks

(HEADPHONE) Allow you to connect headphones to listen to the sound coming from the TV.

USB

Allows you to connect a compatible mass storage device using a USB jack.

HDMI IN 2

Lets you connect a component, such as a digital cable box, with an HDMI output for the best picture quality.

AUDIO/VIDEO IN 2 (AV 2) Lets you connect a component that has composite video jacks, such as a VCR or DVD player.

- **L AUDIO** Provides left audio connection when using the VIDEO IN jack. The left audio connectors are usually white. For mono audio sources, be sure to use the L AUDIO IN .
- **R AUDIO** Provides right audio connection when using the VIDEO IN jack. The right audio connector is usually red.

TV Panel Buttons

If you cannot locate your remote, you can use the TV panel buttons on your TV to operate many TV features.

CH+/-

Press **CH+/-** to select channels stored in the channel list or to move up (▲) or down (▼) through the menu items.

VOL+/-

Press **VOL +/-** to increase or decrease the volume or to move right (▶) or left (◀) through the menu items.

VOL+/(OK) When in the menu system, press to display sub-menus and select highlighted items.

MENU

Press the **MENU** button to bring up the TV's Main menu.

INPUT

Press the **INPUT** button to select the signal source.

POWER (⏻)

Press the **POWER** button to turn the TV on and off.

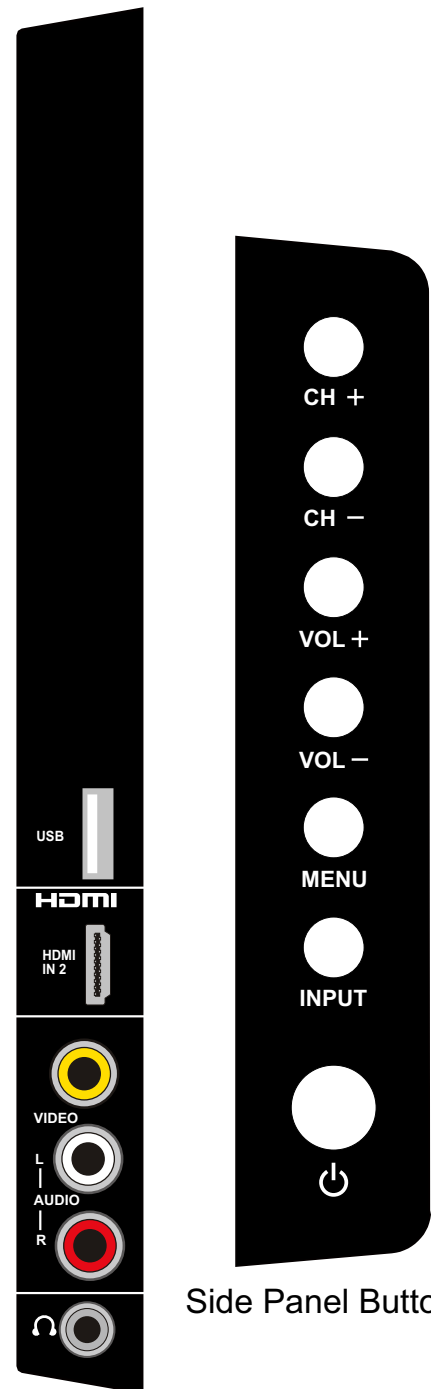

Side AV

Side Panel Button

Obtain the Signal

The first step in connecting your TV is obtaining the signal. The back panel of your TV allows you to receive analog and/or digital channels by using the **ANTENNA/CABLE INPUT**.

Before you connect your TV, you have to determine whether you will be using an antenna or a cable service to obtain the signal.

What You Need

Antenna (Rabbit Ears) Or Outdoor Antenna with Coaxial Cable

Plug the antenna or coaxial cable from the wall outlet into the **ANTENNA/CABLE IN** on the back of the TV. You are ready to receive off-air local digital and analog channels.

Cable Service

Plug the coaxial cable from the wall outlet into the **ANTENNA/CABLE IN** on the back of the TV. You are ready to receive your cable channels.

Set-Top Box

If you have a set-top box, you may need to call your cable company or satellite service provider. They may recommend special cables to allow you to view digital channels.

What You Need to Know

- Visit www.antennaweb.org for help in deciding what type of antenna to use in order to receive the local digital channels available to you. Enter your location, and the program will list local analog and digital stations available using your antenna.
- When you watch TV, the **Channel Banner** displays the type of channel currently viewed.

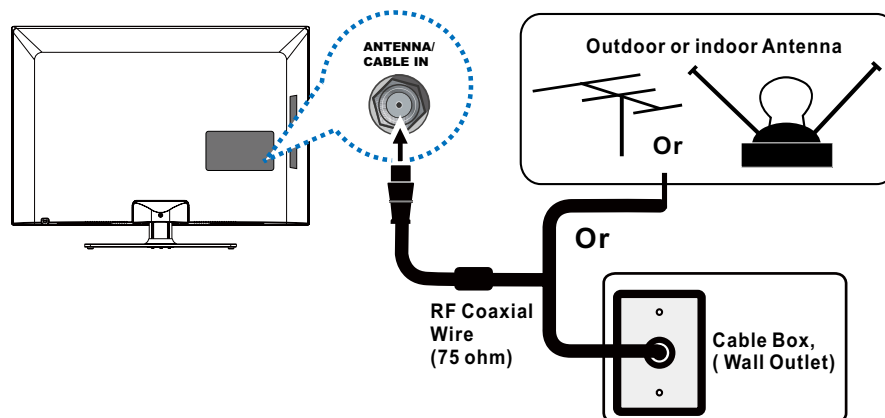





Connect the RF coaxial cable on your home outlet to the **ANTENNA/CABLE IN** jack of this unit.

Once all connections are complete, turn on the unit and begin the initial setup process, scanning for channels in your area.

Choose Your Connections

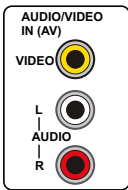
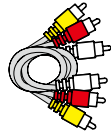
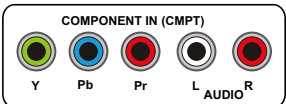
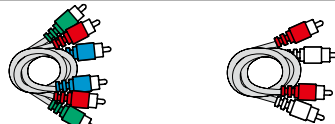
There are several ways to connect components, such as DVD players and set-top boxes, to your TV. Please use the following chart to determine which connections are best for you. Proceed to the appropriate pages to connect your components.

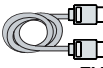
Note: No cables are supplied with this unit. Please purchase the necessary cables. A high-speed HDMI cable is recommended for better compatibility.

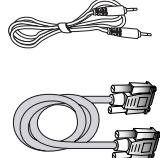
Jacks Used	Cable Needed	Go to...
 <p>VIDEO L AUDIO R</p> <p>Video Audio L and R</p>	 <p>Audio/Video</p>	page 12
 <p>Y Pb Pr L AUDIO R</p> <p>Y Pb Pr Audio L and R</p>	 <p>Component Video Audio</p>	page 12
 <p>HDMI/DVI IN 1 DVI/PC AUDIO IN</p> <p>HDMI/DVI Audio</p>	 <p>HDMI™ OR</p>  <p>HDMI™ + HDMI/DVI Adapter + Audio</p>	page 13
 <p>DVI/PC AUDIO IN VGA</p> <p>Audio VGA</p> <p>PC IN</p>	 <p>Audio VGA</p>	page 14

HDMI, the HDMI logo, and High-Definition Multimedia Interface are trademarks or registered trademarks of HDMI Licensing LLC.

Input	Signal Compatibility
Antenna/Cable	480i, 480p, 720p, 1080i (NTSC, ATSC, and QAM formats)
Composite Video	480i
Component Video	480i, 480p, 720p/60Hz, 1080i/60Hz, 1080p/60Hz
HDMI	480i, 480p, 720p/60Hz, 1080i/60Hz, 1080p/60Hz
PC	VGA SVGA XGA

Composite Video Connection (Good)

To connect a component with a video output jack, such as a DVD player, follow these steps:

Example: DVD Player

1. Connect your cable and/or off-air antenna as described on page 10.
2. Connect the yellow video cable to the **(AV2) VIDEO** jack on the side of the TV and to the video output jack on the DVD player.
3. Connect the red and white audio cables to the **(AV2)** right and left audio jacks on the side of the TV and to the audio output jacks on the DVD player.
4. Turn on your TV; then turn on the DVD player.
5. Press the **INPUT** button on the remote control to open the Input list. Once open, press the **INPUT** button repeatedly to select **AV2**.

Note: same operation for connection to the **AV1** on the back of the TV.

This is an example of a connection using the composite video jack.

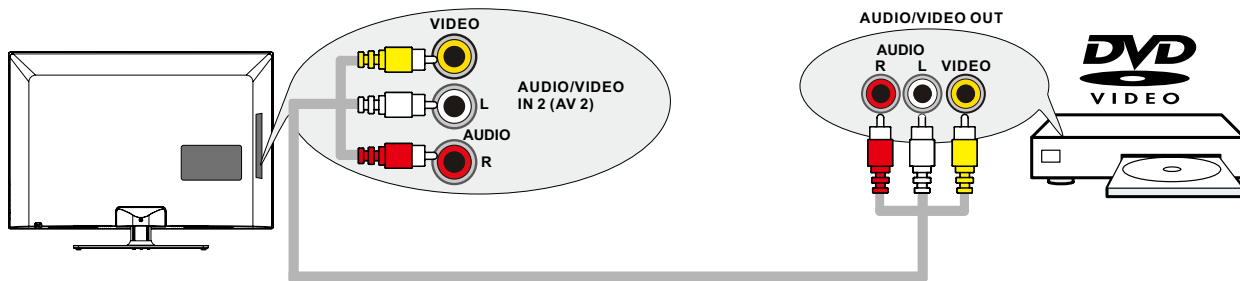

Component Video Connection (Better)

Component video connection offers better picture quality for video devices connected to the unit. To connect a component that has Y Pb Pr jacks, such as a DVD player, follow these steps:

Example: DVD Player

1. Connect your cable and/or off-air antenna as described on page 10.
2. Connect three video cables or special Y Pb Pr cables to the **COMPONENT IN 1 (CMPT 1)** Y Pb Pr jacks on the back of the TV and to the Y Pb Pr outputs on the DVD player.
3. Connect your red and white audio cables to the **COMPONENT IN 1 (CMPT 1)** R and L AUDIO jacks on the back of the TV and to the audio output jacks on the DVD player.
4. Turn on your TV; then turn on the DVD player.
5. Press the **INPUT** button on the remote control to open the Input list. Once open, press the **INPUT** button repeatedly to select **CMPT1**.

Note: same operation for connection to the **COMPONENT IN 2 (CMPT 2)** on the back of the TV.

This is an example of a connection using the component video jacks.

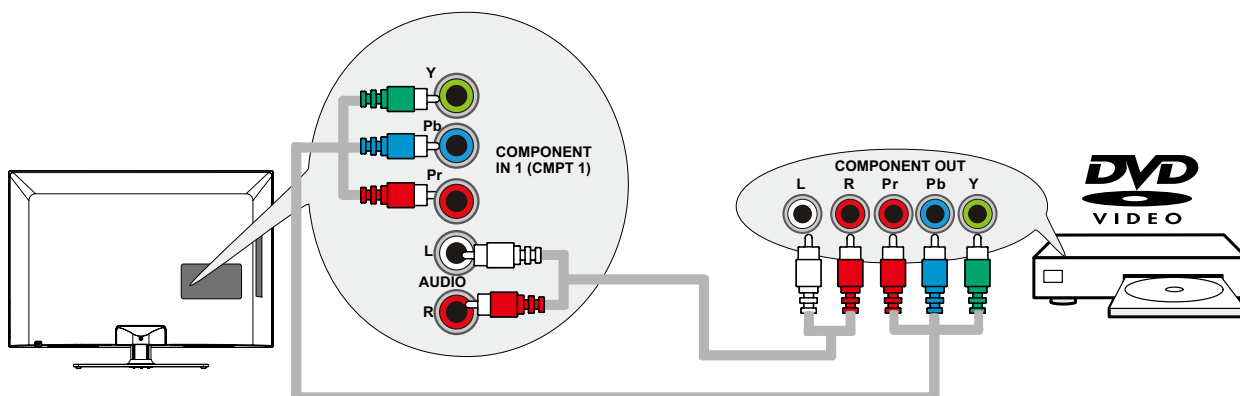

HDMI Connection (Best)

High-Definition Multimedia Interface (HDMI) technology is an uncompressed digital connection that carries both video and audio data by way of an integrated mini-plug cable.

Example: Component with HDMI jack.

1. Connect an HDMI cable to the **HDMI IN 2** jack on the side of the TV (or the **HDMI/DVI IN 1** jack or **HDMI IN 3** jack on the back of the TV) and to the HDMI output jack on the component.
2. Turn on your TV; then turn on the component.
3. Press the **INPUT** button on the remote control to open the Input list. Once open, press the **INPUT** button repeatedly to select **HDMI 2** (or **HDMI 1** or **HDMI 3**).

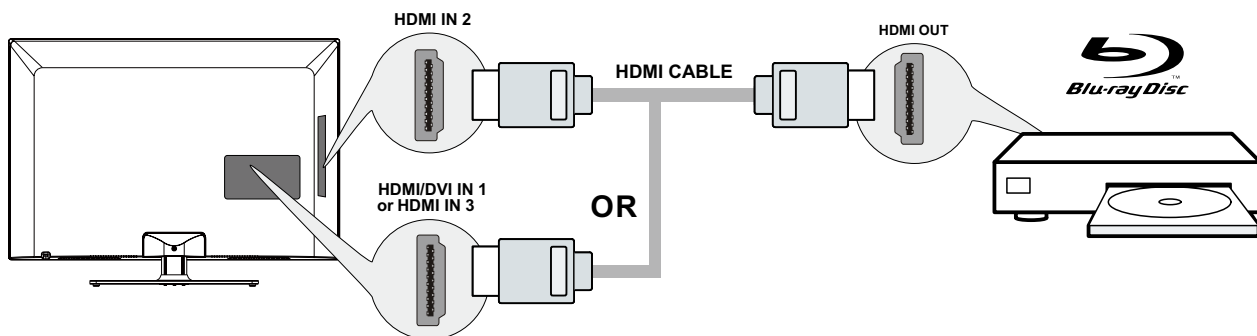

HDMI/DVI Connection

Since HDMI technology is based on Digital Visual Interface (DVI), the jack on the back of your TV is also compatible with components that have a DVI output jack.

Example: Personal Computer (PC)

1. Connect an HDMI cable to the **HDMI/DVI IN 1** jack on the back of the TV.
2. Attach an HDMI/DVI adapter on the other end of the HDMI cable, then connect it to the DVI output jack on the PC.
3. Since you're using an HDMI/DVI adapter, you need to connect a separate audio cable to the **DVI AUDIO IN** jack on the back of the TV and the audio output jack on the PC.
4. Turn on your TV; then turn on the PC.
5. Press the **INPUT** button on the remote control to open the Input list. Once open, press the **INPUT** button repeatedly to select **HDMI 1**.

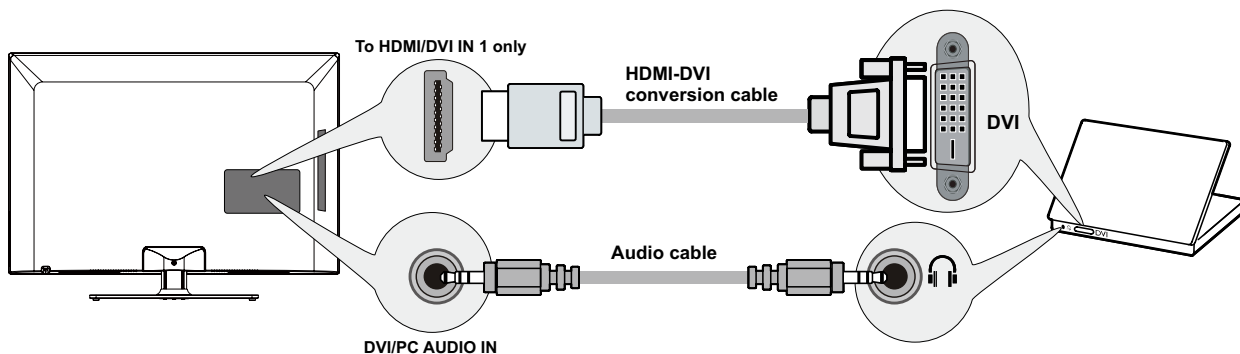

Don't forget:

If necessary, connect antenna or cable to get a picture. Go to page 10 for instructions.

PC Connection

To connect a personal computer and use your TV as a monitor, follow these steps:

1. Connect one end of a 15-pin monitor cable (VGA cable) to the **PC IN VGA** jack on the TV and the other end to the PC's video output jack.
2. Connect an audio cable to the **PC AUDIO IN** jack on the back of the TV and the other end to the audio output jack on the PC.
3. Turn on your TV; then turn on the PC.
4. Press the **INPUT** button on the remote control to open the Input list. Once open, press the **INPUT** button repeatedly to select **PC**.

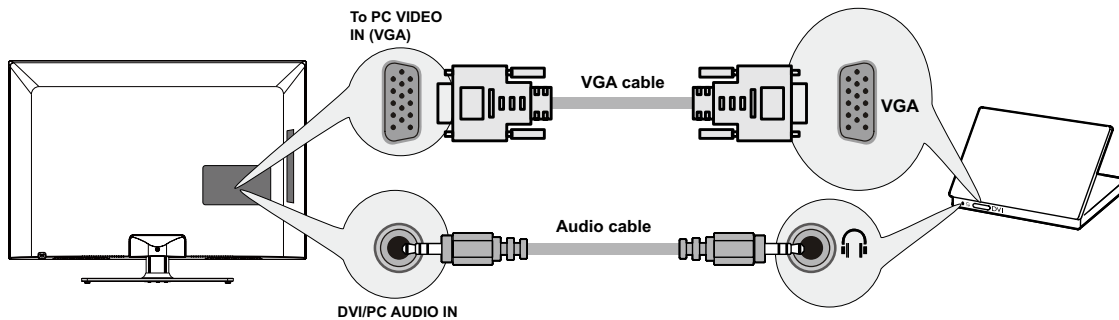



Plug in the TV

Plug the end of the power cord into an outlet, inserting the plug completely. Do not plug the TV into an outlet controlled by a light switch.

Put Batteries in the Remote





- Remove the battery compartment cover from the back of the remote control by pushing the tab and lifting off the cover.
- Insert 2 AAA batteries, making sure the polarities (+ and -) are aligned correctly.
- Replace the cover.

Turn on the TV

Turn on your TV by pressing the  button on the TV or the  button on the remote control.

Using the Remote Control to Complete the Initial Setup

You will need to use the remote control to complete the setup of your TV. The remote control allows you to navigate through and select items that appear in the on-screen menus. The process works the same on all menu screens: highlight your choice and select it.

To highlight an item in the menu list, press the up or down arrow (/) to move up or down. Use the left or right arrows (/) to view other selections for the highlighted menu choice or to display a sub-menu.

Note: *Highlighted items stand out from other menu items on the list (appear darker, brighter, or a different color).*

Complete the Initial Setup

The menu system in your TV allows all of the TV's features to work properly. The first time you turn on your TV, the Initial Setup Wizard opens, which guides you through the setup process, including Language, TV Location, Time Zone, Tuner and Channel Scan.

Set the Menu Language

The first step of the setup requires you to select your preferred language for the menu system. If **English** is your preferred language, press the **OK** button on the remote control. To select another language use the down arrow button (▼) until that language is selected then press **OK** or the right arrow button (▶) to proceed to the next screen.



Set the TV Location Mode

After choosing the language, a menu screen asks you to set the TV Location.

- Choosing "**Home**" for the TV Location assigns the optimal picture settings for most home environments.
- Choosing "**Retail**," which is not Energy Star compliant, sets the unit up with predefined settings for retail displays. In this setting, the power consumption may exceed the requirements of the Energy Star® qualification.

Use the up or down arrow (▲/▼) to select the desired location setting (**Home/Retail**); then press the **OK** button or right arrow (▶) to continue to the next screen.

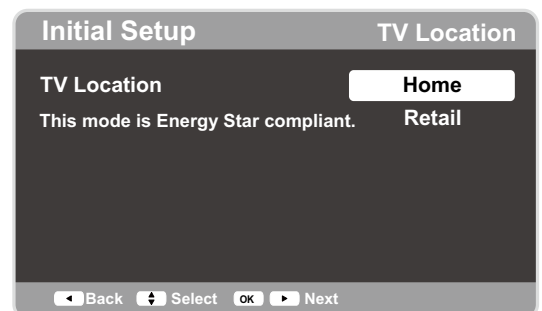

Set the Time Zone

Use the up or down arrows (▲/▼) to select the current local time zone. Press the **OK** button or right arrow (▶) to continue to the next screen.

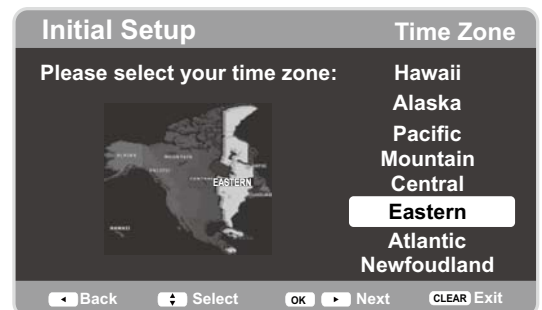

Auto Channel Scan

1. On the **Tuner** screen, select either **Antenna** or **Cable**. Press the **OK** button or right arrow (▶) to continue to the next screen.

Note: If you are using a satellite or cable set-top box, you do not have to complete the Channel Search.

2. The **Channel Scan** screen is now displayed. The default choice is to scan. Press the **OK** button or the right arrow (▶) to begin the channel scan for available channels to be stored in the TV's memory.

Note: If you do not want to scan for channels at this time, press the **OK** button or right arrow (▶) to stop the scanning process.

3. The screen will change to show the progress of the scanning process.
4. When the scanning is finished, the unit has completed the Initial Setup.
5. Press **CLEAR** to exit the Wizard and begin watching TV.

Skip Scan

If you select to skip the Auto Scanning process by choosing **Skip Scan** or by pressing the **CLEAR** button, you will need to follow this process the next time you decide to complete this procedure.

1. Select the **TV** as input (using the **INPUT** key).
2. Go through the menu options to select the **Signal Type**, which will display the option of scanning the channels again.
3. If you are using a satellite or cable set-top box, you do not have to complete the Channel Search.

Note: See the **Setup** Menu to:

- Scan channels automatically again (page 23).
- Add desired channels not memorized by the Channel Scan (page 24).
- Reset the time zone (page 27).

See the **Language** Menu to:

- Change to another language (page 32).

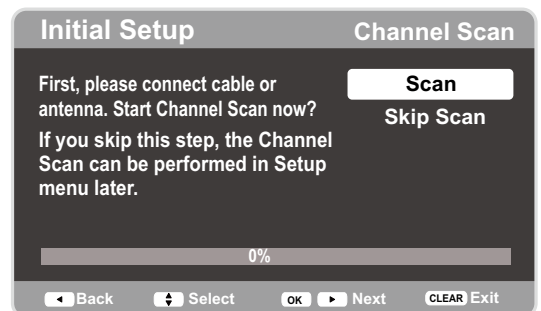
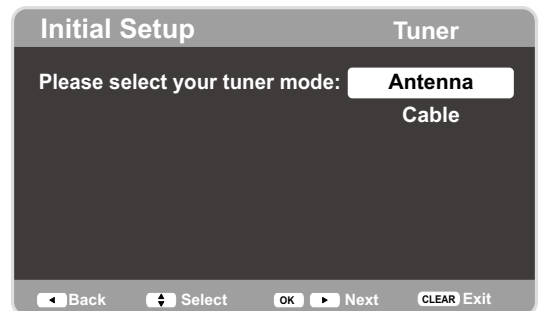

Chapter 2 - Understanding the Basics

Turning the TV On and Off

1. Plug the power cord from the TV into an AC power outlet.
2. Press **⏻** to turn on the TV.
3. Press **⏻** to turn off the TV. When you turn the TV off, it automatically goes into Standby Mode.

Note: When your TV is in Standby Mode, it is still receiving some power. To completely disconnect the power, unplug the power cord.

Selecting the Video Input Source

1. Turn on the TV; then, press **INPUT** on the remote control. The INPUT list appears.
2. To select an input source, press the **INPUT** button repeatedly or use the up and down arrows (**▲/▼**) to highlight the video source and press **OK** to select.

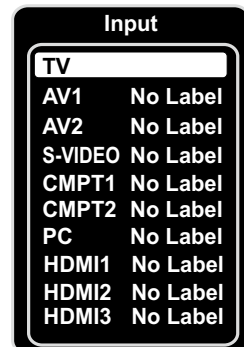

Selecting a Channel

1. Select the desired channel by using the **CH+/-** or the numeric keypad. The **CH+/-** can select only memorized channels. Select non-memorized channels using the numeric keypad.
2. To use the numeric keypad:
 - Analog TV Channels** – When selecting an analog channel, such as channel 12, press the 1, then the 2, then press **OK**.
 - DTV** – When selecting digital channels, such as 12.3, be sure to press the dot (•) in the appropriate place. So, for 12.3, you would press 1, then 2, then dot, then 3. Press **OK** to select.
3. Press **GO BACK** to return to the previously viewed channel.

What is a Sub-channel?

A sub-channel is a channel such as 12.3. By using high-compression technology, digital broadcasting enables multiple signals to be sent simultaneously. Therefore, you can select more than one program per main channel, since digital broadcasting technology can distinguish between multiple channels on a single network.

Adjusting/Muting the Volume

1. Use the **VOL +/-** to adjust the volume. The volume bar will be displayed at the bottom part of your TV screen when you are adjusting the volume. The volume bar disappears a few seconds after you have completed the adjustment.
2. Press **MUTE** to turn the sound on and off. The MUTE mark is displayed on the TV screen for a few seconds.
3. When you press **MUTE** again, the volume reverts to its previous level. Or you can press the **VOL +** to cancel the mute function.

Screen Formats

Screen format refers to the way the picture is displayed on your TV. Press the **ZOOM +/-** button on your remote to see if a different format is available for the video you are viewing. The format changes as you press the **ZOOM +/-** button, and the format type is displayed at the bottom left of the screen.

Analog video is sent in a 4/3 format, which your TV displays in a 16/9 format. Most digital video is sent in a 16/9 format which fills your screen, but it sometimes is sent in 4/3, which does not fill your screen. It depends on how the station or component connected to your TV is formatting the video. If there are bars on the screen, press the **ZOOM +/-** button to try a different format that may eliminate the bars. Some bars can't be removed because of the way the format is sent by the broadcaster. Press **ZOOM +/-** repeatedly to cycle through the available display formats.

Examples of the different formats appear below. Each format is available for analog video, but it might not be available for digital video.

Note: For HD Video, press **ZOOM +/-** to choose from Full, Expand, Normal and Zoom. For HDMI and CMPT inputs, there is also a No Overscan format.

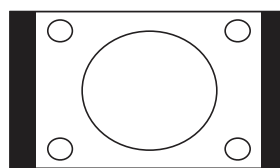

Normal

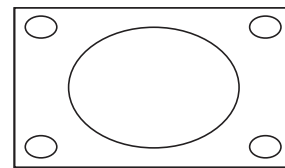

Full

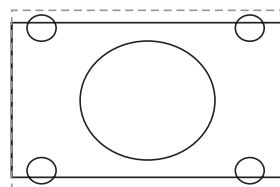

Cinerama

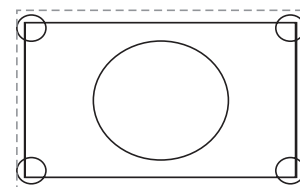

Zoom

Channel Banner

There are several indicators that may appear when you press the **INFO** button on the remote control. This display is called the **Channel Banner**. The following list describes the items on the **Channel Banner** screen.

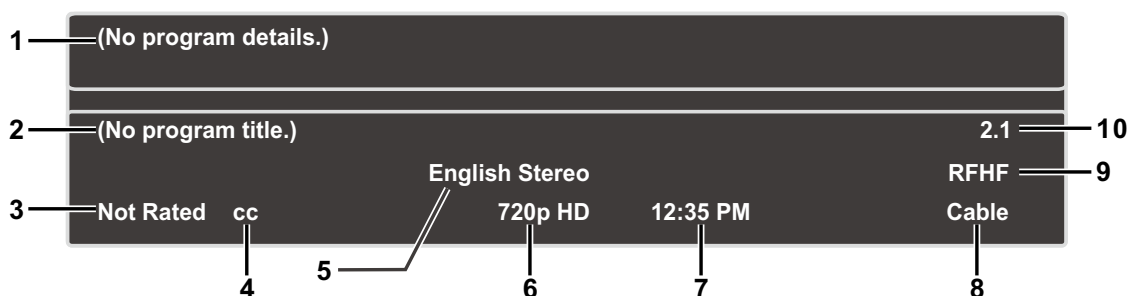

- 1. Program Guide** – The term “No program details” is displayed when no program guide is available.
- 2. Program Title**
- 3. Rating Information** – This displays the rating of the current program.
- 4. Closed Captioning** – This tells whether or not Closed Captioning is available for the current program.
- 5. Audio Language**
- 6. Effective Scanning Lines** – Displays Scanning mode (720p) and digital TV format (HD)
- 7. Current Time**
- 8. Signal Type**
- 9. Channel Name, if available**
- 10. Channel Number**

Chapter 3 - Using the Remote Control

Remote Control Buttons

- 1. INPUT** – Press the **INPUT** button to open the **Input** list; then press the **INPUT** button repeatedly to select the video input, or press the up and down arrows (▲/▼) to highlight options, and press **OK** to select the desired option.
- 2. Alphanumeric Buttons** – Using these buttons, enter channel numbers. To enter a channel, press the number buttons and press **OK** (or let the entry timeout).
To enter a digital channel with a sub-channel, enter the main channel; then, press the dot (•), the sub-channel, and then the **OK** button.
- 3. MENU** – Press the **MENU** button to display the Main Menu.
- 4. Arrows (▲/▼/◀/▶)** – Use the four arrows to highlight different items in the TV menu and to adjust the menu controls.
ZOOM +/- (◀/▶) – Press to select the desired screen format.
SLEEP +/- (▲/▼) – Press to set the TV to turn off after a given amount of time.
- 5. PIC** – Press to select your desired picture mode.
- 6. INFO** – If no menus are currently active, press the **INFO** button to display the **Channel Banner**.
- 7. VOL +/-** – Increases or decreases the TV volume.
- 8. MUTE** – Press to turn the volume on and off.
- 9. FAV** – Press the **FAV** button to browse the channels in your favorite list. Use the up and down arrows (▲/▼) to highlight options, then press **OK** to select. Or, press the **FAV** button repeatedly to cycle through your favorite channels.
- 10. MEDIA** – Press the **MEDIA** button to enter the USB menu directly.
- 11. POWER (⏻)** – Press the **POWER** button to turn the TV on and off.
- 12. GUIDE** – Press the **GUIDE** button to display the program guide. Program guide details are only available on digital channels.
- 13. CLEAR** – Press the **CLEAR** button to remove any menu or display from the screen and return to normal viewing.
- 14. OK** – Press to display Channel List menu. When the TV is in the Menu system, press the **OK** button to confirm your selection.
- 15. GO BACK** – Pressing the **GO BACK** button returns you to the previously viewed channel.
- 16. CH + or CH -** – Press the **CH +/-** buttons to select channels and external input mode.
- 17. TV** – Press to access to the TV mode.
- 18. MTS** – Press to select your desired sound mode.
- 19.** These buttons can be used for playing music and photos in the USB menu.

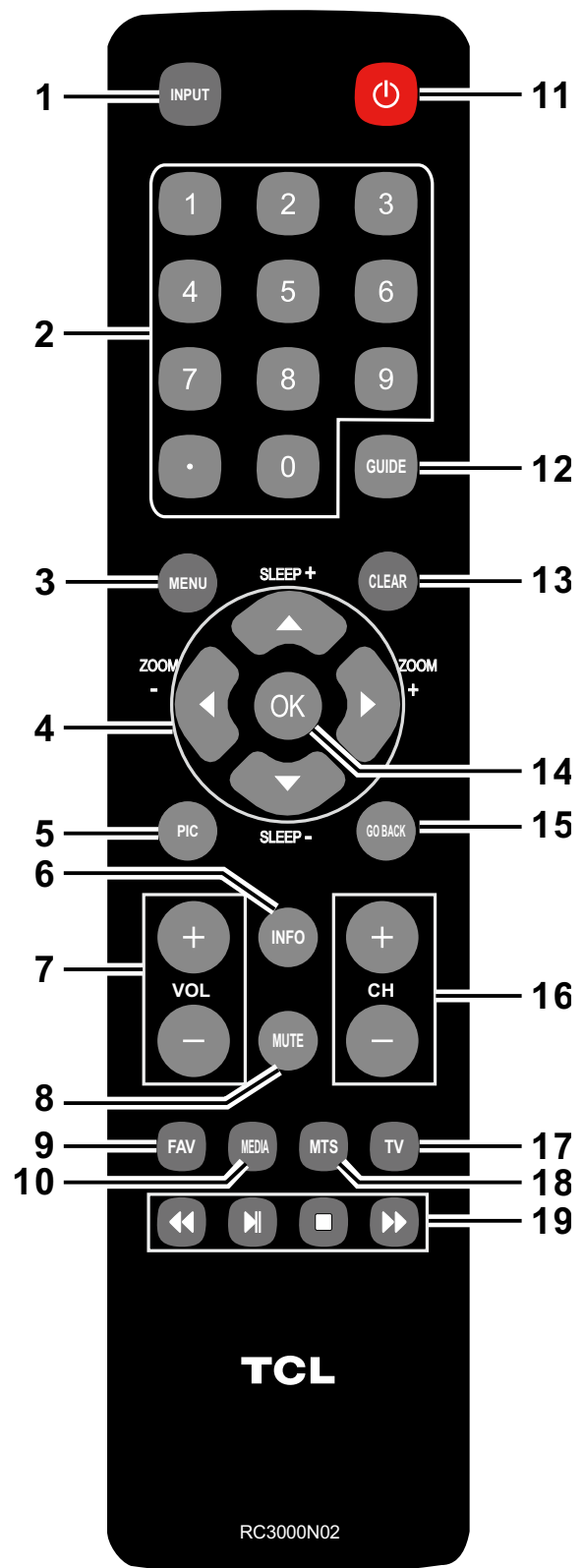

Chapter 4 - Using the TV Menu

Using the Menu System

This section explores the menus of your TV. Each menu is outlined and detailed to help you get the most from your TV. To access the menu system, follow these steps:

1. Press the **MENU** button to open the main menu.
2. Use the up and down arrows (▲/▼) to highlight an option and press the **OK** button or the right arrow (▶) to enter its sub-menu.
3. Press the up and down arrows (▲/▼) to highlight an item; then press the left or right arrows (◀/▶) to adjust the selected items, or press the left or right arrows (◀/▶) to enter the next screen.
4. Press the **OK** button to confirm your selections.
5. Press the **MENU** button to return to the previous screen, or press the **CLEAR** button to close the menu.

Note:

Use the text at the bottom of the screen to assist you. Descriptions of each menu are discussed in the order they appear.

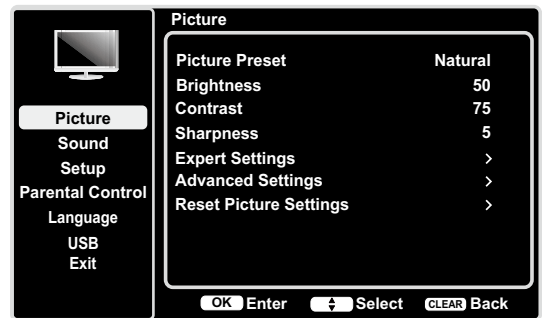

Picture Menu

The **Picture** Menu contains menus and controls to configure the way the picture appears. The **Picture** Menu options apply to the video for the main TV and VIDEO INPUT selections.

To access the **Picture** Menu, press the **MENU** button on the remote to open the Main menu. Press the up or down arrow (▲/▼) to select **Picture**; then press the **OK** button or the right arrow (▶) to display options.

Picture Settings:

Picture Preset - Displays a list that lets you select one of the preset picture settings: **Natural**, **Sports**, **Personal** or **ECO**, **Vibrant**, **Cinematic**. Choose the setting that is best for your viewing environment.

Note: *ECO is the default setting, if you select some other options, the power consumption may change.*

Brightness - Adjusts the brightness of the picture. This function is able to be adjusted only when **Light Sensor** and **Dynamic Backlight** in the **Advanced Settings** are both turned off.

Contrast - Adjusts the difference between the light and dark areas of the picture.

Sharpness - Adjusts the crispness of the edges in the picture.

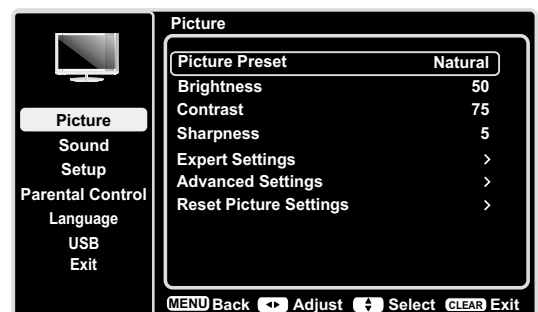

Expert Settings

Backlight -Adjusts the backlight level. the menu line is grayed out by default. Only when “**Dynamic Backlight**”and “**Light Sensor**” are both set to “**Off**”, the menu line can be adjustable.

Color - Adjusts the richness of the color.

Tint - This option adjusts the balance between the red and green levels.

Color Temperature - Adjusts the color temperature from cool to warm.

Advanced Settings

Light Sensor – When activated, this feature monitors the ambient light conditions in the room and adjusts the TV’s backlight for optimum viewing. It also serves as an energy-saving feature by lowering the backlight power level when appropriate (typically in darker conditions).

Dynamic Backlight – This option automatically adjusts the brightness of the backlight according to the content of the incoming signal. **Dynamic Backlight** optimizes the picture quality and decreases power consumption.

Note: When **Light Sensor** or **Dynamic Backlight** is set to **Off**, the power consumption may exceed the requirements of the Energy Star® qualification.

Noise Reduction – This setting reduces picture “static” or any type of interference. This feature is especially useful for providing a clearer picture in weak analog signal conditions. Choose between these options:

Low for a softer, smoother picture that retains picture sharpness and detail.

Middle for a slightly softer picture than the Low setting.

High for an even softer, smoother picture than the other settings (the picture detail is somewhat decreased).

PC Settings - This option allows you to adjust the PC settings when in PC mode.

Reset Picture Settings - This function allows you to reset all the picture settings to the factory default settings.

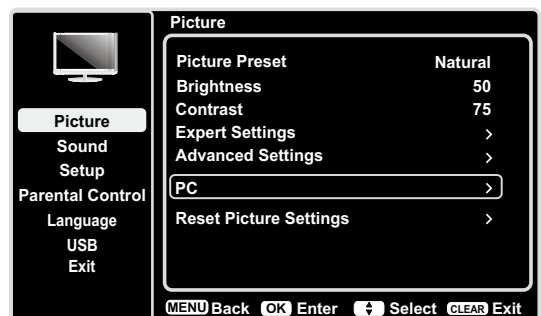
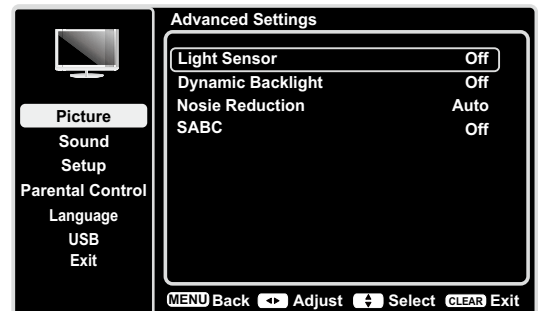
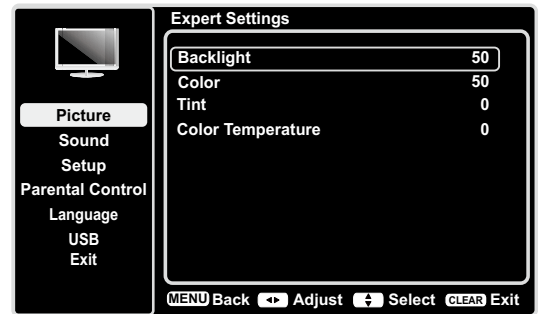

Only in PC mode

Sound Menu

The **Sound** Menu lets you adjust audio output. To access the **Sound** Menu, press **MENU** on the remote, and then use the up and down arrows (▲/▼) to highlight **Sound** from the Main Menu. Press the **OK** button or right arrow key (▶) to select. The following options will be displayed:

Equalizer – The five-band equalizer allows you to adjust the audio frequency settings. You can select one of the five preset options or create a custom preset.

- **Equalizer** – Allows you to choose a specific sound preset: **Standard, Music, Voice, Movie, and Personal**.
- **Frequency Range** – Displays the different graphic equalizer names set for each sound preset option. Choose a band and make adjustments. When making adjustments, the **Equalizer** option automatically changes to **Personal**. Press the left or right arrow (◀/▶) to select the desired frequency (100Hz, 300Hz, 1KHz, 3KHz, 10KHz) you wish to adjust. Use the up and down arrows (▲/▼) to adjust the level. When you have finished adjusting the levels, press the **MENU** button to exit.

Balance – Adjust the amount of audio sent to the left and right speakers.

Surround – Option **On/Off**. When turned on, this option enables a mode which simulates a surround sound effect.

Speaker – Option **On/Off**. When you select the Off option, the sound speaker on the TV will be turned off.

SPDIF Type – This option controls the type of audio stream sent to the Digital Audio Output jack. Available options are **Dolby Digital(AC3), PCM, or Off**.

Auto Volume Control – Option **On/Off**. This option reduces the annoying blasts in volume that often occur during commercial breaks, and also amplifies softer sounds in program material, eliminating the need for constant volume adjustment.

Analog TV Sound – This option controls the manner in which the sound comes through your speakers. Options available vary according to the input selected.

- **Mono (available for regular TV viewing only)** – This option plays the sound in mono only. Use this setting when receiving broadcasts with weak stereo signals.
- **Stereo** – This option splits the incoming stereo audio signal into left and right channels. Most TV programs and recorded materials have stereo audio. The word “Stereo” appears in the **Channel Banner** when you tune to a program that is broadcast in stereo.
- **Second Audio Program (SAP)** – This option plays the program’s audio in a second language, if available. The letters “SAP” appear in the Channel Banner when you tune to a program that is broadcast with SAP information. SAP audio is broadcast in mono only. SAP is also used to broadcast a program’s audio with descriptions of the video for the visually impaired.

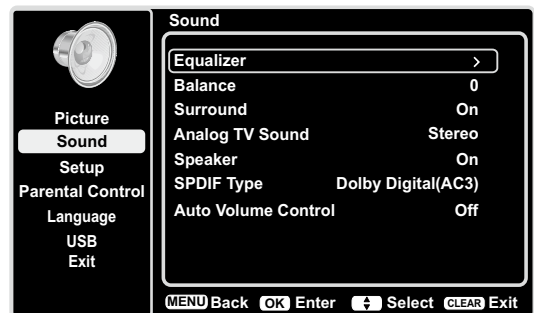

only available for analog channels

Default Audio Language – Choose the language you prefer for dialog on digital channels. If the preferred language is not broadcasted with the program, then the TV plays the default audio for the program (usually **English** in the US). There are 3 available default languages (**English, French, Spanish**).

Current Audio Language – Press the left or right arrow (◀/▶) to choose from the list of languages available for the program you're watching. The language chosen becomes your preferred language for all digital channels until you turn the TV off. If the language chosen is not being broadcasted with a program, the TV plays the default language for the program (usually English in the US).

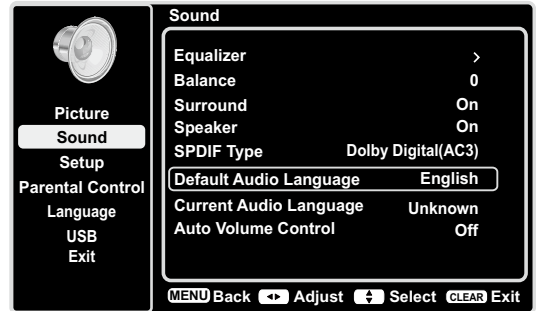

only available for digital channels

Setup Menu

The **Setup** Menu allows you to configure the TV with your preferences. Press **MENU** on the remote to open the Main Menu. Press the up and down arrows (▲/▼) to select **Setup**; then press the **OK** button or the right arrow (▶) to display the following options:

Signal Type

Choose the type of signal (**Cable/Antenna**) you have connected to the **ANTENNA/CABLE IN**.

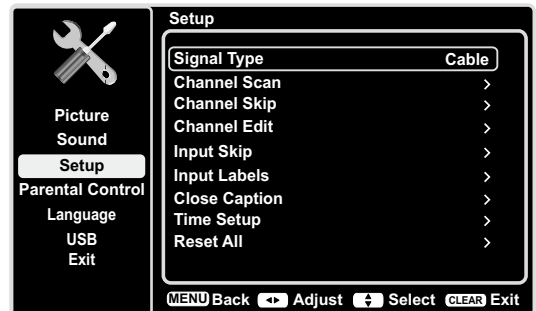

Channel Scan

When you perform a Channel Scan, your TV searches for channels with signals and stores the channel information in the Channel List. Then, as you watch TV and press **CH+** or **CH-**, your TV goes to the next or previous channel in the Channel List and skips the channels that do not have signals.

If the TV signal source changes – for example, if you change from an outdoor antenna to cable TV – you will need to rescan for channels.

To automatically scan for channels:

1. After choosing a signal type, press the up or down arrow (▲/▼) to highlight **Channel Scan**.
2. Press the left or right arrow (◀/▶) to start the scan. You can see the search progress and how many channels are found in the on-screen menu. (**Note: If you wish to stop the search, press the CLEAR button.**)
3. After the scan is complete, press the **OK** button to restart scan, or press the **MENU** button to return to the previous menu, or press the **CLEAR** button to close the menu.

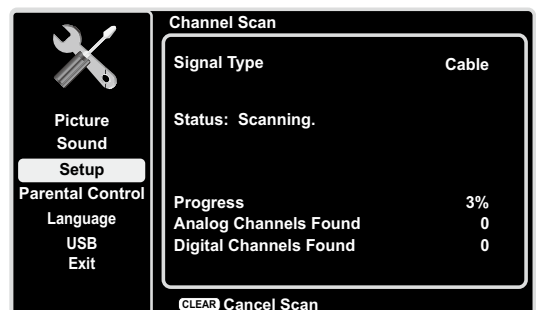
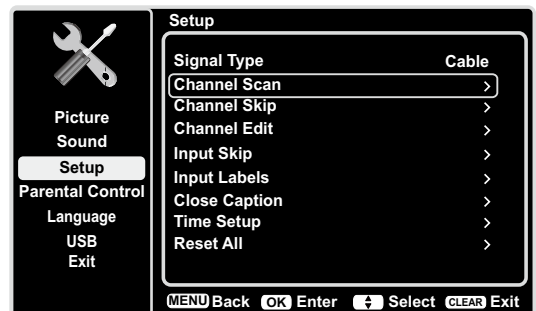

Channel Skip

You can hide channels in the Channel List. Then, when you press the **CH+** or **CH-** button, the TV will skip the hidden channels. You can still tune to these hidden channels by pressing the number of the channel on the numeric keypad.

To hide specific channels:

1. In the **Setup** Menu, press the up or down arrow (▲/▼) to highlight **Channel Skip**.
2. Press the **OK** button or the right arrow (▶) to open the **Channel Skip** screen.
3. Press the up or down arrow (▲/▼) to highlight the channel you wish to skip; then press the **OK** button to check the highlighted channel. You can add the channel back into the Channel List by highlighting it and un-checking it.
4. Repeat the process to hide additional channels.
5. Press the **MENU** button to return to the previous menu, or press the **CLEAR** button to close the menu.

Channel Edit

The **Channel Edit** function allows you to add or change a channel label, only for analog channels. You cannot change the name on digital channels.

To edit an analog channel name:

1. In the **Setup** Menu, press the up or down arrow (▲/▼) to highlight **Channel Edit**.
2. Press the **OK** button or the right arrow (▶) to open the Channel List screen.
3. Press the up or down arrow (▲/▼) to highlight the channel you wish to label or edit.
4. Press the **OK** button to enter the **Channel Edit** screen.
5. The **Channel Name** will be highlighted, press the **OK** button to start editing.
6. Use the left or right arrow (◀/▶) to select the input field, use the up or down arrow (▲/▼) to enter the name for the channel.
6. Press the **OK** button to confirm and save the new label.
7. Press the **MENU** button to return to the previous menu, or press the **CLEAR** button to close the menu.

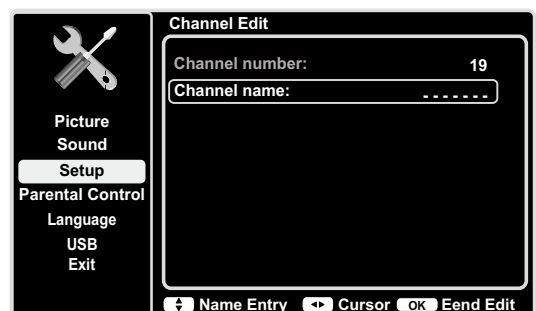
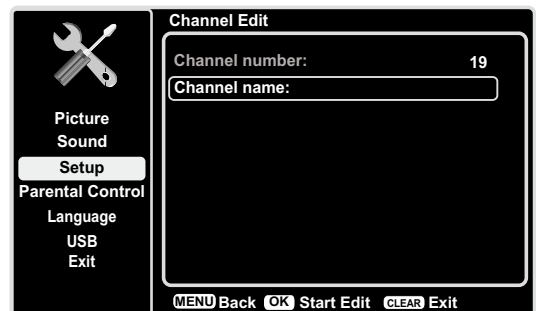
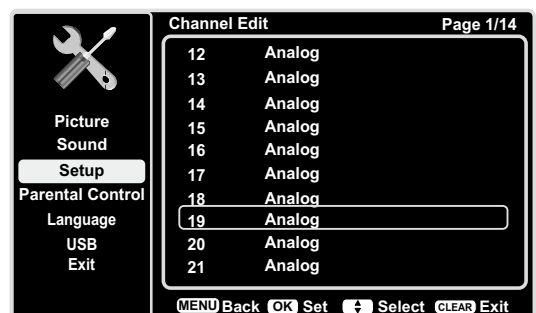
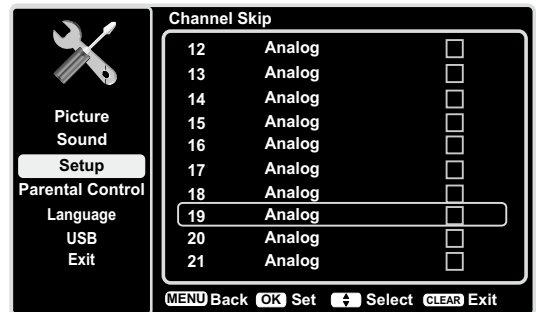

Input Skip

You can hide video inputs in the Channel List. This option allows you to remove the inputs from the Channel List so you do not encounter them when channeling up or down. Once you have hidden inputs, the TV will skip these inputs when you press the **CH+** or **CH-** button.

To hide video inputs:

1. In the **Setup** Menu screen, press the up or down arrow (▲/▼) to highlight **Input Skip**.
2. Press the **OK** button or the right arrow (▶) to open the Input Lists screen.
3. Press the up or down arrow (▲/▼) to highlight the video input you want to hide.
4. Press the **OK** button to check the highlighted input. You can add an input by highlighting it and un-checking it.
5. Repeat the process to hide additional video inputs.
6. Press the **MENU** button to return to the previous menu, or press the **CLEAR** button to close the menu.

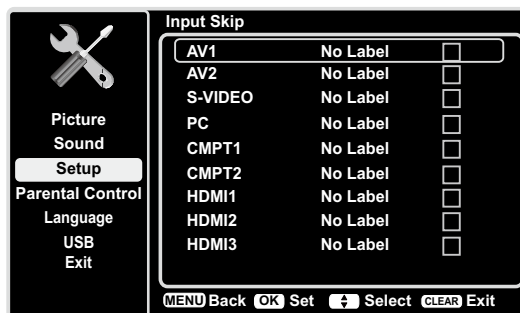

Input Labels

You can add a label to a video input source to make it easier to identify.

1. In the **Setup** Menu, press the up or down arrow (▲/▼) to highlight **Input Labels**.
2. Press the **OK** button or the right arrow (▶) to open the **Input Labels** screen.
3. Press the up or down arrow (▲/▼) to highlight the input source you wish to label.
4. Press the left or right arrow (◀/▶) to select the label for this source.
5. Press the **MENU** button to return to the previous menu, or press the **CLEAR** button to close the menu.

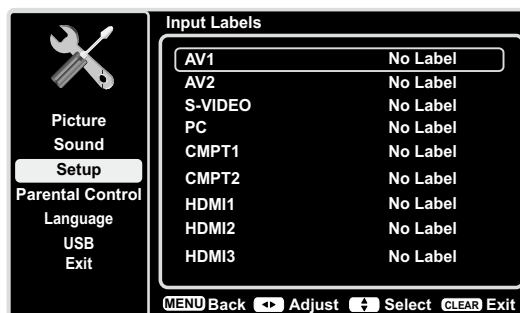

Closed Caption

Many programs are encoded with closed captioning information, which allows you to display the audio portion of a program as text on the TV screen

Note: Closed caption settings are not available for HDMI, CMPT or PC INPUTS. These settings must be set in the connected component's menu. Closed captioning is not available on all channels at all times. Only specific programs are encoded with closed captioning information. When a program is closed captioned, CC is displayed in the **Channel Banner**. See page 18 for more information about the **Channel Banner**.

The Closed Caption options are:

CC Setting – This option allows you to choose the way closed captioning information appears on the screen.

Off - No captioning information displayed.

On Always – Choose this option if you want captioning information to be shown whenever available.

On When Muted – This option allows the closed captioning to display (when available) whenever the TV's sound is muted. The captioning information is not displayed when the sound is not muted.

Analog CC Type – This option lets you select the captioning mode used for displaying caption information, when available. If you are unsure of the differences among the modes, you may prefer to leave the closed captioned mode set to CC1, which displays complete text of the program in the primary language in your area.

Digital CC Type If available, this allows you to select a closed caption service mode (1-6) for digital channels.

Digital CC Preset If available, this allows you to select between **Off** and **On** options. **On** mode allows you to set the options below.

Digital CC Style – This option lets you customize the following display options, if available:

Caption Style – Select either **As Broadcast** or **Custom** options. If you choose **Custom** options, the setting changes according to the options you choose.

Digital CC Size – Set the size of the digital closed caption text: **Default, Small, Standard or Large**.

Digital CC Font - Select a character design for the digital closed caption text. A font is a complete assortment of letters, numbers, punctuation marks, etc. in a given design. You can choose from a variety of fonts.(Default, Style 0-7).

Digital CC Background Color – Set the appearance of the area behind the digital closed caption text: Default, Black, White, Red, Green, Blue, Yellow, Magenta, or Cyan.

Digital CC Background Opacity – Set the appearance of the area behind the digital closed caption text: Default, Solid, Flashing, Translucent, or Transparent.

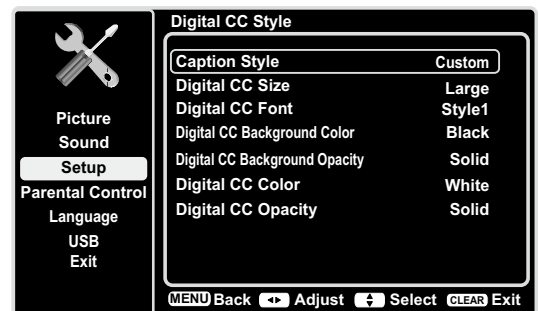
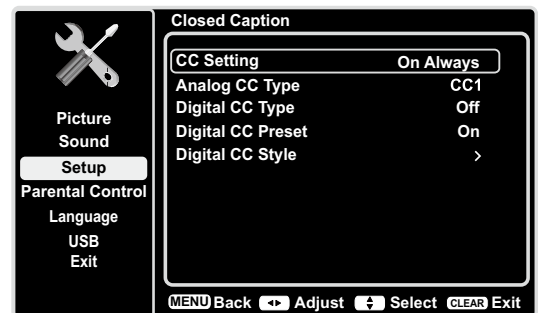

Note: These captioning style options only have an effect on true digital closed captions. Not all captioning on digital channels is digital captioning--it depends on what the broadcaster is sending. If the closed captioning for a program is not digital, the Digital CC style settings will not have an effect.

- Digital CC Color** – Choose the color of the digital closed caption text: Default, Black, White, Red, Green, Blue, Yellow, Magenta, or Cyan.
- Digital CC Opacity** – Set the appearance of the digital closed caption text: Default, Solid, Flashing, Translucent, or Transparent.

Time Setup

Time Zone

You can select the current local time. Options are: **Eastern, Atlantic, Newfoundland, Hawaii, Alaska, Pacific, Mountain and Central.**

To choose a time zone:

1. In the **Time Setup** Menu, press the up or down arrow (▲/▼) to highlight **Time Zone**.
2. Press the **OK** button or the right arrow (▶) to proceed to the next screen.
3. Press the left or right arrow (◀/▶) to select the time zone for your area.
4. Press the **MENU** button to go back to the previous screen, or press the **CLEAR** button to close the menu.

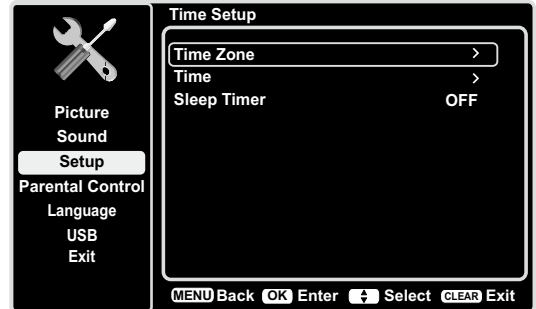

Time

To set the time:

1. In the **Time Setup** Menu, press the up or down arrow (▲/▼) to highlight **Time**.
2. Press the **OK** button or the right arrow (▶) to proceed to the next screen.
3. Options on this screen include:
 - a. **Auto Synchronization** – Press the left or right arrow (◀/▶) to choose **On** to acquire the time automatically from digital channels.
 - b. **Daylight Saving** – Select **Auto** or **off** for the Daylight Saving Time.
 - c. **Date** – When Date is highlighted, use (◀/▶) to select the input field, then press the **OK** button to start to input, again use (◀/▶) to set the date, finally press **OK** to confirm. (*Note: using the same way to set the time below*)
 - d. **Time** – Lets you set the time manually.
 - e. **Power On Timer** – Select **Once/Daily/Off**.
 - f. **Power On Time** – Allows you to set the time you want the TV to turn itself on.
 - g. **Power Off Timer** – Select **Once/Daily/Off**.
 - g. **Power Off Time** – Allows you to set the time you want the TV to turn itself off.

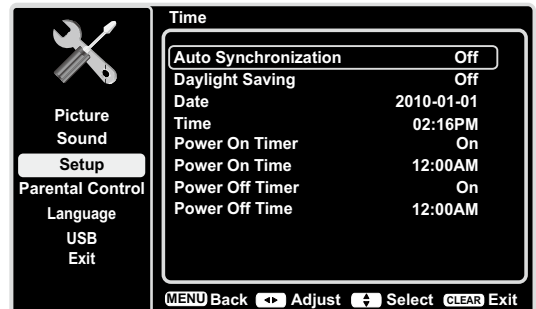

Sleep Timer – Press the left or right arrow (◀/▶) to set the TV to turn off after a given amount of time.

System Information – This option allows you to see the system information including Panel ID, SW Version, Service Model No..

Reset All

This option resets all settings (except parental control settings) to the factory defaults. When you select this option, a confirmation box opens (Note: If some channels are blocked, you must enter the V-chip password, then you can follow the operation below).

1. Press the left or right arrows (◀/▶) to select **OK** or **Cancel**.
2. Press the **OK** button to confirm.

Parental Controls and V-Chip

The choices in the US V-Chip and Canada V-Chip menus involve software inside your TV, referred to as V-Chip, which allows you to block TV programs and movies. TV programs can be blocked by age-based ratings, such as TV-MA (See page 30). If available, TV programs can also be blocked by content, such as adult language (L) (See page 30). Movies can only be blocked by age-based ratings (See page 31). Once you block programs, you can unblock them by entering a password. By default, the software inside your TV is turned off or unlocked. For instructions to lock V-Chip, see page 29.

V-Chip - US and Canada

V-Chip reads the program's age-based rating (TV-MA, TV-14, etc.) and content themes (Violence (V), Adult Language (L), etc.). If you have blocked the rating and/or content themes that the program contains, you receive a message that the channel is currently blocked. Change the channel or press **OK** to enter your password and temporarily deactivate the parental controls.

Broadcasters are not required to provide content themes, so programs received with no content themes are blocked only if you block their age-based rating. You can also block programs that have been given an Exempt rating, and programs that are considered unrated. See page 38 for the US and Canada ratings explanations.

Change V-Chip Password

The first time you enter the Parental Control menu, you must set a password in order to adjust other parental control settings. To enter a V-Chip Password, follow these steps:

1. Press the **MENU** button to display the Main Menu.
2. Press the up or down arrow (▲/▼) to highlight **Parental Control**.
3. Press the **OK** button or right arrow (▶) to enter the next screen, **Change Password** is highlighted.
4. Press the **OK** button or right arrow (▶) to enter the **Change Password** screen.
5. Use the numeric keypad to enter the four-digit number for your password.
6. Re-enter the same code to confirm the password. The next time you wish to access the **Parental Control** menu, you must enter the correct password first.

Reset V-Chip Password

After you have initially set your personal V-Chip password, you can change it later. If you have forgotten your personal password, follow these steps:

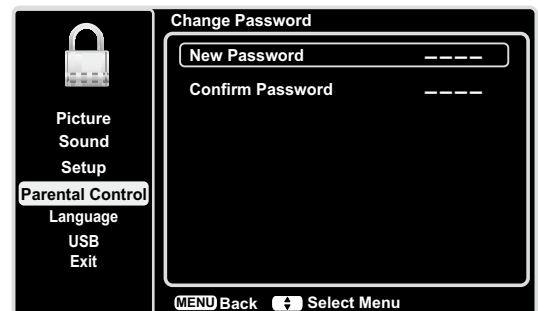
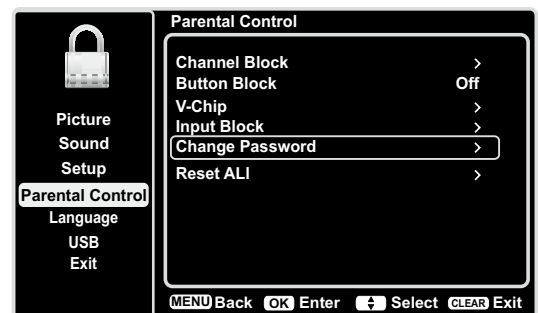

1. Press the **MENU** button to display the Main Menu.
2. Press the up or down arrow (▲/▼) to highlight **Picture** menu.
3. Press the **OK** button or right arrow (▶) to enter the next screen.
4. Press the up or down arrow (▲/▼) to highlight **Expert Settings**.
5. Press the left or right arrow (◀/▶) to continue to the next screen.
6. **Contrast** is highlighted. Enter 2458, using the numeric keypad.
7. Return to the **Parental Control** menu to select **Create Password** and set a new password.

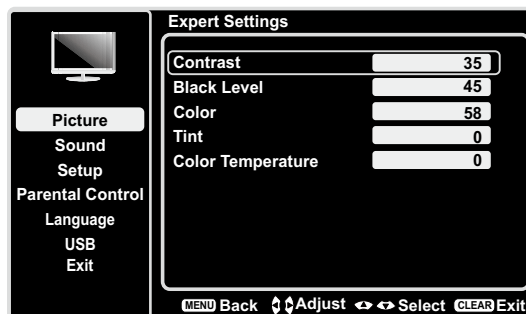

Channel Block

To block a specific channel, follow these steps:

1. Press the up or down arrow (▲/▼) to highlight **Channel Block** in the **Parental Control** submenu.
2. Press the **OK** button or right arrow (▶) to display the Channel List screen.
3. Press the up or down arrow (▲/▼) to select the channel you wish to block.
4. Press the **OK** button to place a checkmark in the box to block that channel. When you tune to that channel, you will need to enter a password to view the channel programming.

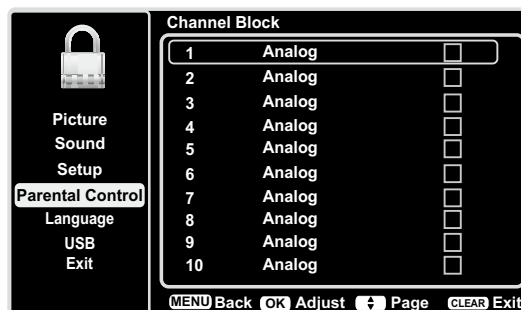

Button Block

This option allows you to block (disable) or unblock (enable) the TV panel buttons. The remote control still tunes to any channel. If you are using this to keep children from changing channels, be sure to remove access to any remote that is capable of operating the TV while you have the TV panel button blocked.

To block the TV panel buttons, follow these steps:

1. Press the up or down arrow (▲/▼) to highlight **Button Block** in the **Parental Control** submenu.
2. Choose the On option.
3. To enable these buttons again, return to this menu and choose the Off option.

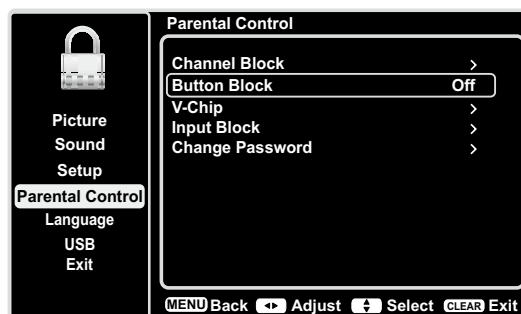

V-Chip Rating Enable

You must remember to set **Rating Enable** to **On** mode to have the following V-Chip rating limits to take effect.

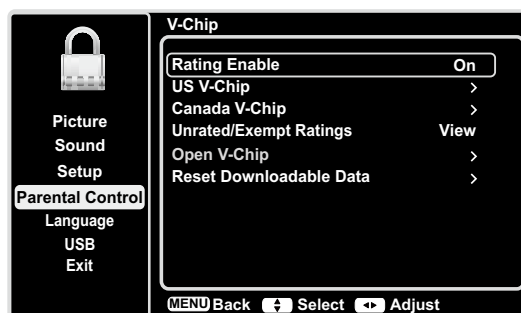

V-Chip Rating Screen

The following graphic details where items are located within the TV Ratings option with the US V-Chip menu.

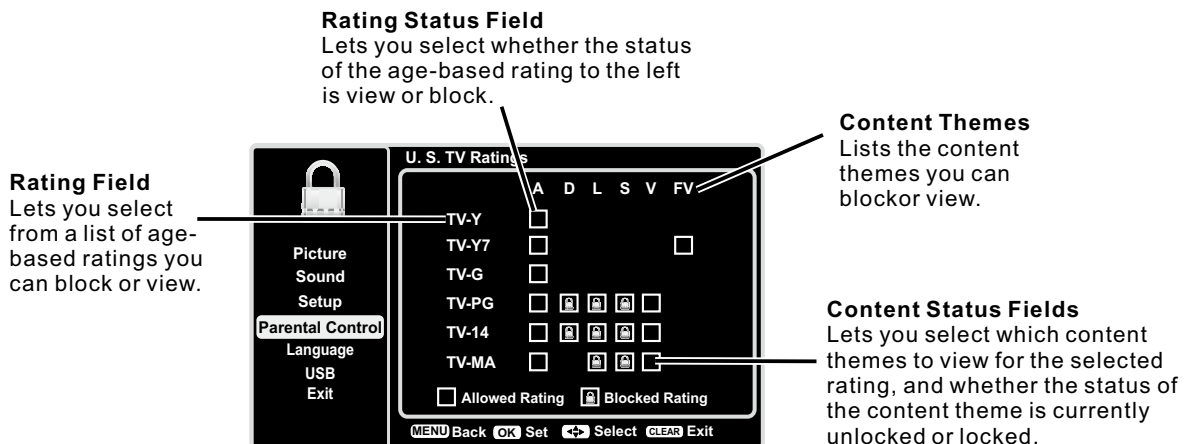

US V-Chip TV Ratings

You can automatically block all program ratings above a specified age-based rating level.

1. Choose **Parental Control** from the Main Menu. If parental controls have previously been locked, you must enter your password.
2. Press the up or down arrow (▲/▼) to select **V-Chip**.
3. Press the **OK** button or right arrow (▶) to enter the next screen.
4. Press the up or down arrow (▲/▼) to select **US V-Chip**.
5. Press the **OK** button or right arrow (▶) to enter the next screen.
6. **U.S. TV Ratings** is highlighted. Press the left or right arrow (◀/▶).
7. Use the up or down arrow (▲/▼) to select the desired rating.
8. Press the **OK** button repeatedly to toggle between View and Block.
9. Use the **MENU** button repeatedly to return to the Main Menu.

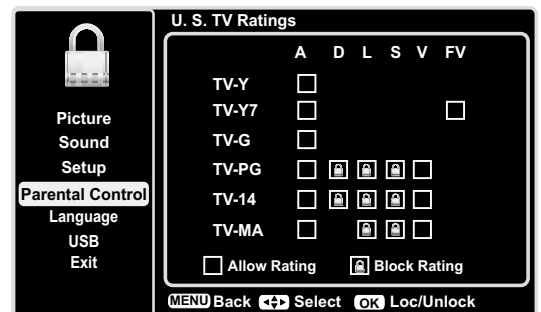

Blocking Specific Content Themes

From the **US V-Chip** Menu, you can set sub-ratings to block specific programs based on their content. To block program content:

1. Press the up or down arrow (▲/▼) to select **V-Chip** in the **Parental Control** submenu.
 2. Press the **OK** button or right arrow (▶) to enter the next screen.
 3. Press the up or down arrow (▲/▼) to select **US V-Chip**.
 4. Press the **OK** button or right arrow (▶) to enter the next screen.
 5. **U.S. TV Ratings** is highlighted. Press the left or right arrow (◀/▶).
 6. Use the up, down, left and right arrows (▲/▼/◀/▶) to select the desired rating.
 7. Press the **OK** button repeatedly to toggle between View and Block.
- To view content themes after you've locked them, follow the same steps as above to unlock.

Hierarchy of Age-Based Ratings	
TV-Y	All Children
TV-Y7	Directed to Children 7 Years and Older
TV-G	General Audience
TV-PG	Parents Guidance Suggested
TV-14	Parents Strongly Cautioned
TV-MA	Mature Audience Only

Content Themes	
D	Sexually Explicit Dialogue
L	Adult Language
S	Sexual Situations
V	Violence
FV	Fantasy Violence

US V-Chip Movie Rating Limit

Set movie rating limits by blocking movies rated above a specified level. To access the Movie Rating Limit Menu, follow these steps:

1. Press the up or down arrow (▲/▼) to select **V-Chip** in the **Parental Control** submenu.
2. Press the **OK** button or right arrow (▶) to enter the next screen.
3. Press the up or down arrow (▲/▼) to select **US V-Chip**.
4. Press the **OK** button or right arrow (▶) to enter the next screen.
5. Press the up or down arrow (▲/▼) to select **U.S. Movie Ratings**.
6. Press the **OK** button or right arrow (▶).
7. Press the up or down arrow (▲/▼) to select the desired rating.
8. Press the **OK** button repeatedly to toggle between View and Block.

Rating	Category
G	General audience
PG	Parental guidance suggested
PG-13	Unsuitable for children under 13
R	Restricted; under 17 requires accompanying parent or adult guardian
NC-17	No one under 17 admitted
X	Mature audience only

Blocking Canada V-Chip Ratings

If you receive Canadian programs, you can block Canadian English and French V-Chip by ratings only. When you block a particular rating, you automatically block the higher-rated programs as well. To block Canadian English and French program ratings, follow these steps:

1. Press the up or down arrow (▲/▼) to select **V-Chip** in the **Parental Control** submenu.
2. Press the **OK** button or right arrow (▶) to enter the next screen.
3. Press the up or down arrow (▲/▼) to select **Canada V-Chip**.
4. Press the **OK** button or right arrow (▶) to proceed to the next screen.
5. Press the up or down arrow (▲/▼) to select **Canadian English Ratings** or **Canadian French Ratings**.

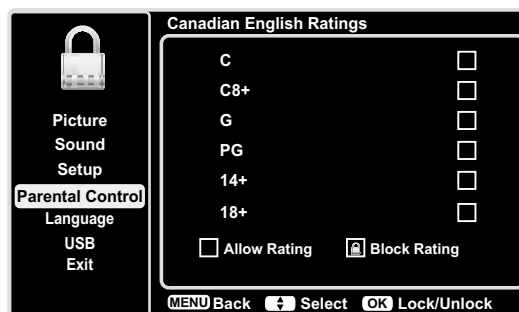

6. Press the **OK** button or right arrow (▶) to proceed.
7. Press the up or down arrow (▲/▼) to select the desired rating.
8. Press the **OK** button to toggle between View and Block.

Open V-Chip - allows you to select the downloadable rating level. In the event that a new rating system is provided by the broadcaster, the new rating options would appear within this menu.

Blocking Unrated/Exempt Programs

The Unrated/Exempt Ratings option lets you decide if programs that the V-Chip recognizes as unrated or exempt can be viewed. Unrated TV programs may include news, sports, political, religious, local and weather programs, emergency bulletins, public announcements, and programs without ratings. The Exempt option applies to both US and Canadian unrated programs and Canadian programs rated E.

1. Press the up or down arrow (▲/▼) to select **V-Chip** in the **Parental Control** submenu.
2. Press the **OK** button or right arrow (▶) to proceed to the next screen.
3. Press the up or down arrow (▲/▼) to highlight **Unrated/Exempt Ratings**.
4. Press the left or right arrow (◀/▶) to toggle between **View** and **Block**.

View All unrated programs are available.

Block All unrated programs are not available.

Reset Downloadable Data

1. Press the up or down arrow (▲/▼) to select **V-Chip** in the **Parental Control** submenu.
2. Press the **OK** button or right arrow (▶) to proceed to the next screen.
3. Select this option to reset the downloadable V-Chip data. When you select this option, a confirmation box opens. Press the left or right arrow (◀/▶) to select.
4. Press the **OK** button to reset the downloadable rating data, if present.

Input Block

1. Press **MENU** on the remote control (the Main Menu appears).
2. Select **Parental Control**. If parental controls have previously been locked, you must enter your password.
3. Press the up or down arrow (▲/▼) to highlight **Input Block**.
4. Press the **OK** button or right arrow (▶) to display the Input Source List screen.
5. Press the up or down arrow (▲/▼) to place a checkmark in the box to block the input. When you tune to that input, you will need to enter a password to view the channel.
6. Press the **OK** button to confirm your selection. A locked/unlocked icon appears next to the selected input.

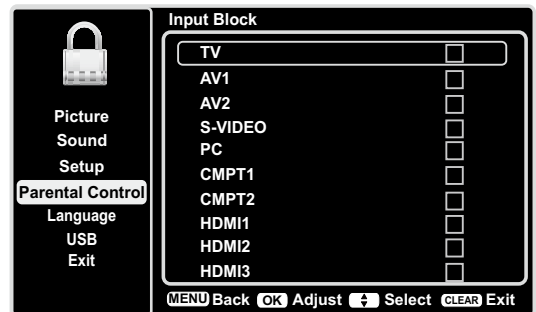

Language Menu

To select the preferred language for all menus, follow the steps below. You can choose between English, Espanol, or Francais.

1. Press **MENU** on the remote control (the Main Menu appears).
2. Use the up or down arrow (▲/▼) to select **Language**.



3. Press the **OK** button or right arrow (▶) to display the **Language** Screen.
4. Press the up or down arrow (▲/▼) to select the preferred language for the menu.
5. Press the left or right arrow (◀/▶) to select **On** or **Off**.
6. Press the **MENU** or **CLEAR** key to exit the menu.

USB Menu

The USB feature on your TV allows you to play audio files (format supported: MP3) or display pictures (format supported: JPEG). To utilize this feature, follow these steps:

1. Press **MENU** on the remote control (the Main Menu appears).
2. Use the up or down arrow (▲/▼) to select **USB**.
3. Press the **OK** button or the right arrow (▶) to proceed to the **USB** Screen. Or, you can press the **MEDIA** button on the remote control to display the **USB** screen directly. (Note: if no USB device is inserted, “**No Media**” displays on the screen)

Media Brower: Select **Media Brower**, press **OK** to enter, then press the up or down arrow (▲/▼) to select a file or file folder, press **OK** and use the following menus:

Open - Select to display the folder/file list in the USB device.

Thumbnail - Select to display the thumbnail of the folders/files.

Slideshow - Select to start photo slideshow. The menu line is grayed-out if there is no photo file in the root of the current USB device.

Play Music - Select to playback the music. The menu line is grayed-out if there is no music file in the root of the current U disk.

Return - Select to return to the previous menu.

Media Settings Select **Media Settings**, press **OK** to enter, then use the following menus:

Photo Settings - Select to display **Photo Settings** submenu.

Slideshow Interval - Select the **Slideshow Interval: 5 Seconds, 10 Seconds, 20 Seconds.**

Slideshow Effect - Select the **Slideshow Effect.**

Slideshow Repeat - Select the options: **Off/On.**

Thumbnail Size- Select to display the thumbnail size: 5X3 and 3X2.

Music Settings - Select to display **Music Settings** submenu.

Music Play Mode - Select the **Music Play Mode: Once, Play All, Random.**

Music Repeat Mode - Select the **Music Repeat Mode: Off/On .**

Music Auto Play - Select the options: **Off/On.**

4. Press the **MENU** button to go back to the previous menu, or press the **CLEAR** button to exit.

USB Connection

You can connect a device with USB to your TV or use a USB flash drive.

This connection allows you to insert a USB flash drive directly or connect a compatible mass storage device with USB, such as a digital camera, a multi-format card reader, or an MP3 player. If you have a USB drive, plug it into the drive directly. If you have a device with a USB port, connect one end of the USB cable to the USB port and the other end to the USB jack on the side of the TV. To access and adjust the options of the USB device, refer to **USB Menu**.

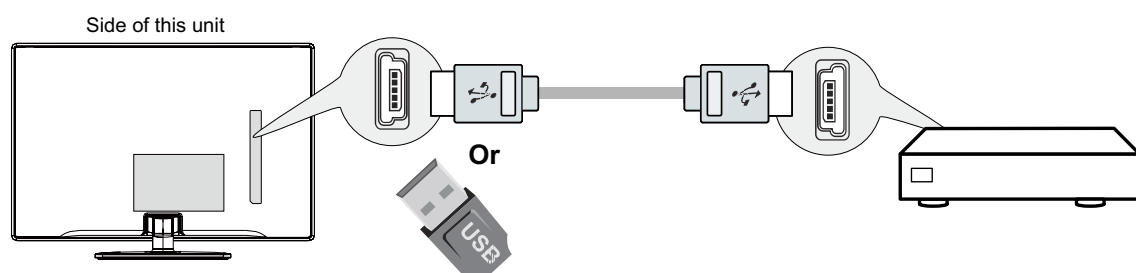

Chapter 5 - Other Information

Frequently Asked Questions (FAQs)

What's the quickest way to view High Definition (HD) video?

Connect an off-air antenna to the ANTENNA/CABLE Input to view free local digital channels. You may need to purchase an antenna. (See page 10 for more information).

Visit www.antennaweb.org for assistance in deciding what type of antenna to use to receive the local digital channels available to you. By entering your location, this mapping program tells you which local analog and digital stations are available using a certain antenna.

Are there other ways to view High Definition (HD) video?

Besides using an off-air antenna as mentioned above, you can also use a set-top box to receive digital video. Contact your cable company or satellite provider to purchase digital programming and have them connect the box to ensure you are viewing channels the best way.

How do I tell an analog channel from a digital channel?

Press the **INFO** button to display the **Channel Banner**. Look at the bottom right corner of the screen. The dot (•) is displayed for a digital channel. If there is no dot, it is an analog channel.

Why are there bars on my screen and can I get rid of them?

Most digital video is sent in a 16/9 format which fills your screen, but is sometimes sent in 4/3 which does not fill your screen. It depends on how the station or device connected to your TV is formatting the video. If there are bars on the screen, press the **ZOOM +/-** button to try a different format that may eliminate the bars. Some bars can't be removed because of the way the format is sent by the broadcaster. The format changes as you press the **ZOOM +/-** button and the format type is displayed at the bottom left of the screen. For more information on screen formats, go to page 18.

Why does channel search find a lot of channels, but when I try to tune to them, there's nothing there?

Some channels enabled by the cable company don't carry programming, such as video ondemand. When channels are unavailable, your TV screen is blank or appears like snow. You probably want to remove these channels from your Channel List. Remove these in the Channel Skip Menu. Go to page 24 for more information.

Why does the first channel search take a long time?

If you have both analog and digital channels, the TV is looking for all available channels in the Channel List. If you do have digital channels, the TV is also searching for scrambled channels, non-scrambled channels, and each sub-channel of that digital channel.

Troubleshooting

Most problems you encounter with your TV can be corrected by consulting the following troubleshooting list.

TV Problems

The TV won't turn on.

- Make sure the TV is plugged in.
- Check the wall receptacle (or extension cord) to make sure it is "live" by plugging in another device.
- The TV panel controls may be locked (disabled). Use the remote control to unlock the TV panel controls.
- Select the Button Block feature on the Parental Control menu and press **OK** to uncheck the box.

There is no picture and no sound but the TV is on.

- You may be tuned to an input with no component connected to it. If you're trying to view a connected component, press **INPUT** until the picture from that component appears.
- The Signal Type option may be set incorrectly. Go to page 23 for detailed instructions.
- The channel may be blank. Try changing channels.
- If you're watching your VCR and it's connected with coaxial cable to the ANTENNA/CABLE jack, tune the TV to channel 3 or 4 (whichever channel is selected on the 3/4 switch on the back of your VCR). Also make sure the TV/VCR button on the VCR is in the correct mode (press the TV/VCR button on your VCR).

The sound is fine, but the picture is poor quality.

- If you're getting a black and white picture from a component you've connected to your TV, you might have your video cables connected to the wrong jacks. A yellow video cable connects to the yellow VIDEO INPUT jack on the side or back of your TV; three video cables or bundled component video cables (red, blue, and green) connect to the corresponding COMPONENT INPUT jacks on the back of your TV.
- Check the antenna connections. Make sure all of the cables are firmly connected to the jacks.
- Try adjusting the sharpness function to improve weak signals. Go to page 23 for more instructions.

There is no sound, but the picture is fine.

- The sound might be muted. Try pressing the volume up button to restore sound.
- If using DVI or Y, PB, PR, remember to also connect the device's left and right audio output jacks to the TV's L and R AUDIO INPUT jacks.
- The sound settings may not be set correctly. Go to page 22 for more information.
- If your audio source has only one jack or is a (mono) audio source, make sure you have plugged the connection into the L AUDIO INPUT jack on the TV.

The screen is blank.

- Check your connections. If you used yellow, red, and white cables to connect, make sure they're connected to the red, white, and yellow AUDIO/VIDEO INPUT jacks on the side or back of the TV.
- If you're trying to watch something that's playing on a component connected to the TV (like a DVD), press **INPUT** until you get to the correct video input channel.
- Make sure the component connected to the TV is turned on.
- Try another channel.

The buttons on the TV panel don't work.

- The TV panel controls may be locked (disabled). Use the remote control to unlock the TV panel controls by selecting the Button Block feature in the Parental Control Menu and press the left or right arrow (◀/▶) to uncheck the box.
- Unplug the TV for 10 minutes and then plug it back in. Turn the TV on and try again.

The TV turns off unexpectedly.

- The electronic protection circuit may have been activated because of a power surge. Wait 30 seconds, and then turn the TV on again. If this happens frequently, the voltage in your house may be abnormally high or low.
- Unplug. Wait 10 minutes. Plug in again.

You can't select a certain channel.

- The channel may be blocked or not approved in the **Parental Control** Menu.
- If using a VCR, check to make sure the **TV/VCR** button on the VCR is in the correct mode (press the **TV/VCR** button on your VCR).
- Press the **TV** button and then try to change channels.

The stereo reception is noisy.

- It may be a weak station. Use the Sound Menu and Analog TV Sound to choose mono.

A black box appears on the screen.

- Closed captioning might be on. Check Closed Caption in the Setup menu. Go to page 26 for more instructions.

You are having problems with the HDMI Connection.

- Make sure the HDMI or DVI component is turned on and the cables are firmly connected. If problems still occur, turn off your component and reconnect it. Reset the power by unplugging the power cord and plugging it back in.
- If you are tuned to the **HDMI 1**, **HDMI 2** or **HDMI 3** INPUT and you're receiving Unusable Signal message onscreen, press the **INFO** button on the remote. If Acquiring Channel appears in the **Channel Banner**, the HDMI or DVI device isn't responding. Contact the manufacturer of the HDMI or DVI device for further assistance.
- If you tune to the **HDMI 1**, **HDMI 2** or **HDMI 3** INPUT and you see snow, the video goes in and out, or the video takes a long time to appear, your HDMI or DVI component is having trouble sending video information to the TV. Reconnect your device. Reset the power by unplugging the power cord and plugging it back in. If problems persist, try connecting the Y Pb Pr jacks if they are available or contact the manufacturer of the HDMI or DVI component for further assistance.
- If you have black bars on each side of your picture, the component you connected might have a switch or a menu option allowing you to change the picture quality output that will fix this. Choose either 720p or 1080i.

The remote control doesn't work.

- Something might be between the remote and the remote light sensor on the front of the TV. Make sure there is a clear path.
- The remote may not be aimed directly at the TV.
- The batteries in the remote may be weak, dead, or installed incorrectly. Put new batteries in the remote.

The Universal Remote control doesn't work.

This TV utilizes new remote control signals and may not be compatible with your existing universal remote (e.g. satellite box remotes, cable box remotes, and generic universal remotes, etc.). Over time, newer universal remotes will become available that should pick up the new TV codes.

You are experiencing problems with V-Chip/Parental Controls.

If the rating limits don't work, you must lock the settings. Go to the Main Menu (press MENU on your remote), select Parental Control. Select V-Chip and then press the left or right arrow (◀/▶) to proceed to the next screen. Rating Enable is highlighted. Press the left or right arrow (◀/▶) to select On to have the rating limits take effect.

The V-Chip won't let me watch a program even though it's not rated as violent.

Maybe the movie was given an NR (Not Rated) status. After you block movie ratings, you must set NR to View Separately in order to view movies with an NR rating.

What else can I do?

If you've been through the Troubleshooting section and nothing has fixed your problem, try rebooting your TV. Note that after a reboot, you may need to run your TV through the setup process again. To do a reboot, unplug the power cord from the wall outlet or power strip. Keep your TV unplugged for about 5 minutes. Then plug in the TV and turn it on. See if the problem is fixed. If the problem remains, then please visit www.tclusa.com for updated FAQs or contact TCL Customer Support at the support number provided in your Warranty under "How To Get Service."

Care and Cleaning

Caution: Turn OFF your TV before cleaning.

You can clean the TV as required, using a soft lint-free cloth. Be sure to occasionally dust the ventilation slots in the cabinet to help assure adequate ventilation.

IMPORTANT: Never use strong cleaning agents, such as ammonia-based cleaners, or abrasive powder. These types of cleaners will damage the TV. The TV's screen may be cleaned with a soft, lint-free cloth as well. Take care not to scratch or mar the screen. If necessary, you may use a cloth dampened with warm water. While cleaning, do not spray liquid directly on the screen, or allow liquid to run down the screen and inside the TV. Also, never place drinks or vases with water on top of the TV. This could increase the risk of fire, shock hazard or damage to the TV.

V-Chip Rating Explanations

US V-Chip Rating System

TV-MA (Mature Audience Only) Specifically designed to be viewed by adults and may be unsuitable for children under 17. It contains one or more of the following content themes: crude indecent language (L), explicit sexual activity (S), or graphic violence (V).

TV-14 (Parents Strongly Cautioned) Contains some material that many parents would find unsuitable for children under 14. Parents are strongly urged to exercise greater care in monitoring this program and are cautioned against letting children under the age of 14 watch unattended. This program contains one or more of the following content themes: intensely suggestive dialogue (D), strong coarse language (L), intense sexual situations (S), or intense violence (V).

TV-PG (Parental Guidance Suggested) Contains material that parents may find unsuitable for younger children. Many parents may want to watch it with their younger children. The program contains one or more of the following content themes: some suggestive dialogue (D), infrequent coarse language (L), some sexual situations (S), or moderate violence (V).

TV-G (Parental Audience) Most parents would find this program suitable for all ages. It contains little or no sexual dialogue (D) or situations (S), no strong language (L), and little or no violence (V).

TV-Y7 (Directed to Children 7 years and older) Designed for children ages 7 and above. It may be more appropriate for children who have acquired the developmental skills needed to distinguish between make believe and reality. Themes and elements in this program may include mild fantasy violence (FV) or comedic violence, or may frighten children under the age of 7.

TV-Y (All Children) Themes and elements in this program are designed for a young audience, including children ages 2-6. It is not expected to frighten younger children.

Canadian English V-Chip Rating System

18+ (Adult) Programming intended for adults 18 and older. It may contain elements of violence, language, and sexual content which could make it unsuitable for viewers under 18. Violence Guidelines: May contain violence integral to the development of the plot, character or theme, intended for adult audiences. Other Content Guidelines: May contain graphic language and explicit portrayals of nudity and/or sex.

14+ (Viewer 14 and over) Programming contains themes or content which may not be suitable for viewers under the age of 14. Parents are strongly cautioned to exercise discretion in permitting viewing by pre-teens and early teens. Violence Guidelines: May contain intense scenes of violence. Could deal with mature themes and societal issues in a realistic fashion. Other Content Guidelines: May contain scenes of nudity and/or sexual activity. There could be frequent use of profanity.

PG (Parental Guidance) Programming intended for a general audience but which may not be suitable for younger children (under the age of 8). Parents may consider some content inappropriate for unsupervised viewing by children aged 8-13. Violence Guidelines: Depictions of conflict and/or aggression will be limited and moderate; may include physical, fantasy, or supernatural violence. Other Content Guidelines: May contain infrequent mild profanity, or mildly suggestive language. Could also contain brief scenes of nudity.

G (General Audience) Programming considered acceptable for all ages groups. While not designed specifically for children, it is understood younger viewers may be part of the audience. Violence Guidelines: Will contain very little violence, either physical or verbal or emotional. Will be sensitive to themes which could frighten a younger child, will not depict realistic scenes of violence which minimize or gloss over the effects of violent acts. Other Content Guidelines: There may be some inoffensive slang, no profanity and no nudity.



C8+ (Children 8 and older) Programming generally considered acceptable for children 8 years and over to watch on their own. Violence Guidelines: Violence will not be portrayed as the preferred, acceptable, or only way to resolve conflict or encourage children to imitate dangerous acts which they may see on television. Any realistic depictions of violence will be infrequent, discreet, of low intensity and will show the consequences of the acts. Other Content Guidelines: There will be no profanity, nudity or sexual content.

C (Children) Programming intended for children under age 8. Violence Guidelines: Careful attention is paid to themes which could threaten children’s sense of security and well being. There will be no realistic scenes of violence. Depictions of aggressive behavior will be infrequent and limited to portrayals that are clearly imaginary, comedic or unrealistic in nature. Other Content Guidelines: There will be no offensive language, nudity or sexual content.

Canadian French V-Chip Rating System

18 ans+ (Adult) Programming is for adults only. This program contains sustained violence or extremely violent scenes.

16 ans+ (Viewer 16 and over) Programming is not suitable for those under age 16. This program contains frequent scenes of violence or intensely violent scenes.

13 ans+ (Viewer 13 and over) Programming may not be suitable for children under the age of 13. This program either contains several violent scenes or one or more scenes that are violent enough to affect them. Viewing in the company of an adult is therefore strongly recommended for children under the age of 13.

8 ans+ (Viewer 8 and over) Not recommended for young children. This program is suitable for most audiences, but it contains mild or occasional violence that could upset young children. Viewing in the company of an adult is therefore recommended for young children (under the age of 8) who do not distinguish between reality and imagination.

G (General Audience) This program is suitable for audiences of all ages. It contains no violence, or any violence that it does contain is either minimal or is presented in a humorous manner, as a caricature, or in an unrealistic way.

Television Specifications

Broadcasting system	US System NTSC-M ATSC standard (8VSB), QAM
Receiving Channels	VHF2-13 UHF14-69 CATV 14-36 (A)-(W) 37-59 (AA)-(WW) 60-85 (AAA)-(ZZZ) 86-94 (86)-(94)95-99 (A-5)-(A-1) 100-135 (100)-(135) 01 (4A)
Tuner type	Frequency synthesized
Screen refresh rate	60Hz

TTE Technology, Inc. (“TTE”) Limited Warranty

All LCD/LED Models

EXCEPT TO THE EXTENT PROHIBITED BY APPLICABLE LAW, THIS WARRANTY DOES NOT COVER, AND AS DESCRIBED BELOW TTE EXPRESSLY DISCLAIMS, ALL ACTUAL AND IMPLIED WARRANTIES WITH RESPECT TO ANY PRODUCT USED FOR INSTITUTIONAL OR OTHER COMMERCIAL PURPOSES (INCLUDING BUT NOT LIMITED TO RENTAL PURPOSES).

What your warranty covers: Defects in materials or workmanship to the original owner of this TCL product when purchased from an Authorized Dealer of TCL brand products and packaged with this warranty statement.

New LCD/LED Televisions

For how long after your purchase:

- Two (2) years from date of purchase for parts.
- Two (2) years from date of purchase for labor.

What we will do:

- At TTE’s discretion, pay an Authorized TCL Service Center for both labor charges and parts to repair your television, or replace your television with a new or refurbished/remanufactured unit. See “How to get service”.

How to get service:

- Call **1-877-300-8837**. Please have your unit’s date of purchase, place of purchase and model/serial number ready. The model/serial number information can be found on the back of your unit.
- A representative will troubleshoot your problem over the phone. If it is determined that your unit requires service, the service location will be at the sole discretion of TTE based upon the TTE Limited Warranty statement.
- At the sole discretion of TTE, television screen sizes 32” and smaller will either be repaired at an Authorized TCL Service Center or directly exchanged for a new or refurbished/remanufactured unit. At the sole discretion of TTE, television screen sizes 33” through 55” will either be repaired at an Authorized TCL Service Center or repaired in-home.

If repaired at an Authorized TCL Service Center, TTE is not responsible for transportation costs to the Authorized TCL Service Center. However, TTE will pay for return shipping. TTE will provide instructions for packaging and shipping the unit. Proof of purchase in the form of a bill of sale or receipted invoice from an Authorized Dealer which is evidence that the product is within the warranty period must be presented to obtain warranty service.

What your warranty does not cover:

- Customer instruction. (Your Owner’s Manual describes how to install, adjust, and operate your unit. Any additional information should be obtained from your Authorized Dealer.)
- Installation and related adjustments.
- Damage resulting from non-approved installation methods.
- Signal reception problems not caused by your unit.
- Damage from misuse or neglect.
- Batteries.
- A television that has been modified or incorporated into other products or is used for institutional or other commercial purposes (including but not limited to rental purposes).
- A unit purchased or serviced outside the USA.
- A unit sold as is or with all faults
- Acts of nature, such as but not limited to lightning damage.
- Special, incidental or consequential damages.

Product Registration:

Please register your TCL purchase on-line at www.tclusa.com. It will make it easier to contact you should it ever be necessary. Registration is not required for warranty coverage.

Limitation of Warranty:

- **THE WARRANTY STATED ABOVE IS THE ONLY WARRANTY APPLICABLE TO THIS PRODUCT. NO VERBAL OR WRITTEN INFORMATION GIVEN BY TTE TECHNOLOGY, INC., ITS AGENTS OR EMPLOYEES SHALL CREATE A GUARANTY OR IN ANY WAY INCREASE OR MODIFY THE SCOPE OF THIS WARRANTY.**
- **REPAIR OR REPLACEMENT AS PROVIDED UNDER THIS WARRANTY IS THE EXCLUSIVE REMEDY OF THE CONSUMER. TTE TECHNOLOGY, INC. SHALL NOT BE LIABLE FOR SPECIAL, INCIDENTAL OR CONSEQUENTIAL DAMAGES RESULTING FROM THE USE OF THIS PRODUCT OR ARISING OUT OF ANY BREACH OF ANY EXPRESS OR IMPLIED WARRANTY ON THIS PRODUCT. THIS DISCLAIMER OF WARRANTIES AND LIMITED WARRANTY ARE GOVERNED BY THE LAWS OF THE STATE OF INDIANA. EXCEPT TO THE EXTENT PROHIBITED BY APPLICABLE LAW, ANY IMPLIED WARRANTY OF MERCHANTABILITY OR FITNESS FOR A PARTICULAR PURPOSE ON THIS PRODUCT IS LIMITED TO THE APPLICABLE WARRANTY AND WARRANTY PERIOD SET FORTH ABOVE.**

How State Law relates to this warranty:

- Some states do not allow the exclusion nor limitation of incidental or consequential damages, or limitations on how long an implied warranty lasts, so the above limitations or exclusions may not apply to you.
- This warranty gives you specific legal rights, and you also may have other rights that vary from state to state.

If you purchased your unit outside the United States or seek warranty coverage outside the United States: This warranty does not apply. Contact your dealer for warranty information.

Service calls which do not involve defective materials or workmanship are not covered by this warranty. Costs of such service calls are the sole responsibility of the purchaser.



ENERGY STAR is a set of power-saving guidelines issued by the U.S. Environmental Protection Agency (EPA).

ENERGY STAR is a joint program of the U.S. Environmental Protection Agency and the U.S. Department of Energy helping us all save money and protect the environment through energy efficient products and practices.

Manufactured under license from Dolby Laboratories.

“Dolby” and the double-D symbol are registered trademarks of Dolby Laboratories.

FCC Information

This equipment has been tested and found to comply with the limits for a Class B digital device, pursuant to Part 15 of the FCC Rules. These limits are designed to provide reasonable protection against harmful interference in a residential installation. This equipment generates, uses, and can radiate radio frequency energy and, if not installed and used in accordance with the instructions, may cause harmful interference to radio communications. However, there is no guarantee that interference will not occur in a particular installation. If this equipment does cause harmful interference to radio or television reception, which can be determined by turning the equipment off and on, the user is encouraged to try to correct the interference by one or more of the following measures:

- Reorient or relocate the receiving antenna.
- Increase the separation between the equipment and receiver.
- Connect the equipment into an outlet on a circuit different from that to which the receiver is connected.
- Consult the dealer or an experienced radio/TV technician for help.

This Class B digital apparatus complies with Canadian ICES-003.

Please do not send any products to the Indianapolis address listed in this manual or on the carton. This will only add delays in service for your product.

TTE

TTE Technology, Inc.

1255 Graphite Drive Corona, CA 92881

©2011 TTE Technology, Inc.

TCL and associated marks are trademarks of TCL S.A. used under license to TTE Corporation.

Printed in China

Part No.: 72-F12C8A-XNA1A