

Thank you for purchasing this Products.
Please carefully read this instruction manual for properly setup instructions.

PACKAGE CONTENTS

- FM Transmitter
- Car Charger
- 3.5 Stereo cable

PRODECTS FEATURES

- Hi-fi transmission for audio.
- Suitable For all iPod/ iPhone/ BlackBerry/Most mobile Phone/ MP3/ Cars.
- Provides hands-free for iPhone conversations through your car speakers
- Connection the car charger to your devices, you can enjoy the music while synced charging for your devices.
- Ingenious sucker fixed design and flexible goose-pipe makes it convenient to find the best position for your device, allowing you to use effortlessly.
- Tightly fitting clamps hold your device securely.
- LCD frequency display.

DEVICE APPEARANCE

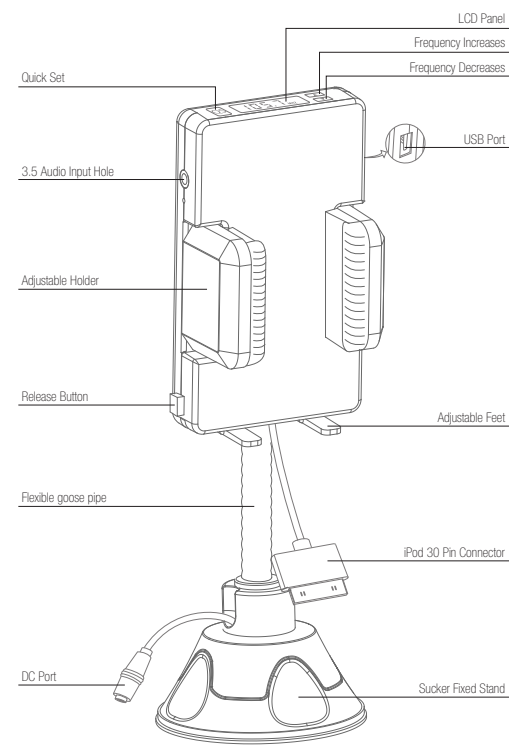

1

2

REMOTE CONTROL

Remote control function is extended,
Please make sure your model configuration.

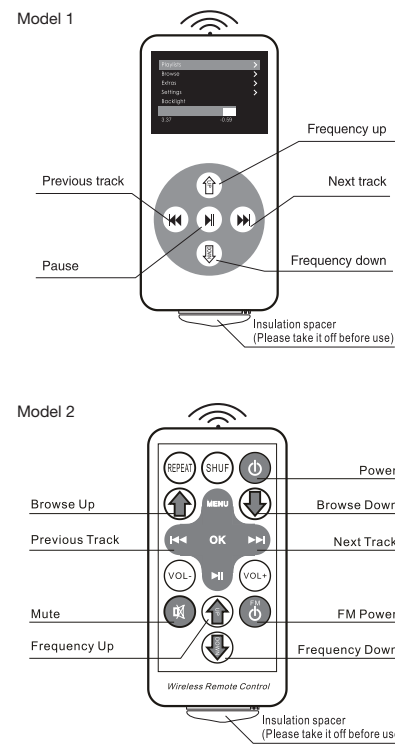

3

OPERATING GUIDE

Preparation for usage

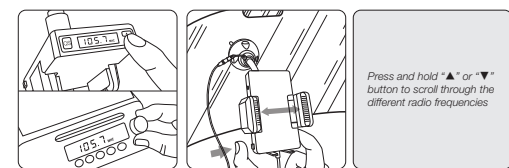
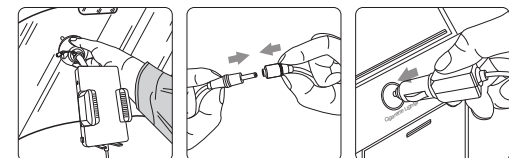

Work with iPod

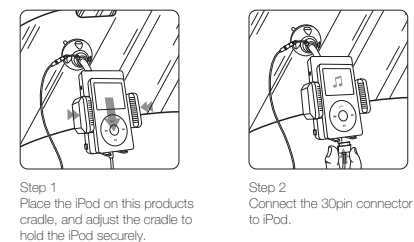

4

Work with iPhone

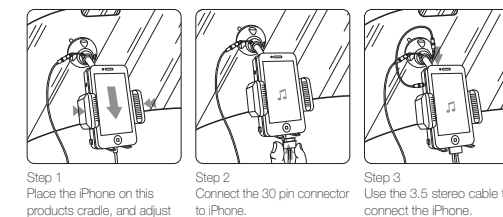

Now you can select to talk or continue to enjoy music through car speaker systems .

Using with others mechanisms

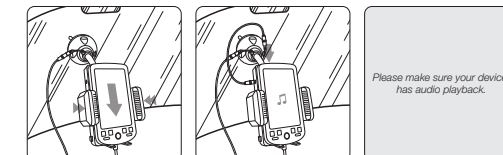

How to removal

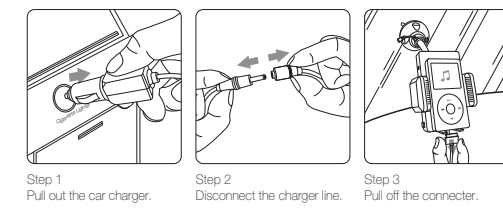

5

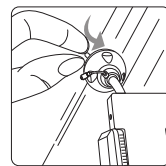
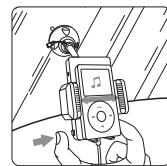

USB Charger

Connect your USB device to the products USB port to charge your device.

Please check if your USB device supports the standard.

SPECIFICATIONS

All specifications are subject to change without notice.

Frequency

Band	FM Frequency
Quality	Hi-Fi stereo
Range	88.1~107.9MHz
Interval	0.1MHz
Stability	10ppm (-10 C ~+ 55 C)
Clutter & Harmonic	≤-60dB
Effective Range	≥5m
Remote Range	≥3m

6

Power

Working Voltage:	DC 12V ~ 24V
USB Output Voltage:	DC 5 V 800mA

Audio

Stereo separation	40dB
Frequency reponse	20Hz~16KHz
Audio Distortion	≤0.1% (F=75KHz, f=1KHz)
SNR:	≥45dB (1KHz 100%)

Physical

Product size	110 x 65,5 x 40 mm
Weight	203 g

Please avoid using local radio signal frequencies to ensure better sound quality.
Please adjust the volume on the device or the car stereo to ensure proper volume levels.
Please carefully check the electricity capacity of your equipment when using as a USB charger

WARNING
WARRANTY WILL BE VOIDED IF MODIFICATIONS OR ALTERATIONS HAVE BEEN MADE TO THE DEVICE.
DEVICE CONTAINS REMOVABLE PARTS PLEASE MONITOR WHEN AROUND CHILDREN.

7

RULE STATEMENT

this products is a radio transmitter device, in accordance with part 15 of FCC rules, the product meets the requirements of Class B digital products restrictions by the specific circumstances of the impact of the following two conditions:

1. This device will not cause any harmful interference.
2. The device must be able to accept the receipt of the interference, including the possibility of operator error caused the interference.

MAINTENANCE ATTENTION TO THE ISSUES

1. Please use a clean soft cloth to clean this device.
2. For prolonged use of the device, device should be disconnected from vehicle cigarette lighter port.

TROUBLESHOOTING

Please reference below for troubleshooting help with your device.

SYMPTOM	SOLUTION
Not fully inserted into the car cigarette lighter hole	Fully inserted into the car cigarette lighter hole

Fuse Spec: Φ 5 x 20mm, 250V/2A

SYMPTOM	SOLUTION
The volume of audio device is too low	Adjust the device volume higher
Car Speaker volume is too low	Adjust the car volume
Bad contact of audio	Recheck if audio stereo cable is securely plugged
Stereo cable is damaged	Replace with a new one

8

3. There is static from the car speaker

SYMPTOM	SOLUTION
Strong local radio signal interference	Change the frequency

4. There is an echo when using with the iPhone

SYMPTOM	SOLUTION
Volume is too high	Adjust iPhone or car

5. Audio output on one side is lower than the other when using the iPhone

SYMPTOM	SOLUTION
User is to far away from the iPhone	User needs or maintain no more then 1 M distance for effective hands-free

FM RADIO TRANSMITTER uses the iPhone MIC, effective speaking distances should be around 1 M

6. USB device is not charging

SYMPTOM	SOLUTION
Use of non-Standard	Replace with a standard
Non-Standard USB	Stop the charging

7. No sound coming from the car speaker

SYMPTOM	SOLUTION
Device setting is mute or has stopped	Check the device settings

iPod® & iPhone® is a trademark of Apple Computer Inc., registered in the U.S. and other countries



9

USER MANUAL FM Transmitter

