



Shenzhen Certification Technology Service Co., Ltd
3F, Bldg27, Area A, Tanglang Industrial Zone, Xili Town, Nanshan
District, ShenZhen, Guang dong, P.R. China.

TEST REPORT

FCC ID: W8D-F6B

Applicant : Shenzhen Onuoda Electronics Technology Co.,Ltd
Address : 3F D building Jingfu industry zone Airway(West) Gushu village
Xixiang town Bao'an district Shenzhen city Guangdong China

Equipment under Test (EUT):

Name : FM transmitter

Model : F6B

Standards : FCC Part15.239

Report No. : STE091104617

Date of Test : November 8-9, 2009

Date of Issue : November 10, 2009

Test Result :	PASS *
----------------------	---------------

* In the configuration tested, the EUT complied with the standards specified above

Authorized Signature

(Mark Zhu)
General Manager

The manufacture should ensure that all the products in series production are in conformity with the product sample detailed in this report.

If the product in this report is used in any configuration other than that detailed in the report, the manufacturer must ensure the new system complies with all relevant standards. Any mention of Shenzhen Certification Technology Service Co., Ltd. Or test done by Shenzhen Certification Technology Service Co., Ltd. Approvals in connection with, distribution or use of the product described in this report must be approved by Shenzhen Certification Technology Service Co., Ltd. Approvals in writing.

TABLE OF CONTENT

Description	Page
1 General Information-----	3
1.1 Description of Device (EUT) -----	3
1.2 Description of Test Facility-----	4
2 Test Equipment List -----	4
3 Summary of Measurement -----	5
4 Radiated Emission Test -----	6
4.1 Radiated Emission Limits(15.209&239)-----	6
4.2 Test Setup for Emission measurement -----	7
4.3 Test Procedure-----	8
4.4 Test Condition-----	9
4.5 Test Results-----	10
5 Bandwidth Test -----	15
5.1 Limit for Bandwidth-----	15
5.2 Method of measurement-----	15
5.3 Test Setup -----	15
5.4 Test Results -----	15
6 Band Edge Test -----	17
6.1 Test Limit-----	17
6.2 Test Procedure -----	17
6.3 Test Results -----	17
7 Antenna Requirement -----	19
7.1 Standard requirement-----	19
7.2 Result -----	19
8 Photographs of Test Setup -----	20
9 Photographs of EUT -----	21

1 General Information

1.1 Description of Device (EUT)

Trade Name : N/A
EUT : FM Transmitter

Model No. : F6B

Type of Antenna : Integral Antenna

Operation Frequency : 88.1-107.9MHZ(All turning channels is manually verified
Which will be only between 88MHZ~108MHZ)
Modulation type : FM

Power Supply : DC12V
Rated RF output Power : 51.60 dBuV(PK detector)

Applicant : Shenzhen Onuoda Electronics Technology Co.,Ltd
Address : 3F D building Jingfu industry zone Airway(West)
Gushu village Xixiang town Bao'an district Shenzhen city
Guangdong China

Manufacturer : Shenzhen Onuoda Electronics Technology Co.,Ltd
Address : 3F D building Jingfu industry zone Airway(West)
Gushu village Xixiang town Bao'an district Shenzhen city
Guangdong China

1.2 Description of Test Facility

Shenzhen Certification Technology Service Co.,Ltd.
 3F, Bldg.27, Area A, Tanglang Industrial Zone, Xili Town, Nanshan District, Shenzhen
 518055, Guangdong, P.R. China
 FCC Registered No.:305283

2 Test Equipment List

Equipment	Manufacture	Model No.	Serial No.	Last cal.	Cal Interval
3m Semi-Anechoic	ETS-LINDGREN	N/A	SEL0017	16/06/2009	1Year
Spectrum analyzer	Agilent	E4443A	MY46185649	06/06/2009	1Year
Receiver	R&S	ESCI	100492	04/06/2009	1Year
Receiver	R&S	ESCI	101202	07/01/2009	1Year
Bilog Antenna	Sunol	JB3	A121206	04/06/2009	1Year
Horn Antenna	EMCO	3115	640201028-06	04/06/2009	1Year
ETS Horn Antenna	ETS	3160	SEL0076	12/08/2008	1Year
Active Loop Antenna	Beijing Daze	ZN30900A	SEL0097	15/06/2009	1Year
Cable	Resenberger	N/A	No.1	04/06/2009	1Year
Cable	SCHWARZBECK	N/A	No.2	04/06/2009	1Year
Cable	SCHWARZBECK	N/A	No.3	04/06/2009	1Year
Pre-amplifier	R&S	AFS42-00101 800-25-S-42	SEL0081	18/06/2009	1Year
Pre-amplifier	R&S	AFS33-18002650 -30-8P-44	SEL0080	18/06/2009	1Year

3 Summary of Measurement

Test Item	Test Requirement	Standard Paragraph	Result
Antenna Requirement	FCC PART15	15.203	Compliance
Conducted Emission	FCC PART15	15.207	Not applicable
Radiation Emission	FCC PART15	15.209&15.239	Compliance
Bandwidth Requirement	FCC PART15	15.239	Compliance
Band edge Requirement	FCC PART15	15.239	Compliance

4 Radiated Emission Test

4.1 Radiated Emission Limits(15.209&239)

Frequency (MHZ)	Field Strength Limits at 3 metres (watts,e.i.r.p.)		
	uV/m	dB uV/m	Measurement distance(m)
0.009-0.490	2400/F(kHz)	XX	300
0.490-1.705	24000/F(kHz)	XX	30
1.705-30	30	29.5	30
30~88	100(3nW)	40	3
88~216	150(6.8nW)	43.5	3
216~960	200(12nW)	46	3
Above960	500(75nW)	54	3
Carrier frequency	250	48(AV)	3
Carrier frequency		68(PK)	3

NOTE:

- The tighter limit applies at the band edges.
- Emission Level(dB uV/m)=20log Emission Level(uV/m)
- XX means the limit is unsure

4.2 Test Setup for Emission measurement

Test Setup for Emission Below 30MHz

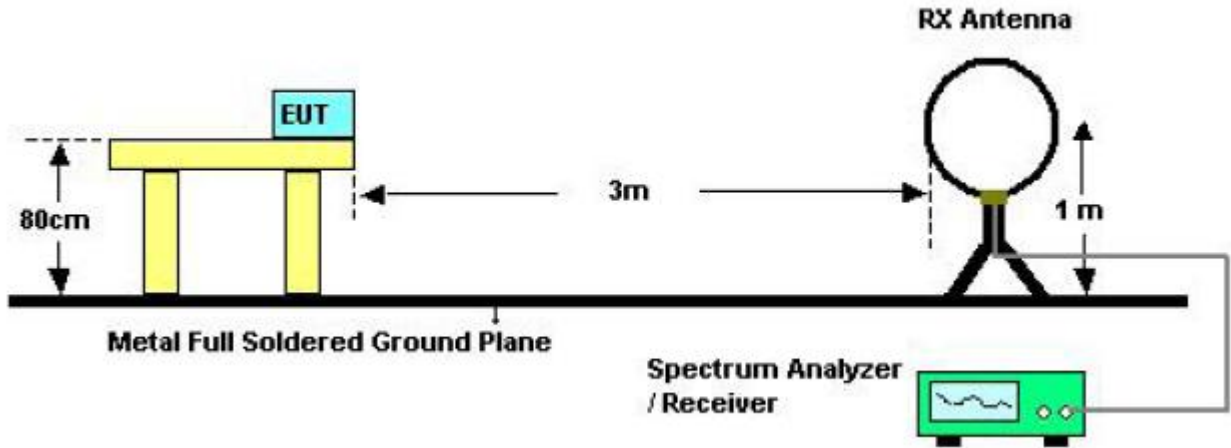

Test Setup for Emission above 30MHz

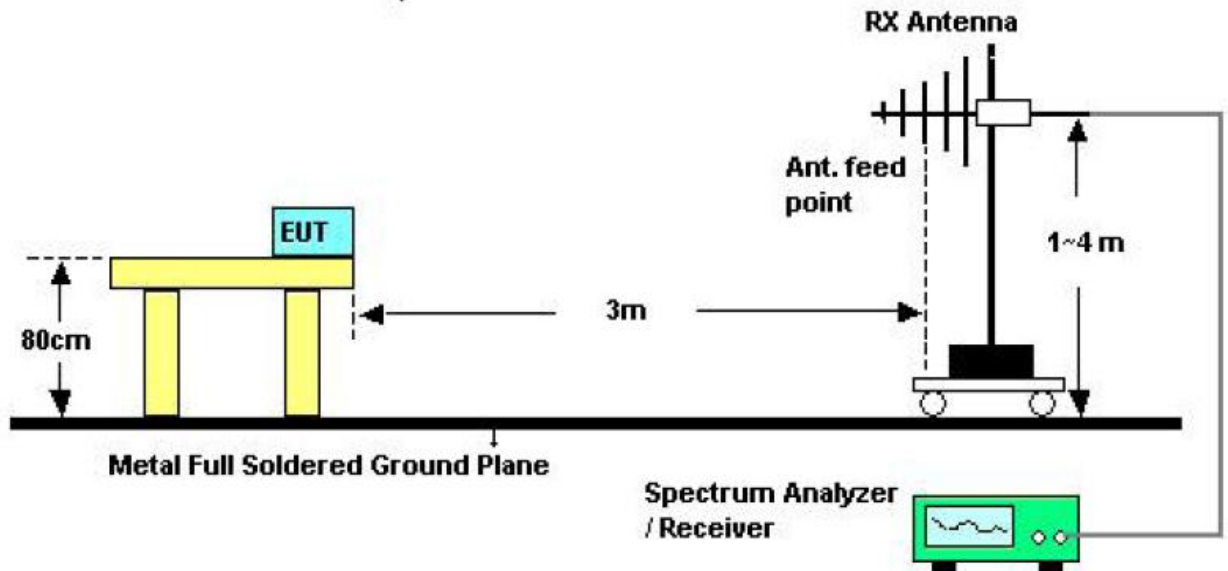

Test Setup for Emission above 1GHz

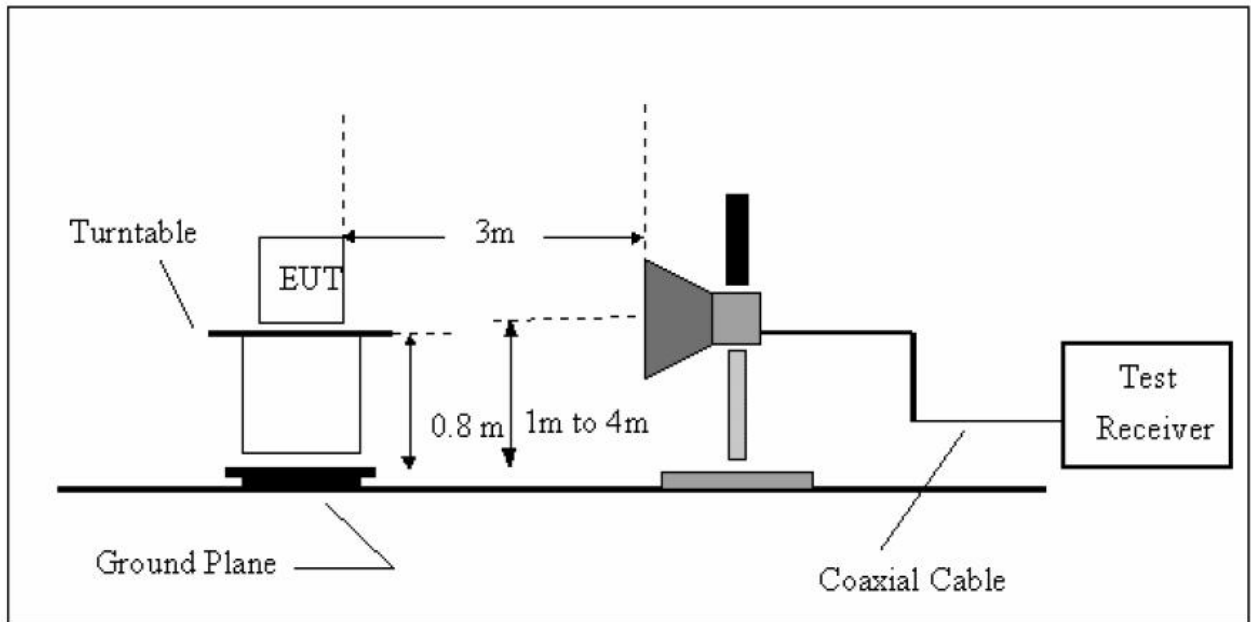

4.3 Test Procedure

- a) The measuring distance of 3m shall be used for measurements at frequency up to 1GHz and above 1 GHz, The EUT was placed on a rotating 0.8 m high above ground. The table was rotated 360 degrees to determine the position of the highest radiation
- b) The Test antenna shall vary between 1m and 4m. Both Horizontal and Vertical antenna are set to make measurement.
- c) The initial step in collecting conducted emission data is a spectrum analyzer Peak detector mode pre-scanning the measurement frequency range. Significant Peaks are then marked and then Qusia Peak Detector mode premeasured
- d) If Peak value comply with QP limit Below 1GHz.The EUT deemed to comply with QP limit. But the Peak value and average value both need to comply with applicable limit above 1GHz.
- e) Repeated step a and d test with EUT in X, Y,Z position, and the maximum emissions data were recorded when EUT in X position as the test photo indicated.

f) For the actual test configuration, please see the test setup photo.

g) Test Equipment Setting For emission test:

30MHZ~1GHZ:

RBW 120KHZ VBW 300KHZ

Above 1GHZ :

RBW 1MHZ VBW 3MHZ for Peak value

RBW 1MHZ VBW 10HZ for Average Value

4.4 Test Condition

Test Audio Signal has been set to maximum Level and Continuous Transmitting in maximum power. We have scanned up the 10th harmonics about the EUT.

4.5 Test Results

Radiated Emissions Result of Outside the band (88~108MHZ)

EUT	FM Transmitter	Model Name	F6B
Temperature	26°C	Relative Humidity	56%
Pressure	960hPa	Test voltage	DC12V
Test Mode	TX(IPod)	TX frequency	88.1MHZ

Antenna polarization: Vertical								
Frequency MHZ	Reading dBuV	Cable Loss dB	Antenna Factor dB	Amplifier Gain	Correct Factor dB	Measurement Result dBuV/m	Limit line dBuV/m	Over Margin
63.75	48.58	0.86	7.42	28.12	-19.84	28.74	40.00	11.26
104.37	49.68	1.54	6.14	27.53	-19.85	29.83	43.50	13.67
136.85	47.06	1.81	6.58	27.31	-18.92	28.14	43.50	15.36
296.47	45.64	2.02	10.95	27.25	-14.28	31.36	46.00	14.64
353.88	45.03	2.23	11.86	26.64	-12.55	32.48	46.00	13.52
537.68	39.3	2.67	16.24	26.32	-7.41	31.89	46.00	14.11
--	--	--	--	--	--	--	--	--

Antenna polarization: Horizontal								
Frequency MHZ	Reading dBuV	Cable Loss dB	Antenna Factor dB	Amplifier Gain	Correct Factor dB	Measurement Result dBuV/m	Limit line dBuV/m	Over Margin
46.35	46.72	0.62	8.31	28.02	-19.09	27.63	40.00	12.37
152.74	47.71	1.98	6.74	27.29	-18.57	29.14	43.50	14.36
271.35	47.05	2.01	10.64	27.26	-14.61	32.44	46.00	13.56
466.89	44.78	2.59	12.73	26.54	-11.22	33.56	46.00	12.44
573.84	38.65	2.71	16.89	26.28	-6.68	31.97	46.00	14.03
622.17	38.79	2.84	17.35	26.16	-5.97	32.82	46.00	13.18
--	--	--	--	--	--	--	--	--

EUT	FM Transmitter	Model Name	F6B
Temperature	26°C	Relative Humidity	56%
Pressure	960hPa	Test voltage	DC12V
Test Mode	TX(IPod)	TX frequency	98.1MHZ

Antenna polarization: Vertical								
Frequency	Reading	Cable Loss	Antenna Factor	Amplifier	Correct Factor	Measurement Result	Limit line	Over Margin
MHZ	dBuV	dB	dB	Gain	dB	dBuV/m	dBuV/m	
63.75	48.58	0.86	7.42	28.12	-19.84	28.74	40.00	11.26
104.37	49.68	1.54	6.14	27.53	-19.85	29.83	43.50	13.67
136.85	47.06	1.81	6.58	27.31	-18.92	28.14	43.50	15.36
296.47	45.64	2.02	10.95	27.25	-14.28	31.36	46.00	14.64
353.88	45.03	2.23	11.86	26.64	-12.55	32.48	46.00	13.52
537.68	39.3	2.67	16.24	26.32	-7.41	31.89	46.00	14.11
--	--	--	--	--	--	--	--	--

Antenna polarization: Horizontal								
Frequency	Reading	Cable Loss	Antenna Factor	Amplifier	Correct Factor	Measurement Result	Limit line	Over Margin
MHZ	dBuV	dB	dB	Gain	dB	dBuV/m	dBuV/m	
46.35	46.72	0.62	8.31	28.02	-19.09	27.63	40.00	12.37
152.74	47.71	1.98	6.74	27.29	-18.57	29.14	43.50	14.36
271.35	47.05	2.01	10.64	27.26	-14.61	32.44	46.00	13.56
466.89	44.78	2.59	12.73	26.54	-11.22	33.56	46.00	12.44
573.84	38.65	2.71	16.89	26.28	-6.68	31.97	46.00	14.03
622.17	38.79	2.84	17.35	26.16	-5.97	32.82	46.00	13.18
--	--	--	--	--	--	--	--	--

EUT	FM Transmitter	Model Name	F6B
Temperature	26°C	Relative Humidity	56%
Pressure	960hPa	Test voltage	DC12V
Test Mode	TX(IPod)	TX frequency	107.9MHZ

Antenna polarization: Vertical

Frequency MHZ	Reading dBuV	Cable Loss dB	Antenna Factor dB	Amplifier Gain	Correct Factor dB	Measurement Result dBuV/m	Limit line dBuV/m	Over Margin
63.75	48.58	0.86	7.42	28.12	-19.84	28.74	40.00	11.26
104.37	49.68	1.54	6.14	27.53	-19.85	29.83	43.50	13.67
136.85	47.06	1.81	6.58	27.31	-18.92	28.14	43.50	15.36
296.47	45.64	2.02	10.95	27.25	-14.28	31.36	46.00	14.64
353.88	45.03	2.23	11.86	26.64	-12.55	32.48	46.00	13.52
537.68	39.3	2.67	16.24	26.32	-7.41	31.89	46.00	14.11
--	--	--	--	--	--	--	--	--

Antenna polarization: Horizontal

Frequency MHZ	Reading dBuV	Cable Loss dB	Antenna Factor dB	Amplifier Gain	Correct Factor dB	Measurement Result dBuV/m	Limit line dBuV/m	Over Margin
46.35	46.72	0.62	8.31	28.02	-19.09	27.63	40.00	12.37
152.74	47.71	1.98	6.74	27.29	-18.57	29.14	43.50	14.36
271.35	47.05	2.01	10.64	27.26	-14.61	32.44	46.00	13.56
466.89	44.78	2.59	12.73	26.54	-11.22	33.56	46.00	12.44
573.84	38.65	2.71	16.89	26.28	-6.68	31.97	46.00	14.03
622.17	38.79	2.84	17.35	26.16	-5.97	32.82	46.00	13.18
--	--	--	--	--	--	--	--	--

Notes: --Means other frequency and mode comply with standard requirements and at least have 20dB margin.

Correct Factor=Cable Loss+Antenna Factor-Amplifier Gain

Measurement Result=Reading + Correct Factor

Margin=Measurement Result-Limit

Radiated Emissions Result of Inside band (88~108MHZ)

EUT	FM Transmitter	Model Name	F6B
Temperature	26°C	Relative Humidity	56%
Pressure	960hPa	Test voltage	DC12V
Test Mode	TX (IPod)	Antenna polarization	Horizontal/Vertical

Channel Low(88.1MHZ)									
Fre. MHz	Plority H/V	Reading dBuV	Antenna Factor dB	Cable Loss dB	Amplifier Gain dB	Correct Factor dB	Measure Result dBuV/m	Limit dBuV/m	Margin dB
88.1	H	68.71 (PK)	5.7	0.57	26.65	-20.38	48.33	68	-19.67
88.1	H	62.31 (AV)	5.7	0.57	26.65	-20.38	41.93	48	-6.07
--	H	--	--	--	--	--	--	--	--
88.1	V	67.25 (PK)	5.7	0.57	26.65	-20.38	46.87	68	-21.13
88.1	V	61.44 (AV)	5.7	0.57	26.65	-20.38	41.06	48	-6.94
--	V	--	--	--	--	--	--	--	--

Channel Middle(98.1MHZ)									
Fre. MHz	Plority H/V	Reading dBuV	Antenna Factor dB	Cable Loss dB	Amplifier Gain dB	Correct Factor dB	Measure Result dBuV/m	Limit dBuV/m	Margin dB
98.1	H	69.34 (PK)	8.4	0.61	26.75	-17.74	51.60	68	-16.40
98.1	H	61.13 (AV)	8.4	0.61	26.75	-17.74	43.39	48	-4.61
--	H	--	--	--	--	--	--	--	--
98.1	V	66.93 (PK)	8.4	0.61	26.75	-17.74	49.19	68	-18.51
98.1	V	59.52 (AV)	8.4	0.61	26.75	-17.74	41.78	48	-6.22
--	V	--	--	--	--	--	--	--	--

Channel High(107.9MHZ)									
Fre. MHz	Plority H/V	Reading dBuV	Antenna Factor dB	Cable Loss dB	Amplifier Gain dB	Correct Factor dB	Measure Result dBuV/m	Limit dBuV/m	Margin dB
107.9	H	65.41 (PK)	10.9	0.68	26.65	-15.07	50.34	68	-17.66
107.9	H	58.72 (AV)	10.9	0.68	26.65	-15.07	43.65	48	-4.35
--	H	--	--	--	--	--	--	--	--
	H								
107.9	V	64.46 (PK)	10.9	0.68	26.65	-15.07	49.36	68	-18.64
107.9	V	57.29 (AV)	10.9	0.68	26.65	-15.07	42.22	48	-5.78
--	V	--	--	--	--	--	--	--	--
	V								

Notes: --Means other frequency and mode comply with standard requirements and at least have 20dB margin.
 Correct Factor=Cable Loss+Antenna Factor-Amplifier Gain
 Measurement Result=Reading + Correct Factor
 Margin=Measurement Result-Limit

5 Bandwidth Test

5.1 Limit for Bandwidth

The occupied bandwidth shall not exceed 200 KHZ

5.2 Method of measurement

a) The bandwidth is measured at an amplitude level reduced 20dB from the reference level. The reference level is the level of the highest amplitude signal observed from the transmitter at the fundamental frequency. Once the reference level is established, the equipment is conditioned with typical modulating signal to produce the worst-case (i.e. the widest) bandwidth.

b) The test receiver RBW set 10KHZ,VBW set 30KHZ

5.3 Test Setup

same as section 5.2

5.4 Test Results

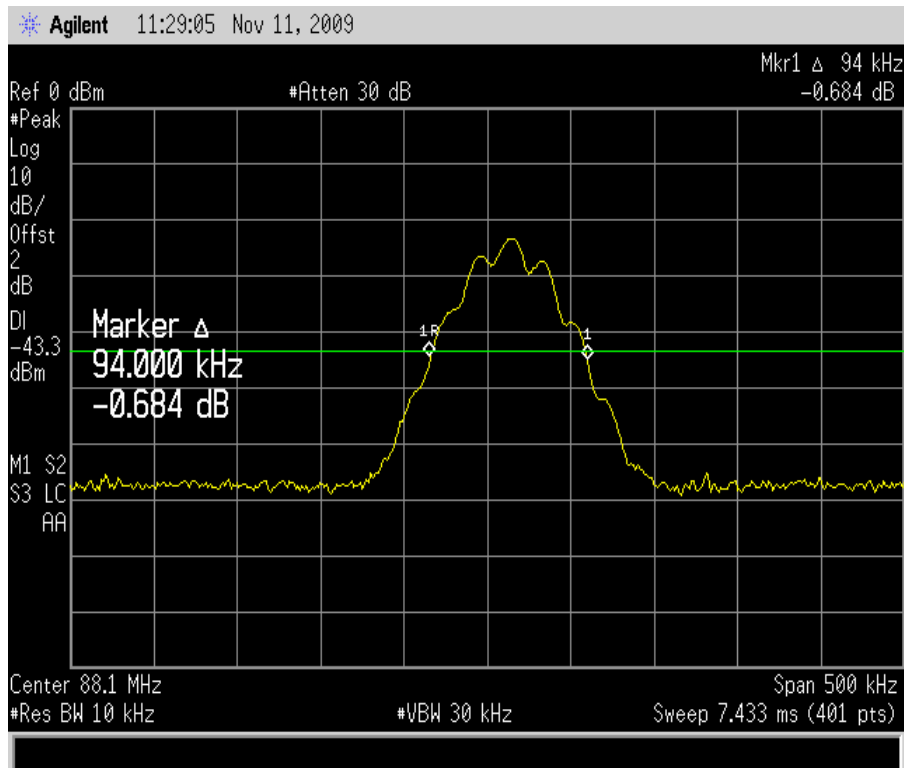

88.1MHZ bandwidth test plot

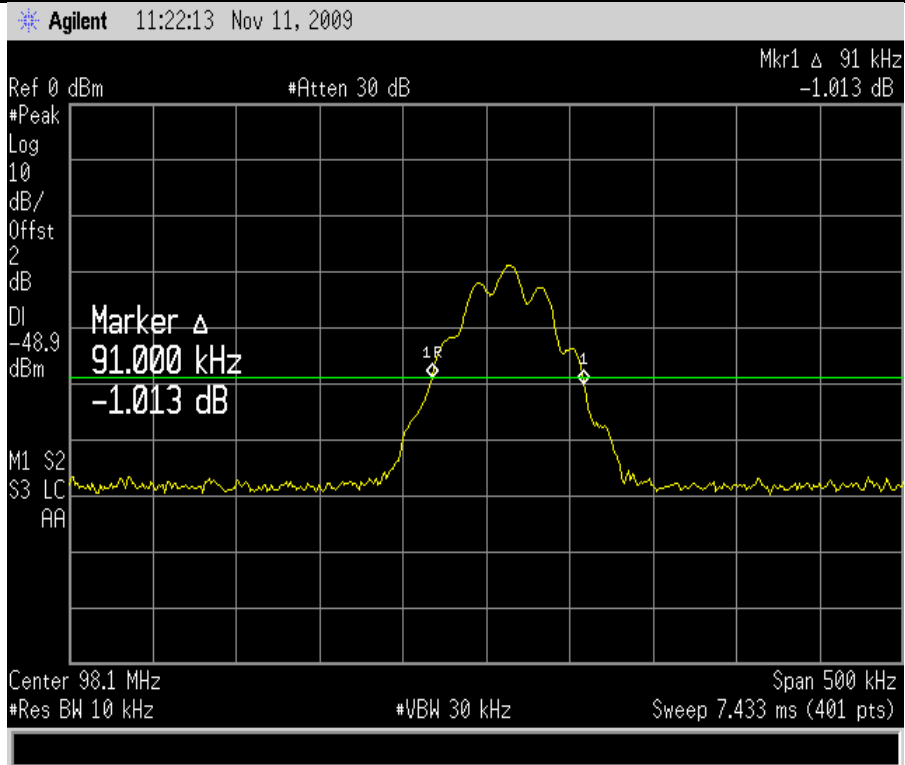

98.1MHZ bandwidth test plot

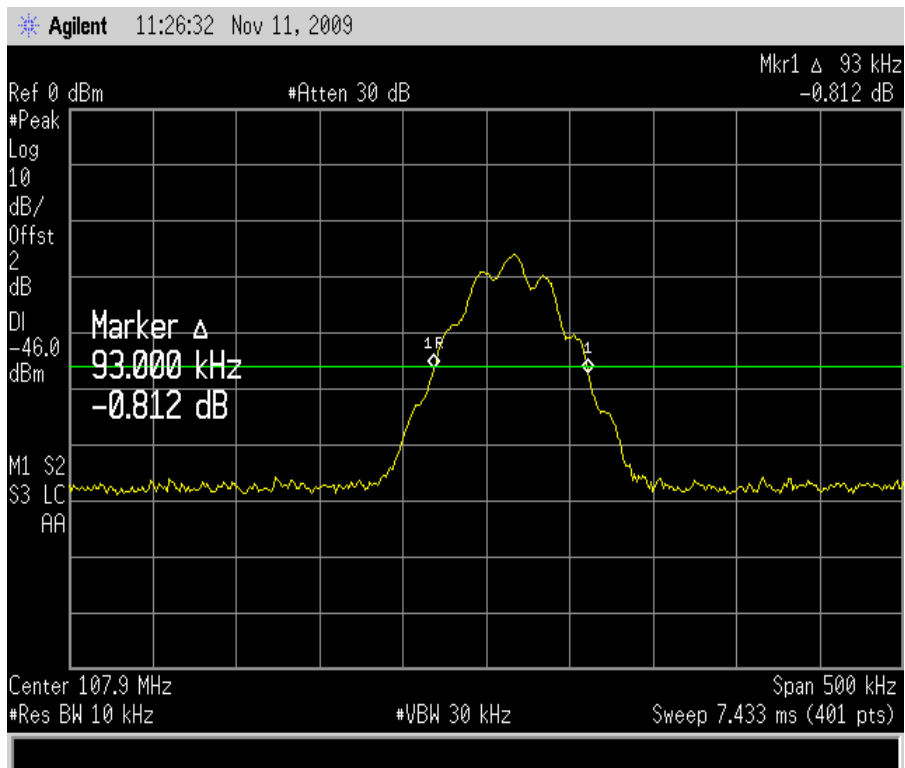

107.9MHZ bandwidth test plot

6 Band Edge Test

6.1 Test Limit

Please see the part 15.239a

6.2 Test Procedure

- a) Put the EUT on a 0.8m high table, power on the EUT. Emissions were scanned and measured rotating the EUT to 360 degrees, Find the maximum Emission
- b) Turning to Low and High frequency, then reduced 20dB from the reference level. The reference level is the level of the highest amplitude signal observed from the transmitter at the fundamental frequency.
- c) Check the spurious emissions out of band.
- d) RBW, VBW Setting, please see the following test plot.

6.3 Test Results

Pass

Detailed information, please see the following page.

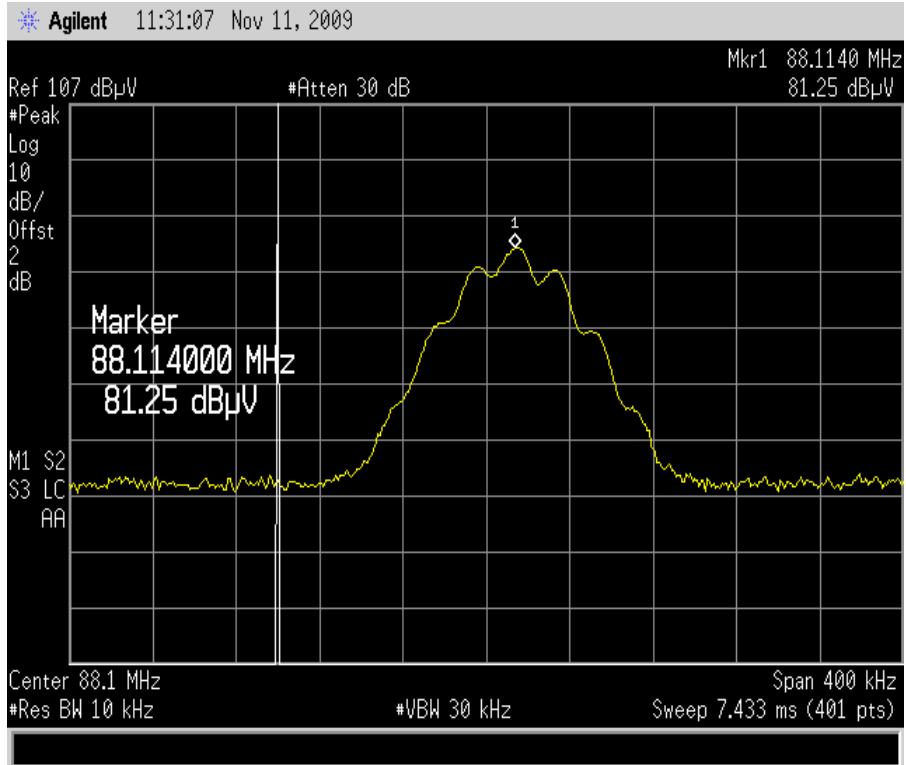

88.1MHz Test Plot

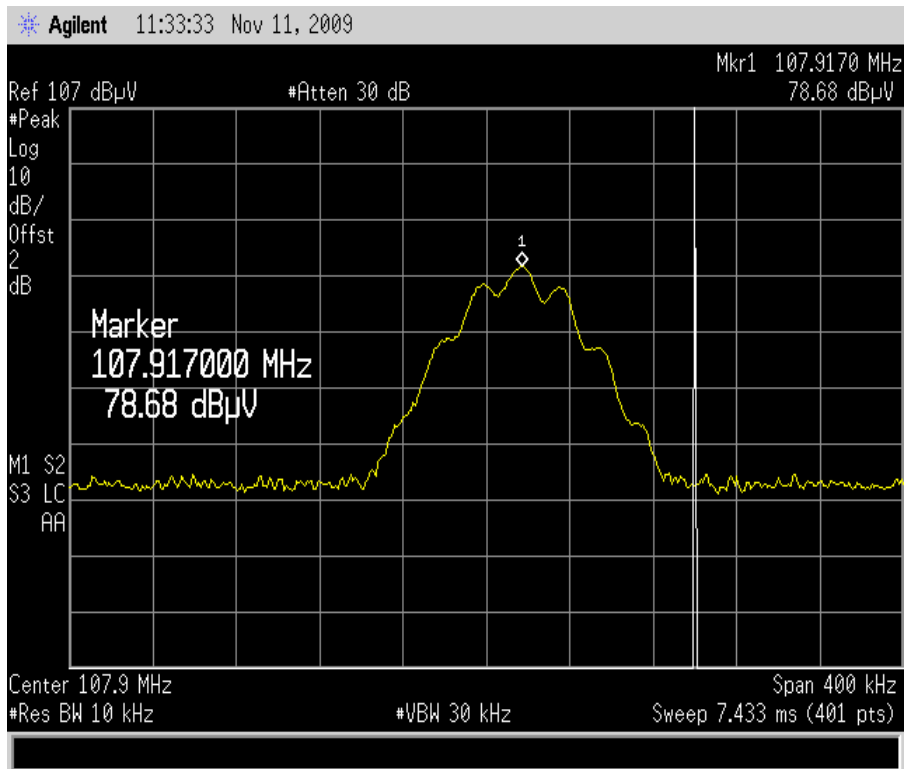

107.9MHz Test Plot

7 Antenna Requirement

7.1 Standard requirement

An intentional radiator shall be designed to ensure that no antenna other than that furnished by the responsible party shall be used with the device. The use of a permanently attached antenna or of an antenna that uses a unique coupling to the intentional radiator shall be considered sufficient to comply with the provisions of this Section. The manufacturer may design the unit so that a broken antenna can be replaced by the user, but the use of a standard antenna jack or electrical connector is prohibited.

7.2 Result

The device is integral antenna, it comply with the standard requirement.

8 Photographs of Test Setup

Photographs-Radiated Emission Test Setup in Chamber

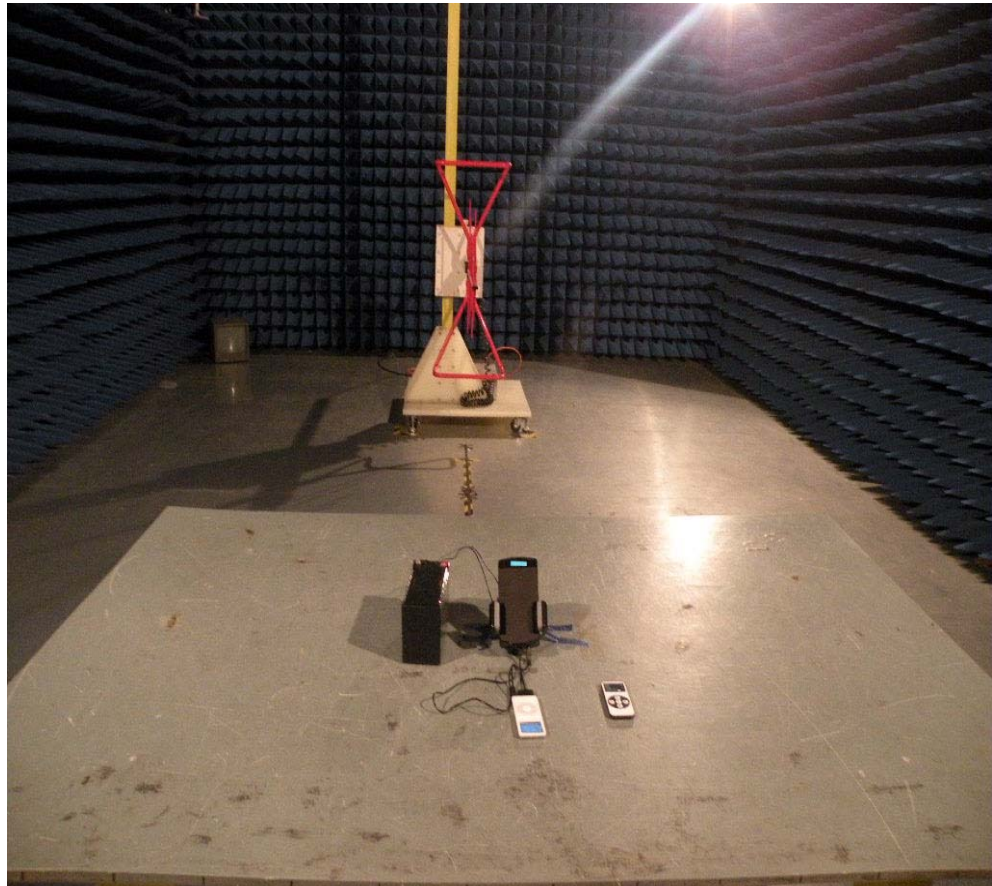

9 Photographs of EUT

Figure 1

Photo of EUT

Front View []

Rear View []

Top View []

Bottom View []

Left View []

Right View []

Full View [✓]



Figure 2

Photo of EUT

Front View []

Rear View []

Top View [✓]

Bottom View []

Left View []

Right View []

Internal View []



Figure 3

Photo of EUT

Front View []

Rear View []

Top View []

Bottom View [✓]

Left View []

Right View []

Internal View []



Figure 4

Photo of EUT

Front View [✓]

Rear View []

Top View []

Bottom View []

Left View []

Right View []

Internal View []



Figure 5

Photo of EUT

Front View []

Rear View []

Top View []

Bottom View []

Left View [✓]

Right View []

Internal View []



Figure 6

Photo of EUT

Front View []

Rear View [✓]

Top View []

Bottom View []

Left View []

Right View []

Internal View []



Figure 7

Photo of EUT

Front View []

Rear View []

Top View []

Bottom View []

Left View []

Right View [✓]

Internal View []

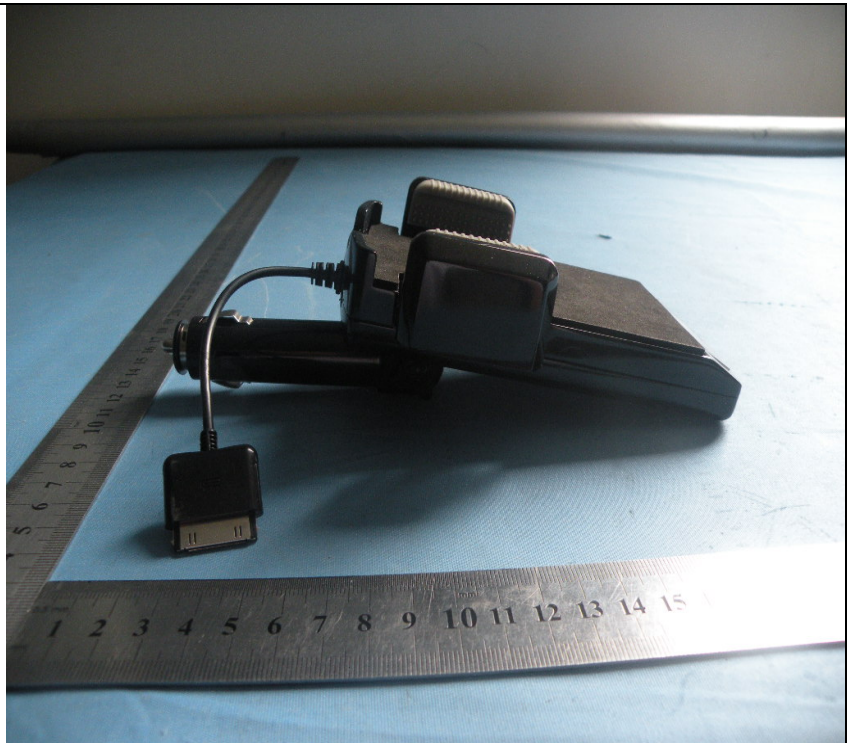

Figure 8

Photo of EUT

Front View []

Rear View []

Top View []

Bottom View []

Left View []

Right View []

Internal View [✓]

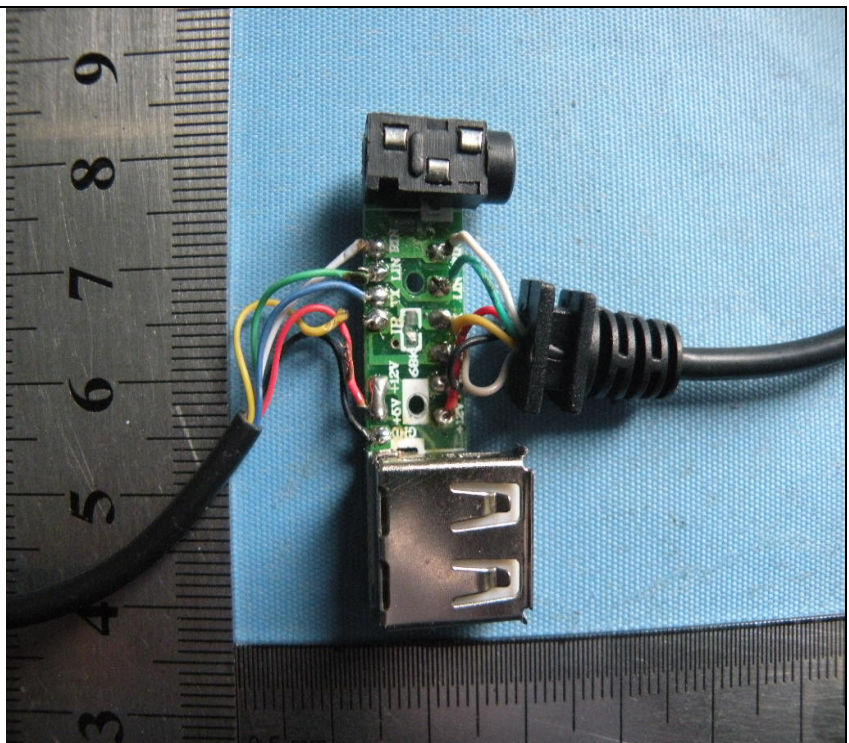

Figure 9

Photo of EUT

Front View []

Rear View []

Top View []

Bottom View []

Left View []

Right View []

Internal View [✓]

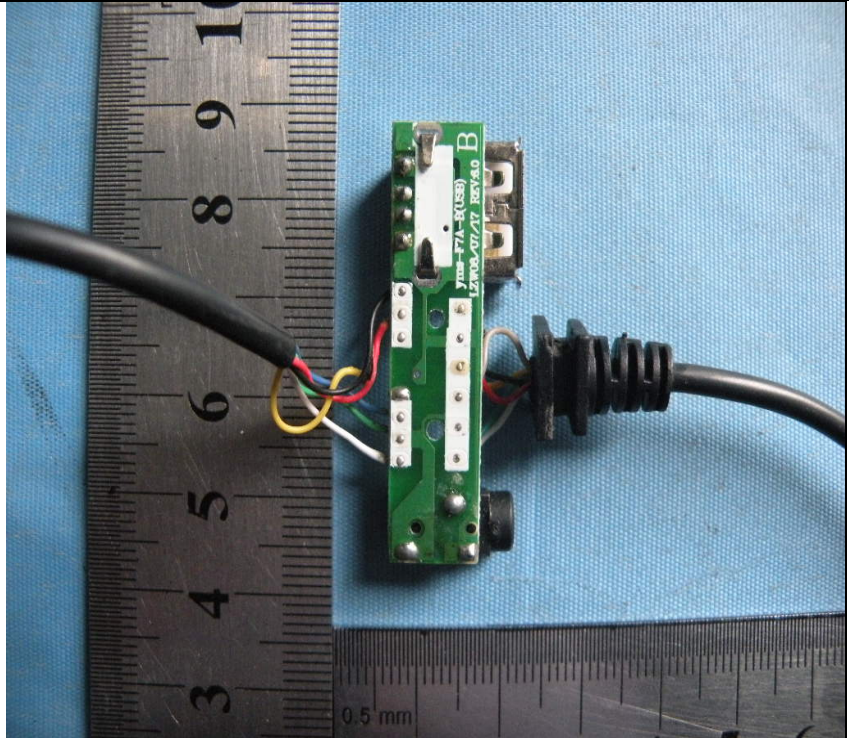

Figure 8

Photo of EUT

Front View []

Rear View []

Top View []

Bottom View []

Left View []

Right View []

Internal View [✓]

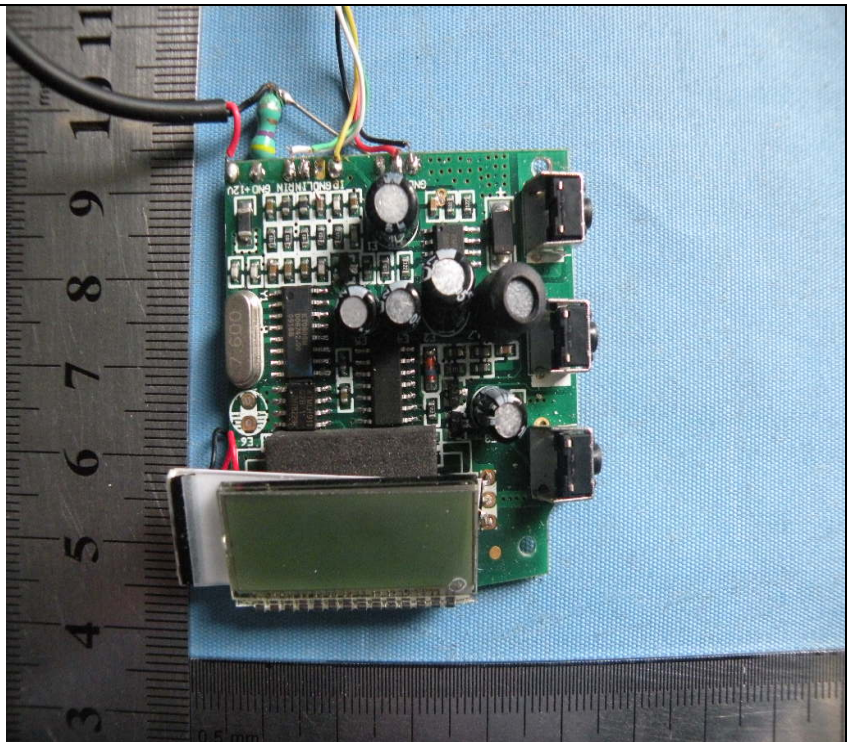

Figure 8

Photo of EUT

Front View []

Rear View []

Top View []

Bottom View []

Left View []

Right View []

Internal View [✓]

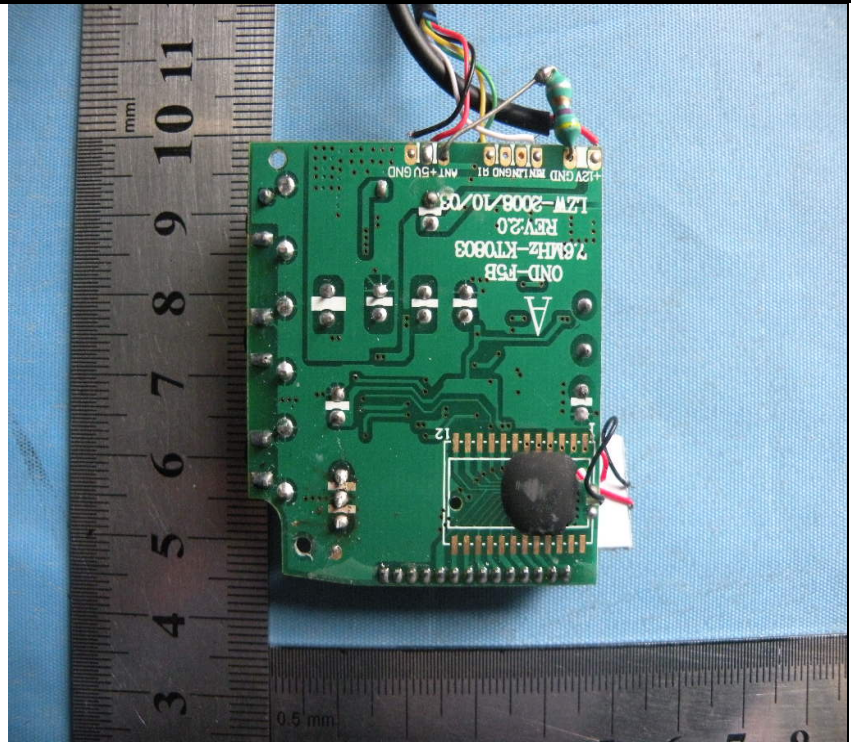

----- THE END OF REPORT-----